

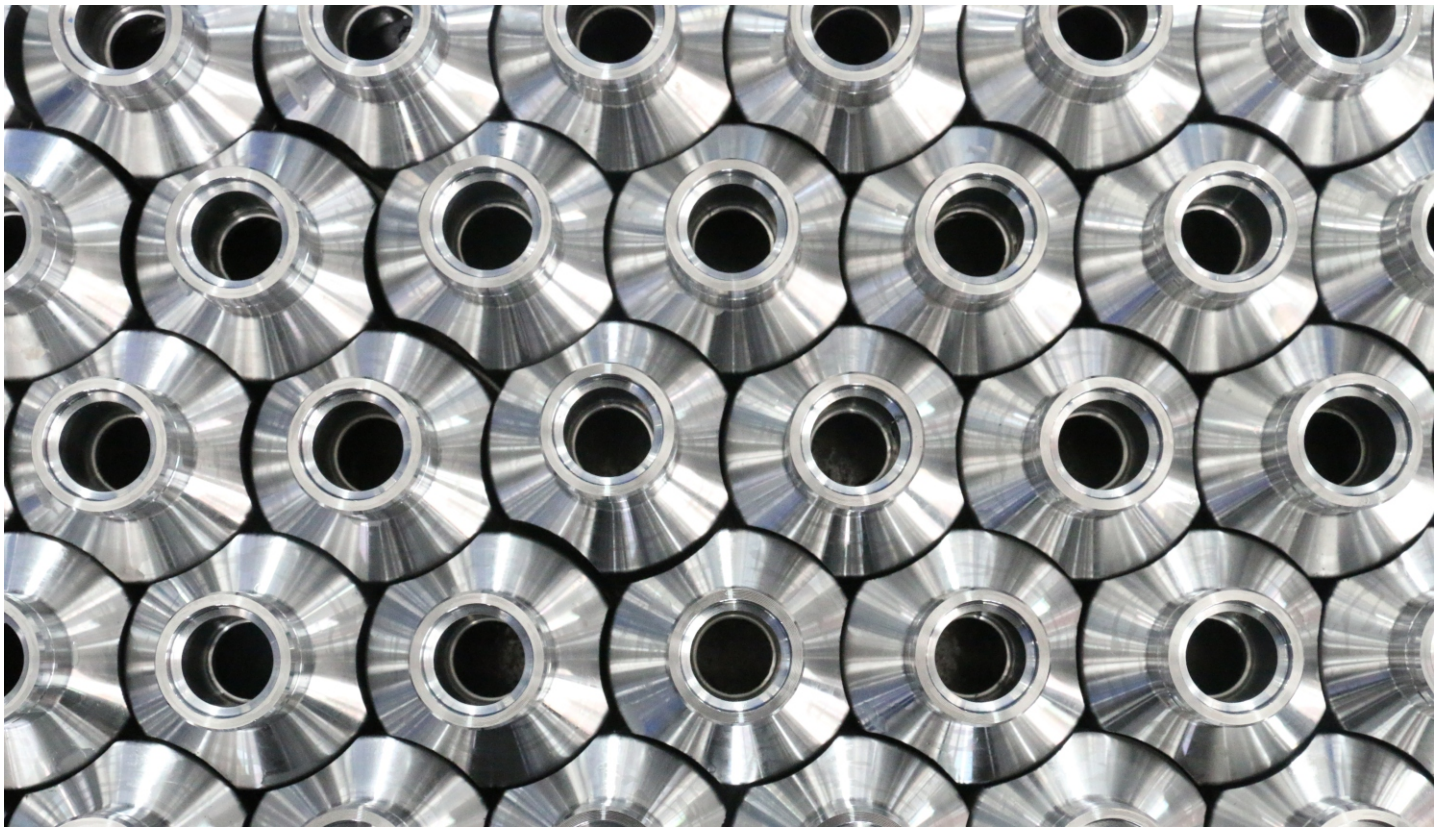

HUB ASSEMBLIES AND WHEEL BEARINGS

Catalogue 2016





G **AUTOPARTS**®





G **AUTOPARTS**®



GENERAL INDEX

Vehicle Index	page. I - X
Coding Rule	page. XI-XI
Hub Assemblies Basic Dimension Table-GSP to Dimension	page.001-021
Hub Assemblies Contents of Complete Kits	page.022-029
Bearing Kits Basic Dimension Table-GSP to Dimension	page.030-038
Bearing Kits Contents of Complete Kits	page.039-045
Application	page.046-796
Cross Reference list	page.797-813
Photo	page.814-922
New Applications (compared with catalogue 2015)	page.923-923
Not Longer Available	page.924-924

MAKE-MODEL	PAGE	MAKE-MODEL	PAGE	MAKE-MODEL	PAGE
ABARTH		AUDI		BMW	
500C (312)	46	A6 AVANT (4G5, C7, 4GD)	88	X1 (E84)	118
ALFA ROMEO		A7 (4GA)	88	X3 (E83)	118
145 (930)	46	A7 SPORTBACK (4GA, 4GF)	88	X5 (E53)	118
146 (930)	47	A8 (4D2, 4D8)	88	X5 (E70)	119
147 (937)	48	A8 (4E_)	89	X5 (F15, F85)	119
155 (167)	49	A8 (4H_)	90	X6 (E71, E72)	119
156 (932)	49	ALLROAD (4BH, C5)	90	X6 (F16, F86)	120
159 (939)	51	CABRIOLET (8G7, B4)	90	Z3 (E36)	120
159 SPORTWAGON (939)	52	COUPE (89, 8B)	91	Z3 (E36) M	120
164 (164)	52	Q3 (8U)	91	Z4 (E85)	121
166 (936)	53	Q5 (8R)	92	Z4 (E86)	121
168 (164)	53	Q7 (4L)	92	Z4 (E89)	121
4C (960)	53	R8	92	Z8 (E52)	121
4C SPIDER (960)	53	R8 SPYDER	92	BUICK	
BRERA	53	TT (8J3)	93	CENTURY	121
GIULIETTA (940)	54	TT (8N3)	93	CENTURY (4_35)	121
GT (937)	54	TT (FV3)	93	LE SABRE	121
GTV (916C_)	55	TT ROADSTER (8J9)	93	PARK AVENUE	121
MITO (955)	55	TT ROADSTER (8N9)	93	SKYLARK	121
SPIDER (916S_)	56	V8 (44_ 4C_)	94	CADILLAC	
SPIDER (939)	56	BMW		ALLANTE	121
AUDI		1 (E81)	94	DEVILLE	121
100 (44, 44Q, C3)	56	1 (E82)	95	ELDORADO	122
100 (4A, C4)	57	1 (E87)	95	ESCALADE	122
100 AVANT (44, 44Q, C3)	57	1 (E88)	96	FLEETWOOD	122
100 AVANT (4A, C4)	57	1 (F20)	96	SEVILLE	122
80 (89, 89Q, 8A, B3)	58	1 (F21)	96	SEVILLE II (K)	122
80 (8C, B4)	58	2 (F22, F87)	97	XLR	122
80 AVANT (8C, B4)	59	2 (F23)	97	CHERY	
90 (89, 89Q, 8A, B3)	59	2 Coupe (F22)	97	AMULET A15	122
A1 (8X1, 8XF)	59	3 (E30)	97	CHEVROLET	
A1 (8XA, 8XK)	60	3 (E36)	97	AVALANCHE	122
A1 SPORTBACK (8XA, 8XK)	61	3 (E46)	99	AVEO (T200)	122
A2 (8Z0)	61	3 (E90)	100	AVEO (T250)	122
A3 (8L1)	61	3 (E92)	101	AVEO (T250, T255)	122
A3 (8P1)	62	3 (E93)	103	AVEO (T300)	123
A3 (8P7)	63	3 (F30, F35, F80)	103	BERETTA (1_37)	124
A3 (8PA)	63	3 COMPACT (E36)	104	CAPTIVA (C100, C140)	124
A3 (8V1)	65	3 COMPACT (E46)	104	CAVALIER	124
A3 (8V7)	65	3 GRAN TURISMO (F34)	104	CLASSIC	124
A3 CONVERTIBLE (8V7)	65	3 TOURING (E30)	105	COBALT	124
A3 LIMOUSINE (8VS)	65	3 TOURING (E36)	105	CORSICA (1_69)	124
A3 SPORTBACK (8PA)	66	3 TOURING (E46)	106	CORVETTE	124
A3 SPORTBACK (8VA)	66	3 TOURING (E91)	106	CORVETTE (C6)	125
A4 (8D2, B5)	67	3 TOURING (F31)	107	CRUZE (J300)	125
A4 (8E2, B6)	69	4 (F32, F82)	108	CRUZE (J305)	126
A4 (8EC, B7)	69	4 (F33, F83)	108	CRUZE STATION WAGON (J308)	126
A4 (8H7, B6, 8HE, B7)	70	4 Convertible (F33, F83)	109	EPICA (KL1_)	126
A4 (8K2, B8)	71	4 Coupe (F32, F82)	109	EVANDA	127
A4 ALLROAD (8KH, B8)	72	4 GRAN (F36)	109	IMPALA	127
A4 AVANT (8D5, B5)	72	4 Gran Coupe (F36)	110	KALOS	127
A4 AVANT (8E5, B6)	74	5 (E34)	110	LACETTI	127
A4 AVANT (8ED, B7)	75	5 (E39)	110	LACETTI (J200)	127
A4 AVANT (8K5, B8)	76	5 (E60)	110	LACETTI / OPTRA (J200)	128
A5 (8F7)	76	5 (F10, F18)	112	LUMINA APV	128
A5 (8T3)	77	5 GRAN TURISMO (F07)	112	MALIBU	128
A5 (8TA)	78	5 TOURING (E34)	113	MALIBU (V300)	128
A5 CONVERTIBLE (8F7)	78	5 TOURING (E39)	113	MATIZ (M200, M250)	128
A5 SPORTBACK (8TA)	79	5 TOURING (E61)	113	NUBIRA	128
A6 (4A, C4)	79	5 TOURING (F11)	114	OPTRA (1J_)	129
A6 (4B2, C5)	80	6 (E63)	115	OPTRA Estate	129
A6 (4F2, C6)	82	6 (E64)	115	ORLANDO (J309)	129
A6 (4G2, C7)	82	6 (F12)	115	PRIZM	129
A6 (4G2, C7, 4GC)	83	6 (F13)	116	SILVERADO 1500	129
A6 ALLROAD (4FH, C6)	84	6 GRAN (F06)	116	SILVERADO 2500	129
A6 ALLROAD (4GH)	84	7 (E32)	116	SILVERADO 3500	129
A6 ALLROAD (4GH, 4GJ)	84	7 (E38)	116	SPARK	129
A6 AVANT (4A, C4)	84	7 (E65, E66, E67)	116	SPARK (M300)	130
A6 AVANT (4B5, C6)	85	7 (E65, E66, E67)	117	SUBURBAN (GMT 900)	130
A6 AVANT (4F5, C6)	86	7 (F01, F02, F03, F04)	117	TACUMA	130
A6 AVANT (4G5, C7)	87	8 (E31)	117	TAHOE (B2W)	130

MAKE-MODEL	PAGE	MAKE-MODEL	PAGE	MAKE-MODEL	PAGE
CHEVROLET		CITROEN		DAIHATSU	
TRAILBLAZER (KC_)	130	EVASION (22, U6)	158	CUORE VI (L7_)	193
TRAX	130	JUMPER	158	CUORE VII (L251)	193
VIVANT	130	JUMPER (230)	158	CUORE VIII	193
CHRYSLER		JUMPER (244)	159	EXTOL	193
300 C	130	JUMPY	159	EXTOL (S22_, S23_)	193
300 C (LX)	130	JUMPY (BS_, BT_, BY_, BZ_)	159	GRAN MOVE (G3)	193
300 C TOURING (LX)	131	NEMO	159	MATERIA (M4_)	193
300 M (LR)	131	NEMO (AA_)	159	MOVE (L6, L9)	193
CIRRUS	131	RELAY	159	SIRION (M1)	193
GRAND VOYAGER V (RT)	131	RELAY (230)	160	SIRION (M3_)	193
NEON (PL)	131	RELAY (230L)	161	TERIOS (J1)	194
NEON II	132	RELAY (230P)	164	TERIOS (J2_)	194
PACIFICA	132	RELAY (244)	166	TREVIS	194
PT CRUISER	132	RELAY (244, Z_)	167	YRV (M2)	194
PT CRUISER (PT_)	132	RELAY VNA	168	DODGE	
SEBRING (JR)	133	SAXO (S0, S1)	168	AVENGER	194
SEBRING (JS)	133	SYNERGIE (22, U6)	169	CALIBER	194
STRATUS (JA)	133	XANTIA (X1)	170	CARAVAN	195
STRATUS (JX)	133	XANTIA (X2)	171	CARAVAN (RG_)	195
TOWN & COUNTRY	133	XM (Y3)	173	CHALLENGER	195
VOYAGER II (ES)	133	XM (Y4)	173	CHARGER	196
VOYAGER II (GS)	133	XSARA	174	DAKOTA	196
VOYAGER III (RG, RS)	134	XSARA (N0)	174	DURANGO	196
CITROEN		XSARA (N1)	176	GRAND CARAVAN	196
AX (ZA-)	134	XSARA (N2)	178	JOURNEY	196
BERLINGO	134	XSARA PICASSO (N68)	181	NEON	196
BERLINGO (B9)	136	ZX (N2)	182	NEON II	196
BERLINGO (M_)	136	DACIA		NITRO	197
BERLINGO (MF)	138	DOKKER	184	RAM 1500	197
BX (XB-)	140	DOKKER EXPRESS	184	RAM 1500 PICKUP (D1, DC, DH, DM, DR)	197
BX BREAK (XB-)	140	DUSTER	184	RAM 2500	197
C1 (PM_, PN_)	140	LODGY	184	RAM 2500 PICKUP (D1, DC, DH, DM, DR)	197
C1 II	140	LOGAN (LS_)	184	RAM 3500	197
C15	140	LOGAN (US_)	186	STRATUS	197
C15 (VD-)	140	LOGAN EXPRESS (FS_)	186	FIAT	
C2 (JM_)	140	LOGAN II	187	500	197
C2 ENTERPRISE	141	LOGAN MCV (KS_)	187	500 (312)	198
C25 (280_, 290_)	141	LOGAN MCV II	188	500 C	198
C3 I (FC_)	141	NOVA	188	500 C (312)	198
C3 II	142	SANDERO	188	500L	198
C3 PICASSO	143	SANDERO II	189	BARCETTA (183)	198
C3 PLURIEL (HB_)	144	SOLENZA	189	BRAVA (182)	199
C4	144	SUPERNOVA	189	BRAVO I (182)	200
C4 (LA_)	144	DAEWOO		BRAVO II (198)	201
C4 AIRCROSS	146	CIELO	189	BRAVO VAN (198)	202
C4 CACTUS	146	ESPERO (KLEJ)	190	CINQUECENTO (170)	202
C4 GRAND PICASSO I (UA_)	146	EVANDA (KLAL)	190	COUPE (FA/175)	202
C4 GRAND PICASSO II	147	KALOS (KLAS)	190	CROMA (154)	203
C4 I (LC_)	147	LACETTI (J200)	190	CROMA (194)	203
C4 II (B7)	148	LACETTI (KLAN)	190	DOBLO (119)	203
C4 PICASSO I (UD_)	149	LANOS (KLAT)	190	DOBLO (152)	204
C4 PICASSO II	150	LEGANZA (KLAJ)	191	DOBLO (152, 263)	204
C5 I (DC_)	150	MATIZ (KLYA)	191	DOBLO (263)	204
C5 I (DE_)	150	NEXIA (KLETN)	191	DOBLO CARGO (223)	206
C5 II (RC_)	150	NUBIRA	191	DOBLO MPV (223, 119)	206
C5 II BREAK (RE_)	151	NUBIRA (KLAJ)	191	DUCATO (230)	206
C5 III (RD_)	151	NUBIRA (KLAN)	192	DUCATO (230L)	212
C5 III BREAK (TD_)	152	NUBIRA WAGON (KLAJ)	192	DUCATO (244)	214
C6 (TD_)	152	NUBIRA WAGON (KLAN)	192	DUCATO (244, Z_)	216
C8 (EA_, EB_)	152	TACUMA (KLAU)	192	DUCATO (250)	217
C-CROSSER (EP_)	153	TICO (KLY3)	192	DUCATO (250, 290)	218
C-CROSSER ENTERPRISE	153	DAIHATSU		DUCATO (290)	218
C-ELYSEE	153	APPLAUSE II (A101)	192	DUCATO 250)	219
DISPATCH	153	BEGO	192	DUCATO PANORAMA (290)	219
DISPATCH (BU_, BV_, BW_, BX_)	154	CHARADE	192	FIORINO (146)	219
DISPATCH (U6U)	154	CHARADE (L2_)	193	FIORINO (225)	219
DISPATCH VAN (BS_, BT_, BY_, BZ_)	154	CHARADE III (G100, G101, G102)	193	FREEMONT (JF_)	219
DISPATCH VAN (BU_, BV_, BW_, BX_)	154	CHARADE III (G102)	193	GRANDE PUNTO (199)	220
DS3	155	CHARADE IV (G200, G202)	193	IDEA	220
DS4	157	CHARADE IV (G203)	193	LINEA (323)	220
DS5	157	COPEN	193	MAREA (185)	221

MAKE-MODEL	PAGE	MAKE-MODEL	PAGE	MAKE-MODEL	PAGE
FIAT		FORD		FORD USA	
MAREA WEEKEND (185)	222	F-250	249	EXPLORER (UN46)	278
MULTIPLA (186)	223	F-250 SUPER DUTY	249	MUSTANG	278
PALIO (178BX)	224	FALCON (FG)	250	MUSTANG (C)	278
PALIO WEEKEND (178DX)	225	FALCON AU1, AU2,AU3, BA	250	TAURUS (P5_)	279
PANDA (141A_)	226	FIESTA	250	TAURUS WAGON (P5_)	279
PANDA (169)	226	FIESTA III (GFJ)	250	WINDSTAR (A3)	279
PANDA (312, 319)	227	FIESTA IV (JA_, JB_)	250	GEO	
PANDA VAN (141_)	227	FIESTA V (JH_, JD_)	251	PRIZM	279
PANDA VAN (169)	227	FIESTA V VAN	251	GM/DAEWOO	
PANDA VAN (312)	228	FIESTA VAN	251	LEGANZA 5BOLT TYPE	279
PANDA VAN(169)	228	FIESTA VI	252	GMC	
PUNTO (176)	228	FIESTA VI VAN	252	SIERRA 3500	279
PUNTO (176C)	229	FOCUS (DAW, DBW)	253	HAFEI	
PUNTO (188)	229	FOCUS (DFW)	254	LOBO / LUBAO	279
PUNTO (199)	220	FOCUS (DNW)	254	HOLDEN	
PUNTO / GRANDE PUNTO (199)	231	FOCUS C-MAX	255	COMMODORE (VE)	279
PUNTO EVO (199)	231	FOCUS II	256	COMMODORE (VR-VS)	279
PUNTO VAN (176L)	232	FOCUS II (DA_)	256	COMMODORE (VT) SERIES II, VX VY VU	279
PUNTO VAN (188AX)	232	FOCUS II STATION WAGON (DA_)	258	COMMODORE (VT) SERIES I	279
PUNTO VAN (199)	232	FUSION (JU_)	258	HONDA	
QUBO (225)	233	GALAXY	259	ACCORD	279
SCUDO (220L)	233	GALAXY (WA6)	259	ACCORD IV (CB)	279
SCUDO (270_)	233	GALAXY (WGR)	259	ACCORD IV (CC1)	280
SCUDO (272, 270)	233	GRANADA III (GAE, GGE)	259	ACCORD V (CC7, CD)	280
SCUDO COMBINATO (220P)	233	GRANADA III (GGE)	260	ACCORD V (CD7, CD9)	280
SEDCI	234	KA	260	ACCORD V (CE)	280
SEICENTO (187)	234	KA (RB_)	260	ACCORD VI (CE, CF)	280
SEICENTO / 600 (187)	234	KA VAN (RB)	261	ACCORD VI (CG, CK)	280
SEICENTO VAN (187)	234	KUGA I	261	ACCORD VII (CG)	280
SIENA	234	KUGA II (DM2)	261	ACCORD VII (CG, CK)	280
SIENA (178_)	234	MAVERICK (UDS, UNS)	261	ACCORD VII (CH)	281
STILO (192)	235	MONDEO (BNP)	261	ACCORD VII (CL)	281
STILO MULTI WAGON (192)	236	MONDEO (GBP)	261	ACCORD VII (CM)	281
STRADA (178E)	237	MONDEO I (BNP)	262	ACCORD VII (CP)	281
STRADA (578_)	237	MONDEO I (GBP)	262	ACCORD VII TOURER (CM)	281
TEMPRA (159)	237	MONDEO II (BAP)	262	ACCORD VIII	281
TEMPRA S.W. (159)	238	MONDEO II (BFP)	263	ACCORD VIII (CU)	281
TIPO (160)	239	MONDEO II (BNP)	263	AVANCIER	282
ULYSSE (179AX)	240	MONDEO III (B4Y)	263	CITY	282
ULYSSE (220)	241	MONDEO III (B5Y)	264	CITY (GM)	282
UNO (146A/E)	241	MONDEO III (BWY)	264	CITY (EG)	282
FORD		MONDEO IV	264	CIVIC IV (EG, EH)	282
B-MAX	241	MONDEO IV (BA7)	265	CIVIC IV (MA, MB)	282
B-MAX (JK)	242	MONDEO IV TURNIER	265	CIVIC IX (FB, FG)	282
B-MAX VAN	242	ORION III (GAL)	266	CIVIC IX (FK)	282
C-MAX	242	PUMA (EC_)	266	CIVIC IX TOURER (FK)	283
C-MAX (DM2)	242	RANGER	267	CIVIC V (EG, EH)	283
COUGAR (EC_)	242	RANGER (TU_)	267	CIVIC V (EJ, EK)	283
COURIER (F3L, F5L)	243	SCORPIO I (GGE)	267	CIVIC V (MB, MC)	283
COURIER (J5_, J3_)	243	SCORPIO II (GFR, GGR)	267	CIVIC VI (EJ, EK)	283
COURIER (JV_)	243	SIERRA (BNG)	267	CIVIC VI (EJ, EM1)	283
CROWN VICTORIA	243	SIERRA (GBC, GBG)	267	CIVIC VII (EM2)	284
ECOSPORT	243	SIERRA (GBG, GB4)	268	CIVIC VII (ES)	284
ESCORT '91 EXPRESS (AVL)	243	S-MAX	268	CIVIC VII (EU, EP, EV)	284
ESCORT '95 (AVL)	244	S-MAX (WA6)	269	CIVIC VIII (FD, FA)	284
ESCORT CLASSIC (AAL, ABL)	244	STREET KA	269	CIVIC VIII (FN, FK)	285
ESCORT CLASSIC TURNIER (ANL)	244	TOURNEO CONNECT	269	CIVICK IV (EJ)	285
ESCORT V (ALL)	244	TOURNEO COURIER Kombi	269	CROSSROAD	285
ESCORT V (GAL)	244	TRANSIT	269	CR-V	285
ESCORT V (GAL, AVL)	245	TRANSIT (E_)	273	CR-V I (RD)	285
ESCORT VI (ALL)	245	TRANSIT (FA_)	274	CR-V II (RD_)	285
ESCORT VI (GAL)	245	TRANSIT (FD_, FB_, FS_, FZ_, FC_)	274	CR-V III (RE)	286
ESCORT VII (ALL)	247	TRANSIT (FM_, FN_)	275	CR-V IV (RE)	286
ESCORT VII (GAL, AAL, ABL)	247	TRANSIT CONNECT (P65_, P70_, P80_)	276	CRX III (EH, EG)	286
ESCORT VII (GAL, AFL)	248	TRANSIT COURIER	276	CR-Z (ZF1)	286
EXCURSION	249	TRANSIT COURIER Kombi	276	ELEMENT	286
EXPEDITION	249	TRANSIT TOURNEO	276	ELYSION	286
EXPLORER	249	TRANSIT VAN (E_)	277	FR-V (BE)	287
EXPLORER SPORT TRAC	249	TRANSIT VAN (FA_)	277	HR-V (GH)	287
F-150	249	FORD USA		INSIGHT (ZE)	287
F-150 HERITAGE	249	EXPLORER (U2)	278	INSIGHT (ZE_)	287

MAKE-MODEL	PAGE	MAKE-MODEL	PAGE	MAKE-MODEL	PAGE
HONDA		HYUNDAI		KIA	
JAZZ II (GD)	287	PONY / EXCEL (X-2)	304	CADENZA	319
JAZZ III (GE)	287	S (SLC)	305	CARENS I (FC)	319
LEGEND III (KA9)	287	SANTA FE I (SM)	305	CARENS II (FJ)	319
LEGEND IV (KB_)	287	SANTA FE II (CM)	305	CARENS III (UN)	319
LOGO (GA3)	287	SANTA FE III (DM)	305	CARENS IV	320
MOBILIO	287	SANTAMO	306	CARNIVAL / GRAND CARNIVAL III (VQ)	320
ODYSSEY III (LHD)	288	SONATA	306	CARNIVAL I (UP)	320
ODYSSEY III (RHD) RB1 / RB2	288	SONATA (Y-2)	306	CEE`D	320
ODYSSEY IV (RHD) RB3 / RB4	288	SONATA II (Y-3)	306	CEE`D SPORTSWAGON (JD)	320
PILOT	288	SONATA III (EF)	306	CEE`D	320
PRELUDE IV (BB)	288	SONATA III (Y-3)	307	CEE`D (ED)	321
PRELUDE V (BB)	288	SONATA IV (EF)	307	CEE`D (JD)	322
S2000 (AP)	288	SONATA V (NF)	307	CERATO (LD)	322
SHUTTLE (RA)	288	SONATA VI (YF)	308	CERATO II (TD)	323
STEPWGN (DBA-RK_)	288	SONATA VII (LF)	308	CLARUS (GC)	323
STREAM (RN)	288	TERRACAN (HP)	308	CLARUS (K9A)	323
HUMMER					
HUMMER H2 SUT	288	TRAJET (FO)	308	JOICE	323
HUMMER H3	288	TUCSON	308	K3	323
HYUNDAI					
ACCENT (LC)	288	TUCSON (JM)	308	K3 (TD)	323
ACCENT (MC)	289	TUCSON (JM)	308	K3 II (TD)	323
ACCENT (X-3)	289	TUCSON (TLE)	309	K3 II (TD)	323
ACCENT I (X-3)	290	VELOSTER (FS)	309	K5	323
ACCENT II (LC)	290	XG (XG)	309	MAGENTIS (GD)	324
ACCENT III (MC)	291	XG350	310	MAGENTIS (MG)	324
ACCENT IV (RB)	291	INFINITI		MENTOR (FA)	324
AMICA (MX)	292	FX	310	OPIRUS (GH)	325
AMICA / ATOZ (MX)	292	G	310	OPTIMA	325
ATOS (MX)	292	I30	310	PICANTO (BA)	325
ATOS PRIME (MX)	292	M (Y51)	310	PICANTO (TA)	325
COUPE (RD)	292	M35	310	PRIDE	325
ELANTRA (HD)	292	M35 / 45 (Y50)	310	PRIDE (DA)	325
ELANTRA (MD, UD)	293	M37	310	PRO CEE`D (JD)	325
ELANTRA (XD)	293	Q50	310	PRO CEED	325
EQUUS	295	Q70 (Y51)	310	PRO CEED (ED)	326
EQUUS NEW	295	QX50	310	RIO (DC)	326
GALLOPER I	295	QX70	311	RIO (DC_)	326
GENESIS	295	ISUZU		RIO II (JB)	327
GETZ (TB)	296	ASCENDER	311	RIO III (UB)	327
GRAND SANTA FÉ	296	IVECO		RONDO	327
GRANDEUR (HG)	296	DAILY CITYS	311	SEDONA II (GQ)	327
GRANDEUR (TG)	296	DAILY II	311	SEDONA II (VQ)	328
GRANDEUR NEW	297	DAILY III	312	SHUMA (FB)	328
GRANDEUR TG(AZERA)	297	DAILY IV	314	SHUMA II (FB)	328
GRANDEUR XG	297	DAILY IV DUMPTRUCK	315	SORENTO I (JC)	328
H-1	297	DAILY LINE	315	SORENTO II (XM)	329
H-1 / STAREX	297	DAILY TOURYS	315	SOUL	329
H-1 CARGO (TQ)	297	DAILY VI	315	SOUL (AM)	329
H-1 TRAVEL (TQ)	297	JAGUAR		SOUL II (PS)	329
H100	297	S-TYPE (CCX)	316	SOUL II (PS)	329
H100 (P)	297	XF (_J05_, CC9)	316	SPORTAGE	329
i10 (PA)	298	XJ (X350, X358)	316	SPORTAGE (JE_)	329
i20	298	XK (_J43_)	316	SPORTAGE (K00)	330
i20 (GB)	298	XK (QQ6_, _J43_)	316	SPORTAGE (SL)	330
i20 (PB, PBT)	298	XK 8 (QDV)	316	SPORTAGE NEW	331
i30 (FD)	298	XK 8 (QEV)	316	VENGA (YN)	331
i30 (GD)	299	X-TYPE	316	LADA	
i30 CW (FD)	299	X-TYPE (CF1)	317	NIVA (2121)	331
i30 CW (GD)	300	JEEP		SAMARA (2108, 2109)	331
i40 (VF)	300	CHEROKEE (KJ)	317	SAMARA FORMA (21099)	331
i40 CW (VF)	300	CHEROKEE (KK)	318	LANCIA	
ix20 (JC)	300	CHEROKEE (XJ)	318	DEDRA (835)	331
ix35 (LM, EL, ELH)	301	COMMANDER (XK)	318	DELTA II (836)	333
ix55	301	COMPASS (MK49)	318	DELTA III (844)	334
LANTRA (GK)	301	GRAND CHEROKEE (ZJ)	318	FLAVIA (JS)	334
LANTRA (J-1)	302	GRAND CHEROKEE II (WJ, WG)	318	KAPPA (838)	334
LANTRA (RD)	302	GRAND CHEROKEE III (WH, WK)	318	KAPPA (838A)	334
LANTRA II (J-2)	302	PATRIOT (MK74)	319	KAPPA (838B)	335
LANTRA II WAGON (J-2)	304	WRANGLER (YJ, SJ_)	319	LYBRA (839AX)	335
MATRIX (FC)	304	WRANGLER II (TJ)	319	LYBRA (839BX)	335
		WRANGLER III (JK)	319	LYBRA SW (839BX)	335
		KIA		MUSA (350)	336
		AVELLA	319	PHEDRA (179)	336
				THEMA (834)	336

MAKE-MODEL	PAGE	MAKE-MODEL	PAGE	MAKE-MODEL	PAGE
LANCIA		MAZDA		MERCEDES BENZ	
THEMA (LX)	337	6 (GH)	351	E-CLASS (W210)	375
THESES (841AX)	337	6 (GJ, GH)	352	E-CLASS (W211)	377
VOYAGER (RT)	337	6 GG	352	E-CLASS (W212)	378
Y (840A)	337	6 GH	352	E-CLASS T-MODEL (S211)	379
Y10 (156)	338	6 MPS GG	352	E-CLASS T-MODEL (S212)	380
YPSILON (843)	338	6 STATION WAGON (GY)	352	G-CLASS (W461)	381
YPSILON (846)	338	6 WAGON GH	352	G-CLASS (W463)	381
ZETA (220)	338	6 WAGON GY	352	G-CLASS CABRIO (W463)	382
LAND ROVER		626 III (GV)	352	GL-CLASS (X164)	382
LR3	339	626 IV (GE)	352	GL-CLASS (X166)	383
LR4	339	626 V (GF)	353	GLE (C292)	383
RANGE ROVER SPORT	339	626 V (GW)	353	GLE (W166)	383
DEFENDER (LD_)	339	ATENZA (GJ, GH)	354	GLK-CLASS (X204)	383
DEFENDER CABRIO (LD)	339	ATENZA GG	354	KOMBI (S124)	383
DEFENDER STATION WAGON (LD)	339	B3000	354	M-CLASS (W163)	383
DISCOVERY (LJ, LG)	339	B4000	354	M-CLASS (W164)	384
DISCOVERY II (LJ, LT)	339	B-SERIE (UF)	354	M-CLASS (W166)	384
DISCOVERY III (TAA)	339	B-SERIE (UN)	354	R-CLASS (W251, V251)	384
DISCOVERY IV (LA)	340	BT-50 (CD, UN)	354	SALOON (W124)	384
FREELANDER (LN)	340	CX-5 (KE, GH)	354	S-CLASS (C140)	384
FREELANDER 2 (FA_)	340	CX-7 (ER)	355	S-CLASS (C215)	385
FREELANDER SOFT TOP	340	CX-7 ER	355	S-CLASS (C216)	385
RANGE ROVER (AE, AN, HAA, HAB, HAM, HBM, RE, RN)	340	CX-9 (TB)	355	S-CLASS (W140)	385
RANGE ROVER II (LP)	340	DEMIO (DW)	355	S-CLASS (W220)	386
RANGE ROVER SPORT (LS)	340	E-SERIE (SR2)	355	S-CLASS (W221)	386
RANGE ROVER SPORT (LW)	341	MPV II (LW)	355	SL (R129)	387
LEXUS		MPV LY	355	SL (R230)	387
CT (ZWA1_)	341	MX-3 (EC)	355	SL (R231)	387
ES (AVV6_, GSV6_, ASV6_)	341	MX-5 (NA)	356	SLK (R170)	387
ES (GSV4_, ACV4_)	341	MX-5 I (NA)	356	SLK (R171)	388
ES (MCV_, VZV_)	341	MX-5 II (NB)	356	SLK (R172)	388
GS (GRL1_, GWL1_)	341	MX-5 III (NC)	356	SLS AMG (A197)	388
GS (GRS19_, UZS19_, GWS19_)	341	MX-6 (GE)	356	SPRINTER 2-T (901, 902)	388
GX (URJ15_)	342	PREMACY (CP)	356	SPRINTER 3,5 (906)	390
IS C (GSE2_)	342	RX 8 (SE17)	357	SPRINTER 3,5-T (906)	391
IS I (JCE1_, GXE1_)	342	XEDOS 6 (CA)	357	SPRINTER 3,5-T (906)	391
IS II (GSE2_, ALE2_, USE2_)	342	XEDOS 9 (TA)	357	SPRINTER 3-T (903)	392
IS III (GSE3_, AVE3_)	342	MERCEDES BENZ		SPRINTER 3-T (906)	394
LS (UCF30)	342	100 (631)	357	SPRINTER 4,6-T (906)	395
LX (URJ201)	342	190 (W201)	357	SPRINTER 4-T (904)	396
NX (ZGZ1_, AGZ1_, AYZ1_)	343	A-CLASS (W168)	357	SPRINTER 5-T (906)	398
RX (GGL1_, GYL1_, AGL1_)	343	A-CLASS (W169)	358	SPRINTER CLASSIC 3,5-T (909)	399
RX (GYL1_, GGL15, AGL10)	343	B-CLASS (W245)	358	SPRINTER CLASSIC 4,6-T (909)	399
RX (MCU15)	343	CABRIOLET (A124)	359	T1 (602)	399
RX (MHU3_, G SU3_, MCU3_)	343	C-CLASS (C204)	359	VANEO (414)	399
LINCOLN		C-CLASS (CL203)	359	V-CLASS (638/2)	400
AVIATOR	343	C-CLASS (S202)	360	VIANO (W639)	400
MARK LT	343	C-CLASS (W202)	361	VITO (638)	400
NAVIGATOR	343	C-CLASS (W203)	362	VITO (W639)	400
TOWN CAR	343	C-CLASS (W204)	363	VITO / MIXTO (W639)	401
MAZDA		C-CLASS T-MODEL (S203)	365	MERCURY	
121 II (DB)	344	C-CLASS T-MODEL (S204)	366	GRAND MARQUIS	402
121 III (JASM, JBSM)	344	CITAN (415)	367	MOUNTAINEER	402
2 (DE)	344	CITAN COMBI (415)	367	MG	
2 (DY)	344	CITAN MIXTO (415)	367	MG ZR	402
3 (BK)	345	CLC-CLASS (CL203)	367	MG ZS	402
3 (BL)	345	CLK (A208)	368	MG ZT	402
3 (BM)	346	CLK (A209)	368	MG ZT- T	402
323 C IV (BG)	346	CLK (C208)	369	MINI	
323 C V (BA)	346	CLK (C209)	369	MINI (R50, R53)	403
323 F IV (BG)	347	CLS (C218)	370	MINI (R52)	403
323 F V (BA)	347	CLS (C219)	370	MINI (R56)	404
323 F/P VI (BJ)	347	CLS SHOOTING BRAKE (X218)	371	MINI (R57)	404
323 III (BV)	348	COUPE (C124)	371	MINI (R58)	405
323 P V (BA)	348	E-CLASS (A124)	371	MINI CLUBMAN (R55)	405
323 S IV (BG)	348	E-CLASS (A207)	372	MINI COUNTRYMAN (R60)	405
323 S V (BA)	348	E-CLASS (C124)	372	MINI PACEMAN (R61)	406
323 S VI (BJ)	349	E-CLASS (C207)	372	MINI ROADSTER (R59)	406
5 (CR19)	350	E-CLASS (S124)	373	MITSUBISHI	
5 (CW)	350	E-CLASS (S210)	373	3000 GT (Z16A)	406
6 (GG)	350	E-CLASS (W124)	374	ASX (GA_W_)	406

MAKE-MODEL	PAGE	MAKE-MODEL	PAGE	MAKE-MODEL	PAGE
MITSUBISHI		NISSAN		NISSAN	
ASX VAN (GA_W_)	406	370 Z ROADSTER (Z34)	420	SUNNY IV	436
CARISMA (DA_)	407	ALMERA (N15)	420	SUNNY NEO	436
CHALLENGER (K90)	408	ALMERA I (N15)	421	SYLPHY (C13)	436
COLT CZC (RG)	408	ALMERA II (N16)	421	TEANA I (J31)	436
COLT III (C5_A)	408	ALMERA TINO (V10)	423	TEANA II (J32)	436
COLT IV (CA_A)	408	ALTIMA	423	TERRANO (WD21)	436
COLT V (CJ_, CP_)	408	ARMADA	423	TERRANO II (R20)	436
COLT VI (Z3_A, Z2_A)	408	AVENIR	423	TIIDA (SC11X)	436
DELICA (P0_W, P1_W, P0_V, P1_V, P2_V, P2_W)	409	BASSARA JU30	424	TIIDA (C11X)	436
DELICA (P0_W, P1_W, P2_W)	409	CEDRIC X (Y34)	424	TIIDA (SC11X)	437
ECLIPSE (D2_A)	409	CEFIRO I (J31)	424	TITAN	437
ECLIPSE II (D3_A)	409	CUBE (Z11)	424	URVAN (E25)	437
ECLIPSE IV (DK_A)	409	CUBE (Z12)	424	VANETTE (C22)	437
GALANT (DJ_, ED_, EF_)	409	ELGRAND (E51)	424	X-TRAIL (T30)	437
GALANT IV (E3_A)	409	FUGA Y50	424	X-TRAIL (T31)	438
GALANT V (E5_A, E7_A, E8_A)	409	INTERSTAR (X70)	424	NISSAN DF	393
GALANT VI (EA_)	410	JUKE (F15)	424	TEANA (J32)	438
GRANDIS (NA_W)	412	KUBISTAR	425	TIIDA QIDA (C11)	438
L 200 (K7_T, K6_T)	412	KUBISTAR (X76)	425	TIIDA YIDA (C11)	438
L 200 (KA_T, KB_T)	412	LAFESTA	425	OLDSMOBILE	
L 200 (KB_T, KA_T)	412	LEAF	425	ALERO	439
L 300 (P0_W, P1_W, P2_W)	412	LIVINA / GRAND LIVINA (L10, L11)	426	CUTLASS SUPREME	439
L 400 (PD_W, PC_W, PB_V, PA_W, PA_V)	412	MAXIMA QX (A32)	426	OPEL	
L 400 / SPACE GEAR (PD_W, PC_W, PA_V, PB_V)	412	MAXIMA QX (A33)	426	ADAM	439
LANCER (CS_A)	412	MAXIMA STATION WAGON	426	AGILA (A) (H00)	439
LANCER (CS_A, CT0)	413	MICRA C+C (K12)	426	AGILA (B) (H08)	439
LANCER (CS_W)	413	MICRA II (K11)	426	ANTARA	440
LANCER (CX_A)	413	MICRA III (K12)	426	ASTEA H (L48)	440
LANCER (CY/Z_A)	413	MICRA IV (K13)	427	ASTRA F (51_, 52_)	440
LANCER III (C1_V, C3_V)	414	MURANO (Z50)	427	ASTRA F (53_, 54_, 58_, 59_)	443
LANCER IV (C6_A)	414	MURANO (Z51)	427	ASTRA F (53_B)	445
LANCER IV (C6_A, C7_A)	414	MYRANO (Z51)	427	ASTRA F (56_, 57_)	446
LANCER SPORTBACK (CX_A)	414	NAVARA (D21)	427	ASTRA F CLASSIC	449
LANCER V (CB/D_A)	415	NAVARA (D40)	427	ASTRA F VAN (55_)	449
LANCER V STATION WAGON (CB_W, CD_W)	415	NOTE (E11)	428	ASTRA G	450
LANCER VI (CJ-CP_)	415	NOTE (E12)	428	ASTRA G (F07_)	450
OUTLANDER I (CU_W)	415	NV200	428	ASTRA G (F35_)	451
OUTLANDER II (CW_W)	415	NV200 / EVALIA	428	ASTRA G (F48_, F08_)	452
OUTLANDER II VAN (CW_W)	416	NV200 EVALIA	428	ASTRA G (F69_)	453
OUTLANDER III (GG_W, GF_W, ZJ)	416	NV400	428	ASTRA G (F70)	455
OUTLANDER III VAN (GF_W, GG_W)	416	PATHFINDER (R50)	429	ASTRA GTC J	455
PAJERO / SHOGUN (L04_G, L14_G)	416	PATHFINDER (R51)	429	ASTRA H (L35)	455
PAJERO / SHOGUN (V2_W, V4_W)	416	PATROL GR (Y60, GR)	429	ASTRA H (L48)	457
PAJERO / SHOGUN CLASSIC (V2_W)	417	PATROL GR II (Y61)	429	ASTRA H (L69)	458
PAJERO / SHOGUN II (V3_W, V2_W, V4_W)	417	PICK UP (D22)	429	ASTRA H GTC (L08)	458
PAJERO / SHOGUN III (V6_W, V7_W)	417	PICK UP III (D22)	429	ASTRA H SPORP HATCH (L08)	458
PAJERO / SHOGUN III (V7_W, V6_W)	417	PIXO (UA0)	429	ASTRA H TWINTOP (L67)	460
PAJERO / SHOGUN IV (V8_W, V9_W)	417	PRAIRIE PRO (M11)	429	ASTRA H VAN (L70)	460
PAJERO CLASSIC (V2_W)	417	PRESAGE U30	429	ASTRA J	461
PAJERO III (V6_W, V7_W)	418	PRIMASTAR (X83)	430	ASTRA J SPORTS TOURER	462
PAJERO III (V7_W, V6_W)	418	PRIMASTAR VAN (X83)	430	CALIBRA A (85_)	463
PAJERO III CANVAS TOP (V6_W, V7_W)	418	PRIMERA (P10)	430	CASCADA (W13)	463
PAJERO IV (V8_W, V9_W)	418	PRIMERA (P11)	431	COMBO	463
PAJERO MINI (H5_A)	418	PRIMERA (P12)	432	COMBO (71_)	464
PAJERO SPORT II (KH_, KG_)	418	PRIMERA (WP12)	432	COMBO (X12)	464
RAIDER	418	PRIMERA TRAVELLER (W10)	433	COMBO TOUR	464
SHOGUN PININ (H6_W, H7_W)	418	PRIMERA TRAVELLER (WP11)	433	COMBO TOUR (X12)	465
SIGMA (F2_A, F1_A)	418	QASHQAI / QASHQAI +2 (J10, JJ10)	433	CORSA A (93_, 94_, 98_, 99_)	465
SIGMA STATION WAGON (F0_W)	418	QUEST (V42)	433	CORSA B (73_)	466
SPACE RUNNER (N1_W, N2_W)	418	R-NESSA N30	434	CORSA B (73_, 78_, 79_)	466
SPACE STAR (DG_A)	418	SENTRA IV (B14)	434	CORSA B (F35)	467
SPACE WAGON (N3_W, N4_W)	419	SENTRA V (B15)	434	CORSA C (F08, F68)	467
SPACE WAGON (N9_W, N8_W)	419	SKYLINE (R33)	434	CORSA C (F08, W5L)	467
NISSAN		SKYLINE (R34)	434	CORSA D	468
100 NX (B13)	419	SKYLINE (V35)	434	CORSA D VAN	469
200 SX (S13)	419	STAGEA (M35)	434	CORSA E	469
200 SX (S14)	419	STAGEA (WC34)	434	CORSA E VAN	470
240 SX	419	SUNNY (Y10)	434	GT	470
350 Z (Z33)	419	SUNNY III	434	INSIGNIA	470
350 Z ROADSTER (Z33)	420	SUNNY III (N14)	434	INSIGNIA SPORTS TOURER	471
370 Z (Z34)	420	SUNNY III (Y10)	436	KADETT E (33_, 34_, 43_, 44_)	472

MAKE-MODEL	PAGE	MAKE-MODEL	PAGE	MAKE-MODEL	PAGE
OPEL		PEUGEOT		RAM	
KADETT E (35_, 36_, 45_, 46_)	472	307 (3E)	511	DAKOTA	544
KADETT E (37_, 47_)	472	307 (3H)	512	RENAULT	
KADETT E (39_, 49_)	472	307 CC (3B)	513	19 (D53_)	544
KADETT E (43B_)	473	307 SW (3H)	514	19 (L53_)	545
KADETT E COMBO (38_, 48_)	473	308	514	19 I (B/C53_)	545
MERIVA	473	308 (4A_, 4C_)	514	19 I CABRIOLET (D53_)	545
MERIVA B	474	308 CC	515	19 I CHAMADE (L53_)	545
MOKKA	474	308 SW	515	19 II (B/C53_)	545
MOVANO (F9)	474	309 II (3C, 3A)	516	19 II (D53_, 853_)	546
MOVANO (H9)	475	4007 (GP_)	517	19 II (L53_)	546
MOVANO (J9)	476	4008	517	19 II (S53_)	547
MOVANO (U9, E9)	476	405 I (15B)	517	19 II CABRIOLET (D53_, 853_)	547
MOVANO B	477	405 I BREAK (15E)	517	19 II CHAMADE (L53_)	547
OMEGA A (16_, 17_, 19_)	477	405 II (4B)	517	21 (L48_)	547
OMEGA A (66_, 67_)	478	405 II (4E)	518	21 SAVANNA (K48_)	548
OMEGA B (21_, 22_, 23_)	478	405 II BREAK (4E)	518	AVANTIME (DE0_)	548
OMEGA B (21_, 22_, 23_)	479	406 (8B)	518	CAPTUR	548
OMEGA B (25_, 26_, 27_)	479	406 (8C)	520	CLIO (B/C57_, 5/357_)	548
SENATOR B (29_)	480	406 (8E/F)	520	CLIO GRANDTOUR (KR0/1_)	549
SIGNUM	480	406 BREAK (8E/F)	521	CLIO GRANDTOUR IV	550
SINTRA	481	407 (6C_)	521	CLIO I (B/C57_, 5/357_)	551
TIGRA (95_)	481	407 (6D_)	522	CLIO I (S57_)	551
TIGRA TWINTOP	481	407 (6E_)	522	CLIO II (BB0/1/2_, CB0/1/2_)	551
VECTRA A (86_, 87_)	482	408	523	CLIO II (SB0/1/2_)	553
VECTRA A (88_, 89_)	482	5008	523	CLIO III (BR0/1, CR0/1)	554
VECTRA B (31_)	483	508	523	CLIO IV	555
VECTRA B (36_)	484	508 SW	524	CLIO MK II (BB0/1/2_, CB0/1/2_)	556
VECTRA B (38_)	485	605 (6B)	524	DUSTER	556
VECTRA C	487	607 (9D, 9U)	525	ESPACE II (J/S63_)	556
VECTRA C GTS	488	806 (221)	525	ESPACE III (JE0_)	556
VIVARO (E7)	489	807 (E)	526	ESPACE IV (JK0/1_)	556
VIVARO (F7)	490	BIPPER (AA_)	526	EXPRESS	557
VIVARO (J7)	490	BIPPER TEPEE	526	EXTRA (F40_, G40_)	557
ZAFIRA A (F75_)	491	BOXER	526	EXTRA VAN (F40_, G40_)	557
ZAFIRA B (A05)	491	BOXER (ZCT_)	528	FLUENCE (L30_)	558
ZAFIRA B VAN	492	BOXER (230L)	528	GRAND SCENIC II (JM0/1_)	558
ZAFIRA TOURER C (P12)	492	BOXER (230P)	531	GRAND SCENIC III (JZ0/1_)	558
PEUGEOT		BOXER (244)	533	KANGOO (KC0/1_)	558
1007 (KM_)	493	BOXER (244, Z_)	534	KANGOO / GRAND KANGOO (KW0/1_)	560
106 (1A, 1C)	493	BOXER (ZCT_)	535	KANGOO BE BOP (KW0/1_)	560
106 II (1)	493	EXPERT	537	KANGOO EXPRESS (FC0/1_)	561
106 VAN (1_)	494	EXPERT (223)	537	KANGOO EXPRESS (FW0/1_)	562
107	494	EXPERT (224)	537	KOLEOS (HY_)	563
108	494	EXPERT (VF3A_, VF3U_, VF3X_)	537	LAGUNA I (B56_, 556_)	563
2008	495	EXPERT TEPEE (VF3V_)	538	LAGUNA I (K56_)	565
205 (741B, 20D)	495	EXPERT VAN (222)	538	LAGUNA II (BG0/1_)	566
205 II (20A/C)	495	J5 (290L)	538	LAGUNA II GRANDTOUR (KG0/1_)	566
205 VAN	496	J5 (290P)	539	LAGUNA II SPORT TOURER (KG0/1_)	566
206	496	PARTNER	539	LAGUNA III (BT0/1)	567
206 (2A/C)	496	PARTNER (5)	539	LAGUNA III GRANDTOUR (KT0/1)	567
206 (2E/K)	497	PARTNER (5F)	540	LAGUNA III SPORT TOURER (KT0/1)	568
206 2A/C)	497	PARTNER BOX (5)	540	LATITUDE (L70_)	568
206 CC (2D)	497	PARTNER COMBISPACE (5F)	540	LOGAN (KS_)	568
206 SW (2E/K)	498	PARTNER TEPEE	541	LOGAN (LS_)	568
206 VAN	498	PARTNER VAN (5)	542	LOGAN EXPRESS	568
206+ (T3E)	498	RCZ	543	LOGAN I (KS_)	569
207	498	PLYMOUTH		LOGAN I (LS_)	569
207 (WA_, WC_)	498	BREEZE	544	LOGAN II	569
207 (WK_)	499	NEON	544	MASTER II (ED/HD/UD)	569
207 CC (WD_)	500	NEON II	544	MASTER II (JD)	570
207 SW (WK_)	500	VOYAGER / GRAN VOYAGER	544	MASTER II VAN (FD)	570
207 VAN	500	PONTIAC		MASTER III (EV, HV, UV)	571
208	501	BONNEVILLE	544	MASTER III (FV)	571
3008	502	GRAND AM	544	MASTER III (JV)	572
301	502	TRANS SPORT	544	MEGANE CC (EZ0/1_)	572
306 (7A, 7C, N3, N5)	503	VIBE	544	MEGANE I (BA0/1_)	572
306 (7B, N3, N5)	505	PORSCHE		MEGANE I CABRIOLET (EA0/1_)	574
306 (7D, N3, N5)	507	CAYENNE (955)	544	MEGANE I CLASSIC (LA0/1_)	574
306 BREAK (7E, N3, N5)	508	PROTON		MEGANE I COACH (DA0/1_)	575
306 VAN (N_, 7_)	509	IMPIAN	544	MEGANE I GRANDTOUR (KA0/1_)	576
307 (3A/C)	509			MEGANE II SPORT TOURER (KM0/1_)	576

MAKE-MODEL	PAGE	MAKE-MODEL	PAGE	MAKE-MODEL	PAGE
RENAULT		SEAT		SMART	
MEGANE II (BM0/1_, CM0/1_)	576	AROSA (6H)	605	FORTWO CABRIO (451)	643
MEGANE II (EM0/1_)	577	CORDOBA (6K1, 6K2)	606	ROADSTER (452)	643
MEGANE II (KM0/1_)	577	CORDOBA (6K2)	608	SSANGYONG	
MEGANE II (LM0/1_)	577	CORDOBA (6L2)	608	ACTYON I	644
MEGANE II COUPE-CABRIOLET II (EM0/1_)	578	CORDOBA VARIO (6K5)	609	ACTYON SPORTS I (QJ)	644
MEGANE II SPORT TOURER (KM0/1_)	579	EXEO (3R2)	611	KYRON	644
MEGANE III (BZ0_)	579	EXEO ST (3R5)	611	REXTON (GAB_)	644
MEGANE III (DZ0/1_)	580	IBIZA (021A)	611	SUBARU	
MEGANE III GRANDTOUR (KZ0/1)	580	IBIZA II (6K1)	611	BAJA	644
MEGANE SCENIC (JA0/1_)	580	IBIZA III (6K1)	613	FORESTER (SF)	644
MODUS / GRAND MODUS (F/JP0_)	581	IBIZA IV (6L1)	614	FORESTER (SG)	644
RAPID (F40_, G40_)	583	IBIZA V (6J5)	615	FORESTER (SH)	645
SAFRANE (B54_)	583	IBIZA V (6J5, 6P1)	616	FORESTER (SJ)	645
SAFRANE II (B54_)	583	IBIZA V SPORTCOUPE (6J1)	616	IMPREZA	645
SANDERO / STEPWAY	583	IBIZA V SPORTCOUPE (6J1, 6P5)	617	IMPREZA (GC)	645
SANDERO / STEPWAY I	584	IBIZA V ST (6J8)	617	IMPREZA (GD)	645
SANDERO/STEPWAY I	584	IBIZA V ST (6J8, 6P8)	618	IMPREZA (GD, GG)	645
SANDERO/STEPWAY II	584	INCA (6K9)	618	IMPREZA (GF)	646
SCENIC I (JA0/1_)	584	LEON (1M1)	619	IMPREZA (GFC)	646
SCENIC II (JM0/1_)	558	LEON (1P1)	620	IMPREZA (GR)	647
SCENIC III (JZ0/1_)	558	LEON (5F1)	621	IMPREZA (GR, GH, G3)	647
THALIA I (LB0/1/2_)	586	LEON SC (5F5)	622	JUSTY III (G3X)	647
THALIA II (LU1/2_)	586	LEON ST (5F8)	622	LEGACY (BC)	647
TRAFIC (TXW)	586	MALAGA (023A)	623	LEGACY (BC, BJF)	647
TRAFIC (TXX)	587	MARBELLA (28)	623	LEGACY II (BD, BG)	647
TRAFIC II (EL)	587	MII (KF1_)	623	LEGACY III (BE, BH)	647
TRAFIC II (FL)	587	TOLEDO (1L)	623	LEGACY IV	648
TRAFIC II (JL)	587	TOLEDO I (1L)	625	LEGACY IV (B13_)	648
TRAFIC II VAN (FL)	588	TOLEDO II (1M2)	625	LEGACY OUTBACK (BG)	648
TWINGO I (C06_)	589	TOLEDO III (5P2)	625	LEGACY V	648
TWINGO I (S06_)	589	TOLEDO IV (KG3)	626	LEGACY V (BM, BR)	649
TWINGO II (CN0_)	589	SKODA		OUTBACK (BE, BH)	649
TWIZY (MAM_)	589	CITIGO	626	OUTBACK (BL, BP)	649
VEL SATIS (BJ0_)	589	FABIA	626	OUTBACK (BM, BR)	649
WIND (E4M_)	590	FABIA (6Y2)	627	TREZIA	649
ZOE	590	FABIA (6Y3)	628	TRIBECA (B9)	649
ROVER		FABIA (6Y5)	630	SUZUKI	
200 (RF)	590	FABIA (NJ3)	631	ALTO (HA25, HA35)	649
200 (XW)	590	FABIA (NJ5)	631	ALTO III (EF)	649
25 (RF)	591	FABIA COMBI	631	ALTO IV (FF)	649
400 (RT)	591	FABIA PRAKTIK	632	BALENO (EG)	649
400 (XW)	592	FAVORIT (781)	633	CAPPUCINO (EA)	650
400 TOURER (XW)	592	FAVORIT (787)	633	CARRY (FD)	650
45 (RT)	592	FAVORIT FORMAN (785)	633	GRAND VITARA I (FT, GT)	650
600 (RH)	593	FELICIA (6U1)	633	GRAND VITARA II (JT)	650
75 (RJ)	593	FELICIA (6U5)	634	IGNIS (FH)	651
75 TOURER (RJ)	593	FELICIA I FUN (797)	634	IGNIS II	651
CABRIOLET (XW)	593	FELICIA II (6U1)	634	JIMNY (FJ)	651
CITYROVER	594	FELICIA II (6U5)	634	LIANA (ER)	651
COUPE	594	OCTAVIA (1U2)	634	SAMURAI (SJ)	652
MINI		OCTAVIA (1U5)	635	SPLASH	652
MINI (XN)	594	OCTAVIA (1Z3)	636	SWIFT (SF413)	652
STREETWISE	594	OCTAVIA (1Z5)	636	SWIFT II (AH, AJ)	652
SAAB		OCTAVIA (5E3)	638	SWIFT II (EA, MA)	652
900	594	OCTAVIA COMBI (5E5)	638	SWIFT III (MZ, EZ)	652
900 (AC4, AM4)	594	RAPID (NH1)	639	SWIFT IV (FZ, NZ)	652
900 II	595	RAPID SPACEBACK (NH1)	639	SX4 (EY, GY)	653
9000	595	ROOMSTER (5J)	639	SX4 (GY)	653
42616	596	ROOMSTER PRAKTIK (5J)	640	VITARA (ET, TA)	653
9-3 (YS3D)	597	SUPERB (3T4)	640	VITARA CABRIO (ET, TA)	653
9-3 (YS3F)	598	SUPERB (3T5)	641	WAGON R	654
9-3 CABRIOLET (YS3D)	599	SUPERB (3U4)	641	WAGON R+ (EM)	654
9-3X	600	YETI (5L)	641	WAGON R+ (MM)	654
9-5 (YS3E)	600	SMART		X-90 (EL)	654
9-5 (YS3G)	602	CABRIO (450)	642	TOYOTA	
9-7X	602	CITY-COUPE (450)	642	4 RUNNER (KZN18_, VZN18_, RZN18_)	654
SEAT		CROSSBLADE (450)	642	4 RUNNER (RN10_, VZN13_, VZN10_, RN13_)	654
ALHAMBRA (710)	602	FORFOUR (454)	642	4 RUNNER (UZN21_, KZN21_, GRN21_)	654
ALHAMBRA (7V8, 7V9)	603	FORTWO (450)	643	ALLION I (ZZT24_, NZT24_, AZT24_)	654
ALTEA (5P1)	603	FORTWO (451)	643	ALLION II (NZT26_, ZRT26_)	654
ALTEA XL (5P5, 5P8)	604	FORTWO CABRIO (450)	643	ALPHARD (ATH1_, MNH1_, ANH1_)	654

MAKE-MODEL	PAGE	MAKE-MODEL	PAGE	MAKE-MODEL	PAGE
TOYOTA		TOYOTA		TOYOTA	
ALPHARD / VELLFIRE (GGH2_, ANH2_, ATH2_) 654		HIACE IV (LXH1_, RZH1_, LH1_) 672		WISH MPV (ZNE1_, ANE1_) 680	
ALTEZZA (SXE1_, JCE1_, GXE1_) 655		HIACE IV (TRH2_, KDH2_) 672		YARIS (NHP13_, NSP13_, NCP13_, KSP13_, NLP13_) 680	
ALTEZZA GITA (SXE1_, GXE1_) 655		HIACE V (TRH2_, KDH2_) 673		YARIS (SCP9_, NSP9_, KSP9_, NCP9_, ZSP9_) 680	
ALTIS 655		HIGHLANDER 673		YARIS / VITZ (NLP13_, NSP13_, NCP13_, KSP13_) 680	
AURION (GSV4_, ACV4_) 655		HILUX II (RN6_, RN5_, LN6_, YN6_, YN5_, LN5_) 673		YARIS / VITZ (SCP1_, NLP1_, NCP1_) 680	
AURIS (NRE15_, ZZE15_, ADE15_, ZRE15_, NDE15_) 655		HILUX III (KUN_, TGN_, LAN_, GGN_) 673		YARIS / VITZ (SCP9_, NSP9_, KSP9_, NCP9_, ZSP9_) 681	
AURIS (NZE18_, ZRE18_) 655		HILUX III (KUN1_, TGN3_, TGN2_, TGN1_, KUN2_) 673		YARIS VERSO (_NLP2_, _NCP2_) 681	
AURIS TOURING SPORTS (ADE18_, ZWE18_, ZRE18_) 655		HILUX III (TGN1_, GGN2_, GGN1_, KUN2_, KUN1_) 673		ZELAS (AGT20) 681	
AVALON (GSX3_) 656		HILUX III PICKUP (TGN1_, GGN2_, GGN1_, KUN2_, KUN1_) 673		VAUXHALL	
AVALON (MCX1_) 656		IQ (KPJ1_, KGJ1_, NGJ1_, NUJ1_) 673		ADAM 681	
AVALON (MCX2_) 656		IQ (KPJ1_, NGJ1_, KGJ1_, NUJ1_) 673		AGILA I (A) 681	
AVENSIS (_T22_) 656		ISIS (ZNM1_, ANM1_, ZGM1_) 673		AGILA II (B) 682	
AVENSIS (T25) 656		KIJANG INNOVA (_TGN4_, _KUN4_) 674		ANTARA (J26, H26) 682	
AVENSIS (T25_) 657		KLUGER (_MCU2_, _ACU2_) 674		ASTRA GTC MK VI (J) 682	
AVENSIS (ZRT27, ADT27) 657		KLUGER (_MHU4_, _GSU4_, _ASU4_) 674		ASTRA GTC VI (J) 682	
AVENSIS LIFTBACK (_T22_) 658		LAND CRUISER (KDJ12_, GRJ12_) 674		ASTRA II 683	
AVENSIS STATION WAGON (_T22_) 658		LAND CRUISER (KDJ15_, GRJ15_) 674		ASTRA II BELMONT 683	
AVENSIS VERSO (_CLM2_, _ACM2_) 658		LAND CRUISER (PZJ7_, KZJ7_, HZJ7_, BJ7_, LJ7_, RJ7_) 675		ASTRA III (F) 683	
AYGO (PAB4_, KGB4_) 658		LAND CRUISER 200 (VDJ2_, UZJ2_) 675		ASTRA IV (G) 689	
AYGO (WNB1_, KGB1_) 658		LAND CRUISER 80 (_J8_) 675		ASTRA IV (G) (F67) 693	
BREVIS (JCG1_) 658		LAND CRUISER 90 (_J9_) 675		ASTRA MK VI (J) 694	
CALDINA (ZZT24_, ST24_, AZT24_) 658		LAND CRUISER HARDTOP (_J7_) 675		ASTRA TWINTOP V (H) 694	
CAMRY (_CV1_, _XV1_, _V1_) 658		LAND CRUISER PRADO (KDJ15_, GRJ15_) 676		ASTRA V (H) 694	
CAMRY (_CV2_, _XV2_) 659		LAND CRUISER PRADO (LJ12_, KZJ12_, TRJ12_, KDJ12_, GRJ12_) 676		ASTRA V (H) SPORT HATCH 697	
CAMRY (_XV4_) 659		MATRIX 676		ASTRA VI (J) 698	
CAMRY (AVV5_, XV5_) 659		MATRIX (ZRE14_, AZE14_) 676		ASTRA VI (J) SPORTS TOURER 698	
CAMRY (MCV3_, ACV3_, _XV3_) 659		MATRIX (ZZE13_) 676		ASTRAMAX 699	
CAMRY SOLARA (MCV3_, ACV3_) 660		MR 2 III (ZZW3_) 676		ASTRAVAN III (F) 699	
CAMRY STATION WAGON (_V2_) 660		NOAH/VOXY (_AZR6_) 676		ASTRAVAN IV (G) 699	
CAMRY STATION WAGON (_XV1_, _CV1_, _V10) 660		OPA (ZCT1_, ACT1_) 676		ASTRAVAN V (H) 700	
CARINA E (_T19_) 660		PASEO (EL54) 676		CALIBRA 700	
CELICA (AT20_, ST20_) 662		PICNIC (_XM10) 676		CARLTON III 701	
CELICA (ST20_, AT20_) 662		PREMIO (NZZ26_, ZRT26_) 676		CASCADA 701	
CELICA (ZZT23_) 662		PREVIA (MCR3_, ACR3_, CLR3_) 676		CAVALIER III 701	
CELSIOR (UCF3_) 663		PREVIA III (AHR5_, GSR5_, ACR5_) 676		CAVALIER III (87) 702	
CHASER (_X9_) 663		PRIUS (NHW11_) 676		COMBO I (B) 703	
COROLLA 663		PRIUS (NHW20_) 676		COMBO II (C) (F25) 703	
COROLLA (_E10_) 663		PRIUS (ZVW3_) 677		COMBO III (D) 703	
COROLLA (_E11_) 663		PRIUS C (NHP10_) 677		COMBO TOUR II (C) (F25) 704	
COROLLA (_E12J_, _E12T_) 664		PRIUS PLUS (ZVW4_) 677		CORSA I (B) 704	
COROLLA (E15_) 664		PROGRES (JCG1_) 677		CORSA II (C) (W5L, F08) 705	
COROLLA (NRE18_, ZRE17_, ZRE18_, NDE18_) 665		RACTIS (SCP10_, NCP10_) 677		CORSA III (D) (L_8) 705	
COROLLA (ZZE12_, NDE12_, ZDE12_) 665		RAV 4 (SXA1_) 677		CORSA MK IV (E) 706	
COROLLA COMPACT (_E10_) 666		RAV 4 I (SXA1_) 677		CORSAVAN I (B) 707	
COROLLA COMPACT (_E11_) 666		RAV 4 II (CLA2_, XA2_, ZCA2_, ACA2_) 677		CORSAVAN II (C) 707	
COROLLA LEVIN (AE10_) 667		RAV 4 III (ACA3_, ACE_, ALA3_, GSA3_, ZSA3_) 677		CORSAVAN III (D) 707	
COROLLA LIFTBACK (_E10_) 667		RAV 4 IV (WWA4_, AVA4_, ZSA4_, ALA4_) 678		CORSAVAN MK IV (E) 707	
COROLLA LIFTBACK (_E11_) 667		RAV 4 IV (ZSA4_, ALA4_) 678		INSIGNIA 708	
COROLLA VERSO (ZDE12_, CDE12_) 668		ROYAL (JZS17_) 678		INSIGNIA SPORTS TOURER 709	
COROLLA VERSO (ZER_, ZZE_, R1_) 668		RUSH (F700_) 678		MERIVA I (A) 710	
COROLLA WAGON (_E11_) 669		SEQUOIA 678		MERIVA II (B) 710	
COROLLA WAGON (_E10_) 670		SEQUOIA (UCK6_, UPK6_, USK6_) 678		MERIVA MK II (B) 710	
CROWN (CRS_, JZS_, GRS18_, UZS_) 670		SIENNA 678		MOKKA 710	
CROWN Saloon (CRS_, JZS_, GRS18_, UZS_) 670		SIENNA (MCL2_, GSL2_) 678		MOVANO I (A) (JD) 711	
CYNOS (EL44_) 670		SIERRA 678		MOVANO I (A) CHASSIS/CAB (ED, UD, HD) 711	
CYNOS (EL54) 670		STARLET (EP91) 678		MOVANO I (A) VAN (FD) 712	
ECHO 670		TACOMA 678		MOVANO II (B) CHASSIS/CAB 712	
ECHO (NCP13_, NCP12_) 670		URBAN CRUISER (NSP1_, NLP1_, ZSP1_, NCP11_) 679		MOVANO II (B) COMBI 713	
ECHO (NCP13_, NCP12_) 670		VENZA (GGV1_, AGV1_) 679		MOVANO II (B) VAN 713	
FJ CRUISER (GSJ1_) 671		VEROSSA (JZX11_, GX11_) 679		MOVANO MK II (B) VAN 713	
FORTUNER (TGN6_, KUN6_, GGN6_, TGN5_) 671		VERSO (_AUR2_, _ZGR2_) 679		NOVA 713	
FORTUNER (TGN6_, KUN6_, GGN6_, TGN5_, LAN5_, KUN5_, GGN5_) 671		VERSO S (NLP12_, NCP12_, NSP12_) 679		NOVAVAN 714	
GAIA (CXM1_, SXM1_, ACM1_) 671		VIOS (SCP4_, NCP4_, AXP4_) 679		OMEGA (B) 714	
HARRIER (MCU3_, MHU3_, ACU3_, GSU3_) 671		VIOS/YARIS (ZSP9_, NCP9_) 679		SENATOR II (B) 716	
HARRIER (SXU1_, MCU1_, ACU1_) 671		VISTA (SV5_, ZV5_) 679		SIGNUM 716	
HIACE / COMMUTER IV (TRH2_, KDH2_) 671		WILL VS (ZZE12_, NZE12_) 679		SINTRA 717	
HIACE / COMMUTER V (TRH2_, KDH2_) 671		WINDOM (MCV3_) 679		TIGRA I (F07) 717	
HIACE III (YH7_, LH6_, LH7_, LH5_, YH5_, YH6_) 671		WINDOM (VCV1_) 679		TIGRA TWINTOP 717	
HIACE III WAGON (LH1_, RZH1_) 671		WISH (ZGE2_) 679		VECTRA (B) 717	
HIACE IV (LH1_) 671		WISH (ZNE1_, ANE1_) 680		VECTRA II (C) 720	
HIACE IV (LXH1_, RCH1_, KLH1_) 672		WISH MPV (ZGE2_) 680		VECTRA II (C) GTS 721	

MAKE-MODEL	PAGE	MAKE-MODEL	PAGE	MAKE-MODEL	PAGE
VAUXHALL		VOLKSWAGEN		VOLVO	
VIVARO (E7)	721	PASSAT VARIANT (3C5)	761	V90	795
VIVARO (F7)	722	PASSAT VARIANT (3G5)	762	XC60	795
VIVARO (J7)	722	PHAETON (3D_)	762	XC70 CROSS COUNTRY	795
ZAFIRA I (A) (F75)	723	POLO	762	XC70 II	795
ZAFIRA II (B) (M75)	724	POLO (6KV2)	763	XC90	796
ZAFIRA III (P12)	724	POLO (6N1)	763		
ZAFIRA MK III (P12)	724	POLO (6N2)	765		
VOLKSWAGEN		POLO (6NF)	766		
BEETLE	724	POLO (6R, 6C)	766		
BEETLE (5C1)	725	POLO (86C, 80)	767		
BEETLE (5C7)	725	POLO (86CF)	767		
BORA (1J2)	726	POLO (9A4)	767		
BORA (1J6)	727	POLO (9N_)	767		
CADDY II (9K9A)	728	POLO CLASSIC (6KV2)	769		
CADDY II (9K9B)	729	POLO VARIANT (6KV5)	769		
CADDY II (9U7)	729	ROUTAN	770		
CADDY III (2KA, 2KH, 2CA, 2CH)	729	SANTANA	770		
CADDY III (2KB, 2KJ, 2CB, 2CJ)	730	SCIROCCO (137)	770		
CC (358)	730	SCIROCCO (137, 138)	770		
CORRADO (531)	731	SHARAN (7M8, 7M9, 7M6)	770		
CRAFTER 30-35 (2E_)	731	SHARAN (7N)	771		
CRAFTER 30-50 (2E_)	732	TARO	771		
CRAFTER 30-50 (2F_)	732	TIGUAN (5N_)	771		
EOS (1F7, 1F8)	732	TOUAREG (7LA, 7L6, 7L7)	772		
FOX (5Z1, 5Z3)	733	TOUAREG (7P5)	772		
GOLF ALLTRACK (BA5)	733	TOURAN (1T1, 1T2)	772		
GOLF II (19E, 1G1)	733	TOURAN (1T3)	773		
GOLF III (1E7)	733	TOURAN (5T1)	773		
GOLF III (1H1)	734	TRANSPORTER / CARAVELLE V (7HB, 7HJ, 7EB, 7EJ, 7EF)	773		
GOLF III CABRIOLET (1E7)	736	TRANSPORTER V (7HA, 7HH, 7EA, 7EH)	774		
GOLF III VARIANT (1H5)	737	TRANSPORTER V (7JD, 7JE, 7JL, 7JY, 7JZ)	774		
GOLF IV (1J1)	739	TRANSPORTER VI (SFD, SFE, SFL, SFZ)	774		
GOLF IV (1J5)	740	TRANSPORTER VI (SGA, SGH)	774		
GOLF IV VARIANT (1J5)	741	TRANSPORTER VI (SGB, SGG, SGJ)	775		
GOLF PLUS (5M1, 521)	741	UP	775		
GOLF V (1K1)	743	VENTO (1H2)	775		
GOLF V VARIANT (1K5)	744	VOLVO			
GOLF VI (517)	744	440 K (445)	777		
GOLF VI (5K1)	745	460 L (464)	777		
GOLF VI CONVERTIBLE (517)	746	480 E	778		
GOLF VI VARIANT (AJ5)	746	740 (744)	778		
GOLF VII (5G1)	746	740 KOMBI (745)	778		
GOLF VII (5G1, BE1)	747	850 (LS)	778		
GOLF VII (BA5)	747	850 (LW)	778		
GOLF VII KOMBI (BA5)	747	940 (944)	779		
JETTA II (19E, 1G2, 165)	748	940 II (944)	780		
JETTA III (1K2)	748	940 II (945)	781		
JETTA IV (162)	748	940 KOMBI (945)	781		
JETTA IV (162, 163)	749	960 (964)	781		
LT 28-50 (281-363)	749	960 II (964)	782		
LT II (2DA, 2DD, 2DH)	749	960 II (965)	782		
LT II (2DB, 2DE, 2DK)	750	960 KOMBI (965)	782		
LT II (2DC, 2DF, 2DG, 2DL, 2DM)	750	C30	782		
LUPO (6X1, 6E1)	751	C70 I	783		
MULTIVAN V (7HM, 7HN, 7HF, 7EF, 7EM, 7EN)	751	C70 II	783		
MULTIVAN VI (SGF, SGM, SGN)	752	S40 I (VS)	783		
NEW BEETLE (1Y7)	752	S40 II (MS)	784		
NEW BEETLE (9C1, 1C1)	752	S60	785		
PASSAT (362)	753	S60 I	785		
PASSAT (3A2, 351)	753	S60 II	785		
PASSAT (3B2)	755	S70 (LS)	786		
PASSAT (3B3)	756	S80 I (TS, XY)	788		
PASSAT (3B5)	756	S80 II (AS)	789		
PASSAT (3C2)	756	S90	790		
PASSAT ALLTRACK (365)	757	V40 (VW)	790		
PASSAT ALLTRACK (3G5)	757	V50 (MW)	790		
PASSAT CC (357)	757	V60	791		
PASSAT VARIANT (365)	758	V70 (LV)	792		
PASSAT VARIANT (3A5, 351)	758	V70 I (LV)	793		
PASSAT VARIANT (3B5)	760	V70 II (SW)	793		
PASSAT VARIANT (3B6)	761	V70 III (BW)	794		

Explanation of G-AP Hub assembly number code

Example: GHA228028K

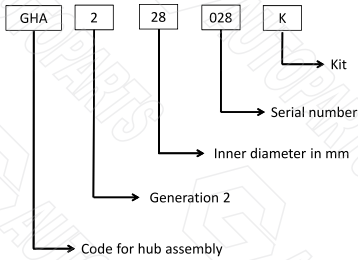

Explanation of G-AP Hub assembly number code

Example: GHA327039K

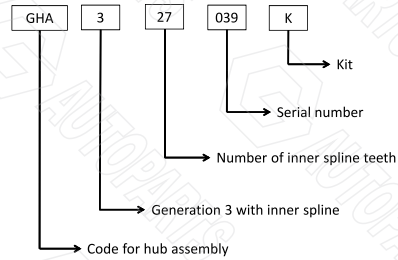

Explanation of G-AP Hub assembly number code

Example: GHA400053K

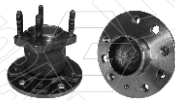
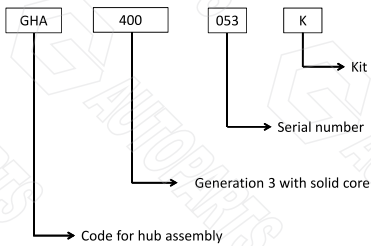

Explanation of G-AP Hub assembly number code

Example: GHA425017K

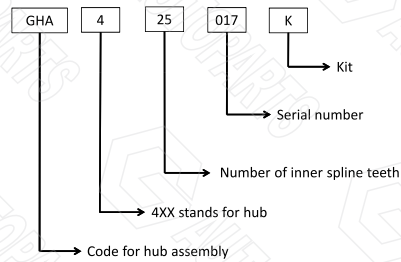

Explanation of G-AP Hub assembly number code

Example: GHA499032K

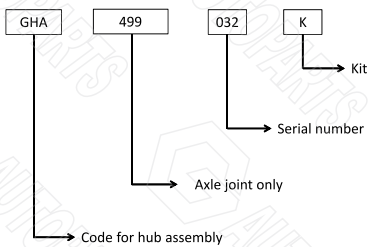

Hub Assemblies

Basic Dimension Table-G-AP to Dimension.....

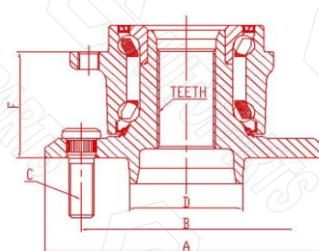
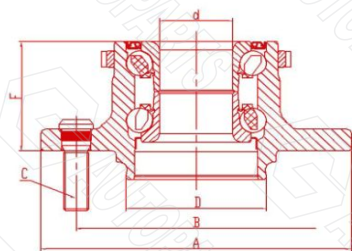

ID	G-AP Ref.	BASIC DIMENSIONS(mm)					TEETH / d	ABS
		A	B	C	D	F		
1	GHA223001	134	100	M12x1.5(4S)	56.1	49.4	23	√
2	GHA225003K	133	108	M14X1.5(5)	60	54	25	√
3	GHA225006K	133	100	M12X1.5(4)	60	54	25	√
4	GHA225006F	133	100	M12X1.5(4)	60	54	25	√
5	GHA225008	133.8	100	M12X1.5(4S)	56	49.5	25	
6	GHA225009A	128	108	M12X1.25(4)	65	42	25	√
7	GHA225010K	129	108	M12X1.25(4)	65	42	25	√
8	GHA225011K	129	108	M12X1.25(4)	65	42	25	√
9	GHA225012K	129	108	M12X1.25(4)	65	42	25	√
10	GHA225013K	129	108	M12X1.25(4)	65	42	25	√
11	GHA225014K	129	108	M12X1.25(4)	65	42	25	
12	GHA225015K	133	100	M12X1.5(4)	60	54	25	√
13	GHA225016	129	108	M12X1.25(4)	65	42	25	
14	GHA225018K	274	100	M12X1.5(2)	60	68.3	25	√
15	GHA225019K	240	100	M12X1.5(4)	60	67.5	25	√
16	GHA225020K	133	100	M12X1.5(4)	60	54	25	
17	GHA225021K	125.6	100	M12X1.5(4S)	56.5	56	25	√
18	GHA225022K	133	100	M12X1.5(4)	60	54.2	25	√
19	GHA225025K	125.6	100	M12X1.5(4S)	56.5	56	25	
20	GHA225026K	133	100	M12x1.5(4)	60	54	25	√
21	GHA225027K	133	100	M12x1.5(4)	60	54	25	√
22	GHA225028K	133	100	M12x1.5(4)	60	54.2	25	√
23	GHA225029K	120	100	M12x1.5(4)	57	41	25	√
24	GHA225030K	133	100	M12x1.5(4)	60	54	25	√
25	GHA225031K	128	108	M12x1.25(4)	65	42	25	
26	GHA225032K	128	108	M12x1.25(4)	65	42	25	
27	GHA225034K	133	108	M14x1.5(5)	60	54	25	√
28	GHA225035K	133	108	M14x1.5(5)	60	54	25	√
29	GHA225036K	133	108	M14x1.5(5)	60	54.2	25	√
30	GHA225037K	128	108	M12x1.25(4)	65	42.2	25	√
31	GHA225038K	260	114.3	M12x1.5(5)		61	25	√
32	GHA225039K	237.8	100	M12x1.5(4)		55	25	√
33	GHA225040K	237.8	100	M12x1.5(4)		55	25	√
34	GHA225041K	270	100	M12x1.5(4)		60	25	√
35	GHA225042K	248.6	108	M12x1.25(4)		51	25	√
36	GHA227001K	134	100	M12X1.25(4S)	59	52.5	27	
37	GHA227002	148	114.3	M12X1.25(4S)	66	52.5	27	√
38	GHA227003K	148	114.3	M12X1.25(4S)	66	57.5	27	
39	GHA227004K	148	114.3	M12X1.25(4S)	66	52.5	27	√
40	GHA227006	134	100	M12X1.25(4S)	59	52.5	27	√
41	GHA227007	134	100	Φ14(4)	59	52.5	27	
42	GHA227010	134	100	M12X1.25(4S)	59	52.5	27	√
43	GHA227011	148	114.3	M12x1.25(4S)	66	52.5	27	√
44	GHA227014	148	114.3	M12X1.25(4S)	66	52.5	27	
45	GHA227015	148	114.3	Φ14(4)	66	52.5	27	√

Hub Assemblies

Basic Dimension Table-G-AP to Dimension.....

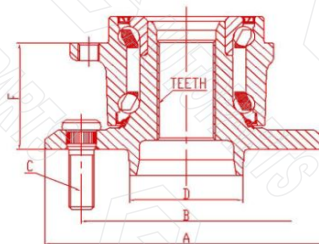
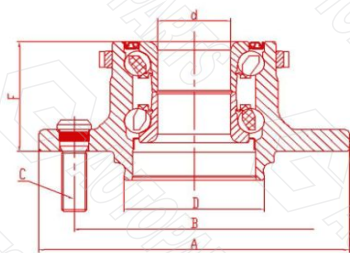

ID	G-AP Ref.	BASIC DIMENSIONS(mm)					TEETH / d	ABS
		A	B	C	D	F		
46	GHA227017K	134	100	M12X1.25(4S)	59	45	27	√
47	GHA227018K	134	100	M12X1.25(4S)	59	45	27	√
48	GHA227019	148	114.3	Φ14(4)	66	52.5	27	
49	GHA227022F	134	100	M12X1.25(4S)	59	45	27	
50	GHA227023K	123	100	M12X1.5(4)	56.5	53.2	27	
51	GHA227026K	148	114.3	M12x1.25(4S)	66	57.5	27	√
52	GHA228006K		97	Φ10.5(4)		52	28	
53	GHA228009	141	100	M12X1.5(4S)	56	57	28	
54	GHA228011	135.2	100	M12X1.5(5S)	57	59	28	
55	GHA228013	135	100	M12X1.5(5S)	56.9	57.5	28	
56	GHA228014	139	114.3	M12X1.5(4S)	67	50.5	28	
57	GHA228015	133.8	100	M12X1.5(4S)	56	49.5	28	
58	GHA228016	135.3	100	M12X1.5(5S)	56.9	49.4	28	√
59	GHA228017K	139	114.3	M12X1.5(4S)	67	50.5	28	
60	GHA228018K	139	114.3	M12X1.5(4S)	67	50.5	28	
61	GHA228019K	134	100	M12X1.5(4S)	56.1	54.5	28	√
62	GHA228020K	125.5	100	M12X1.5(4S)	56	56.5	28	
63	GHA228022K	140	100	M12X1.5(4S)	54	50.5	28	
64	GHA228026K	129.8	100	M12X1.25(4S)	54	49.5	28	√
65	GHA228027K	129.8	100	M12X1.25(4S)	54	49.5	28	
66	GHA228028K	139	114.3	M12X1.5(4S)	67	50.5	28	√
67	GHA228029K	134	100	M12X1.5(4S)	56.1	54.5	28	√
68	GHA228030K	133.8	100	M12X1.5(4S)	56	49.5	28	
69	GHA228031K	139	114.3	M12X1.5(4S)	67	50.5	28	√
70	GHA228032K	133.8	100	M12X1.5(4S)	56	49.5	28	√
71	GHA228033K	133.8	114.3	M12X1.25(4S)	60	49.5	28	
72	GHA228034K	140	100	M12X1.5(4S)	54	50.5	28	√
73	GHA228035K	139	114.3	M12X1.5(4S)	67	50.5	28	√
74	GHA228036K	120	100	M14X1.5(5)	57	41.5	28	√
75	GHA228037	120	100	M14X1.5(5)	57	41.5	28	
76	GHA228038K	134	100	M12X1.5(4S)	56.1	54.5	28	
77	GHA228041K	120	100	M12X1.5(4)	57	41.5	28	√
78	GHA228046K	122	100	M12X1.5(4S)	54	54	28	
79	GHA228048	135	100	M12X1.5(5S)	56.9	57.5	28	√
80	GHA228049K	140	100	M12X1.5(4S)	54	50.5	28	
81	GHA228050	136	100	M12X1.5(4S)	56.1	54.5	28	
82	GHA228051K	120	100	M12X1.25(4S)		49.5	28	
83	GHA228052	120	100	M12X1.5(4)	57	41.5	28	
84	GHA228055	125.5	100	M12X1.5(4S)	56	56.5	28	
85	GHA228056K	122	100	M12X1.5(4S)	54	54	28	√
86	GHA228057K	120	100	M12X1.25(4S)	60	49.5	28	√
87	GHA228058K	133.7	112	M12X1.5(3)	57	34.5	28	√
88	GHA228061K	121	100	M12X1.5(4)	57	41.5	28	√
89	GHA228066K	125.5	100	M12X1.5(4S)	56	56.5	28	
90	GHA228067K	140	100	M12x1.5(4S)	54	50.5	28	√

Hub Assemblies

Basic Dimension Table-G-AP to Dimension.....

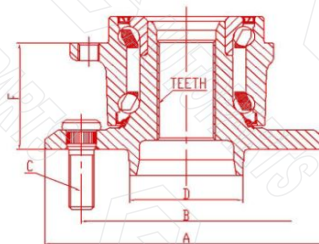
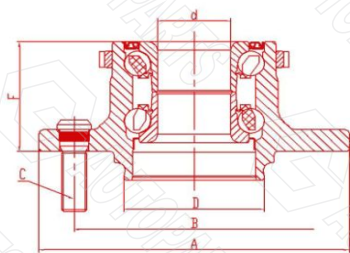

ID	G-AP Ref.	BASIC DIMENSIONS(mm)					TEETH / d	ABS
		A	B	C	D	F		
91	GHA228068K	139	114.3	M12x1.5(4S)	67	50.5	28	√
92	GHA228071	135.2	100	M12x1.5(5S)	56.7		28	√
93	GHA228072	122	100	M12x1.5(4S)	54	54	28	√
94	GHA228073	135.3	100	M12x1.5(5S)	56.8	52.5	28	√
95	GHA228074K	144	114.3	M12x1.25(5S)	60	59.6	28	√
96	GHA229001	136	108	M12X1.5(4S)	63.2	64.7	29	
97	GHA230002F	117	98	M12X1.25(4)	58	44.3	30	
98	GHA230002S	117	98	M12X1.25(4)	58	44.3	30	
99	GHA230003K	152	114.3	M12X1.5(4S)	64	56	30	
100	GHA230004	148	114.3	M12X1.25(5S)	66	49	30	√
101	GHA230005K	130.5	108	M14X1.5(4)	65	52.5	30	√
102	GHA230007	120	100	M12X1.5(4)	57	41	30	
103	GHA230008K		90	M10X1.25(4)	66	44	30	
104	GHA230014K	135.8	100	M12X1.5(4S)	56	55	30	
105	GHA230015K	136	100	M12X1.5(4S)	56.1	54.5	30	√
106	GHA230017K	152	114.3	M12X1.5(4S)	64	56	30	√
107	GHA230020K	152	114.3	M12X1.5(5S)	64	55.8	30	√
108	GHA230022	139.2	114.3	M12X1.5(5S)	64	56	30	√
109	GHA230023K	152	114.3	M12X1.5(4S)	64	55.8	30	√
110	GHA230024K	152	114.3	M12X1.5(5S)	63	56	30	√
111	GHA230026K		99	Φ10.5(4)		52	30	
112	GHA230028K	117	98	M12X1.25(4)	58	44.5	30	√
113	GHA230029K	152	114.3	M12X1.5(4S)	64	56	30	√
114	GHA230030K	152	114.3	M12X1.5(4S)	64	56	30	√
115	GHA230032K	122	100	M12X1.5(4S)	54	56	30	
116	GHA230034K	148	114.3	M12X1.25(4S)	66	49	30	
117	GHA230035K	122	100	M12X1.5(4S)	56	56	30	
118	GHA230036	122	100	M12X1.5(4S)	54	56	30	
119	GHA230037K	122	100	M12X1.5(4S)	54	56	30	√
120	GHA230038K		99	Φ10.5(4)		52	30	
121	GHA230039K	148	114.3	M12X1.25(4S)	66	57.5	30	√
122	GHA230040K	140.2	114.3	M12X1.5(4S)	67	56.5	30	
123	GHA230044K	116.5	98	M12X1.25(4)	58	43	30	
124	GHA230046K	116.5	98	M12X1.25(4)	58	43	30	√
125	GHA230047K	117.5	98	M12X1.25(4)	58	44	30	√
126	GHA230049K	139	100	M12X1.5(4S)	56	56	30	√
127	GHA230050K	122	100	M12X1.5(4S)	54	56	30	√
128	GHA230051K	120	100	M14X1.5(5)	57	42.5	30	√
129	GHA230052K	148	114.3	M12X1.25(5S)	66	49	30	√
130	GHA230053	140	114.3	M12X1.5(4S)	67	56.5	30	
131	GHA230057K	120	100	M12X1.5(4)	57	41	30	√
132	GHA230058K	148	114.3	M12X1.25(5S)	66	49	30	√
133	GHA230061K	120	100	M12X1.25(4)	52	45.5	30	
134	GHA230062	148	114.3	M12X1.25(5S)	66	49	30	
135	GHA230065K	139	100	M12X1.5(4S)	56	56	30	√

Hub Assemblies

Basic Dimension Table-G-AP to Dimension.....

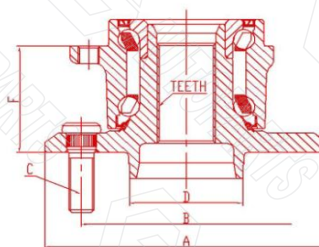
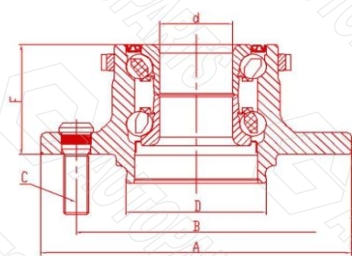

ID	G-AP Ref.	BASIC DIMENSIONS(mm)					TEETH / d	ABS
		A	B	C	D	F		
136	GHA230066K	122	100	M12X1.5(4S)	56	56	30	√
137	GHA230067K	152	114.3	M12X1.5(5S)	64	56	30	√
138	GHA230068K	139	100	M12X1.5(4S)	56	56	30	√
139	GHA230069	139	100	M12X1.5(4S)	56	56	30	√
140	GHA230070	148	114.3	M12X1.25(4S)	66	57.5	30	
141	GHA230071K	140.3	114.3	M12X1.5(4S)	67	56.5	30	
142	GHA230072	152	114.5	M12X1.5(4S)	64	56	30	
143	GHA230075A	132.7	108	M14X1.5(5)	60	54.2	30	√
144	GHA230078K	139	100	M12X1.5(4S)	56	56	30	
145	GHA230080K	148	114.3	M12X1.25(4S)	66	57.5	30	√
146	GHA230081K	140	114.3	M12X1.5(4S)	67	56.5	30	√
147	GHA230082K	136.5	112	M14X1.5(5)	57	47.2	30	√
148	GHA230084K	140.2	114.3	M12X1.5(4S)	67	56.5	30	√
149	GHA230086K	117.5	98	M12X1.25(5)	58	44	30	√
150	GHA230087K	137.5	114.3	M12X1.5 (5S)	67	56.5	30	√
151	GHA230090K	117	98	M12X1.25(4)	57.9	43.5	30	√
152	GHA230091K	139.2	114.3	M12X1.5 (5S)	64	56	30	√
153	GHA230092K	120	100	M12X1.5(4)	56.5	43	30	√
154	GHA230092S	120	100	M12X1.5(4)	56.5	43	30	√
155	GHA230093K	152	114.3	M12X1.5(5S)	64	70.7	30	√
156	GHA230094K	148	114.3	Φ14(4)	66	57.5	30	
157	GHA230095	138.8	114.3	M12X1.5 (4S)	64	59.5	30	√
158	GHA230097K	117.5	98	M12X1.25(4)	58	43	30	√
159	GHA230098K	130	110	M12X1.5(5)	65	43	30	√
160	GHA230100	137.5	114.3	M12X1.5(4S)	67	56.5	30	√
161	GHA230104K	116.6	98	M12X1.25(5)	58	43.2	30	√
162	GHA230107	117	98	M12X1.25(4)	58	43.8	30	
163	GHA230108K	140.2	114.3	M12X1.5(5S)	67	56.5	30	√
164	GHA230109K	135.8	108	M12X1.75(5)	65	52	30	√
165	GHA230110K	120	100	M12x1.25(4)	52	45.5	30	√
166	GHA230111K	120	98	M14x1.5(5)	58	53.8	30	√
167	GHA230112K	152	114.3	M12x1.5(4S)	64	71	30	√
168	GHA230113K	132.7	108	M14x1.5(5)	60	54.2	30	
169	GHA230114	125.5	100	M12x1.25(5S)	56	64.5	30	
170	GHA230115K	130	110	M12x1.25(5)	65	43	30	√
171	GHA230116K	132.7	108	M14x1.5(5)	60	54.2	30	√
172	GHA230117K	135.8	100	M12x1.5(4S)	56.1	55	30	
173	GHA230118K	116.5	98	M12x1.25(5)	58	43	30	√
174	GHA230119K	139	114.3	M12x1.5(4S)	56.5	62	30	√
175	GHA230120K	116.5	98	M12x1.25(5)	58	43	30	√
176	GHA230121K	120	98	M14x1.5(5)	58	53.8	30	√
177	GHA230122K	140	114.3	M12x1.5(5S)	67	56	30	
178	GHA230123K	136	100	M12x1.5(4S)	56.5	62	30	√
179	GHA230124	142	114.3	M12x1.5(5S)	56.5	62	30	√
180	GHA230125K	140	114.3	M12x1.5(5S)	67	56	30	√

Hub Assemblies

Basic Dimension Table-G-AP to Dimension.....

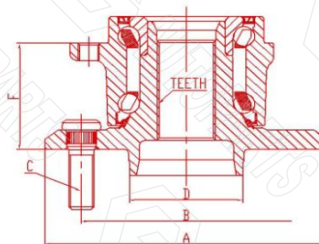
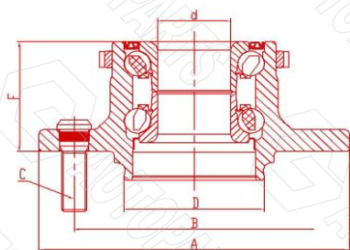

ID	G-AP Ref.	BASIC DIMENSIONS(mm)					TEETH / d	ABS
		A	B	C	D	F		
181	GHA230127	120	98	M12x1.25(5)	58	53.8	30	
182	GHA230128	120	98	M12x1.25(5)	58	53.8	30	√
183	GHA230131	139	114.3	M12x1.5(5S)	56.5	62	30	√
184	GHA230134K	139.3	114.3	M12x1.5(5S)		56	30	√
185	GHA230135	152	114.3	M12x1.5(5S)		56.2	30	√
186	GHA230137K	260	114.3	M12x1.5(5)		61	30	√
187	GHA230138K	274	114.3	M12x1.5(5)		61	30	√
188	GHA230140K	274	100	M12x1.5(4)		60	30	√
189	GHA230141K	274	108	M12x1.5(5)		60	30	√
190	GHA230142K	300	108	M14x1.5(5)		60	30	√
191	GHA230143K	300	114.3	M14x1.5(5)		57	30	√
192	GHA230144K	274	108	M12x1.5(5)		60	30	√
193	GHA230145K	248.7	108	M12x1.25(4)		53	30	√
194	GHA230146K	249	108	M12x1.25(4)		57	30	√
195	GHA230148K	267.7	108	M12x1.25(4)		57	30	√
196	GHA230151K	136	100	M12x1.5(4S)	56	55	30	√
197	GHA230152	148	114.3	M12x1.25(4S)	66	49	30	√
198	GHA231001K	120	100	M12X1.5(4)	57	42	31	√
199	GHA232001K	128	108	M12X1.25(5)	65	42	32	√
200	GHA232002K	139	114.3	M12X1.5(4S)	67	50.5	32	√
201	GHA232004K	128	108	M12X1.25(4)	65	42.2	32	
202	GHA232005	140	114.3	M12X1.5(5S)	71.4	41.4	32	√
203	GHA232007F	129	108	M12X1.25(4)	65	42	32	√
204	GHA232008K	139	114.3	M12X1.5(4S)	67	50.5	32	√
205	GHA232011K	129	108	M12X1.25(4)	65	42	32	
206	GHA232012K	128	108	M12X1.25(4)	65	42	32	√
207	GHA232013K	128	108	M12X1.25(4)	65	42	32	√
208	GHA232014K	130.8	112	M14X1.5(5)	57	48.5	32	√
209	GHA232015K	139	114.3	M12X1.5(4S)	67	50.5	32	
210	GHA232018K	136.5	112	M14X1.5(5)	57	48.6	32	√
211	GHA232021K	128	108	M12X1.25(4)	65	42	32	√
212	GHA232022K	128	108	M12X1.25(4)	65	42.2	32	√
213	GHA232023	139	100	M14X1.5(5)	56	59.8	32	
214	GHA232024K	139	114.3	M12X1.5 (5S)	67	50.5	32	√
215	GHA232025	139	114.3	M12x1.5(4S)	67	50.5	32	
216	GHA232026K	142	112	M14X1.5(5)	66.5	48.5	32	√
217	GHA232028K	128	108	M12X1.25(4)	65	42	32	√
218	GHA232029K	128	108	M12X1.25(5)	65	42	32	√
219	GHA232030K	129.3	108	M12X1.25(4)	65	42	32	√
220	GHA232031K	128	108	M12X1.25(5)	65	51	32	√
221	GHA232032K	128	108	M12x1.25(4)	65	42	32	
222	GHA232033K	129	108	M12x1.25(4)	65	42	32	√
223	GHA232034K	128	108	M12x1.25(5)	65	42	32	√
224	GHA232035K	128	108	M12x1.25(4)	65	42	32	√
225	GHA232036K	142	112	M14x1.5(5)	66.5	48.5	32	√

Hub Assemblies

Basic Dimension Table-G-AP to Dimension.....

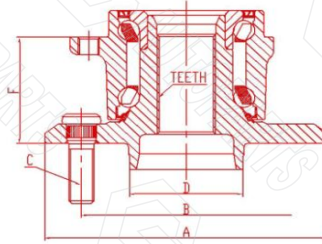
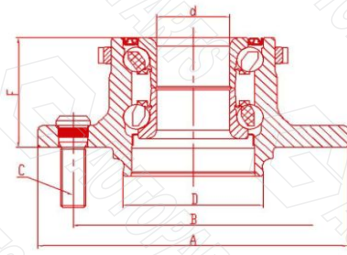

ID	G-AP Ref.	BASIC DIMENSIONS(mm)					TEETH / d	ABS
		A	B	C	D	F		
226	GHA232037K	139	114.3	M12x1.5(5S)	67	50.5	32	√
227	GHA232038K	129	108	M12x1.25(5)	65	57	32	√
228	GHA232039K	128	108	M12x1.25(5)	65	42	32	√
229	GHA232040K	139	114.3	M12x1.5(5S)	67	50.5	32	
230	GHA232042	139	114.3	M12x1.5(5S)	67	50.5	32	
231	GHA232043	139	114.3	M12x1.5(4S)	67	50.5	32	
232	GHA232044	139	114.3	M12x1.5(4S)	67	50.5	32	
233	GHA232047	139.2	114.3	M12x1.5(4S)	67	50.7	32	√
234	GHA233002F	139.8	114.3	M12X1.5(5S)	67	59	33	√
235	GHA233003	140	114.3	M12X1.5(5S)	67	57.2	33	
236	GHA233005K	139	114.3	M12X1.5(5S)	67	53.5	33	√
237	GHA233007K	140	114.3	M12X1.5(4S)	67	59	33	√
238	GHA233008	139	114.3	M12X1.5(5S)	67	53.5	33	
239	GHA233009K	139.8	114.3	M12X1.5(5S)	67	59	33	
240	GHA233010K	140	114.3	M12X1.5(4S)	67	57.2	33	
241	GHA233011	140.5	114.3	M12X1.5(4S)	67	57.2	33	
242	GHA233012	140.5	114.3	M12x1.5(4S)	67	57.2	33	√
243	GHA233013	140.5	114.3	M12x1.5(5S)	67	57.2	33	√
244	GHA233014	140.5	114.3	M12x1.5(5S)	67	57.2	33	
245	GHA233016	140	114.3	M12x1.5(4S)	67	59	33	
246	GHA234001	151.8	114.3	M12X1.5(4S)	64	56	34	
247	GHA234002	151.8	114.3	M12X1.5(4S)	64	56	34	√
248	GHA234003K	139	114.3	M12X1.5(4S)	67	50.5	34	√
249	GHA234004K	146.5	114.3	M12X1.5(5S)	64	62	34	√
250	GHA234005K	146.5	114.3	M12X1.5(5S)	64	62	34	√
251	GHA234007	152	114.3	M12x1.5(5S)		62	34	√
252	GHA234008K	139	114.3	M12x1.5(4S)	67	50.5	34	
253	GHA234010	139.8	114.3	M12x1.25(5S)	66	58.9	34	√
254	GHA234011	148	114.3	M12x1.25(5S)	66	58.8	34	√
255	GHA234502	139	114.3	1/2-20(5S)	70.5	47.6	34.5	√
256	GHA235001K	137	110	M12X1.5(5)	65	49	35	√
257	GHA235005K	136	108	M12X1.5(4S)	63.2	51.5	35	√
258	GHA235008K	137	108	M12X1.5(5S)	65	49	35	
259	GHA235009K	136	108	M12X1.5(4S)	63.2	52	35	
260	GHA235011K	136	108	M12X1.5(5S)	65	48.8	35	√
261	GHA235012K	148	114.3	M12X1.5(5S)	67	56.2	35	√
262	GHA235013	137	110	M12X1.5(5)	65	49	35	
263	GHA235014K	116	98	M12X1.25(4)	58	46	35	
264	GHA235015K	148	114.3	M12X1.5(5S)	67	56.2	35	
265	GHA235018K	116.2	98	M12X1.25(5)	58	46	35	√
266	GHA235019K	136	108	M12x1.5(5S)	65	49	35	√
267	GHA235020K	128	108	M12x1.25(5)	58	52	35	√
268	GHA235021K	128	108	M12x1.25(5)	58	52	35	√
269	GHA235022K	128	108	M12x1.25(5)	58	52	35	√
270	GHA235023K	148	114.3	M12x1.5(5S)	67	56.2	35	√

Hub Assemblies

Basic Dimension Table-G-AP to Dimension.....

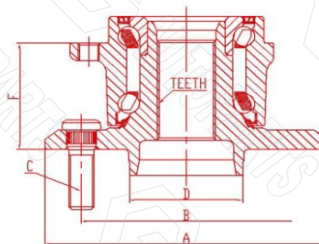
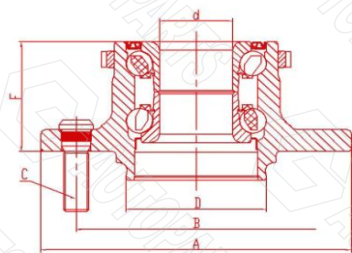

ID	G-AP Ref.	BASIC DIMENSIONS(mm)					TEETH / d	ABS
		A	B	C	D	F		
271	GHA235024K	150	112	M12x1.5(5)	66.4	58.4	35	√
272	GHA235025	279.8	118	M14x1.5(5)		80.5	35	√
273	GHA236001	140	114.3	M12X1.5(5S)	67	57	36	
274	GHA236002K	140	114.3	M12X1.5(5S)	67	61	36	√
275	GHA236003	140	114.3	M12X1.5(5S)	67	61	36	
276	GHA237001K	139	120	M12X1.5(5)	72.5	45	37	√
277	GHA237002K	139	120	M12X1.5(5)	72.5	45	37	√
278	GHA237003K	139	120	M12X1.5(5)	72.5	45	37	
279	GHA237004K	139	120	M12X1.5(5)	72.5	45	37	√
280	GHA237006	151	114.3	1/2-20(5S)	70.5	55	37	√
281	GHA237009K	151.5	114.3	1/2-20(5S)	70.5	52	37	√
282	GHA237010K	193	160	M14X2(5S)		78	37	
283	GHA237013	150	115	M14X1.5(5S)	71.5	55	37	√
284	GHA237015K	189	160	M14X2(5S)		66.5	37	
285	GHA237016K	136	108	M12X1.5(5S)	63.3	65	37	√
286	GHA237017K	189	160	M14X2.0(5S)		66.5	37	√
287	GHA237018K		108	Φ10.35 (4)	76	22	37	√
288	GHA237020	147.6	114.3	1/2-20(5S)	70.5	55	37	√
289	GHA237021		93	M10x1.25(4)	67.8	16.6	37	
290	GHA238001K		106	Φ10.5(4)	87.4	55	38	
291	GHA238002	140.5	114.3	M12x1.5(5S)	67	57.2	38	
292	GHA239001		120	M12X1.25(3)	75	49.3	39	
293	GHA239002		120	M12X1.25(3)	80.5	49.3	39	
294	GHA239003		120	M12X1.25(3)	80.5	49.3	39	
295	GHA239004		120	M12X1.25(3)	75	49.3	39	
296	GHA240001K		106	M12X1.25(4)	84	26.5	40	
297	GHA240008K		107	M12X1.25(4)	84	43	40	
298	GHA240009		103.4	M10x1.25(4)		39.5	40	
299	GHA241001	169.5	139.7	M12X1.25(5S)	105	37	41	
300	GHA241002	169.5	139.7	M12X1.25(5S)	105	37	41	√
301	GHA242007K	160.1	130	M16X1.5(5)	78	76	42	√
302	GHA242008K	143.2	118	M14X1.5(5)	71	76	42	√
303	GHA242009K		108	Φ10.4(4)	83.5	22	42	√
304	GHA242009S		108	Φ10.4(4)	83.5	22	42	√
305	GHA243001K		102	M10X1.25(4)	82.8	44	43	
306	GHA243003K		120	M12X1.25(3)	80.6	55.1	43	
307	GHA243004K		120	M12X1.25(3)	80.6	55.1	43	
308	GHA243005		110	M12X1.25(4)	84	45	43	
309	GHA243006K		107	M12X1.25(4)	83.8	34	43	
310	GHA243008		120	M10x1.25(3)		49	43	√
311	GHA243009		120	M10x1.25(3)		49	43	√
312	GHA243011		107	M12x1.25(4)	83	19	43	
313	GHA244001		125	Φ10(4)		58.3	44	
314	GHA244002		125	Φ10(4)		58.3	44	
315	GHA244003K		140	Φ12(2)Φ13(2)		58.25	44	√

Hub Assemblies

Basic Dimension Table-G-AP to Dimension.....

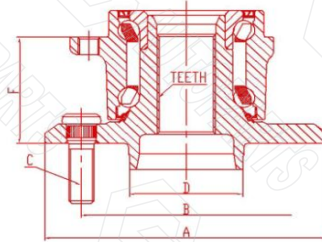
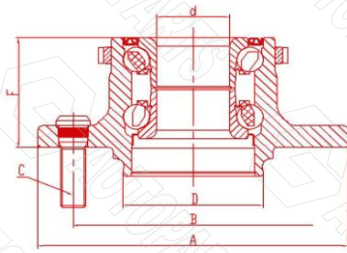

ID	G-AP Ref.	BASIC DIMENSIONS(mm)					TEETH / d	ABS
		A	B	C	D	F		
316	GHA244004K		140	Φ12(2)Φ13(2)		58.3	44	√
317	GHA244005		140	12 (2) 13 (2)		58.3	44	
318	GHA244006		140	12 (2) 13 (2)		58.3	44	
319	GHA245001K		106	M10X1(4)	90	37.2	45	
320	GHA245003		105	M10X1.25(4)	85.8	49	45	
321	GHA245007K		107	M12X1.5(4)	82	37	45(43)	√
322	GHA245007S		107	M12X1.5(4)	82	37	45(43)	√
323	GHA245008K		98	Φ10.85(5)	78	40	45	
324	GHA245009K		98	Φ10.8(5)	78	40	45	
325	GHA245010K		107	M12X1.5(4)	82	37	43(45)	
326	GHA245011	161.3	139.7	M12X1.5(6S)	92.2	60	45	
327	GHA245012K		106	M12X1.5(4)		37.2	45	√
328	GHA245013	161.3	139.7	M12x1.5(6S)	92.2	60	45	√
329	GHA245015K	193	160	M14X2.0(5S)		79	45	
330	GHA245016K	189	160	M14x2(5S)		67	45	√
331	GHA245017	120	100	M12x1.25(6)		85	45	
332	GHA245019	161.3	139.7	M12x1.5(6S)	92.2	60	45	
333	GHA245021		120.7	12.6(3)	86.5	29.6	45	√
334	GHA245022K		138	M12x1.75(4)	91	37.7	45	√
335	GHA247001K		114	M12X1.5(4)	89	22	45/47	√
336	GHA248001		140	12 (2) 12.9 (2)		50.7	48	
337	GHA249001K		108	Φ10.8(5)	87.5	40.5	49	
338	GHA249002K		110	M10X1.5(4)	91	38	49	
339	GHA249003		140	Φ12.1 (4)		58.3	49	√
340	GHA249004		140	Φ12.1 (4)		58.3	49	√
341	GHA249005K		110	M10x1.5(4)	91	30	49	
342	GHA249006K		110	M12x1.5(4)	92	41.2	49	√
343	GHA250001		112	M12x1.25(4)	86	23	50	
344	GHA250010	126.8	106.8	M12X1.25(4)	83.7	44	50	
345	GHA250011			M12x1.25(4)	87.7	23	50	
346	GHA251001		112	M12X1.25(4)	86.5	35.5	51	
347	GHA251002K		117	M12x1.25(4)	94	35	51	√
348	GHA251003		118	M12x1.5(4)		46.4	51	√
349	GHA251004		112	M12x1.25(4)	88.8	35.5	51	
350	GHA254001K		120	M12X1.25(4)	90	59	54	
351	GHA254002K		132	Φ12.7(4)	96	34.5	54	
352	GHA254003K		132	Φ12.7(4)	96	34.6	54	√
353	GHA254004K		119	M14x1.5(4)		46.9	54	
354	GHA254901		120	M12x1.25(4)	90		54	
355	GHA258001		145.5	Φ12.7(4)	105.8	40.6	58	
356	GHA258002		142	M12x1.25(4)	106.8	50.6	58	√
357	GHA262001K		126	M12X1.5(4)	101	40.5	61/62	√
358	GHA320001K	117	98	M12X1.25(4)	58	52	20	
359	GHA320002K	120.7	100	M14X1.5(5)	57	55.5	20	√
360	GHA320003K	117.8	100	M12x1.5(4)	57	53.2	20	√

Hub Assemblies

Basic Dimension Table-G-AP to Dimension.....

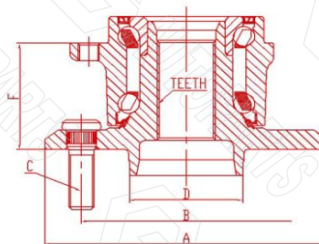
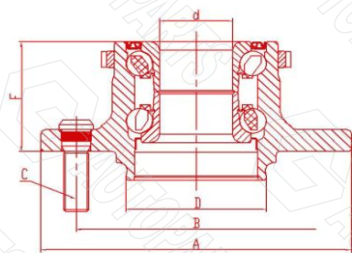

ID	G-AP Ref.	BASIC DIMENSIONS(mm)					TEETH / d	ABS
		A	B	C	D	F		
361	GHA323002	134	100	M12x1.25(4S)	59.9	50.8	23	√
362	GHA324002K	133.4	112	M12X1.5(3)	57	54	24	
363	GHA324003	140	114.3	M12X1.5(5)	60	60	24	√
364	GHA324004K	120.5	100	M12X1.25(4S)	54	60	24	√
365	GHA324005	154	120	M14x1.5(5S)		53.5	24	
366	GHA324006	154	120	M14x1.5(5S)		53.5	24	
367	GHA324007	154	120	M14x1.5(5S)		110	24	
368	GHA324008	154	120	M14x1.5(5S)		52.6	24	√
369	GHA324009	154	120	M14x1.5(5S)		52.6	24	√
370	GHA325001	142	114.3	M12X1.5(5S)	67	40.5	25	
371	GHA325003	124	100	M12X1.25(5S)	56	65.6	25	
372	GHA325005	143	114.3	M12X1.5(4S)	67	40.5	25	
373	GHA325016K	136	114.3	M12X1.25(4S)	66	40.7	25	√
374	GHA325018K	140.5	114.3	M12X1.5(5S)	67	60.5	25	√
375	GHA325019K	148	114.3	M12X1.25(5S)	66	69	25	
376	GHA325020	136	114.3	M12x1.25(4S)	66	40.7	25	
377	GHA325022K	137	114.3	M12X1.5(5S)	65.7	59	25	
378	GHA325024	122	100	M12X1.25(4S)	60	41	25	√
379	GHA325025K	124	100	M12X1.25(5S)	56	65.5	25	√
380	GHA325026K	137	114.3	M12X1.5(4S)	67	54.2	25	
381	GHA325029	140.5	114.3	M12x1.5(5S)	67	60.6	25	√
382	GHA325030	140.5	114.3	M12x1.5(5S)	67	60.7	25	√
383	GHA326001	130.5	108	M14X1.5(4)	65	37	26	
384	GHA326004K	135.5	108	M12X1.75(5)	65	43	26	
385	GHA326005K	135.5	108	M12X1.75(4)	65	43	26	
386	GHA326006	139	108	M12X1.5(5S)	63.3	41.4	26	
387	GHA326008	126	100	M12X1.5(5S)	56	37.5	26	
388	GHA326009	139	108	M12X1.5(5S)	63.3	36	26	
389	GHA326011K	130.5	108	M14X1.5(4)	65	37	26	
390	GHA326014K	139	114.3	M12X1.5(5S)	71.3	37.5	26	
391	GHA326016	139	114.3	M12X1.5(5S)	71.4	48	26	
392	GHA326017K	139	114.3	M12X1.5(5S)	71.3	37.5	26	
393	GHA326020K	126	100	M12X1.5(5S)	56.9	37.5	26	
394	GHA326024K	139	114.3	M12X1.5(5S)	60	47.5	26	√
395	GHA326026K	137.5	100	M12X1.5(4)	56	44	26	√
396	GHA326027K	152	114.3	M12X1.5(5S)	60	69	26	
397	GHA326028K	125	100	M12X1.5(5S)	54	42	26	
398	GHA326030K	152	114.3	M12X1.5(5S)	60	60	26	√
399	GHA326031K	137.5	100	M14X1.25(4)	56	44	26	√
400	GHA326032K	152	114.3	M12X1.5(5S)	60	65	26	√
401	GHA326034	167.5	127	M12x1.5(5S)	71.4	48.6	26	√
402	GHA326036	152	114.3	M12x1.5(5S)	60	72	26	
403	GHA326038K	136	108	M12x1.5(5S)	63.3	63	26	
404	GHA326039	125	100	M12x1.5(5S)	54	47	26	√
405	GHA326043	135	100	M12x1.5(4S)	54	54.5	26	

Hub Assemblies

Basic Dimension Table-G-AP to Dimension.....

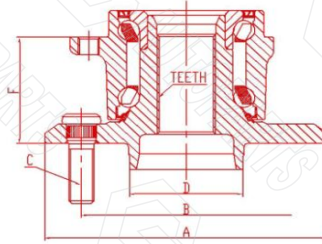
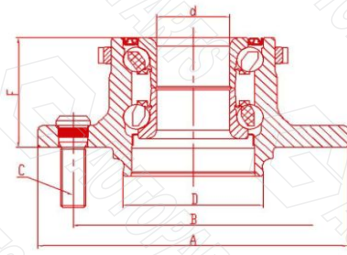

ID	G-AP Ref.	BASIC DIMENSIONS(mm)					TEETH / d	ABS
		A	B	C	D	F		
406	GHA326046	152	114.3	M12x1.5(5S)	60	69	26	
407	GHA326047	167.3	127	M12x1.5(5S)	71.4	48.5	26	√
408	GHA326052	152	114.3	M12x1.5(5S)	64	61.4	26	√
409	GHA326053	135	100	M12x1.5(5S)	54	54.5	26	
410	GHA326054K	135	100	M12x1.5(5S)	54	66	26	
411	GHA326057	134.9	100	M12x1.5(5S)	54	54.5	26	
412	GHA327010K	154	114.3	1/2-20(5S)	71.4	54.2	27	
413	GHA327011	150.5	114.3	1/2-20(5S)	70.5	56.3	27	√
414	GHA327013	153.5	114.3	1/2-20(5S)	71.4	48.5	27	
415	GHA327015K	164.75	127	1/2-20(5S)	71.4	53.8	27	
416	GHA327016	144	114.3	1/2-20(5S)	71.4	46	27	
417	GHA327017	149.5	114.3	1/2-20(5S)	70.6	56.2	27	√
418	GHA327021	144.5	120.7	M12X1.5(5S)	70.1	47.3	27	
419	GHA327022	144.5	120.7	M12X1.5(5S)	70.1	47.3	27	√
420	GHA327023K	147	115	M12X1.5(5S)	70.1	42	27	
421	GHA327027	150.3	127	M12X1.5(6S)	77.8	47	27	√
422	GHA327028	153.5	114.3	1/2-20(5S)	71.4	53.7	27	√
423	GHA327032	139	114.3	M12X1.5(5S)	67	38.3	27	
424	GHA327033	149.5	114.3	1/2-20(5S)	70.5	56.3	27	√
425	GHA327034	149.4	114.3	1/2-20(5S)	70.5	56	27	
426	GHA327035	136	114.3	M12X1.25(5S)	66	40.7	27	√
427	GHA327037	160	114.3	1/2-20(5S)	70.5	48.4	27	
428	GHA327038K	124	100	M12X1.25(5S)	56	66.5	27	√
429	GHA327039K	124	100	M12X1.25(5S)	56	49	27	√
430	GHA327040K	150	115	M14X1.5(5S)	71.4	60.3	27	
431	GHA327043K	153.5	114.3	1/2-20(5S)	71.4	53.7	27	√
432	GHA327044K	140.5	114.3	M12X1.5(5S)	67	59.2	27	√
433	GHA327051	153.5	114.3	1/2-20(5S)	71.4	23.7	27	
434	GHA327052	138	114.3	M12x1.5(5S)	53.9	46.4	27	√
435	GHA327054	137.9	114.3	M12x1.25(5S)	56	66.6	27	√
436	GHA327056	138	114.3	M12x1.25(5S)	56.1	46.5	27	√
437	GHA327057	138	114.3	M12x1.25(5S)	56	63.4	27	√
438	GHA328002K	152	114.3	M12X1.5(5S)	64	61.4	28	√
439	GHA328003K	139	114.3	M12X1.5(4S)	56.5	37	28	√
440	GHA328005K	160	130	M14X1.5(5S)	83.9	47.5	28	
441	GHA328006K	139	114.5	M12X1.5(5S)	67	38.5	28	√
442	GHA328007K	140	114.3	M12X1.25(5S)	60	53.5	28	√
443	GHA328008	139	114.3	M12X1.5(4S)	56.5	37	28	
444	GHA328011K	139	114.3	M12x1.5(5S)	67	57	28	
445	GHA328012	139.7	114.3	M12x1.5(5S)	67	63	28	
446	GHA328013	159.8	120	M14x1.5(5S)	64	62.4	28	√
447	GHA328014	139.7	114.3	M12x1.5(5S)	67	63.1	28	
448	GHA329001K	136	114.3	M12X1.25(5S)	66	40.7	29	√
449	GHA329002K	160	120	M14X1.5(5S)	72.5	57.8	29	
450	GHA329003	139.8	114.3	M12X1.25(6S)	66	46.1	29	√

Hub Assemblies

Basic Dimension Table-G-AP to Dimension.....

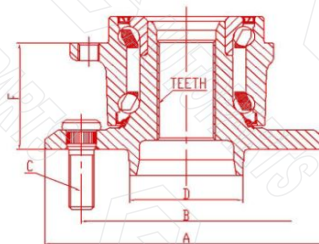
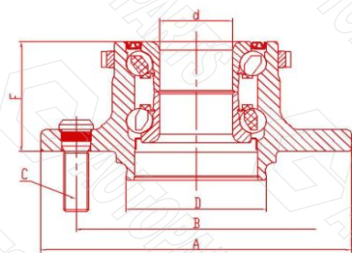

ID	G-AP Ref.	BASIC DIMENSIONS(mm)					TEETH / d	ABS
		A	B	C	D	F		
451	GHA329004K	165	127	1/2-20(5S)	71.5	52	29	√
452	GHA329005	139.8	114.3	M12X1.25(6S)	66	61.1	29	√
453	GHA329006K	136	114.3	M12X1.25(5S)	66	40.7	29	√
454	GHA329007	165	127	1/2-20(5S)	71.5	63.5	29	√
455	GHA329008K	175	130	M14X1.5(6)	84	62.7	29	
456	GHA329009	139.7	114.2	M12x1.25(6S)	66	61	29	
457	GHA329010	136	114.3	M12X1.25(4S)	66	50	29	√
458	GHA329012K	136	114.3	M12x1.25(5S)	66	40.7	29	√
459	GHA329013	175	130	M14X1.5(6)	84	62.7	29	√
460	GHA329015K	148	114.3	M12X1.25(5S)	66	69.2	29	√
461	GHA329017	170.4	139.7	M12x1.25(6S)	77.4	45.2	29	√
462	GHA329018K	158.5	120	M14x1.5(5S)	72.5	58	29	
463	GHA329019	136	114.3	M12x1.25(5S)	66	40.7	29	√
464	GHA329023	148	114.3	M12x1.25(5S)	65.9	69	29	√
465	GHA329025	148	114.3	M12x1.25(5S)	66	69.2	29	
466	GHA330001K	145.8	115	M12X1.5(5S)	70.1	37	30	√
467	GHA330006K	169.3	139.7	M12X1.5(6S)	67	37.5	30	
468	GHA330007	169	139.8	M12X1.5(6S)	67	37.5	30	
469	GHA330008K	151	115	M12X1.5(5S)	70.1	64.7	30	√
470	GHA330009	139.5	114.3	M12X1.5(5S)	67	53.3	30	
471	GHA330010K	151	115	M12X1.5(5S)	70.1	42	30	√
472	GHA330011K	137	110	M12X1.5(5)	65	39	30	√
473	GHA330013K	137	110	M12X1.5(5)	65	39	30	√
474	GHA330014K	139	114.3	M12X1.5(5S)	60	47.5	30	√
475	GHA330017K	169.2	139.7	M12X1.5(6S)	66.9	42.5	30	
476	GHA330018K	169.2	139.7	M12X1.5(6S)	66.9	37.5	30	
477	GHA330019K	146	115	M12X1.5(5S)	70.1	42	30	√
478	GHA330020K	154.5	114.3	M12X1.5(5S)	60	67.5	30	
479	GHA330021K	137	110	M12X1.5(5)	65	39	30	√
480	GHA330022F	137	110	M12X1.5(5)	65	39	30	
481	GHA330024K	157	120	M14X1.5(5S)	66.9	42	30	√
482	GHA330024F	157	120	M14X1.5(5S)	66.9	42	30	√
483	GHA330024S	157	120	M14X1.5(5S)	66.9	42	30	√
484	GHA330025K	135	110	M14X1.5(5)	65	38.5	30	√
485	GHA330026K	144	120	M14X1.25(5)	74	60	30	√
486	GHA330027	145.5	120.7	M12x1.5(5S)	70.1	42.1	30	
487	GHA330028	137	110	M12x1.5(5S)	65	39	30	√
488	GHA330029	154.5	114.3	M12X1.5(5S)	60	67.5	30	√
489	GHA330032	151	115	M12x1.5(5S)	70.1	42	30	√
490	GHA330037	154.2	114.3	M12x1.5(5S)	60	67.5	30	
491	GHA330038	151.8	120	M14x1.5(5S)	64	47.4	30	√
492	GHA330044	140	114.3	M12x1.5(5S)	60	50.1	30	√
493	GHA330045	140	114.3	M12x1.5(5S)	60	50.1	30	√
494	GHA330046	154.2	114.3	M12x1.5(5S)	60	67.6	30	√
495	GHA330047	152	112	M14x1.5(5)	66.4	59	30	√

Hub Assemblies

Basic Dimension Table-G-AP to Dimension.....

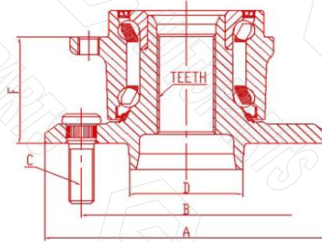
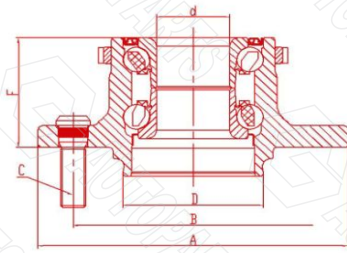

ID	G-AP Ref.	BASIC DIMENSIONS(mm)					TEETH / d	ABS
		A	B	C	D	F		
496	GHA330048K	152.2	120	M14x1.5(5S)	64	47.6	30	√
497	GHA331001	160.5	114.3	1/2-20(6S)	71.4	53.5	31	
498	GHA331004	160.5	114.3	1/2-20(6S)	71.4	53.5	31	
499	GHA331006K	160.5	114.3	1/2-20(6S)	71.37	53.5	31	
500	GHA331007A	161.3	139.7	M12x1.5(6S)	92.2	48	31	
501	GHA331008	139	114.3	M12x1.5(5S)	66.9	42.8	31	√
502	GHA332001K	141.5	114.3	M12X1.5(5S)	67	48.5	32	√
503	GHA332002	162	127	M12X1.5(5S)	71.4	48.5	32	√
504	GHA332005K	148	114.3	M12X1.25(6S)	66	69	32	
505	GHA332006	154.5	114.3	1/2-20(5S)	71.4	48.5	32	√
506	GHA332008K	161.5	127	1/2-20(5S)	71.4	48.5	32	√
507	GHA332009K	162	127	M12X1.5(5S)	71.5	48.6	32	√
508	GHA332010K	141.5	114.3	M12X1.5(5S)	67	48.5	32	
509	GHA332011	148	114.3	M12X1.25(5S)	66	69	32	
510	GHA332014	171	139.7	M12x1.25(6S)	77.7	56.3	32	√
511	GHA332018	162	127	M12x1.5(5S)	71.4	48.5	32	√
512	GHA332020	149.5	115	M14x1.5(5S)	71.3	60.1	32	
513	GHA332024	136	114.3	M12x1.25(5S)	66	40.8	32	√
514	GHA333006	146	115	M12X1.5(5S)	70.1	42	33	√
515	GHA333012	181	135	M12X1.75(5S)	86.7	49.3	33	
516	GHA333018	180	150	M12x1.75(7S)	86.8	49.2	33	√
517	GHA333019	181.35	135	M14X2(5S)	86.7	49.3	33	√
518	GHA333022	172.2	139.7	1/2-20(5S)	77.6	50.8	33	
519	GHA333024K	124.8	100	M12X1.5(5S)	57	44.2	33	
520	GHA333027	180	139.7	M14X1.5(6S)	77.9	49.8	33	
521	GHA333029K	137	110	M12X1.5(5)	65	38	33	√
522	GHA333031	145.5	114.3	M12X1.5(5S)	71.4	42	33	
523	GHA333033k	119	100	M12X1.5(4)	56.5	39	33	√
524	GHA333036K	119	100	M12X1.5(4)	56.5	39	33	
525	GHA333038	183	139.7	9/16-18(5S)	77.7	46.6	33	
526	GHA333039	212	165	15.3(8)		75.4	33	
527	GHA333041	198.8	165.1	M14X1.5(8S)	116.7	57.8	33	
528	GHA333042	208	165	15.3(8)		67.8	33	
529	GHA333047	181	139.7	1/2-20(5S)	77.6	50.8	33	
530	GHA333048	181	139.7	1/2-20(5S)	77.6	50.8	33	
531	GHA333050	181.5	135	M12X1.75(5S)	86.8	49.1	33	
532	GHA333052K	169	139.9	M12X1.5(6S)	67	61.4	33	
533	GHA333058	208	165.1	Φ15.3(8)	121	55.9	33	
534	GHA333059	181	150	M12x1.75(7S)	86.8	49.2	33	
535	GHA333060	172.2	139.7	1/2-20(5S)	77.7	50.8	33	√
536	GHA333061	181.5	135	M14X2(5S)	86.8	49.2	33	
537	GHA333062	172.2	139.7	1/2-20(5S)	77.7	50.8	33	
538	GHA333068	199.3	165.1	M14X1.5(8S)	116.6	57.8	33	
539	GHA333069K	119	100	M12X1.5(4)	56.5	39	33	√
540	GHA333070K	137	110	M12X1.5(5)	65	38	33	√

Hub Assemblies

Basic Dimension Table-G-AP to Dimension.....

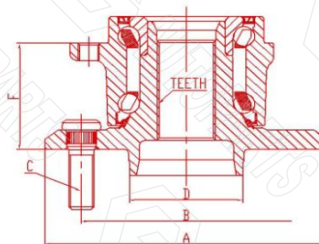
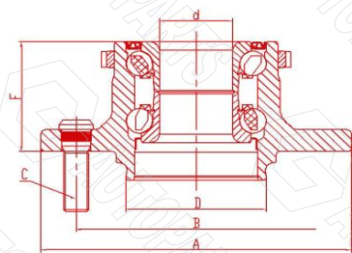

ID	G-AP Ref.	BASIC DIMENSIONS(mm)					TEETH / d	ABS
		A	B	C	D	F		
541	GHA333075	179	139.7	M14X1.5(6S)	77.7	50	33	
542	GHA333076K	133.4	112	M12X1.5(3)	57	54	33	
543	GHA333077	205.3	165	9/16-18(8S)	121	54.5	33	√
544	GHA333080K	136	105	M12X1.5(5S)	56.5	42	33	√
545	GHA333082	205	165	M14.3X1.1.41(8S)	121	54.3	33	
546	GHA333083K	146	115	M12x1.5(5S)	70.1	42.1	33	√
547	GHA333084	205	165	M14.3X1.1.41(8S)	121	54.3	33	
548	GHA333085	169	139.8	M12x1.5(6S)	67	66	33	
549	GHA333086	204.5	165	9/16-18(8S)	121	54.3	33	√
550	GHA333090	183	139.7	9/16-18(5S)	77.8	48.6	33	√
551	GHA333091	183	135	M14x2(6S)	86.8	55.5	33	√
552	GHA333095	150	114.3	M12X1.5(5S)	63.8		33	
553	GHA333097K	137	110	M12x1.5(5)	65	39	33	√
554	GHA333102K	137	110	M12x1.5(5)	65	38	33	
555	GHA333104	178.5	139.7	M12x1.5(6S)	99.9	49.7	33	√
556	GHA333107	183	139.7	9/16-18(5S)	77.7	46.9	33	√
557	GHA333110	183	139.7	9/16-18(5S)	77.7	46.9	33	√
558	GHA335001	205	165.1	9/16-18(8S)	121	56.5	35	√
559	GHA336001K	126.7	100	M14X1.5(5)	57	55.3	36	√
560	GHA336002	126.5	100	M14X1.5(5)	57	59.5	36	
561	GHA336003K	131.5	108	M12X1.5(5S)	63.2	66	36	√
562	GHA336004K	136.5	112	M14X1.5(5)	57	48	36	√
563	GHA336005K	135.7	108	M12X1.75(5)	65	43	36	
564	GHA336006K	135.7	108	M14X1.5(5)	65	43	36	
565	GHA336006S	135.7	108	M14X1.5(5)	65	43	36	
566	GHA336007K	136.5	112	M14X1.5(5)	57	48	36	√
567	GHA336008	138	114.3	M12x1.5(5S)	67	61.5	36	√
568	GHA336010K	131.3	108	M12x1.5(5S)	63.2	61.5	36	√
569	GHA336011K	136	108	M14X1.5(5)	67	43	36	
570	GHA336012K	136	108	M14X1.5(5)	67	59	36	√
571	GHA336013K	120.7	100	M14X1.5(5)	57	55.4	36	√
572	GHA336014K	136	108	M14X1.5(5)	65	59	36	√
573	GHA336015K	136	108	M14x1.5(5)	63.2	73	36	
574	GHA336016K	136	108	M14x1.5(5)	63.2	63	36	
575	GHA336017K	136	108	M12x1.5(5S)	63.2	73	36	
576	GHA338001K	149.5	120	M14X1.5(5)	65	71.8	38	√
577	GHA340001K	136	108	M12X1.5(5S)	63.2	67.8	40	
578	GHA340003k	136.2	108	M14X1.5(5)	63.3	68	40	√
579	GHA340004K	136	108	M14X1.5(5)	67	43	40	
580	GHA340005K	136.5	108	M14x1.5(5S)	63.2	67.8	40	√
581	GHA342001	149.5	114	1/2-20(5S)	70.5	56.3	42	
582	GHA355005K	203	170	M14X2(8S)	125	54.4	55	
583	GHA400001K	139	120	M12X1.5(5)	74	51		
584	GHA400003	131	112	M14X1.5(5)	57	70.1		√
585	GHA400004	148	114.3	M12X1.5(4S)	67	59		√

Hub Assemblies

Basic Dimension Table-G-AP to Dimension.....

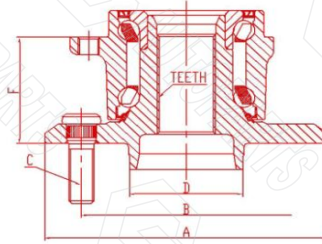
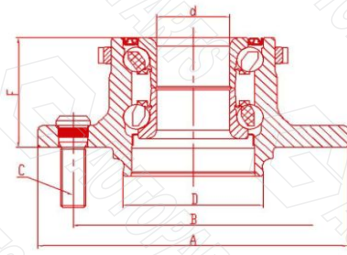

ID	G-AP Ref.	BASIC DIMENSIONS(mm)					TEETH / d	ABS
		A	B	C	D	F		
586	GHA400007	135	100	M12X1.5(4S)	54	54.5		
587	GHA400008	135	100	M12X1.5(4S)	54	54.5		√
588	GHA400009	148	114.3	M12X1.25(4S)	66	69		√
589	GHA400010	135	100	M12X1.5(4S)	54	54.5		√
590	GHA400011	148	114.3	M12X1.25(5S)	66	69		√
591	GHA400013	151	115	M12X1.5(5S)	70.1	65.1		√
592	GHA400014	138	100	M12X1.5(5S)	57	65		√
593	GHA400016	151	115	M12X1.5(5S)	70.1	65.1		√
594	GHA400024	152	114.3	M12X1.5(5S)	60	74.8		
595	GHA400025	146.5	120	M12X1.5(5S)	70.1	69.1		√
596	GHA400026	126.5	100	M12X1.5(5S)	56.8	48		√
597	GHA400027	137.5	114.3	M12X1.5(5S)	65.5	59		√
598	GHA400030	140.5	114.3	M12X1.5(5S)	71.4	48		√
599	GHA400031	151	115	M12X1.5(5S)	70.1	65.1		√
600	GHA400036K	140	100	M12X1.5(4S)	54	74.7		√
601	GHA400037	148	114.3	M12X1.5(4S)	67	59		
602	GHA400038	140	120	M12X1.5(5S)	69.5	43		√
603	GHA400039	140	120	M12X1.5(5S)	69.5	43		√
604	GHA400040	140	120	M12X1.5(5S)	69.5	43		√
605	GHA400041	140	120	M12X1.5(5S)	69.5	43		
606	GHA400042	140	120	M12X1.5(5S)	69.5	43		√
607	GHA400043	140	120	M12X1.5(5S)	69.5	43		
608	GHA400044	140	120	M12X1.5(5S)	69.5	43		
609	GHA400045	140	120	M12X1.5(5S)	69.5	43		√
610	GHA400046	140	120	M12X1.5(5S)	69.5	43		√
611	GHA400047	140	120	M12X1.5(5S)	69.5	43		√
612	GHA400048	140	120	M12X1.5(5S)	69.5	43		√
613	GHA400049	139.5	114.3	M12X1.5(4S)	56.5	63		√
614	GHA400051K		120	M14X1.5(5)	66.4	76.8		√
615	GHA400052K	140	110	M12X1.5(5)	65	78		√
616	GHA400053K	140	110	M12X1.5(5)	65	78		
617	GHA400054	140	100	M12X1.5(4S)	54	74.8		
618	GHA400058K	136	99.7	M12X1.5(4)	56.5	78		
619	GHA400059	135	100	M12X1.5(4S)	54	54.5		
620	GHA400060	152	114.3	M12X1.5(5S)	60	74.5		√
621	GHA400061	152	114.3	M12X1.5(5S)	60	74.5		√
622	GHA400062	135	100	M12X1.5(4S)	54	54.5		√
623	GHA400064K	136	99.7	M12X1.5(4)	56.5	78		√
624	GHA400067	139.5	100	M12X1.5(5S)	54	74.7		√
625	GHA400068	139.5	114.3	M12X1.5(5S)	64	58.7		√
626	GHA400071	140.5	114.3	M12X1.5(5S)	71.4	48		√
627	GHA400072K	140.5	114.3	M12X1.5(5S)	67	60.6		√
628	GHA400076	139	108	M12X1.5(5S)	63.3	44.5		√
629	GHA400077	135	100	M12X1.5(5S)	54	54.5		
630	GHA400079	152	114.3	M12X1.5(5S)	60	60		√

Hub Assemblies

Basic Dimension Table-G-AP to Dimension.....

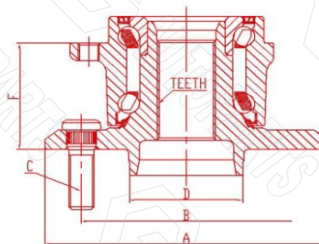
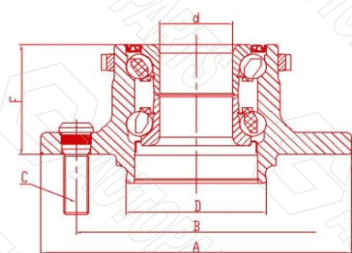

ID	G-AP Ref.	BASIC DIMENSIONS(mm)					TEETH / d	ABS
		A	B	C	D	F		
631	GHA400081K	136	108	M12X1.5(5S)	63.3	63		√
632	GHA400083	139.3	114.3	M12X1.5(5S)	64	55.1		√
633	GHA400084K	136	108	M12X1.5(5S)	63.2	63.2		√
634	GHA400085	139	114.3	M12X1.5(4S)	56.5	63		√
635	GHA400086K	152	114.3	M12X1.5(5S)	60	74.8		√
636	GHA400087K	135	100	M12X1.5(4S)	54	60		√
637	GHA400088	137.5	114.3	M12X1.5(4S)	65.5	59		√
638	GHA400089	137.5	114.3	M12X1.5(4S)	65.5	59		√
639	GHA400090	152	114.3	M12X1.5(5S)	60	60		√
640	GHA400091K	139.5	114.3	M12X1.5(4S)	56.5	63		
641	GHA400092	125	100	M12X1.5(4S)	54	74.7		√
642	GHA400093	135	100	M12X1.5(5S)	54	60		
643	GHA400094	135	100	M12X1.5(5S)	54	60		√
644	GHA400095	135	100	M12X1.5(5S)	54	54.5		√
645	GHA400096	148	114.3	M12X1.25(4S)	66	69		√
646	GHA400098	135	100	M12X1.5(4S)	54	60		
647	GHA400099	138.5	100	M12X1.5(4S)	54	51.7		√
648	GHA400100	140	100	M12X1.5(4S)	53.7	58		
649	GHA400101	139.5	114.3	M12X1.5(5S)	64	59		√
650	GHA400104	148	114.3	M12X1.25(4S)	66	69		
651	GHA400105	136	108	M12X1.5(5S)	63.2	63.2		
652	GHA400106	142	114.3	M12X1.5(5S)	67	63		√
653	GHA400107	142	114.3	M12X1.5(5S)	67	63		
654	GHA400108	148	114.3	M12X1.5(5S)	67	59		√
655	GHA400109K	135.7	108	M14X1.5(5)	65	58.8		√
656	GHA400110	122	100	M12X1.5(4S)	54	68.5		√
657	GHA400112	140	114.3	M12X1.5(5S)	71.3	48		
658	GHA400114	135	100	M12X1.5(5S)	54	54.5		√
659	GHA400115	138	100	M12X1.5(4S)	54	52.5		√
660	GHA400116	152	114.3	M12X1.5(5S)	64	61.5		√
661	GHA400118K	140	110	M12X1.5(5)	65	78		√
662	GHA400121	152	114.3	M12X1.5(5S)	60	69		√
663	GHA400127	140	114.3	M12X1.25(6S)	66	46.1		√
664	GHA400129K	152	114.3	M12X1.5(5S)	60	69		
665	GHA400130K	140	100	M12X1.5(4S)	54	58		√
666	GHA400131	148	114.3	M12X1.5(5S)	67	59		√
667	GHA400133K	140	110	M12X1.5(5)	65	78		√
668	GHA400134K	137.5	100	M14X1.25(4)	56	56.5		√
669	GHA400134F	137.5	100	M14X1.25(4)	56	56.5		√
670	GHA400135K	137	114.3	M12X1.5(5S)	67	59.5		√
671	GHA400136K	131	108	M12X1.5(4S)	63.2	68.5		√
672	GHA400137K	140	110	M12X1.5(5)	65	68		√
673	GHA400140	140	114.3	M12X1.5(5S)	67	63		√
674	GHA400141	152.7	114.3	M12x1.5(5S)	60	78.5		√
675	GHA400144	145.5	120.7	M12X1.5(5S)	70.1	42.1		

Hub Assemblies

Basic Dimension Table-G-AP to Dimension.....

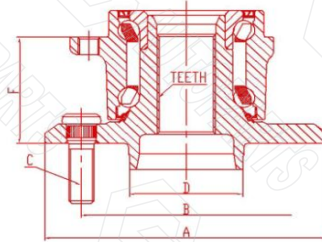
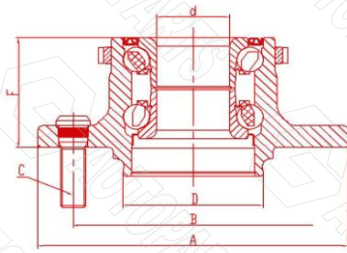

ID	G-AP Ref.	BASIC DIMENSIONS(mm)					TEETH / d	ABS
		A	B	C	D	F		
676	GHA400149	135	100	M12X1.5(4)	54	55.5		√
677	GHA400151	140	114.3	M12X1.5(5S)	67	54.5		√
678	GHA400152	144.5	120	M12X1.5(5S)	67	42.1		√
679	GHA400153K	136	99.7	M12X1.5(4)	56.5	78		√
680	GHA400154k	137.5	100	M12X1.5(4)	56	56.5		√
681	GHA400155	140	114.3	M12X1.5(5S)	67	54.5		√
682	GHA400156	140	114.3	M12X1.5(5S)	67	54.5		√
683	GHA400157	148	114.3	M12X1.5(5S)	67	59		√
684	GHA400158K	140	100	M12X1.5(4S)	54	58		√
685	GHA400159	142	114.3	1/2-20(5S)	70.5	45.4		√
686	GHA400160	139.8	114.3	M12X1.25(6S)	65.9	61.1		√
687	GHA400161	148	114.3	M12X1.25(5S)	66	69		√
688	GHA400164K	136	105	M12X1.5(5S)	56.5	64.8		√
689	GHA400165	143	114.3	M12X1.5(5S)	67	59		√
690	GHA400166	135	100	M12X1.5(5S)	54	60		√
691	GHA400167K	152	114.3	M12X1.5(5S)	60	69		√
692	GHA400168	137.5	114.3	M12X1.5(4S)	65.5	59		√
693	GHA400169K	160	130	M14X1.5(5S)	83.9	47.5		√
694	GHA400170K	143	120	M12X1.5(5)	72.5	51		√
695	GHA400171K	147	120	M12X1.5(5)	72.5	51		√
696	GHA400171S	147	120	M12X1.5(5)	72.5	51		√
697	GHA400172	139.7	114.2	M12x1.25(6S)	66	61		√
698	GHA400173	183	135	M14x2(6S)	86.8	45.6		√
699	GHA400174K	136	108	M12X1.5(5S)	63.2	63.2		√
700	GHA400175	162	127	M12X1.5(5S)	71.4	48.6		√
701	GHA400176K	140.5	114.3	M12X1.5(5S)	67	60.6		√
702	GHA400177	148	114.3	M12X1.25(4S)	66	69		√
703	GHA400178	162	127	M12X1.5(5S)	71.4	48.6		√
704	GHA400179	162	127	M12X1.5(5S)	71.4	48.6		√
705	GHA400180	134	100	M12X1.25(4S)	60	69		√
706	GHA400181	139	108	M12X1.5(5S)	63.3	44.5		√
707	GHA400182K	128	108	M12X1.25(5)	65	107		√
708	GHA400183	148	114.3	M12X1.25(5S)	66	69		√
709	GHA400184	152	114.3	M12x1.5(5S)	60	69		√
710	GHA400187	140	114.3	M12x1.25(5S)	60	60		√
711	GHA400188K	140	114.3	M12X1.5(5)	60	60		√
712	GHA400190	139.2	114.3	M12X1.5(5S)	67	53.3		√
713	GHA400191	136	108	M12X1.5(4S)	63.3	63		√
714	GHA400192	140.5	114.3	M12X1.5(5S)	67	60.6		√
715	GHA400193K	146	115	M12X1.5(5S)	70.1	65.1		√
716	GHA400194	148	114.3	M12X1.25(5S)	66	69		√
717	GHA400196K	131	112	M14X1.5(5)	56.2	48		√
718	GHA400197K	136	108	M14X1.5(5S)	63.2	73		√
719	GHA400198	120	100	M12X1.5(4)	54	60		√
720	GHA400199	120	100	M12X1.25(4S)	54	60		√

Hub Assemblies

Basic Dimension Table-G-AP to Dimension.....

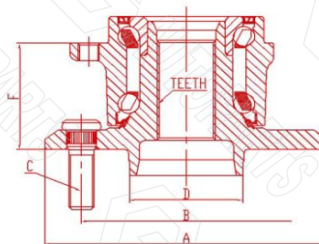
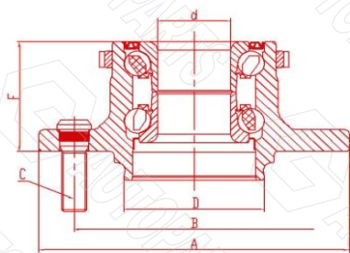

ID	G-AP Ref.	BASIC DIMENSIONS(mm)					TEETH / d	ABS
		A	B	C	D	F		
721	GHA400203	136	114.3	M12X1.25(5S)	66	40.7		√
722	GHA400206K	135	110	M14X1.5(5)	65	38.5		√
723	GHA400207K	136	108	M12X1.5(5S)	63.2	73		√
724	GHA400208	139	114.3	M12X1.5(5S)	67	59		√
725	GHA400210	140	114.3	M12X1.5(5S)	60	55		√
726	GHA400211	138	114.3	M12x1.5(5S)	67	59		√
727	GHA400216	160	120	M14x1.5(5S)	64	62.2		√
728	GHA400218	190	150	M14x2(7S)	86.7	45.7		√
729	GHA400224	130	100	M12X1.5(4S)	54	52.5		√
730	GHA400230	148	114.3	M14X1.5(5S)	67	64		√
731	GHA400231	148	114.3	M12X1.5(5S)	67	59		√
732	GHA400232	132	100	M12x1.5(4S)	54	59		√
733	GHA400233	135	100	M12x1.5(5S)	54	60		√
734	GHA400234	152	114.3	M12x1.5(5S)	60	64		√
735	GHA400236	152	114.3	M12x1.5(5S)	60	72		√
736	GHA400237	140	114.3	M12X1.5(5S)	60	55		√
737	GHA400238	152	114.3	M12x1.5(5S)	60	60		√
738	GHA400239	123.5	100	M12x1.5(4S)	56	61		√
739	GHA400240K	143	112	M14x1.5(5)	66.5	64.5		√
740	GHA400241	140	114.3	M12x1.5(5S)	60	58		√
741	GHA400242	140	114.3	M12X1.5(5S)	60	54.5		√
742	GHA400247	136	114.3	M12x1.25(5S)	66	40.7		√
743	GHA400248K	145	120	M14x1.5(5)	72.5	55		√
744	GHA400253K	136	108	M14x1.5(5)	63.2	63		√
745	GHA400254	134	112	M12x1.5(3)	57	43.3		√
746	GHA400256	139	114.3	M12x1.5(5S)	67	53.5		√
747	GHA400257	139	114.3	M12x1.5(5S)	67	59		√
748	GHA400258	148	114.3	M12x1.5(5S)	67	59		√
749	GHA400259	136	105	M12x1.5(5S)	56.5	64.8		√
750	GHA400260	139	114.3	M12x1.5(5S)	67	59		√
751	GHA400261	139	114.3	M12x1.5(5S)	67	59		√
752	GHA400262	148	114.3	M12x1.5(5S)	67	59		√
753	GHA400263	148	114.3	M12x1.5(5S)	67	59		√
754	GHA400264	148	114.3	M12x1.5(5S)	67	59		√
755	GHA400265	148	114.3	M12x1.5(5S)	67	59		√
756	GHA400268K	145	120	M14x1.25(5)	72.5	44		√
757	GHA400269	152	114.3	M12x1.5(5S)	60	60		√
758	GHA400274	132	100	M12x1.5(4S)	54	59		√
759	GHA400275	152.3	114.3	M12x1.5(5S)	64.1	61		√
760	GHA400276	135	100	M12x1.5(4S)	54	60		√
761	GHA400279	143	120	M14x1.25(5)	72.5	51		√
762	GHA400281	138.7	114.3	M12x1.5(5S)	67	57		√
763	GHA400282	140	114.3	M12x1.5(5S)	60	57		√
764	GHA400285K	136	108	M14x1.5(5)	67	59		√
765	GHA400286	179	139.7	M14x1.5(6S)	77.8	49.7		√

Hub Assemblies

Basic Dimension Table-G-AP to Dimension.....

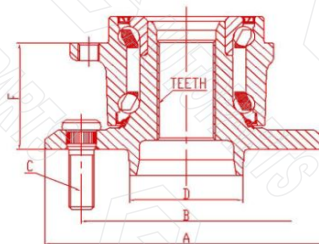
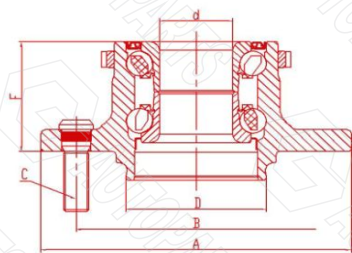

ID	G-AP Ref.	BASIC DIMENSIONS(mm)					TEETH / d	ABS
		A	B	C	D	F		
766	GHA400292	140	114.3	M12x1.5(5S)	60	55		√
767	GHA400295	125	100	M12x1.5(4S)	54	55.5		√
768	GHA400309	135	100	M12x1.5(5S)	54	60		√
769	GHA400310	152	114.3	M12x1.5(5S)	60	69		√
770	GHA400313	150.3	115	M12x1.5(5S)	70.1	64.9		√
771	GHA400314K	147	120	M14x1.25(5)	72.5	51		√
772	GHA400321	152	114.3	M12x1.5(5S)	60	72.1		√
773	GHA400326	148	114.3	M12x1.25(5S)	65.9	69		√
774	GHA400335K	129	108	M12x1.25(5)	65	57		√
775	GHA400336K	131	108	M12x1.5(4S)	63.3	68.5		√
776	GHA400337K	136.6	108	M12x1.5(5S)	63.3	73.2		√
777	GHA400338K	140	110	M12x1.5(5)	65	81		√
778	GHA400340	148	114.3	M12x1.5(5S)	67	59		√
779	GHA400343	152	114.3	M12x1.5(5S)	60	74.5		√
780	GHA400344	152	114.3	M12x1.5(5S)	60	74.5		√
781	GHA400350	135	100	M12x1.5(5S)	54	60.1		√
782	GHA400351	135	100	M12x1.5(5S)	54	60.1		√
783	GHA400353K	152	130	M14x1.5(6)	84	90.1		√
784	GHA400354K	152	130	M14x1.5(6)	84	90.1		√
785	GHA400356	148	114.3	M12x1.25(4S)	66	69		√
786	GHA400359	139.7	114.3	M12x1.5(5S)	67	63.1		√
787	GHA400360	152	114.3	M12x1.5(5S)	60	65		√
788	GHA420004	117	98	M12x1.25(4)	58.2	35.2	20	
789	GHA421001	119	100	M12X1.5(4)	60	33	21	
790	GHA421003	129.5	108	M12X1.25(4)	65	31	21	
791	GHA421004A	121	100	M12X1.5(4)	60	35.2	21	
792	GHA421012	121	100.3	M12x1.5(4)	60	35.3	21	
793	GHA422001	117	98	M12X1.25(4)	58	35	22	
794	GHA422004	120.5	100	M12X1.5(4)	57	33.5	22	
795	GHA422006K	120	100	M12X1.5(4)	56.5	34	22	
796	GHA422007	116	98	M12X1.25(4)	58	35	22	
797	GHA422008A	120.5	100	M12X1.5(4)	57	34.3	22	
798	GHA422009K	120.5	100	M12X1.5(4)	57	33.5	22	
799	GHA422010	182	140	Φ14(5)	98	57.5	22	
800	GHA422012K	120.5	100	M12X1.5(4)	57	33.5	22	
801	GHA422014	122.6	100	M12X1.5(4)	56.5	33.3	22	
802	GHA422015	116	98	M12X1.25(4)	58	30.7	22	
803	GHA422018	116	98	M12X1.25(4)	58	35.2	22	
804	GHA422022	120.5	100	M12X1.5(4)	57	33.5	22	√
805	GHA422023	120	100	M12X1.5(4)		35.8	22	
806	GHA422026	122.5	100	M14X1.5(5)	57	33.7	22	
807	GHA422027K	120.5	99.7	M12X1.5(4S)	56.5	34	22	
808	GHA422029	117	98	M12X1.25(4)	58.5	32	22	
809	GHA422036K	121	100	M12x1.5(4)	57	33.5	22	√
810	GHA423001	130	100	M12X1.5(4)	60	36	23	

Hub Assemblies

Basic Dimension Table-G-AP to Dimension.....

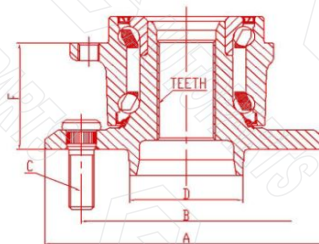
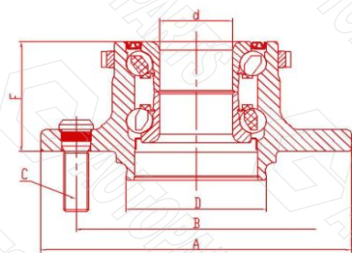

ID	G-AP Ref.	BASIC DIMENSIONS(mm)					TEETH / d	ABS
		A	B	C	D	F		
811	GHA423002	131	108	M12X1.5(4S)	63.2	35	23	
812	GHA423003K	121	100	M12X1.5(4)	60	35.3	23	
813	GHA423007	130	108.3	M12X1.5(4)	63.2	34.5	23	
814	GHA423010	142	114.3	Φ12(4)	69	43	23	
815	GHA423016	151.5	114.3	M12x1.5(5S)	64	38	23	
816	GHA423017	122.3	100	M12x1.25(4S)		35.5	23	
817	GHA423018	142	114.3	M12x1.25(4S)		43	23	
818	GHA424010	141	112	M12X1.5(5)	66.3	34.5	24	
819	GHA424015	122	100	M12X1.5(4S)	54	37	24	
820	GHA424016K	125	100	M12X1.5(4S)	54	36	24	
821	GHA424019	121.5	100	M12x1.5(4S)	54	35.7	24	
822	GHA425001	154	114.3	M12X1.5(4S)	67	38.5	25	
823	GHA425002	120	100	M12X1.5(4S)	54	35.5	25	
824	GHA425004K	131.2	108	M12X1.5(4S)	63.2	34.7	25	
825	GHA425008	117	98	M12X1.25(4)	58	34.4	25	
826	GHA425009	116	98	M12X1.25(4)	58	35.2	25	
827	GHA425017	122	100	M12X1.25(4S)	59	32.5	25	
828	GHA425018K	136	114.3	M12X1.25(4S)	66	32.5	25	
829	GHA425022	128.5	108	M12X1.25(4)	65	33.8	25	
830	GHA425027	137	114.3	M12X1.5(4S)	67	35	25	
831	GHA425028	116.5	98	M12X1.25(5)	58	34	25	
832	GHA425036	123	100	M12X1.5(4S)	54	34.5	25	
833	GHA425041K	122	100	M12x1.25(4S)	60	34	25	
834	GHA425044	150	114.3	M12x1.5(4S)	67	36.2	25	
835	GHA425045	137.2	114.3	M12x1.5(4S)	67	36	25	
836	GHA425047	137	114.3	M12x1.5(4S)	66.9	35.1	25	
837	GHA425048	147.6	112	M12x1.5(5)	66.2	36.8	25	
838	GHA425049	142.4	114.3	M12x1.5(5S)	67	38.9	25	
839	GHA425051	142.3	114.3	M12x1.5(5S)	66.8	35	25	
840	GHA425052	140.6	114.3	M12x1.5(5S)	67	41.6	25	
841	GHA426009K	126	100	M12X1.5(5S)	56.9	56.7	26	
842	GHA426015K	139	114.3	M12X1.5(5S)	59.9	42.5	26	
843	GHA426021	125	100	M12X1.5(4S)	55	33.5	26	
844	GHA426022	125	100	M12X1.5(4S)	54	39.5	26	
845	GHA426023K	124.7	100	M12X1.5(4S)	54	33.5	26	
846	GHA426024	125	100	M12X1.5(4S)	54	36.5	26	
847	GHA426026	139	114.3	M12X1.5(5S)	60	42.5	26	
848	GHA426028K	139	114.3	M12X1.5(5S)	63	42	26	
849	GHA426030K	125	100	M12x1.5(5S)	54	39.5	26	
850	GHA426041	139.9	114.3	M12x1.5(5S)	59.8	33.5	26	
851	GHA426048K	139.2	100	M12x1.5(4S)	56	38	26	
852	GHA426049K	138.9	114.3	M12x1.5(5S)	59.9	42.5	26	
853	GHA426052	140	114.3	M12x1.5(5S)	60	33.5	26	
854	GHA427002	137	114.3	M12X1.5(4S)	67	35	27	
855	GHA427003	138	100	M12X1.5(4)	57	35	27	

Hub Assemblies

Basic Dimension Table-G-AP to Dimension.....

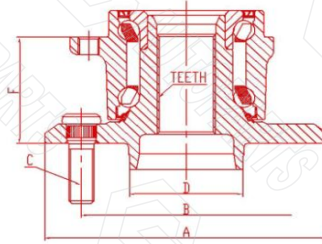
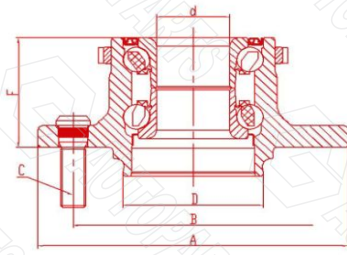

ID	G-AP Ref.	BASIC DIMENSIONS(mm)					TEETH / d	ABS
		A	B	C	D	F		
856	GHA427004	147.8	114.3	M12X1.5(5S)	67	38	27	
857	GHA427005	136.8	114.3	M12X1.5(5S)	67	40	27	
858	GHA427006	140	114.3	M12X1.5(4S)	67	35	27	
859	GHA427008	144.8	120	M12x1.5(5)	72.5	35	27	
860	GHA427010	139	114.3	M12X1.5(5S)	67	39	27	
861	GHA427011	145	120	M12X1.5(5)	72.5	35	27	
862	GHA427017	136	114.3	M12X1.25(5S)	66	40.5	27	
863	GHA427019	150	112	M14x1.5(5)	66.5	34.5	27	
864	GHA427020	139	114.3	M12x1.5(5S)	67	40	27	
865	GHA427021	137.2	114.3	M12x1.5(5S)	67	40	27	
866	GHA427022	137.2	114.3	M12x1.5(4S)	67	40	27	
867	GHA427023	124	100	M12x1.25(5S)	55.9	36	27	
868	GHA427024	124	100	M12x1.25(5S)	55.9	36	27	
869	GHA428001	152	114.3	M12X1.5(4S)	64	42	28	
870	GHA428004	139	118	M14X1.5(5)	71	59.5	28	
871	GHA428005K	140	114.3	M12X1.5(5S)	67	41	28	
872	GHA428006	139	118	M14X1.5(5)	71	46.4	28	
873	GHA428011K	138.7	114.3	M12X1.5(5S)	67	37	28	
874	GHA428015K	139.8	114.3	Φ14(5)	67	39	28	
875	GHA428016	138.7	100	Φ12.5(4)	56	41	28	
876	GHA428026	136.2	108	M14x1.5(5S)	63.2	34.5	28	
877	GHA429001K	160	114.3	1/2-20(5S)	70.5	43	29	
878	GHA429002K	136	114.3	M12X1.25(5S)	66	40.5	29	
879	GHA429003	148	114.3	M12x1.25(5S)	66	41.8	29	
880	GHA429006	148	114.3	M12x1.25(5S)	66	53	29	
881	GHA430001K	139	114.3	M12X1.5(5S)	59.9	42.5	30	
882	GHA430002	139	114.3	M12X1.5(5S)	67	40	30	
883	GHA430005K	139	114.3	M12x1.5(5S)	60	43	30	
884	GHA430007	152.2	114.3	M12x1.5(5S)	64	42	30	
885	GHA430008	167	139.7	M12x1.5(6S)	106	49.8	30	
886	GHA431002	139.7	114.3	M12x1.5(5S)	66.9	42.9	31	
887	GHA431005	158.5	120	M14x1.5(5S)	72.5	47.9	31	
888	GHA433001	120	100	M12X1.5(4S)	56.5	33.8	33	
889	GHA433002	130.5	112	M14X1.5(5)	57	35	33	
890	GHA433004	137	110	M12X1.5(5)	65	35.7	33	
891	GHA433007	120	100	M12X1.5(4)	56.5	34.2	33	
892	GHA433010	135	114.3	M12X1.5(4S)	56.5	36	33	
893	GHA433013	120	100	M12X1.5(4)	56.5	34	33	
894	GHA433019	120	100	M12x1.5(4)		35.6	33	
895	GHA435001	155.5	130	M16X1.5(5)	78	58.5	35	
896	GHA435002	155.7	130	M16X1.5(5)	78	57.2	35	
897	GHA436001	126.5	100	M14X1.5(5)	57	33.5	36	√
898	GHA436002K	126.5	100	M14X1.5(5)	57	36.5	36	√
899	GHA436007	179.4	149.7	M14x1.5(5S)	110	57.7	36	
900	GHA499001K	80	65	Φ10.5(4)		78.5		

Hub Assemblies



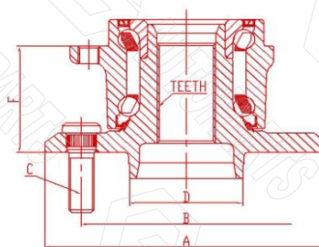
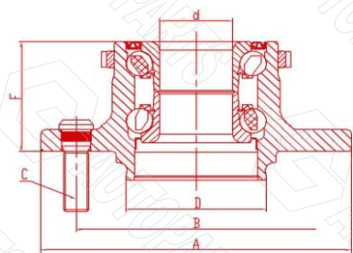









Basic Dimension Table-G-AP to Dimension.....



ID	G-AP Ref.	BASIC DIMENSIONS(mm)					TEETH / d	ABS
		A	B	C	D	F		
901	GHA499004	82	65.5	M10X1.25(4)		82.3		
902	GHA499014		65	Φ10.5(6)		78		
903	GHA499015		65	Φ10.5(6)		78		
904	GHA499032K		65	M10X1.25(4)	36	65.5		
905	GHA499042	150	112	M14X1.5(5)	66.4		35/22	√
906	GHA499044	80.2	64.5	Φ10.5(6)		30.5		
907	GHA499045		65	10.5(6)		31.3		
908	GHA499046		65	10.5(6)		31.3		
909	GHA499047	96	82	8.5(6)		20.2		
910	GHA499064	181	139.7	M12x1.25(6S)	97.9			
911	GHA499084	140	114.3	M12x1.5(5S)	60	75		













Hub Assemblies

Contents of Complete Kits.....

ID	G-AP Ref..													kg
1	GHA225003K	1												1.98
2	GHA225006F	1												1.48
3	GHA225006K	1												2.35
4	GHA225009A	1				1								2.21
5	GHA225010K	1	1								2			2.00
6	GHA225011K	1	1											1.82
7	GHA225012K	1	1								2			2.00
8	GHA225013K	1	1											2.01
9	GHA225014K	1	1											1.81
10	GHA225015K	1												2.20
11	GHA225018K	1	1											7.17
12	GHA225020K	1	1											1.95
13	GHA225021K	1		2										2.20
14	GHA225022K	1	1											2.45
15	GHA225025K	1												1.99
16	GHA225026K	1												1.95
17	GHA225027K	1												1.93
18	GHA225028K	1												2.35
19	GHA225029K	1	1											1.46
20	GHA225030K	1	1											1.98
21	GHA225031K	1												1.69
22	GHA225032K	1	1								1	1		2.10
23	GHA225034K	1	1											2.04
24	GHA225035K	1	1											1.94
25	GHA225036K	1												2.42
26	GHA227001K		1			1								1.70
27	GHA227003K					1								2.09
28	GHA227004K	1												2.00
29	GHA227017K					2								2.02
30	GHA227018K					1								1.56
31	GHA227022F					2								1.48
32	GHA227023K	1	1								1			1.85
33	GHA227026K					1								2.29
34	GHA228006K	1							1					1.10
35	GHA228017K	1												1.91
36	GHA228018K	1												1.83
37	GHA228019K	1												1.62
38	GHA228020K	1												1.87
39	GHA228022K	1												1.86
40	GHA228026K	1												1.70
41	GHA228027K	1												1.28
42	GHA228028K	1												1.93
43	GHA228029K	1												1.70
44	GHA228030K	1												1.70
45	GHA228031K	1												2.13
46	GHA228032K	1												1.60
47	GHA228033K	1												1.65
48	GHA228034K	1												1.92
49	GHA228035K	1												1.89
50	GHA228036K	1	1											1.55
51	GHA228038K	1												1.61
52	GHA228041K	1	1											1.84
53	GHA228046K	1												1.56
54	GHA228049K	1												1.74
55	GHA228051K	1												1.38
56	GHA228056K	1												1.73
57	GHA228057K	1												1.43
58	GHA228058K		1	1										1.33













Hub Assemblies

Contents of Complete Kits.....

ID	G-AP Ref..													kg
59	GHA228061K	1	1	4										1.60
60	GHA228066K	1												1.81
61	GHA228067K	1												1.89
62	GHA228068K	1												2.03
63	GHA228074K	1												2.19
64	GHA230002F	1	1											1.28
65	GHA230002S		1											1.28
66	GHA230003K	1												1.80
67	GHA230005K	1												2.10
68	GHA230008K	1												1.11
69	GHA230014K	1												1.78
70	GHA230015K	1												1.82
71	GHA230017K	1												1.84
72	GHA230020K	1												1.98
73	GHA230023K	1												1.96
74	GHA230024K	1												2.08
75	GHA230026K	1							1					1.15
76	GHA230028K	1												1.50
77	GHA230029K	1												1.81
78	GHA230030K	1												1.84
79	GHA230032K	1												1.71
80	GHA230034K	1												2.14
81	GHA230035K	1												1.74
82	GHA230037K	1												1.83
83	GHA230038K	1							1					1.12
84	GHA230039K		1											2.28
85	GHA230040K	1												2.20
86	GHA230044K	1	1											1.51
87	GHA230046K	1	1											1.66
88	GHA230047K	1	1											1.67
89	GHA230049K	1												1.79
90	GHA230050K	1												1.75
91	GHA230051K	1	1	1										1.63
92	GHA230052K	1												2.19
93	GHA230057K	1	1											1.65
94	GHA230058K	1												2.20
95	GHA230061K	1												1.50
96	GHA230065K	1												1.91
97	GHA230066K	1												2.06
98	GHA230067K	1												2.30
99	GHA230068K	1												1.92
100	GHA230071K	1	1	2										2.40
101	GHA230075A	1	1											2.35
102	GHA230078K	1												1.83
103	GHA230080K	1	1											2.20
104	GHA230081K	1												2.36
105	GHA230082K		1	1										2.00
106	GHA230086K	1	1											1.66
107	GHA230087K	1												1.94
108	GHA230090K	1												1.35
109	GHA230091K	1												2.30
110	GHA230092K	1	1											1.55
111	GHA230092K	1	1											1.55
112	GHA230092S	1	1											1.59
113	GHA230093K	1												2.27
114	GHA230094K	1		4										2.00
115	GHA230097K	1	1											1.60
116	GHA230098K	1	1											1.80













Hub Assemblies

Contents of Complete Kits.....

ID	G-AP Ref..													kg
117	GHA230104K	1												1.44
118	GHA230108K	1												2.50
119	GHA230109K	1												2.73
120	GHA230110K	1												1.74
121	GHA230111K	1												1.99
122	GHA230112K	2												2.30
123	GHA230113K	1												2.28
124	GHA230116K	1	1											2.30
125	GHA230117K	2												1.83
126	GHA230118K	1												1.52
127	GHA230119K	1												2.56
128	GHA230120K	1	1											1.55
129	GHA230121K	1	1											1.92
130	GHA230122K	1												1.99
131	GHA230123K	1												2.24
132	GHA230125K	1												2.05
133	GHA230134K	1												2.30
134	GHA231001K	1	1											1.83
135	GHA232001K	1												2.00
136	GHA232002K	1												2.19
137	GHA232004K	1												1.85
138	GHA232007F	1												1.98
139	GHA232008K	1												2.25
140	GHA232011K	1												1.70
141	GHA232012K	1	1											1.84
142	GHA232013K	1												1.90
143	GHA232014K		1	1										2.30
144	GHA232015K	1												2.10
145	GHA232018K		1	1										2.35
146	GHA232021K	1	1											2.00
147	GHA232022K	1												1.80
148	GHA232024K	1												2.44
149	GHA232026K		1	1							1			2.36
150	GHA232028K	1	1											2.02
151	GHA232029K	1	1											1.70
152	GHA232030K	1	1											1.76
153	GHA232031K	1	1											1.99
154	GHA232032K	1	1											1.99
155	GHA232033K	1												1.89
156	GHA232034K	1	1											2.00
157	GHA232035K	1	1											2.02
158	GHA232036K		1	1							1			2.55
159	GHA232037K	1												2.44
160	GHA232038K	1	1											2.22
161	GHA232039K	1												2.01
162	GHA232040K	1												2.35
163	GHA233002F	1												2.29
164	GHA233005K	1												2.51
165	GHA233007K	1												2.41
166	GHA233009K	1												2.21
167	GHA233010K	1												2.41
168	GHA234003K	1												2.57
169	GHA234004K	1												2.47
170	GHA234005K	1												2.37
171	GHA234008K	1												2.23
172	GHA235001K	1												2.28
173	GHA235005K	1												2.00
174	GHA235008K	1												2.58













Hub Assemblies

Contents of Complete Kits.....

ID	G-AP Ref..													kg
175	GHA235009K	1												2.39
176	GHA235011K	1	1											3.11
177	GHA235012K	1												2.87
178	GHA235014K	1												1.63
179	GHA235015K	1												2.75
180	GHA235018K	1	1											1.70
181	GHA235018K	1	1											1.70
182	GHA235019K	1												2.93
183	GHA235020K	1												1.93
184	GHA235021K	1	1											2.05
185	GHA235022K	1												1.97
186	GHA235023K	1												2.85
187	GHA236002K	1	1											2.70
188	GHA237002K	1	1									1		2.20
189	GHA237003K	1	1											2.10
190	GHA237004K	1	1											2.37
191	GHA237009K	1												2.56
192	GHA237010K	1												5.20
193	GHA237015K	1												5.10
194	GHA237016K	1	1											2.79
195	GHA237017K	1												4.70
196	GHA237018K	1		4										1.17
197	GHA238001K					1								1.52
198	GHA240001K					1								1.24
199	GHA240008K	1												1.62
200	GHA242007K	1	1											4.30
201	GHA242008K	1	1											4.00
202	GHA242009K	1		4										2.02
203	GHA242009S	1		4										1.31
204	GHA243001K	1												1.30
205	GHA243003K	1							1					1.93
206	GHA243004K	1							1					1.94
207	GHA243006K					1					1			1.39
208	GHA244003K				1				1	1	1	1		2.69
209	GHA244004K				1				1	1	1	1		2.69
210	GHA245001K	1		4										1.30
211	GHA245007K			5								1		1.57
212	GHA245007S			5								1		1.55
213	GHA245008K	1		5		1		1						1.45
214	GHA245009K	1		5		1		1						1.10
215	GHA245010K			5								1		1.55
216	GHA245012K	1		4										1.63
217	GHA245015K	1												6.80
218	GHA245016K	1												5.57
219	GHA247001K			5								1		1.92
220	GHA249001K	1		5		1		1						1.81
221	GHA249002K	1		4										1.85
222	GHA249005K	1		4										1.59
223	GHA249006K	1		4										1.97
224	GHA251002K	1		4										2.11
225	GHA254001K										1	2		2.10
226	GHA254002K					1			1		2	1		2.15
227	GHA254003K					1			1		2			2.20
228	GHA254004K					1								2.12
229	GHA262001K			5										1.90
230	GHA320001K	1									1			2.14
231	GHA320002K	1												1.99
232	GHA320003K	1												1.52













Hub Assemblies

Contents of Complete Kits.....

ID	G-AP Ref..													kg
233	GHA324002K			5										2.25
234	GHA325016k	1				1								2.70
235	GHA325018K			4										3.15
236	GHA325019K	1				1								3.35
237	GHA325022K	1				1								3.57
238	GHA325025K	1												3.45
239	GHA325026K	1												2.50
240	GHA326004K	2		6										4.00
241	GHA326005K	1		4										3.61
242	GHA326011K	1		4										2.84
243	GHA326014K	1				1		1						3.68
244	GHA326017K	1				1				1				3.70
245	GHA326020K									1				3.12
246	GHA326024K	1												3.48
247	GHA326026K	1		4										2.90
248	GHA326027K					1								3.29
249	GHA326028K	1												2.75
250	GHA326030K	1												3.15
251	GHA326031K	1		4										3.00
252	GHA326038K			4										3.40
253	GHA326054K	1												3.20
254	GHA327010K	1				1		1						4.80
255	GHA327015K	1					1							5.63
256	GHA327023K	1						1		1				3.80
257	GHA327038K	1												3.64
258	GHA327039K	1												2.65
259	GHA327040K	1												4.19
260	GHA327043K	1												5.13
261	GHA327044K			4		1								3.63
262	GHA328002K	1												3.22
263	GHA328003K	1												3.66
264	GHA328005K	1												4.50
265	GHA328006K	1												3.08
266	GHA328007K	1		4										3.14
267	GHA329001K	1												3.53
268	GHA329002K	1												5.35
269	GHA329004K					1								5.05
270	GHA329015K					1								3.63
271	GHA330006K	2				1		1				1		4.44
272	GHA330008K	1												4.29
273	GHA330010K	1		3										4.56
274	GHA330011K	1	1	3										3.50
275	GHA330013K	1	1	3										3.45
276	GHA330014K	1												3.43
277	GHA330017K	1				1		1						4.45
278	GHA330018K	1				1		1						4.45
279	GHA330019K	1		3										3.90
280	GHA330021K	1	1	3										3.50
281	GHA330022F	1	1	3										3.41
282	GHA330024K	1		3										4.25
283	GHA330024S			3										4.14
284	GHA330025K	1		4										3.31
285	GHA330026K	1		4										4.27
286	GHA332005K	1												4.23
287	GHA333029K	1	1	3		1						1		3.30
288	GHA333033K	1	1	3		1								3.05
289	GHA333036K	1	1	3		1								2.98
290	GHA333052K	1												4.90













Hub Assemblies

Contents of Complete Kits.....

ID	G-AP Ref..													kg
291	GHA333069K	1	1	3										2.95
292	GHA333070K	1	1	3										3.30
293	GHA333076K			5										2.30
294	GHA333080K	1		3										3.41
295	GHA333083K			3										4.03
296	GHA333097K	1	1	3										3.55
297	GHA333102K	1	1	3		1								3.25
298	GHA336001K	1									1			2.10
299	GHA336003K			1										2.79
300	GHA336004K			4										3.10
301	GHA336005K			5										3.32
302	GHA336006K			5										3.28
303	GHA336006S			5										3.24
304	GHA336007K			5										3.46
305	GHA336010K			1										2.72
306	GHA336011K			5										3.65
307	GHA336012K			5										3.75
308	GHA336013K	1												1.85
309	GHA336014K			5										3.74
310	GHA336015K			5										3.84
311	GHA336016K			5										3.60
312	GHA336017K			5										4.01
313	GHA338001K	2												3.93
314	GHA340001K			1										3.05
315	GHA340003K			1										2.95
316	GHA340004K			5										3.70
317	GHA340005K			1										3.17
318	GHA400001K			4										3.60
319	GHA400036K								1					2.90
320	GHA400051K	1		2										4.30
321	GHA400052K	4												3.76
322	GHA400053K	4												3.42
323	GHA400058K	4												3.19
324	GHA400064K	4												3.26
325	GHA400081K			4										3.75
326	GHA400084k			4										3.80
327	GHA400087K			4										2.67
328	GHA400091K			5										3.56
329	GHA400118K	4												3.55
330	GHA400129K					1								3.44
331	GHA400130K			4										2.99
332	GHA400133K	4												3.50
333	GHA400134F			4										3.00
334	GHA400134K			4										3.05
335	GHA400135K			4										2.85
336	GHA400136K			4										2.67
337	GHA400137K	4												3.55
338	GHA400153K	4												3.20
339	GHA400154K			4										3.05
340	GHA400158K			4										2.94
341	GHA400164K			4										4.00
342	GHA400167K	4				1								3.55
343	GHA400170K			4										3.55
344	GHA400171K			4										3.55
345	GHA400171S			4										3.53
346	GHA400174K			5					1					3.45
347	GHA400176K			4										3.15
348	GHA400182K	4		4										6.40













Hub Assemblies

Contents of Complete Kits.....

ID	G-AP Ref..													kg
349	GHA400188K			4										3.13
350	GHA400193K			4										4.15
351	GHA400196K			4										3.55
352	GHA400197K			5					1					4.15
353	GHA400206K			4										3.57
354	GHA400207K			5					1					4.06
355	GHA400207K			5					1					4.06
356	GHA400240K		1	4								4		3.42
357	GHA400248K			4										3.89
358	GHA400253K			5					1					3.54
359	GHA400268K			4										3.78
360	GHA400285K			4										3.62
361	GHA400335K			4										3.48
362	GHA400336K			4										2.80
363	GHA400337K			4										4.38
364	GHA400338K	4												3.51
365	GHA422006K												1	1.75
366	GHA422009K			4									1	2.35
367	GHA422012K			4									1	1.95
368	GHA423003K												1	2.02
369	GHA424016K												1	1.98
370	GHA425004K	1	1		1								1	2.25
371	GHA425018K												1	2.30
372	GHA426023K										2	1	1	2.15
373	GHA436002K			5									1	2.50
374	GHA499032K	1	1		1								1	1.20
375	GHA225019K	1	1											5.12
376	GHA225038K	1	1											6.38
377	GHA225039K	1	1											4.47
378	GHA225040K	1	1											4.51
379	GHA225041K	1	1											6.46
380	GHA225042K	1	1											5.22
381	GHA230115K	1	1										1	1.76
382	GHA230137K	1	1											6.80
383	GHA230138K	1	1											7.78
384	GHA230140K	1	1											7.18
385	GHA230141K	1	1											7.34
386	GHA230142K	1	1											8.37
387	GHA230143K	1	1											8.28
388	GHA230144K	1	1											7.52
389	GHA230145K	1	1											5.23
390	GHA230146K	1	1											5.51
391	GHA230148K	1	1											6.95
392	GHA230151K	2												2.08
393	GHA228074K	1												2.19
394	GHA230134K	1												2.30
395	GHA326054K	1												3.20
396	GHA329004K					1								5.05
397	GHA400087K			4										2.67
398	GHA400130K			4										2.99
399	GHA400158K			4										2.94
400	GHA400335K			4										3.48
401	GHA400336K			4										2.80
402	GHA400337K			4										4.38
403	GHA400338K	4												3.51
404	GHA237001K	1												2.37
405	GHA329018K	1												4.56
406	GHA329006K	1												2.85

Hub Assemblies

Contents of Complete Kits.....

ID	G-AP Ref..													 kg
407	GHA330001K	1		3										3.62
408	GHA331006K													4.75
409	GHA332001K	1												3.72
410	GHA333024K	1						1			1			2.69
411	GHA355005K			4										11.10
412	GHA400072K					1								3.16
413	GHA400086K							1						3.28
414	GHA400109K			4										3.62
415	GHA421004A												1	2.05
416	GHA422008A												1	1.90
417	GHA422027K												1	2.15
418	GHA428011K	1												2.14
419	GHA428005K	1												1.99
420	GHA499001K	1												0.82
421	GHA426009K			3							1			2.29
422	GHA426015K	1			1								1	1.94
423	GHA429001K				1								1	3.60
424	GHA430001K	1			1								1	2.93
425	GHA230084K	1												2.60
426	GHA400169K	1												5.05
427	GHA326032K	1												3.95
428	GHA330020K	1				1		1						3.95
429	GHA332008K	1												4.80
430	GHA332009K	1												4.30
431	GHA332010K	1												3.60
432	GHA324004K	1												2.40
433	GHA426028K												1	2.50
434	GHA429002K												1	2.55
435	GHA331007A	1												4.74
436	GHA329008K				1				1					5.74
437	GHA329012K	1												2.85
438	GHA430005K												1	2.93
439	GHA428015K			5										1.85
440	GHA425041K												1	1.95
441	GHA400314K			4										3.40
442	GHA426030K	1												1.66
443	GHA328011K	1												2.74
444	GHA225037K	1												2.08
445	GHA235024K		1	1										2.78
446	GHA400353K	1		2										5.77
447	GHA426049K	1												2.03
448	GHA426048K	1												1.49
449	GHA400354K	1		2										5.65
450	GHA235025K	1	1											9.19
451	GHA245022K	1												3.33
452	GHA330024F	1		3										4.27
453	GHA422036K	1												1.68
454	GHA330048K	1												4.06

Bearing Kits

Basic Dimension Table-G-AP to Dimension.....

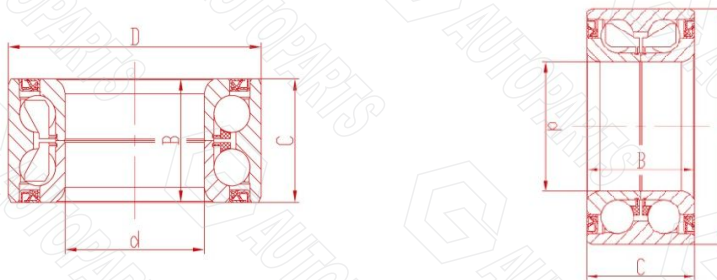

ID	G-AP Ref.	BASIC DIMENSIONS(mm)			ABS	MAGNETIC POLE
		D	d	B/C		
1	GWB0001	75	42	37		
2	GWB0504	39.878	17.463	13.843		
		50.292	26.988	14.224		
3	GWB0526	45.237	19.05	15.494		
		59.131	31.75	15.875		
4	GWB0528	39.878	17.463	13.843		
		50.292	29	14.224		
5	GWB0529	39.878	17.463	13.843		
		50.292	29	14.224		
6	GWB0534	39.878	17.463	13.843		
		50.292	29	14.224		
7	GWB0540	47	25	15		
		58	32	17		
8	GWB0542	45.237	19.05	15.494		
		50.292	29	14.224		
9	GWB0575	68	39	37		
10	GWB0577	62	34	37		
11	GWB0593	64	34	37		
12	GWB0596	50.005	21.43	17.526		
		65.088	34.925	18.034		
13	GWB0652	42	20	15		
		47	25	15		
14	GWB0663	64	34	37		
15	GWB0687	59.974	34.988	15.875		
16	GWB0736	72	39	37		
17	GWB0739	63	38	17		
18	GWB0740	59.974	34.988	15.875		
19	GWB0741	59.974	34.988	15.875		
20	GWB0754	72.06	39	37		
21	GWB0756	39.878	17.463	13.843		
		59.131	31.75	15.875		
22	GWB0757	84	45	39		
23	GWB0802	50.292	29	14.224		
		67.975	40.988	17.5		
24	GWB0826	50.005	21.43	17.526		
		65.088	34.925	18.034		
25	GWB0827	90	40	23		
26	GWB0828	52	25	19.2		
		72	35	24.25		
27	GWB0841	80	40	19.75		
28	GWB0882	72	35	33		
29	GWB0897	59.974	34.988	15.875		
30	GWB0898	59.974	34.988	15.875		
31	GWB0904	45.237	19.05	15.494		
		50.292	26.988	14.224		
32	GWB0906	66	35	37		
33	GWB0909	84	42	39		
34	GWB0910	72	35	17		
		62	35	19		
35	GWB0911	45.237	19.05	15.494		
		67.975	40.988	17.5		

Bearing Kits

Basic Dimension Table-G-AP to Dimension.....

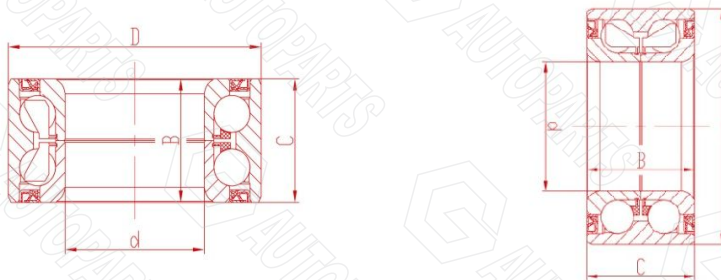

ID	G-AP Ref.	BASIC DIMENSIONS(mm)			ABS	MAGNETIC POLE
		D	d	B/C		
36	GWB0915	82	42	36		
37	GWB0918	68	41	19		
38	GWB0919	68	41	19		
39	GWB0926	45.237	19.05	15.494		
		57.15	26	17.462		
40	GWB0927	42	15	14.3		
		58	23	18.3		
41	GWB0928	35	15	11		
		43	20	13.25		
42	GWB0941	45.237	19.05	15.494		
		59.131	31.75	15.875		
43	GWB0944	39.878	17.463	13.843		
		50.292	29	14.224		
44	GWB0947	45.237	19.05	15.494		
		50.292	29	14.224		
45	GWB0949	63	38	17		
46	GWB0961	52	25	37		
47	GWB0962	82	42	37		
48	GWB0969	52	25	37		
49	GWB0975	52	25	43		
50	GWB0976	55	25	43		
51	GWB1306	64	34	37		
52	GWB1314	84	45	39		
53	GWB1317	72.06	39	37		
54	GWB1320	75	42	37		
55	GWB1324	68	40	19		
56	GWB1326	74	37	45		
57	GWB1327	66	35	32		
58	GWB1333	50.292	29	14.224		
59	GWB1340	74	38	36/33		
60	GWB1342	68.02	35	33/30		
61	GWB1345	61	28	42		
62	GWB1347	84	49	43		
63	GWB1349	58	30	42		
64	GWB1352	45.237	19.05	15.494		
		62	31.75	18.161		
65	GWB1353	45.237	19.05	15.494		
		62	31.75	18.161		
66	GWB1355	75	39/41	37		
67	GWB1356	82	43/45	37		
68	GWB1358	72	40	37		
69	GWB1362	74	38	50		
70	GWB1363	52	27	45/43		
71	GWB1365	72	42	38/35		
72	GWB1366	65.088	38.1	18.034		
73	GWB1367	50.292	28	14.224		
74	GWB1369	50.005	21.43	17.526		
		65.088	34.925	18.034		
75	GWB1370	65.088	38.1	18.034		
76	GWB1374	76.04	40	41/38		
77	GWB1383	63	38	17		

Bearing Kits

Basic Dimension Table-G-AP to Dimension.....

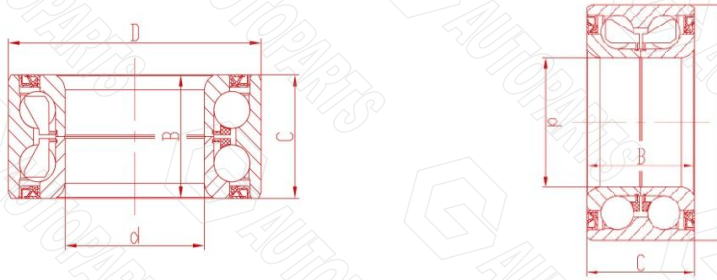

ID	G-AP Ref.	BASIC DIMENSIONS(mm)			ABS	MAGNETIC POLE
		D	d	B/C		
78	GWB1393	90	55	23		
79	GWB1397	67.975	40.988	17.5		
		75	46	18		
80	GWB1401	66	35	33		
81	GWB1410	68	35	37		
82	GWB1412	84.02	45	39		
83	GWB1431	60	35	13		
84	GWB1432	72	39	37		
85	GWB1433	59.974	34.988	15.875		
86	GWB1438	72.04	35	33		
87	GWB1439	72.04	37	37		
88	GWB1444	80	50	20		
89	GWB1445	55	30	17		
		68	40	19		
90	GWB1455	59.974	34.988	15.875		
91	GWB1459	72	39	37		
92	GWB1465	45.237	19.05	15.494		
		62	35	18		
93	GWB1466	85	45	30.2		
94	GWB1467	84	49	48		
95	GWB1470	79.975	44.987	24		
96	GWB1473	59.974	34.988	15.875		
97	GWB1480	75	40	37		
98	GWB1488	80	42	37		
99	GWB1491	72	40	37		
100	GWB1498	45.237	21.987	15.494		
		59.975	34.98	15.875		
101	GWB1499	52	25	22		
		68	40	19		
102	GWB1905	70.64	47.15	27		
103	GWB1909	73.431	45.242	19.558		
		82	50	21.5		
104	GWB1911	72.02	37.99	36/33		
105	GWB1915	73.431	45.242	19.558		
106	GWB1928	63	38	17		
107	GWB1930	62	35	14		
		62	35	14		
108	GWB1931	52	25	15		
		47	20	14		
109	GWB1948	80	42	45		
110	GWB1950	74	40	40		
111	GWB1951	73.431	45.242	19.558		
		82	50	21.5		
112	GWB1956	80	40	19.75		
113	GWB1961	52	28	15.8		
114	GWB1962	50.292	28	14		
115	GWB1970	80	40	36/34		
116	GWB1971	72	35	22/17		
117	GWB1973	80	40	36/34		
118	GWB1999	76	42	38/35		
119	GWB3201	74.02	37.99	36/33		

Bearing Kits

Basic Dimension Table-G-AP to Dimension.....

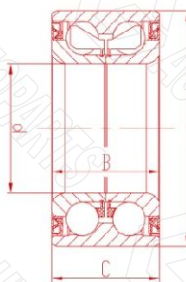
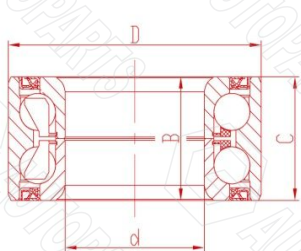

ID	G-AP Ref.	BASIC DIMENSIONS(mm)			ABS	MAGNETIC POLE
		D	d	B/C		
120	GWB3205	67.975	40.988	17.5		
		77.788	45.242	19.842		
121	GWB3206	80	40	19.75		
122	GWB3217	39.878	17.463	13.843		
		49	27	15		
123	GWB3219	68	41	40/35		
124	GWB3220	80	35	26/21		
125	GWB3221	76	43	43/40		
126	GWB3224	68.02	35	33/30		
127	GWB3235	72	42	38/35		
128	GWB3236	65	38	52/48		
129	GWB3237	82	43	45		
130	GWB3245	73	38	40		
131	GWB3246	79	43	41/38		
132	GWB3255	39.878	17.463	13.843		
		50.292	29	14.224		
133	GWB3256	64	34	37		
134	GWB3257	72	39	37		
135	GWB3272	74	40	36		
136	GWB3308	74	38	36/33		
137	GWB3309	74	40	36/34		
138	GWB3319	73.431	41.275	19.558		
		85	45	20.5		
139	GWB3325	80	40	45/44		
140	GWB3331	73.431	41.275	19.558		
		85	50	26		
141	GWB3332	90	45	54/51		
142	GWB3400	88	49	46		
143	GWB3403	66	34	37		
144	GWB3404	75	45	20		
		74.976	45.987	18		
145	GWB3405	72	30	20.75		
		85	45	20.5		
146	GWB3410	74	39	39		
147	GWB3412	74	39	39		
148	GWB3413	66	35	33		
149	GWB3414	72.04	35	33		
150	GWB3416	72.04	37	37		
151	GWB3417	80	50	20		
		90	55	23		
152	GWB3420	77.788	45.242	19.842		
153	GWB3421	77.788	45.242	19.842		
154	GWB3423	82.5	44	37		
155	GWB3427	85	43/45	37		
156	GWB3428	90	55	23		
157	GWB3429	68	40	19		
		55	30	17		
158	GWB3430	62	30	21.25		
		75	40	26		
159	GWB3434	52	25	22		
		73.431	41.275	19.558		

Bearing Kits

Basic Dimension Table-G-AP to Dimension.....

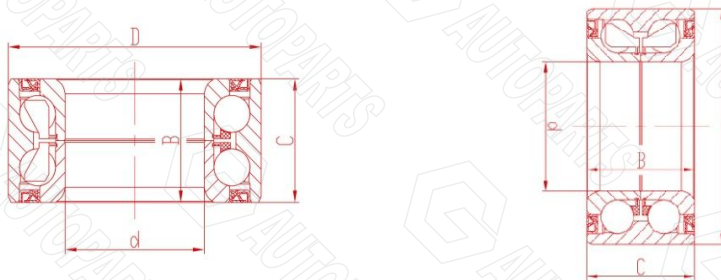

ID	G-AP Ref.	BASIC DIMENSIONS(mm)			ABS	MAGNETIC POLE
		D	d	B/C		
160	GWB3435	84	49	48		
161	GWB3441	68	35	37		
162	GWB3443	80	40	36/34		
163	GWB3446	72.06	39	37		
164	GWB3449	80	43	38		
165	GWB3450	80	43	38		
166	GWB3455	74	40	40		
167	GWB3475	90	55	23		
		90	50	24.75		
168	GWB3485	68	41	19		
169	GWB3486	84	45	39		
170	GWB3490	84.06	45	39		
171	GWB3492	84.05	40	39/40	√	88
172	GWB3495	84	40	38		
173	GWB3496	65	35	35		
174	GWB3499	75	42	37		
175	GWB3500	84	49	48		
176	GWB3501	80	45.3	48		
177	GWB3504	88.02	45	39		
178	GWB3518	84.06	45	39		
179	GWB3519	45.237	19.05	15.494		
		50.292	29	14.224		
180	GWB3520	75.05	42	37		
181	GWB3521	55	25	43		
182	GWB3522	88	49	46		
183	GWB3525	52	25	37		
184	GWB3527	82.5	44	37		
185	GWB3528	68.02	35	37		
186	GWB3530	72.05	39	37		
187	GWB3531	72.04	39	37	√	88
188	GWB3532	53.02	29	37		
189	GWB3535	75	39/41	37		
190	GWB3538	72.04	35	33	√	96
191	GWB3539	72.04	37	37	√	96
192	GWB3543	74	39	39		
193	GWB3551	73	40	55		
194	GWB3552	90	55	60		
195	GWB3554A	72	37	33		
196	GWB3556	52	25	37		
197	GWB3565	45.237	21.987	15.494		
		68	40	19		
198	GWB3571	61.8	35	40		
199	GWB3572	52	25	42		
200	GWB3574	90.06	49	45		
201	GWB3575	75	40	37	√	64
202	GWB3577	66	35	33	√	96
203	GWB3581	72.04	37	37	√	96
204	GWB3584	82	42	36	√	96
205	GWB3596	72.04	37	37		
206	GWB3598	74.04	37	37	√	96
207	GWB3599	82.5	42	37	√	96

Bearing Kits

Basic Dimension Table-G-AP to Dimension.....

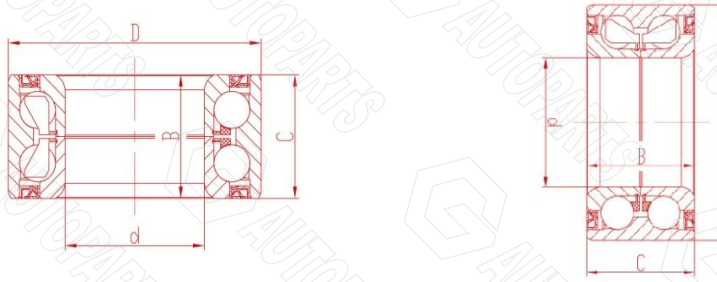

ID	G-AP Ref.	BASIC DIMENSIONS(mm)			ABS	MAGNETIC POLE
		D	d	B/C		
208	GWB3601	53	27	43		
209	GWB3603	82.5	44	37	√	96
210	GWB3605	82	43/45	37		
211	GWB3607	74	40	40		
212	GWB3608	83	45	39	√	96
213	GWB3613	84	49	48		
214	GWB3614	80	45.3	48		
215	GWB3615	84.05	40	38/39.7		
216	GWB3616	86	45	39		
217	GWB3617	68	35	48		
218	GWB3618	86	45	39	√	96
219	GWB3625	83	47	37	√	64
220	GWB3628	88	49	46		
221	GWB3633	82.5	44	37	√	96
222	GWB3637	72.04	37	37	√	96
223	GWB3638	77	42	39	√	96
224	GWB3639	55	25	45		
225	GWB3640	84	49	48		
226	GWB3641	90	55	60		
227	GWB3642	75	42	60		
228	GWB3645	96	51	50	√	96
229	GWB3647	75	40	37		
230	GWB3648	88	45	39	√	96
231	GWB3649	86	46	39	√	96
232	GWB3657	72	37	33	√	96
233	GWB3658	52	25	37		
234	GWB3666	50.292	29	14.224		
235	GWB3668	85.04	45	41		
236	GWB3676	55	25	48		
237	GWB3678	72.06	39	37		
238	GWB3679	84	49	48		
239	GWB3680	60	25	45		
240	GWB3682	75.05	42	37	√	96
241	GWB3683	83	45	44	√	96
242	GWB3684	69	38	39/34	√	64
243	GWB3688	80	42	46		
244	GWB3690	90	55	60		
245	GWB3692	83	45	39	√	96
246	GWB3703	68	35	39/36		
247	GWB3713	61.8	35	31		
248	GWB3716	47	20	14		
		52	25	15		
249	GWB3717	47	20	14		
		52	25	15		
250	GWB3718	72	40	36/33		
251	GWB3727	73.431	45.242	19.558		
		82	50	21.5		
252	GWB3729	72.02	37.99	36/33		
253	GWB3730	72.02	37.99	36/33		
254	GWB3740	90	40	23		
255	GWB3765	80	40	45/44		

Bearing Kits

Basic Dimension Table-G-AP to Dimension.....

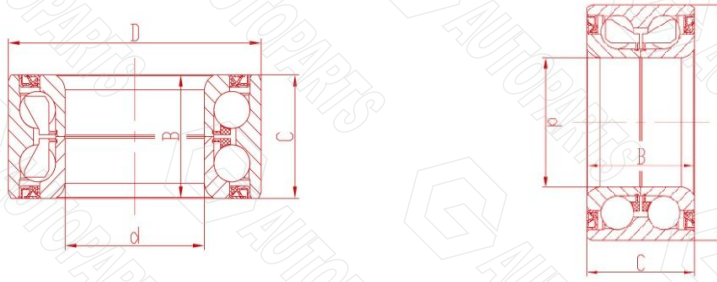

ID	G-AP Ref.	BASIC DIMENSIONS(mm)			ABS	MAGNETIC POLE
		D	d	B/C		
256	GWB3775	80	40	19.75		
257	GWB3785	72.06	39	37		
258	GWB3786	64	34	37		
259	GWB3796	47	20	15.25		
		52	25	16.25		
260	GWB3797	62	35	14		
261	GWB3901	59.975	34.98	15.875		
262	GWB3902	74	39	39		
263	GWB3906	80	40	36/34		
264	GWB3907	70	38.1	37		
265	GWB3909	80	42	36/34		
266	GWB3916	68.02	35	33/30		
267	GWB3917	68.02	35	33/30		
268	GWB3922	68	41	40/35		
269	GWB3929	71	38	39		
270	GWB3936	68.262	34.925	20.638		
		57.15	25.4	17.462		
271	GWB3940	74	40	36		
272	GWB3945	82	43	45		
273	GWB3946	84	45	45		
274	GWB3949	73.431	45.242	19.558		
		63	38	17		
275	GWB3950	80	40	19.75		
276	GWB3951	84	45	42/40		
277	GWB3959	74	40	42		
278	GWB3961	86	47.98	42/40	√	96
279	GWB3965	62	35	40		
280	GWB3966	52	25	42		
281	GWB3970	72	35	22/17		
282	GWB3974	96	54	51		
283	GWB3979	74	40	42		
284	GWB3981	76	43	43		
285	GWB3985	88	47	57.5		
286	GWB3991	72.04	37	37	√	96
287	GWB3997	79	43	45		
288	GWB6502	68.02	35	37	√	96
289	GWB6508	55	25	53.5		
290	GWB6509	84	45	39	√	96
291	GWB6515	53.03	29	37		
292	GWB6520	74	39	39	√	88
293	GWB6530	50.005	22	17.526		
		62	35	18		
294	GWB6537	45.237	21.987	15.494		
		68	40	19		
295	GWB6544	62	30	48		
296	GWB6549	62	30	51		
297	GWB6550	72.04	35	33	√	96
298	GWB6559	90	54	50	√	96
299	GWB6561	72.04	37	37	√	88
300	GWB6570	90	55	54	√	96
301	GWB6575	86	45	44	√	96

Bearing Kits

Basic Dimension Table-G-AP to Dimension.....

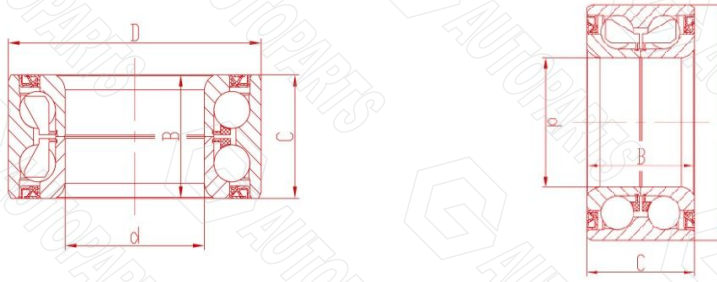

ID	G-AP Ref.	BASIC DIMENSIONS(mm)			ABS	MAGNETIC POLE
		D	d	B/C		
302	GWB6578	84	45	39	√	88
303	GWB6590	76	42	33		
304	GWB6591	76	42	39		
305	GWB6632	85.05	45	41	√	96
306	GWB6639	58	28	44		
307	GWB6640	52	25	42		
308	GWB6643	72	40	36		
309	GWB6647	84.06	45	39		
310	GWB6653	72.05	39	37	√	88
311	GWB6658	55	25	43		
312	GWB6686	52	25	22		
		73.431	41.275	19.558		
313	GWB6700	90	55	23		
		95	60	23		
314	GWB6720	78	40	40	√	96
315	GWB6721	90	55	54	√	96
316	GWB6805	79	38	45		
317	GWB6812	74	39.09	36/34		
318	GWB6820	52	25	42		
319	GWB6825	73	38	40	√	96
320	GWB6830	84	45	42/40	√	96
321	GWB6831	74	40	42		
322	GWB6845	74	40	36/34		
323	GWB6849	84	45	45		
324	GWB6856	72.05	39	37	√	88
325	GWB6878	75	40	39	√	96
326	GWB6891	84	45	41/39		
327	GWB6901	90	40	28/23		
328	GWB6923	78	42	40		
329	GWB6926	80	40	40		
330	GWB6938	87	45	41/39		
331	GWB6944	76	42	39		
332	GWB6956	76	42	39		
333	GWB6966	64	35	37	√	72
334	GWB6967	70	38	38		
335	GWB6972	80	42	45	√	88
336	GWB6975	58	28	44		
337	GWB7016	84	45	41	√	96
338	GWB7032	62	30	48		
339	GWB7408	80	43	40	√	86
340	GWB7440	91	51	44	√	96
341	GWB7446	80	42	45		
342	GWB7455	80	40	23/18		
343	GWB7469	78	43	44	√	96
344	GWB7474	50.005	21.43	17.526		
		65.088	34.925	18.034		
345	GWB7490	74	38	40	√	96
346	GWB7525	58	28	44		
347	GWB7526	72.08	40	36	√	88
348	GWB7534A	88	47	55		
349	GWB7536	80	42	45	√	88

Bearing Kits



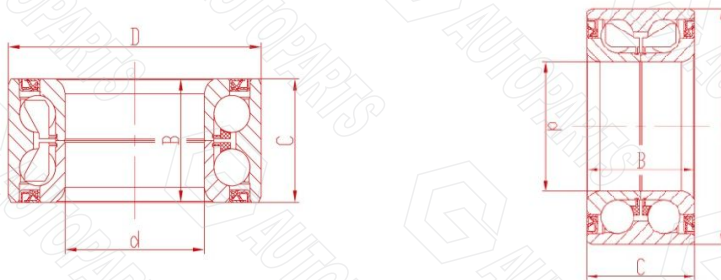









Basic Dimension Table-G-AP to Dimension.....



ID	G-AP Ref.	BASIC DIMENSIONS(mm)			ABS	MAGNETIC POLE
		D	d	B/C		
350	GWB7538	84	45	45	√	96
351	GWB7545	70	38.1	37		
352	GWB7573	52	25	37		
353	GWB7587	84	45	42/40		
354	GWB7606	52	25	42		













Bearing Kits

Contents of Complete Kits.....

ID	G-AP Ref..													
1	GWB0001	D	1		1		1						1	0.65
2	GWB0504	G	2	1				1						0.26
3	GWB0523	G	2	1				1						0.36
4	GWB0526	G	2	1				1						0.34
5	GWB0528	G	2	1				1						0.25
6	GWB0529	G	2	1				1	1	1		1		0.27
7	GWB0534	G	2	1				1						0.22
8	GWB0540	G	2	1	1						1	1		0.39
9	GWB0542	G	2	1				2						0.28
10	GWB0575	D	1		4		2							0.62
11	GWB0577	D	1		4		2							0.55
12	GWB0593	D	1		3		2							0.56
13	GWB0596	G	2	1										0.50
14	GWB0613A	D	1		3	1	2							0.65
15	GWB0652	G	2	1				1	1			1		0.25
16	GWB0663	D	1				2	1						0.53
17	GWB0687	G	2	2	1									0.50
18	GWB0736	D	1				2	1						0.63
19	GWB0739	G	2	2	1									0.48
20	GWB0740	G	2	1	1									0.52
21	GWB0741	G	2	1	1									0.50
22	GWB0749	G	2	2									1	0.53
23	GWB0754	D	1				1					1		0.62
24	GWB0756	G	2	1										0.33
25	GWB0757	D	1		1		1							0.94
26	GWB0802	G	2	1	1									0.43
27	GWB0826	G	2	1				1	1					0.48
28	GWB0827	A	1	2			1				2		1	0.77
29	GWB0828	G	2	1										0.64
30	GWB0841	G	1	2						1				0.47
31	GWB0882	D	1		1		1							0.68
32	GWB0897	G	2	2	1									0.50
33	GWB0898	G	2	2	1									0.50
34	GWB0904	G	2	1	1									0.32
35	GWB0906	D	1		1		2		1					0.61
36	GWB0909	D	1		1		1							0.99
37	GWB0910	A	2	2			1	1						0.62
38	GWB0911	G	2	1	1									0.43
39	GWB0915	D	1		1		1	1						0.88
40	GWB0918	G	2	2	1									0.67
41	GWB0919	G	2	2	1									0.67
42	GWB0926	G	2	1	2				1					0.46
43	GWB0927	G	2	1	2									0.40
44	GWB0928	G	2	1	2									0.19
45	GWB0941	G	2	1										0.35
46	GWB0944	G	2	1				1						0.24
47	GWB0947	G	2	1	1									0.26
48	GWB0949	G	2	2	1				1					0.51
49	GWB0961	H	1	1	1		1						2	0.55
50	GWB0962	D	1		1		1							0.91
51	GWB0969	H	1		1		1							0.50
52	GWB0975	H	1		1		1							0.51
53	GWB0976	H	1		1		1							0.61
54	GWB1306	D	1		1									0.49
55	GWB1314	D	1		1		1							0.96













Bearing Kits

Contents of Complete Kits.....

ID	G-AP Ref..													
56	GWB1317	D	1				1					1		0.58
57	GWB1320	D	1				1					1		0.61
58	GWB1324	G	2	2	1									0.63
59	GWB1326	D	1				1						1	0.83
60	GWB1327	D	1		1		1							0.55
61	GWB1333	G	2	1										0.26
62	GWB1340	D	1	2			1	2				1		0.68
63	GWB1342	D	1	2			1	1						0.57
64	GWB1344	D	1	1	1						1			0.63
65	GWB1345	D	1	1	1						1			0.62
66	GWB1347	D	1		1		1							0.93
67	GWB1349	H	1	1	1		1							0.60
68	GWB1352	G	2	1	1									0.40
69	GWB1353	G	2	1	2									0.41
70	GWB1355	D	1			1	2							0.90
71	GWB1356	D	1			1	2							1.11
72	GWB1358	D	1		5	1	2							0.67
73	GWB1362	D	1	1			1	1						0.92
74	GWB1363	H	1	1			1	1						0.44
75	GWB1365	H	1	2			1	1						0.67
76	GWB1366	G	2	2				1						0.55
77	GWB1367	G	2	1	1									0.34
78	GWB1369	G	2	1				1						0.46
79	GWB1370	G	1	2							1			0.28
80	GWB1374	D	1		1		1							0.78
81	GWB1383	G	2	2	1									0.47
82	GWB1393	G	2	1										1.19
83	GWB1397	G	2	2						1				0.61
84	GWB1401	D	1		1		1							0.52
85	GWB1410	D	1		2		1		1		2			0.70
86	GWB1412	D	1				1	1						0.87
87	GWB1430	G	2	1				1						0.26
88	GWB1431	G	2		1									0.40
89	GWB1432	D	1		1		1							0.67
90	GWB1433	G	2	1										0.43
91	GWB1438	D	1		1		1							0.68
92	GWB1439	D	1		1		1							0.70
93	GWB1444	G	2	2	1									0.98
94	GWB1445	G	2	1	1									0.51
95	GWB1455	G	2	1										0.38
96	GWB1459	D	1		1		1							0.61
97	GWB1465	G	2	1				1						0.43
98	GWB1466	A	1	1							1			0.73
99	GWB1467	H	1	1										1.09
100	GWB1470	G	1	1	6						2			0.55
101	GWB1473	G	2	1	2									0.57
102	GWB1480	D	1		1		2							0.82
103	GWB1488	D	1		1		1							0.84
104	GWB1491	D	1		3	1	1							0.68
105	GWB1495	D	1		1		2							0.65
106	GWB1498	G	2	1		1			1					0.40
107	GWB1499	G	2	1		4			1	1				0.68
108	GWB1905	G	1	1										0.34
109	GWB1909	G	2	1			1			1	1	1		0.81
110	GWB1911	D	1	2			1	1	1					0.66













Bearing Kits

Contents of Complete Kits.....

ID	G-AP Ref..													
111	GWB1915	G	2	1					1					0.63
112	GWB1928	G	2	2	1									0.50
113	GWB1930	A	2	1				1						0.32
114	GWB1931	A	2					1				1		0.30
115	GWB1948	D	1	1	1		1		1					1.04
116	GWB1950	D	1	1	1		1							0.80
117	GWB1951	G	2	1			1	1		1	1			0.81
118	GWB1956	G	1	1						1	2		1	0.50
119	GWB1961	G	2	1	1									0.39
120	GWB1962	G	2	1	1									0.36
121	GWB1970	D	1	2			1	1						0.86
122	GWB1971	A	1	1								1		0.46
123	GWB1973	D	1	2			1	1						0.82
124	GWB1999	D	1	2			2	2						0.73
125	GWB3201	D	1	3			2	1						0.73
126	GWB3205	G	2	2							1			0.85
127	GWB3206	G	1	2						1				0.50
128	GWB3217	G	2	1				1						0.22
129	GWB3219	H	1	2			1							0.58
130	GWB3220	A	1	2								1		0.64
131	GWB3221	H	1	2			2	1						0.90
132	GWB3224	D	1	1			1	1						0.54
133	GWB3235	H	1	2	1		1	1						0.71
134	GWB3236	H	1	3	1		1							0.76
135	GWB3237	D	1				1	2						0.97
136	GWB3245	D	1		1		1							0.76
137	GWB3246	D	1		1		1							0.82
138	GWB3255	G	2	1				1						0.22
139	GWB3256	D	1				2	1						0.49
140	GWB3257	D	1				2	1						0.60
141	GWB3272	D	1				1	1						0.66
142	GWB3308	D	1	2			1	1				1		0.69
143	GWB3309	C	1	2			1	2						0.64
144	GWB3319	G	2	1										0.85
145	GWB3325	C	1	2							1		1	1.30
146	GWB3331	G	2	2										1.00
147	GWB3332	H	1	2										1.66
148	GWB3400	D	1		1	9	1				2			1.44
149	GWB3403	D	1				2	1						0.57
150	GWB3404	G	2	2	1			1					1	1.15
151	GWB3405	G	2	1						1				0.90
152	GWB3410	D	1				2	1						0.73
153	GWB3412	D	1		1		2							0.78
154	GWB3413	D	1		1		1							0.56
155	GWB3414	D	1		1		1							0.69
156	GWB3416	D	1		1		1							0.72
157	GWB3417	G	2	2						1	1			1.04
158	GWB3420	G	2	1			1				3			0.80
159	GWB3421	G	2	2							2			0.80
160	GWB3423	D	1		1		1	1		1				0.93
161	GWB3427	D	1		4	1								1.17
162	GWB3428	G	2	2	1									1.35
163	GWB3429	G	2	1	1				1					0.58
164	GWB3430	G	2	1	1				1					0.92
165	GWB3434	G	2	1					1			2		0.60













Bearing Kits

Contents of Complete Kits.....

ID	G-AP Ref..													
166	GWB3435	H	1	1							2			1.05
167	GWB3441	D	1		1		1							0.64
168	GWB3443	D	1	2	1		1							0.97
169	GWB3446	D	1		1		1			1				0.67
170	GWB3449	D	1		1	1	1							1.02
171	GWB3450	D	1		1	1	1							1.03
172	GWB3455	D	1		1		1							0.75
173	GWB3475	G	2	1						1				1.22
174	GWB3485	G	2	2	1									0.65
175	GWB3486	D	1		1		1							0.96
176	GWB3490	D	1		1		1	1						0.94
177	GWB3492	D	1		1		1							0.99
178	GWB3495	D	1		1		2							0.99
179	GWB3496	D	1		1		1							0.62
180	GWB3499	D	1		1		1							0.65
181	GWB3500	D	1		1		1							1.21
182	GWB3501	H	1		1		1							1.20
183	GWB3504	D	1		1		1							1.15
184	GWB3518	D	1		1		1							0.99
185	GWB3519	G	2	1				1						0.25
186	GWB3520	D	1		1		1		1					0.73
187	GWB3521	H	1		1		1							0.55
188	GWB3522	D	1		1		1							1.23
189	GWB3525	H	1		1		1					1		0.48
190	GWB3527	D	1		1		1							0.87
191	GWB3528	D	1		1		1							0.61
192	GWB3530	D	1		1		1							0.69
193	GWB3531	D	1		1		1							0.69
194	GWB3532	D	1	1	1		2		1				1	0.52
195	GWB3535	D	1			1								0.84
196	GWB3538	D	1		1		1							0.66
197	GWB3539	D	1		1		1		1					0.78
198	GWB3543	D	1		1		2							0.79
199	GWB3551	H	1											0.98
200	GWB3552	H	1											1.40
201	GWB3554A	D	1		1		1							0.67
202	GWB3556	H	1	1	1		1				1			0.47
203	GWB3565	G	2	1										0.47
204	GWB3571	D	1		1		1							0.50
205	GWB3572	D	1				1		1					0.39
206	GWB3574	D	1		1		1							1.18
207	GWB3575	D	1		1		1							0.75
208	GWB3577	D	1		1		1							0.55
209	GWB3581	D	1		1		1							0.69
210	GWB3584	D	1		1		1							0.86
211	GWB3596	D	1		1		1							0.73
212	GWB3598	D	1		1		1							0.80
213	GWB3599	D	1		1		1							0.98
214	GWB3601	D	1		1		1		1					0.55
215	GWB3603	D	1		1		1							0.88
216	GWB3605	D	1			1								0.98
217	GWB3607	D	1			1	1							0.86
218	GWB3608	D	1		1					1				1.00
219	GWB3613	D	1		1		1							1.02
220	GWB3614	H	1		1		1		1					1.26













Bearing Kits

Contents of Complete Kits.....

ID	G-AP Ref..													
221	GWB3615	D	1		1									1.01
222	GWB3616	D	1		1									1.00
223	GWB3617	H	1		1		1							0.91
224	GWB3618	D	1		1				1					1.02
225	GWB3625	D	1		1		1							0.89
226	GWB3628	D	1		1		1							1.15
227	GWB3633	D	1		1		1							0.93
228	GWB3637	D	1		1		1					1		0.72
229	GWB3638	D	1		1		1			1				0.86
230	GWB3639	D	1		1		1		1					0.65
231	GWB3640	H	1		1		1		1					1.21
232	GWB3641	H	1		1		1		1					1.65
233	GWB3642	H	1		1		1							1.31
234	GWB3645	D	1		1		1							1.60
235	GWB3647	D	1		1									0.84
236	GWB3648	D	1		1							1		1.13
237	GWB3649	D	1		1		1							1.02
238	GWB3657	D	1		1		1							0.67
239	GWB3658	H	1	1	1		1		1			1	1	0.47
240	GWB3664		1									1		1.01
241	GWB3666	G	2	1	1									0.32
242	GWB3668	D	1		1		1							0.99
243	GWB3676	H	1		1		1		1					0.66
244	GWB3678	D	1		1		1							0.70
245	GWB3679	H	1		1		1							1.15
246	GWB3680	H	1		1		1		1					0.77
247	GWB3682	D	1		1		1							0.70
248	GWB3683	D	1		1		1							0.99
249	GWB3684	D	1		1		1							0.61
250	GWB3688	D	1		1		1							1.09
251	GWB3689		1		1		1							1.14
252	GWB3690	H	1		1		1							1.59
253	GWB3692	D	1		1		1					1		0.96
254	GWB3703	D	1	2			1	2						0.62
255	GWB3713	C	1	2	1		1							0.43
256	GWB3716	A	2		1									0.25
257	GWB3717	A	2		1									0.26
258	GWB3718	D	1	2	1		1							0.65
259	GWB3727	G	2	2							1			0.82
260	GWB3729	D	1	2			1	1					1	0.66
261	GWB3730	D	1	2			1	1					1	0.66
262	GWB3740	A	1	3			1				2	1		0.77
263	GWB3765	H	1	2			1				3			1.06
264	GWB3775	G	1	2							1		1	0.62
265	GWB3785	D	1		1		1	1						0.72
266	GWB3786	D	1		1		2	1						0.57
267	GWB3796	G	2	1					1					0.31
268	GWB3797	A	2	1	1									0.38
269	GWB3901	G	2	2	1									0.53
270	GWB3902	D	1		1		1							0.77
271	GWB3906	D	1				1							0.81
272	GWB3907	D	1				1	1						0.60
273	GWB3909	D	1				1							0.77
274	GWB3916	D	1	2			1	1						0.57
275	GWB3917	D	1	2			1	1						0.58













Bearing Kits



Contents of Complete Kits.....



ID	G-AP Ref..													
276	GWB3922	H	1	2			2							0.61
277	GWB3929	D	1		1		1							0.70
278	GWB3936	G	2	2										0.60
279	GWB3940	D	1	2			1	1						0.68
280	GWB3945	D	1		1		1							1.03
281	GWB3946	D	1		1		1							1.11
282	GWB3949	G	2	2										0.57
283	GWB3950	G	1	2										0.50
284	GWB3951	D	1		1		1			1	1			1.00
285	GWB3959	D	1		1		1							0.77
286	GWB3961	D	1		1		1							1.02
287	GWB3965	D	1		1		1							0.50
288	GWB3966	C	1	1			1							0.45
289	GWB3967	A	1	1									1	0.30
290	GWB3968		1	1									1	0.50
291	GWB3970	A	1	1									1	0.59
292	GWB3974	H	1	2			1	1						1.59
293	GWB3979	D	1				1	1						0.71
294	GWB3981	D	1				2	1						0.76
295	GWB3985	H	1				1	1						1.53
296	GWB3991	D	1				1	1						0.65
297	GWB3997	D	1				1	1						0.86
298	GWB5549	H	1			12					1			14.00
299	GWB6502	D	1		1		1							0.61
300	GWB6508	H	1		1		1		1					0.70
301	GWB6509	D	1		1		1		1					1.03
302	GWB6515	H	1		1		1							0.43
303	GWB6520	D	1		1		1							0.79
304	GWB6530	G	2	1		1						1		0.47
305	GWB6537	G	2	1		1						1		0.49
306	GWB6540		1		2		2							0.75
307	GWB6544	H	1		1		1					1		0.80
308	GWB6549	H	1		1		1		1					0.79
309	GWB6550	D	1		1		2							0.73
310	GWB6559	D	1		1		1							1.26
311	GWB6561	D	1		1		1		1					0.71
312	GWB6570	H	1		1		1							1.52
313	GWB6575	D	1		1		1							1.12
314	GWB6578	D	1		1		1							0.96
315	GWB6590	D	1					1						0.59
316	GWB6591	D	1					1						0.69
317	GWB6632	D	1		1		1							1.03
318	GWB6636	D	1		1		1							0.92
319	GWB6639	D	1		1		1		1					0.57
320	GWB6640	D	1		1		1		1					0.47
321	GWB6642	D	1		1		1		1					0.47
322	GWB6643	D	1		1		1							0.64
323	GWB6646		1			1	1		1					1.29
324	GWB6647	D	1			1	1		1					1.13
325	GWB6653	D	1		1		1							0.68
326	GWB6658	H	1		1		1		1					0.61
327	GWB6686	G	2	1	1									0.61
328	GWB6700	G	2	1						1				1.20
329	GWB6720	D	1				1	1						0.79
330	GWB6721	D	1		1		1							1.37



Bearing Kits



Contents of Complete Kits.....



ID	G-AP Ref..													
331	GWB6722		1		1		1		1					1.48
332	GWB6726		1		1		1		1					0.54
333	GWB6731		1		1		1							0.78
334	GWB6742	G	2											1.17
335	GWB6774		1		1		1							0.78
336	GWB6799		1		1		1		1					0.84
337	GWB6805	D	1		1		1							1.10
338	GWB6812	D	1				1	1						0.64
339	GWB6819		1		1		1							0.67
340	GWB6820	D	1		1		1							0.43
341	GWB6825	D	1		1		1							0.74
342	GWB6830	D	1		1		1							1.01
343	GWB6831	D	1		1		1							0.81
344	GWB6845	D	1	2	1		1							0.72
345	GWB6849	D	1		1		1							1.08
346	GWB6856	D	1		1									0.67
347	GWB6878	D	1		1		1							0.77
348	GWB6891	D	1		1		1	1						1.03
349	GWB6901	A	1	2			1				3		2	0.88
350	GWB6913		1	2	1		1							0.93
351	GWB6923	D	1				1	1						0.79
352	GWB6926	D	1		1		1							0.95
353	GWB6931		1		1		1							0.50
354	GWB6938	D	1				1	1						1.04
355	GWB6944	H	1	1	1		1							0.85
356	GWB6956	D	1				1	1						0.76
357	GWB6966	D	1				1	1						0.48
358	GWB6967	D	1		1		1	1						0.67
359	GWB6972	D	1		1		1							1.02
360	GWB6975	D	1		1		1							0.58
361	GWB7016	D	1		1		1							0.96
362	GWB7032	H	1		1		1		1					0.83
363	GWB7408	D	1				1	1						0.85
364	GWB7440	D	1		1		1							1.21
365	GWB7446	D	1		1		1							0.97
366	GWB7455	A	1	1						1			1	0.77
367	GWB7456		1		1		1						1	0.48
368	GWB7458		1		1		1							0.43
369	GWB7469	D	1		2		1							0.98
370	GWB7474	G	2	1				1						0.47
371	GWB7490	D	1		1		1							0.77
372	GWB7525	D	1		1		1							0.56
373	GWB7526	D	1		1		1							0.68
374	GWB7534A	H	1	1	1		1							1.60
375	GWB7536	D	1		1		1							1.02
376	GWB7537		1		1		1							1.02
377	GWB7538	D	1		1		1							1.17
378	GWB7545	D	1				1	1						0.55
379	GWB7549		1		1		1							0.68
380	GWB7573	H	1		1		1							0.49
381	GWB7587	D	1		1		1							1.02
382	GWB7606	D	1	1	1		1							0.48



	 YEAR		F	R	G-AP Ref.	KIT
ABARTH						
500C (312)						
1.4 (99 kW)	2011.01-	Convertible Engine 312 A1.000	•		GHA425008	
ALFA ROMEO						
145 (930)						
1.4 i.e. (66 kW)	1994.07-1996.12	Hatchback Engine AR33501	•		GHA425008	
	1994.07-1996.12	Hatchback Engine AR33501	•		GWB1439	
	1994.07-1996.12	Hatchback Engine AR33501		o	GHA230028	K
	1994.07-1996.12	Hatchback Engine AR33501		o	GHA230090	K
	1994.07-1996.12	Hatchback Engine AR33501 Without ABS		o	GHA230044	K
1.4 i.e. 16V T.S. (76 kW)	1996.12-2001.01	Hatchback Engine AR33503/AR38501	•		GHA425008	
	1996.12-2001.01	Hatchback Engine AR33503/AR38501	•		GWB1439	
	1996.12-2001.01	Hatchback Engine AR33503/AR38501	•		GWB3539	
	1996.12-2001.01	Hatchback Engine AR33503/AR38501	•		GWB6540	
	1996.12-2001.01	Hatchback Engine AR33503/AR38501		o	GHA230090	K
	1996.12-2001.01	Hatchback Engine AR33503/AR38501 With ABS		o	GHA230046	K
	1996.12-2001.01	Hatchback Engine AR33503/AR38501 Without ABS		o	GHA230044	K
1.6 16V T.S. (82 kW)	1997.09-2000.12	Hatchback Engine AR32102	•		GHA425008	
	1997.09-2000.12	Hatchback Engine AR32102	•		GWB1439	
	1997.09-2000.12	Hatchback Engine AR32102	•		GWB3539	
	1997.09-2000.12	Hatchback Engine AR32102	•		GWB6540	
	1997.09-2000.12	Hatchback Engine AR32102		o	GHA230090	K
	1997.09-2000.12	Hatchback Engine AR32102 With ABS		o	GHA230046	K
	1997.09-2000.12	Hatchback Engine AR32102 Without ABS		o	GHA230044	K
1.6 i.e. (76 kW)	1994.10-1996.12	Hatchback Engine AR33201	•		GHA425008	
	1994.10-1996.12	Hatchback Engine AR33201	•		GWB1439	
	1994.10-1996.12	Hatchback Engine AR33201		o	GHA230028	K
	1994.10-1996.12	Hatchback Engine AR33201		o	GHA230090	K
	1994.10-1996.12	Hatchback Engine AR33201 Without ABS		o	GHA230044	K
1.6 i.e. 16V T.S. (88 kW)	1996.12-2001.01	Hatchback Engine AR38201/AR67601	•		GHA425008	
	1996.12-2001.01	Hatchback Engine AR38201/AR67601	•		GWB1439	
	1996.12-2001.01	Hatchback Engine AR38201/AR67601	•		GWB3539	
	1996.12-2001.01	Hatchback Engine AR38201/AR67601	•		GWB6540	
	1996.12-2001.01	Hatchback Engine AR38201/AR67601		o	GHA230090	K
	1996.12-2001.01	Hatchback Engine AR38201/AR67601 With ABS		o	GHA230046	K
	1996.12-2001.01	Hatchback Engine AR38201/AR67601 Without ABS		o	GHA230044	K
1.7 i.e. 16V (95 kW)	1994.10-1996.12	Hatchback Engine AR33401	•		GHA425008	
	1994.10-1996.12	Hatchback Engine AR33401	•		GWB1439	
	1994.10-1996.12	Hatchback Engine AR33401		o	GHA230028	K
	1994.10-1996.12	Hatchback Engine AR33401		o	GHA230090	K
	1994.10-1996.12	Hatchback Engine AR33401 Without ABS		o	GHA230044	K
1.8 i.e. 16V (106 kW)	1998.03-2001.01	Hatchback Engine AR32201	•		GHA425008	
	1998.03-2001.01	Hatchback Engine AR32201	•		GWB1439	
	1998.03-2001.01	Hatchback Engine AR32201	•		GWB3539	
	1998.03-2001.01	Hatchback Engine AR32201	•		GWB6540	
	1998.03-2001.01	Hatchback Engine AR32201		o	GHA230090	K
	1998.03-2001.01	Hatchback Engine AR32201 With ABS		o	GHA230046	K
	1998.03-2001.01	Hatchback Engine AR32201 Without ABS		o	GHA230044	K
1.8 i.e. 16V T.S. (103 kW)	1996.12-1998.12	Hatchback Engine AR38401/AR67106	•		GHA425008	
	1996.12-1998.12	Hatchback Engine AR38401/AR67106	•		GWB1439	
	1996.12-1998.12	Hatchback Engine AR38401/AR67106	•		GWB3539	
	1996.12-1998.12	Hatchback Engine AR38401/AR67106	•		GWB6540	
	1996.12-1998.12	Hatchback Engine AR38401/AR67106		o	GHA230090	K
	1996.12-1998.12	Hatchback Engine AR38401/AR67106 With ABS		o	GHA230046	K
	1996.12-1998.12	Hatchback Engine AR38401/AR67106 Without ABS		o	GHA230044	K
1.9 JTD (77 kW)	1999.02-2001.01	Hatchback Engine AR32302	•		GWB1488	
	1999.02-2001.01	Hatchback Engine AR32302 With ABS		o	GHA230046	K
	1999.02-2001.01	Hatchback Engine AR32302 Without ABS		o	GHA230044	K
1.9 TD (66 kW)	1994.10-1999.02	Hatchback Engine AR33601/AR67501	•		GHA425008	
	1994.10-1999.02	Hatchback Engine AR33601/AR67501	•		GWB1439	
	1994.10-1999.02	Hatchback Engine AR33601/AR67501	•		GWB3539	
	1994.10-1999.02	Hatchback Engine AR33601/AR67501	•		GWB6540	
	1994.10-1999.02	Hatchback Engine AR33601/AR67501		o	GHA230028	K
	1994.10-1999.02	Hatchback Engine AR33601/AR67501		o	GHA230090	K
	1994.10-1999.02	Hatchback Engine AR33601/AR67501 With ABS		o	GHA230046	K



	 YEAR		F	R	G-AP Ref.	KIT
ALFA ROMEO						
145 (930)						
1.9 TD (66 kW)	1994.10-1999.02	Hatchback Engine AR33601/AR67501 Without ABS		o	GHA230044	K
2.0 16V QuaDrifoglio (114 kW)	1998.03-2001.01	Hatchback Engine AR32301	•		GHA425008	
	1998.03-2001.01	Hatchback Engine AR32301	•		GWB1439	
	1998.03-2001.01	Hatchback Engine AR32301	•		GWB3539	
	1998.03-2001.01	Hatchback Engine AR32301	•		GWB6540	
	1998.03-2001.01	Hatchback Engine AR32301		o	GHA230090	K
	1998.03-2001.01	Hatchback Engine AR32301 With ABS		o	GHA230046	K
	1998.03-2001.01	Hatchback Engine AR32301 Without ABS		o	GHA230044	K
2.0 16V T.S. (110 kW)	1995.10-2001.01	Hatchback Engine AR67204	•		GHA425008	
	1995.10-2001.01	Hatchback Engine AR67204	•		GWB1439	
	1995.10-2001.01	Hatchback Engine AR67204	•		GWB3539	
	1995.10-2001.01	Hatchback Engine AR67204	•		GWB6540	
	1995.10-2001.01	Hatchback Engine AR67204		o	GHA230028	K
	1995.10-2001.01	Hatchback Engine AR67204		o	GHA230090	K
	1995.10-2001.01	Hatchback Engine AR67204 With ABS		o	GHA230046	K
	1995.10-2001.01	Hatchback Engine AR67204 Without ABS		o	GHA230044	K
146 (930)						
1.4 i.e. (66 kW)	1994.12-1996.12	Hatchback Engine AR33501	•		GHA425008	
	1994.12-1996.12	Hatchback Engine AR33501	•		GWB1439	
	1994.12-1996.12	Hatchback Engine AR33501		o	GHA230028	K
	1994.12-1996.12	Hatchback Engine AR33501		o	GHA230090	K
	1994.12-1996.12	Hatchback Engine AR33501 Without ABS		o	GHA230044	K
1.4 i.e. 16V T.S. (76 kW)	1996.11-2001.01	Hatchback Engine AR33503/AR38501	•		GHA425008	
	1996.11-2001.01	Hatchback Engine AR33503/AR38501	•		GWB1439	
	1996.11-2001.01	Hatchback Engine AR33503/AR38501	•		GWB3539	
	1996.11-2001.01	Hatchback Engine AR33503/AR38501	•		GWB6540	
	1996.11-2001.01	Hatchback Engine AR33503/AR38501		o	GHA230090	K
	1996.11-2001.01	Hatchback Engine AR33503/AR38501 With ABS		o	GHA230046	K
	1996.11-2001.01	Hatchback Engine AR33503/AR38501 Without ABS		o	GHA230044	K
1.6 16V T.S. (82 kW)	1997.09-2000.12	Hatchback Engine AR32102	•		GHA425008	
	1997.09-2000.12	Hatchback Engine AR32102	•		GWB1439	
	1997.09-2000.12	Hatchback Engine AR32102	•		GWB3539	
	1997.09-2000.12	Hatchback Engine AR32102	•		GWB6540	
	1997.09-2000.12	Hatchback Engine AR32102		o	GHA230090	K
	1997.09-2000.12	Hatchback Engine AR32102 With ABS		o	GHA230046	K
	1997.09-2000.12	Hatchback Engine AR32102 Without ABS		o	GHA230044	K
	1.6 i.e. (76 kW)	1994.12-1996.12	Hatchback Engine AR33201	•		GHA425008
1994.12-1996.12		Hatchback Engine AR33201	•		GWB1439	
1994.12-1996.12		Hatchback Engine AR33201		o	GHA230028	K
1994.12-1996.12		Hatchback Engine AR33201		o	GHA230090	K
1994.12-1996.12		Hatchback Engine AR33201 Without ABS		o	GHA230044	K
1.6 i.e. 16V T.S. (88 kW)	1996.11-2001.01	Hatchback Engine AR38201/AR67601	•		GHA425008	
	1996.11-2001.01	Hatchback Engine AR38201/AR67601	•		GWB1439	
	1996.11-2001.01	Hatchback Engine AR38201/AR67601	•		GWB3539	
	1996.11-2001.01	Hatchback Engine AR38201/AR67601	•		GWB6540	
	1996.11-2001.01	Hatchback Engine AR38201/AR67601		o	GHA230090	K
	1996.11-2001.01	Hatchback Engine AR38201/AR67601 With ABS		o	GHA230046	K
	1996.11-2001.01	Hatchback Engine AR38201/AR67601 Without ABS		o	GHA230044	K
1.7 i.e. 16V (95 kW)	1994.12-1996.12	Hatchback Engine AR33401	•		GHA425008	
	1994.12-1996.12	Hatchback Engine AR33401	•		GWB1439	
	1994.12-1996.12	Hatchback Engine AR33401		o	GHA230028	K
	1994.12-1996.12	Hatchback Engine AR33401		o	GHA230090	K
	1994.12-1996.12	Hatchback Engine AR33401 Without ABS		o	GHA230044	K
1.8 i.e. 16V T.S. (103 kW)	1996.11-2001.01	Hatchback Engine AR38401/AR67106	•		GHA425008	
	1996.11-2001.01	Hatchback Engine AR38401/AR67106	•		GWB1439	
	1996.11-2001.01	Hatchback Engine AR38401/AR67106	•		GWB3539	
	1996.11-2001.01	Hatchback Engine AR38401/AR67106	•		GWB6540	
	1996.11-2001.01	Hatchback Engine AR38401/AR67106		o	GHA230090	K
	1996.11-2001.01	Hatchback Engine AR38401/AR67106 With ABS		o	GHA230046	K
	1996.11-2001.01	Hatchback Engine AR38401/AR67106 Without ABS		o	GHA230044	K
1.8 i.e. 16V T.S. (106 kW)	1998.03-2001.01	Hatchback Engine AR32201	•		GHA425008	
	1998.03-2001.01	Hatchback Engine AR32201	•		GWB1439	
	1998.03-2001.01	Hatchback Engine AR32201	•		GWB3539	
	1998.03-2001.01	Hatchback Engine AR32201	•		GWB6540	



	 YEAR		F	R	G-AP Ref.	KIT
ALFA ROMEO						
146 (930)						
1.8 i.e. 16V T.S. (106 kW)	1998.03-2001.01	Hatchback Engine AR32201		o	GHA230090	K
	1998.03-2001.01	Hatchback Engine AR32201 With ABS		o	GHA230046	K
	1998.03-2001.01	Hatchback Engine AR32201 Without ABS		o	GHA230044	K
1.9 JTD (77 kW)	1999.02-2001.01	Hatchback Engine AR32302	•		GWB1488	
	1999.02-2001.01	Hatchback Engine AR32302 With ABS		o	GHA230046	K
	1999.02-2001.01	Hatchback Engine AR32302 Without ABS		o	GHA230044	K
1.9 TD (66 kW)	1994.12-1999.02	Hatchback Engine AR33601/AR67501	•		GHA425008	
	1994.12-1999.02	Hatchback Engine AR33601/AR67501	•		GWB1439	
	1994.12-1999.02	Hatchback Engine AR33601/AR67501	•		GWB3539	
	1994.12-1999.02	Hatchback Engine AR33601/AR67501	•		GWB6540	
	1994.12-1999.02	Hatchback Engine AR33601/AR67501		o	GHA230028	K
	1994.12-1999.02	Hatchback Engine AR33601/AR67501		o	GHA230090	K
	1994.12-1999.02	Hatchback Engine AR33601/AR67501 With ABS		o	GHA230046	K
	1994.12-1999.02	Hatchback Engine AR33601/AR67501 Without ABS		o	GHA230044	K
	2.0 16V QuaDrifoglio (114 kW)	1998.03-2001.01	Hatchback Engine AR32301	•		GHA425008
1998.03-2001.01		Hatchback Engine AR32301	•		GWB1439	
1998.03-2001.01		Hatchback Engine AR32301	•		GWB3539	
1998.03-2001.01		Hatchback Engine AR32301	•		GWB6540	
1998.03-2001.01		Hatchback Engine AR32301		o	GHA230090	K
1998.03-2001.01		Hatchback Engine AR32301 With ABS		o	GHA230046	K
1998.03-2001.01		Hatchback Engine AR32301 Without ABS		o	GHA230044	K
2.0 16V T.S. (110 kW)	1995.10-2001.01	Hatchback Engine AR67204	•		GHA425008	
	1995.10-2001.01	Hatchback Engine AR67204	•		GWB1439	
	1995.10-2001.01	Hatchback Engine AR67204	•		GWB3539	
	1995.10-2001.01	Hatchback Engine AR67204	•		GWB6540	
	1995.10-2001.01	Hatchback Engine AR67204		o	GHA230028	K
	1995.10-2001.01	Hatchback Engine AR67204		o	GHA230090	K
	1995.10-2001.01	Hatchback Engine AR67204 With ABS		o	GHA230046	K
	1995.10-2001.01	Hatchback Engine AR67204 Without ABS		o	GHA230044	K
147 (937)						
1.6 16V T.SPARK (88 kW)	2001.01-2010.03	Hatchback Engine AR32104	•		GHA237018	K
	2001.01-2010.03	Hatchback Engine AR32104		o	GHA230118	K
	2001.01-2010.03	Hatchback Engine AR32104		o	GHA235018	K
1.6 16V T.SPARK ECO (77 kW)	2001.01-2010.03	Hatchback Engine AR37203	•		GHA237018	K
	2001.01-2010.03	Hatchback Engine AR37203		o	GHA230118	K
	2001.01-2010.03	Hatchback Engine AR37203		o	GHA235018	K
1.9 JTD (74 kW)	2003.06-2010.03	Hatchback Engine 182B9.000	•		GHA237018	K
	2003.06-2010.03	Hatchback Engine 182B9.000		o	GHA230118	K
	2003.06-2010.03	Hatchback Engine 182B9.000		o	GHA235018	K
1.9 JTD (85 kW)	2001.04-2010.03	Hatchback Engine 937A2.000	•		GHA237018	K
	2001.04-2010.03	Hatchback Engine 937A2.000		o	GHA230118	K
	2001.04-2010.03	Hatchback Engine 937A2.000		o	GHA235018	K
1.9 JTD 16V (100 kW)	2004.10-2010.03	Hatchback Engine 192B1.000	•		GHA237018	K
	2004.10-2010.03	Hatchback Engine 192B1.000		o	GHA230118	K
1.9 JTD 16V (103 kW)	2003.07-2005.02	Hatchback Engine 192A5.000	•		GHA237018	K
	2003.07-2005.02	Hatchback Engine 192A5.000		o	GHA230118	K
	2003.07-2005.02	Hatchback Engine 192A5.000		o	GHA235018	K
1.9 JTD 16V (93 kW)	2003.09-2004.09	Hatchback Engine 937A4.000	•		GHA237018	K
	2003.09-2004.09	Hatchback Engine 937A4.000		o	GHA235018	K
1.9 JTDM (85 kW)	2004.10-2010.03	Hatchback Engine 939A7.000	•		GHA237018	K
	2004.10-2010.03	Hatchback Engine 939A7.000		o	GHA230118	K
1.9 JTDM 16V (110 kW)	2005.03-2007.09	Hatchback Engine 937A5.000	•		GHA237018	K
	2005.03-2007.09	Hatchback Engine 937A5.000		o	GHA230118	K
1.9 JTDM 16V (125 kW)	2008.06-2010.03	Hatchback Engine 937A6.000	•		GHA237018	K
	2008.06-2010.03	Hatchback Engine 937A6.000		o	GHA230118	K
1.9 JTDM 8V (88 kW)	2006.02-2010.03	Hatchback Engine 937A3.000	•		GHA237018	K
	2006.02-2010.03	Hatchback Engine 937A3.000		o	GHA230118	K
2.0 (121 kW)	2002.07-2005.05	Hatchback Engine 937 A1.000	•		GHA237018	K
	2002.07-2005.05	Hatchback Engine 937 A1.000		o	GHA230118	K
	2002.07-2005.05	Hatchback Engine 937 A1.000		o	GHA235018	K
2.0 16V T.SPARK (110 kW)	2001.01-2010.03	Hatchback Engine AR32310	•		GHA237018	K
	2001.01-2010.03	Hatchback Engine AR32310		o	GHA230118	K
	2001.01-2010.03	Hatchback Engine AR32310		o	GHA235018	K
3.2 GTA (184 kW)	2003.02-2010.03	Hatchback Engine 932A.000	•		GHA242009	K



	 YEAR		F	R	G-AP Ref.	KIT
ALFA ROMEO						
147 (937)						
3.2 GTA (184 kW)	2003.02-2010.03	Hatchback Engine 932A.000	•		GHA425028	
	2003.02-2010.03	Hatchback Engine 932A.000		○	GHA230118	K
	2003.02-2010.03	Hatchback Engine 932A.000		○	GHA235018	K
155 (167)						
1.6 16V T.S. (88 kW)	1996.05-1997.12	Saloon Engine AR67601	•		GHA425008	
	1996.05-1997.12	Saloon Engine AR67601	•		GWB1439	
	1996.05-1997.12	Saloon Engine AR67601		○	GHA230028	K
	1996.05-1997.12	Saloon Engine AR67601 Without ABS		○	GHA230044	K
1.7 T.S. (83 kW)	1993.04-1996.04	Saloon Engine AR67103	•		GHA425008	
1.7 T.S. (83 kW)	1993.04-1996.04	Saloon Engine AR67103	•		GWB1439	
	1993.04-1996.04	Saloon Engine AR67103		○	GHA230028	K
	1993.04-1996.04	Saloon Engine AR67103 Without ABS		○	GHA230044	K
1.7 T.S. (85 kW)	1993.04-1996.04	Saloon Engine AR67105	•		GHA425008	
	1993.04-1996.04	Saloon Engine AR67105	•		GWB1439	
	1993.04-1996.04	Saloon Engine AR67105		○	GHA230028	K
	1993.04-1996.04	Saloon Engine AR67105 Without ABS		○	GHA230044	K
1.7 T.S. 16V (103 kW)	1996.05-1997.12	Saloon Engine AR67106	•		GHA425008	
	1996.05-1997.12	Saloon Engine AR67106	•		GWB1439	
	1996.05-1997.12	Saloon Engine AR67106		○	GHA230028	K
	1996.05-1997.12	Saloon Engine AR67106 Without ABS		○	GHA230044	K
1.8 T.S. (77 kW)	1992.02-1997.12	Saloon Engine AR67402	•		GHA425008	
	1992.02-1997.12	Saloon Engine AR67402	•		GWB1439	
	1992.02-1997.12	Saloon Engine AR67402		○	GHA230028	K
	1992.02-1997.12	Saloon Engine AR67402 Without ABS		○	GHA230044	K
1.8 T.S. (95 kW)	1992.02-1993.06	Saloon Engine AR67101	•		GHA425008	
	1992.02-1993.06	Saloon Engine AR67101	•		GWB1439	
	1992.02-1993.06	Saloon Engine AR67101		○	GHA230028	K
	1992.02-1993.06	Saloon Engine AR67101 Without ABS		○	GHA230044	K
1.8 T.S. Sport (93 kW)	1992.01-1996.12	Saloon Engine AR67101/AR67102	•		GHA425008	
	1992.01-1996.12	Saloon Engine AR67101/AR67102	•		GWB1439	
	1992.01-1996.12	Saloon Engine AR67101/AR67102		○	GHA230028	K
	1992.01-1996.12	Saloon Engine AR67101/AR67102 Without ABS		○	GHA230044	K
1.9 TD (66 kW)	1993.04-1997.12	Saloon Engine AR67501	•		GHA425008	
	1993.04-1997.12	Saloon Engine AR67501	•		GWB1439	
	1993.04-1997.12	Saloon Engine AR67501		○	GHA230028	K
	1993.04-1997.12	Saloon Engine AR67501 Without ABS		○	GHA230044	K
2.0 16V Turbo Q4 (137 kW)	1992.01-1997.12	Saloon Engine AR67203	•		GWB1488	
	1992.01-1997.12	Saloon Engine AR67203		○	GHA425008	
2.0 16V Turbo Q4 (140 kW)	1992.01-1997.12	Saloon Engine AR67203	•		GWB1488	
	1992.01-1997.12	Saloon Engine AR67203		○	GHA425008	
2.0 T.S. (104 kW)	1992.02-1995.02	Saloon Engine AR67202	•		GHA425008	
	1992.02-1995.02	Saloon Engine AR67202	•		GWB1439	
	1992.02-1995.02	Saloon Engine AR67202		○	GHA230028	K
	1992.02-1995.02	Saloon Engine AR67202 Without ABS		○	GHA230044	K
2.0 T.S. (106 kW)	1992.02-1993.04	Saloon Engine AR67201	•		GHA425008	
	1992.02-1993.04	Saloon Engine AR67201	•		GWB1439	
	1992.02-1993.04	Saloon Engine AR67201		○	GHA230028	K
	1992.02-1993.04	Saloon Engine AR67201 Without ABS		○	GHA230044	K
2.0 T.S. 16V (110 kW)	1995.03-1997.12	Saloon Engine AR67204	•		GHA425008	
	1995.03-1997.12	Saloon Engine AR67204	•		GWB1439	
	1995.03-1997.12	Saloon Engine AR67204		○	GHA230028	K
	1995.03-1997.12	Saloon Engine AR67204 Without ABS		○	GHA230044	K
2.5 TD (92 kW)	1993.04-1997.12	Saloon Engine VM07B/VM31B	•		GWB1488	
	1993.04-1997.12	Saloon Engine VM07B/VM31B		○	GHA230028	K
	1993.04-1997.12	Saloon Engine VM07B/VM31B Without ABS		○	GHA230044	K
2.5 V6 (120 kW)	1992.10-1997.12	Saloon Engine AR67302/AR67303	•		GWB1488	
	1992.10-1997.12	Saloon Engine AR67302/AR67303		○	GHA230028	K
	1992.10-1997.12	Saloon Engine AR67302/AR67303 Without ABS		○	GHA230044	K
2.5 V6 (121 kW)	1992.02-1996.09	Saloon Engine AR67301	•		GWB1488	
	1992.02-1996.09	Saloon Engine AR67301		○	GHA230028	K
	1992.02-1996.09	Saloon Engine AR67301 Without ABS		○	GHA230044	K
156 (932)						
1.6 16V T.SPARK (82 kW)	1997.09-2005.09	Estate Engine AR32102	•		GHA242009	K
	1997.09-2005.09	Estate Engine AR32102		○	GHA230118	K



	 YEAR		F	R	G-AP Ref.	KIT
ALFA ROMEO						
156 (932)						
1.6 16V T.SPARK (82 kW)	1997.09-2005.09	Estate Engine AR32102		o	GHA235018	K
	1997.09-2005.09	Saloon Engine AR32102	•		GHA242009	K
	1997.09-2005.09	Saloon Engine AR32102		o	GHA230118	K
	1997.09-2005.09	Saloon Engine AR32102		o	GHA235018	K
1.6 16V T.SPARK (88 kW)	1997.09-2005.09	Saloon Engine AR32104/AR67601	•		GHA242009	K
	1997.09-2005.09	Saloon Engine AR32104/AR67601		o	GHA230118	K
	1997.09-2005.09	Saloon Engine AR32104/AR67601		o	GHA235018	K
1.6 16V T.SPARK. (88 kW)	2000.05-2006.05	Estate Engine AR32104/AR67601	•		GHA242009	K
	2000.05-2006.05	Estate Engine AR32104/AR67601		o	GHA230118	K
	2000.05-2006.05	Estate Engine AR32104/AR67601		o	GHA235018	K
1.8 16V T.SPARK (103 kW)	2000.10-2005.09	Saloon Engine AR32205	•		GHA242009	K
	2000.10-2005.09	Saloon Engine AR32205		o	GHA230118	K
1.8 16V T.SPARK (103 kW)	2000.10-2005.09	Saloon Engine AR32205		o	GHA235018	K
	2000.10-2006.05	Estate Engine AR32205	•		GHA242009	K
	2000.10-2006.05	Estate Engine AR32205		o	GHA230118	K
	2000.10-2006.05	Estate Engine AR32205		o	GHA235018	K
1.8 16V T.SPARK (106 kW)	1997.09-2000.10	Saloon Engine AR32201	•		GHA242009	K
	1997.09-2000.10	Saloon Engine AR32201		o	GHA235018	K
	2000.06-2005.02	Estate Engine AR32201	•		GHA242009	K
	2000.06-2005.02	Estate Engine AR32201		o	GHA235018	K
1.9 JTD (100 kW)	2002.11-2004.11	Estate Engine 192B1.000	•		GHA242009	K
	2002.11-2004.11	Estate Engine 192B1.000		o	GHA230118	K
	2002.11-2004.11	Estate Engine 192B1.000		o	GHA235018	K
	2002.11-2004.11	Saloon Engine 192B1.000	•		GHA242009	K
	2002.11-2004.11	Saloon Engine 192B1.000		o	GHA235018	K
1.9 JTD (110 kW)	2004.07-2005.09	Saloon Engine 937A5.000	•		GHA242009	K
	2004.07-2005.09	Saloon Engine 937A5.000		o	GHA235018	K
	2005.03-2006.05	Estate Engine 937A5.000	•		GHA242009	K
	2005.03-2006.05	Estate Engine 937A5.000		o	GHA230118	K
1.9 JTD (77 kW)	1997.09-2000.10	Saloon Engine AR32302	•		GHA242009	K
	1997.09-2000.10	Saloon Engine AR32302		o	GHA235018	K
	2000.05-2000.10	Estate Engine AR32302	•		GHA242009	K
	2000.05-2000.10	Estate Engine AR32302		o	GHA235018	K
1.9 JTD (81 kW)	2000.10-2001.05	Estate Engine AR37101	•		GHA242009	K
	2000.10-2001.05	Estate Engine AR37101		o	GHA235018	K
	2000.10-2001.05	Saloon Engine AR37101	•		GHA242009	K
	2000.10-2001.05	Saloon Engine AR37101		o	GHA235018	K
1.9 JTD (85 kW)	2001.05-2005.09	Saloon Engine 937A2.000	•		GHA242009	K
	2001.05-2005.09	Saloon Engine 937A2.000		o	GHA230118	K
	2001.05-2005.09	Saloon Engine 937A2.000		o	GHA235018	K
	2001.05-2006.05	Estate Engine 937A2.000	•		GHA242009	K
	2001.05-2006.05	Estate Engine 937A2.000		o	GHA230118	K
	2001.05-2006.05	Estate Engine 937A2.000		o	GHA235018	K
1.9 JTD (93 kW)	2003.11-2005.09	Saloon Engine 937A4.000	•		GHA242009	K
	2003.11-2005.09	Saloon Engine 937A4.000		o	GHA235018	K
	2003.11-2006.05	Estate Engine 937A4.000	•		GHA242009	K
	2003.11-2006.05	Estate Engine 937A4.000		o	GHA230118	K
	2003.11-2006.05	Estate Engine 937A4.000		o	GHA235018	K
1.9 JTD 16V (103 kW)	2002.11-2005.09	Saloon Engine 192A5.000	•		GHA242009	K
	2002.11-2005.09	Saloon Engine 192A5.000		o	GHA230118	K
	2002.11-2005.09	Saloon Engine 192A5.000		o	GHA235018	K
	2002.11-2006.05	Estate Engine 192A5.000	•		GHA242009	K
	2002.11-2006.05	Estate Engine 192A5.000		o	GHA230118	K
	2002.11-2006.05	Estate Engine 192A5.000		o	GHA235018	K
1.9 JTD 16V Q4 (110 kW)	2004.07-2006.05	Estate Engine 937A5.000	•		GHA242009	K
	2004.07-2006.05	Estate Engine 937A5.000		o	GWB3599	
2.0 (119 kW)	2002.03-2006.05	Estate Engine 932A2.000	•		GHA242009	K
	2002.03-2006.05	Estate Engine 932A2.000		o	GHA230118	K
	2002.03-2006.05	Estate Engine 932A2.000		o	GHA235018	K
2.0 16V T.SPARK (110 kW)	2000.10-2002.03	Estate Engine AR32310	•		GHA242009	K
	2000.10-2002.03	Estate Engine AR32310		o	GHA235018	K
	2000.10-2002.03	Saloon Engine AR32310	•		GHA242009	K
	2000.10-2002.03	Saloon Engine AR32310		o	GHA235018	K
2.0 16V T.SPARK (114 kW)	1997.09-2000.10	Saloon Engine AR32301	•		GHA242009	K



	 YEAR		F	R	G-AP Ref.	KIT
ALFA ROMEO						
156 (932)						
2.0 16V T.SPARK (114 kW)	1997.09-2000.10	Saloon Engine AR32301		o	GHA235018	K
	2000.05-2002.06	Estate Engine AR32301	•		GHA242009	K
	2000.05-2002.06	Estate Engine AR32301		o	GHA235018	K
2.0 JTS (122 kW)	2002.03-2005.09	Saloon Engine 937A1.000	•		GHA242009	K
	2002.03-2005.09	Saloon Engine 937A1.000		o	GHA230118	K
	2002.03-2005.09	Saloon Engine 937A1.000		o	GHA235018	K
	2002.03-2006.05	Estate Engine 937A1.000	•		GHA242009	K
	2002.03-2006.05	Estate Engine 937A1.000		o	GHA230118	K
	2002.03-2006.05	Estate Engine 937A1.000		o	GHA235018	K
2.0 Twin Spark (118 kW)	1997.11-2000.04	Saloon Engine AR32303	•		GHA242009	K
	1997.11-2000.04	Saloon Engine AR32303		o	GHA235018	K
2.4 JTD (100 kW)	1997.09-2003.09	Saloon Engine AR32501	•		GHA242009	K
	1997.09-2003.09	Saloon Engine AR32501		o	GHA235018	K
	2000.05-2003.09	Estate Engine AR32501	•		GHA242009	K
	2000.05-2003.09	Estate Engine AR32501		o	GHA235018	K
2.4 JTD (103 kW)	2000.10-2005.09	Saloon Engine 839A6.000	•		GHA242009	K
	2000.10-2005.09	Saloon Engine 839A6.000		o	GHA230118	K
	2000.10-2005.09	Saloon Engine 839A6.000		o	GHA235018	K
	2000.10-2006.05	Estate Engine 839A6.000	•		GHA242009	K
	2000.10-2006.05	Estate Engine 839A6.000		o	GHA230118	K
	2000.10-2006.05	Estate Engine 839A6.000		o	GHA235018	K
2.4 JTD (110 kW)	2002.03-2005.09	Saloon Engine 841C000	•		GHA242009	K
	2002.03-2005.09	Saloon Engine 841C000		o	GHA230118	K
	2002.03-2005.09	Saloon Engine 841C000		o	GHA235018	K
	2002.03-2006.05	Estate Engine 841C000	•		GHA242009	K
	2002.03-2006.05	Estate Engine 841C000		o	GHA230118	K
	2002.03-2006.05	Estate Engine 841C000		o	GHA235018	K
2.4 JTD (120 kW)	2003.06-2005.09	Saloon Engine 841M.000/841N.000	•		GHA242009	K
	2003.06-2005.09	Saloon Engine 841M.000/841N.000		o	GHA235018	K
	2003.06-2006.05	Estate Engine 841M.000/841N.000	•		GHA242009	K
	2003.06-2006.05	Estate Engine 841M.000/841N.000		o	GHA230118	K
	2003.06-2006.05	Estate Engine 841M.000/841N.000		o	GHA235018	K
2.4 JTD (129 kW)	2003.10-2005.09	Saloon Engine 841G.000	•		GHA242009	K
	2003.10-2005.09	Saloon Engine 841G.000		o	GHA230118	K
	2003.10-2005.09	Saloon Engine 841G.000		o	GHA235018	K
	2003.10-2006.05	Estate Engine 841G.000	•		GHA242009	K
	2003.10-2006.05	Estate Engine 841G.000		o	GHA230118	K
	2003.10-2006.05	Estate Engine 841G.000		o	GHA235018	K
2.5 V6 24V (140 kW)	1997.09-2001.12	Saloon Engine AR32401	•		GHA242009	K
	1997.09-2001.12	Saloon Engine AR32401		o	GHA235018	K
	2000.05-2003.08	Estate Engine AR32401	•		GHA242009	K
	2000.05-2003.08	Estate Engine AR32401		o	GHA235018	K
2.5 V6 24V (141 kW)	2000.10-2005.09	Saloon Engine AR32405	•		GHA242009	K
	2000.10-2005.09	Saloon Engine AR32405		o	GHA230118	K
	2000.10-2005.09	Saloon Engine AR32405		o	GHA235018	K
	2000.10-2006.05	Estate Engine AR32405	•		GHA242009	K
	2000.10-2006.05	Estate Engine AR32405		o	GHA230118	K
	2000.10-2006.05	Estate Engine AR32405		o	GHA235018	K
3.2 GTA (184 kW)	2002.03-2005.09	Saloon Engine 932A.000	•		GHA242009	K
	2002.03-2005.09	Saloon Engine 932A.000	•		GHA425028	
	2002.03-2005.09	Saloon Engine 932A.000		o	GHA230118	K
	2002.03-2005.09	Saloon Engine 932A.000		o	GHA235018	K
	2002.03-2006.05	Estate Engine 932A.000	•		GHA242009	K
	2002.03-2006.05	Estate Engine 932A.000	•		GHA425028	
	2002.03-2006.05	Estate Engine 932A.000		o	GHA230118	K
	2002.03-2006.05	Estate Engine 932A.000		o	GHA235018	K
159 (939)						
1.8 MPI (103 kW)	2007.03-2011.11	Estate Engine 939A4.000	•		GHA330025	K
	2007.03-2011.11	Estate Engine 939A4.000		o	GHA400206	K
	2007.03-2011.11	Saloon Engine 939A4.000	•		GHA330025	K
	2007.03-2011.11	Saloon Engine 939A4.000		o	GHA400206	K
1.8 TBi (147 kW)	2009.05-2011.11	Estate Engine 939B1.000	•		GHA330025	K
	2009.05-2011.11	Estate Engine 939B1.000		o	GHA400206	K
	2009.05-2011.11	Saloon Engine 939B1.000	•		GHA330025	K



	 YEAR		F	R	G-AP Ref.	KIT
ALFA ROMEO						
159 (939)						
1.8 TBi (147 kW)	2009.05-2011.11	Saloon Engine 939B1.000		o	GHA400206	K
1.9 JTDM 16V (100 kW)	2005.09-2011.11	Saloon Engine 937A8.000/939A8.000	•		GHA330025	K
	2005.09-2011.11	Saloon Engine 937A8.000/939A8.000		o	GHA400206	K
	2006.03-2011.11	Estate Engine 937A8.000	•		GHA330025	K
	2006.03-2011.11	Estate Engine 937A8.000		o	GHA400206	K
1.9 JTDM 16V (110 kW)	2005.09-2011.11	Saloon Engine 939A2.000	•		GHA330025	K
	2005.09-2011.11	Saloon Engine 939A2.000		o	GHA400206	K
	2006.06-2011.11	Estate Engine 939A2.000	•		GHA330025	K
	2006.06-2011.11	Estate Engine 939A2.000		o	GHA400206	K
1.9 JTDM 8V (85 kW)	2005.09-2011.11	Saloon Engine 939 A7.000	•		GHA330025	K
	2005.09-2011.11	Saloon Engine 939 A7.000		o	GHA400206	K
1.9 JTDM 8V (88 kW)	2005.09-2011.11	Saloon Engine 939A1.000	•		GHA330025	K
	2005.09-2011.11	Saloon Engine 939.A1.000		o	GHA400206	K
	2006.03-2011.11	Estate Engine 939A1.000	•		GHA330025	K
	2006.03-2011.11	Estate Engine 939A1.000		o	GHA400206	K
1.9 JTS (118 kW)	2005.09-2011.11	Saloon Engine 939A6.000	•		GHA330025	K
	2005.09-2011.11	Saloon Engine 939A6.000		o	GHA400206	K
	2006.06-2011.11	Estate Engine 939A6.000	•		GHA330025	K
1.9 JTS (118 kW)	2006.06-2011.11	Estate Engine 939A6.000		o	GHA400206	K
2.0 JTDM (100 kW)	2010.06-2011.11	Estate Engine 939B4.000	•		GHA330025	K
	2010.06-2011.11	Estate Engine 939B4.000		o	GHA400206	K
	2010.06-2011.11	Saloon Engine 939B4.000	•		GHA330025	K
	2010.06-2011.11	Saloon Engine 939B4.000		o	GHA400206	K
2.0 JTDM (120 kW)	2009.05-2011.11	Estate Engine 844A2.000	•		GHA330025	K
	2009.05-2011.11	Estate Engine 844A2.000		o	GHA400206	K
	2009.05-2011.11	Saloon Engine 844A2.000	•		GHA330025	K
	2009.05-2011.11	Saloon Engine 844A2.000		o	GHA400206	K
2.0 JTDM (125 kW)	2009.05-2011.11	Estate Engine 939B3.000	•		GHA330025	K
	2009.05-2011.11	Estate Engine 939B3.000		o	GHA400206	K
	2009.05-2011.11	Saloon Engine 939B3.000	•		GHA330025	K
	2009.05-2011.11	Saloon Engine 939B3.000		o	GHA400206	K
2.2 JTS (136 kW)	2005.09-2011.11	Saloon Engine 939A5.000	•		GHA330025	K
	2005.09-2011.11	Saloon Engine 939A5.000		o	GHA400206	K
	2006.06-2011.11	Estate Engine 939A5.000	•		GHA330025	K
	2006.06-2011.11	Estate Engine 939A5.000		o	GHA400206	K
2.4 JTDM (147 kW)	2005.09-2011.11	Saloon Engine 939A3.000	•		GHA330025	K
	2005.09-2011.11	Saloon Engine 939A3.000		o	GHA400206	K
	2006.06-2011.11	Estate Engine 939A3.000	•		GHA330025	K
	2006.06-2011.11	Estate Engine 939A3.000		o	GHA400206	K
2.4 JTDM (154 kW)	2007.05-2011.11	Estate Engine 939A9.000	•		GHA330025	K
	2007.05-2011.11	Estate Engine 939A9.000		o	GHA400206	K
	2007.05-2011.11	Saloon Engine 939A9.000	•		GHA330025	K
	2007.05-2011.11	Saloon Engine 939A9.000		o	GHA400206	K
2.4 JTDM Q4 (154 kW)	2007.05-2011.11	Estate Engine 939A9.000	•		GHA330025	K
	2007.05-2011.11	Saloon Engine 939A9.000	•		GHA330025	K
3.2 JTS (191 kW)	2008.02-2011.11	Estate Engine 939A.000	•		GHA330025	K
	2008.02-2011.11	Estate Engine 939A.000		o	GHA400206	K
	2008.02-2011.11	Saloon Engine 939A.000	•		GHA330025	K
	2008.02-2011.11	Saloon Engine 939A.000		o	GHA400206	K
3.2 JTS Q4 (191 kW)	2006.01-2011.11	Saloon Engine 939A.000	•		GHA330025	K
	2006.06-2011.11	Estate Engine 939A.000	•		GHA330025	K
159 SPORTWAGON (939)						
1.9 JTDM 8V (85 kW)	2006.03-2011.11	Estate Engine 937 A7.000	•		GHA330025	K
	2006.03-2011.11	Estate Engine 937 A7.000		o	GHA400206	K
164 (164)						
2.0 T.S. (106 kW)	1992.09-1998.09	Saloon Engine AR64103	•		GHA425028	
	1992.09-1998.09	Saloon Engine AR64103	•		GWB1488	
2.0 Twin Spark (106 kW)	1990.07-1992.10	Saloon	•		GWB1488	
2.0 V6 Turbo (148 kW)	1992.09-1998.09	Saloon Engine AR64102	•		GHA425028	
	1992.09-1998.09	Saloon Engine AR64102	•		GWB1488	
2.0 V6 Turbo (150 kW)	1991.03-1992.09	Saloon Engine AR64101	•		GHA425028	
	1991.03-1992.09	Saloon Engine AR64101	•		GWB1488	
2.5 TD (92 kW)	1992.09-1998.09	Saloon Engine VM08B/VM32B	•		GHA425028	
	1992.09-1998.09	Saloon Engine VM08B/VM32B	•		GWB1488	



	 YEAR		F	R	G-AP Ref.	KIT
ALFA ROMEO						
164 (164)						
3.0 (168 kW)	1993.04-1995.02	Saloon Engine AR64304	•		GWB1488	
	1993.04-1995.02	Saloon Engine AR64304		◦	GHA425028	
3.0 (170 kW)	1995.03-1997.08	Saloon Engine AR64304	•		GWB1488	
	1995.03-1997.08	Saloon Engine AR64304		◦	GHA425028	
3.0 (171 kW)	1992.11-1997.10	Saloon Engine AR64307	•		GWB1488	
3.0 24V (155 kW)	1992.09-1998.09	Saloon Engine AR66301/AR66302	•		GWB1488	
	1992.09-1998.09	Saloon Engine AR66301/AR66302		◦	GHA425028	
3.0 24V Q4 (170 kW)	1994.02-1998.09	Saloon Engine AR64307/AR64308	•		GWB1488	
3.0 24V QV (171 kW)	1992.09-1998.09	Saloon Engine AR64304	•		GWB1488	
	1992.09-1998.09	Saloon Engine AR64304		◦	GHA425028	
3.0 i.e. QV (147 kW)	1990.09-1992.09	Saloon Engine AR06430/AR64301	•		GWB1488	
	1990.09-1992.09	Saloon Engine AR06430/AR64301		◦	GHA425028	
3.0 V6 (132 kW)	1992.09-1998.09	Saloon Engine AR64305/AR66303	•		GWB1488	
	1992.09-1998.09	Saloon Engine AR64305/AR66303		◦	GHA425028	
166 (936)						
2.0 T.Spark (110 kW)	2000.10-2007.06	Saloon Engine AR36301	•		GHA242009	K
	2000.10-2007.06	Saloon Engine AR36301		◦	GHA235021	K
2.0 T.Spark (114 kW)	1998.09-2000.10	Saloon Engine AR34103	•		GHA242009	K
	1998.09-2000.10	Saloon Engine AR34103		◦	GHA235021	K
2.0 V6 (151 kW)	1998.09-2000.10	Saloon Engine AR34102	•		GHA242009	K
2.0 V6 (151 kW)	1998.09-2000.10	Saloon Engine AR34102		◦	GHA235021	K
2.4 JTD (100 kW)	1998.09-2000.10	Saloon Engine AR34202	•		GHA242009	K
	1998.09-2000.10	Saloon Engine AR34202		◦	GHA235021	K
2.4 JTD (103 kW)	2000.10-2007.06	Saloon Engine 839A6.000	•		GHA242009	K
	2000.10-2007.06	Saloon Engine 839A6.000		◦	GHA235021	K
2.4 JTD (110 kW)	2002.04-2007.06	Saloon Engine 841C000	•		GHA242009	K
	2002.04-2007.06	Saloon Engine 841C000		◦	GHA235021	K
2.4 JTD (129 kW)	2003.10-2007.06	Saloon Engine 841G.000/841H.000	•		GHA242009	K
	2003.10-2007.06	Saloon Engine 841G.000/841H.000		◦	GHA235021	K
2.4 JTD (132 kW)	2006.07-2007.06	Saloon Engine 841M.000	•		GHA242009	K
	2006.07-2007.06	Saloon Engine 841M.000		◦	GHA235021	K
2.4 JTD (136 kW)	2005.07-2007.06	Saloon Engine 841M.000/936B.000	•		GHA242009	K
	2005.07-2007.06	Saloon Engine 841M.000/936B.000		◦	GHA235021	K
2.5 V6 24V (138 kW)	2000.10-2007.06	Saloon Engine AR36201	•		GHA242009	K
	2000.10-2007.06	Saloon Engine AR36201		◦	GHA235021	K
2.5 V6 24V (140 kW)	1998.09-2000.10	Saloon Engine AR34201	•		GHA242009	K
	1998.09-2000.10	Saloon Engine AR34201		◦	GHA235021	K
3.0 V6 24V (162 kW)	2000.10-2007.06	Saloon Engine AR36101	•		GHA242009	K
	2000.10-2007.06	Saloon Engine AR36101		◦	GHA235021	K
3.0 V6 24V (166 kW)	1998.09-2000.10	Saloon Engine AR34301	•		GHA242009	K
	1998.09-2000.10	Saloon Engine AR34301		◦	GHA235021	K
3.2 V6 24V (176 kW)	2004.04-2006.01	Saloon Engine 936A.000	•		GHA242009	K
	2004.04-2006.01	Saloon Engine 936A.000		◦	GHA235021	K
168 (164)						
2.0 Turbo (152 kW)	1990.07-1992.1	Saloon	•		GWB1488	
2.5 V6 (120 kW)	1992.09-1998.09	Saloon Engine AR 66201	•		GHA425028	
3.0 (156 kW)	1993.09-1995.12	Saloon		◦	GHA425028	
3.0 (157 kW)	1995.03-1997.1	Saloon Engine AR 66306		◦	GHA425028	
3.0 24V (154 kW)	1995.03-1997.1	Saloon Engine AR 66302		◦	GHA425028	
4C (960)						
1.8 Tbi (177 kW)	2013.03-	Coupe Engine 960 A1.000	•		GHA230120	K
4C SPIDER (960)						
	2014.10-	Convertible Engine 960 A1.000	•		GHA230120	K
BRERA						
1.8 Tbi (147 kW)	2009.05-	Hatchback Engine 939B1.000	•		GHA330025	K
	2009.05-	Hatchback Engine 939B1.000		◦	GHA400206	K
2.0 JTDM (120 kW)	2008.03-	Hatchback Engine 844A2.000	•		GHA330025	K
	2008.03-	Hatchback Engine 844A2.000		◦	GHA400206	K
2.0 JTDM (125 kW)	2009.05-	Hatchback Engine 939B3.000	•		GHA330025	K
	2009.05-	Hatchback Engine 939B3.000		◦	GHA400206	K
2.2 JTS (136 kW)	2006.04-	Hatchback Engine 939A5.000	•		GHA330025	K
	2006.04-	Hatchback Engine 939A5.000		◦	GHA400206	K
2.4 JTDM 20V (147 kW)	2006.04-	Hatchback Engine 939A3.000	•		GHA330025	K



	 YEAR		F	R	G-AP Ref.	KIT
ALFA ROMEO						
BRERA						
2.4 JTDM 20V (147 kW)	2006.04-	Hatchback Engine 939A3.000		o	GHA400206	K
2.4 JTDM 20V (154 kW)	2007.05-	Hatchback Engine 939A9.000	•		GHA330025	K
	2007.05-	Hatchback Engine 939A9.000		o	GHA400206	K
3.2 JTS (191 kW)	2008.03-	Hatchback Engine 939A.000	•		GHA330025	K
	2008.03-	Hatchback Engine 939A.000		o	GHA400206	K
3.2 JTS Q4 (191 kW)	2006.04-	Hatchback Engine 939A.000	•		GHA330025	K
GIULIETTA (940)						
1.4 BiFuel (88 kW)	2011.12-	Hatchback Engine 198A4.000	•		GHA242009	K
	2011.12-	Hatchback Engine 198A4.000	•		GHA242009	S
	2011.12-	Hatchback Engine 198A4.000		o	GHA230115	K
1.4 TB (110 kW)	2014.09-	Hatchback Engine 940 A2.000	•		GHA242009	K
	2014.09-	Hatchback Engine 940 A2.000		o	GHA230115	K
1.4 TB (120 kW)	2010.04-	Hatchback Engine 955 A8.000	•		GHA242009	K
	2010.04-	Hatchback Engine 955 A8.000		o	GHA230115	K
1.4 TB (125 kW)	2010.04-	Hatchback Engine 940A2.000	•		GHA242009	K
	2010.04-	Hatchback Engine 940A2.000	•		GHA242009	S
	2010.04-	Hatchback Engine 940A2.000		o	GHA230115	K
1.4 TB (77 kW)	2011.04-	Hatchback Engine 940B1.000/940B8.000	•		GHA242009	K
	2011.04-	Hatchback Engine 940B1.000/940B8.000	•		GHA242009	S
	2011.04-	Hatchback Engine 940B1.000/940B8.000		o	GHA230115	K
1.4 TB (85 kW)	2010.04-	Hatchback Engine 940 A6.000	•		GHA242009	K
	2010.04-	Hatchback Engine 940 A6.000		o	GHA230115	K
1.4 TB (88 kW)	2010.04-	Hatchback Engine 198A4.000/940B7.000	•		GHA242009	K
	2010.04-	Hatchback Engine 198A4.000/940B7.000	•		GHA242009	S
	2010.04-	Hatchback Engine 198A4.000/940B7.000		o	GHA230115	K
1.6 JTDM (77 kW)	2010.04-	Hatchback Engine 940A3.000	•		GHA242009	K
	2010.04-	Hatchback Engine 940A3.000	•		GHA242009	S
	2010.04-	Hatchback Engine 940A3.000		o	GHA230115	K
1.8 TBi (169 kW)	2010.04-2013.09	Hatchback Engine 940 A1.000	•		GHA242009	K
	2010.04-2013.09	Hatchback Engine 940 A1.000		o	GHA230115	K
1.8 TBi (173 kW)	2010.04-	Hatchback Engine 940A1.000	•		GHA242009	K
	2010.04-	Hatchback Engine 940A1.000	•		GHA242009	S
	2010.04-	Hatchback Engine 940A1.000		o	GHA230115	K
1.8 TBi (177 kW)	2013.09-	Hatchback Engine 960 A1.000	•		GHA242009	K
2.0 JTDM (100 kW)	2010.04-	Hatchback Engine 940A8.000/940B6.000	•		GHA242009	K
	2010.04-	Hatchback Engine 940A8.000/940B6.000	•		GHA242009	S
	2010.04-	Hatchback Engine 940A8.000/940B6.000		o	GHA230115	K
2.0 JTDM (103 kW)	2010.04-	Hatchback Engine 940A5.000	•		GHA242009	K
	2010.04-	Hatchback Engine 940A5.000	•		GHA242009	S
	2010.04-	Hatchback Engine 940A5.000		o	GHA230115	K
2.0 JTDM (110 kW)	2013.08-	Hatchback Engine 940 B5.000	•		GHA242009	K
2.0 JTDM (120 kW)	2010.04-	Hatchback Engine 940 A7.000	•		GHA242009	K
	2010.04-	Hatchback Engine 940 A7.000		o	GHA230115	K
2.0 JTDM (125 kW)	2010.04-	Hatchback Engine 940A4.000	•		GHA242009	K
	2010.04-	Hatchback Engine 940A4.000	•		GHA242009	S
	2010.04-	Hatchback Engine 940A4.000		o	GHA230115	K
2.0 JTDM (129 kW)	2013.11-	Hatchback Engine 940 B4.000	•		GHA242009	K
GT (937)						
1.8 TS (103 kW)	2003.11-2010.09	Coupe Engine AR32205	•		GHA242009	K
	2003.11-2010.09	Coupe Engine AR32205		o	GHA230118	K
	2003.11-2010.09	Coupe Engine AR32205		o	GHA235018	K
1.9 JTD (110 kW)	2004.04-2007.01	Coupe Engine 937A5.000	•		GHA242009	K
	2004.04-2007.01	Coupe Engine 937A5.000		o	GHA230118	K
	2004.04-2007.01	Coupe Engine 937A5.000		o	GHA235018	K
1.9 JTD (125 kW)	2008.05-2010.09	Coupe Engine 937A6.000	•		GHA242009	K
	2008.05-2010.09	Coupe Engine 937A6.000		o	GHA230118	K
2.0 JTS (119 kW)	2006.12-2010.09	Coupe Engine 932A2.000	•		GHA242009	K
	2006.12-2010.09	Coupe Engine 932A2.000		o	GHA230118	K
2.0 JTS (121 kW)	2004.04-2007.01	Coupe Engine 932A2.000/937A1.000	•		GHA242009	K
	2004.04-2007.01	Coupe Engine 932A2.000/937A1.000		o	GHA230118	K
	2004.04-2007.01	Coupe Engine 932A2.000/937A1.000		o	GHA235018	K
3.2 GTA (176 kW)	2004.04-2007.09	Coupe Engine 936A.000	•		GHA242009	K
	2004.04-2007.09	Coupe Engine 936A.000	•		GHA425028	K
	2004.04-2007.09	Coupe Engine 936A.000		o	GHA230118	K



	 YEAR		F	R	G-AP Ref.	KIT
ALFA ROMEO						
GT (937)						
3.2 GTA (176 kW)	2004.04-2007.09	Coupe Engine 936A.000		o	GHA235018	K
GTV (916C_)						
1.8 16V (106 kW)	1998.05-2005.10	Coupe Engine AR32201	•		GWB1439	
	1998.05-2005.10	Coupe Engine AR32201	•		GWB3539	
	1998.05-2005.10	Coupe Engine AR32201	•		GWB6540	
	1998.05-2005.10	Coupe Engine AR32201		o	GHA230104	K
	1998.05-2005.10	Coupe Engine AR32201		o	GHA230120	K
2.0 JTS (121 kW)	2003.07-2006.01	Coupe Engine 937A1.000	•		GWB3539	
	2003.07-2006.01	Coupe Engine 937A1.000	•		GWB6540	
	2003.07-2006.01	Coupe Engine 937A1.000		o	GHA230120	K
2.0 T.SPARK 16V (110 kW)	1995.06-2005.10	Coupe Engine AR16201/AR32310	•		GWB1439	
	1995.06-2005.10	Coupe Engine AR16201/AR32310	•		GWB3539	
	1995.06-2005.10	Coupe Engine AR16201/AR32310	•		GWB6540	
	1995.06-2005.10	Coupe Engine AR16201/AR32310		o	GHA230104	K
	1995.06-2005.10	Coupe Engine AR16201/AR32310		o	GHA230120	K
2.0 T.SPARK 16V (114 kW)	1998.05-2000.08	Coupe Engine AR32301	•		GWB1439	
	1998.05-2000.08	Coupe Engine AR32301	•		GWB3539	
	1998.05-2000.08	Coupe Engine AR32301	•		GWB6540	
	1998.05-2000.08	Coupe Engine AR32301		o	GHA230104	K
	1998.05-2000.08	Coupe Engine AR32301		o	GHA230120	K
	1998.05-2000.08	Coupe Engine AR32301		o	GHA230120	K
2.0 V6 Turbo (148 kW)	1995.06-1998.09	Coupe Engine AR16202	•		GWB1488	
	1995.06-1998.09	Coupe Engine AR16202		o	GHA230104	K
3.0 V6 24V (160 kW)	2000.10-2005.10	Coupe Engine AR16105		o	GHA230120	K
3.0 V6 24V (162 kW)	1996.10-2000.10	Coupe Engine AR16102	•		GWB1488	
	1996.10-2000.10	Coupe Engine AR16102		o	GHA230104	K
	1996.10-2000.10	Coupe Engine AR16102		o	GHA230120	K
3.2 V6 24V (176 kW)	2003.07-2006.01	Coupe Engine 936A6.000	•		GHA425028	
	2003.07-2006.01	Coupe Engine 936A6.000		o	GHA230120	K
MITO (955)						
0.9 (63 kW)	2011.07-	Hatchback Engine 312A2.000 With ABS		o	GHA230046	K
1.3 JTDM (62 kW)	2011.01-	Hatchback Engine 199B4.000	•		GWB3539	
	2011.01-	Hatchback Engine 199B4.000	•		GWB6540	
	2011.01-	Hatchback Engine 199B4.000 With ABS		o	GHA230046	K
1.3 JTDM (66 kW)	2008.09-	Hatchback Engine 199A3.000	•		GWB3539	
	2008.09-	Hatchback Engine 199A3.000	•		GWB6540	
	2008.09-	Hatchback Engine 199A3.000 With ABS		o	GHA230046	K
1.3 JTDM (70 kW)	2009.10-	Hatchback Engine 199B1.000	•		GWB3539	
	2009.10-	Hatchback Engine 199B1.000	•		GWB6540	
	2009.10-	Hatchback Engine 199B1.000 With ABS		o	GHA230046	K
1.4 (51 kW)	2011.05-	Hatchback Engine 955A9.000 With ABS		o	GHA230046	K
1.4 (57 kW)	2011.03-	Hatchback Engine 350A1.000 With ABS		o	GHA230046	K
	2011.03-	Hatchback Engine 955A1.000 With ABS		o	GHA230046	K
1.4 (58 kW)	2008.09-	Hatchback Engine 955A1.000 With ABS		o	GHA230046	K
1.4 (70 kW)	2008.09-	Hatchback Engine 199A6.000 With ABS		o	GHA230046	K
1.4 (77 kW)	2010.08-	Hatchback Engine 955A6.000 With ABS		o	GHA230046	K
1.4 (88 kW)	2008.09-	Hatchback Engine 198A4.000 With ABS		o	GHA230046	K
1.4 Bifuel (88 kW)	2011.07-	Hatchback Engine 198A4.000	•		GWB3539	
	2011.07-	Hatchback Engine 198A4.000	•		GWB6540	
	2011.07-	Hatchback Engine 198A4.000 With ABS		o	GHA230046	K
1.4 TB (114 kW)	2008.09-	Hatchback Engine 199A8.000	•		GWB3539	
	2008.09-	Hatchback Engine 199A8.000	•		GWB6540	
	2008.09-	Hatchback Engine 199A8.000 With ABS		o	GHA230046	K
1.4 TB (120 kW)	2009.10-	Hatchback Engine 955A8.000	•		GWB3539	
	2009.10-	Hatchback Engine 955A8.000	•		GWB6540	
	2009.10-	Hatchback Engine 955A8.000 With ABS		o	GHA230046	K
1.4 TB (125 kW)	2009.10-	Hatchback Engine 940A2.000	•		GWB3539	
	2009.10-	Hatchback Engine 940A2.000	•		GWB6540	
	2009.10-	Hatchback Engine 940A2.000 With ABS		o	GHA230046	K
1.4 TB (99 kW)	2009.10-	Hatchback Engine 955A2.000/955A7.000	•		GWB3539	
	2009.10-	Hatchback Engine 955A2.000/955A7.000	•		GWB6540	
	2009.10-	Hatchback Engine 955A2.000/955A7.000 With ABS		o	GHA230046	K
1.4 TJet (110 kW)	2008.09-	Hatchback Engine 198 A1.000	•		GWB3539	
	2008.09-	Hatchback Engine 198 A1.000	•		GWB6540	
	2008.09-	Hatchback Engine 198 A1.000 With ABS		o	GHA230046	K



	 YEAR		F	R	G-AP Ref.	KIT
ALFA ROMEO						
MITO (955)						
1.6 JTDM (85 kW)	2008.09-	Hatchback Engine 955A4.000	•		GWB3539	
	2008.09-	Hatchback Engine 955A4.000	•		GWB6540	
	2008.09-	Hatchback Engine 955A4.000 With ABS		o	GHA230046	K
1.6 JTDM (88 kW)	2008.09-	Hatchback Engine 198A2.000/955A3.000	•		GWB3539	
	2008.09-	Hatchback Engine 198A2.000/955A3.000	•		GWB6540	
	2008.09-	Hatchback Engine 198A2.000/955A3.000 With ABS		o	GHA230046	K
SPIDER (916S_)						
1.8 16V (106 kW)	1998.05-2005.04	Convertible Engine AR32201	•		GWB1439	
	1998.05-2005.04	Convertible Engine AR32201	•		GWB3539	
	1998.05-2005.04	Convertible Engine AR32201	•		GWB6540	
	1998.05-2005.04	Convertible Engine AR32201		o	GHA230104	K
	1998.05-2005.04	Convertible Engine AR32201		o	GHA230120	K
2.0 JTS (121 kW)	2003.04-2005.04	Convertible Engine 937A1.000	•		GWB3539	
	2003.04-2005.04	Convertible Engine 937A1.000	•		GWB6540	
	2003.04-2005.04	Convertible Engine 937A1.000		o	GHA230120	K
2.0 T.SPARK 16V (110 kW)	1995.06-2005.04	Convertible Engine AR16201/AR32310	•		GWB1439	
	1995.06-2005.04	Convertible Engine AR16201/AR32310	•		GWB3539	
	1995.06-2005.04	Convertible Engine AR16201/AR32310	•		GWB6540	
	1995.06-2005.04	Convertible Engine AR16201/AR32310		o	GHA230104	K
	1995.06-2005.04	Convertible Engine AR16201/AR32310		o	GHA230120	K
2.0 T.SPARK 16V (114 kW)	1998.05-2000.08	Convertible Engine AR32301	•		GWB1439	
	1998.05-2000.08	Convertible Engine AR32301	•		GWB3539	
	1998.05-2000.08	Convertible Engine AR32301	•		GWB6540	
	1998.05-2000.08	Convertible Engine AR32301		o	GHA230104	K
	1998.05-2000.08	Convertible Engine AR32301		o	GHA230120	K
2.0 V6 Turbo (148 kW)	1998.05-2005.04	Convertible Engine AR16202	•		GWB1488	
	1998.05-2005.04	Convertible Engine AR16202		o	GHA230104	K
	1998.05-2005.04	Convertible Engine AR16202		o	GHA230120	K
3.0 V6 (141 kW)	1995.06-2005.04	Convertible Engine AR16101	•		GWB1488	
	1995.06-2005.04	Convertible Engine AR16101		o	GHA230104	K
	1995.06-2005.04	Convertible Engine AR16101		o	GHA230120	K
3.0 V6 (160 kW)	1994.09-2000.08	Convertible Engine AR16105		o	GHA230120	K
3.0 V6 24V (162 kW)	1999.01-2003.10	Convertible Engine AR16102	•		GWB1488	
	1999.01-2003.10	Convertible Engine AR16102		o	GHA230104	K
	1999.01-2003.10	Convertible Engine AR16102		o	GHA230120	K
3.2 V6 24V (176 kW)	2003.04-2005.04	Convertible Engine 936A6.000	•		GHA425028	
	2003.04-2005.04	Convertible Engine 936A6.000		o	GHA230120	K
SPIDER (939)						
1.8 TBi (147 kW)	2009.05-	Convertible Engine 939B1.000	•		GHA330025	K
	2009.05-	Convertible Engine 939B1.000		o	GHA400206	K
2.0 JTDM (120 kW)	2009.04-	Convertible Engine 844A2.000	•		GHA330025	K
	2009.04-	Convertible Engine 844A2.000		o	GHA400206	K
2.0 JTDM (125 kW)	2009.05-	Convertible Engine 939B3.000	•		GHA330025	K
	2009.05-	Convertible Engine 939B3.000		o	GHA400206	K
2.2 JTS (136 kW)	2007.03-	Convertible Engine 939A5.000	•		GHA330025	K
	2007.03-	Convertible Engine 939A5.000		o	GHA400206	K
2.4 JTDM (147 kW)	2007.03-	Convertible Engine 939A3.000	•		GHA330025	K
	2007.03-	Convertible Engine 939A3.000		o	GHA400206	K
2.4 JTDM (154 kW)	2008.03-	Convertible Engine 939A3.000	•		GHA330025	K
	2008.03-	Convertible Engine 939A3.000		o	GHA400206	K
3.2 JTS (191 kW)	2008.03-	Convertible Engine 939A.000	•		GHA330025	K
	2008.03-	Convertible Engine 939A.000		o	GHA400206	K
3.2 JTS Q4 (191 kW)	2007.03-	Convertible Engine 939A.000	•		GHA330025	K
AUDI						
100 (44, 44Q, C3)						
2.3 E (98 kW)	1990.01-1990.11	Saloon Engine AAR	•		GWB0962	
	1990.01-1990.11	Saloon Engine AAR	•		GWB1356	
	1990.01-1990.11	Saloon Engine AAR		o	GWB0542	
2.3 Quattro (98 kW)	1990.01-1990.11	Saloon Engine AAR	•		GWB1356	
2.5 TDi (88 kW)	1990.01-1990.11	Saloon Engine 1T	•		GWB0962	
	1990.01-1990.11	Saloon Engine 1T	•		GWB1356	
	1990.01-1990.11	Saloon Engine 1T		o	GHA499047	
	1990.01-1990.11	Saloon Engine 1T		o	GWB0542	



	 YEAR		F	R	G-AP Ref.	KIT
AUDI						
100 (4A, C4)						
2.0 (74 kW)	1990.12-1994.06	Saloon Engine AAE	•		GWB1356	
	1990.12-1994.06	Saloon Engine AAE		◦	GHA499047	
	1990.12-1994.06	Saloon Engine AAE		◦	GWB0542	
2.0 E (85 kW)	1990.12-1994.06	Saloon Engine AAD/ABK	•		GWB1356	
	1990.12-1994.06	Saloon Engine AAD/ABK		◦	GHA499047	
	1990.12-1994.06	Saloon Engine AAD/ABK		◦	GWB0542	
2.0 E 16V (103 kW)	1992.01-1994.06	Saloon Engine ACE	•		GWB1356	
	1992.01-1994.06	Saloon Engine ACE		◦	GHA499047	
	1992.01-1994.06	Saloon Engine ACE		◦	GWB0542	
2.0 E 16V Quattro (103 kW)	1992.07-1994.06	Saloon Engine ACE	•		GWB1356	
2.0 E Quattro (85 kW)	1990.12-1992.07	Saloon Engine AAD	•		GWB1356	
2.2 S4 Turbo Quattro (169 kW)	1991.08-1994.06	Saloon Engine AAN	•		GWB1356	
2.3 E (98 kW)	1990.12-1994.06	Saloon Engine AAR	•		GWB1356	
	1990.12-1994.06	Saloon Engine AAR		◦	GHA499047	
	1990.12-1994.06	Saloon Engine AAR		◦	GWB0542	
2.3 E Quattro (98 kW)	1990.12-1994.06	Saloon Engine AAR	•		GWB1356	
2.4 D (60 kW)	1990.12-1994.06	Saloon Engine AAS	•		GWB1356	
	1990.12-1994.06	Saloon Engine AAS		◦	GHA499047	
	1990.12-1994.06	Saloon Engine AAS		◦	GWB0542	
2.5 TDi (85 kW)	1990.12-1994.06	Saloon Engine AAT/ABP	•		GWB1356	
	1990.12-1994.06	Saloon Engine AAT/ABP		◦	GHA499047	
	1990.12-1994.06	Saloon Engine AAT/ABP		◦	GWB0542	
2.6 (102 kW)	1993.07-1994.06	Saloon Engine ACZ	•		GWB1356	
	1993.07-1994.06	Saloon Engine ACZ		◦	GWB0542	
2.6 (110 kW)	1992.03-1994.06	Saloon Engine ABC	•		GWB1356	
	1992.03-1994.06	Saloon Engine ABC		◦	GHA499047	
	1992.03-1994.06	Saloon Engine ABC		◦	GWB0542	
2.6 Quattro (110 kW)	1992.04-1994.06	Saloon Engine ABC	•		GWB1356	
2.8 E (128 kW)	1990.12-1994.06	Saloon Engine AAH	•		GWB1356	
	1990.12-1994.06	Saloon Engine AAH		◦	GHA499047	
	1990.12-1994.06	Saloon Engine AAH		◦	GWB0542	
2.8 E Quattro (128 kW)	1990.12-1994.06	Saloon Engine AAH	•		GWB1356	
4.2 S4 V8 Quattro (206 kW)	1992.10-1994.06	Saloon Engine ABH	•		GWB1356	
100 AVANT (44, 44Q, C3)						
2.3 (98 kW)	1990.03-1990.11	Estate Engine AAR	•		GWB0962	
	1990.03-1990.11	Estate Engine AAR	•		GWB1356	
	1990.03-1990.11	Estate Engine AAR		◦	GWB0542	
2.3 Quattro (98 kW)	1990.01-1990.11	Estate Engine AAR	•		GWB1356	
2.5 TDi (88 kW)	1990.01-1990.11	Estate Engine 1T	•		GWB0962	
	1990.01-1990.11	Estate Engine 1T	•		GWB1356	
	1990.01-1990.11	Estate Engine 1T		◦	GHA499047	
	1990.01-1990.11	Estate Engine 1T		◦	GWB0542	
100 AVANT (4A, C4)						
2.0 E (74 kW)	1991.09-1994.06	Estate Engine AAE	•		GWB1356	
	1991.09-1994.06	Estate Engine AAE		◦	GHA499047	
	1991.09-1994.06	Estate Engine AAE		◦	GWB0542	
2.0 E (85 kW)	1991.09-1994.06	Estate Engine AAD/ABK	•		GWB1356	
	1991.09-1994.06	Estate Engine AAD/ABK		◦	GHA499047	
	1991.09-1994.06	Estate Engine AAD/ABK		◦	GWB0542	
2.0 E 16V (103 kW)	1992.07-1994.06	Estate Engine ACE	•		GWB1356	
	1992.07-1994.06	Estate Engine ACE		◦	GHA499047	
	1992.07-1994.06	Estate Engine ACE		◦	GWB0542	
2.0 E 16V Quattro (103 kW)	1992.07-1994.06	Estate Engine ACE	•		GWB1356	
2.0 E Quattro (85 kW)	1990.12-1992.07	Estate Engine AAD	•		GWB1356	
2.2 S4 Turbo Quattro (169 kW)	1991.09-1994.06	Estate Engine AAN	•		GWB1356	
2.3 E (98 kW)	1991.09-1994.06	Estate Engine AAR	•		GWB1356	
	1991.09-1994.06	Estate Engine AAR		◦	GHA499047	
	1991.09-1994.06	Estate Engine AAR		◦	GWB0542	
2.3 E Quattro (98 kW)	1991.09-1994.06	Estate Engine AAR	•		GWB1356	
2.4 D (60 kW)	1990.12-1994.06	Estate Engine AAS	•		GWB1356	
	1990.12-1994.06	Estate Engine AAS		◦	GHA499047	
	1990.12-1994.06	Estate Engine AAS		◦	GWB0542	
2.5 TDi (85 kW)	1990.12-1994.06	Estate Engine AAT/ABP	•		GWB1356	
	1990.12-1994.06	Estate Engine AAT/ABP		◦	GHA499047	



	 YEAR		F	R	G-AP Ref.	KIT
AUDI						
100 AVANT (4A, C4)						
2.5 TDi (85 kW)	1990.12-1994.06	Estate Engine AAT/ABP		o	GWB0542	
2.6 (102 kW)	1993.07-1994.06	Estate Engine ACZ	•		GWB1356	
	1993.07-1994.06	Estate Engine ACZ		o	GWB0542	
2.6 (110 kW)	1992.03-1994.06	Estate Engine ABC	•		GWB1356	
	1992.03-1994.06	Estate Engine ABC		o	GHA499047	
	1992.03-1994.06	Estate Engine ABC		o	GWB0542	
2.6 E Quattro (102 kW)	1993.08-1994.07	Estate Engine ACZ	•		GWB1356	
2.6 Quattro (110 kW)	1992.07-1994.06	Estate Engine ABC	•		GWB1356	
2.8 E (128 kW)	1991.09-1994.06	Estate Engine AAH	•		GWB1356	
	1991.09-1994.06	Estate Engine AAH		o	GHA499047	
	1991.09-1994.06	Estate Engine AAH		o	GWB0542	
2.8 E Quattro (128 kW)	1991.09-1994.06	Estate Engine AAH	•		GWB1356	
4.2 S4 V8 Quattro (206 kW)	1992.10-1994.06	Estate Engine ABH	•		GWB1356	
80 (89, 89Q, 8A, B3)						
1.6 (75 kW)	1990.08-1991.10	Saloon Engine ABB	•		GWB1355	
	1990.08-1991.10	Saloon Engine ABB		o	GHA499044	
	1990.08-1991.10	Saloon Engine ABB		o	GHA499047	
	1990.08-1991.10	Saloon Engine ABB		o	GWB0529	
	1990.08-1991.10	Saloon Engine ABB		o	GWB0542	
2.0 (82 kW)	1990.10-1991.08	Saloon Engine AAD	•		GWB1355	
	1990.10-1991.08	Saloon Engine AAD		o	GHA499044	
	1990.10-1991.08	Saloon Engine AAD		o	GHA499047	
	1990.10-1991.08	Saloon Engine AAD		o	GWB0529	
2.0 E 16V (101 kW)	1990.10-1991.08	Saloon Engine AAD		o	GWB0542	
	1990.03-1991.09	Saloon Engine 6A	•		GWB1355	
	1990.03-1991.09	Saloon Engine 6A		o	GHA499044	
	1990.03-1991.09	Saloon Engine 6A		o	GHA499047	
	1990.03-1991.09	Saloon Engine 6A		o	GWB0529	
2.0 E 16V Quattro (101 kW)	1990.03-1991.08	Saloon Engine 6A	•		GWB1355	
2.0 Quattro (85 kW)	1990.10-1991.08	Saloon Engine AAD	•		GWB1355	
80 (8C, B4)						
1.6 (52 kW)	1991.09-1994.12	Saloon Engine ABM	•		GWB1355	
	1991.09-1994.12	Saloon Engine ABM		o	GHA499047	
	1991.09-1994.12	Saloon Engine ABM		o	GWB0529	
	1991.09-1994.12	Saloon Engine ABM		o	GWB0542	
1.6 E (74 kW)	1993.06-1994.12	Saloon Engine ADA	•		GWB1355	
	1993.06-1994.12	Saloon Engine ADA		o	GHA499047	
	1993.06-1994.12	Saloon Engine ADA		o	GWB0542	
1.9 TD (55 kW)	1991.09-1994.12	Saloon Engine AAZ	•		GWB1355	
	1991.09-1994.12	Saloon Engine AAZ		o	GHA499047	
	1991.09-1994.12	Saloon Engine AAZ		o	GWB0529	
	1991.09-1994.12	Saloon Engine AAZ		o	GWB0542	
1.9 TDi (66 kW)	1991.09-1994.12	Saloon Engine 1Z	•		GWB1355	
	1991.09-1994.12	Saloon Engine 1Z		o	GHA499047	
	1991.09-1994.12	Saloon Engine 1Z		o	GWB0529	
	1991.09-1994.12	Saloon Engine 1Z		o	GWB0542	
2.0 (66 kW)	1991.09-1994.12	Saloon Engine ABT	•		GWB1355	
	1991.09-1994.12	Saloon Engine ABT		o	GHA499047	
	1991.09-1994.12	Saloon Engine ABT		o	GWB0529	
	1991.09-1994.12	Saloon Engine ABT		o	GWB0542	
2.0 E (85 kW)	1991.09-1994.12	Saloon Engine ABK	•		GWB1355	
	1991.09-1994.12	Saloon Engine ABK		o	GHA499047	
	1991.09-1994.12	Saloon Engine ABK		o	GWB0529	
	1991.09-1994.12	Saloon Engine ABK		o	GWB0542	
2.0 E 16V (101 kW)	1991.09-1992.07	Saloon Engine 6A		o	GHA499047	
2.0 E 16V (103 kW)	1992.08-1994.12	Saloon Engine ACE	•		GWB1355	
	1992.08-1994.12	Saloon Engine ACE		o	GHA499047	
	1992.08-1994.12	Saloon Engine ACE		o	GWB0529	
	1992.08-1994.12	Saloon Engine ACE		o	GWB0542	
2.0 E 16V Quattro (103 kW)	1992.04-1994.12	Saloon Engine ACE	•		GWB1355	
2.0 E Quattro (85 kW)	1991.09-1994.12	Saloon Engine ABK	•		GWB1355	
2.2 S2 Quattro (169 kW)	1993.02-1994.12	Saloon Engine ABY	•		GWB1356	
2.3 E (98 kW)	1991.09-1994.12	Saloon Engine NG	•		GWB1355	



	 YEAR		F	R	G-AP Ref.	KIT
AUDI						
80 (8C, B4)						
2.3 E (98 kW)	1991.09-1994.12	Saloon Engine NG		o	GHA499047	
	1991.09-1994.12	Saloon Engine NG		o	GWB0542	
2.3 E Quattro (98 kW)	1991.09-1994.12	Saloon Engine NG	•		GWB1355	
	1991.09-1994.12	Saloon Engine NG	•		GWB1356	
2.6 (110 kW)	1992.07-1994.12	Saloon Engine ABC	•		GWB1356	
	1992.07-1994.12	Saloon Engine ABC		o	GHA499047	
	1992.07-1994.12	Saloon Engine ABC		o	GWB0542	
2.6 Quattro (110 kW)	1992.06-1994.12	Saloon Engine ABC	•		GWB1356	
	1992.06-1994.12	Saloon Engine ABC		o	GWB1355	
2.8 (128 kW)	1991.09-1994.12	Saloon Engine AAH	•		GWB1356	
	1991.09-1994.12	Saloon Engine AAH		o	GHA499047	
	1991.09-1994.12	Saloon Engine AAH		o	GWB0542	
2.8 Quattro (128 kW)	1991.09-1994.12	Saloon Engine AAH	•		GWB1356	
	1991.09-1994.12	Saloon Engine AAH		o	GWB1355	
80 AVANT (8C, B4)						
1.6 E (74 kW)	1993.06-1996.01	Estate Engine ADA	•		GWB1355	
	1993.06-1996.01	Estate Engine ADA		o	GWB0542	
1.9 TD (55 kW)	1991.09-1994.12	Estate Engine AAZ	•		GWB1355	
	1991.09-1994.12	Estate Engine AAZ		o	GWB0529	
	1991.09-1994.12	Estate Engine AAZ		o	GWB0542	
1.9 TDi (66 kW)	1992.07-1996.01	Estate Engine 1Z	•		GWB1355	
	1992.07-1996.01	Estate Engine 1Z		o	GWB0542	
2.0 (66 kW)	1992.07-1996.01	Estate Engine ABT	•		GWB1355	
	1992.07-1996.01	Estate Engine ABT		o	GWB0542	
2.0 E (85 kW)	1992.07-1996.01	Estate Engine ABK	•		GWB1355	
	1992.07-1996.01	Estate Engine ABK		o	GWB0542	
2.0 E 16V (103 kW)	1993.02-1996.01	Estate Engine ACE	•		GWB1355	
	1993.02-1996.01	Estate Engine ACE		o	GWB0542	
2.0 E 16V Quattro (103 kW)	1992.12-1995.07	Estate Engine ACE	•		GWB1356	
2.0 Quattro (79 kW)	1993.11-1996.01	Estate Engine ADW	•		GWB1356	
2.2 RS2 Quattro (232 kW)	1994.03-1995.05	Estate Engine ADU	•		GWB1356	
2.2 S2 Quattro (169 kW)	1993.02-1995.07	Estate Engine ABY	•		GWB1356	
2.3 E (98 kW)	1992.07-1996.01	Estate Engine NG	•		GWB1355	
	1992.07-1996.01	Estate Engine NG		o	GWB0542	
2.3 E Quattro (98 kW)	1991.09-1994.11	Estate Engine NG	•		GWB1355	
	1991.09-1994.11	Estate Engine NG	•		GWB1356	
2.6 (110 kW)	1992.07-1996.01	Estate Engine ABC	•		GWB1356	
	1992.07-1996.01	Estate Engine ABC		o	GWB0542	
2.6 Quattro (110 kW)	1992.07-1995.07	Estate Engine ABC	•		GWB1356	
2.8 (128 kW)	1991.09-1996.01	Estate Engine AAH	•		GWB1356	
	1991.09-1996.01	Estate Engine AAH		o	GWB0542	
2.8 Quattro (128 kW)	1992.08-1995.07	Estate Engine AAH	•		GWB1356	
90 (89, 89Q, 8A, B3)						
2.3 E 20V (123 kW)	1990.04-1991.07	Saloon Engine 7A	•		GWB1356	
	1990.04-1991.07	Saloon Engine 7A		o	GHA499044	
	1990.04-1991.07	Saloon Engine 7A		o	GWB0542	
2.3 E 20V Quattro (123 kW)	1990.04-1991.09	Saloon Engine 7A	•		GWB1356	
	1990.04-1991.09	Saloon Engine 7A		o	GWB1355	
A1 (8X1, 8XF)						
1.0 TFSi (70 kW)	2015.03-	Hatchback Engine CHZB With ABS	•		GHA336001	K
	2015.03-	Hatchback Engine CHZB With ABS		o	GHA228036	K
1.2 TFSi (63 kW)	2010.05-	Hatchback Engine CBZA 4 hole	•		GHA336007	K
	2010.05-	Hatchback Engine CBZA With ABS	•		GHA336001	K
	2010.05-	Hatchback Engine CBZA With ABS		o	GHA228036	K
	2010.05-	Hatchback Engine CBZA Without ABS	•		GHA336002	
	2010.05-	Hatchback Engine CBZA Without ABS		o	GHA228037	
1.4 TDi (66 kW)	2014.11-	Hatchback Engine CUSB With ABS	•		GHA336001	K
	2014.11-	Hatchback Engine CUSB With ABS		o	GHA228036	K
1.4 TFSi (103 kW)	2012.04-	Hatchback Engine CPTA 4 hole	•		GHA336007	K
	2012.04-	Hatchback Engine CPTA With ABS	•		GHA336001	K
	2012.04-	Hatchback Engine CPTA With ABS		o	GHA228036	K
	2012.04-	Hatchback Engine CPTA Without ABS	•		GHA336002	
1.4 TFSi (110 kW)	2014.11-	Hatchback Engine CZEA With ABS	•		GHA336001	K
	2014.11-	Hatchback Engine CZEA With ABS		o	GHA228036	K



	 YEAR		F	R	G-AP Ref.	KIT
AUDI						
A1 (8X1, 8XF)						
1.4 TFSi (136 kW)	2011.01-	Hatchback Engine CAVG/CTHG/CTJA 4 hole	•		GHA336007	K
	2011.01-	Hatchback Engine CAVG/CTHG/CTJA With ABS	•		GHA336001	K
	2011.01-	Hatchback Engine CAVG/CTHG/CTJA With ABS		◦	GHA228036	K
	2011.01-	Hatchback Engine CAVG/CTHG/CTJA Without ABS	•		GHA336002	
1.4 TFSi (90 kW)	2010.05-	Hatchback Engine CAXA/CNVA 4 hole	•		GHA336007	K
	2010.05-	Hatchback Engine CAXA/CNVA With ABS	•		GHA336001	K
	2010.05-	Hatchback Engine CAXA/CNVA With ABS		◦	GHA228036	K
	2010.05-	Hatchback Engine CAXA/CNVA Without ABS	•		GHA336002	
	2010.05-	Hatchback Engine CAXA/CNVA Without ABS		◦	GHA228037	
1.4 TFSi (92 kW)	2014.11-	Hatchback Engine CZCA/CZDB With ABS	•		GHA336001	K
	2014.11-	Hatchback Engine CZCA/CZDB With ABS		◦	GHA228036	K
1.6 TDi (66 kW)	2011.03-	Hatchback Engine CAYB 4 hole	•		GHA336007	K
	2011.03-	Hatchback Engine CAYB With ABS	•		GHA336001	K
	2011.03-	Hatchback Engine CAYB With ABS		◦	GHA228036	K
	2011.03-	Hatchback Engine CAYB Without ABS	•		GHA336002	
1.6 TDi (77 kW)	2010.05-	Hatchback Engine CAYC 4 hole	•		GHA336007	K
	2010.05-	Hatchback Engine CAYC With ABS	•		GHA336001	K
	2010.05-	Hatchback Engine CAYC With ABS		◦	GHA228036	K
	2010.05-	Hatchback Engine CAYC Without ABS	•		GHA336002	
	2010.05-	Hatchback Engine CAYC Without ABS		◦	GHA228037	
1.6 TDi (85 kW)	2014.11-	Hatchback Engine CXMA With ABS	•		GHA336001	K
	2014.11-	Hatchback Engine CXMA With ABS		◦	GHA228036	K
1.8 TFSi (141 kW)	2015.02-	Hatchback Engine DAJB With ABS	•		GHA336001	K
	2015.02-	Hatchback Engine DAJB With ABS		◦	GHA228036	K
2.0 TDi (100 kW)	2012.05-	Hatchback Engine CFHB 4 hole	•		GHA336007	K
	2012.05-	Hatchback Engine CFHB With ABS	•		GHA336001	K
	2012.05-	Hatchback Engine CFHB With ABS		◦	GHA228036	K
2.0 TDi (105 kW)	2011.09-	Hatchback Engine CFHD 4 hole	•		GHA336007	K
	2011.09-	Hatchback Engine CFHD With ABS	•		GHA336001	K
	2011.09-	Hatchback Engine CFHD With ABS		◦	GHA228036	K
	2011.09-	Hatchback Engine CFHD Without ABS	•		GHA336002	
2.0 TFSi Quattro (188 kW)	2012.03-	Hatchback Engine CDLH 4 hole	•		GHA336007	K
	2012.03-	Hatchback Engine CDLH With ABS	•		GHA336001	K
	2012.03-	Hatchback Engine CDLH Without ABS	•		GHA336002	
S1 Quattro (170 kW)	2014.03-	Hatchback Engine CWZA 4 hole	•		GHA336007	K
	2014.03-	Hatchback Engine CWZA With ABS	•		GHA336001	K
A1 (8XA, 8XK)						
1.2 TFSi (63 kW)	2012.01-	Hatchback Engine CBZA 4 hole	•		GHA336007	K
	2012.01-	Hatchback Engine CBZA With ABS	•		GHA336001	K
	2012.01-	Hatchback Engine CBZA With ABS		◦	GHA228036	K
	2012.01-	Hatchback Engine CBZA Without ABS	•		GHA336002	
1.4 TFSi (103 kW)	2012.04-	Hatchback Engine CPTA 4 hole	•		GHA336007	K
	2012.04-	Hatchback Engine CPTA With ABS	•		GHA336001	K
	2012.04-	Hatchback Engine CPTA With ABS		◦	GHA228036	K
	2012.04-	Hatchback Engine CPTA Without ABS	•		GHA336002	
1.4 TFSi (136 kW)	2011.11-	Hatchback Engine CAVG/CTHG/CTJA 4 hole	•		GHA336007	K
	2011.11-	Hatchback Engine CAVG/CTHG/CTJA With ABS	•		GHA336001	K
	2011.11-	Hatchback Engine CAVG/CTHG/CTJA With ABS		◦	GHA228036	K
	2011.11-	Hatchback Engine CAVG/CTHG/CTJA Without ABS	•		GHA336002	
1.4 TFSi (90 kW)	2011.11-	Hatchback Engine CAXA/CNVA 4 hole	•		GHA336007	K
	2011.11-	Hatchback Engine CAXA/CNVA With ABS	•		GHA336001	K
	2011.11-	Hatchback Engine CAXA/CNVA With ABS		◦	GHA228036	K
	2011.11-	Hatchback Engine CAXA/CNVA Without ABS	•		GHA336002	
1.6 TDi (66 kW)	2011.11-	Hatchback Engine CAYB 4 hole	•		GHA336007	K
	2011.11-	Hatchback Engine CAYB With ABS	•		GHA336001	K
	2011.11-	Hatchback Engine CAYB With ABS		◦	GHA228036	K
	2011.11-	Hatchback Engine CAYB Without ABS	•		GHA336002	
1.6 TDi (77 kW)	2011.11-	Hatchback Engine CAYC 4 hole	•		GHA336007	K
	2011.11-	Hatchback Engine CAYC With ABS	•		GHA336001	K
	2011.11-	Hatchback Engine CAYC With ABS		◦	GHA228036	K
	2011.11-	Hatchback Engine CAYC Without ABS	•		GHA336002	
2.0 TDi (100 kW)	2012.05-	Hatchback Engine CFHB 4 hole	•		GHA336007	K
	2012.05-	Hatchback Engine CFHB With ABS	•		GHA336001	K
	2012.05-	Hatchback Engine CFHB With ABS		◦	GHA228036	K



	 YEAR		F	R	G-AP Ref.	KIT
AUDI						
A1 (8XA, 8XK)						
2.0 TDi (105 kW)	2011.09-	Hatchback Engine CFHD 4 hole	•		GHA336007	K
	2011.09-	Hatchback Engine CFHD With ABS	•		GHA336001	K
	2011.09-	Hatchback Engine CFHD With ABS		o	GHA228036	K
	2011.09-	Hatchback Engine CFHD Without ABS	•		GHA336002	
A1 SPORTBACK (8XA, 8XK)						
1.0 TFSi (70 kW)	2015.03-	Hatchback Engine CHZB With ABS	•		GHA336001	K
	2015.03-	Hatchback Engine CHZB With ABS		o	GHA228036	K
1.4 TDi (66 kW)	2014.11-	Hatchback Engine CUSB With ABS	•		GHA336001	K
	2014.11-	Hatchback Engine CUSB With ABS		o	GHA228036	K
1.4 TFSi (110 kW)	2014.11-	Hatchback Engine CZEA With ABS	•		GHA336001	K
	2014.11-	Hatchback Engine CZEA With ABS		o	GHA228036	K
1.4 TFSi (92 kW)	2014.11-	Hatchback Engine CZCA/CZDB With ABS	•		GHA336001	K
	2014.11-	Hatchback Engine CZCA/CZDB With ABS		o	GHA228036	K
1.6 TDi (85 kW)	2014.11-	Hatchback Engine CXMA With ABS	•		GHA336001	K
	2014.11-	Hatchback Engine CXMA With ABS		o	GHA228036	K
1.8 TFSi (141 kW)	2015.02-	Hatchback Engine DAJB With ABS	•		GHA336001	K
	2015.02-	Hatchback Engine DAJB With ABS		o	GHA228036	K
S1 Quattro (170 kW)	2014.03-	Hatchback Engine CWZA 4 hole	•		GHA336007	K
	2014.03-	Hatchback Engine CWZA With ABS	•		GHA336001	K
A2 (8Z0)						
1.2 TDi (45 kW)	2001.03-2005.08	Hatchback Engine ANY	•		GHA320003	K
	2001.03-2005.08	Hatchback Engine ANY		o	GHA225029	K
1.4 (55 kW)	2000.02-2005.08	Hatchback Engine AUA/BBY With ABS	•		GHA336001	K
	2000.02-2005.08	Hatchback Engine AUA/BBY With ABS		o	GHA228036	K
	2000.02-2005.08	Hatchback Engine AUA/BBY Without ABS	•		GHA336002	
	2000.02-2005.08	Hatchback Engine AUA/BBY Without ABS		o	GHA228037	
1.4 TDi (55 kW)	2000.02-2005.08	Hatchback Engine AMF/BHC With ABS	•		GHA336001	K
	2000.02-2005.08	Hatchback Engine AMF/BHC With ABS		o	GHA228036	K
	2000.02-2005.08	Hatchback Engine AMF/BHC Without ABS	•		GHA336002	
	2000.02-2005.08	Hatchback Engine AMF/BHC Without ABS		o	GHA228037	
1.4 TDi (66 kW)	2003.09-2004.12	Hatchback Engine ATL With ABS	•		GHA336001	K
	2003.09-2004.12	Hatchback Engine ATL With ABS		o	GHA228036	K
	2003.09-2004.12	Hatchback Engine ATL Without ABS	•		GHA336002	
	2003.09-2004.12	Hatchback Engine ATL Without ABS		o	GHA228037	
1.6 FSi (81 kW)	2002.05-2005.08	Hatchback Engine BAD With ABS	•		GHA336001	K
	2002.05-2005.08	Hatchback Engine BAD With ABS		o	GHA228036	K
	2002.05-2005.08	Hatchback Engine BAD Without ABS	•		GHA336002	
	2002.05-2005.08	Hatchback Engine BAD Without ABS		o	GHA228037	
A3 (8L1)						
1.6 (74 kW)	1996.09-2003.05	Hatchback Engine AEH/AKL/APF	•		GHA436002	K
	1996.09-2003.05	Hatchback Engine AEH/AKL/APF	•		GWB3455	
	1996.09-2003.05	Hatchback Engine AEH/AKL/APF With ABS		o	GHA230051	K
1.6 (75 kW)	2000.08-2003.05	Hatchback Engine AVU/BFQ	•		GHA436002	K
	2000.08-2003.05	Hatchback Engine AVU/BFQ	•		GWB3455	
	2000.08-2003.05	Hatchback Engine AVU/BFQ With ABS		o	GHA230051	K
1.8 (92 kW)	1996.09-2003.05	Hatchback Engine AGN/APG	•		GHA436002	K
	1996.09-2003.05	Hatchback Engine AGN/APG	•		GWB3455	
	1996.09-2003.05	Hatchback Engine AGN/APG With ABS		o	GHA230051	K
1.8 S3 Quattro (154 kW)	1999.03-2002.04	Hatchback Engine APY/AMK	•		GWB3455	
	1999.03-2002.04	Hatchback Engine APY/AMK	•		GWB3607	
	1999.03-2002.04	Hatchback Engine APY/AMK		o	GHA436002	K
1.8 S3 Quattro (165 kW)	2001.10-2003.05	Hatchback Engine BAM	•		GWB3607	
	2001.10-2003.05	Hatchback Engine BAM		o	GHA436002	K
	2001.10-2003.05	Hatchback Engine BAM		o	GWB3455	
1.8 T (110 kW)	1996.12-2003.05	Hatchback Engine AGU/AQA/ARZ/AUM	•		GHA436002	K
	1996.12-2003.05	Hatchback Engine AGU/AQA/ARZ/AUM	•		GWB3455	
	1996.12-2003.05	Hatchback Engine AGU/AQA/ARZ/AUM With ABS		o	GHA230051	K
1.8 T (132 kW)	1998.12-2003.05	Hatchback Engine AJQ/APP/ARY/AUQ	•		GHA436002	K
	1998.12-2003.05	Hatchback Engine AJQ/APP/ARY/AUQ	•		GWB3455	
	1998.12-2003.05	Hatchback Engine AJQ/APP/ARY/AUQ With ABS		o	GHA230051	K
1.8 T Quattro (110 kW)	1996.12-2003.05	Hatchback Engine AGU/AQA/ARX	•		GWB3455	
	1996.12-2003.05	Hatchback Engine AGU/AQA/ARX		o	GHA436002	K
1.8 T Quattro (132 kW)	1998.10-2003.05	Hatchback Engine AJQ/ARY	•		GWB3455	
	1998.10-2003.05	Hatchback Engine AJQ/ARY		o	GHA436002	K



	 YEAR		F	R	G-AP Ref.	KIT
AUDI						
A3 (8L1)						
1.9 TDi (66 kW)	1996.09-2001.07	Hatchback Engine AGR/ALH	•		GHA436002	K
	1996.09-2001.07	Hatchback Engine AGR/ALH	•		GWB3455	
	1996.09-2001.07	Hatchback Engine AGR/ALH With ABS		○	GHA230051	K
1.9 TDi (74 kW)	2000.10-2003.05	Hatchback Engine ATD/AXR	•		GHA436002	K
	2000.10-2003.05	Hatchback Engine ATD/AXR	•		GWB3455	
	2000.10-2003.05	Hatchback Engine ATD/AXR With ABS		○	GHA230051	K
1.9 TDi (81 kW)	1997.08-2001.07	Hatchback Engine AHF/ASV	•		GHA436002	K
	1997.08-2001.07	Hatchback Engine AHF/ASV	•		GWB3455	
	1997.08-2001.07	Hatchback Engine AHF/ASV With ABS		○	GHA230051	K
1.9 TDi (96 kW)	2000.08-2003.05	Hatchback Engine ASZ	•		GHA436002	K
	2000.08-2003.05	Hatchback Engine ASZ	•		GWB3455	
	2000.08-2003.05	Hatchback Engine ASZ With ABS		○	GHA230051	K
1.9 TDi Quattro (96 kW)	2000.08-2003.05	Hatchback Engine ASZ	•		GWB3455	
	2000.08-2003.05	Hatchback Engine ASZ		○	GHA436002	K
A3 (8P1)						
1.2 TSi (77 kW)	2010.04-2012.08	Hatchback Engine CBZB 3 hole	•		GHA336004	K
	2010.04-2012.08	Hatchback Engine CBZB 4 hole	•		GHA336007	K
	2010.04-2012.08	Hatchback Engine CBZB Inner Diameter [30mm]		○	GHA230082	K
	2010.04-2012.08	Hatchback Engine CBZB Inner Diameter [32mm]		○	GHA232018	K
1.4 TFSi (92 kW)	2007.09-2012.08	Hatchback Engine CAXC/CMSA 3 hole	•		GHA336004	K
	2007.09-2012.08	Hatchback Engine CAXC/CMSA 4 hole	•		GHA336007	K
	2007.09-2012.08	Hatchback Engine CAXC/CMSA Inner Diameter [30mm]		○	GHA230082	K
	2007.09-2012.08	Hatchback Engine CAXC/CMSA Inner Diameter [32mm]		○	GHA232018	K
1.6 (75 kW)	2003.05-2012.08	Hatchback Engine BGU/BSE/BSF/CCSA/CMXA 3 hole	•		GHA336004	K
	2003.05-2012.08	Hatchback Engine BGU/BSE/BSF/CCSA/CMXA 4 hole	•		GHA336007	K
	2003.05-2012.08	Hatchback Engine BGU/BSE/BSF/CCSA/CMXA Inner Diameter [30mm]		○	GHA230082	K
	2003.05-2012.08	Hatchback Engine BGU/BSE/BSF/CCSA/CMXA Inner Diameter [32mm]		○	GHA232018	K
1.6 E-Power (75 kW)	2011.01-2012.08	Hatchback Engine CMXA 3 hole	•		GHA336004	K
	2011.01-2012.08	Hatchback Engine CMXA 4 hole	•		GHA336007	K
	2011.01-2012.08	Hatchback Engine CMXA Inner Diameter [30mm]		○	GHA230082	K
	2011.01-2012.08	Hatchback Engine CMXA Inner Diameter [32mm]		○	GHA232018	K
1.6 FSi (85 kW)	2003.08-2007.04	Hatchback Engine BAG/BLF/BLP 3 hole	•		GHA336004	K
	2003.08-2007.04	Hatchback Engine BAG/BLF/BLP 4 hole	•		GHA336007	K
	2003.08-2007.04	Hatchback Engine BAG/BLF/BLP Inner Diameter [30mm]		○	GHA230082	K
	2003.08-2007.04	Hatchback Engine BAG/BLF/BLP Inner Diameter [32mm]		○	GHA232018	K
1.6 TDi (66 kW)	2009.05-2012.08	Hatchback Engine CAYB 3 hole	•		GHA336004	K
	2009.05-2012.08	Hatchback Engine CAYB 4 hole	•		GHA336007	K
	2009.05-2012.08	Hatchback Engine CAYB Inner Diameter [30mm]		○	GHA230082	K
	2009.05-2012.08	Hatchback Engine CAYB Inner Diameter [32mm]		○	GHA232018	K
1.6 TDi (77 kW)	2009.05-2012.08	Hatchback Engine CAYC 3 hole	•		GHA336004	K
	2009.05-2012.08	Hatchback Engine CAYC 4 hole	•		GHA336007	K
	2009.05-2012.08	Hatchback Engine CAYC Inner Diameter [30mm]		○	GHA230082	K
	2009.05-2012.08	Hatchback Engine CAYC Inner Diameter [32mm]		○	GHA232018	K
1.8 T (110 kW)	2006.08-2012.08	Hatchback Engine BPU 3 hole	•		GHA336004	K
	2006.08-2012.08	Hatchback Engine BPU 4 hole	•		GHA336007	K
	2006.08-2012.08	Hatchback Engine BPU Inner Diameter [30mm]		○	GHA230082	K
	2006.08-2012.08	Hatchback Engine BPU Inner Diameter [32mm]		○	GHA232018	K
1.8 TFSi (118 kW)	2006.11-2012.08	Hatchback Engine BYT/BZB/CDAA 3 hole	•		GHA336004	K
	2006.11-2012.08	Hatchback Engine BYT/BZB/CDAA 4 hole	•		GHA336007	K
	2006.11-2012.08	Hatchback Engine BYT/BZB/CDAA Inner Diameter [30mm]		○	GHA230082	K
	2006.11-2012.08	Hatchback Engine BYT/BZB/CDAA Inner Diameter [32mm]		○	GHA232018	K
1.8 TFSi Quattro (118 kW)	2008.07-2012.08	Hatchback Engine CDAA 4 hole	•		GHA336007	K
1.9 TDi (77 kW)	2003.05-2007.04	Hatchback Engine BKC/BLS/BXE 3 hole	•		GHA336004	K
	2003.05-2007.04	Hatchback Engine BKC/BLS/BXE 4 hole	•		GHA336007	K
	2003.05-2007.04	Hatchback Engine BKC/BLS/BXE Inner Diameter [30mm]		○	GHA230082	K
	2003.05-2007.04	Hatchback Engine BKC/BLS/BXE Inner Diameter [32mm]		○	GHA232018	K
2.0 (120 kW)	2006.06-2012.08	Hatchback 3 hole	•		GHA336004	K
	2006.06-2012.08	Hatchback 4 hole	•		GHA336007	K
	2006.06-2012.08	Hatchback Inner Diameter [30mm]		○	GHA230082	K
	2006.06-2012.08	Hatchback Inner Diameter [32mm]		○	GHA232018	K
2.0 FSi (110 kW)	2003.05-2008.06	Hatchback Engine AXW/BLR/BLX/BLY/BMB/BVY/BVZ 3 hole	•		GHA336004	K
	2003.05-2008.06	Hatchback Engine AXW/BLR/BLX/BLY/BMB/BVY/BVZ 4 hole	•		GHA336007	K
	2003.05-2008.06	Hatchback Engine AXW/BLR/BLX/BLY/BMB/BVY/BVZ Inner Diameter [30mm]		○	GHA230082	K
	2003.05-2008.06	Hatchback Engine AXW/BLR/BLX/BLY/BMB/BVY/BVZ Inner Diameter [32mm]		○	GHA232018	K



	 YEAR		F	R	G-AP Ref.	KIT
AUDI						
A3 (8P1)						
2.0 S3 Quattro (188 kW)	2007.02-2012.08	Hatchback Engine CDLC/BZC 4 hole	•		GHA336007	K
2.0 S3 Quattro (195 kW)	2006.10-2007.12	Hatchback Engine BHZ/CDLA 4 hole	•		GHA336007	K
2.0 TDi (100 kW)	2003.05-2012.08	Hatchback Engine AZV/CBAA/CFFA 3 hole	•		GHA336004	K
	2003.05-2012.08	Hatchback Engine AZV/CBAA/CFFA 4 hole	•		GHA336007	K
	2003.05-2012.08	Hatchback Engine AZV/CBAA/CFFA Inner Diameter [30mm]		○	GHA230082	K
	2003.05-2012.08	Hatchback Engine AZV/CBAA/CFFA Inner Diameter [32mm]		○	GHA232018	K
2.0 TDi (103 kW)	2007.02-2007.04	Hatchback Engine BMM 3 hole	•		GHA336004	K
	2007.02-2007.04	Hatchback Engine BMM 4 hole	•		GHA336007	K
	2007.02-2007.04	Hatchback Engine BMM Inner Diameter [30mm]		○	GHA230082	K
2.0 TDi (120 kW)	2006.06-2008.06	Hatchback Engine BUY 3 hole	•		GHA336004	K
	2006.06-2008.06	Hatchback Engine BUY 4 hole	•		GHA336007	K
	2006.06-2008.06	Hatchback Engine BUY Inner Diameter [30mm]		○	GHA230082	K
2.0 TDi (125 kW)	2006.05-2007.04	Hatchback Engine BMN/CBBB/CFGB 3 hole	•		GHA336004	K
	2006.05-2007.04	Hatchback Engine BMN/CBBB/CFGB 4 hole	•		GHA336007	K
	2006.05-2007.04	Hatchback Engine BMN/CBBB/CFGB Inner Diameter [30mm]		○	GHA230082	K
	2006.05-2007.04	Hatchback Engine BMN/CBBB/CFGB Inner Diameter [32mm]		○	GHA232018	K
2.0 TDi 16V (103 kW)	2003.05-2012.08	Hatchback Engine BKD/CBAB/CFFB/CLJA 3 hole	•		GHA336004	K
	2003.05-2012.08	Hatchback Engine BKD/CBAB/CFFB/CLJA 4 hole	•		GHA336007	K
	2003.05-2012.08	Hatchback Engine BKD/CBAB/CFFB/CLJA Inner Diameter [30mm]		○	GHA230082	K
	2003.05-2012.08	Hatchback Engine BKD/CBAB/CFFB/CLJA Inner Diameter [32mm]		○	GHA232018	K
2.0 TDi 16V Quattro (103 kW)	2004.10-2007.04	Hatchback Engine BKD/CBAB/CFFB 4 hole	•		GHA336007	K
2.0 TDi Quattro (100 kW)	2003.05-2008.06	Hatchback Engine AZV 4 hole	•		GHA336007	K
2.0 TDi Quattro (103 kW)	2006.01-2008.06	Hatchback Engine BMM 4 hole	•		GHA336007	K
2.0 TDi Quattro (125 kW)	2006.05-2007.04	Hatchback Engine BMN/CBBB/CFGB 4 hole	•		GHA336007	K
2.0 TFSi (147 kW)	2004.07-2007.04	Hatchback Engine AXX/BWA/CAWB/CCZA 3 hole	•		GHA336004	K
	2004.07-2007.04	Hatchback Engine AXX/BWA/CAWB/CCZA 4 hole	•		GHA336007	K
	2004.07-2007.04	Hatchback Engine AXX/BWA/CAWB/CCZA Inner Diameter [30mm]		○	GHA230082	K
	2004.07-2007.04	Hatchback Engine AXX/BWA/CAWB/CCZA Inner Diameter [32mm]		○	GHA232018	K
2.0 TFSi Quattro (147 kW)	2004.10-2007.04	Hatchback Engine AXX/BWA/CCZA 4 hole	•		GHA336007	K
3.2 V6 Quattro (184 kW)	2003.08-2007.04	Hatchback Engine BDB/BMJ/BUB 4 hole	•		GHA336007	K
A3 (8P7)						
1.2 TFSi (77 kW)	2010.03-	Convertible Engine CBZB 3 hole	•		GHA336004	K
	2010.03-	Convertible Engine CBZB 4 hole	•		GHA336007	K
	2010.03-	Convertible Engine CBZB Inner Diameter [30mm]		○	GHA230082	K
1.4 TFSi (92 kW)	2011.02-	Convertible Engine CAXC 3 hole	•		GHA336004	K
	2011.02-	Convertible Engine CAXC 4 hole	•		GHA336007	K
	2011.02-	Convertible Engine CAXC Inner Diameter [30mm]		○	GHA230082	K
1.6 (75 kW)	2008.09-	Convertible Engine BSE 3 hole	•		GHA336004	K
	2008.09-	Convertible Engine BSE 4 hole	•		GHA336007	K
	2008.09-	Convertible Engine BSE Inner Diameter [30mm]		○	GHA230082	K
1.6 TDi (77 kW)	2009.05-	Convertible Engine CAYC 3 hole	•		GHA336004	K
	2009.05-	Convertible Engine CAYC 4 hole	•		GHA336007	K
	2009.05-	Convertible Engine CAYC Inner Diameter [30mm]		○	GHA230082	K
1.8 TFSi (118 kW)	2008.04-	Convertible Engine BZB/CDAA 3 hole	•		GHA336004	K
	2008.04-	Convertible Engine BZB/CDAA 4 hole	•		GHA336007	K
	2008.04-	Convertible Engine BZB/CDAA Inner Diameter [30mm]		○	GHA230082	K
1.9 TDi (77 kW)	2008.04-	Convertible Engine BLS 3 hole	•		GHA336004	K
	2008.04-	Convertible Engine BLS 4 hole	•		GHA336007	K
	2008.04-	Convertible Engine BLS Inner Diameter [30mm]		○	GHA230082	K
2.0 TDi (100 kW)	2008.04-	Convertible Engine CFFA/CBAA 3 hole	•		GHA336004	K
	2008.04-	Convertible Engine CFFA/CBAA 4 hole	•		GHA336007	K
	2008.04-	Convertible Engine CFFA/CBAA Inner Diameter [30mm]		○	GHA230082	K
2.0 TDi (103 kW)	2008.04-	Convertible Engine CBAB/CFFB 3 hole	•		GHA336004	K
	2008.04-	Convertible Engine CBAB/CFFB 4 hole	•		GHA336007	K
	2008.04-	Convertible Engine CBAB/CFFB Inner Diameter [30mm]		○	GHA230082	K
2.0 TFSi (147 kW)	2008.04-	Convertible Engine CAWB/CCZA 3 hole	•		GHA336004	K
	2008.04-	Convertible Engine CAWB/CCZA 4 hole	•		GHA336007	K
	2008.04-	Convertible Engine CAWB/CCZA Inner Diameter [30mm]		○	GHA230082	K
A3 (8PA)						
1.2 TSi (77 kW)	2010.04-	Hatchback Engine CBZB 3 hole	•		GHA336004	K
	2010.04-	Hatchback Engine CBZB 4 hole	•		GHA336007	K
	2010.04-	Hatchback Engine CBZB Inner Diameter [30mm]		○	GHA230082	K
	2010.04-	Hatchback Engine CBZB Inner Diameter [32mm]		○	GHA232018	K
1.4 TFSi (92 kW)	2007.09-	Hatchback Engine CAXC/CMSA 3 hole	•		GHA336004	K



	 YEAR		F	R	G-AP Ref.	KIT
AUDI						
A3 (8PA)						
1.4 TFSi (92 kW)	2007.09-	Hatchback Engine CAXC/CMSA 4 hole	•		GHA336007	K
	2007.09-	Hatchback Engine CAXC/CMSA Inner Diameter [30mm]		○	GHA230082	K
	2007.09-	Hatchback Engine CAXC/CMSA Inner Diameter [32mm]		○	GHA232018	K
1.6 (75 kW)	2005.06-2007.04	Hatchback Engine CMXA/CCSA/BSF/BSE/BGU 3 hole	•		GHA336004	K
	2005.06-2007.04	Hatchback Engine CMXA/CCSA/BSF/BSE/BGU 4 hole	•		GHA336007	K
	2005.06-2007.04	Hatchback Engine CMXA/CCSA/BSF/BSE/BGU Inner Diameter [30mm]		○	GHA230082	K
	2005.06-2007.04	Hatchback Engine CMXA/CCSA/BSF/BSE/BGU Inner Diameter [32mm]		○	GHA232018	K
1.6 E-Power (75 kW)	2011.01-	Hatchback Engine CMXA 3 hole	•		GHA336004	K
	2011.01-	Hatchback Engine CMXA 4 hole	•		GHA336007	K
	2011.01-	Hatchback Engine CMXA Inner Diameter [30mm]		○	GHA230082	K
	2011.01-	Hatchback Engine CMXA Inner Diameter [32mm]		○	GHA232018	K
1.6 FSi (85 kW)	2004.09-	Hatchback Engine BLF/BLP 3 hole	•		GHA336004	K
	2004.09-	Hatchback Engine BLF/BLP 4 hole	•		GHA336007	K
	2004.09-	Hatchback Engine BLF/BLP Inner Diameter [30mm]		○	GHA230082	K
1.6 TDi (66 kW)	2009.05-	Hatchback Engine CAYB 3 hole	•		GHA336004	K
	2009.05-	Hatchback Engine CAYB 4 hole	•		GHA336007	K
	2009.05-	Hatchback Engine CAYB Inner Diameter [30mm]		○	GHA230082	K
	2009.05-	Hatchback Engine CAYB Inner Diameter [32mm]		○	GHA232018	K
1.6 TDi (77 kW)	2009.05-	Hatchback Engine CAYC 3 hole	•		GHA336004	K
	2009.05-	Hatchback Engine CAYC 4 hole	•		GHA336007	K
	2009.05-	Hatchback Engine CAYC Inner Diameter [30mm]		○	GHA230082	K
	2009.05-	Hatchback Engine CAYC Inner Diameter [32mm]		○	GHA232018	K
1.8 TFSi (118 kW)	2006.10-2007.04	Hatchback Engine BYT/BZB/CDA 3 hole	•		GHA336004	K
	2006.10-2007.04	Hatchback Engine BYT/BZB/CDA 4 hole	•		GHA336007	K
	2006.10-2007.04	Hatchback Engine BYT/BZB/CDA Inner Diameter [30mm]		○	GHA230082	K
	2006.10-2007.04	Hatchback Engine BYT/BZB/CDA Inner Diameter [32mm]		○	GHA232018	K
1.8 TFSi Quattro (118 kW)	2008.07-	Hatchback Engine CDA 4 hole	•		GHA336007	K
1.9 TDi (77 kW)	2005.06-2007.04	Hatchback Engine BKC/BLS/BXE 3 hole	•		GHA336004	K
	2005.06-2007.04	Hatchback Engine BKC/BLS/BXE 4 hole	•		GHA336007	K
	2005.06-2007.04	Hatchback Engine BKC/BLS/BXE Inner Diameter [30mm]		○	GHA230082	K
	2005.06-2007.04	Hatchback Engine BKC/BLS/BXE Inner Diameter [32mm]		○	GHA232018	K
2.0 FSi (110 kW)	2005.06-2007.04	Hatchback Engine BLR/BLX/BLY/BMB/BVY/BVZ 3 hole	•		GHA336004	K
	2005.06-2007.04	Hatchback Engine BLR/BLX/BLY/BMB/BVY/BVZ 4 hole	•		GHA336007	K
	2005.06-2007.04	Hatchback Engine BLR/BLX/BLY/BMB/BVY/BVZ Inner Diameter [30mm]		○	GHA230082	K
2.0 S3 Quattro (188 kW)	2008.07-	Hatchback Engine CDLC 4 hole	•		GHA336007	K
2.0 S3 Quattro (195 kW)	2008.06-	Hatchback Engine BHZ/CDLA 4 hole	•		GHA336007	K
2.0 TDi (100 kW)	2004.09-	Hatchback Engine CFFA/CBAA/AZV 3 hole	•		GHA336004	K
	2004.09-	Hatchback Engine CFFA/CBAA/AZV 4 hole	•		GHA336007	K
	2004.09-	Hatchback Engine CFFA/CBAA/AZV Inner Diameter [30mm]		○	GHA230082	K
	2004.09-	Hatchback Engine CFFA/CBAA/AZV Inner Diameter [32mm]		○	GHA232018	K
2.0 TDi (103 kW)	2004.11-2007.04	Hatchback Engine BMM 3 hole	•		GHA336004	K
	2004.11-2007.04	Hatchback Engine BMM 4 hole	•		GHA336007	K
	2004.11-2007.04	Hatchback Engine BMM Inner Diameter [30mm]		○	GHA230082	K
2.0 TDi (120 kW)	2006.06-2008.06	Hatchback Engine BUY 3 hole	•		GHA336004	K
	2006.06-2008.06	Hatchback Engine BUY 4 hole	•		GHA336007	K
	2006.06-2008.06	Hatchback Engine BUY Inner Diameter [30mm]		○	GHA230082	K
2.0 TDi (125 kW)	2006.05-2007.04	Hatchback Engine BMN/CBBB/CFGB 3 hole	•		GHA336004	K
	2006.05-2007.04	Hatchback Engine BMN/CBBB/CFGB 4 hole	•		GHA336007	K
	2006.05-2007.04	Hatchback Engine BMN/CBBB/CFGB Inner Diameter [30mm]		○	GHA230082	K
	2006.05-2007.04	Hatchback Engine BMN/CBBB/CFGB Inner Diameter [32mm]		○	GHA232018	K
2.0 TDi 16V (103 kW)	2005.06-2007.02	Hatchback Engine BKD/CBAB/CFFB/CLJA 3 hole	•		GHA336004	K
	2005.06-2007.02	Hatchback Engine BKD/CBAB/CFFB/CLJA 4 hole	•		GHA336007	K
	2005.06-2007.02	Hatchback Engine BKD/CBAB/CFFB/CLJA Inner Diameter [30mm]		○	GHA230082	K
	2005.06-2007.02	Hatchback Engine BKD/CBAB/CFFB/CLJA Inner Diameter [32mm]		○	GHA232018	K
2.0 TDi 16V Quattro (103 kW)	2005.11-	Hatchback Engine BKD/CBAB/CFFB 4 hole	•		GHA336007	K
2.0 TDi Quattro (103 kW)	2006.01-2008.06	Hatchback Engine BMM 4 hole	•		GHA336007	K
2.0 TDi Quattro (125 kW)	2006.05-2007.04	Hatchback Engine BMN/CBBB/CFGB 4 hole	•		GHA336007	K
2.0 TFSi (147 kW)	2005.06-2007.04	Hatchback Engine AXX/BWA/CAWB/CBFA/CCZA 3 hole	•		GHA336004	K
	2005.06-2007.04	Hatchback Engine AXX/BWA/CAWB/CBFA/CCZA 4 hole	•		GHA336007	K
	2005.06-2007.04	Hatchback Engine AXX/BWA/CAWB/CBFA/CCZA Inner Diameter [30mm]		○	GHA230082	K
	2005.06-2007.04	Hatchback Engine AXX/BWA/CAWB/CBFA/CCZA Inner Diameter [32mm]		○	GHA232018	K
2.0 TFSi Quattro (147 kW)	2007.02-2007.04	Hatchback Engine AXX/BPY/BWA/CCZA 4 hole	•		GHA336007	K
2.5 RS3 Quattro (250 kW)	2011.01-	Hatchback Engine CEPA 4 hole		○	GHA336007	K
3.2 V6 Quattro (184 kW)	2005.06-2007.04	Hatchback Engine BMJ/BUB 4 hole	•		GHA336007	K



	 YEAR		F	R	G-AP Ref.	KIT
AUDI						
A3 (8V1)						
1.2 TFSi (77 kW)	2013.02-	Hatchback Engine CJZA 3 hole	•		GHA336004	K
	2013.02-	Hatchback Engine CJZA Inner Diameter [30mm]		○	GHA230082	K
1.2 TFSi (81 kW)	2014.05-	Hatchback Engine CYVB 3 hole	•		GHA336004	K
	2014.05-	Hatchback Engine CYVB Inner Diameter [30mm]		○	GHA230082	K
1.4 TFSi (103 kW)	2013.03-	Hatchback Engine CPTA 3 hole	•		GHA336004	K
	2013.03-	Hatchback Engine CPTA Inner Diameter [30mm]		○	GHA230082	K
1.4 TFSi (110 kW)	2014.05-	Hatchback Engine CZEA 3 hole	•		GHA336004	K
	2014.05-	Hatchback Engine CZEA Inner Diameter [30mm]		○	GHA230082	K
1.4 TFSi (90 kW)	2012.04-	Hatchback Engine CMBA/CXSA 3 hole	•		GHA336004	K
	2012.04-	Hatchback Engine CMBA/CXSA Inner Diameter [30mm]		○	GHA230082	K
1.4 TFSi (92 kW)	2014.05-	Hatchback Engine CXSB/CZCA 3 hole	•		GHA336004	K
	2014.05-	Hatchback Engine CXSB/CZCA Inner Diameter [30mm]		○	GHA230082	K
1.6 TDi (77 kW)	2012.10-	Hatchback Engine CLHA 3 hole	•		GHA336004	K
	2012.10-	Hatchback Engine CLHA Inner Diameter [30mm]		○	GHA230082	K
1.6 TDi (81 kW)	2013.09-	Hatchback Engine CRKB/CXXB/DBKA 3 hole	•		GHA336004	K
	2013.09-	Hatchback Engine CRKB/CXXB/DBKA Inner Diameter [30mm]		○	GHA230082	K
1.8 TFSi (132 kW)	2012.04-	Hatchback Engine CJSA 3 hole	•		GHA336004	K
	2012.04-	Hatchback Engine CJSA Inner Diameter [30mm]		○	GHA230082	K
1.8 TFSi Quattro (132 kW)	2012.08-	Hatchback Engine CJSB 3 hole	•		GHA336004	K
2.0 S3 Quattro (206 kW)	2013.02-	Hatchback Engine CJXB 3 hole	•		GHA336004	K
2.0 TDi (100 kW)	2013.05-	Hatchback Engine CRBD/CRLC 3 hole	•		GHA336004	K
	2013.05-	Hatchback Engine CRBD/CRLC Inner Diameter [30mm]		○	GHA230082	K
2.0 TDi (105 kW)	2012.09-	Hatchback Engine CRFC 3 hole	•		GHA336004	K
	2012.09-	Hatchback Engine CRFC Inner Diameter [30mm]		○	GHA230082	K
2.0 TDi (110 kW)	2012.04-	Hatchback Engine CRBC/CRLB/CRUA 3 hole	•		GHA336004	K
	2012.04-	Hatchback Engine CRBC/CRLB/CRUA Inner Diameter [30mm]		○	GHA230082	K
2.0 TDi (135 kW)	2013.05-	Hatchback Engine CUNA 3 hole	•		GHA336004	K
	2013.05-	Hatchback Engine CUNA Inner Diameter [30mm]		○	GHA230082	K
2.0 TDi (81 kW)	2013.01-	Hatchback Engine CRFA 3 hole	•		GHA336004	K
	2013.01-	Hatchback Engine CRFA Inner Diameter [30mm]		○	GHA230082	K
2.0 TDi Quattro (110 kW)	2012.10-	Hatchback Engine CRBC 3 hole	•		GHA336004	K
2.0 TDi Quattro (135 kW)	2012.12-	Hatchback Engine CUNA 3 hole	•		GHA336004	K
S3 Quattro (210 kW)	2014.05-	Hatchback Engine CJXF 3 hole	•		GHA336004	K
S3 Quattro (221 kW)	2012.11-	Hatchback Engine CJXC 3 hole	•		GHA336004	K
A3 (8V7)						
1.4 TFSi (103 kW)	2013.10-	Convertible Engine CPTA 3 hole	•		GHA336004	K
	2013.10-	Convertible Engine CPTA Inner Diameter [30mm]		○	GHA230082	K
1.4 TFSi (110 kW)	2014.05-	Convertible Engine CZEA 3 hole	•		GHA336004	K
	2014.05-	Convertible Engine CZEA Inner Diameter [30mm]		○	GHA230082	K
1.4 TFSi (92 kW)	2014.02-	Convertible Engine CXSB 3 hole	•		GHA336004	K
	2014.02-	Convertible Engine CXSB Inner Diameter [30mm]		○	GHA230082	K
1.6 TDi (81 kW)	2014.02-	Convertible Engine CRKB 3 hole	•		GHA336004	K
	2014.02-	Convertible Engine CRKB Inner Diameter [30mm]		○	GHA230082	K
1.8 TFSi (125 kW)	2014.05-	Convertible Engine CNSB 3 hole	•		GHA336004	K
	2014.05-	Convertible Engine CNSB Inner Diameter [30mm]		○	GHA230082	K
1.8 TFSi (132 kW)	2013.10-	Convertible Engine CJSA 3 hole	•		GHA336004	K
	2013.10-	Convertible Engine CJSA Inner Diameter [30mm]		○	GHA230082	K
1.8 TFSi Quattro (132 kW)	2014.03-	Convertible Engine CJSB 3 hole	•		GHA336004	K
2.0 S3 Quattro (221 kW)	2014.04-	Convertible Engine CJXC 3 hole	•		GHA336004	K
2.0 TDi (100 kW)	2013.10-	Convertible Engine CRLC 3 hole	•		GHA336004	K
	2013.10-	Convertible Engine CRLC Inner Diameter [30mm]		○	GHA230082	K
2.0 TDi (135 kW)	2014.05-	Convertible Engine CUNA 3 hole	•		GHA336004	K
	2014.05-	Convertible Engine CUNA Inner Diameter [30mm]		○	GHA230082	K
2.0 TDi Quattro (135 kW)	2014.05-	Convertible Engine CUNA 3 hole	•		GHA336004	K
2.0 TFSi Quattro (162 kW)	2014.05-	Convertible Engine CNTC 3 hole	•		GHA336004	K
S3 Quattro (210 kW)	2014.03-	Convertible Engine CJXF 3 hole	•		GHA336004	K
A3 CONVERTIBLE (8V7)						
2.0 TDi (110 kW)	2013.10-	Convertible Engine CRLB 3 hole	•		GHA336004	K
	2013.10-	Convertible Engine CRLB Inner Diameter [30mm]		○	GHA230082	K
2.0 TDi Quattro (110 kW)	2014.03-	Convertible Engine CRLB 3 hole	•		GHA336004	K
A3 LIMOUSINE (8VS)						
1.2 TFSi (77 kW)	2013.10-	Saloon Engine CJZA 3 hole	•		GHA336004	K
	2013.10-	Saloon Engine CJZA Inner Diameter [30mm]		○	GHA230082	K
1.2 TFSi (81 kW)	2014.05-	Saloon Engine CYVB 3 hole	•		GHA336004	K



	 YEAR		F	R	G-AP Ref.	KIT
AUDI						
A3 LIMOUSINE (8VS)						
1.2 TFSi (81 kW)	2014.05-	Saloon Engine CYVB Inner Diameter [30mm]		o	GHA230082	K
1.4 TFSi (103 kW)	2013.05-	Saloon Engine CPTA 3 hole	•		GHA336004	K
	2013.05-	Saloon Engine CPTA Inner Diameter [30mm]		o	GHA230082	K
1.4 TFSi (110 kW)	2014.05-	Saloon Engine CZEA 3 hole	•		GHA336004	K
	2014.05-	Saloon Engine CZEA Inner Diameter [30mm]		o	GHA230082	K
1.4 TFSi (90 kW)	2013.09-	Saloon Engine CMBA/CXSA 3 hole	•		GHA336004	K
	2013.09-	Saloon Engine CMBA/CXSA Inner Diameter [30mm]		o	GHA230082	K
1.4 TFSi (92 kW)	2013.09-	Saloon Engine CXSB 3 hole	•		GHA336004	K
	2013.09-	Saloon Engine CXSB Inner Diameter [30mm]		o	GHA230082	K
1.6 TDi (77 kW)	2013.09-	Saloon Engine CLHA 3 hole	•		GHA336004	K
	2013.09-	Saloon Engine CLHA Inner Diameter [30mm]		o	GHA230082	K
1.6 TDi (81 kW)	2014.05-	Saloon Engine CRKB 3 hole	•		GHA336004	K
	2014.05-	Saloon Engine CRKB Inner Diameter [30mm]		o	GHA230082	K
1.6 TDi Quattro (81 kW)	2015.05-	Saloon Engine CXXB 3 hole	•		GHA336004	K
1.8 TFSi (125 kW)	2013.11-	Saloon Engine CNSB 3 hole	•		GHA336004	K
	2013.11-	Saloon Engine CNSB Inner Diameter [30mm]		o	GHA230082	K
1.8 TFSi (132 kW)	2013.05-	Saloon Engine CJSA/CJSB 3 hole	•		GHA336004	K
	2013.05-	Saloon Engine CJSA/CJSB Inner Diameter [30mm]		o	GHA230082	K
1.8 TFSi Quattro (132 kW)	2013.11-	Saloon Engine CJSB 3 hole	•		GHA336004	K
2.0 S3 Quattro (206 kW)	2013.10-	Saloon Engine CJXB 3 hole	•		GHA336004	K
2.0 S3 Quattro (221 kW)	2013.10-	Saloon Engine CJXC 3 hole	•		GHA336004	K
2.0 TDi (100 kW)	2013.09-	Saloon Engine CRBD/CRLC 3 hole	•		GHA336004	K
	2013.09-	Saloon Engine CRBD/CRLC Inner Diameter [30mm]		o	GHA230082	K
2.0 TDi (105 kW)	2013.10-	Saloon Engine CRFC 3 hole	•		GHA336004	K
	2013.10-	Saloon Engine CRFC Inner Diameter [30mm]		o	GHA230082	K
2.0 TDi (110 kW)	2013.05-	Saloon Engine CRBC/CRLB/CRUA 3 hole	•		GHA336004	K
	2013.05-	Saloon Engine CRBC/CRLB/CRUA Inner Diameter [30mm]		o	GHA230082	K
2.0 TDi (135 kW)	2014.05-	Saloon Engine CUNA 3 hole	•		GHA336004	K
	2014.05-	Saloon Engine CUNA Inner Diameter [30mm]		o	GHA230082	K
2.0 TDi (81 kW)	2013.05-	Saloon Engine CRFA 3 hole	•		GHA336004	K
	2013.05-	Saloon Engine CRFA Inner Diameter [30mm]		o	GHA230082	K
2.0 TDi Quattro (110 kW)	2013.10-	Saloon Engine CRBC/CRLB 3 hole	•		GHA336004	K
2.0 TDi Quattro (135 kW)	2014.05-	Saloon Engine CUNA 3 hole	•		GHA336004	K
S3 (210 kW)	2014.05-	Saloon Engine CJXF 3 hole	•		GHA336004	K
A3 SPORTBACK (8PA)						
2.0 (120 kW)	2006.06-2013.03	Hatchback 3 hole	•		GHA336004	K
	2006.06-2013.03	Hatchback 4 hole	•		GHA336007	K
	2006.06-2013.03	Hatchback Inner Diameter [30mm]		o	GHA230082	K
	2006.06-2013.03	Hatchback Inner Diameter [32mm]		o	GHA232018	K
A3 SPORTBACK (8VA)						
1.2 TFSi (77 kW)	2013.05-	Hatchback Engine CJZA 3 hole	•		GHA336004	K
	2013.05-	Hatchback Engine CJZA Inner Diameter [30mm]		o	GHA230082	K
1.2 TFSi (81 kW)	2014.05-	Hatchback Engine CYVB 3 hole	•		GHA336004	K
	2014.05-	Hatchback Engine CYVB Inner Diameter [30mm]		o	GHA230082	K
1.4 TFSi (103 kW)	2013.03-	Hatchback Engine CPTA 3 hole	•		GHA336004	K
	2013.03-	Hatchback Engine CPTA Inner Diameter [30mm]		o	GHA230082	K
1.4 TFSi (110 kW)	2014.05-	Hatchback Engine CZEA 3 hole	•		GHA336004	K
	2014.05-	Hatchback Engine CZEA Inner Diameter [30mm]		o	GHA230082	K
1.4 TFSi (90 kW)	2012.09-	Hatchback Engine CMBA/CXSA 3 hole	•		GHA336004	K
	2012.09-	Hatchback Engine CMBA/CXSA Inner Diameter [30mm]		o	GHA230082	K
1.4 TFSi (92 kW)	2014.05-	Hatchback Engine CZCA 3 hole	•		GHA336004	K
	2014.05-	Hatchback Engine CZCA Inner Diameter [30mm]		o	GHA230082	K
1.4 TFSi e-tron (110 kW)	2014.05-	Hatchback Engine CUKB/CXUA 3 hole	•		GHA336004	K
	2014.05-	Hatchback Engine CUKB/CXUA Inner Diameter [30mm]		o	GHA230082	K
1.4 TFSi g-tron (81 kW)	2013.11-	Hatchback Engine CPWA 3 hole	•		GHA336004	K
	2013.11-	Hatchback Engine CPWA Inner Diameter [30mm]		o	GHA230082	K
1.6 TDi (77 kW)	2012.10-	Hatchback Engine CLHA 3 hole	•		GHA336004	K
	2012.10-	Hatchback Engine CLHA Inner Diameter [30mm]		o	GHA230082	K
1.6 TDi (81 kW)	2013.09-	Hatchback Engine CRKB/CXXB/DBKA 3 hole	•		GHA336004	K
	2013.09-	Hatchback Engine CRKB/CXXB/DBKA Inner Diameter [30mm]		o	GHA230082	K
1.6 TDi Quattro (81 kW)	2015.05-	Hatchback Engine CXXB 3 hole	•		GHA336004	K
1.8 TFSi (132 kW)	2012.09-	Hatchback Engine CJSA/CJSB 3 hole	•		GHA336004	K
	2012.09-	Hatchback Engine CJSA/CJSB Inner Diameter [30mm]		o	GHA230082	K
1.8 TFSi Quattro (132 kW)	2013.05-	Hatchback Engine CJSB 3 hole	•		GHA336004	K



	 YEAR		F	R	G-AP Ref.	KIT
AUDI						
A3 SPORTBACK (8VA)						
2.0 S3 Quattro (206 kW)	2013.05-	Hatchback Engine CJXB 3 hole	•		GHA336004	K
2.0 S3 Quattro (221 kW)	2012.11-	Hatchback Engine CJXC 3 hole	•		GHA336004	K
2.0 TDi (100 kW)	2013.05-	Hatchback Engine CRBD/CRLC 3 hole	•		GHA336004	K
	2013.05-	Hatchback Engine CRBD/CRLC Inner Diameter [30mm]		○	GHA230082	K
2.0 TDi (105 kW)	2013.03-	Hatchback Engine CRFC 3 hole	•		GHA336004	K
	2013.03-	Hatchback Engine CRFC Inner Diameter [30mm]		○	GHA230082	K
2.0 TDi (110 kW)	2012.09-	Hatchback Engine CRBC/CRLB/CRUA 3 hole	•		GHA336004	K
	2012.09-	Hatchback Engine CRBC/CRLB/CRUA Inner Diameter [30mm]		○	GHA230082	K
2.0 TDi (135 kW)	2013.05-	Hatchback Engine CUNA 3 hole	•		GHA336004	K
	2013.05-	Hatchback Engine CUNA Inner Diameter [30mm]		○	GHA230082	K
2.0 TDi (81 kW)	2013.05-	Hatchback Engine CRFA 3 hole	•		GHA336004	K
	2013.05-	Hatchback Engine CRFA Inner Diameter [30mm]		○	GHA230082	K
2.0 TDi Quattro (110 kW)	2013.02-	Hatchback Engine CRBC/CRLB 3 hole	•		GHA336004	K
2.0 TDi Quattro (135 kW)	2013.05-	Hatchback Engine CUNA 3 hole	•		GHA336004	K
RS3 Quattro (270 kW)	2015.03-	Hatchback 3 hole	•		GHA336004	K
S3 Quattro (210 kW)	2014.05-	Hatchback Engine CJXF 3 hole	•		GHA336004	K
A4 (8D2, B5)						
1.6 (74 kW)	1994.11-2000.10	Saloon Engine ADP/AHL/ANA/ARM	•		GHA433002	
	1994.11-2000.10	Saloon Engine ADP/AHL/ANA/ARM	•		GWB1355	
	1994.11-2000.10	Saloon Engine ADP/AHL/ANA/ARM		○	GHA499047	
	1994.11-2000.10	Saloon Engine ADP/AHL/ANA/ARM		○	GWB0542	
	1994.11-2000.10	Saloon Engine ADP/AHL/ANA/ARM		○	GWB3519	
1.6 (75 kW)	2000.07-2000.11	Saloon Engine ALZ	•		GHA433002	
	2000.07-2000.11	Saloon Engine ALZ	•		GWB1355	
	2000.07-2000.11	Saloon Engine ALZ		○	GHA499047	
	2000.07-2000.11	Saloon Engine ALZ		○	GWB3519	
1.8 (125 kW)	2000.05-2000.09	Saloon Engine AMB	•		GWB1355	
	2000.05-2000.09	Saloon Engine AMB		○	GWB3519	
1.8 (85 kW)	1995.04-2000.11	Saloon Engine AFY	•		GHA433002	
	1995.04-2000.11	Saloon Engine AFY	•		GWB1355	
	1995.04-2000.11	Saloon Engine AFY		○	GWB0542	
	1995.04-2000.11	Saloon Engine AFY		○	GWB3519	
1.8 (92 kW)	1995.01-2000.11	Saloon Engine ADR/APT/ARG/AVV	•		GHA433002	
	1995.01-2000.11	Saloon Engine ADR/APT/ARG/AVV	•		GWB1355	
	1995.01-2000.11	Saloon Engine ADR/APT/ARG/AVV		○	GHA499047	
	1995.01-2000.11	Saloon Engine ADR/APT/ARG/AVV		○	GWB0542	
	1995.01-2000.11	Saloon Engine ADR/APT/ARG/AVV		○	GWB3519	
1.8 Quattro (85 kW)	1995.07-2000.11	Saloon Engine AFY	•		GHA433002	
	1995.07-2000.11	Saloon Engine AFY	•		GWB1355	
1.8 Quattro (92 kW)	1995.01-2000.11	Saloon Engine ADR/APT/ARG	•		GHA433002	
	1995.01-2000.11	Saloon Engine ADR/APT/ARG	•		GWB1355	
1.8 T (110 kW)	1995.01-2000.11	Saloon Engine AEB/ANB/APU/ARK/AWT	•		GHA433002	
	1995.01-2000.11	Saloon Engine AEB/ANB/APU/ARK/AWT	•		GWB1355	
	1995.01-2000.11	Saloon Engine AEB/ANB/APU/ARK/AWT		○	GHA499047	
	1995.01-2000.11	Saloon Engine AEB/ANB/APU/ARK/AWT		○	GWB0542	
	1995.01-2000.11	Saloon Engine AEB/ANB/APU/ARK/AWT		○	GWB3519	
1.8 T (132 kW)	1997.12-2000.11	Saloon Engine AJL	•		GWB1356	
	1997.12-2000.11	Saloon Engine AJL		○	GHA499047	
	1997.12-2000.11	Saloon Engine AJL		○	GWB3519	
1.8 T Quattro (110 kW)	1995.01-2000.11	Saloon Engine AEB/ANB/APU/ARK/AWT	•		GHA433002	
	1995.01-2000.11	Saloon Engine AEB/ANB/APU/ARK/AWT	•		GWB1355	
1.8 T Quattro (132 kW)	1997.12-2000.11	Saloon Engine AJL	•		GWB1356	
	1997.12-2000.11	Saloon Engine AJL		○	GWB1355	
1.9 TDi (55 kW)	1995.12-2000.11	Saloon Engine AFF	•		GHA433002	
	1995.12-2000.11	Saloon Engine AFF	•		GWB1355	
	1995.12-2000.11	Saloon Engine AFF		○	GHA499047	
	1995.12-2000.11	Saloon Engine AFF		○	GWB0542	
	1995.12-2000.11	Saloon Engine AFF		○	GWB3519	
1.9 TDi (66 kW)	1995.01-2000.11	Saloon Engine 1Z/AHH/AHU	•		GHA433002	
	1995.01-2000.11	Saloon Engine 1Z/AHH/AHU	•		GWB1355	
	1995.01-2000.11	Saloon Engine 1Z/AHH/AHU		○	GHA499047	
	1995.01-2000.11	Saloon Engine 1Z/AHH/AHU		○	GWB0542	
	1995.01-2000.11	Saloon Engine 1Z/AHH/AHU		○	GWB3519	
1.9 TDi (81 kW)	1995.10-2000.11	Saloon Engine AFN/AVG	•		GHA433002	



	 YEAR		F	R	G-AP Ref.	KIT
AUDI						
A4 (8D2, B5)						
1.9 TDi (81 kW)	1995.10-2000.11	Saloon Engine AFN/AVG	•		GWB1355	
	1995.10-2000.11	Saloon Engine AFN/AVG		◦	GHA499047	
	1995.10-2000.11	Saloon Engine AFN/AVG		◦	GWB0542	
	1995.10-2000.11	Saloon Engine AFN/AVG		◦	GWB3519	
1.9 TDi (85 kW)	2000.03-2000.11	Saloon Engine AJM	•		GHA433002	
	2000.03-2000.11	Saloon Engine AJM	•		GWB1355	
	2000.03-2000.11	Saloon Engine AJM		◦	GHA499047	
	2000.03-2000.11	Saloon Engine AJM		◦	GWB3519	
1.9 TDi Quattro (81 kW)	1996.09-2000.11	Saloon Engine AFN/AVG	•		GHA433002	
	1996.09-2000.11	Saloon Engine AFN/AVG	•		GWB1355	
1.9 TDi Quattro (85 kW)	2000.03-2000.11	Saloon Engine AJM/ATJ	•		GHA433002	
	2000.03-2000.11	Saloon Engine AJM/ATJ	•		GWB1355	
2.4 (110 kW)	1995.07-1997.07	Saloon Engine AFM	•		GWB1356	
	1995.07-1997.07	Saloon Engine AFM		◦	GWB0542	
	1995.07-1997.07	Saloon Engine AFM		◦	GWB3519	
2.4 (120 kW)	1997.08-2000.11	Saloon Engine AJG/AMM/APZ	•		GWB1356	
	1997.08-2000.11	Saloon Engine AJG/AMM/APZ		◦	GHA499047	
	1997.08-2000.11	Saloon Engine AJG/AMM/APZ		◦	GWB3519	
2.4 (121 kW)	1997.03-2000.11	Saloon Engine AGA/ALF/AML/APS/ARJ	•		GWB1356	
	1997.03-2000.11	Saloon Engine AGA/ALF/AML/APS/ARJ		◦	GHA499047	
	1997.03-2000.11	Saloon Engine AGA/ALF/AML/APS/ARJ		◦	GWB0542	
	1997.03-2000.11	Saloon Engine AGA/ALF/AML/APS/ARJ		◦	GWB3519	
2.4 Quattro (120 kW)	1997.08-2000.11	Saloon Engine APZ	•		GWB1356	
	1997.08-2000.11	Saloon Engine APZ		◦	GWB1355	
2.4 Quattro (121 kW)	1997.03-2000.11	Saloon Engine AGA/ALF/AML/APS/ARJ	•		GWB1356	
	1997.03-2000.11	Saloon Engine AGA/ALF/AML/APS/ARJ		◦	GWB1355	
2.5 TDi (110 kW)	1997.09-2000.11	Saloon Engine AFB/AKN	•		GWB1356	
	1997.09-2000.11	Saloon Engine AFB/AKN		◦	GHA499047	
	1997.09-2000.11	Saloon Engine AFB/AKN		◦	GWB3519	
2.5 TDi Quattro (110 kW)	1997.09-2000.11	Saloon Engine AFB/AKN	•		GWB1356	
	1997.09-2000.11	Saloon Engine AFB/AKN		◦	GWB1355	
2.6 (102 kW)	1996.01-1997.07	Saloon Engine ACZ	•		GWB1356	
	1996.01-1997.07	Saloon Engine ACZ		◦	GWB0542	
	1996.01-1997.07	Saloon Engine ACZ		◦	GWB3519	
2.6 (110 kW)	1995.01-2000.11	Saloon Engine ABC	•		GWB1356	
	1995.01-2000.11	Saloon Engine ABC		◦	GHA499047	
	1995.01-2000.11	Saloon Engine ABC		◦	GWB0542	
	1995.01-2000.11	Saloon Engine ABC		◦	GWB3519	
	1995.01-2000.11	Saloon Engine ABC		◦	GWB3427	
2.6 Quattro (110 kW)	1995.01-2000.11	Saloon Engine ABC	•		GWB1356	
	1995.01-2000.11	Saloon Engine ABC		◦	GWB1355	
	1995.01-2000.11	Saloon Engine ABC		◦	GWB3427	
2.7 S4 Quattro (195 kW)	1997.09-2001.09	Saloon Engine AGB/AZB	•		GWB1356	
	1997.09-2001.09	Saloon Engine AGB/AZB		◦	GWB1355	
2.8 (128 kW)	1995.09-1997.07	Saloon Engine AAH	•		GWB1356	
	1995.09-1997.07	Saloon Engine AAH		◦	GHA499047	
	1995.09-1997.07	Saloon Engine AAH		◦	GWB0542	
	1995.09-1997.07	Saloon Engine AAH		◦	GWB3519	
	1995.09-1997.07	Saloon Engine AAH		◦	GWB3427	
2.8 (142 kW)	1996.10-1999.07	Saloon Engine AHA	•		GWB1356	
	1996.10-1999.07	Saloon Engine AHA		◦	GWB0542	
	1996.10-1999.07	Saloon Engine AHA		◦	GWB3519	
	1996.10-2000.11	Saloon Engine ACK/AHA/ALG/AMX/APR/AQD	•		GWB1356	
	1996.10-2000.11	Saloon Engine ACK/AHA/ALG/AMX/APR/AQD		◦	GHA499047	
	1996.10-2000.11	Saloon Engine ACK/AHA/ALG/AMX/APR/AQD		◦	GWB0542	
	1996.10-2000.11	Saloon Engine ACK/AHA/ALG/AMX/APR/AQD		◦	GWB3519	
2.8 Quattro (128 kW)	1995.01-1997.07	Saloon Engine AAH	•		GWB1356	
	1995.01-1997.07	Saloon Engine AAH		◦	GWB1355	
	1995.01-1997.07	Saloon Engine AAH		◦	GWB3427	
2.8 Quattro (142 kW)	1996.10-2001.08	Saloon Engine ACK/AHA/ALG/AMX/APR/AQD	•		GWB1356	
	1996.10-2001.08	Saloon Engine ACK/AHA/ALG/AMX/APR/AQD		◦	GWB1355	
	1996.10-2001.08	Saloon Engine ACK/AHA/ALG/AMX/APR/AQD		◦	GWB3427	



	 YEAR		F	R	G-AP Ref.	KIT
AUDI						
A4 (8E2, B6)						
1.6 (75 kW)	2000.11-2004.12	Saloon Engine ALZ	•		GHA245010	K
	2000.11-2004.12	Saloon Engine ALZ	•		GHA433002	
	2000.11-2004.12	Saloon Engine ALZ		o	GHA232014	K
1.8 T (110 kW)	2001.09-2004.05	Saloon Engine AVJ	•		GHA245010	K
	2001.09-2004.05	Saloon Engine AVJ		o	GHA232014	K
1.8 T (120 kW)	2002.07-2004.12	Saloon Engine BFB	•		GHA245010	K
	2002.07-2004.12	Saloon Engine BFB		o	GHA232014	K
1.8 T (125 kW)	2001.07-2004.12	Saloon Engine AMB	•		GHA245010	K
	2001.07-2004.12	Saloon Engine AMB		o	GHA232014	K
1.8 T (140 kW)	2002.11-2004.12	Saloon Engine BEX	•		GHA245010	K
	2002.11-2004.12	Saloon Engine BEX		o	GHA232014	K
1.8 T Quattro (110 kW)	2000.11-2002.07	Saloon Engine AVJ	•		GHA245010	K
	2000.11-2002.07	Saloon Engine AVJ		o	GWB3605	
1.8 T Quattro (120 kW)	2002.07-2004.12	Saloon Engine BFB	•		GHA245010	K
	2002.07-2004.12	Saloon Engine BFB		o	GWB3605	
1.8 T Quattro (125 kW)	2001.07-2004.12	Saloon Engine AMB	•		GHA245010	K
	2001.07-2004.12	Saloon Engine AMB		o	GWB3605	
1.8 T Quattro (140 kW)	2002.11-2004.12	Saloon Engine BEX	•		GHA245010	K
	2002.11-2004.12	Saloon Engine BEX		o	GWB3605	
1.9 TDi (74 kW)	2001.05-2004.12	Saloon Engine AVB	•		GHA245010	K
	2001.05-2004.12	Saloon Engine AVB		o	GHA232014	K
1.9 TDi (85 kW)	2004.04-2004.09	Saloon Engine BKE	•		GHA245010	K
	2004.04-2004.09	Saloon Engine BKE		o	GHA232014	K
1.9 TDi (96 kW)	2000.11-2004.12	Saloon Engine AVF/AWX	•		GHA245010	K
	2000.11-2004.12	Saloon Engine AVF/AWX		o	GHA232014	K
1.9 TDi Quattro (96 kW)	2001.11-2004.12	Saloon Engine AVF	•		GHA245010	K
	2001.11-2004.12	Saloon Engine AVF		o	GWB3605	
2.0 (96 kW)	2000.11-2004.12	Saloon Engine ALT	•		GHA245010	K
	2000.11-2004.12	Saloon Engine ALT		o	GHA232014	K
2.0 FSi (110 kW)	2002.07-2004.12	Saloon Engine AWA	•		GHA245010	K
	2002.07-2004.12	Saloon Engine AWA		o	GHA232014	K
2.4 (120 kW)	2001.09-2004.12	Saloon Engine AMM	•		GHA245010	K
	2001.09-2004.12	Saloon Engine AMM		o	GHA232014	K
2.4 (125 kW)	2001.09-2004.12	Saloon Engine BDV	•		GHA245010	K
	2001.09-2004.12	Saloon Engine BDV		o	GHA232014	K
2.5 TDi (114 kW)	2001.08-2002.07	Saloon Engine AYM	•		GHA245010	K
	2001.08-2002.07	Saloon Engine AYM		o	GHA232014	K
2.5 TDi (120 kW)	2002.07-2004.12	Saloon Engine BCZ/BDG/BFC	•		GHA245010	K
	2002.07-2004.12	Saloon Engine BCZ/BDG/BFC		o	GHA232014	K
2.5 TDi Quattro (132 kW)	2000.11-2004.12	Saloon Engine AKE/BAU/BDH	•		GHA245010	K
	2000.11-2004.12	Saloon Engine AKE/BAU/BDH		o	GWB3605	
3.0 (160 kW)	2001.04-2004.12	Saloon Engine BBJ	•		GHA245010	K
	2001.04-2004.12	Saloon Engine BBJ		o	GHA232014	K
3.0 (162 kW)	2000.11-2004.12	Saloon Engine ASN	•		GHA245010	K
	2000.11-2004.12	Saloon Engine ASN		o	GHA232014	K
3.0 Quattro (160 kW)	2001.04-2004.12	Saloon Engine BBJ	•		GHA245010	K
	2001.04-2004.12	Saloon Engine BBJ		o	GWB3605	
3.0 Quattro (162 kW)	2000.11-2004.12	Saloon Engine ASN	•		GHA245010	K
	2000.11-2004.12	Saloon Engine ASN		o	GWB3605	
4.2 S4 Quattro (253 kW)	2003.03-2004.12	Saloon Engine BBK	•		GHA245010	K
	2003.03-2004.12	Saloon Engine BBK		o	GWB3605	
A4 (8EC, B7)						
1.6 (75 kW)	2004.11-2008.06	Saloon Engine ALZ	•		GHA245010	K
	2004.11-2008.06	Saloon Engine ALZ	•		GHA433002	
	2004.11-2008.06	Saloon Engine ALZ		o	GHA232014	K
1.8 T (120 kW)	2004.11-2008.06	Saloon Engine BFB	•		GHA245010	K
	2004.11-2008.06	Saloon Engine BFB		o	GHA232014	K
1.8 T Quattro (120 kW)	2004.11-2008.06	Saloon Engine BFB	•		GHA245010	K
	2004.11-2008.06	Saloon Engine BFB		o	GWB3605	
1.9 TDi (85 kW)	2004.11-2008.06	Saloon Engine BKE/BRB	•		GHA245010	K
	2004.11-2008.06	Saloon Engine BKE/BRB		o	GHA232014	K
2.0 (96 kW)	2004.11-2008.06	Saloon Engine ALT	•		GHA245010	K
	2004.11-2008.06	Saloon Engine ALT		o	GHA232014	K
2.0 TDi (100 kW)	2007.02-2007.08	Saloon Engine BNA/BRF	•		GHA245010	K



	 YEAR		F	R	G-AP Ref.	KIT
AUDI						
A4 (8EC, B7)						
2.0 TDi (100 kW)	2007.02-2007.08	Saloon Engine BNA/BRF		o	GHA232014	K
2.0 TDi (103 kW)	2007.02-2007.08	Saloon Engine BPW	•		GHA245010	K
	2007.02-2007.08	Saloon Engine BPW		o	GHA232014	K
2.0 TDi (120 kW)	2006.06-2008.06	Saloon Engine BVA	•		GHA245010	K
	2006.06-2008.06	Saloon Engine BVA		o	GHA232014	K
2.0 TDi (125 kW)	2006.05-2007.08	Saloon Engine BRD	•		GHA245010	K
	2006.05-2007.08	Saloon Engine BRD		o	GHA232014	K
2.0 TDi (89 kW)	2005.09-2006.09	Saloon Engine BVG	•		GHA245010	K
	2005.09-2006.09	Saloon Engine BVG		o	GHA232014	K
2.0 TDi (93 kW)	2005.11-2006.11	Saloon Engine BVF	•		GHA245010	K
	2005.11-2006.11	Saloon Engine BVF		o	GHA232014	K
2.0 TDi 16V (103 kW)	2004.11-2008.06	Saloon Engine BLB/BRE	•		GHA245010	K
	2004.11-2008.06	Saloon Engine BLB/BRE		o	GHA232014	K
2.0 TDi Quattro (103 kW)	2006.01-2008.06	Saloon Engine BPW	•		GHA245010	K
	2006.01-2008.06	Saloon Engine BPW		o	GWB3605	
2.0 TDi Quattro (120 kW)	2006.06-2008.06	Saloon Engine BVA	•		GHA245010	K
	2006.06-2008.06	Saloon Engine BVA		o	GWB3605	
2.0 TDi Quattro (125 kW)	2006.05-2007.08	Saloon Engine BRD	•		GHA245010	K
	2006.05-2007.08	Saloon Engine BRD		o	GWB3605	
2.0 TFSi (125 kW)	2006.10-2008.06	Saloon Engine BPJ/BYK	•		GHA245010	K
	2006.10-2008.06	Saloon Engine BPJ/BYK		o	GHA232014	K
2.0 TFSi (147 kW)	2004.11-2008.06	Saloon Engine BGB/BWE	•		GHA245010	K
	2004.11-2008.06	Saloon Engine BGB/BWE		o	GHA232014	K
2.0 TFSi (162 kW)	2005.12-2007.08	Saloon Engine BUL	•		GHA245010	K
	2005.12-2007.08	Saloon Engine BUL		o	GHA232014	K
2.0 TFSi Quattro (147 kW)	2004.11-2008.06	Saloon Engine BGB/BWE	•		GHA245010	K
	2004.11-2008.06	Saloon Engine BGB/BWE		o	GWB3605	
2.0 TFSi Quattro (162 kW)	2005.04-2007.08	Saloon Engine BUL	•		GHA245010	K
	2005.04-2007.08	Saloon Engine BUL		o	GWB3605	
2.5 TDi (120 kW)	2004.11-2006.05	Saloon Engine BDG	•		GHA245010	K
	2004.11-2006.05	Saloon Engine BDG		o	GHA232014	K
2.7 TDi (120 kW)	2005.11-2008.06	Saloon Engine BSG	•		GHA245010	K
	2005.11-2008.06	Saloon Engine BSG		o	GHA232014	K
2.7 TDi (132 kW)	2006.02-2007.08	Saloon Engine BPP	•		GHA245010	K
	2006.02-2007.08	Saloon Engine BPP		o	GHA232014	K
3.0 (160 kW)	2004.11-2006.05	Saloon Engine BBJ	•		GHA245010	K
	2004.11-2006.05	Saloon Engine BBJ		o	GHA232014	K
3.0 Quattro (160 kW)	2004.11-2006.07	Saloon Engine BBJ	•		GHA245010	K
	2004.11-2006.07	Saloon Engine BBJ		o	GWB3605	
3.0 TDi Quattro (150 kW)	2004.11-2008.06	Saloon Engine BKN	•		GHA245010	K
	2004.11-2008.06	Saloon Engine BKN		o	GWB3605	
3.0 TDi Quattro (171 kW)	2007.02-2007.08	Saloon Engine ASB	•		GHA245010	K
	2007.02-2007.08	Saloon Engine ASB		o	GWB3605	
3.2 FSi (188 kW)	2005.01-2008.06	Saloon Engine AUK	•		GHA245010	K
	2005.01-2008.06	Saloon Engine AUK		o	GHA232014	K
3.2 FSi Quattro (188 kW)	2005.01-2008.06	Saloon Engine AUK	•		GHA245010	K
	2005.01-2008.06	Saloon Engine AUK		o	GWB3605	
4.2 RS4 Quattro (309 kW)	2005.09-2008.06	Saloon Engine BNS	•		GHA245010	K
4.2 S4 Quattro (253 kW)	2007.02-2007.08	Saloon Engine BBK	•		GHA245010	K
	2007.02-2007.08	Saloon Engine BBK		o	GWB3605	
A4 (8H7, B6, 8HE, B7)						
1.8 T (120 kW)	2002.07-2009.03	Convertible Engine BFB	•		GHA245010	K
	2002.07-2009.03	Convertible Engine BFB		o	GHA232014	K
1.8 T (125 kW)	2002.10-2005.1	Convertible Engine AMB	•		GHA245010	K
	2002.10-2005.1	Convertible Engine AMB		o	GHA232014	K
1.8 T Quattro (120 kW)	2003.05-2005.10	Convertible Engine BFB	•		GHA245010	K
	2003.05-2005.10	Convertible Engine BFB		o	GWB3605	
2.0 (96 kW)	2004.09-2005.12	Convertible Engine ALT	•		GHA245010	K
	2004.09-2005.12	Convertible Engine ALT		o	GHA232014	K
2.0 TDi (100 kW)	2006.01-2009.03	Convertible Engine BRC	•		GHA245010	K
	2006.01-2009.03	Convertible Engine BRC		o	GHA232014	K
2.0 TDi (103 kW)	2005.11-2007.04	Convertible Engine BPW	•		GHA245010	K
	2005.11-2007.04	Convertible Engine BPW		o	GHA232014	K
2.0 TFSi 16V (147 kW)	2005.11-2007.04	Convertible Engine BWE	•		GHA245010	K



	 YEAR		F	R	G-AP Ref.	KIT
AUDI						
A4 (8H7, B6, 8HE, B7)						
2.0 TFSi 16V (147 kW)	2005.11-2007.04	Convertible Engine BWE		o	GHA232014	K
2.0 TFSi Quattro (147 kW)	2005.11-2009.03	Convertible	•		GHA245010	K
	2005.11-2009.03	Convertible		o	GWB3605	
2.4 (120 kW)	2002.04-2005.12	Convertible Engine AMM	•		GHA245010	K
	2002.04-2005.12	Convertible Engine AMM		o	GHA232014	K
2.4 (125 kW)	2002.04-2005.12	Convertible Engine BDV	•		GHA245010	K
	2002.04-2005.12	Convertible Engine BDV		o	GHA232014	K
2.5 TDi (120 kW)	2002.08-2005.12	Convertible Engine BCZ/BDG/BFC	•		GHA245010	K
	2002.08-2005.12	Convertible Engine BCZ/BDG/BFC		o	GHA232014	K
2.7 TDi (132 kW)	2006.06-2009.03	Convertible Engine BPP	•		GHA245010	K
	2006.06-2009.03	Convertible Engine BPP		o	GHA232014	K
3.0 (160 kW)	2002.04-2005.12	Convertible Engine BBJ	•		GHA245010	K
	2002.04-2005.12	Convertible Engine BBJ		o	GHA232014	K
3.0 (162 kW)	2002.04-2005.12	Convertible Engine ASN	•		GHA245010	K
	2002.04-2005.12	Convertible Engine ASN		o	GHA232014	K
3.0 Quattro (162 kW)	2003.05-2005.10	Convertible Engine ASN	•		GHA245010	K
	2003.05-2005.10	Convertible Engine ASN		o	GWB3605	
3.0 TDi Quattro (150 kW)	2006.01-2009.03	Convertible Engine BKN	•		GHA245010	K
	2006.01-2009.03	Convertible Engine BKN		o	GWB3605	
3.0 TDi Quattro (171 kW)	2005.11-2007.04	Convertible Engine ASB	•		GHA245010	K
	2005.11-2007.04	Convertible Engine ASB		o	GWB3605	
3.2 FSi (188 kW)	2005.11-2007.04	Convertible Engine AUK	•		GHA245010	K
	2005.11-2007.04	Convertible Engine AUK		o	GHA232014	K
3.2 FSi Quattro (188 kW)	2005.11-2007.04	Convertible Engine AUK	•		GHA245010	K
	2005.11-2007.04	Convertible Engine AUK		o	GWB3605	
4.2 RS4 Quattro (309 kW)	2006.03-2009.03	Convertible Engine BNS	•		GHA245010	K
4.2 S4 Quattro (253 kW)	2004.01-2007.12	Convertible Engine BBK	•		GHA245010	K
	2004.01-2007.12	Convertible Engine BBK		o	GWB3605	
A4 (8K2, B8)						
1.8 TFSi (118 kW)	2007.11-	Saloon Engine CABB/CCUA/CDHB	•		GHA262001	K
	2007.11-	Saloon Engine CABB/CCUA/CDHB		o	GHA232026	K
1.8 TFSi (125 kW)	2011.11-	Saloon Engine CJEB	•		GHA262001	K
	2011.11-	Saloon Engine CJEB		o	GHA232026	K
1.8 TFSi (88 kW)	2008.02-	Saloon Engine CABA/CDHA	•		GHA262001	K
	2008.02-	Saloon Engine CABA/CDHA		o	GHA232026	K
1.8 TFSi Quattro (118 kW)	2008.09-	Saloon Engine CDHB	•		GHA262001	K
1.8 TFSi Quattro (125 kW)	2011.11-	Saloon Engine CJEB	•		GHA262001	K
2.0 TDi (100 kW)	2007.11-	Saloon Engine CAGB/CJCB	•		GHA262001	K
	2007.11-	Saloon Engine CAGB/CJCB		o	GHA232026	K
2.0 TDi (105 kW)	2007.11-	Saloon Engine CAGA/CJCA/CMEA/CMFA	•		GHA262001	K
	2007.11-	Saloon Engine CAGA/CJCA/CMEA/CMFA		o	GHA232026	K
2.0 TDi (110 kW)	2013.05-	Saloon Engine CJCD/CMFB/CSUA	•		GHA262001	K
	2013.05-	Saloon Engine CJCD/CMFB/CSUA		o	GHA232026	K
2.0 TDi (120 kW)	2008.08-	Saloon Engine CAHB/CGLD	•		GHA262001	K
	2008.08-	Saloon Engine CAHB/CGLD		o	GHA232026	K
2.0 TDi (125 kW)	2008.01-	Saloon Engine CAHA	•		GHA262001	K
	2008.01-	Saloon Engine CAHA		o	GHA232026	K
2.0 TDi (130 kW)	2011.11-	Saloon Engine CGLC/CMGB	•		GHA262001	K
	2011.11-	Saloon Engine CGLC/CMGB		o	GHA232026	K
2.0 TDi (140 kW)	2013.09-	Saloon Engine CNHA	•		GHA262001	K
	2013.09-	Saloon Engine CNHA		o	GHA232026	K
2.0 TDi (88 kW)	2008.06-	Saloon Engine CAGC/CJCC	•		GHA262001	K
	2008.06-	Saloon Engine CAGC/CJCC		o	GHA232026	K
2.0 TDi Quattro (105 kW)	2008.11-	Saloon Engine CAGA/CJCA	•		GHA262001	K
2.0 TDi Quattro (110 kW)	2013.05-	Saloon Engine CJCD/CSUA	•		GHA262001	K
2.0 TDi Quattro (125 kW)	2008.01-	Saloon Engine CAHA	•		GHA262001	K
2.0 TDi Quattro (130 kW)	2011.11-	Saloon Engine CGLC	•		GHA262001	K
2.0 TDi Quattro (140 kW)	2013.09-	Saloon Engine CNHA	•		GHA262001	K
2.0 TFSi (132 kW)	2008.06-	Saloon Engine CAEA/CDNB/CDZA	•		GHA262001	K
	2008.06-	Saloon Engine CAEA/CDNB/CDZA		o	GHA232026	K
2.0 TFSi (155 kW)	2008.06-	Saloon Engine CADA/CAEB/CDNC	•		GHA262001	K
	2008.06-	Saloon Engine CADA/CAEB/CDNC		o	GHA232026	K
2.0 TFSi (162 kW)	2013.05-2015.12	Saloon Engine CAED	•		GHA262001	K
	2013.05-2015.12	Saloon Engine CAED		o	GHA232026	K



	 YEAR		F	R	G-AP Ref.	KIT
AUDI						
A4 (8K2, B8)						
2.0 TFSi (165 kW)	2013.05-	Saloon Engine CNCD	•		GHA262001	K
	2013.05-	Saloon Engine CNCD		◦	GHA232026	K
2.0 TFSi FlexFuel (132 kW)	2009.11-	Saloon Engine CFKA	•		GHA262001	K
	2009.11-	Saloon Engine CFKA		◦	GHA232026	K
2.0 TFSi FlexFuel Quattro (132 kW)	2009.11-	Saloon Engine CFKA	•		GHA262001	K
2.0 TFSi Quattro (155 kW)	2008.06-	Saloon Engine CDNC/CPMA	•		GHA262001	K
2.0 TFSi Quattro (162 kW)	2013.05-2015.12	Saloon Engine CAED/CPMB	•		GHA262001	K
2.0 TFSi Quattro (165 kW)	2013.05-	Saloon Engine CNCD	•		GHA262001	K
2.7 TDi (120 kW)	2007.11-	Saloon Engine CGKB/CAMB	•		GHA262001	K
	2007.11-	Saloon Engine CGKB/CAMB		◦	GHA232026	K
2.7 TDi (140 kW)	2007.11-	Saloon Engine CAMA/CGKA	•		GHA262001	K
	2007.11-	Saloon Engine CAMA/CGKA		◦	GHA232026	K
3.0 S4 Quattro (245 kW)	2008.11-	Saloon Engine CAKA/CCBA/CGWC/CGXC/CTUB	•		GHA262001	K
3.0 TDi (150 kW)	2011.11-	Saloon Engine CLAB	•		GHA262001	K
	2011.11-	Saloon Engine CLAB		◦	GHA232026	K
3.0 TDi Quattro (155 kW)	2008.06-	Saloon Engine CCWB	•		GHA262001	K
3.0 TDi Quattro (176 kW)	2007.11-	Saloon Engine CAPA/CCLA/CCWA	•		GHA262001	K
3.0 TDi Quattro (180 kW)	2011.11-	Saloon Engine CDUC/CKVB/CKVC	•		GHA262001	K
3.0 TFSi Quattro (200 kW)	2012.02-	Saloon Engine CMUA	•		GHA262001	K
3.2 FSi (195 kW)	2008.09-	Saloon Engine CALA	•		GHA262001	K
	2008.09-	Saloon Engine CALA		◦	GHA232026	K
3.2 FSi Quattro (195 kW)	2007.11-	Saloon Engine CALA	•		GHA262001	K
A4 ALLROAD (8KH, B8)						
2.0 TDi Quattro (100 kW)	2009.09-	Estate Engine CAGB/CJCB	•		GHA262001	K
2.0 TDi Quattro (105 kW)	2009.09-	Estate Engine CAGA/CJCA	•		GHA262001	K
2.0 TDi Quattro (110 kW)	2013.05-	Estate Engine CJCD	•		GHA262001	K
2.0 TDi Quattro (120 kW)	2009.04-	Estate Engine CAHB/CGLD	•		GHA262001	K
2.0 TDi Quattro (125 kW)	2009.04-	Estate Engine CAHA	•		GHA262001	K
2.0 TDi Quattro (130 kW)	2011.11-	Estate Engine CGLC	•		GHA262001	K
2.0 TDi Quattro (140 kW)	2013.09-	Estate Engine CNHA	•		GHA262001	K
2.0 TFSi Quattro (155 kW)	2009.04-	Estate Engine CDNC/CPMA	•		GHA262001	K
2.0 TFSi Quattro (162 kW)	2013.05-	Estate Engine CPMB	•		GHA262001	K
2.0 TFSi Quattro (165 kW)	2013.05-	Estate Engine CNCD	•		GHA262001	K
3.0 TDi Quattro (176 kW)	2009.04-	Estate Engine CCWA	•		GHA262001	K
3.0 TDi Quattro (180 kW)	2012.01-	Estate Engine CDUC/CKVB/CKVC	•		GHA262001	K
A4 AVANT (8D5, B5)						
1.6 (74 kW)	1994.11-2001.09	Estate Engine ADP/AHL/ANA/ARM	•		GHA433002	
	1994.11-2001.09	Estate Engine ADP/AHL/ANA/ARM	•		GWB1355	
	1994.11-2001.09	Estate Engine ADP/AHL/ANA/ARM		◦	GHA499047	
	1994.11-2001.09	Estate Engine ADP/AHL/ANA/ARM		◦	GWB0542	
	1994.11-2001.09	Estate Engine ADP/AHL/ANA/ARM		◦	GWB3519	
1.6 (75 kW)	2000.07-2001.09	Estate Engine ALZ	•		GHA433002	
	2000.07-2001.09	Estate Engine ALZ	•		GWB1355	
	2000.07-2001.09	Estate Engine ALZ		◦	GHA499047	
	2000.07-2001.09	Estate Engine ALZ		◦	GWB3519	
1.8 (85 kW)	1995.07-2001.09	Estate Engine AFY	•		GHA433002	
	1995.07-2001.09	Estate Engine AFY	•		GWB1355	
	1995.07-2001.09	Estate Engine AFY		◦	GWB0542	
	1995.07-2001.09	Estate Engine AFY		◦	GWB3519	
1.8 (92 kW)	1996.02-2001.09	Estate Engine ADR/APT/ARG/AVV	•		GHA433002	
	1996.02-2001.09	Estate Engine ADR/APT/ARG/AVV	•		GWB1355	
	1996.02-2001.09	Estate Engine ADR/APT/ARG/AVV		◦	GHA499047	
	1996.02-2001.09	Estate Engine ADR/APT/ARG/AVV		◦	GWB0542	
	1996.02-2001.09	Estate Engine ADR/APT/ARG/AVV		◦	GWB3519	
1.8 Quattro (85 kW)	1995.07-2001.09	Estate Engine AFY	•		GHA433002	
	1995.07-2001.09	Estate Engine AFY	•		GWB1355	
1.8 Quattro (92 kW)	1996.01-2001.09	Estate Engine ADR/APT/ARG	•		GHA433002	
	1996.01-2001.09	Estate Engine ADR/APT/ARG	•		GWB1355	
1.8 T (110 kW)	1996.03-2001.09	Estate Engine AEB/ANB/APU/ARK/AWT	•		GHA433002	
	1996.03-2001.09	Estate Engine AEB/ANB/APU/ARK/AWT	•		GWB1355	
	1996.03-2001.09	Estate Engine AEB/ANB/APU/ARK/AWT		◦	GHA499047	
	1996.03-2001.09	Estate Engine AEB/ANB/APU/ARK/AWT		◦	GWB0542	
1.8 T (132 kW)	1996.03-2001.09	Estate Engine AEB/ANB/APU/ARK/AWT		◦	GWB3519	
	1997.12-2001.09	Estate Engine AJL	•		GWB1356	



	 YEAR		F	R	G-AP Ref.	KIT
AUDI						
A4 AVANT (8D5, B5)						
1.8 T (132 kW)	1997.12-2001.09	Estate Engine AJL		o	GHA499047	
	1997.12-2001.09	Estate Engine AJL		o	GWB3519	
1.8 T Quattro (110 kW)	1996.01-2001.09	Estate Engine AEB/ANB/APU/ARK/AWT	•		GHA433002	
	1996.01-2001.09	Estate Engine AEB/ANB/APU/ARK/AWT	•		GWB1355	
1.8 T Quattro (132 kW)	1997.12-2001.09	Estate Engine AJL	•		GWB1356	
	1997.12-2001.09	Estate Engine AJL		o	GWB1355	
1.9 DUO (66 kW)	1998.03-2001.09	Estate Engine AHU	•		GHA433002	
	1998.03-2001.09	Estate Engine AHU	•		GWB1355	
	1998.03-2001.09	Estate Engine AHU		o	GHA499047	
	1998.03-2001.09	Estate Engine AHU		o	GWB3519	
1.9 TDi (55 kW)	1996.03-2001.09	Estate Engine AFF	•		GHA433002	
	1996.03-2001.09	Estate Engine AFF	•		GWB1355	
	1996.03-2001.09	Estate Engine AFF		o	GHA499047	
	1996.03-2001.09	Estate Engine AFF		o	GWB0542	
	1996.03-2001.09	Estate Engine AFF		o	GWB3519	
1.9 TDi (66 kW)	1996.02-2001.09	Estate Engine 1Z/AHH/AHU	•		GHA433002	
	1996.02-2001.09	Estate Engine 1Z/AHH/AHU	•		GWB1355	
	1996.02-2001.09	Estate Engine 1Z/AHH/AHU		o	GHA499047	
	1996.02-2001.09	Estate Engine 1Z/AHH/AHU		o	GWB0542	
	1996.02-2001.09	Estate Engine 1Z/AHH/AHU		o	GWB3519	
1.9 TDi (81 kW)	1996.02-2001.09	Estate Engine AFN/AVG	•		GHA433002	
	1996.02-2001.09	Estate Engine AFN/AVG	•		GWB1355	
	1996.02-2001.09	Estate Engine AFN/AVG		o	GHA499047	
	1996.02-2001.09	Estate Engine AFN/AVG		o	GWB0542	
	1996.02-2001.09	Estate Engine AFN/AVG		o	GWB3519	
1.9 TDi (85 kW)	2000.03-2001.09	Estate Engine AJM	•		GHA433002	
	2000.03-2001.09	Estate Engine AJM	•		GWB1355	
	2000.03-2001.09	Estate Engine AJM		o	GHA499047	
	2000.03-2001.09	Estate Engine AJM		o	GWB3519	
1.9 TDi Quattro (81 kW)	1996.09-2001.09	Estate Engine AFN/AVG	•		GHA433002	
	1996.09-2001.09	Estate Engine AFN/AVG	•		GWB1355	
1.9 TDi Quattro (85 kW)	2000.03-2001.09	Estate Engine AJM/ATJ	•		GHA433002	
	2000.03-2001.09	Estate Engine AJM/ATJ	•		GWB1356	
	2000.03-2001.09	Estate Engine AJM/ATJ		o	GWB1355	
2.4 (110 kW)	1995.07-1997.07	Estate Engine AFW	•		GWB1356	
	1995.07-1997.07	Estate Engine AFW		o	GWB0542	
	1995.07-1997.07	Estate Engine AFW		o	GWB3519	
2.4 (120 kW)	1997.08-2001.09	Estate Engine AJG/AMM/APZ	•		GWB1356	
	1997.08-2001.09	Estate Engine AJG/AMM/APZ		o	GHA499047	
	1997.08-2001.09	Estate Engine AJG/AMM/APZ		o	GWB3519	
2.4 (121 kW)	1997.03-2001.09	Estate Engine AGA/ALF/AML/APS/ARJ	•		GWB1356	
	1997.03-2001.09	Estate Engine AGA/ALF/AML/APS/ARJ		o	GHA499047	
	1997.03-2001.09	Estate Engine AGA/ALF/AML/APS/ARJ		o	GWB0542	
	1997.03-2001.09	Estate Engine AGA/ALF/AML/APS/ARJ		o	GWB3519	
2.4 Quattro (120 kW)	1997.08-2001.09	Estate Engine APZ	•		GWB1356	
	1997.08-2001.09	Estate Engine APZ		o	GWB1355	
2.4 Quattro (121 kW)	1997.03-2001.09	Estate Engine AGA/ALF/AML/APS/ARJ	•		GWB1356	
	1997.03-2001.09	Estate Engine AGA/ALF/AML/APS/ARJ		o	GWB1355	
2.5 TDi (110 kW)	1997.09-2001.09	Estate Engine AFB/AKN	•		GWB1356	
	1997.09-2001.09	Estate Engine AFB/AKN		o	GHA499047	
	1997.09-2001.09	Estate Engine AFB/AKN		o	GWB3519	
2.5 TDi Quattro (110 kW)	1997.09-2001.09	Estate Engine AFB/AKN	•		GWB1356	
	1997.09-2001.09	Estate Engine AFB/AKN		o	GWB1355	
2.6 (110 kW)	1996.02-2001.09	Estate Engine ABC	•		GWB1356	
	1996.02-2001.09	Estate Engine ABC		o	GHA499047	
	1996.02-2001.09	Estate Engine ABC		o	GWB0542	
	1996.02-2001.09	Estate Engine ABC		o	GWB3519	
	1996.02-2001.09	Estate Engine ABC			GWB3427	
2.6 Quattro (110 kW)	1996.01-2001.09	Estate Engine ABC	•		GWB1356	
	1996.01-2001.09	Estate Engine ABC		o	GWB1355	
	1996.01-2001.09	Estate Engine ABC			GWB3427	
2.7 RS4 Quattro (280 kW)	2000.05-2001.09	Estate Engine ASJ/AZR	•		GHA245010	K
	2000.05-2001.09	Estate Engine ASJ/AZR		o	GWB1355	
2.7 S4 Quattro (195 kW)	1997.09-2001.09	Estate Engine AGB/AZB	•		GWB1356	



	 YEAR		F	R	G-AP Ref.	KIT
AUDI						
A4 AVANT (8D5, B5)						
2.7 S4 Quattro (195 kW)	1997.09-2001.09	Estate Engine AGB/AZB		o	GWB1355	
2.8 (128 kW)	1996.03-1996.09	Estate Engine AAH	•		GWB1356	
	1996.03-1996.09	Estate Engine AAH		o	GHA499047	
	1996.03-1996.09	Estate Engine AAH		o	GWB0542	
	1996.03-1996.09	Estate Engine AAH		o	GWB3519	
	1996.03-1996.09	Estate Engine AAH		o	GWB3427	
2.8 (140 kW)	1999.03-2000.09	Estate Engine ATX	•		GWB1356	
	1999.03-2000.09	Estate Engine ATX		o	GWB3519	
2.8 (142 kW)	1996.10-2001.09	Estate Engine ACK/AHA/ALG/AMX/APR/AQD	•		GWB1356	
	1996.10-2001.09	Estate Engine ACK/AHA/ALG/AMX/APR/AQD		o	GHA499047	
	1996.10-2001.09	Estate Engine ACK/AHA/ALG/AMX/APR/AQD		o	GWB0542	
	1996.10-2001.09	Estate Engine ACK/AHA/ALG/AMX/APR/AQD		o	GWB3519	
	1996.10-2001.09	Estate Engine ACK/AHA/ALG/AMX/APR/AQD		o	GWB3427	
2.8 Quattro (128 kW)	1996.01-1996.09	Estate Engine AAH	•		GWB1356	
	1996.01-1996.09	Estate Engine AAH		o	GWB1355	
	1996.01-1996.09	Estate Engine AAH		o	GWB3427	
2.8 Quattro (140 kW)	1999.03-2000.09	Estate Engine ATX	•		GWB1356	
	1999.03-2000.09	Estate Engine ATX		o	GWB1355	
2.8 Quattro (142 kW)	1996.10-2001.09	Estate Engine ACK/AHA/ALG/AMX/APR/AQD	•		GWB1356	
	1996.10-2001.09	Estate Engine ACK/AHA/ALG/AMX/APR/AQD		o	GWB1355	
	1996.10-2001.09	Estate Engine ACK/AHA/ALG/AMX/APR/AQD		o	GWB3427	
A4 AVANT (8E5, B6)						
1.6 (75 kW)	2001.09-2004.12	Estate Engine ALZ	•		GHA245010	K
	2001.09-2004.12	Estate Engine ALZ	•		GHA433002	
	2001.09-2004.12	Estate Engine ALZ		o	GHA232014	K
1.8 T (110 kW)	2001.09-2002.07	Estate Engine AVJ	•		GHA245010	K
	2001.09-2002.07	Estate Engine AVJ		o	GHA232014	K
1.8 T (120 kW)	2002.07-2004.12	Estate Engine BFB	•		GHA245010	K
	2002.07-2004.12	Estate Engine BFB		o	GHA232014	K
1.8 T (140 kW)	2002.11-2004.12	Estate Engine BEX	•		GHA245010	K
	2002.11-2004.12	Estate Engine BEX		o	GHA232014	K
1.8 T Quattro (110 kW)	2001.09-2002.07	Estate Engine AVJ	•		GHA245010	K
	2001.09-2002.07	Estate Engine AVJ		o	GWB3605	
1.8 T Quattro (120 kW)	2002.07-2004.12	Estate Engine BFB	•		GHA245010	K
	2002.07-2004.12	Estate Engine BFB		o	GWB3605	
1.8 T Quattro (125 kW)	2001.09-2004.12	Estate Engine AMB	•		GHA245010	K
	2001.09-2004.12	Estate Engine AMB		o	GWB3605	
1.8 T Quattro (140 kW)	2002.11-2004.12	Estate Engine BEX	•		GHA245010	K
	2002.11-2004.12	Estate Engine BEX		o	GWB3605	
1.9 TDi (74 kW)	2001.11-2004.12	Estate Engine AVB	•		GHA245010	K
	2001.11-2004.12	Estate Engine AVB		o	GHA232014	K
1.9 TDi (85 kW)	2004.06-2004.12	Estate Engine BKE	•		GHA245010	K
	2004.06-2004.12	Estate Engine BKE		o	GHA232014	K
1.9 TDi (96 kW)	2001.09-2004.12	Estate Engine AVF/AWX	•		GHA245010	K
	2001.09-2004.12	Estate Engine AVF/AWX		o	GHA232014	K
1.9 TDi Quattro (96 kW)	2001.11-2004.12	Estate Engine AVF	•		GHA245010	K
	2001.11-2004.12	Estate Engine AVF		o	GWB3605	
2.0 (96 kW)	2001.09-2004.12	Estate Engine ALT	•		GHA245010	K
	2001.09-2004.12	Estate Engine ALT		o	GHA232014	K
2.0 FSi (110 kW)	2002.07-2004.12	Estate Engine AWA	•		GHA245010	K
	2002.07-2004.12	Estate Engine AWA		o	GHA232014	K
2.4 (120 kW)	2001.09-2004.12	Estate Engine AMM	•		GHA245010	K
	2001.09-2004.12	Estate Engine AMM		o	GHA232014	K
2.4 (125 kW)	2001.09-2004.12	Estate Engine BDV	•		GHA245010	K
	2001.09-2004.12	Estate Engine BDV		o	GHA232014	K
2.5 TDi (114 kW)	2001.09-2002.07	Estate Engine AYM	•		GHA245010	K
	2001.09-2002.07	Estate Engine AYM		o	GHA232014	K
2.5 TDi (120 kW)	2002.07-2004.12	Estate Engine BCZ/BDG/BFC	•		GHA245010	K
	2002.07-2004.12	Estate Engine BCZ/BDG/BFC		o	GHA232014	K
2.5 TDi Quattro (132 kW)	2001.09-2004.12	Estate Engine AKE/BAU/BDH	•		GHA245010	K
	2001.09-2004.12	Estate Engine AKE/BAU/BDH		o	GWB3605	
3.0 (160 kW)	2001.04-2004.12	Estate Engine BBJ	•		GHA245010	K
	2001.04-2004.12	Estate Engine BBJ		o	GHA232014	K
3.0 (162 kW)	2001.09-2004.12	Estate Engine ASN	•		GHA245010	K



	 YEAR		F	R	G-AP Ref.	KIT
AUDI						
A4 AVANT (8E5, B6)						
3.0 (162 kW)	2001.09-2004.12	Estate Engine ASN		o	GHA232014	K
3.0 Quattro (160 kW)	2001.04-2004.12	Estate Engine BBJ	•		GHA245010	K
	2001.04-2004.12	Estate Engine BBJ		o	GWB3605	
3.0 Quattro (162 kW)	2001.09-2004.12	Estate Engine ASN/AVK	•		GHA245010	K
	2001.09-2004.12	Estate Engine ASN/AVK		o	GWB3605	
4.2 S4 Quattro (253 kW)	2003.03-2004.12	Estate Engine BBK	•		GHA245010	K
	2003.03-2004.12	Estate Engine BBK		o	GWB3605	
A4 AVANT (8ED, B7)						
1.6 (75 kW)	2004.11-2008.06	Estate Engine ALZ	•		GHA245010	K
	2004.11-2008.06	Estate Engine ALZ	•		GHA433002	
	2004.11-2008.06	Estate Engine ALZ		o	GHA232014	K
1.8 T (120 kW)	2004.11-2008.06	Estate Engine BFB	•		GHA245010	K
	2004.11-2008.06	Estate Engine BFB		o	GHA232014	K
1.8 T Quattro (120 kW)	2004.11-2008.06	Estate Engine BFB	•		GHA245010	K
	2004.11-2008.06	Estate Engine BFB		o	GWB3605	
1.9 TDi (85 kW)	2004.11-2008.06	Estate Engine BKE/BRB	•		GHA245010	K
	2004.11-2008.06	Estate Engine BKE/BRB		o	GHA232014	K
2.0 (96 kW)	2004.11-2008.06	Estate Engine ALT	•		GHA245010	K
	2004.11-2008.06	Estate Engine ALT		o	GHA232014	K
2.0 TDi (100 kW)	2007.02-2007.08	Estate Engine BNA/BRF	•		GHA245010	K
	2007.02-2007.08	Estate Engine BNA/BRF		o	GHA232014	K
2.0 TDi (103 kW)	2007.02-2007.08	Estate Engine BPW	•		GHA245010	K
	2007.02-2007.08	Estate Engine BPW		o	GHA232014	K
2.0 TDi (120 kW)	2006.06-2008.06	Estate Engine BVA	•		GHA245010	K
	2006.06-2008.06	Estate Engine BVA		o	GHA232014	K
2.0 TDi (125 kW)	2006.05-2007.08	Estate Engine BRD	•		GHA245010	K
	2006.05-2007.08	Estate Engine BRD		o	GHA232014	K
2.0 TDi (89 kW)	2005.09-2006.09	Estate Engine BVG	•		GHA245010	K
	2005.09-2006.09	Estate Engine BVG		o	GHA232014	K
2.0 TDi (93 kW)	2005.11-2006.11	Estate Engine BVF	•		GHA245010	K
	2005.11-2006.11	Estate Engine BVF		o	GHA232014	K
2.0 TDi 16V (103 kW)	2004.11-2008.06	Estate Engine BLB/BRE	•		GHA245010	K
	2004.11-2008.06	Estate Engine BLB/BRE		o	GHA232014	K
2.0 TDi Quattro (103 kW)	2006.01-2008.06	Estate Engine BPW	•		GHA245010	K
	2006.01-2008.06	Estate Engine BPW		o	GWB3605	
2.0 TDi Quattro (120 kW)	2006.06-2008.06	Estate Engine BVA	•		GHA245010	K
	2006.06-2008.06	Estate Engine BVA		o	GWB3605	
2.0 TDi Quattro (125 kW)	2006.05-2007.08	Estate Engine BRD	•		GHA245010	K
	2006.05-2007.08	Estate Engine BRD		o	GWB3605	
2.0 TFSi (125 kW)	2006.10-2008.06	Estate Engine BPJ/BYK	•		GHA245010	K
	2006.10-2008.06	Estate Engine BPJ/BYK		o	GHA232014	K
2.0 TFSi (147 kW)	2004.11-2008.06	Estate Engine BGB/BWE	•		GHA245010	K
	2004.11-2008.06	Estate Engine BGB/BWE		o	GHA232014	K
2.0 TFSi (162 kW)	2007.02-2007.08	Estate Engine BUL	•		GHA245010	K
	2007.02-2007.08	Estate Engine BUL		o	GHA232014	K
2.0 TFSi Quattro (147 kW)	2004.11-2008.06	Estate Engine BGB/BWE/BWT	•		GHA245010	K
	2004.11-2008.06	Estate Engine BGB/BWE/BWT		o	GWB3605	
2.0 TFSi Quattro (162 kW)	2005.12-2007.08	Estate Engine BUL	•		GHA245010	K
	2005.12-2007.08	Estate Engine BUL		o	GWB3605	
2.5 TDi (120 kW)	2004.11-2006.05	Estate Engine BDG	•		GHA245010	K
	2004.11-2006.05	Estate Engine BDG		o	GHA232014	K
2.7 TDi (120 kW)	2005.11-2008.03	Estate Engine BSG	•		GHA245010	K
	2005.11-2008.03	Estate Engine BSG		o	GHA232014	K
2.7 TDi (132 kW)	2006.02-2007.08	Estate Engine BPP	•		GHA245010	K
	2006.02-2007.08	Estate Engine BPP		o	GHA232014	K
3.0 (160 kW)	2004.11-2006.05	Estate Engine BBJ	•		GHA245010	K
	2004.11-2006.05	Estate Engine BBJ		o	GHA232014	K
3.0 Quattro (160 kW)	2004.11-2006.07	Estate Engine BBJ	•		GHA245010	K
	2004.11-2006.07	Estate Engine BBJ		o	GWB3605	
3.0 TDi Quattro (150 kW)	2004.11-2008.06	Estate Engine BKN	•		GHA245010	K
	2004.11-2008.06	Estate Engine BKN		o	GWB3605	
3.0 TDi Quattro (171 kW)	2007.02-2007.08	Estate Engine ASB	•		GHA245010	K
	2007.02-2007.08	Estate Engine ASB		o	GWB3605	
3.2 FSi (188 kW)	2005.01-2008.06	Estate Engine AUK	•		GHA245010	K



	 YEAR		F	R	G-AP Ref.	KIT
AUDI						
A4 AVANT (8ED, B7)						
3.2 FSi (188 kW)	2005.01-2008.06	Estate Engine AUK		o	GHA232014	K
3.2 FSi Quattro (188 kW)	2005.01-2008.06	Estate Engine AUK	•		GHA245010	K
	2005.01-2008.06	Estate Engine AUK		o	GWB3605	
4.2 RS4 Quattro (309 kW)	2005.09-2008.06	Estate Engine BNS	•		GHA245010	K
4.2 S4 Quattro (253 kW)	2007.02-2007.08	Estate Engine BBK	•		GHA245010	K
	2007.02-2007.08	Estate Engine BBK		o	GWB3605	
A4 AVANT (8K5, B8)						
1.8 TFSi (118 kW)	2007.11-	Estate Engine CABB/CDHB	•		GHA262001	K
	2007.11-	Estate Engine CABB/CDHB		o	GHA232026	K
1.8 TFSi (125 kW)	2011.11-	Estate Engine CJEB	•		GHA262001	K
	2011.11-	Estate Engine CJEB		o	GHA232026	K
1.8 TFSi (88 kW)	2008.04-	Estate Engine CDHA	•		GHA262001	K
	2008.04-	Estate Engine CDHA		o	GHA232026	K
1.8 TFSi Quattro (118 kW)	2008.09-	Estate Engine CDHB	•		GHA262001	K
1.8 TFSi Quattro (125 kW)	2011.11-	Estate Engine CJEB	•		GHA262001	K
2.0 TDi (100 kW)	2008.04-	Estate Engine CJCB/CAGB	•		GHA262001	K
	2008.04-	Estate Engine CJCB/CAGB		o	GHA232026	K
2.0 TDi (105 kW)	2008.04-	Estate Engine CAGA/CJCA/CMEA/CMFA	•		GHA262001	K
	2008.04-	Estate Engine CAGA/CJCA/CMEA/CMFA		o	GHA232026	K
2.0 TDi (110 kW)	2013.05-	Estate Engine CJCD/CMFB/CSUA	•		GHA262001	K
	2013.05-	Estate Engine CJCD/CMFB/CSUA		o	GHA232026	K
2.0 TDi (120 kW)	2008.08-	Estate Engine CAHB/CGLD	•		GHA262001	K
	2008.08-	Estate Engine CAHB/CGLD		o	GHA232026	K
2.0 TDi (125 kW)	2008.04-	Estate Engine CAHA	•		GHA262001	K
	2008.04-	Estate Engine CAHA		o	GHA232026	K
2.0 TDi (130 kW)	2011.11-	Estate Engine CGLC	•		GHA262001	K
	2011.11-	Estate Engine CGLC		o	GHA232026	K
2.0 TDi (140 kW)	2013.09-	Estate Engine CNHA	•		GHA262001	K
	2013.09-	Estate Engine CNHA		o	GHA232026	K
2.0 TDi (88 kW)	2008.06-	Estate Engine CAGC/CJCC	•		GHA262001	K
	2008.06-	Estate Engine CAGC/CJCC		o	GHA232026	K
2.0 TDi Quattro (105 kW)	2008.04-	Estate Engine CAGA/CJCA	•		GHA262001	K
2.0 TDi Quattro (110 kW)	2013.05-	Estate Engine CJCD/CSUA	•		GHA262001	K
2.0 TDi Quattro (125 kW)	2008.08-	Estate Engine CAHA	•		GHA262001	K
2.0 TDi Quattro (130 kW)	2011.11-	Estate Engine CGLC	•		GHA262001	K
2.0 TDi Quattro (140 kW)	2013.09-	Estate Engine CNHA	•		GHA262001	K
2.0 TFSi (132 kW)	2008.06-	Estate Engine CDN/CFKA	•		GHA262001	K
	2008.06-	Estate Engine CDN/CFKA		o	GHA232026	K
2.0 TFSi (155 kW)	2008.06-	Estate Engine CAEB/CDNC	•		GHA262001	K
	2008.06-	Estate Engine CAEB/CDNC		o	GHA232026	K
2.0 TFSi (165 kW)	2013.05-	Estate Engine CNCD	•		GHA262001	K
	2013.05-	Estate Engine CNCD		o	GHA232026	K
2.0 TFSi FlexFuel (132 kW)	2009.11-	Estate Engine CFKA	•		GHA262001	K
	2009.11-	Estate Engine CFKA		o	GHA232026	K
2.0 TFSi FlexFuel Quattro (132 kW)	2009.11-	Estate Engine CFKA	•		GHA262001	K
2.0 TFSi Quattro (155 kW)	2008.06-	Estate Engine CDNC/CAEB	•		GHA262001	K
2.0 TFSi Quattro (165 kW)	2013.05-	Estate Engine CNCD	•		GHA262001	K
2.7 TDi (120 kW)	2008.06-	Estate Engine CGKB/CAMB	•		GHA262001	K
	2008.06-	Estate Engine CGKB/CAMB		o	GHA232026	K
2.7 TDi (140 kW)	2008.04-	Estate Engine CAMA/CGKA	•		GHA262001	K
	2008.04-	Estate Engine CAMA/CGKA		o	GHA232026	K
3.0 S4 Quattro (245 kW)	2008.11-	Estate Engine CAKA/CGWC	•		GHA262001	K
3.0 TDi (150 kW)	2011.11-	Estate Engine CLAB	•		GHA262001	K
	2011.11-	Estate Engine CLAB		o	GHA232026	K
3.0 TDi Quattro (155 kW)	2008.06-	Estate Engine CCWB	•		GHA262001	K
3.0 TDi Quattro (176 kW)	2008.04-	Estate Engine CAPA/CCLA/CCWA	•		GHA262001	K
3.0 TDi Quattro (180 kW)	2011.11-	Estate Engine CDUC/CKVB/CKVC	•		GHA262001	K
3.0 TFSi Quattro (200 kW)	2012.02-	Estate Engine CMUA	•		GHA262001	K
3.2 FSi (195 kW)	2008.09-	Estate Engine CALA	•		GHA262001	K
	2008.09-	Estate Engine CALA		o	GHA232026	K
3.2 FSi Quattro (195 kW)	2008.04-	Estate Engine CALA	•		GHA262001	K
4.2 RS4 Quattro (331 kW)	2012.05-	Estate Engine CFSA	•		GHA262001	K
A5 (8F7)						
1.8 TFSi (118 kW)	2009.09-	Convertible Engine CDHB	•		GHA262001	K



	 YEAR		F	R	G-AP Ref.	KIT
AUDI						
A5 (8F7)						
1.8 TFSi (118 kW)	2009.09-	Convertible Engine CDHB		o	GHA232026	K
1.8 TFSi (125 kW)	2011.10-	Convertible Engine CABD/CJEB	•		GHA262001	K
	2011.10-	Convertible Engine CABD/CJEB		o	GHA232026	K
1.8 TFSi (130 kW)	2015.05-	Convertible Engine CJEE	•		GHA262001	K
	2015.05-	Convertible Engine CJEE		o	GHA232026	K
2.0 TDi (105 kW)	2011.10-	Convertible Engine CJCA	•		GHA262001	K
	2011.10-	Convertible Engine CJCA		o	GHA232026	K
2.0 TDi (110 kW)	2013.05-	Convertible Engine CJCD	•		GHA262001	K
	2013.05-	Convertible Engine CJCD		o	GHA232026	K
2.0 TDi (120 kW)	2009.05-	Convertible Engine CAHB/CGLD	•		GHA262001	K
	2009.05-	Convertible Engine CAHB/CGLD		o	GHA232026	K
2.0 TDi (125 kW)	2009.05-	Convertible Engine CAHA	•		GHA262001	K
	2009.05-	Convertible Engine CAHA		o	GHA232026	K
2.0 TDi (130 kW)	2011.10-	Convertible Engine CGLC	•		GHA262001	K
	2011.10-	Convertible Engine CGLC		o	GHA232026	K
2.0 TDi (140 kW)	2013.09-	Convertible Engine CNHA	•		GHA262001	K
	2013.09-	Convertible Engine CNHA		o	GHA232026	K
2.0 TDi Quattro (130 kW)	2012.01-	Convertible Engine CGLC	•		GHA262001	K
2.0 TDi Quattro (140 kW)	2013.09-	Convertible Engine CNHA	•		GHA262001	K
2.0 TFSi (132 kW)	2009.03-	Convertible Engine CAEA/CDNB	•		GHA262001	K
	2009.03-	Convertible Engine CAEA/CDNB		o	GHA232026	K
2.0 TFSi (155 kW)	2009.03-	Convertible Engine CAEB/CDNC	•		GHA262001	K
	2009.03-	Convertible Engine CAEB/CDNC		o	GHA232026	K
2.0 TFSi (165 kW)	2013.05-	Convertible Engine CNCD	•		GHA262001	K
	2013.05-	Convertible Engine CNCD		o	GHA232026	K
2.0 TFSi (169 kW)	2015.08-	Convertible Engine CNCE	•		GHA262001	K
	2015.08-	Convertible Engine CNCE		o	GHA232026	K
2.0 TFSi Quattro (155 kW)	2009.03-	Convertible Engine CAEB/CDNC	•		GHA262001	K
2.0 TFSi Quattro (162 kW)	2012.03-	Convertible Engine CPMB	•		GHA262001	K
2.0 TFSi Quattro (165 kW)	2013.05-	Convertible Engine CNCD	•		GHA262001	K
2.0 TFSi Quattro (169 kW)	2015.08-	Convertible Engine CNCE	•		GHA262001	K
2.7 TDi (120 kW)	2009.05-	Convertible Engine CGKB	•		GHA262001	K
	2009.05-	Convertible Engine CGKB		o	GHA232026	K
2.7 TDi (140 kW)	2009.03-	Convertible Engine CGKA	•		GHA262001	K
	2009.03-	Convertible Engine CGKA		o	GHA232026	K
3.0 S5 Quattro (245 kW)	2009.06-	Convertible Engine CAKA/CCBA/CGWC/CGXC/CTUB	•		GHA262001	K
3.0 TDi (150 kW)	2011.10-	Convertible Engine CLAB	•		GHA262001	K
	2011.10-	Convertible Engine CLAB		o	GHA232026	K
3.0 TDi Quattro (160 kW)	2015.05-	Convertible Engine CKVD	•		GHA262001	K
3.0 TDi Quattro (176 kW)	2009.03-	Convertible Engine CCWA	•		GHA262001	K
3.0 TDi Quattro (180 kW)	2011.10-	Convertible Engine CDUC	•		GHA262001	K
3.0 TFSi Quattro (200 kW)	2011.11-	Convertible Engine CMUA	•		GHA262001	K
3.2 FSi (195 kW)	2009.03-	Convertible Engine CALA	•		GHA262001	K
	2009.03-	Convertible Engine CALA		o	GHA232026	K
3.2 FSi Quattro (195 kW)	2009.03-	Convertible Engine CALA	•		GHA262001	K
4.2 RS 5 Quattro (331 kW)	2013.02-	Convertible Engine CFSA	•		GHA262001	K
A5 (8T3)						
1.8 TFSi (118 kW)	2009.05-	Coupe Engine CDHB	•		GHA262001	K
	2009.05-	Coupe Engine CDHB		o	GHA232026	K
1.8 TFSi (125 kW)	2007.09-	Coupe Engine CABD/CJEB	•		GHA262001	K
	2007.09-	Coupe Engine CABD/CJEB		o	GHA232026	K
1.8 TFSi (130 kW)	2015.05-	Coupe Engine CJEE	•		GHA262001	K
	2015.05-	Coupe Engine CJEE		o	GHA232026	K
2.0 TDi (120 kW)	2008.08-	Coupe Engine CGLD/CAHB	•		GHA262001	K
	2008.08-	Coupe Engine CGLD/CAHB		o	GHA232026	K
2.0 TDi (125 kW)	2008.08-	Coupe Engine CAHA	•		GHA262001	K
	2008.08-	Coupe Engine CAHA		o	GHA232026	K
2.0 TDi (130 kW)	2011.10-	Coupe Engine CGLC	•		GHA262001	K
	2011.10-	Coupe Engine CGLC		o	GHA232026	K
2.0 TDi (140 kW)	2013.09-	Coupe Engine CNHA	•		GHA262001	K
	2013.09-	Coupe Engine CNHA		o	GHA232026	K
2.0 TDi Quattro (125 kW)	2008.08-	Coupe Engine CAHA	•		GHA262001	K
2.0 TDi Quattro (130 kW)	2011.12-	Coupe Engine CGLC	•		GHA262001	K
2.0 TDi Quattro (140 kW)	2013.09-	Coupe Engine CNHA	•		GHA262001	K



	 YEAR		F	R	G-AP Ref.	KIT
AUDI						
A5 (8T3)						
2.0 TFSi (132 kW)	2008.11-	Coupe Engine CDNB	•		GHA262001	K
	2008.11-	Coupe Engine CDNB		◦	GHA232026	K
2.0 TFSi (155 kW)	2008.06-	Coupe Engine CDNC	•		GHA262001	K
	2008.06-	Coupe Engine CDNC		◦	GHA232026	K
2.0 TFSi (165 kW)	2013.05-	Coupe Engine CNCD	•		GHA262001	K
	2013.05-	Coupe Engine CNCD		◦	GHA232026	K
2.0 TFSi (169 kW)	2015.08-	Coupe Engine CNCE	•		GHA262001	K
	2015.08-	Coupe Engine CNCE		◦	GHA232026	K
2.0 TFSi Quattro (155 kW)	2008.06-	Coupe Engine CAEB/CDNC	•		GHA262001	K
2.0 TFSi Quattro (162 kW)	2012.03-	Coupe Engine CAED/CPMB	•		GHA262001	K
2.0 TFSi Quattro (165 kW)	2013.05-	Coupe Engine CNCD	•		GHA262001	K
2.0 TFSi Quattro (169 kW)	2015.08-	Coupe Engine CNCE	•		GHA262001	K
2.7 TDi (120 kW)	2007.09-	Coupe Engine CGKB/CAMB	•		GHA262001	K
	2007.09-	Coupe Engine CGKB/CAMB		◦	GHA232026	K
2.7 TDi (140 kW)	2007.06-	Coupe Engine CAMA/CGKA	•		GHA262001	K
	2007.06-	Coupe Engine CAMA/CGKA		◦	GHA232026	K
3.0 S5 Quattro (245 kW)	2011.10-	Coupe Engine CAKA/CGWC/CGXC/CTUB	•		GHA262001	K
3.0 TDi (150 kW)	2011.10-	Coupe Engine CLAB	•		GHA262001	K
	2011.10-	Coupe Engine CLAB		◦	GHA232026	K
3.0 TDi Quattro (155 kW)	2008.03-	Coupe Engine CCWB	•		GHA262001	K
3.0 TDi Quattro (160 kW)	2015.05-	Coupe Engine CKVD	•		GHA262001	K
3.0 TDi Quattro (176 kW)	2007.06-	Coupe Engine CAPA/CCWA	•		GHA262001	K
3.0 TDi Quattro (180 kW)	2011.10-	Coupe Engine CDUC/CKVB	•		GHA262001	K
3.0 TFSi Quattro (200 kW)	2011.12-	Coupe Engine CMUA	•		GHA262001	K
3.2 FSi (195 kW)	2007.06-	Coupe Engine CALA	•		GHA262001	K
	2007.06-	Coupe Engine CALA		◦	GHA232026	K
3.2 FSi Quattro (195 kW)	2007.06-	Coupe Engine CALA	•		GHA262001	K
4.2 RS 5 Quattro (331 kW)	2010.03-	Coupe Engine CFSA	•		GHA262001	K
4.2 S5 Quattro (260 kW)	2007.06-	Coupe Engine CAUA	•		GHA262001	K
A5 (8TA)						
1.8 TFSi (118 kW)	2009.11-	Hatchback Engine CDHB	•		GHA262001	K
	2009.11-	Hatchback Engine CDHB		◦	GHA232026	K
1.8 TFSi (125 kW)	2011.08-	Hatchback Engine CJEB	•		GHA262001	K
	2011.08-	Hatchback Engine CJEB		◦	GHA232026	K
2.0 TDi (100 kW)	2009.09-	Hatchback Engine CJC/CAGB	•		GHA262001	K
	2009.09-	Hatchback Engine CJC/CAGB		◦	GHA232026	K
2.0 TDi (105 kW)	2009.09-	Hatchback Engine CMFA/CJCA/CMEA/CAGA	•		GHA262001	K
	2009.09-	Hatchback Engine CMFA/CJCA/CMEA/CAGA		◦	GHA232026	K
2.0 TDi (120 kW)	2009.09-	Hatchback Engine CGLD/CAHB	•		GHA262001	K
	2009.09-	Hatchback Engine CGLD/CAHB		◦	GHA232026	K
2.0 TDi (125 kW)	2009.09-	Hatchback Engine CAHA	•		GHA262001	K
	2009.09-	Hatchback Engine CAHA		◦	GHA232026	K
2.0 TDi (130 kW)	2011.10-	Hatchback Engine CGLC	•		GHA262001	K
	2011.10-	Hatchback Engine CGLC		◦	GHA232026	K
2.0 TDi Quattro (125 kW)	2009.09-	Hatchback Engine CAHA	•		GHA262001	K
2.0 TDi Quattro (130 kW)	2011.12-	Hatchback Engine CGLC	•		GHA262001	K
2.0 TFSi (132 kW)	2009.09-	Hatchback Engine CDNB	•		GHA262001	K
	2009.09-	Hatchback Engine CDNB		◦	GHA232026	K
2.0 TFSi (155 kW)	2009.09-	Hatchback Engine CDNC	•		GHA262001	K
	2009.09-	Hatchback Engine CDNC		◦	GHA232026	K
2.0 TFSi Quattro (155 kW)	2009.09-	Hatchback Engine CDNC	•		GHA262001	K
2.7 TDi (140 kW)	2009.09-	Hatchback Engine CGKA	•		GHA262001	K
	2009.09-	Hatchback Engine CGKA		◦	GHA232026	K
3.0 S5 Quattro (245 kW)	2010.01-	Hatchback Engine CAKA/CGWC/CTUB	•		GHA262001	K
3.0 TDi (150 kW)	2011.10-	Hatchback Engine CLAB	•		GHA262001	K
	2011.10-	Hatchback Engine CLAB		◦	GHA232026	K
3.0 TDi Quattro (176 kW)	2009.09-	Hatchback Engine CCWA	•		GHA262001	K
3.0 TDi Quattro (180 kW)	2011.10-	Hatchback Engine CDUC/CKVB	•		GHA262001	K
3.0 TFSi Quattro (200 kW)	2011.12-	Hatchback Engine CMUA	•		GHA262001	K
3.2 FSi Quattro (195 kW)	2009.09-	Hatchback Engine CALA	•		GHA262001	K
A5 CONVERTIBLE (8F7)						
2.0 TFSi (162 kW)	2013.05-	Convertible Engine CAED	•		GHA262001	K
	2013.05-	Convertible Engine CAED		◦	GHA232026	K



	 YEAR		F	R	G-AP Ref.	KIT
AUDI						
A5 SPORTBACK (8TA)						
1.8 TFSi (106 kW)	2014.09-	Hatchback Engine CJED	•		GHA262001	K
	2014.09-	Hatchback Engine CJED		◦	GHA232026	K
1.8 TFSi (130 kW)	2015.05-	Hatchback Engine CJEE	•		GHA262001	K
	2015.05-	Hatchback Engine CJEE		◦	GHA232026	K
2.0 TDi (110 kW)	2013.05-	Hatchback Engine CJCD	•		GHA262001	K
	2013.05-	Hatchback Engine CJCD		◦	GHA232026	K
2.0 TDi (140 kW)	2013.09-	Hatchback Engine CNHA	•		GHA262001	K
	2013.09-	Hatchback Engine CNHA		◦	GHA232026	K
2.0 TDi Quattro (140 kW)	2013.09-	Hatchback Engine CNHA	•		GHA262001	K
	2013.05-	Hatchback Engine CNCD	•		GHA262001	K
2.0 TFSi (165 kW)	2013.05-	Hatchback Engine CNCD		◦	GHA232026	K
	2015.08-	Hatchback Engine CNCE	•		GHA262001	K
2.0 TFSi (169 kW)	2015.08-	Hatchback Engine CNCE		◦	GHA232026	K
	2013.05-	Hatchback Engine CNCD	•		GHA262001	K
2.0 TFSi Quattro (169 kW)	2015.08-	Hatchback Engine CNCE	•		GHA262001	K
	2009.09-	Hatchback Engine CGKB	•		GHA262001	K
2.7 TDi (120 kW)	2009.09-	Hatchback Engine CGKB		◦	GHA232026	K
	2015.05-	Hatchback Engine CKVD	•		GHA262001	K
A6 (4A, C4)						
1.8 (92 kW)	1995.12-1997.10	Saloon Engine ADR	•		GWB1356	
	1995.12-1997.10	Saloon Engine ADR		◦	GHA499047	
	1995.12-1997.10	Saloon Engine ADR		◦	GWB0542	
1.8 Quattro (92 kW)	1995.12-1997.10	Saloon Engine ADR	•		GWB1356	
1.9 TDi (66 kW)	1994.06-1997.10	Saloon Engine 1Z/AHU	•		GWB1356	
	1994.06-1997.10	Saloon Engine 1Z/AHU		◦	GHA499047	
	1994.06-1997.10	Saloon Engine 1Z/AHU		◦	GWB0542	
2.0 (74 kW)	1994.06-1997.10	Saloon Engine AAE	•		GWB1356	
	1994.06-1997.10	Saloon Engine AAE		◦	GHA499047	
	1994.06-1997.10	Saloon Engine AAE		◦	GWB0542	
2.0 (85 kW)	1994.06-1997.10	Saloon Engine ABK	•		GWB1356	
	1994.06-1997.10	Saloon Engine ABK		◦	GHA499047	
	1994.06-1997.10	Saloon Engine ABK		◦	GWB0542	
2.0 16V (103 kW)	1994.06-1997.10	Saloon Engine ACE	•		GWB1356	
	1994.06-1997.10	Saloon Engine ACE		◦	GHA499047	
	1994.06-1997.10	Saloon Engine ACE		◦	GWB0542	
2.0 16V Quattro (103 kW)	1994.06-1997.10	Saloon Engine ACE	•		GWB1356	
2.2 S6 Turbo Quattro (169 kW)	1994.06-1997.10	Saloon Engine AAN	•		GWB1356	
2.3 (98 kW)	1994.06-1995.12	Saloon Engine AAR	•		GWB1356	
	1994.06-1995.12	Saloon Engine AAR		◦	GHA499047	
	1994.06-1995.12	Saloon Engine AAR		◦	GWB0542	
2.3 Quattro (98 kW)	1994.06-1995.12	Saloon Engine AAR	•		GWB1356	
2.4 (110 kW)	1995.07-1996.06	Saloon Engine AFM	•		GWB1356	
	1995.07-1996.06	Saloon Engine AFM		◦	GWB0542	
2.5 TDi (103 kW)	1994.08-1997.10	Saloon Engine AEL	•		GWB1356	
	1994.08-1997.10	Saloon Engine AEL		◦	GHA499047	
	1994.08-1997.10	Saloon Engine AEL		◦	GWB0542	
2.5 TDi (84 kW)	1995.01-1997.10	Saloon Engine AAT	•		GWB1356	
	1995.01-1997.10	Saloon Engine AAT		◦	GWB0542	
2.5 TDi (85 kW)	1994.06-1997.10	Saloon Engine AAT	•		GWB1356	
	1994.06-1997.10	Saloon Engine AAT		◦	GHA499047	
	1994.06-1997.10	Saloon Engine AAT		◦	GWB0542	
2.5 TDi Quattro (103 kW)	1995.10-1997.10	Saloon Engine AEL	•		GWB1356	
2.6 (102 kW)	1994.06-1997.1	Saloon Engine ACZ	•		GWB1356	
	1994.06-1997.1	Saloon Engine ACZ		◦	GWB0542	
2.6 (110 kW)	1994.06-1997.10	Saloon Engine ABC	•		GWB1356	
	1994.06-1997.10	Saloon Engine ABC		◦	GHA499047	
	1994.06-1997.10	Saloon Engine ABC		◦	GWB0542	
2.6 Quattro (110 kW)	1994.06-1997.10	Saloon Engine ABC	•		GWB1356	
2.8 (120 kW)	1995.08-1996.07	Saloon Engine AEJ	•		GWB1356	
	1995.08-1996.07	Saloon Engine AEJ		◦	GWB0542	
2.8 (128 kW)	1994.06-1997.10	Saloon Engine AAH/AEJ/AFC	•		GWB1356	
	1994.06-1997.10	Saloon Engine AAH/AEJ/AFC		◦	GHA499047	
	1994.06-1997.10	Saloon Engine AAH/AEJ/AFC		◦	GWB0542	
2.8 (142 kW)	1995.12-1997.10	Saloon Engine ACK	•		GWB1356	



	 YEAR		F	R	G-AP Ref.	KIT
AUDI						
A6 (4A, C4)						
2.8 (142 kW)	1995.12-1997.10	Saloon Engine ACK		o	GHA499047	
	1995.12-1997.10	Saloon Engine ACK		o	GWB0542	
2.8 Quattro (128 kW)	1994.06-1997.10	Saloon Engine AAH	•		GWB1356	
2.8 Quattro (142 kW)	1995.12-1997.10	Saloon Engine ACK	•		GWB1356	
4.2 S6 Plus Quattro (240 kW)	1996.04-1997.10	Saloon Engine AHK	•		GWB1356	
4.2 S6 Quattro (213 kW)	1994.06-1997.10	Saloon Engine AEC	•		GWB1356	
A6 (4B2, C5)						
1.8 (85 kW)	1997.05-2005.01	Saloon Engine AFY	•		GHA245010	K
	1997.05-2005.01	Saloon Engine AFY	•		GHA433002	
	1997.05-2005.01	Saloon Engine AFY	•		GWB1355	
	1997.05-2005.01	Saloon Engine AFY	•		GWB1356	
	1997.05-2005.01	Saloon Engine AFY		o	GHA400003	
1.8 (92 kW)	1997.07-2005.01	Saloon Engine AJP/ANQ/AQE/ARH	•		GHA245010	K
	1997.07-2005.01	Saloon Engine AJP/ANQ/AQE/ARH	•		GHA433002	
	1997.07-2005.01	Saloon Engine AJP/ANQ/AQE/ARH	•		GWB1355	
	1997.07-2005.01	Saloon Engine AJP/ANQ/AQE/ARH	•		GWB1356	
	1997.07-2005.01	Saloon Engine AJP/ANQ/AQE/ARH		o	GHA400003	
1.8 T (110 kW)	1997.01-2005.01	Saloon Engine AEB/ANB/APU/ARK/AWL/AWT	•		GHA245010	K
	1997.01-2005.01	Saloon Engine AEB/ANB/APU/ARK/AWL/AWT	•		GHA433002	
	1997.01-2005.01	Saloon Engine AEB/ANB/APU/ARK/AWL/AWT	•		GWB1355	
	1997.01-2005.01	Saloon Engine AEB/ANB/APU/ARK/AWL/AWT	•		GWB1356	
	1997.01-2005.01	Saloon Engine AEB/ANB/APU/ARK/AWL/AWT		o	GHA400003	
1.8 T (132 kW)	1997.12-2005.01	Saloon Engine AJL	•		GHA245010	K
	1997.12-2005.01	Saloon Engine AJL	•		GWB1355	
	1997.12-2005.01	Saloon Engine AJL	•		GWB1356	
	1997.12-2005.01	Saloon Engine AJL		o	GHA400003	
1.8 T Quattro (110 kW)	1997.02-2005.01	Saloon Engine AEB/ANB/APU/ARK/AWT	•		GHA245010	K
	1997.02-2005.01	Saloon Engine AEB/ANB/APU/ARK/AWT	•		GHA433002	
	1997.02-2005.01	Saloon Engine AEB/ANB/APU/ARK/AWT	•		GWB1355	
	1997.02-2005.01	Saloon Engine AEB/ANB/APU/ARK/AWT	•		GWB1356	
	1997.02-2005.01	Saloon Engine AEB/ANB/APU/ARK/AWT		o	GWB3535	
1.8 T Quattro (132 kW)	1997.12-2005.01	Saloon Engine AJL	•		GHA245010	K
	1997.12-2005.01	Saloon Engine AJL	•		GWB1355	
	1997.12-2005.01	Saloon Engine AJL	•		GWB1356	
	1997.12-2005.01	Saloon Engine AJL		o	GWB3535	
1.9 TDi (81 kW)	1997.04-2000.10	Saloon Engine AFN/AVG	•		GWB1356	
	1997.04-2000.10	Saloon Engine AFN/AVG		o	GHA400003	
1.9 TDi (85 kW)	2000.07-2005.01	Saloon Engine AJM	•		GHA245010	K
	2000.07-2005.01	Saloon Engine AJM	•		GWB1356	
	2000.07-2005.01	Saloon Engine AJM		o	GHA400003	
1.9 TDi (96 kW)	2001.08-2005.01	Saloon Engine AVF/AWX	•		GHA245010	K
	2001.08-2005.01	Saloon Engine AVF/AWX	•		GWB1356	
	2001.08-2005.01	Saloon Engine AVF/AWX		o	GHA400003	
2.0 (96 kW)	2001.08-2005.01	Saloon Engine ALT	•		GHA245010	K
	2001.08-2005.01	Saloon Engine ALT	•		GWB1356	
	2001.08-2005.01	Saloon Engine ALT		o	GHA400003	
2.4 (100 kW)	1998.07-2005.01	Saloon Engine ALW/ARN/ASM	•		GHA245010	K
	1998.07-2005.01	Saloon Engine ALW/ARN/ASM	•		GWB1356	
	1998.07-2005.01	Saloon Engine ALW/ARN/ASM		o	GHA400003	
2.4 (115 kW)	1997.02-2005.01	Saloon Engine APC	•		GHA245010	K
	1997.02-2005.01	Saloon Engine APC	•		GWB1356	
	1997.02-2005.01	Saloon Engine APC		o	GHA400003	
2.4 (120 kW)	1997.02-2005.01	Saloon Engine AJG/AMM/APZ	•		GHA245010	K
	1997.02-2005.01	Saloon Engine AJG/AMM/APZ	•		GWB1356	
	1997.02-2005.01	Saloon Engine AJG/AMM/APZ		o	GHA400003	
2.4 (121 kW)	1997.02-2005.01	Saloon Engine AGA/ALF/AML/APS/ARJ	•		GHA245010	K
	1997.02-2005.01	Saloon Engine AGA/ALF/AML/APS/ARJ	•		GWB1356	
	1997.02-2005.01	Saloon Engine AGA/ALF/AML/APS/ARJ		o	GHA400003	
2.4 (125 kW)	2001.08-2005.01	Saloon Engine BDV	•		GHA245010	K
	2001.08-2005.01	Saloon Engine BDV	•		GWB1356	
	2001.08-2005.01	Saloon Engine BDV		o	GHA400003	
2.4 Quattro (115 kW)	1998.08-1999.07	Saloon Engine APC	•		GWB1356	
	1998.08-1999.07	Saloon Engine APC		o	GWB3535	
2.4 Quattro (120 kW)	1997.02-2005.01	Saloon Engine AJG/APZ	•		GHA245010	K



	 YEAR		F	R	G-AP Ref.	KIT
AUDI						
A6 (4B2, C5)						
2.4 Quattro (120 kW)	1997.02-2005.01	Saloon Engine AJG/APZ	•		GWB1356	
	1997.02-2005.01	Saloon Engine AJG/APZ		◦	GWB3535	
2.4 Quattro (121 kW)	1997.02-2005.01	Saloon Engine AGA/ALF/AML/APS/ARJ	•		GHA245010	K
	1997.02-2005.01	Saloon Engine AGA/ALF/AML/APS/ARJ	•		GWB1356	
	1997.02-2005.01	Saloon Engine AGA/ALF/AML/APS/ARJ		◦	GWB3535	
2.4 Quattro (125 kW)	2001.08-2005.01	Saloon Engine BDV	•		GHA245010	K
	2001.08-2005.01	Saloon Engine BDV	•		GWB1356	
2.5 TDi (110 kW)	1997.07-2005.01	Saloon Engine AFB/AKN	•		GHA245010	K
	1997.07-2005.01	Saloon Engine AFB/AKN	•		GWB1356	
	1997.07-2005.01	Saloon Engine AFB/AKN		◦	GHA400003	
2.5 TDi (114 kW)	2001.08-2005.01	Saloon Engine AYM	•		GHA245010	K
	2001.08-2005.01	Saloon Engine AYM	•		GWB1356	
	2001.08-2005.01	Saloon Engine AYM		◦	GHA400003	
2.5 TDi (120 kW)	2002.07-2004.05	Saloon Engine BCZ/BDG/BFC	•		GHA245010	K
	2002.07-2004.05	Saloon Engine BCZ/BDG/BFC		◦	GHA400003	
2.5 TDi (132 kW)	2000.02-2005.01	Saloon Engine AKE/BAU/BDH/BND	•		GHA245010	K
	2000.02-2005.01	Saloon Engine AKE/BAU/BDH/BND	•		GWB1356	
	2000.02-2005.01	Saloon Engine AKE/BAU/BDH/BND		◦	GHA400003	
2.5 TDi Quattro (110 kW)	1997.07-2005.01	Saloon Engine AFB/AKN	•		GHA245010	K
	1997.07-2005.01	Saloon Engine AFB/AKN	•		GWB1356	
	1997.07-2005.01	Saloon Engine AFB/AKN		◦	GWB3535	
2.5 TDi Quattro (132 kW)	2000.02-2005.01	Saloon Engine AKE/BAU/BDH	•		GHA245010	K
	2000.02-2005.01	Saloon Engine AKE/BAU/BDH	•		GWB1356	
	2000.02-2005.01	Saloon Engine AKE/BAU/BDH		◦	GWB3535	
2.7 (187 kW)	2001.05-2004.07	Saloon Engine APB BEL	•		GHA245010	K
	2001.05-2004.07	Saloon Engine APB BEL	•		GWB1356	
	2001.05-2004.07	Saloon Engine APB BEL		◦	GHA400003	
2.7 Quattro (187 kW)	2001.05-2004.07	Saloon Engine BEL/APB	•		GHA245010	K
	2001.05-2004.07	Saloon Engine BEL/APB	•		GWB1356	
	2001.05-2004.07	Saloon Engine BEL/APB		◦	GWB3535	
2.7 Quattro (195 kW)	2003.11-2004.07	Saloon Engine BEL	•		GHA245010	K
	2003.11-2004.07	Saloon Engine BEL		◦	GWB1356	
2.7 T (169 kW)	1999.02-2005.01	Saloon Engine AJK	•		GHA245010	K
	1999.02-2005.01	Saloon Engine AJK	•		GWB1356	
	1999.02-2005.01	Saloon Engine AJK		◦	GHA400003	
2.7 T Quattro (169 kW)	1997.12-2005.01	Saloon Engine AJK	•		GHA245010	K
	1997.12-2005.01	Saloon Engine AJK	•		GWB1356	
	1997.12-2005.01	Saloon Engine AJK		◦	GWB3535	
2.7 T Quattro (184 kW)	2001.08-2005.01	Saloon Engine ARE/BES	•		GHA245010	K
	2001.08-2005.01	Saloon Engine ARE/BES	•		GWB1356	
2.8 (132 kW)	1997.10-2000.05	Saloon Engine AGE	•		GWB1356	
	1997.10-2000.05	Saloon Engine AGE		◦	GHA400003	
2.8 (140 kW)	1999.07-2005.01	Saloon Engine ATX	•		GHA245010	K
	1999.07-2005.01	Saloon Engine ATX	•		GWB1356	
	1999.07-2005.01	Saloon Engine ATX		◦	GHA400003	
2.8 (142 kW)	1997.02-2005.01	Saloon Engine ACK/AHA/ALG/AMX/APR/AQD	•		GHA245010	K
	1997.02-2005.01	Saloon Engine ACK/AHA/ALG/AMX/APR/AQD	•		GWB1356	
	1997.02-2005.01	Saloon Engine ACK/AHA/ALG/AMX/APR/AQD		◦	GHA400003	
2.8 Quattro (132 kW)	1998.01-2000.04	Saloon Engine AGE	•		GWB1356	
	1998.01-2000.04	Saloon Engine AGE		◦	GWB3535	
2.8 Quattro (140 kW)	1999.07-2001.05	Saloon Engine ATX	•		GWB1356	
	1999.07-2001.05	Saloon Engine ATX		◦	GWB3535	
2.8 Quattro (142 kW)	1997.02-2005.01	Saloon Engine ACK/AHA/ALG/AMX/APR/AQD	•		GHA245010	K
	1997.02-2005.01	Saloon Engine ACK/AHA/ALG/AMX/APR/AQD	•		GWB1356	
	1997.02-2005.01	Saloon Engine ACK/AHA/ALG/AMX/APR/AQD		◦	GWB3535	
3.0 (162 kW)	2001.08-2005.01	Saloon Engine ASN	•		GHA245010	K
	2001.08-2005.01	Saloon Engine ASN	•		GWB1356	
	2001.08-2005.01	Saloon Engine ASN		◦	GHA400003	
3.0 Quattro (160 kW)	2001.06-2004.07	Saloon Engine BBJ	•		GHA245010	K
	2001.06-2004.07	Saloon Engine BBJ	•		GWB1356	
3.0 Quattro (162 kW)	2001.08-2005.01	Saloon Engine ASN	•		GHA245010	K
	2001.08-2005.01	Saloon Engine ASN	•		GWB1356	
4.2 Quattro (220 kW)	1998.11-2005.01	Saloon Engine ASG/ARS	•		GHA245010	K
4.2 RS6 Quattro (331 kW)	2002.07-2005.01	Saloon Engine BCY	•		GHA245010	K



	 YEAR		F	R	G-AP Ref.	KIT
AUDI						
A6 (4B2, C5)						
4.2 RS6 Quattro (331 kW)	2002.07-2005.01	Saloon Engine BCY		o	GWB1356	
4.2 S6 Quattro (250 kW)	1999.09-2005.01	Saloon Engine ANK/AQJ	•		GHA245010	K
A6 (4F2, C6)						
2.0 TDi (100 kW)	2006.01-2007.11	Saloon Engine BNA/BRF/CAGB	•		GHA245007	K
	2006.01-2007.11	Saloon Engine BNA/BRF/CAGB		o	GHA400196	K
2.0 TDi (103 kW)	2004.06-2007.11	Saloon Engine BLB/BRE	•		GHA245007	K
	2004.06-2007.11	Saloon Engine BLB/BRE		o	GHA400196	K
2.0 TDi (120 kW)	2009.04-2011.03	Saloon Engine CAHB	•		GHA245007	K
	2009.04-2011.03	Saloon Engine CAHB		o	GHA400196	K
2.0 TDi (125 kW)	2008.11-2011.03	Saloon Engine CAHA	•		GHA245007	K
	2008.11-2011.03	Saloon Engine CAHA		o	GHA400196	K
2.0 TDi (89 kW)	2005.09-2006.06	Saloon Engine BVG	•		GHA245007	K
	2005.09-2006.06	Saloon Engine BVG		o	GHA400196	K
2.0 TFSi (125 kW)	2005.06-2007.11	Saloon Engine BPJ	•		GHA245007	K
	2005.06-2007.11	Saloon Engine BPJ		o	GHA400196	K
2.4 (130 kW)	2004.05-2008.10	Saloon Engine BDW	•		GHA245007	K
	2004.05-2008.10	Saloon Engine BDW		o	GHA400196	K
2.4 Quattro (130 kW)	2005.01-2008.10	Saloon Engine BDW	•		GHA245007	K
	2005.01-2008.10	Saloon Engine BDW		o	GHA247001	K
2.7 TDi (120 kW)	2004.11-2011.03	Saloon Engine BSG/CANB	•		GHA247001	K
	2004.11-2011.03	Saloon Engine BSG/CANB		o	GHA400196	K
2.7 TDi (132 kW)	2004.10-2007.11	Saloon Engine BPP	•		GHA247001	K
	2004.10-2007.11	Saloon Engine BPP		o	GHA400196	K
2.7 TDi (140 kW)	2008.10-2011.03	Saloon Engine CANA	•		GHA247001	K
	2008.10-2011.03	Saloon Engine CANA		o	GHA400196	K
2.7 TDi Quattro (120 kW)	2005.06-2011.03	Saloon Engine BSG/CAND	•		GHA247001	K
2.7 TDi Quattro (132 kW)	2004.11-2008.10	Saloon Engine BPP	•		GHA247001	K
2.7 TDi Quattro (140 kW)	2008.10-2011.03	Saloon Engine CANC	•		GHA247001	K
2.8 FSi (140 kW)	2008.10-2011.03	Saloon Engine CCDA	•		GHA245007	K
	2008.10-2011.03	Saloon Engine CCDA		o	GHA400196	K
2.8 FSi (154 kW)	2006.11-2008.10	Saloon Engine BDX	•		GHA245007	K
	2006.11-2008.10	Saloon Engine BDX		o	GHA400196	K
2.8 FSi (162 kW)	2008.10-2011.03	Saloon Engine CCEA	•		GHA245007	K
	2008.10-2011.03	Saloon Engine CCEA		o	GHA400196	K
2.8 FSi Quattro (140 kW)	2008.10-2011.03	Saloon Engine CCDA	•		GHA245007	K
	2008.10-2011.03	Saloon Engine CCDA		o	GHA247001	K
2.8 FSi Quattro (154 kW)	2007.06-2008.10	Saloon Engine BDX	•		GHA245007	K
	2007.06-2008.10	Saloon Engine BDX		o	GHA247001	K
2.8 FSi Quattro (162 kW)	2008.10-2011.03	Saloon Engine CCEA	•		GHA245007	K
	2008.10-2011.03	Saloon Engine CCEA		o	GHA247001	K
3.0 (160 kW)	2004.08-2006.05	Saloon Engine BBJ	•		GHA245007	K
	2004.08-2006.05	Saloon Engine BBJ		o	GHA400196	K
3.0 Quattro (160 kW)	2004.05-2006.05	Saloon Engine BBJ	•		GHA245007	K
	2004.05-2006.05	Saloon Engine BBJ		o	GHA247001	K
3.0 TDi Quattro (155 kW)	2004.05-2011.03	Saloon Engine BNG/CDYB	•		GHA247001	K
3.0 TDi Quattro (165 kW)	2004.05-2006.05	Saloon Engine BMK	•		GHA247001	K
3.0 TDi Quattro (171 kW)	2006.05-2007.11	Saloon Engine ASB	•		GHA247001	K
3.0 TDi Quattro (176 kW)	2008.10-2011.03	Saloon Engine CDYA/CDYC	•		GHA247001	K
3.0 TFSi Quattro (213 kW)	2008.10-2011.03	Saloon Engine CAJA	•		GHA247001	K
3.0 TFSi Quattro (220 kW)	2008.10-2011.03	Saloon Engine CCAA	•		GHA247001	K
3.2 FSi (188 kW)	2004.05-2009.05	Saloon Engine AUK/BKH	•		GHA245007	K
	2004.05-2009.05	Saloon Engine AUK/BKH		o	GHA400196	K
3.2 FSi (195 kW)	2009.05-2011.03	Saloon Engine CALA	•		GHA245007	K
	2009.05-2011.03	Saloon Engine CALA		o	GHA400196	K
3.2 FSi Quattro (183 kW)	2006.09-2008.10	Saloon Engine BYU	•		GHA245007	K
	2006.09-2008.10	Saloon Engine BYU		o	GHA247001	K
3.2 FSi Quattro (188 kW)	2004.05-2008.10	Saloon Engine AUK	•		GHA245007	K
	2004.05-2008.10	Saloon Engine AUK		o	GHA247001	K
4.2 FSi Quattro (257 kW)	2006.05-2007.11	Saloon Engine BVJ	•		GHA247001	K
4.2 Quattro (246 kW)	2004.07-2006.10	Saloon Engine BAT	•		GHA247001	K
5.0 RS6 Quattro (426 kW)	2008.09-2010.08	Saloon Engine BUH	•		GHA247001	K
5.2 S6 Quattro (320 kW)	2006.03-2007.11	Saloon Engine BXA	•		GHA247001	K
A6 (4G2, C7)						
2.0 TDi (120 kW)	2011.03-	Saloon Engine CGLD	•		GHA262001	K



	 YEAR		F	R	G-AP Ref.	KIT
AUDI						
A6 (4G2, C7)						
2.0 TDi (120 kW)	2011.03-	Saloon Engine CGLD		o	GHA232026	K
	2011.03-	Saloon Engine CGLD		o	GHA232036	K
2.0 TDi (130 kW)	2011.03-	Saloon Engine CGLC/CMGB	•		GHA262001	K
	2011.03-	Saloon Engine CGLC/CMGB		o	GHA232026	K
	2011.03-	Saloon Engine CGLC/CMGB		o	GHA232036	K
2.0 TFSi (132 kW)	2011.05-	Saloon Engine CDNB	•		GHA262001	K
	2011.05-	Saloon Engine CDNB		o	GHA232026	K
	2011.05-	Saloon Engine CDNB		o	GHA232036	K
2.0 TFSi (155 kW)	2011.03-2013.05	Saloon Engine CAEB	•		GHA262001	K
	2011.03-2013.05	Saloon Engine CAEB		o	GHA232026	K
	2011.03-2013.05	Saloon Engine CAEB		o	GHA232036	K
2.0 TFSi (162 kW)	2013.05-	Saloon Engine CAED	•		GHA262001	K
	2013.05-	Saloon Engine CAED		o	GHA232026	K
	2013.05-	Saloon Engine CAED		o	GHA232036	K
2.0 TFSi HybriD (155 kW)	2011.11-	Saloon Engine CHJA	•		GHA262001	K
	2011.11-	Saloon Engine CHJA		o	GHA232026	K
	2011.11-	Saloon Engine CHJA		o	GHA232036	K
2.8 FSi (150 kW)	2011.03-	Saloon Engine CHVA	•		GHA262001	K
	2011.03-	Saloon Engine CHVA		o	GHA232026	K
	2011.03-	Saloon Engine CHVA		o	GHA232036	K
2.8 FSi Quattro (150 kW)	2011.03-	Saloon Engine CHVA	•		GHA262001	K
3.0 TDi (150 kW)	2010.11-	Saloon Engine CLAB	•		GHA262001	K
	2010.11-	Saloon Engine CLAB		o	GHA232026	K
	2010.11-	Saloon Engine CLAB		o	GHA232036	K
3.0 TDi Quattro (150 kW)	2011.03-	Saloon Engine CLAA	•		GHA262001	K
3.0 TDi Quattro (180 kW)	2011.03-	Saloon Engine CDUC/CDUD/CKVB/CKVC	•		GHA262001	K
3.0 TDi Quattro (230 kW)	2011.11-	Saloon Engine CGQB	•		GHA262001	K
3.0 TFSi Quattro (220 kW)	2010.11-2012.05	Saloon Engine CGWB	•		GHA262001	K
3.0 TFSi Quattro (228 kW)	2011.03-	Saloon Engine CGWD/CGXB/CTUA	•		GHA262001	K
4.0 S6 Quattro (309 kW)	2012.02-	Saloon Engine CEUC	•		GHA262001	K
A6 (4G2, C7, 4GC)						
1.8 TFSi (140 kW)	2014.09-	Saloon Engine CYGA	•		GHA262001	K
	2014.09-	Saloon Engine CYGA		o	GHA232026	K
	2014.09-	Saloon Engine CYGA		o	GHA232036	K
2.0 TDi (100 kW)	2012.01-	Saloon Engine CGLE/CSUE	•		GHA262001	K
	2012.01-	Saloon Engine CGLE/CSUE		o	GHA232026	K
	2012.01-	Saloon Engine CGLE/CSUE		o	GHA232036	K
2.0 TDi (110 kW)	2014.09-	Saloon Engine CSUD	•		GHA262001	K
	2014.09-	Saloon Engine CSUD		o	GHA232026	K
	2014.09-	Saloon Engine CSUD		o	GHA232036	K
2.0 TDi (140 kW)	2013.11-	Saloon Engine CNHA	•		GHA262001	K
	2013.11-	Saloon Engine CNHA		o	GHA232026	K
	2013.11-	Saloon Engine CNHA		o	GHA232036	K
2.0 TDi Quattro (140 kW)	2015.04-	Saloon Engine CNHA	•		GHA262001	K
2.0 TFSi (185 kW)	2014.09-	Saloon Engine CYNB/CYPA	•		GHA262001	K
	2014.09-	Saloon Engine CYNB/CYPA		o	GHA232026	K
	2014.09-	Saloon Engine CYNB/CYPA		o	GHA232036	K
2.0 TFSi Quattro (155 kW)	2012.05-2013.05	Saloon Engine CAEB	•		GHA262001	K
2.0 TFSi Quattro (162 kW)	2013.05-	Saloon Engine CAED	•		GHA262001	K
2.0 TFSi Quattro (183 kW)	2015.05-	Saloon Engine CYPB	•		GHA262001	K
2.0 TFSi Quattro (185 kW)	2014.05-	Saloon Engine CYNB/CYPA	•		GHA262001	K
3.0 TDi (155 kW)	2014.09-	Saloon Engine CTCB	•		GHA262001	K
	2014.09-	Saloon Engine CTCB		o	GHA232026	K
	2014.09-	Saloon Engine CTCB		o	GHA232036	K
3.0 TDi (160 kW)	2014.09-	Saloon Engine CTCC	•		GHA262001	K
	2014.09-	Saloon Engine CTCC		o	GHA232026	K
	2014.09-	Saloon Engine CTCC		o	GHA232036	K
3.0 TDi Quattro (155 kW)	2014.09-	Saloon Engine CRTF	•		GHA262001	K
3.0 TDi Quattro (160 kW)	2014.09-	Saloon Engine CRTE	•		GHA262001	K
3.0 TDi Quattro (176 kW)	2013.05-	Saloon Engine CPNB	•		GHA262001	K
3.0 TDi Quattro (200 kW)	2014.09-	Saloon Engine CRTD	•		GHA262001	K
3.0 TDi Quattro (235 kW)	2014.09-	Saloon Engine CVUA	•		GHA262001	K
3.0 TDi Quattro (240 kW)	2014.09-	Saloon Engine CVUB	•		GHA262001	K
3.0 TFSi Quattro (245 kW)	2014.09-	Saloon Engine CREC	•		GHA262001	K



	 YEAR		F	R	G-AP Ref.	KIT
AUDI						
A6 ALLROAD (4FH, C6)						
2.7 TDi Quattro (120 kW)	2006.05-2011.08	Estate Engine BSG/CAND	•		GHA247001	K
2.7 TDi Quattro (132 kW)	2006.05-2008.10	Estate Engine BPP	•		GHA247001	K
2.7 TDi Quattro (140 kW)	2008.10-2011.08	Estate Engine CANC	•		GHA247001	K
3.0 TDi Quattro (155 kW)	2006.05-2011.08	Estate Engine BNG/CDYB	•		GHA247001	K
3.0 TDi Quattro (171 kW)	2006.05-2008.10	Estate Engine ASB	•		GHA247001	K
3.0 TDi Quattro (176 kW)	2008.10-2011.08	Estate Engine CDYA/CDYC	•		GHA247001	K
3.0 TFSi Quattro (213 kW)	2008.10-2011.08	Estate Engine CAJA	•		GHA245007	K
	2008.10-2011.08	Estate Engine CAJA		o	GHA247001	K
3.2 FSi Quattro (188 kW)	2006.12-2007.11	Estate Engine AUK	•		GHA245007	K
	2006.12-2007.11	Estate Engine AUK		o	GHA247001	K
4.2 FSi Quattro (257 kW)	2006.12-2007.11	Estate Engine BVJ	•		GHA247001	K
A6 ALLROAD (4GH)						
3.0 TDi Quattro (150 kW)	2012.01-	Estate Engine CLAA	•		GHA262001	K
3.0 TDi Quattro (180 kW)	2012.01-	Estate Engine CDUD/CKVC	•		GHA262001	K
3.0 TDi Quattro (230 kW)	2012.01-	Estate Engine CGQB	•		GHA262001	K
3.0 TFSi Quattro (228 kW)	2012.01-	Estate Engine CGWD	•		GHA262001	K
A6 ALLROAD (4GH, 4GJ)						
3.0 TDi Quattro (155 kW)	2014.09-	Estate Engine CRTF	•		GHA262001	K
3.0 TDi Quattro (160 kW)	2014.09-	Estate Engine CRTE	•		GHA262001	K
3.0 TDi Quattro (200 kW)	2014.09-	Estate Engine CRTD	•		GHA262001	K
3.0 TDi Quattro (235 kW)	2012.01-	Estate Engine CVUA	•		GHA262001	K
A6 AVANT (4A, C4)						
1.8 (92 kW)	1995.12-1997.12	Estate Engine ADR	•		GWB1356	
	1995.12-1997.12	Estate Engine ADR		o	GHA400003	
	1995.12-1997.12	Estate Engine ADR		o	GHA499047	
	1995.12-1997.12	Estate Engine ADR		o	GWB0542	
1.8 Quattro (92 kW)	1995.12-1997.12	Estate Engine ADR	•		GWB1356	
1.9 TDi (66 kW)	1994.06-1997.12	Estate Engine 1Z/AHU	•		GWB1356	
	1994.06-1997.12	Estate Engine 1Z/AHU		o	GHA400003	
	1994.06-1997.12	Estate Engine 1Z/AHU		o	GHA499047	
	1994.06-1997.12	Estate Engine 1Z/AHU		o	GWB0542	
2.0 (74 kW)	1994.06-1997.12	Estate Engine AAE	•		GWB1356	
	1994.06-1997.12	Estate Engine AAE		o	GHA400003	
	1994.06-1997.12	Estate Engine AAE		o	GHA499047	
	1994.06-1997.12	Estate Engine AAE		o	GWB0542	
2.0 (85 kW)	1994.06-1997.12	Estate Engine ABK	•		GWB1356	
	1994.06-1997.12	Estate Engine ABK		o	GHA400003	
	1994.06-1997.12	Estate Engine ABK		o	GHA499047	
	1994.06-1997.12	Estate Engine ABK		o	GWB0542	
2.0 16V (103 kW)	1994.06-1997.12	Estate Engine ACE	•		GWB1356	
	1994.06-1997.12	Estate Engine ACE		o	GHA400003	
	1994.06-1997.12	Estate Engine ACE		o	GHA499047	
	1994.06-1997.12	Estate Engine ACE		o	GWB0542	
2.0 16V Quattro (103 kW)	1994.06-1997.12	Estate Engine ACE	•		GWB1356	
2.2 S6 Turbo Quattro (169 kW)	1994.06-1997.12	Estate Engine AAN	•		GWB1356	
2.3 (98 kW)	1994.06-1995.12	Estate Engine AAR	•		GWB1356	
	1994.06-1995.12	Estate Engine AAR		o	GHA499047	
	1994.06-1995.12	Estate Engine AAR		o	GWB0542	
2.3 Quattro (98 kW)	1994.06-1995.12	Estate Engine AAR	•		GWB1356	
2.4 (110 kW)	1996.07-1997.12	Estate Engine AFM	•		GWB1356	
	1996.07-1997.12	Estate Engine AFM		o	GHA400003	
	1996.07-1997.12	Estate Engine AFM		o	GWB0542	
2.5 TDi (103 kW)	1994.08-1997.12	Estate Engine AEL	•		GWB1356	
	1994.08-1997.12	Estate Engine AEL		o	GHA400003	
	1994.08-1997.12	Estate Engine AEL		o	GHA499047	
	1994.08-1997.12	Estate Engine AEL		o	GWB0542	
2.5 TDi (84 kW)	1995.01-1997.12	Estate Engine AAT	•		GWB1356	
	1995.01-1997.12	Estate Engine AAT		o	GHA400003	
	1995.01-1997.12	Estate Engine AAT		o	GWB0542	
2.5 TDi (85 kW)	1994.06-1997.12	Estate Engine AAT	•		GWB1356	
	1994.06-1997.12	Estate Engine AAT		o	GHA400003	
	1994.06-1997.12	Estate Engine AAT		o	GHA499047	
	1994.06-1997.12	Estate Engine AAT		o	GWB0542	
2.5 TDi Quattro (103 kW)	1995.07-1997.12	Estate Engine AEL	•		GWB1356	



	 YEAR		F	R	G-AP Ref.	KIT
AUDI						
A6 AVANT (4A, C4)						
2.6 (102 kW)	1994.06-1997.02	Estate Engine ACZ	•		GWB1356	
	1994.06-1997.02	Estate Engine ACZ		○	GWB0542	
2.6 (110 kW)	1994.06-1997.12	Estate Engine ABC	•		GWB1356	
	1994.06-1997.12	Estate Engine ABC		○	GHA400003	
	1994.06-1997.12	Estate Engine ABC		○	GHA499047	
	1994.06-1997.12	Estate Engine ABC		○	GWB0542	
2.6 Quattro (110 kW)	1994.06-1997.12	Estate Engine ABC	•		GWB1356	
2.8 (128 kW)	1994.06-1997.12	Estate Engine AAH	•		GWB1356	
	1994.06-1997.12	Estate Engine AAH		○	GHA400003	
	1994.06-1997.12	Estate Engine AAH		○	GHA499047	
	1994.06-1997.12	Estate Engine AAH		○	GWB0542	
2.8 (142 kW)	1995.12-1997.12	Estate Engine ACK	•		GWB1356	
	1995.12-1997.12	Estate Engine ACK		○	GHA400003	
	1995.12-1997.12	Estate Engine ACK		○	GHA499047	
	1995.12-1997.12	Estate Engine ACK		○	GWB0542	
2.8 Quattro (128 kW)	1994.06-1997.12	Estate Engine AEJ/AAH	•		GWB1356	
2.8 Quattro (142 kW)	1995.12-1997.12	Estate Engine ACK	•		GWB1356	
4.2 S6 Plus Quattro (240 kW)	1996.04-1997.12	Estate Engine AHK	•		GWB1356	
4.2 S6 Quattro (213 kW)	1994.06-1997.12	Estate Engine AEC	•		GWB1356	
A6 AVANT (4B5, C5)						
1.8 (85 kW)	1998.02-2005.01	Estate Engine AFY	•		GHA245010	K
	1998.02-2005.01	Estate Engine AFY	•		GHA433002	
	1998.02-2005.01	Estate Engine AFY	•		GWB1355	
	1998.02-2005.01	Estate Engine AFY	•		GWB1356	
	1998.02-2005.01	Estate Engine AFY		○	GHA400003	
1.8 (92 kW)	1997.12-2005.01	Estate Engine AJP/AQE/ARH	•		GHA245010	K
	1997.12-2005.01	Estate Engine AJP/AQE/ARH	•		GHA433002	
	1997.12-2005.01	Estate Engine AJP/AQE/ARH	•		GWB1355	
	1997.12-2005.01	Estate Engine AJP/AQE/ARH	•		GWB1356	
	1997.12-2005.01	Estate Engine AJP/AQE/ARH		○	GHA400003	
1.8 T (110 kW)	1997.12-2005.01	Estate Engine AEB/ANB/APU/ARK/AWT	•		GHA245010	K
	1997.12-2005.01	Estate Engine AEB/ANB/APU/ARK/AWT	•		GHA433002	
	1997.12-2005.01	Estate Engine AEB/ANB/APU/ARK/AWT	•		GWB1355	
	1997.12-2005.01	Estate Engine AEB/ANB/APU/ARK/AWT	•		GWB1356	
	1997.12-2005.01	Estate Engine AEB/ANB/APU/ARK/AWT		○	GHA400003	
1.8 T (132 kW)	1999.04-2005.01	Estate Engine AJL	•		GHA245010	K
	1999.04-2005.01	Estate Engine AJL	•		GWB1356	
	1999.04-2005.01	Estate Engine AJL		○	GHA400003	
1.8 T Quattro (110 kW)	1997.12-2005.01	Estate Engine AEB/ANB/APU/ARK/AWT	•		GHA245010	K
	1997.12-2005.01	Estate Engine AEB/ANB/APU/ARK/AWT	•		GHA433002	
	1997.12-2005.01	Estate Engine AEB/ANB/APU/ARK/AWT	•		GWB1355	
	1997.12-2005.01	Estate Engine AEB/ANB/APU/ARK/AWT	•		GWB1356	
1.8 T Quattro (132 kW)	1997.12-2005.01	Estate Engine AJL	•		GHA245010	K
	1997.12-2005.01	Estate Engine AJL	•		GWB1356	
1.9 TDi (81 kW)	1998.02-2001.04	Estate Engine AFN	•		GWB1356	
	1998.02-2001.04	Estate Engine AFN		○	GHA400003	
1.9 TDi (85 kW)	2000.07-2005.01	Estate Engine AJM	•		GHA245010	K
	2000.07-2005.01	Estate Engine AJM	•		GWB1356	
	2000.07-2005.01	Estate Engine AJM		○	GHA400003	
1.9 TDi (96 kW)	2001.08-2005.01	Estate Engine AVF/AWX	•		GHA245010	K
	2001.08-2005.01	Estate Engine AVF/AWX	•		GWB1356	
	2001.08-2005.01	Estate Engine AVF/AWX		○	GHA400003	
2.0 (96 kW)	2001.08-2005.01	Estate Engine ALT	•		GHA245010	K
	2001.08-2005.01	Estate Engine ALT	•		GWB1356	
	2001.08-2005.01	Estate Engine ALT		○	GHA400003	
2.4 (100 kW)	1998.07-2005.01	Estate Engine ALW/ARN/ASM	•		GHA245010	K
	1998.07-2005.01	Estate Engine ALW/ARN/ASM	•		GWB1356	
	1998.07-2005.01	Estate Engine ALW/ARN/ASM		○	GHA400003	
2.4 (115 kW)	1997.12-2005.01	Estate Engine APC	•		GHA245010	K
	1997.12-2005.01	Estate Engine APC	•		GWB1356	
	1997.12-2005.01	Estate Engine APC		○	GHA400003	
2.4 (120 kW)	1997.12-2005.01	Estate Engine AJG/AMM/APZ	•		GHA245010	K
	1997.12-2005.01	Estate Engine AJG/AMM/APZ	•		GWB1356	
	1997.12-2005.01	Estate Engine AJG/AMM/APZ		○	GHA400003	



	 YEAR		F	R	G-AP Ref.	KIT
AUDI						
A6 AVANT (4B5, C5)						
2.4 (121 kW)	1997.12-2005.01	Estate Engine AGA/ALF/AML/APS/ARJ	•		GHA245010	K
	1997.12-2005.01	Estate Engine AGA/ALF/AML/APS/ARJ	•		GWB1356	
	1997.12-2005.01	Estate Engine AGA/ALF/AML/APS/ARJ		○	GHA400003	
2.4 (125 kW)	2001.08-2005.01	Estate Engine BDV	•		GHA245010	K
	2001.08-2005.01	Estate Engine BDV	•		GWB1356	
	2001.08-2005.01	Estate Engine BDV		○	GHA400003	
2.4 Quattro (115 kW)	1998.08-2001.05	Estate Engine APC	•		GWB1356	
2.4 Quattro (120 kW)	1997.12-2005.01	Estate Engine AJG/APZ	•		GHA245010	K
	1997.12-2005.01	Estate Engine AJG/APZ	•		GWB1356	
2.4 Quattro (121 kW)	1997.12-2005.01	Estate Engine AGA/ALF/AML/APS/ARJ	•		GHA245010	K
	1997.12-2005.01	Estate Engine AGA/ALF/AML/APS/ARJ	•		GWB1356	
2.4 Quattro (125 kW)	2001.08-2005.01	Estate Engine BDV	•		GHA245010	K
	2001.08-2005.01	Estate Engine BDV	•		GWB1356	
2.5 TDi (110 kW)	1997.12-2005.01	Estate Engine AFB/AKN	•		GHA245010	K
	1997.12-2005.01	Estate Engine AFB/AKN	•		GWB1356	
	1997.12-2005.01	Estate Engine AFB/AKN		○	GHA400003	
2.5 TDi (114 kW)	2001.08-2005.01	Estate Engine AYM	•		GHA245010	K
	2001.08-2005.01	Estate Engine AYM	•		GWB1356	
	2001.08-2005.01	Estate Engine AYM		○	GHA400003	
2.5 TDi (120 kW)	2002.07-2005.01	Estate Engine BCZ/BDG/BFC	•		GHA245010	K
	2002.07-2005.01	Estate Engine BCZ/BDG/BFC		○	GHA400003	
2.5 TDi (132 kW)	2000.02-2005.01	Estate Engine AKE/BAU/BDH	•		GHA245010	K
	2000.02-2005.01	Estate Engine AKE/BAU/BDH	•		GWB1356	
	2000.02-2005.01	Estate Engine AKE/BAU/BDH		○	GHA400003	
2.5 TDi Quattro (110 kW)	1997.12-2005.01	Estate Engine AFB/AKN	•		GHA245010	K
	1997.12-2005.01	Estate Engine AFB/AKN	•		GWB1356	
2.5 TDi Quattro (132 kW)	2000.02-2005.01	Estate Engine AKE/BAU/BDH	•		GHA245010	K
	2000.02-2005.01	Estate Engine AKE/BAU/BDH	•		GWB1356	
2.7 T (169 kW)	1999.02-2005.01	Estate Engine AJK	•		GHA245010	K
	1999.02-2005.01	Estate Engine AJK	•		GWB1356	
	1999.02-2005.01	Estate Engine AJK		○	GHA400003	
2.7 T Quattro (169 kW)	1997.12-2005.01	Estate Engine AJK/AZA	•		GHA245010	K
	1997.12-2005.01	Estate Engine AJK/AZA	•		GWB1356	
2.7 T Quattro (184 kW)	2001.08-2005.01	Estate Engine ARE/BES	•		GHA245010	K
	2001.08-2005.01	Estate Engine ARE/BES	•		GWB1356	
2.8 (132 kW)	1997.12-2000.05	Estate Engine AGE	•		GWB1356	
	1997.12-2000.05	Estate Engine AGE		○	GHA400003	
2.8 (140 kW)	1999.07-2005.01	Estate Engine ATX	•		GHA245010	K
	1999.07-2005.01	Estate Engine ATX	•		GWB1356	
	1999.07-2005.01	Estate Engine ATX		○	GHA400003	
2.8 (142 kW)	1997.12-2005.01	Estate Engine ACK/AHA/ALG/AMX/APR/AQD	•		GHA245010	K
	1997.12-2005.01	Estate Engine ACK/AHA/ALG/AMX/APR/AQD	•		GWB1356	
	1997.12-2005.01	Estate Engine ACK/AHA/ALG/AMX/APR/AQD		○	GHA400003	
2.8 Quattro (142 kW)	1997.12-2005.01	Estate Engine ACK/AHA/ALG/AMX/APR/AQD	•		GHA245010	K
	1997.12-2005.01	Estate Engine ACK/AHA/ALG/AMX/APR/AQD	•		GWB1356	
3.0 (162 kW)	2001.08-2005.01	Estate Engine ASN	•		GHA245010	K
	2001.08-2005.01	Estate Engine ASN	•		GWB1356	
	2001.08-2005.01	Estate Engine ASN		○	GHA400003	
3.0 Quattro (162 kW)	2001.08-2005.01	Estate Engine ASN	•		GHA245010	K
	2001.08-2005.01	Estate Engine ASN	•		GWB1356	
4.2 Quattro (220 kW)	1998.11-2005.01	Estate Engine ARS/ASG/AWN	•		GHA245010	K
4.2 RS6 plus Quattro (353 kW)	2004.04-2005.01	Estate Engine BRV	•		GHA245010	K
	2004.04-2005.01	Estate Engine BRV		○	GWB1356	
4.2 RS6 Quattro (331 kW)	2002.07-2005.01	Estate Engine BCY	•		GHA245010	K
	2002.07-2005.01	Estate Engine BCY		○	GWB1356	
4.2 S6 Quattro (250 kW)	1999.09-2005.01	Estate Engine ANK/AQJ	•		GHA245010	K
A6 AVANT (4F5, C6)						
2.0 TDi (100 kW)	2005.06-2011.08	Estate Engine BNA/BRF/CAGB	•		GHA245007	K
	2005.06-2011.08	Estate Engine BNA/BRF/CAGB		○	GHA400196	K
2.0 TDi (103 kW)	2005.06-2007.11	Estate Engine BLB/BRE	•		GHA245007	K
	2005.06-2007.11	Estate Engine BLB/BRE		○	GHA400196	K
2.0 TDi (120 kW)	2009.04-2011.08	Estate Engine CAHB	•		GHA245007	K
	2009.04-2011.08	Estate Engine CAHB		○	GHA400196	K
2.0 TDi (125 kW)	2008.10-2011.08	Estate Engine CAHA	•		GHA245007	K



	 YEAR		F	R	G-AP Ref.	KIT
AUDI						
A6 AVANT (4F5, C6)						
2.0 TDi (125 kW)	2008.10-2011.08	Estate Engine CAHA		o	GHA400196	K
2.0 TDi (89 kW)	2005.09-2006.06	Estate Engine BVG	•		GHA245007	K
	2005.09-2006.06	Estate Engine BVG		o	GHA400196	K
2.0 TFSi (125 kW)	2005.06-2007.11	Estate Engine BPJ	•		GHA245007	K
	2005.06-2007.11	Estate Engine BPJ		o	GHA400196	K
2.4 (130 kW)	2005.03-2008.10	Estate Engine BDW	•		GHA245007	K
	2005.03-2008.10	Estate Engine BDW		o	GHA400196	K
2.4 Quattro (130 kW)	2005.03-2008.10	Estate Engine BDW	•		GHA245007	K
	2005.03-2008.10	Estate Engine BDW		o	GHA247001	K
2.7 TDi (120 kW)	2005.03-2011.08	Estate Engine BSG/CANB	•		GHA247001	K
	2005.03-2011.08	Estate Engine BSG/CANB		o	GHA400196	K
2.7 TDi (132 kW)	2005.03-2008.10	Estate Engine BPP	•		GHA247001	K
	2005.03-2008.10	Estate Engine BPP		o	GHA400196	K
2.7 TDi (140 kW)	2008.10-2011.08	Estate Engine CANA	•		GHA247001	K
	2008.10-2011.08	Estate Engine CANA		o	GHA400196	K
2.7 TDi Quattro (120 kW)	2005.06-2011.08	Estate Engine BSG/CAND	•		GHA247001	K
2.7 TDi Quattro (132 kW)	2005.03-2008.10	Estate Engine BPP	•		GHA247001	K
2.7 TDi Quattro (140 kW)	2008.10-2011.08	Estate Engine CANC	•		GHA247001	K
2.8 FSi (140 kW)	2008.10-2011.08	Estate Engine CCDA	•		GHA245007	K
	2008.10-2011.08	Estate Engine CCDA		o	GHA400196	K
2.8 FSi (154 kW)	2006.11-2008.10	Estate Engine BDx	•		GHA245007	K
	2006.11-2008.10	Estate Engine BDx		o	GHA400196	K
2.8 FSi (162 kW)	2008.10-2011.08	Estate Engine CCEA	•		GHA245007	K
	2008.10-2011.08	Estate Engine CCEA		o	GHA400196	K
2.8 FSi Quattro (140 kW)	2008.10-2011.08	Estate Engine CCDA	•		GHA245007	K
	2008.10-2011.08	Estate Engine CCDA		o	GHA247001	K
2.8 FSi Quattro (154 kW)	2007.06-2008.10	Estate Engine BDx	•		GHA245007	K
	2007.06-2008.10	Estate Engine BDx		o	GHA247001	K
2.8 FSi Quattro (162 kW)	2008.10-2011.08	Estate Engine CCEA	•		GHA245007	K
	2008.10-2011.08	Estate Engine CCEA		o	GHA247001	K
3.0 (160 kW)	2005.03-2006.05	Estate Engine BBJ	•		GHA245007	K
	2005.03-2006.05	Estate Engine BBJ		o	GHA400196	K
3.0 Quattro (160 kW)	2005.03-2006.05	Estate Engine BBJ	•		GHA247001	K
3.0 TDi (171 kW)	2007.09-2011.08	Estate Engine ASB	•		GHA247001	K
	2007.09-2011.08	Estate Engine ASB		o	GHA400196	K
3.0 TDi Quattro (155 kW)	2005.03-2011.08	Estate Engine BNG/CDYB	•		GHA247001	K
3.0 TDi Quattro (165 kW)	2005.03-2006.05	Estate Engine BMK	•		GHA247001	K
3.0 TDi Quattro (171 kW)	2006.05-2007.11	Estate Engine ASB	•		GHA247001	K
3.0 TDi Quattro (176 kW)	2008.10-2011.08	Estate Engine CDYA/CDYC	•		GHA247001	K
3.0 TFSi Quattro (213 kW)	2008.10-2011.08	Estate Engine CAJA	•		GHA247001	K
3.0 TFSi Quattro (220 kW)	2008.10-2011.08	Estate Engine CCAA	•		GHA247001	K
3.2 FSi (188 kW)	2005.03-2008.10	Estate Engine AUK	•		GHA245007	K
	2005.03-2008.10	Estate Engine AUK		o	GHA400196	K
3.2 FSi Quattro (188 kW)	2005.03-2008.10	Estate Engine AUK	•		GHA245007	K
	2005.03-2008.10	Estate Engine AUK		o	GHA247001	K
4.2 FSi Quattro (257 kW)	2006.05-2007.11	Estate Engine BVJ	•		GHA247001	K
4.2 Quattro (246 kW)	2005.03-2006.05	Estate Engine BAT	•		GHA247001	K
5.0 RS6 Quattro (426 kW)	2008.01-2010.08	Estate Engine BUH	•		GHA247001	K
5.2 S6 Quattro (320 kW)	2006.03-2007.11	Estate Engine BXA	•		GHA247001	K
A6 AVANT (4G5, C7)						
2.0 TDi (120 kW)	2011.05-	Estate Engine CGLD	•		GHA262001	K
	2011.05-	Estate Engine CGLD		o	GHA232036	K
2.0 TDi (130 kW)	2011.05-	Estate Engine CGLC/CMGB	•		GHA262001	K
	2011.05-	Estate Engine CGLC/CMGB		o	GHA232036	K
2.0 TFSi (132 kW)	2011.06-	Estate Engine CDNb	•		GHA262001	K
	2011.06-	Estate Engine CDNb		o	GHA232036	K
2.8 FSi (150 kW)	2011.05-	Estate Engine CHVA	•		GHA262001	K
	2011.05-	Estate Engine CHVA		o	GHA232036	K
2.8 FSi Quattro (150 kW)	2011.05-	Estate Engine CHVA	•		GHA262001	K
3.0 TDi (150 kW)	2011.05-	Estate Engine CLAB	•		GHA262001	K
	2011.05-	Estate Engine CLAB		o	GHA232036	K
3.0 TDi Quattro (150 kW)	2011.05-	Estate Engine CLAA	•		GHA262001	K
3.0 TDi Quattro (180 kW)	2011.05-	Estate Engine CDUC/CDUD/CKVB/CKVC	•		GHA262001	K
3.0 TDi Quattro (230 kW)	2011.11-	Estate Engine CGQB	•		GHA262001	K



	 YEAR		F	R	G-AP Ref.	KIT
AUDI						
A6 AVANT (4G5, C7)						
3.0 TFSi Quattro (220 kW)	2011.05-2012.05	Estate Engine CGWB	•		GHA262001	K
3.0 TFSi Quattro (228 kW)	2011.11-	Estate Engine CGWD	•		GHA262001	K
4.0 S6 Quattro (309 kW)	2012.02-	Estate Engine CEUC	•		GHA262001	K
A6 AVANT (4G5, C7, 4GD)						
1.8 TFSi (140 kW)	2014.09-	Estate Engine CYGA	•		GHA262001	K
	2014.09-	Estate Engine CYGA		◦	GHA232036	K
2.0 TDi (100 kW)	2012.01-	Estate Engine CGLE/CSUE	•		GHA262001	K
	2012.01-	Estate Engine CGLE/CSUE		◦	GHA232036	K
2.0 TDi (110 kW)	2014.09-	Estate Engine CSUD	•		GHA262001	K
	2014.09-	Estate Engine CSUD		◦	GHA232036	K
2.0 TDi (140 kW)	2013.11-	Estate Engine CNHA	•		GHA262001	K
	2013.11-	Estate Engine CNHA		◦	GHA232036	K
2.0 TDi Quattro (140 kW)	2015.04-	Estate Engine CNHA	•		GHA262001	K
2.0 TFSi (185 kW)	2014.09-	Estate Engine CYNB/CYPA	•		GHA262001	K
	2014.09-	Estate Engine CYNB/CYPA		◦	GHA232036	K
2.0 TFSi Quattro (183 kW)	2015.05-	Estate Engine CYPB	•		GHA262001	K
2.0 TFSi Quattro (185 kW)	2015.05-	Estate Engine CYPA	•		GHA262001	K
3.0 TDi (155 kW)	2014.09-	Estate Engine CTCB	•		GHA262001	K
	2014.09-	Estate Engine CTCB		◦	GHA232036	K
3.0 TDi (160 kW)	2014.09-	Estate Engine CTCC	•		GHA262001	K
	2014.09-	Estate Engine CTCC		◦	GHA232036	K
3.0 TDi Quattro (155 kW)	2014.09-	Estate Engine CRTF	•		GHA262001	K
3.0 TDi Quattro (160 kW)	2014.09-	Estate Engine CRTE	•		GHA262001	K
3.0 TDi Quattro (200 kW)	2014.09-	Estate Engine CRTD	•		GHA262001	K
3.0 TDi Quattro (235 kW)	2014.09-	Estate Engine CVUA	•		GHA262001	K
3.0 TDi Quattro (240 kW)	2014.09-	Estate Engine CVUB	•		GHA262001	K
3.0 TFSi Quattro (245 kW)	2014.09-	Estate Engine CREC	•		GHA262001	K
4.0 RS6 Quattro (412 kW)	2013.01-	Estate Engine CRDB	•		GHA262001	K
4.0 S6 Quattro (331 kW)	2014.10-	Estate Engine CTGE	•		GHA262001	K
A7 (4GA)						
2.8 FSi (150 kW)	2011.02-	Hatchback Engine CHVA	•		GHA262001	K
	2011.02-	Hatchback Engine CHVA		◦	GHA232036	K
2.8 FSi Quattro (150 kW)	2010.10-	Hatchback Engine CHVA/CNYA	•		GHA262001	K
3.0 TDi (150 kW)	2010.11-	Hatchback Engine CLAB	•		GHA262001	K
	2010.11-	Hatchback Engine CLAB		◦	GHA232036	K
3.0 TDi Quattro (150 kW)	2010.12-	Hatchback Engine CLAA	•		GHA262001	K
3.0 TDi Quattro (180 kW)	2010.10-	Hatchback Engine CDUC/CDUD/CKVB/CKVC	•		GHA262001	K
3.0 TDi Quattro (230 kW)	2011.11-	Hatchback Engine CGQB	•		GHA262001	K
3.0 TFSi Quattro (220 kW)	2010.10-	Hatchback Engine CGWB/CHMA	•		GHA262001	K
3.0 TFSi Quattro (228 kW)	2011.01-	Hatchback Engine CGWD/CGXB/CTTA/CTUA	•		GHA262001	K
4.0 S7 Quattro (309 kW)	2012.02-	Hatchback Engine CEUC	•		GHA262001	K
A7 SPORTBACK (4GA, 4GF)						
1.8 TFSi (140 kW)	2015.04-	Hatchback Engine CYGA	•		GHA262001	K
	2015.04-	Hatchback Engine CYGA		◦	GHA232036	K
2.0 TFSi (185 kW)	2014.09-	Hatchback Engine CYPA	•		GHA262001	K
	2014.09-	Hatchback Engine CYPA		◦	GHA232036	K
2.0 TFSi Quattro (183 kW)	2015.05-	Hatchback Engine CYPB	•		GHA262001	K
2.0 TFSi Quattro (185 kW)	2015.05-	Hatchback Engine CYNB/CYPA	•		GHA262001	K
3.0 TDi (160 kW)	2014.07-	Hatchback Engine CTCC	•		GHA262001	K
	2014.07-	Hatchback Engine CTCC		◦	GHA232036	K
3.0 TDi Quattro (155 kW)	2014.07-	Hatchback Engine CRTF/CTCB	•		GHA262001	K
3.0 TDi Quattro (160 kW)	2014.07-	Hatchback Engine CRTE	•		GHA262001	K
3.0 TDi Quattro (176 kW)	2013.05-	Hatchback Engine CPNB	•		GHA262001	K
3.0 TDi Quattro (200 kW)	2014.05-	Hatchback Engine CRTD	•		GHA262001	K
3.0 TDi Quattro (235 kW)	2014.05-	Hatchback Engine CVUA	•		GHA262001	K
3.0 TDi Quattro (240 kW)	2014.09-	Hatchback Engine CVUB	•		GHA262001	K
3.0 TFSi Quattro (245 kW)	2014.05-	Hatchback Engine CREC	•		GHA262001	K
4.0 RS7 Quattro (412 kW)	2013.10-	Hatchback Engine CRDB/CWUB	•		GHA262001	K
4.0 S7 Quattro (331 kW)	2014.07-	Hatchback Engine CTGE	•		GHA262001	K
A8 (4D2, 4D8)						
2.5 TDi (110 kW)	1997.01-2000.04	Saloon Engine AFB/AKN	•		GHA245010	K
	1997.01-2000.04	Saloon Engine AFB/AKN	•		GHA247001	K
	1997.01-2000.04	Saloon Engine AFB/AKN	•		GWB1356	



	 YEAR		F	R	G-AP Ref.	KIT
AUDI						
A8 (4D2, 4D8)						
2.5 TDi (132 kW)	2000.09-2002.09	Saloon Engine AKE	•		GHA245010	K
	2000.09-2002.09	Saloon Engine AKE	•		GHA247001	K
2.5 TDi Quattro (110 kW)	1997.07-2000.04	Saloon Engine AFB/AKN	•		GHA245010	K
	1997.07-2000.04	Saloon Engine AFB/AKN	•		GHA247001	K
	1997.07-2000.04	Saloon Engine AFB/AKN	•		GWB1356	
2.5 TDi Quattro (132 kW)	2000.09-2002.09	Saloon Engine AKE	•		GHA245010	K
	2000.09-2002.09	Saloon Engine AKE	•		GHA247001	K
2.8 (120 kW)	1995.07-1996.03	Saloon Engine AEJ	•		GWB1356	
	1995.07-1996.03	Saloon Engine AEJ			GWB3427	
2.8 (128 kW)	1994.03-1996.03	Saloon Engine AAH	•		GWB1356	
	1994.03-1996.03	Saloon Engine AAH			GWB3427	
2.8 (142 kW)	1996.04-2002.09	Saloon Engine ACK/ALG/AMX/APR/AQD	•		GHA245010	K
	1996.04-2002.09	Saloon Engine ACK/ALG/AMX/APR/AQD	•		GHA247001	K
	1996.04-2002.09	Saloon Engine ACK/ALG/AMX/APR/AQD	•		GWB1356	
2.8 Quattro (120 kW)	1995.07-1996.03	Saloon Engine AEJ	•		GWB1356	
	1995.07-1996.03	Saloon Engine AEJ			GWB3427	
2.8 Quattro (128 kW)	1994.03-1996.03	Saloon Engine AAH	•		GWB1356	
	1994.03-1996.03	Saloon Engine AAH			GWB3427	
2.8 Quattro (142 kW)	1996.04-2002.09	Saloon Engine ACK/AMX/APR/AQD	•		GHA245010	K
	1996.04-2002.09	Saloon Engine ACK/AMX/APR/AQD	•		GHA247001	K
	1996.04-2002.09	Saloon Engine ACK/AMX/APR/AQD	•		GWB1356	
3.3 TDi Quattro (165 kW)	2000.06-2002.09	Saloon Engine AKF	•		GHA245010	K
	2000.06-2002.09	Saloon Engine AKF	•		GHA247001	K
3.7 (169 kW)	1995.07-1998.12	Saloon Engine AEW	•		GWB1356	
	1995.07-1998.12	Saloon Engine AEW			GWB3427	
3.7 (191 kW)	1998.11-2002.09	Saloon Engine AKC/AQG	•		GHA245010	K
	1998.11-2002.09	Saloon Engine AKC/AQG	•		GHA247001	K
	1998.11-2002.09	Saloon Engine AKC/AQG	•		GWB1356	
3.7 Quattro (169 kW)	1995.07-1998.11	Saloon Engine AEW/AKJ	•		GWB1356	
	1995.07-1998.11	Saloon Engine AEW/AKJ			GWB3427	
3.7 Quattro (191 kW)	1998.11-2002.09	Saloon Engine AKC/AQG	•		GHA245010	K
	1998.11-2002.09	Saloon Engine AKC/AQG	•		GHA247001	K
	1998.11-2002.09	Saloon Engine AKC/AQG	•		GWB1356	
4.2 Quattro (175 kW)	1999.02-2000.04	Saloon Engine ARU	•		GHA245010	K
	1999.02-2000.04	Saloon Engine ARU	•		GHA247001	K
4.2 Quattro (180 kW)	1994.03-1996.07	Saloon Engine AEM	•		GWB1356	
	1994.03-1996.07	Saloon Engine AEM			GWB3427	
4.2 Quattro (210 kW)	1995.07-1998.09	Saloon Engine AGH	•		GWB1356	
4.2 Quattro (220 kW)	1994.03-1998.11	Saloon Engine ABZ/AKG	•		GWB1356	
	1994.03-1998.11	Saloon Engine ABZ/AKG			GWB3427	
4.2 Quattro (228 kW)	1998.11-2002.09	Saloon Engine AQF/AUW/AUX	•		GHA245010	K
	1998.11-2002.09	Saloon Engine AQF/AUW/AUX	•		GHA247001	K
	1998.11-2002.09	Saloon Engine AQF/AUW/AUX	•		GWB1356	
4.2 S8 Quattro (250 kW)	1996.07-1999.06	Saloon Engine AHC/AKH	•		GHA245010	K
	1996.07-1999.06	Saloon Engine AHC/AKH	•		GHA247001	K
	1996.07-1999.06	Saloon Engine AHC/AKH	•		GWB1356	
4.2 S8 Quattro (265 kW)	1999.06-2002.09	Saloon Engine AQH/AVP	•		GHA245010	K
	1999.06-2002.09	Saloon Engine AQH/AVP	•		GHA247001	K
6.0 W12 Quattro (309 kW)	2001.01-2002.09	Saloon Engine AZC	•		GHA247001	K
	2001.01-2002.09	Saloon Engine AZC		o	GHA245010	K
A8 (4E_)						
2.8 FSi (154 kW)	2007.08-2010.07	Saloon Engine BDX	•		GHA247001	K
	2007.08-2010.07	Saloon Engine BDX		o	GHA245007	S
3.0 (160 kW)	2003.07-2006.05	Saloon Engine BBJ	•		GHA247001	K
	2003.07-2006.05	Saloon Engine BBJ		o	GHA245007	S
3.0 (162 kW)	2003.07-2005.05	Saloon Engine ASN	•		GHA247001	K
	2003.07-2005.05	Saloon Engine ASN		o	GHA245007	S
3.0 Quattro (160 kW)	2003.11-2004.05	Saloon Engine BBJ	•		GHA247001	K
	2003.11-2004.05	Saloon Engine BBJ		o	GHA245007	S
3.0 TDi Quattro (155 kW)	2003.11-2010.07	Saloon Engine BNG	•		GHA247001	K
	2003.11-2010.07	Saloon Engine BNG		o	GHA245007	S
3.0 TDi Quattro (171 kW)	2003.08-2010.07	Saloon Engine ASB	•		GHA247001	K
	2003.08-2010.07	Saloon Engine ASB		o	GHA245007	S
3.2 FSi (191 kW)	2005.06-2007.11	Saloon Engine BPK	•		GHA247001	K



	 YEAR		F	R	G-AP Ref.	KIT
AUDI						
A8 (4E_)						
3.2 FSi (191 kW)	2005.06-2007.11	Saloon Engine BPK		o	GHA245007	S
3.2 FSi Quattro (191 kW)	2005.06-2010.07	Saloon Engine BPK	•		GHA247001	K
	2005.06-2010.07	Saloon Engine BPK		o	GHA245007	S
3.7 Quattro (206 kW)	2002.10-2006.05	Saloon Engine BFL	•		GHA247001	K
	2002.10-2006.05	Saloon Engine BFL		o	GHA245007	S
4.0 TDi Quattro (202 kW)	2003.05-2005.07	Saloon Engine ASE	•		GHA247001	K
	2003.05-2005.07	Saloon Engine ASE		o	GHA245007	S
4.2 FSi Quattro (257 kW)	2006.05-2007.11	Saloon Engine BVJ	•		GHA247001	K
	2006.05-2007.11	Saloon Engine BVJ		o	GHA245007	S
4.2 Quattro (246 kW)	2002.10-2010.07	Saloon Engine BFM	•		GHA247001	K
	2002.10-2010.07	Saloon Engine BFM		o	GHA245007	S
4.2 TDi Quattro (235 kW)	2005.06-2007.11	Saloon Engine BMC	•		GHA247001	K
	2005.06-2007.11	Saloon Engine BMC		o	GHA245007	S
4.2 TDi Quattro (240 kW)	2005.07-2010.07	Saloon Engine BVN	•		GHA247001	K
	2005.07-2010.07	Saloon Engine BVN		o	GHA245007	S
5.2 S8 Quattro (331 kW)	2006.01-2007.12	Saloon Engine BSM	•		GHA247001	K
	2006.01-2007.12	Saloon Engine BSM		o	GHA245007	S
6.0 W12 Quattro (331 kW)	2003.12-2010.07	Saloon Engine BHT	•		GHA247001	K
	2003.12-2010.07	Saloon Engine BHT		o	GHA245007	S
A8 (4H_)						
2.0 TFSi HybrID (155 kW)	2012.02-	Saloon Engine CHJA	•		GHA262001	K
3.0 TDi (150 kW)	2011.09-	Saloon Engine CLAB	•		GHA262001	K
3.0 TDi Quattro (155 kW)	2010.08-	Saloon Engine CDTB	•		GHA262001	K
3.0 TDi Quattro (176 kW)	2012.11-	Saloon Engine CPNA	•		GHA262001	K
3.0 TDi Quattro (184 kW)	2010.07-	Saloon Engine CDTA/CMHA	•		GHA262001	K
3.0 TDi Quattro (190 kW)	2013.10-	Saloon Engine CTBA	•		GHA262001	K
3.0 TDi Quattro (193 kW)	2015.05-	Saloon Engine CTBD	•		GHA262001	K
3.0 TFSi Quattro (213 kW)	2010.07-	Saloon Engine CGWA/CGXA	•		GHA262001	K
3.0 TFSi Quattro (228 kW)	2011.11-	Saloon Engine CGWD	•		GHA262001	K
3.0 TFSi Quattro (245 kW)	2010.06-	Saloon Engine CGXC/CMDA/CREC/CTDA/CTUB	•		GHA262001	K
3.0 FSi (150 kW)	2012.07-	Saloon Engine CPAA/CVBA	•		GHA262001	K
4.0 S8 Quattro (382 kW)	2012.04-	Saloon Engine CGTA	•		GHA262001	K
4.0 TFSi Quattro (309 kW)	2012.03-	Saloon Engine CEUA	•		GHA262001	K
4.0 TFSi Quattro (320 kW)	2013.10-	Saloon Engine CTGA	•		GHA262001	K
4.2 FSi Quattro (273 kW)	2009.11-	Saloon Engine CDRA	•		GHA262001	K
4.2 TDi Quattro (258 kW)	2009.11-	Saloon Engine CDSB	•		GHA262001	K
4.2 TDi Quattro (283 kW)	2013.10-	Saloon Engine CTEC	•		GHA262001	K
6.3 W12 Quattro (368 kW)	2011.01-	Saloon Engine CEJA/CTNA	•		GHA262001	K
ALLROAD (4BH, C5)						
2.5 TDi Quattro (120 kW)	2003.05-2005.08	Estate Engine BCZ	•		GWB1356	
2.5 TDi Quattro (132 kW)	2000.05-2005.08	Estate Engine AKE/BAU	•		GWB1356	
2.7 Quattro (187 kW)	2000.09-2005.08	Estate Engine APB/BEL	•		GWB1356	
2.7 T Quattro (184 kW)	2000.05-2005.08	Estate Engine ARE/BES	•		GWB1356	
4.2 V8 Quattro (220 kW)	2002.07-2005.08	Estate Engine BAS	•		GWB1356	
CABRIOLET (8G7, B4)						
1.8 (92 kW)	1997.01-2000.08	Convertible Engine ADR	•		GWB1355	
	1997.01-2000.08	Convertible Engine ADR		o	GHA499047	
	1997.01-2000.08	Convertible Engine ADR		o	GWB0542	
	1997.01-2000.08	Convertible Engine ADR		o	GWB3519	
1.9 TDi (66 kW)	1995.06-2000.08	Convertible Engine 1Z/AHU	•		GWB1355	
	1995.06-2000.08	Convertible Engine 1Z/AHU		o	GHA499047	
	1995.06-2000.08	Convertible Engine 1Z/AHU		o	GWB0542	
	1995.06-2000.08	Convertible Engine 1Z/AHU		o	GWB3519	
2.0 16V (103 kW)	1995.06-1996.07	Convertible Engine ACE	•		GWB1355	
	1995.06-1996.07	Convertible Engine ACE		o	GWB0542	
2.0 E (85 kW)	1993.01-1998.07	Convertible Engine ABK	•		GWB1355	
	1993.01-1998.07	Convertible Engine ABK		o	GHA499047	
	1993.01-1998.07	Convertible Engine ABK		o	GWB0542	
	1993.01-1998.07	Convertible Engine ABK		o	GWB3519	
2.3 E (98 kW)	1991.05-1994.07	Convertible Engine NG	•		GWB1355	
	1991.05-1994.07	Convertible Engine NG		o	GHA499047	
	1991.05-1994.07	Convertible Engine NG		o	GWB0542	
2.6 (102 kW)	1995.05-2000.08	Convertible Engine ACZ	•		GWB1356	
	1995.05-2000.08	Convertible Engine ACZ		o	GWB0542	



	 YEAR		F	R	G-AP Ref.	KIT
AUDI						
CABRIOLET (8G7, B4)						
2.6 (102 kW)	1995.05-2000.08	Convertible Engine ACZ		o	GWB3519	
2.6 (110 kW)	1993.06-2000.08	Convertible Engine ABC	•		GWB1356	
	1993.06-2000.08	Convertible Engine ABC		o	GHA499047	
	1993.06-2000.08	Convertible Engine ABC		o	GWB0542	
	1993.06-2000.08	Convertible Engine ABC		o	GWB3519	
2.8 (128 kW)	1992.11-2000.08	Convertible Engine AAH	•		GWB1356	
	1992.11-2000.08	Convertible Engine AAH		o	GHA499047	
	1992.11-2000.08	Convertible Engine AAH		o	GWB0542	
	1992.11-2000.08	Convertible Engine AAH		o	GWB3519	
COUPE (89, 8B)						
2.0 (82 kW)	1990.03-1990.07	Coupe Engine 3A	•		GWB1355	
	1990.03-1990.07	Coupe Engine 3A		o	GHA499047	
	1990.03-1990.07	Coupe Engine 3A		o	GWB0542	
2.0 16V (101 kW)	1992.01-1992.07	Coupe Engine 6A	•		GWB1355	
	1992.01-1992.07	Coupe Engine 6A		o	GHA499047	
	1992.01-1992.07	Coupe Engine 6A		o	GWB0542	
2.0 16V (103 kW)	1992.08-1996.12	Coupe Engine ACE	•		GWB1355	
	1992.08-1996.12	Coupe Engine ACE		o	GHA499047	
	1992.08-1996.12	Coupe Engine ACE		o	GWB0542	
2.2 S2 Quattro (162 kW)	1990.09-1992.09	Coupe Engine 3B	•		GWB1356	
2.2 S2 Quattro (169 kW)	1992.10-1996.12	Coupe Engine ABY	•		GWB1356	
2.3 (98 kW)	1990.03-1996.12	Coupe Engine NG	•		GWB1356	
	1990.03-1996.12	Coupe Engine NG		o	GHA499047	
	1990.03-1996.12	Coupe Engine NG		o	GWB0542	
2.3 20V (123 kW)	1990.08-1991.07	Coupe Engine 7A	•		GWB1356	
	1990.08-1991.07	Coupe Engine 7A		o	GWB0542	
2.3 20V Quattro (123 kW)	1990.05-1996.12	Coupe Engine 7A	•		GWB1356	
	1990.05-1996.12	Coupe Engine 7A		o	GWB1355	
2.3 Quattro (98 kW)	1990.05-1996.12	Coupe Engine NG	•		GWB1355	
	1990.05-1996.12	Coupe Engine NG	•		GWB1356	
2.6 (110 kW)	1992.08-1996.12	Coupe Engine ABC	•		GWB1356	
	1992.08-1996.12	Coupe Engine ABC		o	GHA499047	
	1992.08-1996.12	Coupe Engine ABC		o	GWB0542	
2.6 Quattro (110 kW)	1992.08-1996.12	Coupe Engine ABC	•		GWB1356	
	1992.08-1996.12	Coupe Engine ABC		o	GWB1355	
2.8 (128 kW)	1991.09-1996.12	Coupe Engine AAH	•		GWB1356	
	1991.09-1996.12	Coupe Engine AAH		o	GHA499047	
	1991.09-1996.12	Coupe Engine AAH		o	GWB0542	
2.8 Quattro (128 kW)	1991.08-1996.12	Coupe Engine AAH	•		GWB1356	
	1991.08-1996.12	Coupe Engine AAH		o	GWB1355	
Q3 (8U)						
1.4 TFSi (110 kW)	2013.10-	Closed Off-Road Vehicle Engine CHPB/CZDA/CZEA 4 hole	•		GHA336007	K
	2013.10-	Closed Off-Road Vehicle Engine CHPB/CZDA/CZEA Inner Diameter [32mm]		o	GHA232018	K
2.0 TDi (100 kW)	2011.09-	Closed Off-Road Vehicle Engine CFFA 4 hole	•		GHA336007	K
	2011.09-	Closed Off-Road Vehicle Engine CFFA Inner Diameter [32mm]		o	GHA232018	K
2.0 TDi (103 kW)	2011.09-	Closed Off-Road Vehicle Engine CFFB/CLJA 4 hole	•		GHA336007	K
	2011.09-	Closed Off-Road Vehicle Engine CFFB/CLJA Inner Diameter [32mm]		o	GHA232018	K
2.0 TDi (110 kW)	2014.11-	Closed Off-Road Vehicle Engine CUVC 4 hole	•		GHA336007	K
	2014.11-	Closed Off-Road Vehicle Engine CUVC Inner Diameter [32mm]		o	GHA232018	K
2.0 TDi (130 kW)	2013.05-	Closed Off-Road Vehicle Engine CFGC 4 hole	•		GHA336007	K
	2013.05-	Closed Off-Road Vehicle Engine CFGC Inner Diameter [32mm]		o	GHA232018	K
2.0 TDi (135 kW)	2015.05-	Closed Off-Road Vehicle Engine CUWA 4 hole	•		GHA336007	K
	2015.05-	Closed Off-Road Vehicle Engine CUWA Inner Diameter [32mm]		o	GHA232018	K
2.0 TDi (88 kW)	2015.03-	Closed Off-Road Vehicle Engine CUVD 4 hole	•		GHA336007	K
	2015.03-	Closed Off-Road Vehicle Engine CUVD Inner Diameter [32mm]		o	GHA232018	K
2.0 TDi Quattro (103 kW)	2012.01-	Closed Off-Road Vehicle Engine CFFB 4 hole	•		GHA336007	K
2.0 TDi Quattro (110 kW)	2014.11-	Closed Off-Road Vehicle Engine CUVC 4 hole	•		GHA336007	K
2.0 TDi Quattro (120 kW)	2011.06-	Closed Off-Road Vehicle Engine CFGD 4 hole	•		GHA336007	K
2.0 TDi Quattro (130 kW)	2011.06-	Closed Off-Road Vehicle Engine CFGC/CLLB 4 hole	•		GHA336007	K
2.0 TDi Quattro (135 kW)	2014.11-	Closed Off-Road Vehicle Engine CUWA/CYLA 4 hole	•		GHA336007	K
2.0 TFSi (132 kW)	2015.05-	Closed Off-Road Vehicle Engine CULB 4 hole	•		GHA336007	K
	2015.05-	Closed Off-Road Vehicle Engine CULB Inner Diameter [32mm]		o	GHA232018	K
2.0 TFSi Quattro (125 kW)	2011.06-	Closed Off-Road Vehicle Engine CCZC 4 hole	•		GHA336007	K
2.0 TFSi Quattro (132 kW)	2014.11-	Closed Off-Road Vehicle Engine CULB 4 hole	•		GHA336007	K



	 YEAR		F	R	G-AP Ref.	KIT
AUDI						
Q3 (8U)						
2.0 TFSi Quattro (155 kW)	2011.06-	Closed Off-Road Vehicle Engine CPSA 4 hole	•		GHA336007	K
2.0 TFSi Quattro (162 kW)	2014.11-	Closed Off-Road Vehicle 4 hole	•		GHA336007	K
2.5 RS Quattro (228 kW)	2013.10-	Closed Off-Road Vehicle Engine CTSA 4 hole	•		GHA336007	K
RS 2.5 Quattro (250 kW)	2013.05-	Closed Off-Road Vehicle Engine CZGA 4 hole	•		GHA336007	K
Q5 (8R)						
2.0 TDi (100 kW)	2010.11-	Closed Off-Road Vehicle Engine CJCB	•		GHA262001	K
	2010.11-	Closed Off-Road Vehicle Engine CJCB		○	GHA232036	K
2.0 TDi (105 kW)	2010.11-	Closed Off-Road Vehicle Engine CJCA	•		GHA262001	K
	2010.11-	Closed Off-Road Vehicle Engine CJCA		○	GHA232036	K
2.0 TDi (110 kW)	2013.05-	Closed Off-Road Vehicle Engine CJCD	•		GHA262001	K
	2013.05-	Closed Off-Road Vehicle Engine CJCD		○	GHA232036	K
2.0 TDi Quattro (100 kW)	2009.08-	Closed Off-Road Vehicle Engine CAGB/CJCB/CSUB	•		GHA262001	K
2.0 TDi Quattro (105 kW)	2009.08-	Closed Off-Road Vehicle Engine CAGA/CJCA	•		GHA262001	K
2.0 TDi Quattro (110 kW)	2013.05-	Closed Off-Road Vehicle Engine CJCD/CSUA	•		GHA262001	K
2.0 TDi Quattro (120 kW)	2008.11-	Closed Off-Road Vehicle Engine CAHB/CGLA/CGLD/CNHC	•		GHA262001	K
2.0 TDi Quattro (125 kW)	2008.11-	Closed Off-Road Vehicle Engine CAHA/CGLB/CMGA	•		GHA262001	K
2.0 TDi Quattro (130 kW)	2012.06-	Closed Off-Road Vehicle Engine CGLC/CMGB	•		GHA262001	K
2.0 TDi Quattro (140 kW)	2013.11-	Closed Off-Road Vehicle Engine CNHA	•		GHA262001	K
2.0 TFSi HybrID Quattro (155 kW)	2011.06-	Closed Off-Road Vehicle Engine CHJA	•		GHA262001	K
2.0 TFSi Quattro (132 kW)	2009.08-	Closed Off-Road Vehicle Engine CDN/CNCB	•		GHA262001	K
2.0 TFSi Quattro (155 kW)	2008.11-	Closed Off-Road Vehicle Engine CAEB/CDNC/CPMA	•		GHA262001	K
2.0 TFSi Quattro (162 kW)	2013.05-	Closed Off-Road Vehicle Engine CPMB	•		GHA262001	K
2.0 TFSi Quattro (165 kW)	2012.06-	Closed Off-Road Vehicle Engine CNCD	•		GHA262001	K
2.0 TFSi Quattro (169 kW)	2015.08-	Closed Off-Road Vehicle Engine CNCE	•		GHA262001	K
3.0 SQ5 TDi Quattro (230 kW)	2012.12-	Closed Off-Road Vehicle Engine CGQB	•		GHA262001	K
3.0 SQ5 TFSi Quattro (260 kW)	2013.05-	Closed Off-Road Vehicle Engine CTUD/CTXA	•		GHA262001	K
3.0 TDi Quattro (155 kW)	2008.11-	Closed Off-Road Vehicle Engine CCWB	•		GHA262001	K
3.0 TDi Quattro (176 kW)	2008.11-	Closed Off-Road Vehicle Engine CCWA	•		GHA262001	K
3.0 TDi Quattro (180 kW)	2012.06-	Closed Off-Road Vehicle Engine CDUD	•		GHA262001	K
3.0 TDi Quattro (184 kW)	2012.06-	Closed Off-Road Vehicle Engine CTBC	•		GHA262001	K
3.0 TDi Quattro (190 kW)	2013.11-	Closed Off-Road Vehicle Engine CTBA	•		GHA262001	K
3.0 TFSi Quattro (200 kW)	2012.06-	Closed Off-Road Vehicle Engine CTUC/CTVA	•		GHA262001	K
3.2 FSi Quattro (199 kW)	2008.11-	Closed Off-Road Vehicle Engine CALB	•		GHA262001	K
SQ5 TDi Quattro (240 kW)	2015.04-	Closed Off-Road Vehicle Engine CVUB	•		GHA262001	K
Q7 (4L)						
3.0 TDi (150 kW)	2010.05-	Closed Off-Road Vehicle Engine CJGC/CJMA	•		GWB3645	
3.0 TDi (155 kW)	2006.03-2010.05	Closed Off-Road Vehicle Engine BUN/CASB	•		GWB3645	
3.0 TDi (165 kW)	2009.06-2012.05	Closed Off-Road Vehicle Engine CATA	•		GWB3645	
3.0 TDi (171 kW)	2006.03-2008.05	Closed Off-Road Vehicle Engine BUG	•		GWB3645	
3.0 TDi (176 kW)	2007.11-	Closed Off-Road Vehicle Engine CASA/CCMA/CJGA/CNRB	•		GWB3645	
3.0 TDi (180 kW)	2011.05-	Closed Off-Road Vehicle Engine CJGD/CLZB/CRCA	•		GWB3645	
3.0 TFSi (200 kW)	2010.05-	Closed Off-Road Vehicle Engine CJTC/CJWC	•		GWB3645	
3.0 TFSi (206 kW)	2011.05-	Closed Off-Road Vehicle Engine CJWE/CTWB	•		GWB3645	
3.0 TFSi (245 kW)	2010.05-	Closed Off-Road Vehicle Engine CJTB/CJWB/CNAA/CTWA	•		GWB3645	
3.6 FSi (206 kW)	2006.12-2007.11	Closed Off-Road Vehicle Engine BHK	•		GWB3645	
4.2 FSi (257 kW)	2006.03-2010.05	Closed Off-Road Vehicle Engine BAR	•		GWB3645	
4.2 TDi (240 kW)	2007.03-2007.11	Closed Off-Road Vehicle Engine BTR	•		GWB3645	
4.2 TDi (250 kW)	2009.05-	Closed Off-Road Vehicle Engine CCFA/CCFC	•		GWB3645	
6.0 TDi (368 kW)	2008.09-	Closed Off-Road Vehicle Engine CCGA	•		GWB3645	
R8						
4.2 FSi Quattro (309 kW)	2007.04-2010.09	Coupe Engine BYH	•		GHA245007	K
	2007.04-2010.09	Coupe Engine BYH		○	GHA247001	K
4.2 FSi Quattro (316 kW)	2010.07-	Coupe Engine CNDA	•		GHA245007	K
	2010.07-	Coupe Engine CNDA		○	GHA247001	K
5.2 FSi Quattro (386 kW)	2009.04-	Coupe Engine BUJ/CTYA	•		GHA245007	K
5.2 FSi Quattro (404 kW)	2012.05-	Coupe Engine CTPA	•		GHA245007	K
5.2 FSi Quattro (412 kW)	2010.11-	Coupe Engine CMPA	•		GHA245007	K
5.2 FSi Quattro (419 kW)	2014.07-	Coupe Engine CTPB	•		GHA245007	K
R8 SPYDER						
4.2 FSi Quattro (316 kW)	2010.09-	Convertible Engine CNDA	•		GHA245007	K
	2010.09-	Convertible Engine CNDA		○	GHA247001	K
5.2 FSi Quattro (386 kW)	2010.02-	Convertible Engine BUJ/CTYA	•		GHA245007	K
5.2 FSi Quattro (412 kW)	2011.11-	Convertible Engine CMPA	•		GHA245007	K



	 YEAR		F	R	G-AP Ref.	KIT
AUDI						
TT (8J3)						
1.8 TFSi (118 kW)	2008.06-	Coupe Engine CDAA 4 hole	•		GHA336007	K
	2008.06-	Coupe Engine CDAA Inner Diameter [32mm]		◦	GHA232018	K
2.0 Quattro (195 kW)	2008.05-	Coupe Engine CDLA/CDMA 4 hole	•		GHA336007	K
2.0 TDi Quattro (125 kW)	2008.06-	Coupe Engine CBBB/CFGB 4 hole	•		GHA336007	K
2.0 TFSi (147 kW)	2006.08-2010.06	Coupe Engine BWA 4 hole	•		GHA336007	K
	2006.08-2010.06	Coupe Engine BWA Inner Diameter [32mm]		◦	GHA232018	K
2.0 TFSi (155 kW)	2010.05-	Coupe Engine CESA 4 hole	•		GHA336007	K
	2010.05-	Coupe Engine CESA Inner Diameter [32mm]		◦	GHA232018	K
2.0 TFSi Quattro (147 kW)	2008.06-2010.06	Coupe Engine CCZA/BWA 4 hole	•		GHA336007	K
2.0 TFSi Quattro (155 kW)	2010.05-	Coupe Engine CESA/CETA 4 hole	•		GHA336007	K
2.0 TFSi Quattro (200 kW)	2008.05-	Coupe Engine CDLB 4 hole	•		GHA336007	K
2.5 TFSi RS Quattro (250 kW)	2009.07-	Coupe Engine CEPA 4 hole	•		GHA336007	K
2.5 TFSi RS Quattro (265 kW)	2011.05-	Coupe Engine CEPB 4 hole	•		GHA336007	K
3.2 V6 Quattro (184 kW)	2006.08-2010.06	Coupe Engine BUB 4 hole	•		GHA336007	K
TT (8N3)						
1.8 T (110 kW)	2002.09-2006.06	Coupe Engine AUM	•		GWB3607	
	2002.09-2006.06	Coupe Engine AUM With ABS		◦	GHA230051	K
1.8 T (120 kW)	2005.09-2006.06	Coupe Engine BVP	•		GWB3607	
	2005.09-2006.06	Coupe Engine BVP With ABS		◦	GHA230051	K
1.8 T (132 kW)	1998.10-2006.06	Coupe Engine AJQ/APP/ATC/AUQ	•		GWB3455	
	1998.10-2006.06	Coupe Engine AJQ/APP/ATC/AUQ	•		GWB3607	
	1998.10-2006.06	Coupe Engine AJQ/APP/ATC/AUQ With ABS		◦	GHA230051	K
1.8 T (140 kW)	2004.06-2006.08	Coupe Engine BVR	•		GWB3607	
	2004.06-2006.08	Coupe Engine BVR With ABS		◦	GHA230051	K
1.8 T Quattro (132 kW)	1998.10-2006.06	Coupe Engine AJQ/ARY/AUQ	•		GWB3455	
	1998.10-2006.06	Coupe Engine AJQ/ARY/AUQ	•		GWB3607	
	1998.10-2006.06	Coupe Engine AJQ/ARY/AUQ		◦	GHA436002	K
1.8 T Quattro (140 kW)	2005.09-2006.08	Coupe Engine BVR	•		GWB3607	
	2005.09-2006.08	Coupe Engine BVR		◦	GHA436002	K
	2005.09-2006.08	Coupe Engine BVR		◦	GWB3455	
1.8 T Quattro (165 kW)	1998.10-2006.06	Coupe Engine APX/BAM	•		GWB3455	
	1998.10-2006.06	Coupe Engine APX/BAM	•		GWB3607	
	1998.10-2006.06	Coupe Engine APX/BAM		◦	GHA436002	K
1.8 T Quattro (176 kW)	2005.03-2006.08	Coupe Engine BFV	•		GWB3607	
	2005.03-2006.08	Coupe Engine BFV		◦	GHA436002	K
	2005.03-2006.08	Coupe Engine BFV		◦	GWB3455	
3.2 VR6 Quattro (184 kW)	2003.07-2006.06	Coupe Engine BHE/BPF	•		GWB3607	
	2003.07-2006.06	Coupe Engine BHE/BPF		◦	GHA436002	K
	2003.07-2006.06	Coupe Engine BHE/BPF		◦	GWB3455	
TT (FV3)						
2.0 TDi (135 kW)	2014.07-	Coupe Engine CUNA 4 hole		◦	GHA336007	K
2.0 TFSi (169 kW)	2014.07-	Coupe Engine DHHC 4 hole		◦	GHA336007	K
TT ROADSTER (8J9)						
1.8 TFSi (118 kW)	2008.06-	Convertible Engine CDAA 4 hole	•		GHA336007	K
	2008.06-	Convertible Engine CDAA Inner Diameter [32mm]		◦	GHA232018	K
2.0 Quattro (195 kW)	2008.05-	Convertible Engine CDLA/CDMA 4 hole	•		GHA336007	K
2.0 TDi Quattro (125 kW)	2008.06-	Convertible Engine CBBB/CFGB 4 hole	•		GHA336007	K
2.0 TFSi (147 kW)	2007.03-2010.06	Convertible Engine BWA 4 hole	•		GHA336007	K
	2007.03-2010.06	Convertible Engine BWA Inner Diameter [32mm]		◦	GHA232018	K
2.0 TFSi (155 kW)	2010.05-	Convertible Engine CESA 4 hole	•		GHA336007	K
	2010.05-	Convertible Engine CESA Inner Diameter [32mm]		◦	GHA232018	K
2.0 TFSi Quattro (147 kW)	2008.06-2010.06	Convertible Engine CCZA 4 hole	•		GHA336007	K
2.0 TFSi Quattro (155 kW)	2010.05-	Convertible Engine CESA/CETA 4 hole	•		GHA336007	K
2.0 TFSi Quattro (200 kW)	2008.05-	Convertible Engine CDLB 4 hole	•		GHA336007	K
2.5 TFSi RS Quattro (250 kW)	2009.07-	Convertible Engine CEPA 4 hole	•		GHA336007	K
2.5 TFSi RS Quattro (265 kW)	2012.03-	Convertible Engine CEPB 4 hole	•		GHA336007	K
3.2 V6 Quattro (184 kW)	2007.03-2010.06	Convertible Engine BUB 4 hole	•		GHA336007	K
TT ROADSTER (8N9)						
1.8 T (110 kW)	2001.01-2006.06	Convertible Engine AUM	•		GWB3455	
	2001.01-2006.06	Convertible Engine AUM	•		GWB3607	
	2001.01-2006.06	Convertible Engine AUM With ABS		◦	GHA230051	K
1.8 T (120 kW)	2005.09-2006.06	Convertible Engine BVP	•		GWB3607	
	2005.09-2006.06	Convertible Engine BVP With ABS		◦	GHA230051	K



	 YEAR		F	R	G-AP Ref.	KIT
AUDI						
TT ROADSTER (8N9)						
1.8 T (132 kW)	1999.10-2006.06	Convertible Engine AJQ/APP/AUQ/ATC	•		GWB3455	
	1999.10-2006.06	Convertible Engine AJQ/APP/AUQ/ATC	•		GWB3607	
	1999.10-2006.06	Convertible Engine AJQ/APP/AUQ/ATC With ABS		○	GHA230051	K
1.8 T (140 kW)	2005.09-2006.06	Convertible Engine BVR	•		GWB3607	
	2005.09-2006.06	Convertible Engine BVR With ABS		○	GHA230051	K
1.8 T Quattro (132 kW)	2000.02-2006.06	Convertible Engine AJQ/ARY/AUQ	•		GWB3455	
	2000.02-2006.06	Convertible Engine AJQ/ARY/AUQ	•		GWB3607	
	2000.02-2006.06	Convertible Engine AJQ/ARY/AUQ		○	GHA436002	K
1.8 T Quattro (140 kW)	2005.09-2006.11	Convertible Engine BVR	•		GWB3607	
	2005.09-2006.11	Convertible Engine BVR		○	GHA436002	K
	2005.09-2006.11	Convertible Engine BVR		○	GWB3455	
1.8 T Quattro (165 kW)	1999.10-2006.06	Convertible Engine BAM/APX	•		GWB3455	
	1999.10-2006.06	Convertible Engine BAM/APX	•		GWB3607	
	1999.10-2006.06	Convertible Engine BAM/APX		○	GHA436002	K
3.2 VR6 Quattro (184 kW)	2003.07-2006.06	Convertible Engine BHE/BPF	•		GWB3607	
	2003.07-2006.06	Convertible Engine BHE/BPF		○	GHA436002	K
	2003.07-2006.06	Convertible Engine BHE/BPF		○	GWB3455	
V8 (44_, 4C_)						
3.6 Quattro (180 kW)	1993.04-1994.02	Saloon Engine PT	•		GWB1356	
4.2 Quattro (206 kW)	1991.10-1994.02	Saloon Engine ABH	•		GWB1356	
BMW						
1 (E81)						
116 D (66 kW)	2011.01-2011.12	Hatchback Engine N47D20A/N47D20C		○	GWB3682	
116 D (85 kW)	2008.11-2012.09	Hatchback Engine N47D20A/N47D20C	•		GHA400171	K
	2008.11-2012.09	Hatchback Engine N47D20A/N47D20C		○	GHA427011	
	2008.11-2012.09	Hatchback Engine N47D20A/N47D20C		○	GWB3682	
116 i (85 kW)	2007.03-2012.09	Hatchback Engine N43B16A/N45B16A	•		GHA400171	K
	2007.03-2012.09	Hatchback Engine N43B16A/N45B16A		○	GHA427011	
	2007.03-2012.09	Hatchback Engine N43B16A/N45B16A		○	GWB3682	
116 i (89 kW)	2007.08-2012.09	Hatchback Engine N43B16A		○	GWB3682	
116 i (90 kW)	2007.03-2012.09	Hatchback Engine N43B16A/N45B16A	•		GHA400171	K
	2007.03-2012.09	Hatchback Engine N43B16A/N45B16A		○	GHA427011	
	2007.03-2012.09	Hatchback Engine N43B16A/N45B16A		○	GWB3682	
	2008.11-2012.09	Hatchback Engine N43B20A	•		GHA400171	K
	2008.11-2012.09	Hatchback Engine N43B20A		○	GHA427011	
118 D (100 kW)	2006.09-2012.09	Hatchback Engine N47D20A/N47D20C	•		GHA400171	K
	2006.09-2012.09	Hatchback Engine N47D20A/N47D20C		○	GWB3682	
	2006.09-2012.09	Hatchback Engine N47D20A/N47D20C	•		GHA400171	K
118 D (105 kW)	2006.09-2012.09	Hatchback Engine N47D20A/N47D20C		○	GHA427011	
	2006.09-2012.09	Hatchback Engine N47D20A/N47D20C		○	GWB3682	
	2006.09-2012.09	Hatchback Engine N47D20A/N47D20C	•		GHA400171	K
118 i (100 kW)	2006.09-2012.09	Hatchback Engine N46 B20 B	•		GHA400171	K
	2006.09-2012.09	Hatchback Engine N46 B20 B		○	GWB3682	
118 i (105 kW)	2006.09-2012.09	Hatchback Engine N43B20A/N43B20B	•		GHA400171	K
	2006.09-2012.09	Hatchback Engine N43B20A/N43B20B		○	GHA427011	
	2006.09-2012.09	Hatchback Engine N43B20A/N43B20B		○	GWB3682	
120 D (120 kW)	2006.09-2012.09	Hatchback Engine M47D20(204D4)/N47D20A/N47D20C	•		GHA400171	K
	2006.09-2012.09	Hatchback Engine M47D20(204D4)/N47D20A/N47D20C		○	GWB3682	
120 D (130 kW)	2006.09-2012.09	Hatchback Engine N47D20A/N47D20C	•		GHA400171	K
	2006.09-2012.09	Hatchback Engine N47D20A/N47D20C		○	GHA427011	
	2006.09-2012.09	Hatchback Engine N47D20A/N47D20C		○	GWB3682	
120 i (115 kW)	2006.09-2012.09	Hatchback Engine N43B20A/N46B20B/N46B20C		○	GHA427011	
	2006.09-2012.09	Hatchback Engine N43B20A/N46B20B/N46B20C		○	GWB3682	
120 i (120 kW)	2006.09-2012.09	Hatchback Engine N43B20A/N46B20B/N46B20C	•		GHA400171	K
	2006.09-2012.09	Hatchback Engine N43B20A/N46B20B/N46B20C		○	GWB3682	
120 i (125 kW)	2006.09-2012.09	Hatchback Engine N43B20A/N46B20B/N46B20C	•		GHA400171	K
	2006.09-2012.09	Hatchback Engine N43B20A/N46B20B/N46B20C		○	GHA427011	
	2006.09-2012.09	Hatchback Engine N43B20A/N46B20B/N46B20C		○	GWB3682	
123 D (150 kW)	2007.03-2012.09	Hatchback Engine N47D20B/N47D20D	•		GHA400171	K
	2007.03-2012.09	Hatchback Engine N47D20B/N47D20D		○	GWB6632	
130 i (190 kW)	2006.09-2012.09	Hatchback Engine N52B30A/N52B30B/N52B30BF	•		GHA400171	K
	2006.09-2012.09	Hatchback Engine N52B30A/N52B30B/N52B30BF		○	GWB6632	
130 i (195 kW)	2006.09-2012.09	Hatchback Engine N52B30B/N52B30A/N52B30BF	•		GHA400171	K



	 YEAR		F	R	G-AP Ref.	KIT
BMW						
1 (E81)						
130 i (195 kW)	2006.09-2012.09	Hatchback Engine N52B30B/N52B30A/N52B30BF		o	GWB6632	
1 (E82)						
118 D (100 kW)	2009.09-	Coupe Engine N47D20C	•		GHA400171	K
	2009.09-	Coupe Engine N47D20C		o	GWB3682	
118 D (105 kW)	2009.09-	Coupe Engine N47D20C	•		GHA400171	K
	2009.09-	Coupe Engine N47D20C		o	GWB3682	
120 D (120 kW)	2007.10-	Coupe Engine N47D20A/N47D20C	•		GHA400171	K
	2007.10-	Coupe Engine N47D20A/N47D20C		o	GWB3682	
120 D (130 kW)	2007.10-	Coupe Engine N47D20A/N47D20C	•		GHA400171	K
	2007.10-	Coupe Engine N47D20A/N47D20C		o	GWB3682	
120 i (115 kW)	2009.09-	Coupe Engine N46B20B		o	GWB3682	
120 i (125 kW)	2009.09-	Coupe Engine N43B20A/N46B20B	•		GHA400171	K
	2009.09-	Coupe Engine N43B20A/N46B20B		o	GWB3682	
123 D (150 kW)	2007.10-	Coupe Engine N47D20B/N47D20D	•		GHA400171	K
	2007.10-	Coupe Engine N47D20B/N47D20D		o	GWB6632	
125 i (160 kW)	2008.02-	Coupe Engine N53B30A	•		GHA400171	K
	2008.02-	Coupe Engine N53B30A		o	GWB3682	
135 i (225 kW)	2007.10-	Coupe Engine N54B30A/N55B30A	•		GHA400171	K
	2007.10-	Coupe Engine N54B30A/N55B30A		o	GWB6632	
M 3.0 (250 kW)	2011.04-2012.06	Coupe Engine N54B30A		o	GWB6632	
1 (E87)						
116 D (66 kW)	2011.01-2011.12	Hatchback Engine N47D20C		o	GWB3682	
116 D (85 kW)	2008.12-2012.09	Hatchback Engine N47D20A	•		GHA400171	K
	2008.12-2012.09	Hatchback Engine N47D20A		o	GHA427011	
	2008.12-2012.09	Hatchback Engine N47D20A		o	GWB3682	
116 i (85 kW)	2003.11-2012.09	Hatchback Engine N43B16A/N45B16A	•		GHA400171	K
	2003.11-2012.09	Hatchback Engine N43B16A/N45B16A		o	GHA427011	
	2003.11-2012.09	Hatchback Engine N43B16A/N45B16A		o	GWB3682	
116 i (89 kW)	2007.08-2012.09	Hatchback Engine N43B16A		o	GWB3682	
116 i (90 kW)	2003.11-2012.09	Hatchback Engine N43B16A/N45B16A	•		GHA400171	K
	2003.11-2012.09	Hatchback Engine N43B16A/N45B16A		o	GHA427011	
	2003.11-2012.09	Hatchback Engine N43B16A/N45B16A		o	GWB3682	
	2003.11-2012.09	Hatchback Engine N43B20A	•		GHA400171	K
	2003.11-2012.09	Hatchback Engine N43B20A		o	GHA427011	
	2003.11-2012.09	Hatchback Engine N43B20A		o	GWB3682	
118 D (100 kW)	2003.11-2012.09	Hatchback Engine M47D20(204D4)/N47D20A/N47D20C	•		GHA400171	K
	2003.11-2012.09	Hatchback Engine M47D20(204D4)/N47D20A/N47D20C		o	GWB3682	
118 D (105 kW)	2003.11-2012.09	Hatchback Engine M47D20(204D4)/N47D20A/N47D20C	•		GHA400171	K
	2003.11-2012.09	Hatchback Engine M47D20(204D4)/N47D20A/N47D20C		o	GHA427011	
	2003.11-2012.09	Hatchback Engine M47D20(204D4)/N47D20A/N47D20C		o	GWB3682	
118 D (90 kW)	2003.11-2012.09	Hatchback Engine M47D20(204D4)/N47D20A/N47D20C	•		GHA400171	K
	2003.11-2012.09	Hatchback Engine M47D20(204D4)/N47D20A/N47D20C		o	GHA427011	
	2003.11-2012.09	Hatchback Engine M47D20(204D4)/N47D20A/N47D20C		o	GWB3682	
118 i (100 kW)	2004.07-2012.09	Hatchback Engine N43 B20 A		o	GHA427011	
	2004.07-2012.09	Hatchback Engine N43 B20 A		o	GWB3682	
118 i (105 kW)	2004.07-2012.09	Hatchback Engine N43B20A/N46B20B	•		GHA400171	K
	2004.07-2012.09	Hatchback Engine N43B20A/N46B20B		o	GHA427011	
	2004.07-2012.09	Hatchback Engine N43B20A/N46B20B		o	GWB3682	
118 i (125 kW)	2007.03-2007.12	Hatchback Engine N43 B20 A		o	GWB3682	
118 i (95 kW)	2004.07-2012.09	Hatchback Engine N43B20A/N46B20B	•		GHA400171	K
	2004.07-2012.09	Hatchback Engine N43B20A/N46B20B		o	GHA427011	
	2004.07-2012.09	Hatchback Engine N43B20A/N46B20B		o	GWB3682	
120 D (120 kW)	2003.11-2012.09	Hatchback Engine M47D20(204D4)/N47D20A/N47D20C	•		GHA400171	K
	2003.11-2012.09	Hatchback Engine M47D20(204D4)/N47D20A/N47D20C		o	GHA427011	
	2003.11-2012.09	Hatchback Engine M47D20(204D4)/N47D20A/N47D20C		o	GWB3682	
120 D (130 kW)	2003.11-2012.09	Hatchback Engine M47D20(204D4)/N47D20A/N47D20C	•		GHA400171	K
	2003.11-2012.09	Hatchback Engine M47D20(204D4)/N47D20A/N47D20C		o	GHA427011	
	2003.11-2012.09	Hatchback Engine M47D20(204D4)/N47D20A/N47D20C		o	GWB3682	
120 i (110 kW)	2003.11-2012.09	Hatchback Engine N43B20A/N46B20B/N46B20BD/N46B20C/N46B20CC/N46B20CD	•		GHA400171	K
	2003.11-2012.09	Hatchback Engine N43B20A/N46B20B/N46B20BD/N46B20C/N46B20CC/N46B20CD		o	GHA427011	
	2003.11-2012.09	Hatchback Engine N43B20A/N46B20B/N46B20BD/N46B20C/N46B20CC/N46B20CD		o	GWB3682	
120 i (115 kW)	2003.11-2012.09	Hatchback Engine N43B20A/N46B20A/N46B20BD/N46B20C/N46B20CC/N46B20CD/N46B20B	•		GHA427011	
	2003.11-2012.09	Hatchback Engine N43B20A/N46B20A/N46B20BD/N46B20C/N46B20CC/N46B20CD/N46B20B		o	GWB3682	
120 i (120 kW)	2003.11-2012.09	Hatchback Engine N43B20A/N46B20B/N46B20BD/N46B20C/N46B20CC/N46B20CD	•		GHA400171	K



	 YEAR		F	R	G-AP Ref.	KIT
BMW						
1 (E87)						
120 i (120 kW)	2003.11-2012.09	Hatchback Engine N43B20A/N46B20B/N46B20BD/N46B20C/N46B20CC/N46B20CD		o	GWB3682	
120 i (125 kW)	2003.11-2012.09	Hatchback Engine N43B20A/N46B20B/N46B20BD/N46B20C/N46B20CC/N46B20CD	•		GHA400171	K
	2003.11-2012.09	Hatchback Engine N43B20A/N46B20B/N46B20BD/N46B20C/N46B20CC/N46B20CD		o	GHA427011	
	2003.11-2012.09	Hatchback Engine N43B20A/N46B20B/N46B20BD/N46B20C/N46B20CC/N46B20CD		o	GWB3682	
123 D (150 kW)	2007.03-2012.09	Hatchback Engine N47D20B/N47D20D/N47D20C	•		GHA400171	K
	2007.03-2012.09	Hatchback Engine N47D20B/N47D20D/N47D20C		o	GWB6632	
130 i (190 kW)	2005.03-2012.09	Hatchback Engine N52B30A/N52B30AF/N52B30B/N52B30BF	•		GHA400171	K
	2005.03-2012.09	Hatchback Engine N52B30A/N52B30AF/N52B30B/N52B30BF		o	GWB6632	
130 i (195 kW)	2005.03-2012.09	Hatchback Engine N52B30A/N52B30AF/N52B30B/N52B30BF	•		GHA400171	K
	2005.03-2012.09	Hatchback Engine N52B30A/N52B30AF/N52B30B/N52B30BF		o	GWB6632	
1 (E88)						
118 D (100 kW)	2008.09-	Convertible Engine N47D20A/N47D20C	•		GHA400171	K
	2008.09-	Convertible Engine N47D20A/N47D20C		o	GWB3682	
118 D (105 kW)	2008.09-	Convertible Engine N47D20A/N47D20C	•		GHA400171	K
	2008.09-	Convertible Engine N47D20A/N47D20C		o	GWB3682	
118 i (100 kW)	2008.09-	Convertible Engine N46B20B	•		GHA400171	K
	2008.09-	Convertible Engine N46B20B		o	GWB3682	
118 i (105 kW)	2008.03-	Convertible Engine N43B20A	•		GHA400171	K
	2008.03-	Convertible Engine N43B20A		o	GWB3682	
120 D (120 kW)	2008.03-	Convertible Engine N47D20A/N47D20C	•		GHA400171	K
	2008.03-	Convertible Engine N47D20A/N47D20C		o	GWB3682	
120 D (130 kW)	2008.03-	Convertible Engine N47D20A/N47D20C	•		GHA400171	K
	2008.03-	Convertible Engine N47D20A/N47D20C		o	GWB3682	
120 D (145 kW)	2008.03-	Convertible Engine N47D20C		o	GWB3682	
120 i (115 kW)	2008.03-	Convertible Engine N46B20B/N46B20C		o	GWB3682	
120 i (120 kW)	2008.03-	Convertible Engine N43B20A	•		GHA400171	K
	2008.03-	Convertible Engine N43B20A		o	GWB3682	
120 i (125 kW)	2008.03-	Convertible Engine N43B20A	•		GHA400171	K
	2008.03-	Convertible Engine N43B20A		o	GWB3682	
123 D (150 kW)	2008.09-	Convertible Engine N47D20B/N47D20D	•		GHA400171	K
	2008.09-	Convertible Engine N47D20B/N47D20D		o	GWB6632	
125 i (160 kW)	2008.03-	Convertible Engine N52B30A	•		GHA400171	K
	2008.03-	Convertible Engine N52B30A		o	GWB3682	
135 i (225 kW)	2008.03-	Convertible Engine N54B30A/N55B30A	•		GHA400171	K
	2008.03-	Convertible Engine N54B30A/N55B30A		o	GWB6632	
135 i (240 kW)	2008.03-	Convertible Engine N55B30A		o	GWB6632	
1 (F20)						
114 D (70 kW)	2012.10-	Hatchback Engine N47D16A	•		GHA400314	K
114 i (75 kW)	2011.11-	Hatchback Engine N13B16A	•		GHA400314	K
116 D (85 kW)	2010.12-	Hatchback Engine N47D20C	•		GHA400314	K
	2012.11-	Hatchback Engine N47D16A	•		GHA400314	K
	2015.03-	Hatchback Engine B37 D15 A	•		GHA400314	K
116 i (100 kW)	2010.12-	Hatchback Engine N13B16A	•		GHA400314	K
116 i (80 kW)	2015.03-	Hatchback Engine B38 B15 A	•		GHA400314	K
118 D (100 kW)	2010.12-	Hatchback Engine N47D20C	•		GHA400314	K
118 D (105 kW)	2010.12-	Hatchback Engine N47D20C	•		GHA400314	K
118 D (110 kW)	2015.03-	Hatchback Engine B47 D20 A	•		GHA400314	K
118 i (100 kW)	2015.03-	Hatchback Engine N13 B16 A	•		GHA400314	K
118 i (125 kW)	2010.11-	Hatchback Engine N13B16A	•		GHA400314	K
120 D (120 kW)	2010.12-	Hatchback Engine N47D20C	•		GHA400314	K
120 D (135 kW)	2010.12-	Hatchback Engine N47D20C	•		GHA400314	K
120 D (140 kW)	2015.03-	Hatchback Engine B47 D20 A	•		GHA400314	K
120 D (147 kW)	2011.1-	Hatchback Engine N47D20C	•		GHA400314	K
120 i (130 kW)	2015.03-	Hatchback Engine N13 B16 A	•		GHA400314	K
125 D (155 kW)	2011.8-	Hatchback Engine N47D20D	•		GHA400314	K
125 D (160 kW)	2011.8-	Hatchback Engine N47D20D	•		GHA400314	K
125 D (165 kW)	2015.03-	Hatchback Engine B47 D20 B	•		GHA400314	K
125 i (160 kW)	2011.08-	Hatchback Engine N20B20A	•		GHA400314	K
125 i (175 kW)	2013.3-	Hatchback Engine N20B20A	•		GHA400314	K
M 135 i (235 kW)	2011.11-	Hatchback Engine N20B20A	•		GHA400314	K
M 135 i (240 kW)	2015.03-	Hatchback Engine N55 B30 A	•		GHA400314	K
1 (F21)						
114 D (70 kW)	2012.7-	Hatchback Engine N55B30A	•		GHA400314	K
114 i (75 kW)	2011.12-	Hatchback Engine N13B16A	•		GHA400314	K



	 YEAR		F	R	G-AP Ref.	KIT
BMW						
1 (F21)						
116 D (85 kW)	2011.12-	Hatchback Engine N47D16A	•		GHA400314	K
	2012.1-	Hatchback Engine N47D20C	•		GHA400314	K
	2015.03-	Hatchback Engine B37 D15 A	•		GHA400314	K
116 i (100 kW)	2011.12-	Hatchback Engine N13B16A	•		GHA400314	K
116 i (80 kW)	2015.03-	Hatchback Engine B38 B15 A	•		GHA400314	K
118 D (100 kW)	2011.12-	Hatchback Engine N47D20C	•		GHA400314	K
118 D (105 kW)	2011.12-	Hatchback Engine N47D20C	•		GHA400314	K
118 D (110 kW)	2015.03-	Hatchback Engine B47 D20 A	•		GHA400314	K
118 i (100 kW)	2015.03-	Hatchback Engine N13 B16 A	•		GHA400314	K
118 i (125 kW)	2012.7-	Hatchback Engine N13B16A	•		GHA400314	K
120 D (120 kW)	2012.7-	Hatchback Engine N47D20C	•		GHA400314	K
120 D (135 kW)	2012.7-	Hatchback Engine N47D20C	•		GHA400314	K
120 D (140 kW)	2015.03-	Hatchback Engine B47 D20 A	•		GHA400314	K
120 D (147 kW)	2012.1-	Hatchback Engine N47D20C	•		GHA400314	K
120 i (130 kW)	2015.03-	Hatchback Engine N13 B16 A	•		GHA400314	K
125 D (155 kW)	2011.12-	Hatchback Engine N47D20D	•		GHA400314	K
125 D (160 kW)	2011.12-	Hatchback Engine N47D20D	•		GHA400314	K
125 D (165 kW)	2015.03-	Hatchback Engine B47 D20 B	•		GHA400314	K
125 i (160 kW)	2011.12-	Hatchback Engine N20B20A	•		GHA400314	K
125 i (175 kW)	2013.3-	Hatchback Engine N20B20A	•		GHA400314	K
M 135 i (235 kW)	2011.12-	Hatchback Engine N55B30A	•		GHA400314	K
2 (F22, F87)						
218 D (100 kW)	2015.07-	Coupe Engine B47 D20 A	•		GHA400314	K
218 i (100 kW)	2015.03-	Coupe Engine B38 A15 MO/B38 B15 A	•		GHA400314	K
220 D (120 kW)	2014.11-	Coupe Engine B47 D20 A	•		GHA400314	K
220 D (140 kW)	2014.11-	Coupe Engine B47 D20 A	•		GHA400314	K
2 (F23)						
218 D (100 kW)	2015.07-	Convertible Engine B47 D20 A	•		GHA400314	K
218 D (110 kW)	2015.07-	Convertible Engine B47 D20 A	•		GHA400314	K
218 i (100 kW)	2015.03-	Convertible Engine B38 A15 MO/B38 B15 A	•		GHA400314	K
220 D (120 kW)	2014.11-	Convertible Engine B47 D20 A	•		GHA400314	K
220 D (140 kW)	2014.11-	Convertible Engine B47 D20 A	•		GHA400314	K
225 D (165 kW)	2015.07-	Convertible Engine B47 D20 B	•		GHA400314	K
228 i (180 kW)	2014.11-	Convertible Engine N20 B20 A	•		GHA400314	K
M 235 i (240 kW)	2014.11-	Convertible Engine N55 B30 A	•		GHA400314	K
2 Coupe (F22)						
218 D (105 kW)	2014.1-	Coupe Engine N47D20C	•		GHA400314	K
220 D (135 kW)	2013.10-	Coupe Engine N47D20C	•		GHA400314	K
220 D (147 kW)	2014.3-	Coupe Engine N47D20C	•		GHA400314	K
220 i (135 kW)	2013.10-	Coupe Engine N20B20B	•		GHA400314	K
225 D (160 kW)	2014.1-	Coupe Engine N47D20D	•		GHA400314	K
228 i (180 kW)	2014.7-	Coupe Engine N20B20A/N26B20A	•		GHA400314	K
M 235 i (240 kW)	2013.10-	Coupe Engine N55B30A	•		GHA400314	K
3 (E30)						
318 i (83 kW)	1990.09-1993.10	Convertible Engine M40B18	•		GHA231001	K
	1990.09-1993.10	Convertible Engine M40B18		o	GHA427003	
	1990.09-1993.10	Convertible Engine M40B18		o	GWB1320	
M3 EVO II 2.5 (175 kW)	1990.01-1992.01	Saloon Engine S14B25(EVOII)		o	GWB1320	
3 (E36)						
316 i (73 kW)	1990.09-1993.09	Saloon Engine M40B16		o	GHA427008	
	1990.09-1993.09	Saloon Engine M40B16		o	GWB0001	
	1990.09-1993.09	Saloon Engine M40B16		o	GWB1459	
316 i (75 kW)	1990.09-1993.09	Saloon Engine M40B16/M43B16		o	GWB0001	
	1990.09-1993.09	Saloon Engine M40B16/M43B16		o	GWB1459	
	1993.07-1998.02	Saloon Engine M43B16/M40B16		o	GHA427008	
	1993.07-1998.02	Saloon Engine M43B16/M40B16		o	GWB0001	
	1993.07-1998.02	Saloon Engine M43B16/M40B16		o	GWB1459	
	1993.09-1999.04	Coupe Engine M43B16		o	GHA427008	
	1993.09-1999.04	Coupe Engine M43B16		o	GWB0001	
318 i (83 kW)	1993.09-1999.04	Coupe Engine M43B16		o	GWB1459	
	1990.12-1993.10	Saloon Engine M40B18		o	GHA427008	
	1990.12-1993.10	Saloon Engine M40B18		o	GWB0001	
	1990.12-1993.10	Saloon Engine M40B18		o	GWB1459	



	 YEAR		F	R	G-AP Ref.	KIT
BMW						
3 (E36)						
318 i (85 kW)	1993.10-1998.02	Saloon Engine M43B18		o	GHA427008	
	1993.10-1998.02	Saloon Engine M43B18		o	GWB0001	
	1993.10-1998.02	Saloon Engine M43B18		o	GWB1459	
	1994.01-1999.04	Convertible Engine M43B18		o	GHA427008	
	1994.01-1999.04	Convertible Engine M43B18		o	GWB0001	
	1994.01-1999.04	Convertible Engine M43B18		o	GWB1459	
318 iS (103 kW)	1992.03-1995.10	Coupe Engine M42B18		o	GHA427008	
	1992.03-1995.10	Coupe Engine M42B18		o	GWB0001	
	1992.03-1995.10	Coupe Engine M42B18		o	GWB1459	
	1993.03-1998.02	Saloon Engine M42B18		o	GHA427008	
	1993.03-1998.02	Saloon Engine M42B18		o	GWB0001	
	1993.03-1998.02	Saloon Engine M42B18		o	GWB1459	
	1995.09-1998.02	Saloon Engine M44B19		o	GHA427008	
	1995.09-1998.02	Saloon Engine M44B19		o	GWB0001	
	1995.09-1998.02	Saloon Engine M44B19		o	GWB1459	
	1995.09-1999.04	Coupe Engine M44B19/M44B19(194S1)		o	GHA427008	
	1995.09-1999.04	Coupe Engine M44B19/M44B19(194S1)		o	GWB0001	
	1995.09-1999.04	Coupe Engine M44B19/M44B19(194S1)		o	GWB1459	
318 TDS (66 kW)	1995.01-1998.02	Saloon Engine M41D18(Inter.)		o	GHA427008	
	1995.01-1998.02	Saloon Engine M41D18(Inter.)		o	GWB0001	
	1995.01-1998.02	Saloon Engine M41D18(Inter.)		o	GWB1459	
320 i (110 kW)	1990.09-1998.02	Saloon Engine M50B20/M50B20TU/M52B(206S3)/Vanos/M50B(206S1)/M50B(206S2)/Vanos/M52B20/M50B20(206S1)/M50B20(206S2)		o	GHA427008	
	1990.09-1998.02	Saloon Engine M50B20/M50B20TU/M52B(206S3)/Vanos/M50B(206S1)/M50B(206S2)/Vanos/M52B20/M50B20(206S1)/M50B20(206S2)		o	GWB0001	
	1990.09-1998.02	Saloon Engine M50B20/M50B20TU/M52B(206S3)/Vanos/M50B(206S1)/M50B(206S2)/Vanos/M52B20/M50B20(206S1)/M50B20(206S2)		o	GWB1459	
	1992.03-1999.04	Coupe Engine M52B(206S3)/Vanos/M50B(206S1)/M50B(206S2)/Vanos/M52B20/M50B20/M50B20TU		o	GHA427008	
	1992.03-1999.04	Coupe Engine M52B(206S3)/Vanos/M50B(206S1)/M50B(206S2)/Vanos/M52B20/M50B20/M50B20TU		o	GWB0001	
	1992.03-1999.04	Coupe Engine M52B(206S3)/Vanos/M50B(206S1)/M50B(206S2)/Vanos/M52B20/M50B20/M50B20TU		o	GWB1459	
	1993.12-1999.04	Convertible Engine M52B(206S3)/Vanos/M50B(206S2)/Vanos/M52B20/M50B20/M50B20TU		o	GHA427008	
	1993.12-1999.04	Convertible Engine M52B(206S3)/Vanos/M50B(206S2)/Vanos/M52B20/M50B20/M50B20TU		o	GWB0001	
1993.12-1999.04	Convertible Engine M52B(206S3)/Vanos/M50B(206S2)/Vanos/M52B20/M50B20/M50B20TU		o	GWB1459		
323 i (125 kW)	1995.03-1999.04	Coupe Engine M52B25(Vanos)/M52B25(256S3)		o	GHA427008	
	1995.03-1999.04	Coupe Engine M52B25(Vanos)/M52B25(256S3)		o	GWB0001	
	1995.03-1999.04	Coupe Engine M52B25(Vanos)/M52B25(256S3)		o	GWB1459	
	1995.06-1999.04	Convertible Engine M52B25(Vanos)/M52B25(256S3)		o	GHA427008	
	1995.06-1999.04	Convertible Engine M52B25(Vanos)/M52B25(256S3)		o	GWB0001	
	1995.06-1999.04	Convertible Engine M52B25(Vanos)/M52B25(256S3)		o	GWB1459	
323 i 2.5 (125 kW)	1995.03-1998.02	Saloon Engine M52B25(VANOS)		o	GHA427008	
	1995.03-1998.02	Saloon Engine M52B25(VANOS)		o	GWB0001	
	1995.03-1998.02	Saloon Engine M52B25(VANOS)		o	GWB1459	
325 i (141 kW)	1990.09-1995.09	Saloon Engine M50B25(Vanos)/M50B25/M50B25TU/M50B25(256S1)/M50B25(256S2)		o	GHA427008	
	1990.09-1995.09	Saloon Engine M50B25(Vanos)/M50B25/M50B25TU/M50B25(256S1)/M50B25(256S2)		o	GWB0001	
	1992.03-1999.04	Coupe Engine M50B25TU/M50B25(Vanos)/M50B25/M50B25(256S1)/M50B25(256S2)		o	GHA427008	
	1992.03-1999.04	Coupe Engine M50B25TU/M50B25(Vanos)/M50B25/M50B25(256S1)/M50B25(256S2)		o	GWB0001	
	1993.03-1995.03	Convertible Engine M50B25/M50B25TU		o	GHA427008	
	1993.03-1995.03	Convertible Engine M50B25/M50B25TU		o	GWB0001	
325 TD (85 kW)	1991.09-1998.02	Saloon Engine M51D25		o	GHA427008	
	1991.09-1998.02	Saloon Engine M51D25		o	GWB0001	
	1991.09-1998.02	Saloon Engine M51D25		o	GWB1459	
325 TDS (105 kW)	1993.05-1998.02	Saloon Engine M51D25(Inter.)		o	GHA427008	
	1993.05-1998.02	Saloon Engine M51D25(Inter.)		o	GWB0001	
	1993.05-1998.02	Saloon Engine M51D25(Inter.)		o	GWB1459	
	1993.05-1998.02	Saloon Engine M51D25(Inter.)		o	GWB0001	
328 i (142 kW)	1995.01-1998.02	Saloon Engine M52B28/M52B28TU/M52B28(286S1)		o	GHA427008	
	1995.01-1998.02	Saloon Engine M52B28/M52B28TU/M52B28(286S1)		o	GWB0001	
	1995.01-1999.04	Coupe Engine M52B28/M52B28TU/M52B28(286S1)		o	GHA427008	
	1995.01-1999.04	Coupe Engine M52B28/M52B28TU/M52B28(286S1)		o	GWB0001	
	1995.03-1999.04	Convertible Engine M52B28/M52B28TU/M52B28(286S1)		o	GHA427008	
	1995.03-1999.04	Convertible Engine M52B28/M52B28TU/M52B28(286S1)		o	GWB0001	
M3 3.0 (210 kW)	1992.10-1995.01	Coupe Engine S50B30	•	o	GWB5549	
	1992.10-1995.01	Coupe Engine S50B30		o	GWB3668	
	1994.01-1995.10	Convertible Engine S50B30		o	GWB3668	
	1994.08-1995.09	Saloon Engine S50B30		o	GWB3668	
M3 3.0 (217 kW)	1995.01-1995.10	Coupe Engine S50B30		o	GWB3668	
M3 3.2 (236 kW)	1995.09-1998.02	Saloon Engine S50B32		o	GWB3668	
	1995.10-1999.04	Convertible Engine S50B32		o	GWB3668	



	 YEAR		F	R	G-AP Ref.	KIT
BMW						
3 (E36)						
M3 3.2 (236 kW)	1995.10-1999.04	Coupe Engine S50B32		o	GWB3668	
3 (E46)						
316 Ci (77 kW)	2000.04-	Coupe Engine M43B16(164E3)		o	GHA427008	
	2000.04-	Coupe Engine M43B16(164E3)		o	GWB0001	
316 Ci (85 kW)	2002.06-	Coupe Engine N45B16A		o	GHA427008	
	2002.06-	Coupe Engine N45B16A		o	GWB0001	
316 i (77 kW)	1998.09-2005.02	Saloon Engine M43B19(194E1)		o	GHA427008	
	1998.09-2005.02	Saloon Engine M43B19(194E1)		o	GWB0001	
	2000.04-2005.02	Saloon Engine M43B16/M43B16(164E3)		o	GHA427008	
	2000.04-2005.02	Saloon Engine M43B16/M43B16(164E3)		o	GWB0001	
316 i (85 kW)	2002.02-2005.02	Saloon Engine N42B18/N46B18/N46B18A		o	GHA427008	
	2002.02-2005.02	Saloon Engine N42B18/N46B18/N46B18A		o	GWB0001	
	2002.06-2005.02	Saloon Engine N45B16/N45B16A		o	GHA427008	
	2002.06-2005.02	Saloon Engine N45B16/N45B16A		o	GWB0001	
318 Ci (105 kW)	2001.09-	Convertible Engine N42B20/N46B20A		o	GHA427008	
	2001.09-	Convertible Engine N42B20/N46B20A		o	GWB0001	
	2001.09-	Coupe Engine N42B20/N46B20A		o	GWB0001	
318 Ci (110 kW)	2005.09-2007.02	Convertible Engine N46B20A/N46B20B		o	GHA427008	
	2005.09-2007.02	Convertible Engine N46B20A/N46B20B		o	GWB0001	
	2005.09-2007.02	Coupe Engine N46B20A		o	GWB0001	
318 Ci (87 kW)	1999.11-2001.09	Coupe Engine M43B19		o	GWB0001	
318 D (85 kW)	2001.09-2003.03	Saloon Engine M47204D1/M47D20		o	GWB0001	
	2003.03-2005.02	Saloon Engine M47D20(204D4)		o	GWB0001	
318 i (105 kW)	2001.09-2005.02	Saloon Engine N42B20/N46B20A		o	GHA427008	
	2001.09-2005.02	Saloon Engine N42B20/N46B20A		o	GWB0001	
318 i (87 kW)	1998.02-2001.09	Saloon Engine M43B19/M43B19TU		o	GHA427008	
	1998.02-2001.09	Saloon Engine M43B19/M43B19TU		o	GWB0001	
320 CD (110 kW)	2003.07-2007.02	Coupe Engine M47D20(204D4)		o	GWB0001	
	2004.12-2007.02	Convertible Engine M47D20(204D4)		o	GWB0001	
320 Ci (110 kW)	1999.08-2000.09	Coupe Engine M52B(206S4)		o	GHA427008	
	1999.08-2000.09	Coupe Engine M52B(206S4)		o	GWB0001	
320 Ci (120 kW)	2006.01-2007.12	Convertible Engine M54B22(226S1)		o	GWB0001	
320 Ci (125 kW)	2000.09-	Convertible Engine M54B22(226S1)		o	GHA427008	
	2000.09-	Convertible Engine M54B22(226S1)		o	GWB0001	
	2000.09-	Coupe Engine M54B22(226S1)		o	GHA427008	
	2000.09-	Coupe Engine M54B22(226S1)		o	GWB0001	
320 D (100 kW)	1998.04-2001.09	Saloon Engine M47204D1/M47D20		o	GWB0001	
320 D (110 kW)	2001.09-2005.02	Saloon Engine M47D20(204D4)		o	GWB0001	
320 D (95 kW)	1998.02-2005.04	Saloon Engine M47204D1		o	GWB0001	
320 i (110 kW)	1998.03-2000.09	Saloon Engine M52B(206S3)/VANOS/M52B20		o	GHA427008	
	1998.03-2000.09	Saloon Engine M52B(206S3)/VANOS/M52B20		o	GWB0001	
320 i (125 kW)	2000.09-2005.02	Saloon Engine M54B22(226S1)		o	GHA427008	
	2000.09-2005.02	Saloon Engine M54B22(226S1)		o	GWB0001	
323 Ci (125 kW)	1999.04-2000.09	Coupe Engine M52B25(Vanos)		o	GHA427008	
	1999.04-2000.09	Coupe Engine M52B25(Vanos)		o	GWB0001	
	2000.04-2000.09	Convertible Engine M52B25(Vanos)		o	GHA427008	
	2000.04-2000.09	Convertible Engine M52B25(Vanos)		o	GWB0001	
323 i (125 kW)	1998.03-2000.09	Saloon Engine M52B25(256S4)/M52B25(Vanos)/M52B25TU		o	GHA427008	
	1998.03-2000.09	Saloon Engine M52B25(256S4)/M52B25(Vanos)/M52B25TU		o	GWB0001	
325 Ci (141 kW)	2000.09-	Convertible Engine M54B25(256S5)		o	GHA427008	
	2000.09-	Convertible Engine M54B25(256S5)		o	GWB0001	
	2000.09-	Coupe Engine M54B25(256S5)		o	GHA427008	
	2000.09-	Coupe Engine M54B25(256S5)		o	GWB0001	
325 i (141 kW)	2000.09-2005.02	Saloon Engine M54B25(256S5)		o	GHA427008	
	2000.09-2005.02	Saloon Engine M54B25(256S5)		o	GWB0001	
325 xi (141 kW)	2000.09-2005.02	Saloon Engine M54B25(256S5)	•		GWB3668	
328 Ci (142 kW)	1999.04-2000.06	Coupe Engine M52B28/M52B28(286S2)		o	GHA427008	
	1999.04-2000.06	Coupe Engine M52B28/M52B28(286S2)		o	GWB0001	
328 i (142 kW)	1998.02-2000.06	Saloon Engine M52B28/M52B28(286S2)		o	GHA427008	
	1998.02-2000.06	Saloon Engine M52B28/M52B28(286S2)		o	GWB0001	
330 CD (150 kW)	2004.03-2007.02	Coupe Engine M57D30(306D2)		o	GWB3668	
	2005.08-	Convertible Engine M57D30(306D2)		o	GWB3668	
330 Ci (170 kW)	2000.06-	Convertible Engine M54B30(306S3)		o	GWB3668	
	2000.06-	Coupe Engine M54B30(306S3)		o	GWB3668	



	 YEAR		F	R	G-AP Ref.	KIT
BMW						
3 (E46)						
330 D (135 kW)	1999.10-2005.02	Saloon Engine M57D30/M57306D30(306D1)		o	GWB3668	
330 D (150 kW)	2003.03-2005.02	Saloon Engine M57D30(306D2)		o	GWB3668	
330 i (170 kW)	2000.06-2005.02	Saloon Engine M54B30(306S3)		o	GWB3668	
330 xD (135 kW)	2000.06-2005.02	Saloon Engine M57D30	•		GWB3668	
330 xD (150 kW)	2003.03-2005.02	Saloon Engine M57D30(306D2)	•		GWB3668	
330 xi (170 kW)	2000.06-	Coupe Engine M54306S3	•		GWB3668	
M3 3.2 (252 kW)	2000.10-2007.08	Coupe Engine S54B32(326S4)		o	GWB3668	
	2001.04-	Convertible Engine S54B32(326S4)		o	GWB3668	
M3 3.2 CSL (265 kW)	2003.07-2004.02	Coupe Engine S54N326S4/S54B32		o	GWB3668	
3 (E90)						
316 D (85 kW)	2009.07-2011.12	Saloon Engine N47D20C		o	GWB3682	
316 i (85 kW)	2006.02-2011.12	Saloon Engine N45B16A/N45B16/N45B16TU2	•		GHA400171	K
	2006.02-2011.12	Saloon Engine N45B16A/N45B16/N45B16TU2		o	GHA427011	
	2006.02-2011.12	Saloon Engine N45B16A/N45B16/N45B16TU2		o	GWB3682	
316 i (90 kW)	2007.09-2011.12	Saloon Engine N43B16A	•		GHA400171	K
	2007.09-2011.12	Saloon Engine N43B16A		o	GHA427011	
	2007.09-2011.12	Saloon Engine N43B16A		o	GWB3682	
318 D (100 kW)	2007.07-2011.12	Saloon Engine N47D20C	•		GHA400171	K
	2007.07-2011.12	Saloon Engine N47D20C		o	GWB3682	
318 D (105 kW)	2007.09-2011.12	Saloon Engine N47D20A/N47D20C	•		GHA400171	K
	2007.09-2011.12	Saloon Engine N47D20A/N47D20C		o	GHA427011	
	2007.09-2011.12	Saloon Engine N47D20A/N47D20C		o	GWB3682	
318 D (90 kW)	2005.09-2007.08	Saloon Engine M47N204D4	•		GHA400171	K
	2005.09-2007.08	Saloon Engine M47N204D4		o	GHA427011	
	2005.09-2007.08	Saloon Engine M47N204D4		o	GWB3682	
318 i (100 kW)	2007.06-2011.12	Saloon Engine N43B20A/N46B20B		o	GWB3682	
318 i (105 kW)	2007.09-2011.12	Saloon Engine N43B20A	•		GHA400171	K
	2007.09-2011.12	Saloon Engine N43B20A		o	GHA427011	
	2007.09-2011.12	Saloon Engine N43B20A		o	GWB3682	
318 i (95 kW)	2005.09-2007.08	Saloon Engine N46B20/N46B20B	•		GHA400171	K
	2005.09-2007.08	Saloon Engine N46B20/N46B20B		o	GHA427011	
	2005.09-2007.08	Saloon Engine N46B20/N46B20B		o	GWB3682	
320 D (110 kW)	2005.09-2011.12	Saloon Engine M47N204D4	•		GHA400171	K
	2005.09-2011.12	Saloon Engine M47N204D4		o	GHA427011	
	2005.09-2011.12	Saloon Engine M47N204D4		o	GWB3682	
	2005.09-2011.12	Saloon Engine M47N204D4		o	GWB6632	
320 D (120 kW)	2005.01-2011.12	Saloon Engine N47D20C	•		GHA400171	K
	2005.01-2011.12	Saloon Engine N47D20C		o	GWB3682	
	2005.01-2011.12	Saloon Engine N47D20C		o	GWB6632	
	2005.01-2011.12	Saloon Engine N47D20C		o	GWB6632	
320 D (130 kW)	2007.09-2011.12	Saloon Engine N47D20A/N47D20C	•		GHA400171	K
	2007.09-2011.12	Saloon Engine N47D20A/N47D20C		o	GHA427011	
	2007.09-2011.12	Saloon Engine N47D20A/N47D20C		o	GWB3682	
	2007.09-2011.12	Saloon Engine N47D20A/N47D20C		o	GWB6632	
	2007.09-2011.12	Saloon Engine N47D20A/N47D20C		o	GWB6632	
320 D (135 kW)	2010.01-2011.12	Saloon Engine N47D20C		o	GHA427011	
	2010.01-2011.12	Saloon Engine N47D20C		o	GWB3682	
	2010.01-2011.12	Saloon Engine N47D20C		o	GWB6632	
320 d xDrive (120 kW)	2008.07-2011.12	Saloon Engine N47D20C	•		GWB3574	
	2008.07-2011.12	Saloon Engine N47D20C		o	GWB6632	
320 d xDrive (130 kW)	2008.09-2011.12	Saloon Engine N47D20C	•		GWB3574	
	2008.09-2011.12	Saloon Engine N47D20C		o	GWB6632	
320 d xDrive (135 kW)	2010.01-2011.12	Saloon Engine N47D20C	•		GWB3574	
	2010.01-2011.12	Saloon Engine N47D20C		o	GWB6632	
320 i (110 kW)	2005.01-2007.08	Saloon Engine N46B20B/N46B20A/N46B20C	•		GHA400171	K
	2005.01-2007.08	Saloon Engine N46B20B/N46B20A/N46B20C		o	GHA427011	
	2005.01-2007.08	Saloon Engine N46B20B/N46B20A/N46B20C		o	GWB3682	
320 i (115 kW)	2007.03-2011.12	Saloon Engine N43B20A/N46B20B		o	GWB3682	
320 i (125 kW)	2007.09-2011.12	Saloon Engine N43B20A	•		GHA400171	K
	2007.09-2011.12	Saloon Engine N43B20A		o	GHA427011	
	2007.09-2011.12	Saloon Engine N43B20A		o	GWB3682	
320 Si (127 kW)	2006.03-2006.07	Saloon Engine N45B20A	•		GHA400171	K
	2006.03-2006.07	Saloon Engine N45B20A		o	GWB6632	
320 xD (130 kW)	2007.09-2011.12	Saloon Engine N47D20C	•		GWB3574	
	2007.09-2011.12	Saloon Engine N47D20C		o	GWB6632	



	 YEAR		F	R	G-AP Ref.	KIT
BMW						
3 (E90)						
323 i (130 kW)	2006.04-2011.12	Saloon Engine N52B25A/N52NB25A		o	GHA427011	
	2006.04-2011.12	Saloon Engine N52B25A/N52NB25A		o	GWB3682	
323 i (140 kW)	2008.03-2011.12	Saloon Engine N52 B25 A		o	GWB3682	
325 D (145 kW)	2006.08-2007.08	Saloon Engine M57D30(306D3)	•		GHA400171	K
	2006.08-2007.08	Saloon Engine M57D30(306D3)		o	GWB6632	
325 D (150 kW)	2010.01-2011.12	Saloon Engine N57D30A		o	GWB6632	
325 i (155 kW)	2006.01-	Saloon Engine N52B25A		o	GWB3682	
	2006.01-	Saloon Engine N52B25A		o	GWB6632	
325 i (160 kW)	2005.01-2007.08	Saloon Engine N52B25/N52B25A	•		GHA400171	K
	2005.01-2007.08	Saloon Engine N52B25/N52B25A		o	GHA427011	
	2005.01-2007.08	Saloon Engine N52B25/N52B25A		o	GWB3682	
	2005.01-2007.08	Saloon Engine N52B25/N52B25A		o	GWB6632	
	2007.09-2011.12	Saloon Engine N53B30A/N53B30	•		GHA400171	K
	2007.09-2011.12	Saloon Engine N53B30A/N53B30		o	GHA427011	
	2007.09-2011.12	Saloon Engine N53B30A/N53B30		o	GWB3682	
325 i xDrive (160 kW)	2007.09-2011.12	Saloon Engine N53B30A/N53B30		o	GWB6632	
	2008.09-2011.12	Saloon Engine N53B30A	•		GHA400171	K
	2008.09-2011.12	Saloon Engine N53B30A	•		GWB3574	
	2008.09-2011.12	Saloon Engine N53B30A		o	GWB6632	
325 xi (160 kW)	2005.01-2011.12	Saloon Engine N52B25A	•		GHA400171	K
	2005.01-2011.12	Saloon Engine N52B25A	•		GWB3574	
	2005.01-2011.12	Saloon Engine N52B25A		o	GWB6632	
	2007.09-2011.12	Saloon Engine N53B30A	•		GWB3574	
	2007.09-2011.12	Saloon Engine N53B30A		o	GWB6632	
328 i (171 kW)	2007.03-2011.12	Saloon Engine N51 B30 A		o	GHA427011	
328 i (187 kW)	2005.07-2007.11	Saloon Engine N52N B30 A		o	GHA427011	
	2005.07-2007.11	Saloon Engine N52N B30 A		o	GWB3682	
330 D (170 kW)	2005.09-2007.08	Saloon Engine M57306D3/M57D30TU2	•		GHA400171	K
	2005.09-2007.08	Saloon Engine M57306D3/M57D30TU2		o	GWB6632	
330 D (180 kW)	2008.07-2011.12	Saloon Engine N57D30A/M57N2306D3		o	GWB6632	
330 d xDrive (180 kW)	2009.01-2011.12	Saloon Engine N57D30A	•		GWB3574	
	2009.01-2011.12	Saloon Engine N57D30A		o	GWB6632	
330 i (190 kW)	2005.01-2007.08	Saloon Engine N52B30A/N52B30	•		GHA400171	K
	2005.01-2007.08	Saloon Engine N52B30A/N52B30		o	GWB6632	
330 i (200 kW)	2007.09-2011.12	Saloon Engine N52B30A/N53B30A	•		GHA400171	K
	2007.09-2011.12	Saloon Engine N52B30A/N53B30A		o	GWB6632	
330 i xDrive (200 kW)	2008.09-2011.12	Saloon Engine N53B30A	•		GWB3574	
	2008.09-2011.12	Saloon Engine N53B30A		o	GWB6632	
330 xD (170 kW)	2005.09-2011.12	Saloon Engine M57306D3/M57D30TU2	•		GWB3574	
	2005.09-2011.12	Saloon Engine M57306D3/M57D30TU2		o	GWB6632	
330 xi (190 kW)	2005.01-2011.12	Saloon Engine N52B30A	•		GWB3574	
	2005.01-2011.12	Saloon Engine N52B30A		o	GWB6632	
330 xi (200 kW)	2007.09-2011.12	Saloon Engine N53B30A	•		GWB3574	
	2007.09-2011.12	Saloon Engine N53B30A		o	GWB6632	
335 D (210 kW)	2006.08-2007.08	Saloon Engine M57D30(306D5)	•		GHA400171	K
	2006.08-2007.08	Saloon Engine M57D30(306D5)		o	GWB6632	
335 i (220 kW)	2006.10-2011.12	Saloon Engine N54 B30 A/N55 B30 A		o	GWB6632	
335 i (224 kW)	2011.01-2011.12	Saloon Engine N54 B30 A		o	GWB6632	
335 i (225 kW)	2006.09-2011.12	Saloon Engine N54B30A/N55B30A		o	GWB6632	
335 i xDrive (225 kW)	2008.09-2011.12	Saloon Engine N54B30A/N55B30A	•		GWB3574	
	2008.09-2011.12	Saloon Engine N54B30A/N55B30A		o	GWB6632	
335 xi (224 kW)	2007.09-2008.12	Saloon Engine N54 B30 A	•		GWB3574	
	2007.09-2008.12	Saloon Engine N54 B30 A		o	GWB6632	
335 xi (225 kW)	2007.09-2011.12	Saloon Engine N54B30A/N55B30A	•		GWB3574	
	2007.09-2011.12	Saloon Engine N54B30A/N55B30A		o	GWB6632	
M3 4.0 (309 kW)	2007.03-2011.12	Saloon Engine S65B40A		o	GWB6632	
3 (E92)						
316 i (90 kW)	2007.09-	Coupe Engine N43B16A		o	GHA427011	
	2007.09-	Coupe Engine N43B16A		o	GWB3682	
318 i (105 kW)	2010.03-	Coupe Engine N43B20A		o	GHA427011	
	2010.03-	Coupe Engine N43B20A		o	GWB3682	
320 D (120 kW)	2007.01-	Coupe Engine N47D20C	•		GHA400171	K
	2007.01-	Coupe Engine N47D20C		o	GWB3682	
320 D (130 kW)	2007.03-2007.08	Coupe Engine N47D20A	•		GHA400171	K



	 YEAR		F	R	G-AP Ref.	KIT
BMW						
3 (E92)						
320 D (130 kW)	2007.03-2007.08	Coupe Engine N47D20A		o	GHA427011	
	2007.03-2007.08	Coupe Engine N47D20A		o	GWB3682	
320 D (135 kW)	2010.01-	Coupe Engine N47D20C		o	GHA427011	
	2010.01-	Coupe Engine N47D20C		o	GWB3682	
320 d xDrive (130 kW)	2008.09-	Coupe Engine N47D20C	•		GWB3574	
	2008.09-	Coupe Engine N47D20C		o	GWB6632	
320 d xDrive (135 kW)	2010.01-	Coupe Engine N47D20C	•		GHA400171	K
	2010.01-	Coupe Engine N47D20C	•		GWB3574	
	2010.01-	Coupe Engine N47D20C		o	GWB6632	
320 i (110 kW)	2006.11-2007.06	Coupe Engine N46NB20B/N46B20A	•		GHA400171	K
	2006.11-2007.06	Coupe Engine N46NB20B/N46B20A		o	GHA427011	
	2006.11-2007.06	Coupe Engine N46NB20B/N46B20A		o	GWB3682	
320 i (115 kW)	2007.06-	Coupe Engine N43B20A/N46B20B		o	GWB3682	
320 i (120 kW)	2007.01-	Coupe Engine N43B20A	•		GHA400171	K
	2007.01-	Coupe Engine N43B20A		o	GWB3682	
320 i (125 kW)	2007.03-2007.08	Coupe Engine N43B20A	•		GHA400171	K
	2007.03-2007.08	Coupe Engine N43B20A		o	GHA427011	
	2007.03-2007.08	Coupe Engine N43B20A		o	GWB3682	
320 xD (130 kW)	2007.03-	Coupe Engine N47D20A	•		GWB3574	
	2007.03-	Coupe Engine N47D20A		o	GWB6632	
323 i (130 kW)	2006.06-	Coupe Engine N52NB25A		o	GHA427011	
	2006.06-	Coupe Engine N52NB25A		o	GWB3682	
325 D (145 kW)	2007.03-2007.08	Coupe Engine M57D30(306D3)	•		GHA400171	K
	2007.03-2007.08	Coupe Engine M57D30(306D3)		o	GWB6632	
325 D (150 kW)	2010.04-	Coupe Engine M57N2306D3/N57D30A		o	GWB6632	
325 D (155 kW)	2007.01-2009.12	Coupe Engine M57 D30 (306D3)	•		GHA400171	K
	2007.01-2009.12	Coupe Engine M57 D30 (306D3)		o	GWB6632	
325 i (155 kW)	2006.06-2010.12	Coupe	•		GHA400171	K
	2006.06-2010.12	Coupe		o	GWB3682	
	2007.07-2013.12	Coupe Engine N57 B30 A	•		GHA400171	K
	2007.07-2013.12	Coupe Engine N57 B30 A		o	GWB3682	
325 i (160 kW)	2006.09-	Coupe Engine N52B25A/N52B25C	•		GHA400171	K
	2006.09-	Coupe Engine N52B25A/N52B25C		o	GHA427011	
	2006.09-	Coupe Engine N52B25A/N52B25C		o	GWB3682	
	2007.09-	Coupe Engine N53B30/N53B30A/N51B30A	•		GHA400171	K
	2007.09-	Coupe Engine N53B30/N53B30A/N51B30A		o	GHA427011	
	2007.09-	Coupe Engine N53B30/N53B30A/N51B30A		o	GWB3682	
325 i xDrive (160 kW)	2008.09-	Coupe Engine N51B30A/N53B30A	•		GHA400171	K
	2008.09-	Coupe Engine N51B30A/N53B30A	•		GWB3574	
	2008.09-	Coupe Engine N51B30A/N53B30A		o	GWB6632	
325 xi (160 kW)	2006.09-	Coupe Engine N52B25A/N52B25C	•		GHA400171	K
	2006.09-	Coupe Engine N52B25A/N52B25C	•		GWB3574	
	2006.09-	Coupe Engine N52B25A/N52B25C		o	GWB6632	
	2007.09-	Coupe Engine N53B30A	•		GWB3574	
	2007.09-	Coupe Engine N53B30A		o	GWB6632	
328 i (187 kW)	2006.08-2007.11	Coupe Engine N52N B30 A		o	GWB3682	
330 D (170 kW)	2006.08-2007.08	Coupe Engine M57306D3/M57D30TU2	•		GHA400171	K
	2006.08-2007.08	Coupe Engine M57306D3/M57D30TU2		o	GWB6632	
330 D (180 kW)	2008.07-	Coupe Engine N57D30A/M57N2306D3	•		GHA400171	K
	2008.07-	Coupe Engine N57D30A/M57N2306D3		o	GWB6632	
330 d xDrive (180 kW)	2009.01-	Coupe Engine N57D30A	•		GHA400171	K
	2009.01-	Coupe Engine N57D30A	•		GWB3574	
	2009.01-	Coupe Engine N57D30A		o	GWB6632	
330 i (190 kW)	2006.09-2013.12	Coupe Engine N52 B30 A		o	GWB6632	
330 i (200 kW)	2006.08-2007.08	Coupe Engine N52B30A/N53B30A	•		GHA400171	K
	2006.08-2007.08	Coupe Engine N52B30A/N53B30A		o	GWB6632	
330 i xDrive (200 kW)	2008.09-	Coupe Engine N53B30A	•		GHA400171	K
	2008.09-	Coupe Engine N53B30A	•		GWB3574	
	2008.09-	Coupe Engine N53B30A		o	GWB6632	
330 xD (170 kW)	2006.09-	Coupe Engine M57306D3/M57D30TU2	•		GWB3574	
	2006.09-	Coupe Engine M57306D3/M57D30TU2		o	GWB6632	
330 xD (180 kW)	2009.01-	Coupe Engine M57N2306D3/N57D30A	•		GWB3574	
	2009.01-	Coupe Engine M57N2306D3/N57D30A		o	GWB6632	
330 xi (190 kW)	2006.09-	Coupe Engine N52B30A	•		GWB3574	



	 YEAR		F	R	G-AP Ref.	KIT
BMW						
3 (E92)						
330 xi (190 kW)	2006.09-	Coupe Engine N52B30A		o	GWB6632	
330 xi (200 kW)	2006.09-	Coupe Engine N52B30A/N53B30A	•		GWB3574	
	2006.09-	Coupe Engine N52B30A/N53B30A		o	GWB6632	
335 D (210 kW)	2006.08-2007.08	Coupe Engine M57D(306D5)	•		GHA400171	K
	2006.08-2007.08	Coupe Engine M57D(306D5)		o	GWB6632	
335 i (225 kW)	2006.09-	Coupe Engine N54B30A/N55B30A	•		GHA400171	K
	2006.09-	Coupe Engine N54B30A/N55B30A		o	GWB6632	
335 i xDrive (225 kW)	2008.09-	Coupe Engine N54B30A/N55B30A	•		GHA400171	K
	2008.09-	Coupe Engine N54B30A/N55B30A	•		GWB3574	
	2008.09-	Coupe Engine N54B30A/N55B30A		o	GWB6632	
335 xi (225 kW)	2007.09-	Coupe Engine N54B30A/N55B30A	•		GWB3574	
	2007.09-	Coupe Engine N54B30A/N55B30A		o	GWB6632	
M 4.0 (309 kW)	2007.04-2007.08	Coupe Engine S65B40A		o	GWB6632	
M GTS (331 kW)	2007.03-	Coupe Engine S65B44A		o	GWB6632	
3 (E93)						
318 i (105 kW)	2010.03-	Convertible Engine N43B20A		o	GHA427011	
	2010.03-	Convertible Engine N43B20A		o	GWB3682	
320 D (120 kW)	2008.01-	Convertible Engine N47D20C	•		GHA400171	K
	2008.01-	Convertible Engine N47D20C		o	GWB6632	
320 D (130 kW)	2008.03-	Convertible Engine N47D20A/N47D20C	•		GHA400171	K
	2008.03-	Convertible Engine N47D20A/N47D20C		o	GWB6632	
320 D (135 kW)	2010.01-	Convertible Engine N47D20C		o	GWB6632	
320 i (110 kW)	2007.03-2007.08	Convertible Engine N46NB20B/N46B20		o	GHA427011	
	2007.03-2007.08	Convertible Engine N46NB20B/N46B20		o	GWB3682	
	2007.03-2007.08	Convertible Engine N46NB20B/N46B20		o	GWB6632	
320 i (115 kW)	2007.03-	Convertible Engine N43B20A/N46B20B		o	GWB3682	
	2007.03-	Convertible Engine N43B20A/N46B20B		o	GWB6632	
320 i (120 kW)	2007.01-	Convertible Engine N43B20A	•		GHA400171	K
	2007.01-	Convertible Engine N43B20A		o	GWB3682	
	2007.01-	Convertible Engine N43B20A		o	GWB6632	
320 i (125 kW)	2007.03-2007.08	Convertible Engine N43B20A	•		GHA400171	K
	2007.03-2007.08	Convertible Engine N43B20A		o	GHA427011	
	2007.03-2007.08	Convertible Engine N43B20A		o	GWB3682	
	2007.03-2007.08	Convertible Engine N43B20A		o	GWB6632	
325 D (145 kW)	2007.03-	Convertible Engine N57D30(306D3)	•		GHA400171	K
	2007.03-	Convertible Engine N57D30(306D3)		o	GWB6632	
325 D (150 kW)	2010.02-	Convertible Engine N57D30A		o	GWB6632	
325 D (155 kW)	2007.01-2009.12	Convertible Engine M57D30(306D3)	•		GHA400171	K
	2007.01-2009.12	Convertible Engine M57D30(306D3)		o	GWB6632	
325 i (155 kW)	2006.10-2013.12	Convertible Engine N53 B30 A	•		GHA400171	K
	2006.10-2013.12	Convertible Engine N53 B30 A		o	GWB6632	
325 i (160 kW)	2007.03-	Convertible Engine N52B25/N52B25A	•		GHA400171	K
	2007.03-	Convertible Engine N52B25/N52B25A		o	GWB6632	
	2007.03-	Convertible Engine N53B30/N53B30A/N51B30A	•		GHA400171	K
	2007.03-	Convertible Engine N53B30/N53B30A/N51B30A		o	GWB6632	
330 D (170 kW)	2007.03-2007.08	Convertible Engine N57D30(306D3)	•		GHA400171	K
	2007.03-2007.08	Convertible Engine N57D30(306D3)		o	GWB6632	
330 D (180 kW)	2009.01-	Convertible Engine N57D30A/N57N2306D3	•		GHA400171	K
	2009.01-	Convertible Engine N57D30A/N57N2306D3		o	GWB6632	
330 i (190 kW)	2007.03-2013.12	Convertible Engine N52 B30 A		o	GWB6632	
330 i (200 kW)	2007.03-2007.08	Convertible Engine N52B30A/N53B30A	•		GHA400171	K
	2007.03-2007.08	Convertible Engine N52B30A/N53B30A		o	GWB6632	
335 i (225 kW)	2007.03-	Convertible Engine N54B30A/N54B30B/N55B30A	•		GHA400171	K
	2007.03-	Convertible Engine N54B30A/N54B30B/N55B30A		o	GWB6632	
M3 (309 kW)	2007.03-	Convertible Engine S65B40A		o	GWB6632	
3 (F30, F35, F80)						
316 D (85 kW)	2012.02-	Saloon Engine N47D20C	•		GHA400314	K
316 i (100 kW)	2012.10-	Saloon Engine N13B16A	•		GHA400314	K
318 D (100 kW)	2012.02-	Saloon Engine N47 D20 C	•		GHA400314	K
318 D (105 kW)	2012.02-	Saloon Engine N47D20C	•		GHA400314	K
318 d xDrive (105 kW)	2012.11-	Saloon Engine N47D20C		o	GWB7016	
320 D (120 kW)	2011.10-	Saloon Engine N47D20C	•		GHA400314	K
320 D (135 kW)	2011.10-	Saloon Engine N47D20C	•		GHA400314	K
320 D (147 kW)	2012.2-	Saloon Engine N47D20C	•		GHA400314	K



	 YEAR		F	R	G-AP Ref.	KIT
BMW						
3 (F30, F35, F80)						
320 d xDrive (120 kW)	2012.5-	Saloon Engine N47D20C		o	GWB7016	
320 d xDrive (135 kW)	2011.10-	Saloon Engine N47D20C		o	GWB7016	
320 d xDrive (147 kW)	2012.05-	Saloon Engine N47 D20 C		o	GWB7016	
320 i (125 kW)	2012.2-	Saloon Engine N13B16A	•		GHA400314	K
320 i (135 kW)	2012.02-	Saloon Engine N20B20A	•		GHA400314	K
320 i xDrive (135 kW)	2011.11-	Saloon Engine N20B20A		o	GWB7016	
325 D (155 kW)	2011.10-	Saloon Engine N47 D20 D	•		GHA400314	K
	2011.10-	Saloon Engine N47 D20 D		o	GWB7016	
325 D (160 kW)	2011.10-	Saloon Engine N47D20D	•		GHA400314	K
328 i (180 kW)	2011.10-	Saloon Engine N26B20A/N20B20A	•		GHA400314	K
	2011.10-	Saloon Engine N26B20A/N20B20A		o	GWB7016	
328 i xDrive (180 kW)	2011.10-	Saloon Engine N20B20A		o	GWB7016	
330 D (190 kW)	2012.1-	Saloon Engine N57D30A	•		GHA400314	K
	2012.1-	Saloon Engine N57D30A		o	GWB7016	
330 D (210 kW)	2015.09-	Saloon Engine N57 D30 A	•		GHA400314	K
	2015.09-	Saloon Engine N57 D30 A		o	GWB7016	
330 d xDrive (190 kW)	2013.3-	Saloon Engine N57D30A		o	GWB7016	
330 d xDrive (210 kW)	2015.09-	Saloon Engine N57 D30 A		o	GWB7016	
330 e (135 kW)	2016.01-	Saloon Engine B48 B20 A	•		GHA400314	K
	2016.01-	Saloon Engine B48 B20 A		o	GWB7016	
330 e (185 kW)	2016.01-	Saloon Engine B48 B20 A	•		GHA400314	K
	2016.01-	Saloon Engine B48 B20 A		o	GWB7016	
330 i xDrive (185 kW)	2015.07-	Saloon Engine N48 B20 A		o	GWB7016	
335 d xDrive (230 kW)	2013.7-	Saloon Engine N57D30B		o	GWB7016	
335 i (225 kW)	2011.10-	Saloon Engine N55B30A	•		GHA400314	K
	2011.10-	Saloon Engine N55B30A		o	GWB7016	
335 i (240 kW)	2011.10-2013.07	Saloon Engine N55 B30 A	•		GHA400314	K
	2011.10-2013.07	Saloon Engine N55 B30 A		o	GWB7016	
335 i (250 kW)	2013.07-	Saloon Engine N55 B30 A	•		GHA400314	K
	2013.07-	Saloon Engine N55 B30 A		o	GWB7016	
335 i xDrive (225 kW)	2011.10-	Saloon Engine N55B30A		o	GWB7016	
335 i xDrive (240 kW)	2011.10-2013.07	Saloon Engine N55 B30 A		o	GWB7016	
335 i xDrive (250 kW)	2013.07-	Saloon Engine N55 B30 A		o	GWB7016	
ActiveHybrid (225 kW)	2012.7-	Saloon Engine N55B30A	•		GHA400314	K
	2012.7-	Saloon Engine N55B30A		o	GWB7016	
ActiveHybrid (250 kW)	2012.1-	Saloon Engine N55B30A	•		GHA400314	K
	2012.1-	Saloon Engine N55B30A		o	GWB7016	
3 COMPACT (E36)						
316 G (75 kW)	1994.03-2000.08	Hatchback Engine M43B16		o	GWB3446	
316 i (75 kW)	1994.03-2000.08	Hatchback Engine M43B16		o	GWB3446	
316 i (77 kW)	1998.12-2000.08	Hatchback Engine M43B19(19E1)		o	GWB3446	
318 TDS (66 kW)	1995.01-2000.08	Hatchback Engine M41D18(Inter.)		o	GWB3446	
318 TI (103 kW)	1994.11-1995.08	Hatchback Engine M42B18		o	GWB3446	
	1995.07-2000.08	Hatchback Engine M44B19		o	GWB3446	
323 TI (125 kW)	1997.08-2000.08	Hatchback Engine M52B25(VANOS)		o	GWB1320	
3 COMPACT (E46)						
316 TI (77 kW)	2002.06-2005.02	Hatchback		o	GWB0001	
316 TI (85 kW)	2001.06-2005.02	Hatchback Engine N42B18/N46B18A		o	GWB0001	
	2002.06-2005.02	Hatchback Engine N40B16A/N45B16A		o	GWB0001	
318 TD (85 kW)	2003.03-2005.02	Hatchback Engine M47D20(204D4)		o	GWB0001	
318 TI (105 kW)	2001.09-2005.02	Hatchback Engine N42B20/N46B20A		o	GWB0001	
320 TD (100 kW)	2001.10-2002.12	Hatchback Engine M47 D20 (204D1)		o	GWB0001	
320 TD (110 kW)	2001.09-2005.02	Hatchback Engine M47D20(204D4)		o	GWB0001	
325 TI (141 kW)	2001.06-2005.02	Hatchback Engine M54B25(256S5)		o	GWB0001	
3 GRAN TURISMO (F34)						
318 D (100 kW)	2013.03-	Hatchback Engine N47 D20 C	•		GHA400314	K
	2013.03-	Hatchback Engine N47 D20 C		o	GWB7016	
318 D (105 kW)	2013.3-	Hatchback Engine N47D20C	•		GHA400314	K
	2013.3-	Hatchback Engine N47D20C		o	GWB7016	
318 D (110 kW)	2015.07-	Hatchback Engine B47 D20 A	•		GHA400314	K
	2015.07-	Hatchback Engine B47 D20 A		o	GWB7016	
320 D (120 kW)	2013.3-	Hatchback Engine	•		GHA400314	K
	2013.3-	Hatchback Engine		o	GWB7016	
320 D (135 kW)	2013.3-	Hatchback Engine N47D20C	•		GHA400314	K



	 YEAR		F	R	G-AP Ref.	KIT
BMW						
3 GRAN TURISMO (F34)						
320 D (135 kW)	2013.3-	Hatchback Engine N47D20C		o	GWB7016	
320 D (140 kW)	2015.07-	Hatchback Engine B47 D20 A	•		GHA400314	K
	2015.07-	Hatchback Engine B47 D20 A		o	GWB7016	
320 D (147 kW)	2013.05-	Hatchback Engine N47 D20 C	•		GHA400314	K
	2013.05-	Hatchback Engine N47 D20 C		o	GWB7016	
320 d xDrive (120 kW)	2013.03-	Hatchback Engine N47 D20 C		o	GWB7016	
320 d xDrive (135 kW)	2013.3-	Hatchback Engine N47D20C		o	GWB7016	
320 d xDrive (140 kW)	2015.07-	Hatchback Engine B47 D20 A		o	GWB7016	
320 d xDrive (147 kW)	2013.05-	Hatchback Engine N47 D20 C		o	GWB7016	
320 i (120 kW)	2013.03-	Hatchback Engine N20 B20 A/N20 B20 B	•		GHA400314	K
	2013.03-	Hatchback Engine N20 B20 A/N20 B20 B		o	GWB7016	
320 i (135 kW)	2013.3-	Hatchback Engine N20B20A/N20B20B	•		GHA400314	K
	2013.3-	Hatchback Engine N20B20A/N20B20B		o	GWB7016	
320 i xDrive (120 kW)	2013.03-	Hatchback Engine N20 B20 A/N20 B20 B		o	GWB7016	
320 i xDrive (135 kW)	2013.3-	Hatchback Engine N20B20A/N20B20B		o	GWB7016	
325 D (155 kW)	2013.7-	Hatchback Engine N47D20D	•		GHA400314	K
	2013.7-	Hatchback Engine N47D20D		o	GWB7016	
325 D (160 kW)	2013.3-	Hatchback Engine N47D20D	•		GHA400314	K
	2013.3-	Hatchback Engine N47D20D		o	GWB7016	
328 i (180 kW)	2013.3-	Hatchback Engine N20B20A	•		GHA400314	K
	2013.3-	Hatchback Engine N20B20A		o	GWB7016	
328 i xDrive (180 kW)	2013.3-	Hatchback Engine N20B20A		o	GWB7016	
330 D (190 kW)	2014.1-	Hatchback Engine N57D30A	•		GHA400314	K
	2014.1-	Hatchback Engine N57D30A		o	GWB7016	
330 D (210 kW)	2014.01-	Hatchback Engine N57 D30 A	•		GHA400314	K
	2014.01-	Hatchback Engine N57 D30 A		o	GWB7016	
330 d xDrive (190 kW)	2014.01-	Hatchback Engine N57 D30 A		o	GWB7016	
330 d xDrive (210 kW)	2014.01-	Hatchback Engine N57 D30 A		o	GWB7016	
335 d xDrive (230 kW)	2014.01-	Hatchback Engine N57 D30 B		o	GWB7016	
335 i (225 kW)	2013.3-	Hatchback Engine N55B30A	•		GHA400314	K
	2013.3-	Hatchback Engine N55B30A		o	GWB7016	
335 i (240 kW)	2013.03-2014.03	Hatchback Engine N55 B30 A	•		GHA400314	K
	2013.03-2014.03	Hatchback Engine N55 B30 A		o	GWB7016	
335 i (250 kW)	2013.07-	Hatchback Engine N55 B30 A	•		GHA400314	K
	2013.07-	Hatchback Engine N55 B30 A		o	GWB7016	
335 i xDrive (225 kW)	2013.3-	Hatchback Engine N55B30A		o	GWB7016	
335 i xDrive (240 kW)	2013.03-2014.03	Hatchback Engine N55 B30 A		o	GWB7016	
335 i xDrive (250 kW)	2014.03-	Hatchback Engine N55 B30 A		o	GWB7016	
3 TOURING (E30)						
316 i (73 kW)	1991.09-1994.06	Estate Engine M40B16	•		GHA231001	K
	1991.09-1994.06	Estate Engine M40B16		o	GHA427003	
	1991.09-1994.06	Estate Engine M40B16		o	GWB1320	
316 i (75 kW)	1991.09-1994.06	Estate Engine M40B16	•		GHA231001	K
	1991.09-1994.06	Estate Engine M40B16		o	GHA427003	
	1991.09-1994.06	Estate Engine M40B16		o	GWB1320	
3 TOURING (E36)						
	1996.01-1999.10	Estate Engine M43B16		o	GHA427008	
	1996.01-1999.10	Estate Engine M43B16		o	GWB0001	
	1996.01-1999.10	Estate Engine M43B16		o	GWB1459	
318 i (85 kW)	1995.07-1999.10	Estate Engine M43B18		o	GHA427008	
	1995.07-1999.10	Estate Engine M43B18		o	GWB0001	
	1995.07-1999.10	Estate Engine M43B18		o	GWB1459	
318 TDS (66 kW)	1995.01-1999.10	Estate Engine M41D18(Inter.)		o	GHA427008	
	1995.01-1999.10	Estate Engine M41D18(Inter.)		o	GWB0001	
	1995.01-1999.10	Estate Engine M41D18(Inter.)		o	GWB1459	
320 i (110 kW)	1995.01-1999.10	Estate Engine M52B20/M50B20/M50B20TU/M52B(206S3)Vanos		o	GHA427008	
	1995.01-1999.10	Estate Engine M52B20/M50B20/M50B20TU/M52B(206S3)Vanos		o	GWB0001	
	1995.01-1999.10	Estate Engine M52B20/M50B20/M50B20TU/M52B(206S3)Vanos		o	GWB1459	
323 i (125 kW)	1995.09-1999.10	Estate Engine M52B25(Vanos)		o	GHA427008	
	1995.09-1999.10	Estate Engine M52B25(Vanos)		o	GWB0001	
	1995.09-1999.10	Estate Engine M52B25(Vanos)		o	GWB1459	
325 TDS (105 kW)	1995.01-1999.10	Estate Engine M51D25(Inter.)		o	GHA427008	
	1995.01-1999.10	Estate Engine M51D25(Inter.)		o	GWB0001	
	1995.01-1999.10	Estate Engine M51D25(Inter.)		o	GWB1459	



	 YEAR		F	R	G-AP Ref.	KIT
BMW						
3 TOURING (E36)						
328 i (142 kW)	1995.01-1999.10	Estate Engine M52B28TU/M52B28/M52B28(286S1)		o	GHA427008	
	1995.01-1999.10	Estate Engine M52B28TU/M52B28/M52B28(286S1)		o	GWB0001	
3 TOURING (E46)						
316 i (85 kW)	2002.03-2005.02	Estate Engine N42B18/N46B18/N46B18A		o	GHA427008	
	2002.03-2005.02	Estate Engine N42B18/N46B18/N46B18A		o	GWB0001	
	2002.06-2005.02	Estate Engine N45B16/N45B16A		o	GHA427008	
	2002.06-2005.02	Estate Engine N45B16/N45B16A		o	GWB0001	
318 D (85 kW)	2002.03-2005.02	Estate Engine M47204D1/M47D20		o	GWB0001	
	2003.03-2005.02	Estate Engine M47D20(204D4)		o	GWB0001	
318 i (105 kW)	2001.09-2005.02	Estate Engine N42B20/N46B20/N46B20A		o	GHA427008	
	2001.09-2005.02	Estate Engine N42B20/N46B20/N46B20A		o	GWB0001	
318 i (85 kW)	1999.10-2001.09	Estate Engine M43B19(194E1)		o	GWB0001	
318 i (87 kW)	1999.10-2001.09	Estate Engine M43B19/M43B19TU		o	GHA427008	
	1999.10-2001.09	Estate Engine M43B19/M43B19TU		o	GWB0001	
320 D (100 kW)	2000.03-2001.09	Estate Engine M47204D1/M47D20		o	GWB0001	
320 D (110 kW)	2001.09-2005.02	Estate Engine M47D20(204D4)		o	GWB0001	
320 i (110 kW)	1999.10-2000.09	Estate Engine M52B(206S3)Vanos/M52B20		o	GHA427008	
	1999.10-2000.09	Estate Engine M52B(206S3)Vanos/M52B20		o	GWB0001	
320 i (125 kW)	2000.09-2005.02	Estate Engine M54B22(226S1)		o	GHA427008	
	2000.09-2005.02	Estate Engine M54B22(226S1)		o	GWB0001	
325 i (141 kW)	2000.09-2005.02	Estate Engine M54B25(256S5)		o	GWB0001	
325 xi (141 kW)	2000.09-2005.02	Estate Engine M54B25(256S5)	•		GWB3668	
328 i (142 kW)	1999.10-2000.06	Estate Engine M52B28/M52B28(286S2)		o	GHA427008	
	1999.10-2000.06	Estate Engine M52B28/M52B28(286S2)		o	GWB0001	
330 D (135 kW)	1999.10-2005.02	Estate Engine M57D30/M57D30(306D1)		o	GWB3668	
330 D (150 kW)	2003.03-2005.02	Estate Engine M57D30(306D2)		o	GWB3668	
330 i (170 kW)	2000.06-2005.02	Estate Engine M54B30(306S3)		o	GWB3668	
330 xD (135 kW)	2000.06-2005.02	Estate Engine M57D30	•		GWB3668	
330 xD (150 kW)	2003.03-2005.02	Estate Engine M57D30(306D2)	•		GWB3668	
330 xi (170 kW)	2000.06-2005.02	Estate Engine M54B30(306S3)	•		GWB3668	
3 TOURING (E91)						
316 D (85 kW)	2009.09-	Estate Engine N47D20C		o	GWB3682	
	2009.09-	Estate Engine N47D20C		o	GWB6632	
316 i (90 kW)	2008.05-2012.05	Estate Engine N43B16A		o	GWB3682	
	2008.05-2012.05	Estate Engine N43B16A		o	GWB6632	
318 D (100 kW)	2007.07-	Estate Engine N47D20C		o	GWB3682	
	2007.07-	Estate Engine N47D20C		o	GWB6632	
318 D (105 kW)	2007.09-	Estate Engine N47D20A/N47D20C	•		GHA400171	K
	2007.09-	Estate Engine N47D20A/N47D20C		o	GWB3682	
	2007.09-	Estate Engine N47D20A/N47D20C		o	GWB6632	
318 D (90 kW)	2005.09-	Estate Engine M47N204D4	•		GHA400171	K
	2005.09-	Estate Engine M47N204D4		o	GWB3682	
	2005.09-	Estate Engine M47N204D4		o	GWB6632	
318 i (100 kW)	2007.09-	Estate Engine N46B20B/N43B20A		o	GWB3682	
	2007.09-	Estate Engine N46B20B/N43B20A		o	GWB6632	
318 i (105 kW)	2007.09-	Estate Engine N43B20A	•		GHA400171	K
	2007.09-	Estate Engine N43B20A		o	GWB3682	
	2007.09-	Estate Engine N43B20A		o	GWB6632	
318 i (95 kW)	2006.03-2007.08	Estate Engine N46B20/N46B20B	•		GHA400171	K
	2006.03-2007.08	Estate Engine N46B20/N46B20B		o	GWB3682	
	2006.03-2007.08	Estate Engine N46B20/N46B20B		o	GWB6632	
320 D (110 kW)	2005.09-	Estate Engine M47D20(204D4)	•		GHA400171	K
	2005.09-	Estate Engine M47D20(204D4)		o	GWB6632	
320 D (120 kW)	2005.09-	Estate Engine N47D20A/N47D20C/M47D20(204D4)/M47N204D5	•		GHA400171	K
	2005.09-	Estate Engine N47D20A/N47D20C/M47D20(204D4)/M47N204D5		o	GWB3682	
	2005.09-	Estate Engine N47D20A/N47D20C/M47D20(204D4)/M47N204D5		o	GWB6632	
320 D (130 kW)	2007.09-	Estate Engine N47D20A/N47D20C	•		GHA400171	K
	2007.09-	Estate Engine N47D20A/N47D20C		o	GWB3682	
	2007.09-	Estate Engine N47D20A/N47D20C		o	GWB6632	
320 D (135 kW)	2010.01-	Estate Engine N47D20C		o	GWB3682	
	2010.01-	Estate Engine N47D20C		o	GWB6632	
320 d xDrive (120 kW)	2009.07-	Estate Engine N47D20C	•		GWB3574	
	2009.07-	Estate Engine N47D20C		o	GWB6632	
320 d xDrive (130 kW)	2008.09-	Estate Engine N47D20C	•		GWB3574	



	 YEAR		F	R	G-AP Ref.	KIT
BMW						
3 TOURING (E91)						
320 d xDrive (130 kW)	2008.09-	Estate Engine N47D20C		o	GWB6632	
320 d xDrive (135 kW)	2010.01-	Estate Engine N47D20C	•		GHA400171	K
	2010.01-	Estate Engine N47D20C	•		GWB3574	
	2010.01-	Estate Engine N47D20C		o	GWB6632	
320 i (110 kW)	2005.09-2007.08	Estate Engine N46B20A/N46B20C/N46B20	•		GHA400171	K
	2005.09-2007.08	Estate Engine N46B20A/N46B20C/N46B20		o	GWB3682	
	2005.09-2007.08	Estate Engine N46B20A/N46B20C/N46B20		o	GWB6632	
320 i (125 kW)	2007.09-	Estate Engine N43B20A	•		GHA400171	K
	2007.09-	Estate Engine N43B20A		o	GWB3682	
	2007.09-	Estate Engine N43B20A		o	GWB6632	
320 xD (130 kW)	2007.09-	Estate Engine N47D20A	•		GWB3574	
	2007.09-	Estate Engine N47D20A		o	GWB6632	
323 i (130 kW)	2006.04-2007.06	Estate Engine N52NB25A		o	GWB6632	
323 i (140 kW)	2006.09-2008.07	Estate Engine N52 B25 A		o	GWB6632	
325 D (145 kW)	2006.08-2007.08	Estate Engine M57D30(306D3)	•		GHA400171	K
	2006.08-2007.08	Estate Engine M57D30(306D3)		o	GWB6632	
325 D (150 kW)	2010.04-	Estate Engine M57N2306D3/N57D30A		o	GWB6632	
325 i (155 kW)	2012.01-	Estate Engine N53B30A		o	GWB6632	
325 i (160 kW)	2005.09-	Estate Engine N52B25/N52B25A/N52B25C	•		GHA400171	K
	2005.09-	Estate Engine N52B25/N52B25A/N52B25C		o	GWB6632	
	2007.09-	Estate Engine N53B30/N53B30A	•		GHA400171	K
	2007.09-	Estate Engine N53B30/N53B30A		o	GWB6632	
325 i xDrive (160 kW)	2008.09-	Estate Engine N53B30A/N51B30A	•		GHA400171	K
	2008.09-	Estate Engine N53B30A/N51B30A	•		GWB3574	
	2008.09-	Estate Engine N53B30A/N51B30A		o	GWB6632	
325 xi (160 kW)	2005.09-	Estate Engine N52B25C/N52B25A	•		GHA400171	K
	2005.09-	Estate Engine N52B25C/N52B25A	•		GWB3574	
	2005.09-	Estate Engine N52B25C/N52B25A		o	GWB6632	
	2007.09-	Estate Engine N53B30A	•		GWB3574	
	2007.09-	Estate Engine N53B30A		o	GWB6632	
330 D (170 kW)	2005.09-2007.08	Estate Engine M57306D3	•		GHA400171	K
	2005.09-2007.08	Estate Engine M57306D3		o	GWB6632	
330 D (180 kW)	2008.07-	Estate Engine N57D30A/M57N2306D3		o	GWB6632	
330 d xDrive (180 kW)	2009.01-	Estate Engine N57D30A	•		GWB3574	
	2009.01-	Estate Engine N57D30A		o	GWB6632	
330 i (190 kW)	2005.09-2007.08	Estate Engine N52B30/N52B30A	•		GHA400171	K
	2005.09-2007.08	Estate Engine N52B30/N52B30A		o	GWB6632	
330 i (200 kW)	2007.09-	Estate Engine N53B30A/N52B30A	•		GHA400171	K
	2007.09-	Estate Engine N53B30A/N52B30A		o	GWB6632	
330 i xDrive (200 kW)	2008.09-	Estate Engine N53B30A	•		GWB3574	
	2008.09-	Estate Engine N53B30A		o	GWB6632	
330 xD (170 kW)	2005.09-	Estate Engine M57306D3/M57D30TU2	•		GWB3574	
	2005.09-	Estate Engine M57306D3/M57D30TU2		o	GWB6632	
330 xi (190 kW)	2005.09-	Estate Engine N52B30A	•		GWB3574	
	2005.09-	Estate Engine N52B30A		o	GWB6632	
330 xi (200 kW)	2007.09-	Estate Engine N53B30A	•		GWB3574	
	2007.09-	Estate Engine N53B30A		o	GWB6632	
335 D (210 kW)	2006.08-2007.08	Estate Engine M57D30(306D5)	•		GHA400171	K
	2006.08-2007.08	Estate Engine M57D30(306D5)		o	GWB6632	
335 i (225 kW)	2006.09-	Estate Engine N54B30A/N55B30A	•		GHA400171	K
	2006.09-	Estate Engine N54B30A/N55B30A		o	GWB6632	
335 i xDrive (225 kW)	2008.09-	Estate Engine N54B30A/N55B30A	•		GWB3574	
	2008.09-	Estate Engine N54B30A/N55B30A		o	GWB6632	
335 xi (225 kW)	2007.09-	Estate Engine N54B30A/N55B30A	•		GWB3574	
	2007.09-	Estate Engine N54B30A/N55B30A		o	GWB6632	
3 TOURING (F31)						
316 D (85 kW)	2012.6-	Estate Engine N47D20C	•		GHA400314	K
	2012.6-	Estate Engine N47D20C		o	GWB7016	
316 i (100 kW)	2013.3-	Estate Engine N13B16A	•		GHA400314	K
	2013.3-	Estate Engine N13B16A		o	GWB7016	
318 D (100 kW)	2012.06-	Estate Engine N47 D20 C	•		GHA400314	K
	2012.06-	Estate Engine N47 D20 C		o	GWB7016	
318 D (105 kW)	2012.6-	Estate Engine N47D20C	•		GHA400314	K
	2012.6-	Estate Engine N47D20C		o	GWB7016	



	 YEAR		F	R	G-AP Ref.	KIT
BMW						
3 TOURING (F31)						
318 d xDrive (105 kW)	2013.1-	Estate Engine N47D20C		o	GWB7016	
320 D (120 kW)	2012.6-	Estate Engine N47D20C	•		GHA400314	K
	2012.6-	Estate Engine N47D20C		o	GWB7016	
320 D (135 kW)	2012.6-	Estate Engine N47D20C	•		GHA400314	K
	2012.6-	Estate Engine N47D20C		o	GWB7016	
320 D (140 kW)	2015.07-	Estate Engine B47 D20 A	•		GHA400314	K
	2015.07-	Estate Engine B47 D20 A		o	GWB7016	
320 D (147 kW)	2011.10-	Estate Engine N47D20C	•		GHA400314	K
	2011.10-	Estate Engine N47D20C		o	GWB7016	
320 d xDrive (135 kW)	2012.6-	Estate Engine N47D20C		o	GWB7016	
320 d xDrive (140 kW)	2015.07-	Estate Engine B47 D20 A		o	GWB7016	
320 d xDrive (147 kW)	2013.01-	Estate Engine N47 D20 C		o	GWB7016	
320 i (135 kW)	2012.6-	Estate Engine N20B20B	•		GHA400314	K
	2012.6-	Estate Engine N20B20B		o	GWB7016	
	2015.07-	Estate Engine B48 B20 A	•		GHA400314	K
	2015.07-	Estate Engine B48 B20 A		o	GWB7016	
320 i xDrive (135 kW)	2012.6-	Estate Engine N20B20B	•		GWB7016	
325 D (155 kW)	2013.03-	Estate Engine N47 D20 D	•		GHA400314	K
	2013.03-	Estate Engine N47 D20 D		o	GWB7016	
325 D (160 kW)	2013.3-	Estate Engine N47D20D	•		GHA400314	K
	2013.3-	Estate Engine N47D20D		o	GWB7016	
328 i (180 kW)	2012.6-	Estate Engine N20B20A	•		GHA400314	K
	2012.6-	Estate Engine N20B20A		o	GWB7016	
328 i xDrive (180 kW)	2012.6-	Estate Engine N20B20A		o	GWB7016	
330 D (190 kW)	2012.6-	Estate Engine N57D30A	•		GHA400314	K
	2012.6-	Estate Engine N57D30A		o	GWB7016	
330 d xDrive (190 kW)	2012.06-	Estate Engine N57 D30 A		o	GWB7016	
335 d xDrive (230 kW)	2013.09-	Estate Engine N57 D30 B		o	GWB7016	
335 i (225 kW)	2013.3-	Estate Engine N55B30A	•		GHA400314	K
	2013.3-	Estate Engine N55B30A		o	GWB7016	
335 i (240 kW)	2012.01-2013.07	Estate Engine N55 B30 A	•		GHA400314	K
	2012.01-2013.07	Estate Engine N55 B30 A		o	GWB7016	
335 i (250 kW)	2013.07-	Estate Engine N55 B30 A	•		GHA400314	K
	2013.07-	Estate Engine N55 B30 A		o	GWB7016	
335 i xDrive (225 kW)	2013.3-	Estate Engine N55B30A		o	GWB7016	
335 i xDrive (240 kW)	2012.01-2013.07	Estate Engine N55 B30 A		o	GWB7016	
335 i xDrive (250 kW)	2013.07-	Estate Engine N55 B30 A		o	GWB7016	
340 i xDrive (240 kW)	2015.07-	Estate Engine N58 B30 A		o	GWB7016	
340 i xDrive (265 kW)	2015.07-	Estate Engine N58 B30 A		o	GWB7016	
4 (F32, F82)						
418 D (100 kW)	2015.03-	Coupe Engine B47 D20 A	•		GHA400314	K
418 D (110 kW)	2015.03-	Coupe Engine B47 D20 A	•		GHA400314	K
420 D (120 kW)	2013.07-	Coupe Engine B47 D20 A/N47 D20 C	•		GHA400314	K
420 D (140 kW)	2015.03-	Coupe Engine B47 D20 A	•		GHA400314	K
420 D (147 kW)	2013.07-2015.03	Coupe Engine N47 D20 C	•		GHA400314	K
420 d xDrive (120 kW)	2013.11-	Coupe Engine B47 D20 A/N47 D20 C		o	GWB7016	
420 d xDrive (140 kW)	2015.03-	Coupe Engine B47 D20 A		o	GWB7016	
420 d xDrive (147 kW)	2013.11-2015.03	Coupe Engine N47 D20 C		o	GWB7016	
420 i (120 kW)	2013.11-	Coupe Engine N20 B20 A/N20 B20 B	•		GHA400314	K
425 D (155 kW)	2014.01-	Coupe Engine N47 D20 D	•		GHA400314	K
430 d xDrive (190 kW)	2014.01-	Coupe Engine N57 D30 A		o	GWB7016	
430 d xDrive (210 kW)	2013.11-	Coupe Engine N57 D30 A		o	GWB7016	
435 i (250 kW)	2013.07-	Coupe Engine N55 B30 A	•		GHA400314	K
	2013.07-	Coupe Engine N55 B30 A		o	GWB7016	
435 i xDrive (250 kW)	2013.07-	Coupe Engine N55 B30 A		o	GWB7016	
4 (F33, F83)						
420 D (120 kW)	2013.10-	Convertible Engine B47 D20 A/N47 D20 C	•		GHA400314	K
	2013.10-	Convertible Engine B47 D20 A/N47 D20 C		o	GWB7016	
420 D (147 kW)	2013.10-2015.07	Convertible Engine B47 D20 C	•		GHA400314	K
	2013.10-2015.07	Convertible Engine B47 D20 C		o	GWB7016	
420 i (120 kW)	2014.07-	Convertible Engine N20 B20 B	•		GHA400314	K
	2014.07-	Convertible Engine N20 B20 B		o	GWB7016	
425 D (155 kW)	2014.07-	Convertible Engine N47 D20 D	•		GHA400314	K
	2014.07-	Convertible Engine N47 D20 D		o	GWB7016	



	 YEAR		F	R	G-AP Ref.	KIT
BMW						
4 (F33, F83)						
428 i xDrive (180 kW)	2014.01-	Convertible Engine N20 B20 A		o	GWB7016	
430 D (210 kW)	2013.10-	Convertible Engine N57 D30 A	•		GHA400314	K
	2013.10-	Convertible Engine N57 D30 A		o	GWB7016	
435 d xDrive (230 kW)	2014.07-	Convertible Engine N57 D30 B		o	GWB7016	
435 i (250 kW)	2013.10-	Convertible Engine N55 B30 A	•		GWB7016	
435 i xDrive (225 kW)	2014.07-	Convertible Engine N55 B30 A		o	GWB7016	
435 i xDrive (250 kW)	2014.07-	Convertible Engine N55 B30 A		o	GWB7016	
4 Convertible (F33, F83)						
420 D (135 kW)	2013.10-	Convertible Engine N47D20C	•		GHA400314	K
	2013.10-	Convertible Engine N47D20C		o	GWB7016	
420 i (135 kW)	2014.7-	Convertible Engine N20B20B	•		GHA400314	K
	2014.7-	Convertible Engine N20B20B		o	GWB7016	
425 D (160 kW)	2014.7-	Convertible Engine N47D20D	•		GHA400314	K
	2014.7-	Convertible Engine N47D20D		o	GWB7016	
428 i (180 kW)	2013.10-	Convertible Engine N20B20A/N26B20A	•		GHA400314	K
	2013.10-	Convertible Engine N20B20A/N26B20A		o	GWB7016	
430 D (190 kW)	2014.7-	Convertible Engine N57D30A	•		GHA400314	K
	2014.7-	Convertible Engine N57D30A		o	GWB7016	
435 i (225 kW)	2013.10-	Convertible Engine N55B30A	•		GWB7016	
4 Coupe (F32, F82)						
420 D (135 kW)	2013.7-	Convertible Engine N47D20C	•		GHA400314	K
420 d xDrive (135 kW)	2013.11-	Coupe Engine N47D20C		o	GWB7016	
420 i (135 kW)	2013.11-	Coupe Engine N20B20B	•		GHA400314	K
420 i xDrive (135 kW)	2013.11-	Coupe Engine N20B20B		o	GWB7016	
425 D (160 kW)	2014.1-	Coupe Engine N47D20D	•		GHA400314	K
	2014.1-	Coupe Engine N47D20D		o	GWB7016	
428 i (180 kW)	2013.7-	Coupe Engine N20B20A/N26B20A	•		GHA400314	K
	2013.7-	Coupe Engine N20B20A/N26B20A		o	GWB7016	
428 i xDrive (180 kW)	2013.7-	Coupe Engine N20B20A		o	GWB7016	
430 D (190 kW)	2013.11-	Coupe Engine N57D30A	•		GHA400314	K
	2013.11-	Coupe Engine N57D30A		o	GWB7016	
430 D (210 kW)	2013.11-	Coupe Engine N57D30A	•		GHA400314	K
	2013.11-	Coupe Engine N57D30A		o	GWB7016	
435 d xDrive (230 kW)	2013.11-	Coupe Engine N57D30B		o	GWB7016	
435 i (225 kW)	2013.7-	Coupe Engine N55B30A	•		GHA400314	K
	2013.7-	Coupe Engine N55B30A		o	GWB7016	
435 i xDrive (225 kW)	2013.7-	Coupe Engine N55B30A		o	GWB7016	
4 GRAN (F36)						
418 D (100 kW)	2014.03-	Coupe Engine B47 D20 A/N47 D20 C	•		GHA400314	K
	2014.03-	Coupe Engine B47 D20 A/N47 D20 C		o	GWB7016	
420 D (120 kW)	2014.03-	Coupe Engine B47 D20 A/N47 D20 C	•		GHA400314	K
	2014.03-	Coupe Engine B47 D20 A/N47 D20 C		o	GWB7016	
420 D (140 kW)	2015.03-	Coupe Engine B47 D20 A	•		GHA400314	K
	2015.03-	Coupe Engine B47 D20 A		o	GWB7016	
420 D (147 kW)	2014.03-2015.03	Coupe Engine N47 D20 C	•		GHA400314	K
	2014.03-2015.03	Coupe Engine N47 D20 C		o	GWB7016	
420 d xDrive (120 kW)	2014.03-	Coupe Engine B47 D20 A/N47 D20 C		o	GWB7016	
420 d xDrive (135 kW)	2014.03-2015.03	Coupe Engine N47 D20 C		o	GWB7016	
420 d xDrive (140 kW)	2015.03-	Coupe Engine B47 D20 A		o	GWB7016	
420 d xDrive (147 kW)	2014.03-2015.03	Coupe Engine N47 D20 C		o	GWB7016	
420 i (120 kW)	2014.03-	Coupe Engine N20 B20 B	•		GHA400314	K
	2014.03-	Coupe Engine N20 B20 B		o	GWB7016	
420 i xDrive (120 kW)	2014.03-	Coupe Engine N20 B20 A/N20 B20 B		o	GWB7016	
420 i xDrive (135 kW)	2014.07-	Coupe Engine N20 B20 B		o	GWB7016	
428 i xDrive (180 kW)	2014.03-	Coupe Engine N20 B20 A		o	GWB7016	
430 D (210 kW)	2014.07-	Coupe Engine N57 D30 A	•		GHA400314	K
	2014.07-	Coupe Engine N57 D30 A		o	GWB7016	
430 d xDrive (190 kW)	2014.07-	Coupe Engine N57 D30 A		o	GWB7016	
430 d xDrive (210 kW)	2014.07-	Coupe Engine N57 D30 A		o	GWB7016	
435 d xDrive (230 kW)	2014.07-	Coupe Engine N57 D30 B		o	GWB7016	
435 i (250 kW)	2014.03-	Coupe Engine N55 B30 A	•		GHA400314	K
	2014.03-	Coupe Engine N55 B30 A		o	GWB7016	
435 i xDrive (225 kW)	2014.07-	Coupe Engine N55 B30 A		o	GWB7016	
435 i xDrive (250 kW)	2014.07-	Coupe Engine N55 B30 A		o	GWB7016	



	 YEAR		F	R	G-AP Ref.	KIT
BMW						
4 Gran Coupe (F36)						
418 D (105 kW)	2014.3-	Coupe Engine N47D20C	•		GHA400314	K
	2014.3-	Coupe Engine N47D20C		◦	GWB7016	
420 D (135 kW)	2014.3-	Coupe Engine N47D20C	•		GHA400314	K
	2014.3-	Coupe Engine N47D20C		◦	GWB7016	
420 i (135 kW)	2014.3-	Coupe Engine N20B20B	•		GHA400314	K
	2014.3-	Coupe Engine N20B20B		◦	GWB7016	
428 i (180 kW)	2014.3-	Coupe Engine N20B20A	•		GHA400314	K
	2014.3-	Coupe Engine N20B20A		◦	GWB7016	
430 D (190 kW)	2014.7-	Coupe Engine N57D30A	•		GHA400314	K
	2014.7-	Coupe Engine N57D30A		◦	GWB7016	
435 i (225 kW)	2014.3-	Coupe Engine N55B30A	•		GHA400314	K
	2014.3-	Coupe Engine N55B30A		◦	GWB7016	
5 (E34)						
525 TD (85 kW)	1993.04-1995.09	Saloon Engine M51D25	•		GHA237002	K
525 TDS (105 kW)	1991.09-1995.09	Saloon Engine M51D25(Inter.)	•		GHA237001	K
	1991.09-1995.09	Saloon Engine M51D25(Inter.)	•		GHA237002	K
530 i V8 (160 kW)	1992.09-1995.09	Saloon Engine M60B30/M60B30(308S1)	•		GHA237002	K
540 i V8 (210 kW)	1992.09-1995.09	Saloon Engine M60B40/M60B40(408S1)	•		GHA237002	K
5 (E39)						
520 D (100 kW)	2000.02-2003.06	Saloon Engine M47D20/M47204D1	•		GHA400001	K
	2000.02-2003.06	Saloon Engine M47D20/M47204D1		◦	GHA245001	K
520 i (100 kW)	1999.04-2003.06	Saloon Engine M52B(206S3)VANOS	•		GHA400001	K
	1999.04-2003.06	Saloon Engine M52B(206S3)VANOS		◦	GHA245001	K
520 i (110 kW)	1996.01-2000.09	Saloon Engine M52B(206S3)VANOS/M52B(206S4)/M52B20	•		GHA400001	K
	1996.01-2000.09	Saloon Engine M52B(206S3)VANOS/M52B(206S4)/M52B20		◦	GHA245001	K
520 i (125 kW)	2000.09-2003.06	Saloon Engine M54B22	•		GHA400001	K
	2000.09-2003.06	Saloon Engine M54B22		◦	GHA245001	K
523 i (125 kW)	1995.11-2000.09	Saloon Engine M52B25(Vanos)/M52B25TU	•		GHA400001	K
	1995.11-2000.09	Saloon Engine M52B25(Vanos)/M52B25TU		◦	GHA245001	K
525 D (120 kW)	2000.02-2003.06	Saloon Engine M5725(256D1)/M57D25	•		GHA400001	K
	2000.02-2003.06	Saloon Engine M5725(256D1)/M57D25		◦	GHA245001	K
525 i (141 kW)	2000.09-2003.06	Saloon Engine M54256S5/M54B25/M54B25(256S5)	•		GHA400001	K
	2000.09-2003.06	Saloon Engine M54256S5/M54B25/M54B25(256S5)		◦	GHA245001	K
525 TD (85 kW)	1997.01-2003.06	Saloon Engine M51D25	•		GHA400001	K
	1997.01-2003.06	Saloon Engine M51D25		◦	GHA245001	K
525 TDS (105 kW)	1996.01-2003.06	Saloon Engine M51D25(INTER.)	•		GHA400001	K
	1996.01-2003.06	Saloon Engine M51D25(INTER.)		◦	GHA245001	K
528 i (142 kW)	1995.11-2000.09	Saloon Engine M52B28/M52B28TU/M52B28(286S1)/M52B28(286S2)	•		GHA400001	K
	1995.11-2000.09	Saloon Engine M52B28/M52B28TU/M52B28(286S1)/M52B28(286S2)		◦	GHA245001	K
530 D (135 kW)	1998.08-2000.09	Saloon Engine M57D30	•		GHA400001	K
	1998.08-2000.09	Saloon Engine M57D30		◦	GHA245001	K
530 D (142 kW)	2000.09-2003.06	Saloon Engine M57D30	•		GHA400001	K
	2000.09-2003.06	Saloon Engine M57D30		◦	GHA245001	K
530 i (170 kW)	2000.09-2003.06	Saloon Engine M54B30/M54306S3	•		GHA400001	K
	2000.09-2003.06	Saloon Engine M54B30/M54306S3		◦	GHA245001	K
535 i (173 kW)	1996.04-1999.03	Saloon Engine M62B(358S1)/M62B35	•		GHA400001	K
	1996.04-1999.03	Saloon Engine M62B(358S1)/M62B35		◦	GHA245001	K
535 i (180 kW)	1999.04-2003.06	Saloon Engine M62B(358S2)/M62B35TU	•		GHA400001	K
	1999.04-2003.06	Saloon Engine M62B(358S2)/M62B35TU		◦	GHA245001	K
540 i (210 kW)	1996.04-2003.06	Saloon Engine M62B44(448S1)/M62B44(448S2)	•		GHA400001	K
	1996.04-2003.06	Saloon Engine M62B44(448S1)/M62B44(448S2)		◦	GHA245001	K
M 4.9 (294 kW)	1998.10-2003.06	Saloon Engine S38B49/S62B50		◦	GHA245001	K
M5 (230 kW)	1998.09-2003.06	Saloon Engine M70 B50 (5012A)		◦	GHA245001	K
5 (E60)						
520 D (110 kW)	2005.09-2010.03	Saloon Engine M47N204D4	•		GHA400170	K
	2005.09-2010.03	Saloon Engine M47N204D4		◦	GHA245001	K
520 D (120 kW)	2005.09-2007.08	Saloon Engine M47D20(204D4)/N47D20A/N47D20C	•		GHA400170	K
	2005.09-2007.08	Saloon Engine M47D20(204D4)/N47D20A/N47D20C		◦	GHA245001	K
520 D (130 kW)	2007.09-2010.03	Saloon Engine M47D20(204D4)/N47D20A/N47D20C	•		GHA400170	K
	2007.09-2010.03	Saloon Engine M47D20(204D4)/N47D20A/N47D20C		◦	GHA245001	K
520 i (115 kW)	2006.04-2009.12	Saloon Engine N46B20B	•		GHA400170	K
	2006.04-2009.12	Saloon Engine N46B20B		◦	GHA245001	K
520 i (120 kW)	2006.12-2010.03	Saloon Engine N43 B20 A	•		GHA400170	K
	2006.12-2010.03	Saloon Engine N43 B20 A		◦	GHA245001	K



	 YEAR		F	R	G-AP Ref.	KIT
BMW						
5 (E60)						
520 i (125 kW)	2003.07-2010.03	Saloon Engine M54B22(226S1)	•		GHA400170	K
	2003.07-2010.03	Saloon Engine M54B22(226S1)		◦	GHA245001	K
	2007.09-2010.03	Saloon Engine N43B20A	•		GHA400170	K
	2007.09-2010.03	Saloon Engine N43B20A		◦	GHA245001	K
523 i (130 kW)	2005.01-2007.02	Saloon Engine N52B25/N52B25A	•		GHA400170	K
	2005.01-2007.02	Saloon Engine N52B25/N52B25A		◦	GHA245001	K
523 i (140 kW)	2007.03-2007.08	Saloon Engine N52B25A/N53B25A	•		GHA400170	K
	2007.03-2007.08	Saloon Engine N52B25A/N53B25A		◦	GHA245001	K
525 D (120 kW)	2004.12-2010.03	Saloon Engine M57D(256D1)	•		GHA400170	K
	2004.12-2010.03	Saloon Engine M57D(256D1)		◦	GHA245001	K
525 D (130 kW)	2004.03-2007.02	Saloon Engine M57N256D4/M57D25TU	•		GHA400170	K
	2004.03-2007.02	Saloon Engine M57N256D4/M57D25TU		◦	GHA245001	K
525 D (145 kW)	2007.03-2007.08	Saloon Engine M57306D3	•		GHA400170	K
	2007.03-2007.08	Saloon Engine M57306D3		◦	GHA245001	K
525 d xDrive (145 kW)	2008.09-2010.03	Saloon Engine M57D30(306D3)	•		GWB3574	
	2008.09-2010.03	Saloon Engine M57D30(306D3)		◦	GHA245001	K
525 i (141 kW)	2003.08-2005.01	Saloon Engine M54B25(256S5)	•		GHA400170	K
	2003.08-2005.01	Saloon Engine M54B25(256S5)		◦	GHA245001	K
525 i (160 kW)	2005.01-2007.08	Saloon Engine N52B25A/N52B25	•		GHA400170	K
	2005.01-2007.08	Saloon Engine N52B25A/N52B25		◦	GHA245001	K
	2007.01-2010.03	Saloon Engine N53B30A/N53B30	•		GHA400170	K
	2007.01-2010.03	Saloon Engine N53B30A/N53B30		◦	GHA245001	K
525 i xDrive (160 kW)	2008.09-2010.03	Saloon Engine N53B30A	•		GWB3574	
	2008.09-2010.03	Saloon Engine N53B30A		◦	GHA245001	K
525 xD (145 kW)	2007.01-2010.03	Saloon Engine M57306D3	•		GWB3574	
	2007.01-2010.03	Saloon Engine M57306D3		◦	GHA245001	K
525 xi (160 kW)	2005.07-2010.03	Saloon Engine N52B25A	•		GWB3574	
	2005.07-2010.03	Saloon Engine N52B25A		◦	GHA245001	K
	2007.01-2010.03	Saloon Engine N53B30A	•		GWB3574	
	2007.01-2010.03	Saloon Engine N53B30A		◦	GHA245001	K
530 D (155 kW)	2003.07-2010.03	Saloon Engine M57D30(306D2)/M57D30(306D3)	•		GHA400170	K
	2003.07-2010.03	Saloon Engine M57D30(306D2)/M57D30(306D3)		◦	GHA245001	K
530 D (160 kW)	2003.07-2010.03	Saloon Engine N57D30(306D2)	•		GHA400170	K
	2003.07-2010.03	Saloon Engine N57D30(306D2)		◦	GHA245001	K
530 D (170 kW)	2005.09-2007.02	Saloon Engine M57306D3	•		GHA400170	K
	2005.09-2007.02	Saloon Engine M57306D3		◦	GHA245001	K
530 D (173 kW)	2007.03-2007.08	Saloon Engine M57D30(306D3)	•		GHA400170	K
	2007.03-2007.08	Saloon Engine M57D30(306D3)		◦	GHA245001	K
530 d xDrive (173 kW)	2008.09-2010.03	Saloon Engine M57D30(306D3)	•		GWB3574	
	2008.09-2010.03	Saloon Engine M57D30(306D3)		◦	GHA245001	K
530 i (170 kW)	2003.07-2010.03	Saloon Engine M54B30(306S3)	•		GHA400170	K
	2003.07-2010.03	Saloon Engine M54B30(306S3)		◦	GHA245001	K
530 i (187 kW)	2005.03-2010.03	Saloon Engine N52B30A	•		GHA400170	K
	2005.03-2010.03	Saloon Engine N52B30A		◦	GHA245001	K
530 i (190 kW)	2005.01-2007.08	Saloon Engine N52B30/N52B30A	•		GHA400170	K
	2005.01-2007.08	Saloon Engine N52B30/N52B30A		◦	GHA245001	K
530 i (200 kW)	2007.03-2007.08	Saloon Engine N52B30A/N53B30A	•		GHA400170	K
	2007.03-2007.08	Saloon Engine N52B30A/N53B30A		◦	GHA245001	K
530 i xDrive (200 kW)	2008.09-2010.03	Saloon Engine N52B30A/N53B30A	•		GWB3574	
	2008.09-2010.03	Saloon Engine N52B30A/N53B30A		◦	GHA245001	K
530 xD (170 kW)	2005.07-2010.03	Saloon Engine M57306D3	•		GWB3574	
	2005.07-2010.03	Saloon Engine M57306D3		◦	GHA245001	K
530 xD (173 kW)	2007.01-2010.03	Saloon Engine M57D30(306D3)	•		GWB3574	
	2007.01-2010.03	Saloon Engine M57D30(306D3)		◦	GHA245001	K
530 xi (190 kW)	2005.07-2010.03	Saloon Engine N52B30A	•		GWB3574	
	2005.07-2010.03	Saloon Engine N52B30A		◦	GHA245001	K
530 xi (200 kW)	2007.01-2010.03	Saloon Engine N52B30A/N53B30A	•		GWB3574	
	2007.01-2010.03	Saloon Engine N52B30A/N53B30A		◦	GHA245001	K
535 D (200 kW)	2004.07-2007.08	Saloon Engine M57D30(306D4)	•		GHA400170	K
	2004.07-2007.08	Saloon Engine M57D30(306D4)		◦	GHA245001	K
535 D (210 kW)	2007.03-2007.08	Saloon Engine M57D30(306D5)	•		GHA400170	K
	2007.03-2007.08	Saloon Engine M57D30(306D5)		◦	GHA245001	K
540 i (225 kW)	2005.08-2010.03	Saloon Engine N54B30A	•		GHA400170	K
	2005.08-2010.03	Saloon Engine N54B30A		◦	GHA245001	K



	 YEAR		F	R	G-AP Ref.	KIT
BMW						
5 (E60)						
540 i (225 kW)	2005.09-2007.08	Saloon Engine N62B40A	•		GHA400170	K
	2005.09-2007.08	Saloon Engine N62B40A		◦	GHA245001	K
545 i (245 kW)	2003.08-2005.12	Saloon Engine N62B44A	•		GHA400170	K
	2003.08-2005.12	Saloon Engine N62B44A		◦	GHA245001	K
550 i (270 kW)	2005.09-2007.08	Saloon Engine N62B48B/N62B48A	•		GHA400170	K
	2005.09-2007.08	Saloon Engine N62B48B/N62B48A		◦	GHA245001	K
5 (F10, F18)						
3.0 ActiveHybrid (250 kW)	2011.09-	Saloon Engine N55B30A		◦	GHA249006	K
518 D (100 kW)	2013.01-	Saloon Engine B47 D20 A/N47 D20 C		◦	GHA249006	K
518 D (105 kW)	2013.01-	Saloon Engine N47 D20 C		◦	GHA249006	K
518 D (110 kW)	2014.07-	Saloon Engine B47 D20 A		◦	GHA249006	K
520 D (120 kW)	2010.03-	Saloon Engine B47 D20 A/N47 D20 C		◦	GHA249006	K
520 D (135 kW)	2010.03-	Saloon Engine N47D20C	•		GHA400268	K
	2010.03-	Saloon Engine N47D20C		◦	GHA249006	K
520 D (140 kW)	2014.07-	Saloon Engine B47 D20 A		◦	GHA249006	K
520 d xDrive (120 kW)	2013.02-	Saloon Engine B47 D20 A/N47 D20 C		◦	GHA249006	K
520 d xDrive (135 kW)	2013.02-	Saloon Engine N47 D20 C		◦	GHA249006	K
520 d xDrive (140 kW)	2014.07-	Saloon Engine B47 D20 A		◦	GHA249006	K
520 i (120 kW)	2011.09-	Saloon Engine N20B20A		◦	GHA249006	K
520 i (135 kW)	2011.09-	Saloon Engine N20B20A	•		GHA400268	K
	2011.09-	Saloon Engine N20B20A		◦	GHA249006	K
523 i (150 kW)	2010.03-	Saloon Engine N52 B25 A	•		GHA400268	K
	2010.03-	Saloon Engine N52 B25 A		◦	GHA249006	K
	2010.03-	Saloon Engine N53B30A	•		GHA400268	K
	2010.03-	Saloon Engine N53B30A		◦	GHA249006	K
525 D (150 kW)	2010.03-	Saloon Engine N57D30A	•		GHA400268	K
	2010.03-	Saloon Engine N57D30A		◦	GHA249006	K
525 D (155 kW)	2011.09-	Saloon Engine N47D20D		◦	GHA249006	K
525 D (160 kW)	2011.09-	Saloon Engine N47D20D	•		GHA400268	K
	2011.09-	Saloon Engine N47D20D		◦	GHA249006	K
525 d xDrive (155 kW)	2011.09-	Saloon Engine N47D20D		◦	GHA249006	K
525 d xDrive (160 kW)	2011.09-	Saloon Engine N47D20D		◦	GHA249006	K
528 i (180 kW)	2011.09-	Saloon Engine N20B20A	•		GHA400268	K
	2011.09-	Saloon Engine N20B20A		◦	GHA249006	K
528 i (190 kW)	2010.03-	Saloon Engine N53B30A	•		GHA400268	K
	2010.03-	Saloon Engine N53B30A		◦	GHA249006	K
528 i xDrive (180 kW)	2011.09-	Saloon Engine N20B20A		◦	GHA249006	K
530 D (180 kW)	2010.03-	Saloon Engine N57D30A	•		GHA400268	K
	2010.03-	Saloon Engine N57D30A		◦	GHA249006	K
530 D (190 kW)	2011.09-	Saloon Engine N57D30A	•		GHA400268	K
	2011.09-	Saloon Engine N57D30A		◦	GHA249006	K
530 d xDrive (190 kW)	2011.09-	Saloon Engine N57D30A		◦	GHA249006	K
530 i (200 kW)	2011.09-	Saloon Engine N53B30A	•		GHA400268	K
	2011.09-	Saloon Engine N53B30A		◦	GHA249006	K
535 D (220 kW)	2010.09-	Saloon Engine N57D30B	•		GHA400268	K
	2010.09-	Saloon Engine N57D30B		◦	GHA249006	K
535 D (230 kW)	2011.09-	Saloon Engine N57D30B	•		GHA400268	K
	2011.09-	Saloon Engine N57D30B		◦	GHA249006	K
535 d xDrive (230 kW)	2011.09-	Saloon Engine N57D30B		◦	GHA249006	K
535 i (225 kW)	2010.03-	Saloon Engine N55B30A	•		GHA400268	K
	2010.03-	Saloon Engine N55B30A		◦	GHA249006	K
535 i xDrive (225 kW)	2010.03-	Saloon Engine N55B30A		◦	GHA249006	K
550 i (300 kW)	2010.03-	Saloon Engine N63B44A	•		GHA400268	K
	2010.03-	Saloon Engine N63B44A		◦	GHA249006	K
550 i (330 kW)	2013.05-	Saloon Engine N63 B44 B		◦	GHA249006	K
550 i xDrive (300 kW)	2010.09-	Saloon Engine N63B44A		◦	GHA249006	K
550 i xDrive (330 kW)	2013.05-	Saloon Engine N63 B44 B		◦	GHA249006	K
ActiveHybrid (225 kW)	2011.09-	Saloon Engine N55 B30 A		◦	GHA249006	K
M 550 d xDrive (280 kW)	2012.01-	Saloon Engine N57D30C		◦	GHA249006	K
M5 (412 kW)	2011.06-	Saloon Engine S63 B44 B	•		GHA400268	K
5 GRAN TURISMO (F07)						
520 D (135 kW)	2011.10-	Hatchback Engine N47D20C		◦	GHA249006	K
528 i (180 kW)	2013.08-	Hatchback Engine N20 B20 A		◦	GHA249006	K
530 D (155 kW)	2010.07-	Hatchback Engine N57D30A		◦	GHA249006	K



	 YEAR		F	R	G-AP Ref.	KIT
BMW						
5 GRAN TURISMO (F07)						
530 D (180 kW)	2009.10-	Hatchback Engine N57D30A	•		GHA400268	K
	2009.10-	Hatchback Engine N57D30A		◦	GHA249006	K
530 D (190 kW)	2009.10-	Hatchback Engine N57D30A	•		GHA400268	K
	2009.10-	Hatchback Engine N57D30A		◦	GHA249006	K
530 d xDrive (180 kW)	2010.09-	Hatchback Engine N57D30A		◦	GHA249006	K
530 d xDrive (190 kW)	2009.10-	Hatchback Engine N57D30A		◦	GHA249006	K
535 D (220 kW)	2010.09-	Hatchback Engine N57D30B	•		GHA400268	K
	2010.09-	Hatchback Engine N57D30B		◦	GHA249006	K
535 D (230 kW)	2012.02-	Hatchback Engine N57 D30 B		◦	GHA249006	K
535 d xDrive (220 kW)	2010.09-	Hatchback Engine N57SD30B		◦	GHA249006	K
535 d xDrive (230 kW)	2012.02-	Hatchback Engine N57 D30 B		◦	GHA249006	K
535 i (225 kW)	2009.10-	Hatchback Engine N55B30A	•		GHA400268	K
	2009.10-	Hatchback Engine N55B30A		◦	GHA249006	K
535 i xDrive (225 kW)	2010.09-	Hatchback Engine N55B30A		◦	GHA249006	K
550 i (300 kW)	2009.10-	Hatchback Engine N63B44A	•		GHA400268	K
	2009.10-	Hatchback Engine N63B44A		◦	GHA249006	K
550 i (330 kW)	2012.05-	Hatchback Engine N63B44B		◦	GHA249006	K
550 i xDrive (300 kW)	2010.09-	Hatchback Engine N63B44A		◦	GHA249006	K
550 i xDrive (330 kW)	2012.05-	Hatchback Engine N63B44B		◦	GHA249006	K
5 TOURING (E34)						
518 G (85 kW)	1995.11-1996.06	Estate Engine M43B18	•		GHA237002	K
518 i (83 kW)	1993.03-1994.09	Estate Engine M40B18	•		GHA237002	K
518 i (85 kW)	1994.09-1997.01	Estate Engine M43B18	•		GHA237002	K
520 i (110 kW)	1991.11-1997.01	Estate Engine M50B20TU/M50B(206S1)/M50B(206S2)/Vanos/M50B20	•		GHA237002	K
525 i (141 kW)	1991.11-1997.01	Estate Engine M50B25/M50B25(256S1)/M50B25(256S2)/M50B25TU	•		GHA237002	K
525 TD (85 kW)	1993.03-1997.01	Estate Engine M51D25	•		GHA237002	K
525 TDS (105 kW)	1991.12-1997.01	Estate Engine M51D25(Inter.)	•		GHA237002	K
530 i V8 (160 kW)	1992.09-1997.01	Estate Engine M60B30/M60B30(308S1)	•		GHA237002	K
540 i (210 kW)	1993.09-1997.01	Estate Engine M60B40	•		GHA237002	K
M 3.8 (250 kW)	1994.09-1997.01	Estate Engine S38B38	•	◦	GWB5549	
5 TOURING (E39)						
520 D (100 kW)	2000.02-2003.09	Estate Engine M47D20/M47204D1	•		GHA400001	K
	2000.02-2003.09	Estate Engine M47D20/M47204D1		◦	GHA245001	K
520 i (100 kW)	1999.04-2004.05	Estate Engine M52B(206S3)/Vanos	•		GHA400001	K
	1999.04-2004.05	Estate Engine M52B(206S3)/Vanos		◦	GHA245001	K
520 i (110 kW)	1997.01-2000.09	Estate Engine M52B(206S3)/Vanos/M52B(206S4)/M52B20	•		GHA400001	K
	1997.01-2000.09	Estate Engine M52B(206S3)/Vanos/M52B(206S4)/M52B20		◦	GHA245001	K
520 i (125 kW)	2000.09-2004.05	Estate Engine M54B22(226S1)	•		GHA400001	K
	2000.09-2004.05	Estate Engine M54B22(226S1)		◦	GHA245001	K
523 i (125 kW)	1997.01-2000.09	Estate Engine M52B25(Vanos)/M52B25TU	•		GHA400001	K
	1997.01-2000.09	Estate Engine M52B25(Vanos)/M52B25TU		◦	GHA245001	K
525 D (120 kW)	2000.02-2004.05	Estate Engine M57D25(256D1)/M57D25	•		GHA400001	K
	2000.02-2004.05	Estate Engine M57D25(256D1)/M57D25		◦	GHA245001	K
525 i (141 kW)	2000.09-2004.05	Estate Engine M54B25(256S5)	•		GHA400001	K
	2000.09-2004.05	Estate Engine M54B25(256S5)		◦	GHA245001	K
525 TDS (105 kW)	1997.03-2004.05	Estate Engine M51D25(inter.)	•		GHA400001	K
	1997.03-2004.05	Estate Engine M51D25(inter.)		◦	GHA245001	K
528 i (142 kW)	1997.01-2000.09	Estate Engine M52B28/M52B28TU/M52B28(286S1)/M52B28(286S2)	•		GHA400001	K
	1997.01-2000.09	Estate Engine M52B28/M52B28TU/M52B28(286S1)/M52B28(286S2)		◦	GHA245001	K
530 D (135 kW)	1998.08-2000.09	Estate Engine M57D30	•		GHA400001	K
	1998.08-2000.09	Estate Engine M57D30		◦	GHA245001	K
530 D (142 kW)	2000.09-2004.05	Estate Engine M57D30(306D1)	•		GHA400001	K
	2000.09-2004.05	Estate Engine M57D30(306D1)		◦	GHA245001	K
530 i (170 kW)	2000.09-2004.05	Estate Engine M54B30(306S3)	•		GHA400001	K
	2000.09-2004.05	Estate Engine M54B30(306S3)		◦	GHA245001	K
540 i (210 kW)	1997.01-2004.05	Estate Engine M62B44(448S1)/M62B44(448S2)	•		GHA400001	K
	1997.01-2004.05	Estate Engine M62B44(448S1)/M62B44(448S2)		◦	GHA245001	K
5 TOURING (E61)						
520 D (110 kW)	2005.09-	Estate Engine M47D20(204D4)/M47D20A/M47D20C	•		GHA400170	K
	2005.09-	Estate Engine M47D20(204D4)/M47D20A/M47D20C		◦	GHA245012	K
520 D (120 kW)	2005.09-2007.08	Estate Engine N47D20A/N47D20C/M47D20(204D4)	•		GHA400170	K
	2005.09-2007.08	Estate Engine N47D20A/N47D20C/M47D20(204D4)		◦	GHA245012	K
520 D (130 kW)	2007.09-	Estate Engine N47D20A/N47D20C	•		GHA400170	K
	2007.09-	Estate Engine N47D20A/N47D20C		◦	GHA245012	K



	 YEAR		F	R	G-AP Ref.	KIT
BMW						
5 TOURING (E61)						
520 i (120 kW)	2007.07-2010.08	Estate Engine N43 B20 A	•		GHA400170	K
	2007.07-2010.08	Estate Engine N43 B20 A		◦	GHA245012	K
520 i (125 kW)	2007.09-	Estate Engine N43B20A	•		GHA400170	K
	2007.09-	Estate Engine N43B20A		◦	GHA245012	K
523 i (130 kW)	2005.01-2007.02	Estate Engine N52B25A/N52B25	•		GHA400170	K
	2005.01-2007.02	Estate Engine N52B25A/N52B25		◦	GHA245012	K
523 i (140 kW)	2007.03-2007.08	Estate Engine N52B25A/N53B25A	•		GHA400170	K
	2007.03-2007.08	Estate Engine N52B25A/N53B25A		◦	GHA245012	K
525 D (120 kW)	2004.12-	Estate Engine M57N256D4	•		GHA400170	K
	2004.12-	Estate Engine M57N256D4		◦	GHA245012	K
525 D (130 kW)	2004.06-	Estate Engine M57N256D4/M57D25TU	•		GHA400170	K
	2004.06-	Estate Engine M57N256D4/M57D25TU		◦	GHA245012	K
525 D (145 kW)	2007.03-2007.08	Estate Engine M57D30(306D3)	•		GHA400170	K
	2007.03-2007.08	Estate Engine M57D30(306D3)		◦	GHA245012	K
525 d xDrive (145 kW)	2008.09-	Estate Engine M57D30(306D3)	•		GWB3574	
	2008.09-	Estate Engine M57D30(306D3)		◦	GHA245012	K
525 i (141 kW)	2004.06-	Estate Engine M54B25(256S5)	•		GHA400170	K
	2004.06-	Estate Engine M54B25(256S5)		◦	GHA245012	K
525 i (160 kW)	2005.01-2007.02	Estate Engine N52B25A/N52B25	•		GHA400170	K
	2005.01-2007.02	Estate Engine N52B25A/N52B25		◦	GHA245012	K
	2007.03-2007.08	Estate Engine N53B30A/N53B30	•		GHA400170	K
	2007.03-2007.08	Estate Engine N53B30A/N53B30		◦	GHA245012	K
525 i xDrive (160 kW)	2008.09-	Estate Engine N53B30A	•		GWB3574	
	2008.09-	Estate Engine N53B30A		◦	GHA245012	K
525 xD (145 kW)	2007.01-	Estate Engine M57306D3	•		GWB3574	
	2007.01-	Estate Engine M57306D3		◦	GHA245012	K
525 xi (160 kW)	2005.07-	Estate Engine N52B25A	•		GWB3574	
	2005.07-	Estate Engine N52B25A		◦	GHA245012	K
	2007.01-	Estate Engine N53B30A/N52B30A	•		GWB3574	
	2007.01-	Estate Engine N53B30A/N52B30A		◦	GHA245012	K
530 D (155 kW)	2005.11-	Estate Engine M57D30(306D3)	•		GHA400170	K
	2005.11-	Estate Engine M57D30(306D3)		◦	GHA245012	K
530 D (160 kW)	2004.06-	Estate Engine N57D30(306D2)	•		GHA400170	K
	2004.06-	Estate Engine N57D30(306D2)		◦	GHA245012	K
530 D (170 kW)	2005.09-2007.02	Estate Engine M57306D3	•		GHA400170	K
	2005.09-2007.02	Estate Engine M57306D3		◦	GHA245012	K
530 D (173 kW)	2007.03-2007.08	Estate Engine M57D30(306D3)	•		GHA400170	K
	2007.03-2007.08	Estate Engine M57D30(306D3)		◦	GHA245012	K
530 d xDrive (173 kW)	2008.09-	Estate Engine M57D30(306D3)	•		GWB3574	
	2008.09-	Estate Engine M57D30(306D3)		◦	GHA245012	K
530 i (190 kW)	2005.01-2007.08	Estate Engine N52B30A/N52B30	•		GHA400170	K
	2005.01-2007.08	Estate Engine N52B30A/N52B30		◦	GHA245012	K
530 i (200 kW)	2007.03-2007.08	Estate Engine N52B30A/N53B30A	•		GHA400170	K
	2007.03-2007.08	Estate Engine N52B30A/N53B30A		◦	GHA245012	K
530 i xDrive (200 kW)	2008.09-	Estate Engine N53B30A/N52B30A	•		GWB3574	
	2008.09-	Estate Engine N53B30A/N52B30A		◦	GHA245012	K
530 xD (170 kW)	2005.07-	Estate Engine M57306D3	•		GWB3574	
	2005.07-	Estate Engine M57306D3		◦	GHA245012	K
530 xD (173 kW)	2007.01-	Estate Engine M57306D3	•		GWB3574	
	2007.01-	Estate Engine M57306D3		◦	GHA245012	K
530 xi (190 kW)	2005.07-	Estate Engine N52B30A	•		GWB3574	
	2005.07-	Estate Engine N52B30A		◦	GHA245012	K
530 xi (200 kW)	2007.01-	Estate Engine N53B30A/N52B30A	•		GWB3574	
	2007.01-	Estate Engine N53B30A/N52B30A		◦	GHA245012	K
535 D (200 kW)	2004.07-2007.08	Estate Engine M57D30(306D4)	•		GHA400170	K
	2004.07-2007.08	Estate Engine M57D30(306D4)		◦	GHA245012	K
535 D (210 kW)	2007.03-2007.08	Estate Engine M57D30(306D5)	•		GHA400170	K
	2007.03-2007.08	Estate Engine M57D30(306D5)		◦	GHA245012	K
545 i (245 kW)	2004.06-	Estate Engine N62B44A	•		GHA400170	K
	2004.06-	Estate Engine N62B44A		◦	GHA245012	K
550 i (270 kW)	2005.09-2007.08	Estate Engine N62B48A/N62B48B	•		GHA400170	K
	2005.09-2007.08	Estate Engine N62B48A/N62B48B		◦	GHA245012	K
5 TOURING (F11)						
518 D (100 kW)	2013.01-	Estate Engine B47 D20 A/N47 D20 C		◦	GHA249006	K



	 YEAR		F	R	G-AP Ref.	KIT
BMW						
5 TOURING (F11)						
518 D (105 kW)	2013.01-	Estate Engine N47 D20 C		o	GHA249006	K
518 D (110 kW)	2014.05-	Estate Engine B47 D20 A		o	GHA249006	K
520 D (120 kW)	2010.04-	Estate Engine B47 D20 A/N47 D20 C		o	GHA249006	K
520 D (135 kW)	2010.09-	Estate Engine N47D20C	•		GHA400268	K
	2010.09-	Estate Engine N47D20C		o	GHA249006	K
520 D (140 kW)	2014.05-	Estate Engine B47 D20 A		o	GHA249006	K
520 d xDrive (120 kW)	2013.02-	Estate Engine B47 D20 A/N47 D20 C		o	GHA249006	K
520 d xDrive (135 kW)	2013.02-	Estate Engine N47 D20 C		o	GHA249006	K
520 d xDrive (140 kW)	2014.05-	Estate Engine B47 D20 A		o	GHA249006	K
520 i (135 kW)	2011.09-	Estate Engine N20B20A	•		GHA400268	K
	2011.09-	Estate Engine N20B20A		o	GHA249006	K
523 i (150 kW)	2010.04-2011.12	Estate Engine N52 B25 A		o	GHA249006	K
	2010.09-	Estate Engine N53B30A	•		GHA400268	K
	2010.09-	Estate Engine N53B30A		o	GHA249006	K
525 D (150 kW)	2010.09-	Estate Engine N57D30A	•		GHA400268	K
	2010.09-	Estate Engine N57D30A		o	GHA249006	K
525 D (160 kW)	2011.09-	Estate Engine N47D20D	•		GHA400268	K
525 d xDrive (160 kW)	2011.09-	Estate Engine N47D20D		o	GHA249006	K
528 i (180 kW)	2011.09-	Estate Engine N20B20A	•		GHA400268	K
528 i (190 kW)	2010.09-	Estate Engine N53B30A	•		GHA400268	K
	2010.09-	Estate Engine N53B30A		o	GHA249006	K
528 i xDrive (180 kW)	2011.09-	Estate Engine N20B20A		o	GHA249006	K
530 D (180 kW)	2010.09-	Estate Engine N57D30A	•		GHA400268	K
	2010.09-	Estate Engine N57D30A		o	GHA249006	K
530 D (190 kW)	2011.09-	Estate Engine N57D30A	•		GHA400268	K
	2011.09-	Estate Engine N57D30A		o	GHA249006	K
530 d xDrive (190 kW)	2011.09-	Estate Engine N57D30A		o	GHA249006	K
530 i (200 kW)	2011.09-	Estate Engine N53B30A	•		GHA400268	K
535 D (220 kW)	2010.09-	Estate Engine N57SD30B	•		GHA400268	K
	2010.09-	Estate Engine N57SD30B		o	GHA249006	K
535 D (230 kW)	2011.09-	Estate Engine N57D30B	•		GHA400268	K
535 d xDrive (230 kW)	2011.09-	Estate Engine N57D30B		o	GHA249006	K
535 i (225 kW)	2010.09-	Estate Engine N53B30A	•		GHA400268	K
	2010.09-	Estate Engine N53B30A		o	GHA249006	K
535 i xDrive (225 kW)	2011.09-	Estate Engine N55B30A		o	GHA249006	K
550 i (300 kW)	2010.09-	Estate Engine N63B44A	•		GHA400268	K
	2010.09-	Estate Engine N63B44A		o	GHA249006	K
550 i (330 kW)	2013.05-	Estate Engine N63 B44 B		o	GHA249006	K
M 550 d xDrive (280 kW)	2012.01-	Estate Engine N57D30C		o	GHA249006	K
6 (E63)						
630 i (190 kW)	2004.09-2007.08	Coupe Engine N52B30/N52B30A	•		GHA400170	K
	2004.09-2007.08	Coupe Engine N52B30/N52B30A		o	GHA245012	K
630 i (200 kW)	2007.07-	Coupe Engine N53B30/N52B30A	•		GHA400170	K
	2007.07-	Coupe Engine N53B30/N52B30A		o	GHA245012	K
635 D (210 kW)	2007.07-	Coupe Engine M57D30(306D5)	•		GHA400170	K
	2007.07-	Coupe Engine M57D30(306D5)		o	GHA245012	K
645 Ci (245 kW)	2004.01-	Coupe Engine N62B44/N62B44A	•		GHA400170	K
	2004.01-	Coupe Engine N62B44/N62B44A		o	GHA245012	K
650 i (270 kW)	2005.09-2007.08	Coupe Engine N62B48B	•		GHA400170	K
	2005.09-2007.08	Coupe Engine N62B48B		o	GHA245012	K
6 (E64)						
630 i (190 kW)	2004.09-2007.08	Convertible Engine N52B30A/N52B30	•		GHA400170	K
	2004.09-2007.08	Convertible Engine N52B30A/N52B30		o	GHA245012	K
630 i (200 kW)	2007.07-	Convertible Engine N53B30/N53B30A	•		GHA400170	K
	2007.07-	Convertible Engine N53B30/N53B30A		o	GHA245012	K
635 D (210 kW)	2007.07-	Convertible Engine M57D30(306D5)	•		GHA400170	K
	2007.07-	Convertible Engine M57D30(306D5)		o	GHA245012	K
645 Ci (245 kW)	2004.04-	Convertible Engine N62B44/N62B44A	•		GHA400170	K
	2004.04-	Convertible Engine N62B44/N62B44A		o	GHA245012	K
650 i (270 kW)	2005.09-2007.08	Convertible Engine N62B48B	•		GHA400170	K
	2005.09-2007.08	Convertible Engine N62B48B		o	GHA245012	K
6 (F12)						
640 D (230 kW)	2011.09-	Convertible Engine N57D30B	•		GHA400268	K
	2011.09-	Convertible Engine N57D30B		o	GHA249006	K



	 YEAR		F	R	G-AP Ref.	KIT
BMW						
6 (F12)						
640 d xDrive (230 kW)	2011.09-	Convertible Engine N57D30B		o	GHA249006	K
640 i (235 kW)	2011.03-	Convertible Engine N55B30A	•		GHA400268	K
	2011.03-	Convertible Engine N55B30A		o	GHA249006	K
640 i xDrive (235 kW)	2013.01-	Convertible Engine N55 B30 A		o	GHA249006	K
650 i (300 kW)	2011.03-	Convertible Engine N63B44A	•		GHA400268	K
	2011.03-	Convertible Engine N63B44A		o	GHA249006	K
650 i (330 kW)	2011.10-	Convertible Engine N63B44B/N63B44A		o	GHA249006	K
650 i xDrive (300 kW)	2011.06-	Convertible Engine N63B44A		o	GHA249006	K
650 i xDrive (330 kW)	2011.11-	Convertible Engine N63B44B/N63B44A		o	GHA249006	K
6 (F13)						
640 D (230 kW)	2010.11-	Coupe Engine N57D30B	•		GHA400268	K
	2010.11-	Coupe Engine N57D30B		o	GHA249006	K
640 d xDrive (230 kW)	2011.09-	Coupe Engine N57D30B		o	GHA249006	K
640 i (235 kW)	2010.11-	Coupe Engine N55B30A	•		GHA400268	K
	2010.11-	Coupe Engine N55B30A		o	GHA249006	K
640 i xDrive (235 kW)	2013.01-	Coupe Engine N55 B30 A		o	GHA249006	K
650 i (300 kW)	2010.11-	Coupe Engine N63B44A	•		GHA400268	K
	2010.11-	Coupe Engine N63B44A		o	GHA249006	K
650 i (330 kW)	2011.10-	Coupe Engine N63B44B		o	GHA249006	K
650 i xDrive (300 kW)	2011.06-	Coupe Engine N63B44A		o	GHA249006	K
650 i xDrive (330 kW)	2011.11-	Coupe Engine N63B44B		o	GHA249006	K
6 GRAN (F06)						
640 D (230 kW)	2011.09-	Coupe Engine N57D30B		o	GHA249006	K
640 d xDrive (230 kW)	2013.01-	Coupe Engine N57 D30 B		o	GHA249006	K
640 i (235 kW)	2011.09-	Coupe Engine N55B30A		o	GHA249006	K
640 i xDrive (235 kW)	2013.01-	Coupe Engine N55 B30 A		o	GHA249006	K
650 i (330 kW)	2011.11-	Coupe Engine N63B44B		o	GHA249006	K
650 i xDrive (330 kW)	2011.11-	Coupe Engine N63B44B		o	GHA249006	K
7 (E32)						
730 i,iL V8 (160 kW)	1992.04-1994.09	Saloon Engine M60B30	•		GHA237002	K
740 i,iL V8 (210 kW)	1992.04-1994.09	Saloon Engine M60B40/M60B40(408S1)	•		GHA237002	K
7 (E38)						
725 TDS (105 kW)	1996.04-2001.11	Saloon Engine M51D25(INTER.)	•		GHA237003	K
	1996.04-2001.11	Saloon Engine M51D25(INTER.)		o	GWB3668	
728 i,iL (142 kW)	1995.08-2001.11	Saloon Engine M52B28/M52B28TU/M52B28(286S1)/M52B28(286S2)	•		GHA237003	K
	1995.08-2001.11	Saloon Engine M52B28/M52B28TU/M52B28(286S1)/M52B28(286S2)		o	GWB3668	
728i X (142 kW)	1995.11-2001.09	Saloon Engine M52 B28(286S1)	•		GHA237003	K
	1995.11-2001.09	Saloon Engine M52 B28(286S1)		o	GWB3668	
730 D (135 kW)	1998.08-2000.04	Saloon Engine M57D30	•		GHA237003	K
	1998.08-2000.04	Saloon Engine M57D30		o	GWB3668	
730 D (142 kW)	2000.04-2001.11	Saloon Engine M57D30(306D1)	•		GHA237003	K
	2000.04-2001.11	Saloon Engine M57D30(306D1)		o	GWB3668	
730 i,iL (155 kW)	1994.10-2001.11	Saloon Engine M60B30	•		GHA237003	K
	1994.10-2001.11	Saloon Engine M60B30		o	GWB3668	
730 i,iL (160 kW)	1994.10-2001.11	Saloon Engine M60B30	•		GHA237003	K
	1994.10-2001.11	Saloon Engine M60B30		o	GWB3668	
735 i,iL (173 kW)	1996.01-2001.11	Saloon Engine M62B(358S1)/M62B35	•		GHA237003	K
	1996.01-2001.11	Saloon Engine M62B(358S1)/M62B35		o	GWB3668	
740 D (180 kW)	1999.05-2001.11	Saloon Engine M67D39	•		GHA237003	K
	1999.05-2001.11	Saloon Engine M67D39		o	GWB3668	
740 i,iL (210 kW)	1994.10-2001.11	Saloon Engine M60B40/M60B40(408S1)	•		GHA237003	K
	1994.10-2001.11	Saloon Engine M60B40/M60B40(408S1)		o	GWB3668	
	1996.01-2001.11	Saloon Engine M62B44(448S1)/M62B44(448S2)	•		GHA237003	K
	1996.01-2001.11	Saloon Engine M62B44(448S1)/M62B44(448S2)		o	GWB3668	
750 i,iL (240 kW)	1994.12-2001.11	Saloon Engine M73B54/M73B54(54121)/M73B54(54122)	•		GHA237003	K
	1994.12-2001.11	Saloon Engine M73B54/M73B54(54121)/M73B54(54122)		o	GWB3668	
7 (E65, E66, E67)						
730 D (155 kW)	2002.10-	Saloon Engine M57D30(306D3)	•		GHA400248	K
	2002.10-	Saloon Engine M57D30(306D3)		o	GHA245012	K
730 D (160 kW)	2002.10-	Saloon Engine M57D30(306D2)	•		GHA400248	K
	2002.10-	Saloon Engine M57D30(306D2)		o	GHA245012	K
730 i,Li (170 kW)	2003.03-	Saloon Engine M54B30(306S3)	•		GHA400248	K
	2003.03-	Saloon Engine M54B30(306S3)		o	GHA245012	K



	 YEAR		F	R	G-AP Ref.	KIT
BMW						
7 (E65, E66, E67)						
730 i,Li (190 kW)	2005.03-	Saloon Engine N52B30A/N52B30	•		GHA400248	K
	2005.03-	Saloon Engine N52B30A/N52B30		◦	GHA245012	K
730 LD (170 kW)	2005.07-	Saloon Engine M57D30(306D3)/N57N306D2	•		GHA400248	K
	2005.07-	Saloon Engine M57D30(306D3)/N57N306D2		◦	GHA245012	K
735 i (225 kW)	2005.03-2009.12	Saloon Engine N62 B40 A	•		GHA400248	K
	2005.03-2009.12	Saloon Engine N62 B40 A		◦	GHA245012	K
735 i,Li (200 kW)	2001.11-	Saloon Engine N62B36	•		GHA400248	K
	2001.11-	Saloon Engine N62B36		◦	GHA245012	K
740 D (190 kW)	2002.10-	Saloon Engine M67D39(398D1)	•		GHA400248	K
	2002.10-	Saloon Engine M67D39(398D1)		◦	GHA245012	K
740 i,Li (225 kW)	2005.01-	Saloon Engine N62B40A	•		GHA400248	K
	2005.01-	Saloon Engine N62B40A		◦	GHA245012	K
745 D (220 kW)	2005.03-2005.08	Saloon Engine M67D44(448D1)	•		GHA400248	K
	2005.03-2005.08	Saloon Engine M67D44(448D1)		◦	GHA245012	K
745 D (242 kW)	2005.07-	Saloon Engine M67D44(448D1)/N67N448D2	•		GHA400248	K
	2005.07-	Saloon Engine M67D44(448D1)/N67N448D2		◦	GHA245012	K
745 i,Li (245 kW)	2001.11-	Saloon Engine N62B44/N62B44A	•		GHA400248	K
	2001.11-	Saloon Engine N62B44/N62B44A		◦	GHA245012	K
750 i,Li (270 kW)	2005.01-2007.08	Saloon Engine N62B48B	•		GHA400248	K
	2005.01-2007.08	Saloon Engine N62B48B		◦	GHA245012	K
760 i,Li (327 kW)	2003.01-	Saloon Engine N73B60/N73B60A	•		GHA400248	K
	2003.01-	Saloon Engine N73B60/N73B60A		◦	GHA245012	K
7 (E65,E66,E67)						
730i,li (184 kW)	2005.03-	Sedan Engine N52 B30 A	•		GHA400248	K
	2005.03-	Sedan Engine N52 B30 A		◦	GHA245012	K
760 (320 kW)	2003.02-2005.08	Sedan Engine N73 B60 A	•		GHA400248	K
	2003.02-2005.08	Sedan Engine N73 B60 A		◦	GHA245012	K
7 (F01, F02, F03, F04)						
3.0 ActiveHybrid (260 kW)	2012.07-	Saloon Engine N55B30A		◦	GHA249006	K
4.4 ActiveHybrid (330 kW)	2010.10-	Saloon Engine N63B44A		◦	GHA249006	K
4.4 ActiveHybrid (342 kW)	2010.10-	Saloon Engine N63B44A		◦	GHA249006	K
730 D (155 kW)	2009.07-2015.12	Saloon Engine N57 D30 A		◦	GHA249006	K
730 D (180 kW)	2008.10-	Saloon Engine N57D30A	•		GHA400268	K
	2008.10-	Saloon Engine N57D30A		◦	GHA249006	K
730 D (190 kW)	2012.07-	Saloon Engine N57D30A		◦	GHA249006	K
730 d xDrive (190 kW)	2012.07-	Saloon Engine N57D30A		◦	GHA249006	K
730 i (190 kW)	2008.06-	Saloon Engine N52B30A	•		GHA400268	K
	2008.06-	Saloon Engine N52B30A		◦	GHA249006	K
740 D (225 kW)	2009.09-	Saloon Engine N57D30B	•		GHA400268	K
	2009.09-	Saloon Engine N57D30B		◦	GHA249006	K
740 D (230 kW)	2012.07-	Saloon Engine N57D30B		◦	GHA249006	K
740 d xDrive (225 kW)	2009.09-	Saloon Engine N57SD30B		◦	GHA249006	K
740 d xDrive (230 kW)	2012.07-	Saloon Engine N57D30B		◦	GHA249006	K
740 i (235 kW)	2012.07-	Saloon Engine N55B30A		◦	GHA249006	K
740 i (240 kW)	2008.10-	Saloon Engine N54B30A	•		GHA400268	K
	2008.10-	Saloon Engine N54B30A		◦	GHA249006	K
750 d xDrive (280 kW)	2012.07-	Saloon Engine N57D30C		◦	GHA249006	K
750 i (300 kW)	2008.10-	Saloon Engine N63B44A	•		GHA400268	K
	2008.10-	Saloon Engine N63B44A		◦	GHA249006	K
750 i (330 kW)	2012.10-	Saloon Engine N63B44B		◦	GHA249006	K
750 i xDrive (300 kW)	2009.09-	Saloon Engine N63B44A/N63B44B		◦	GHA249006	K
750 i xDrive (330 kW)	2012.10-	Saloon Engine N63B44B		◦	GHA249006	K
760 i (400 kW)	2009.09-	Saloon Engine N74B60A	•		GHA400268	K
	2009.09-	Saloon Engine N74B60A		◦	GHA249006	K
Active Hybrid 7 (235 kW)	2012.07-2015.12	Saloon Engine N55 B30 A		◦	GHA249006	K
8 (E31)						
840 Ci (210 kW)	1996.01-1999.12	Coupe Engine M62B44/M62B44TU/M62B44(448S1)	•		GHA237002	K
	1996.01-1999.12	Coupe Engine M62B44/M62B44TU/M62B44(448S1)		◦	GWB3668	
840 i (210 kW)	1993.02-1996.02	Coupe Engine M60B40/M60B40(408S1)	•		GHA237002	K
	1993.02-1996.02	Coupe Engine M60B40/M60B40(408S1)		◦	GWB3668	
850 Ci (240 kW)	1994.09-1999.12	Coupe Engine M73B54/M73B54(54121)	•		GHA237002	K
	1994.09-1999.12	Coupe Engine M73B54/M73B54(54121)		◦	GWB3668	
850 CSi (278 kW)	1993.04-1995.12	Coupe Engine S70 B56 (516121)		◦	GWB3668	
850 CSi (280 kW)	1993.04-1996.12	Coupe Engine M70B56	•	◦	GWB5549	



	 YEAR		F	R	G-AP Ref.	KIT
BMW						
8 (E31)						
850 CSi (280 kW)	1993.04-1996.12	Coupe Engine M70B56		o	GWB3668	
850 i,Ci (220 kW)	1990.04-1994.10	Coupe Engine M70B50/M70B50(5012A)	•		GHA237001	K
	1990.04-1994.10	Coupe Engine M70B50/M70B50(5012A)	•		GHA237002	K
	1990.04-1994.10	Coupe Engine M70B50/M70B50(5012A)		o	GWB3668	
X1 (E84)						
sDrive 16 D (85 kW)	2012.04-	Estate Engine N47D20C	•		GHA400171	S
sDrive 16 i (105 kW)	2013.03-2015.06		•		GHA400171	S
sDrive 18 D (105 kW)	2009.10-	Estate Engine N47D20C	•		GHA400171	S
sDrive 18 i (110 kW)	2010.01-	Estate Engine N46B20B	•		GHA400171	S
sDrive 20 D (120 kW)	2010.03-	Estate Engine N47D20C	•		GHA400171	S
sDrive 20 D (130 kW)	2009.10-	Estate Engine N47D20C	•		GHA400171	S
sDrive 20 D (135 kW)	2011.03-	Estate Engine N47D20C	•		GHA400171	S
sDrive 20 i (135 kW)	2011.09-	Estate Engine N20B20A	•		GHA400171	S
X3 (E83)						
2.0 D (110 kW)	2004.09-2007.08	Closed Off-Road Vehicle Engine M47D20(204D4)	•		GWB3574	
	2004.09-2007.08	Closed Off-Road Vehicle Engine M47D20(204D4)		o	GWB3668	
2.0 D (130 kW)	2007.09-	Closed Off-Road Vehicle Engine N47D20A	•		GWB3574	
	2007.09-	Closed Off-Road Vehicle Engine N47D20A		o	GWB3668	
2.0 i (110 kW)	2005.09-2006.07	Closed Off-Road Vehicle Engine N46B20/N46B20B	•		GWB3574	
	2005.09-2006.07	Closed Off-Road Vehicle Engine N46B20/N46B20B		o	GWB3668	
2.5 i (141 kW)	2004.03-2006.07	Closed Off-Road Vehicle Engine M54B25(256S5)	•		GWB3574	
	2004.03-2006.07	Closed Off-Road Vehicle Engine M54B25(256S5)		o	GWB3668	
2.5 Si (160 kW)	2006.08-2007.08	Closed Off-Road Vehicle Engine N52B25A	•		GWB3574	
	2006.08-2007.08	Closed Off-Road Vehicle Engine N52B25A		o	GWB3668	
2.5 Si xDrive (155 kW)	2006.07-2008.12	Closed Off-Road Vehicle Engine N52B25A	•		GWB3574	
	2006.07-2008.12	Closed Off-Road Vehicle Engine N52B25A		o	GWB3668	
3.0 D (150 kW)	2004.01-	Closed Off-Road Vehicle Engine M57D30(306D2)	•		GWB3574	
	2004.01-	Closed Off-Road Vehicle Engine M57D30(306D2)		o	GWB3668	
3.0 D (160 kW)	2005.09-2007.08	Closed Off-Road Vehicle Engine M57D30(306D3)/M57N2306D2	•		GWB3574	
	2005.09-2007.08	Closed Off-Road Vehicle Engine M57D30(306D3)/M57N2306D2		o	GWB3668	
3.0 i xDrive (170 kW)	2004.03-2006.07	Closed Off-Road Vehicle Engine M54B30(306S3)	•		GWB3574	
	2004.03-2006.07	Closed Off-Road Vehicle Engine M54B30(306S3)		o	GWB3668	
3.0 SD (210 kW)	2006.08-2007.08	Closed Off-Road Vehicle Engine M57D30(306D5)	•		GWB3574	
	2006.08-2007.08	Closed Off-Road Vehicle Engine M57D30(306D5)		o	GWB3668	
3.0 Si (200 kW)	2006.08-2007.08	Closed Off-Road Vehicle Engine N52B30A	•		GWB3574	
	2006.08-2007.08	Closed Off-Road Vehicle Engine N52B30A		o	GWB3668	
xDrive 18 D (100 kW)	2009.04-	Closed Off-Road Vehicle Engine N47D20C	•		GWB3574	
	2009.04-	Closed Off-Road Vehicle Engine N47D20C		o	GWB3668	
xDrive 18 D (105 kW)	2008.09-	Closed Off-Road Vehicle Engine N47D20C	•		GWB3574	
	2008.09-	Closed Off-Road Vehicle Engine N47D20C		o	GWB3668	
xDrive 20 D (120 kW)	2008.09-	Closed Off-Road Vehicle Engine N47D20C	•		GWB3574	
	2008.09-	Closed Off-Road Vehicle Engine N47D20C		o	GWB3668	
xDrive 20 D (130 kW)	2008.09-	Closed Off-Road Vehicle Engine N47D20C	•		GWB3574	
	2008.09-	Closed Off-Road Vehicle Engine N47D20C		o	GWB3668	
xDrive 20 i (110 kW)	2008.09-	Closed Off-Road Vehicle Engine N46B20B	•		GWB3574	
	2008.09-	Closed Off-Road Vehicle Engine N46B20B		o	GWB3668	
xDrive 25 i (160 kW)	2008.09-	Closed Off-Road Vehicle Engine N52B25A	•		GWB3574	
	2008.09-	Closed Off-Road Vehicle Engine N52B25A		o	GWB3668	
xDrive 30 D (155 kW)	2008.09-	Closed Off-Road Vehicle Engine M57D30(306D3)	•		GWB3574	
	2008.09-	Closed Off-Road Vehicle Engine M57D30(306D3)		o	GWB3668	
xDrive 30 D (160 kW)	2008.09-	Closed Off-Road Vehicle Engine M57D30(306D3)	•		GWB3574	
	2008.09-	Closed Off-Road Vehicle Engine M57D30(306D3)		o	GWB3668	
xDrive 30 i (200 kW)	2008.09-	Closed Off-Road Vehicle Engine N52B30A	•		GWB3574	
	2008.09-	Closed Off-Road Vehicle Engine N52B30A		o	GWB3668	
xDrive 35 D (210 kW)	2008.09-	Closed Off-Road Vehicle Engine M57D30(306D5)	•		GWB3574	
	2008.09-	Closed Off-Road Vehicle Engine M57D30(306D5)		o	GWB3668	
X5 (E53)						
3.0 D (135 kW)	2001.05-	Closed Off-Road Vehicle Engine M57D30(306D1)	•		GWB3574	
	2001.05-	Closed Off-Road Vehicle Engine M57D30(306D1)		o	GHA245012	K
3.0 D (155 kW)	2004.08-	Closed Off-Road Vehicle Engine M57D30(306D2)	•		GWB3574	
3.0 D (160 kW)	2003.09-2007.08	Closed Off-Road Vehicle Engine M57N306D4/M57D30(306D2)	•		GWB3574	
3.0 i (163 kW)	2000.05-	Closed Off-Road Vehicle Engine M54306S3	•		GWB3574	
	2000.05-	Closed Off-Road Vehicle Engine M54306S3		o	GHA245012	K
3.0 i (170 kW)	2000.09-2007.08	Closed Off-Road Vehicle Engine M54B30(306S3)	•		GWB3574	



	 YEAR		F	R	G-AP Ref.	KIT
BMW						
X5 (E53)						
3.0 i (170 kW)	2000.09-2007.08	Closed Off-Road Vehicle Engine M54B30(306S3)		o	GHA245012	K
4.4 i (210 kW)	2000.05-	Closed Off-Road Vehicle Engine M62B44/M62B44TU	•		GWB3574	
	2000.05-	Closed Off-Road Vehicle Engine M62B44/M62B44TU		o	GHA245012	K
4.4 i (235 kW)	2003.09-2007.08	Closed Off-Road Vehicle Engine N62B44/N62B44A	•		GWB3574	
4.6 iS (255 kW)	2002.02-	Closed Off-Road Vehicle Engine M62B46(468S1)	•		GWB3574	
	2002.02-	Closed Off-Road Vehicle Engine M62B46(468S1)		o	GHA245012	K
4.8 iS (265 kW)	2004.03-2007.08	Closed Off-Road Vehicle Engine N62B48A	•		GWB3574	
X5 (E70)						
3.0 D (155 kW)	2007.02-2008.09	Closed Off-Road Vehicle Engine M57D30(306D3)		o	GHA251003	
3.0 D (173 kW)	2007.02-2008.09	Closed Off-Road Vehicle Engine M57D30(306D3)	•		GHA330026	K
	2007.02-2008.09	Closed Off-Road Vehicle Engine M57D30(306D3)		o	GHA251003	
3.0 DxD (155 kW)	2008.09-	Closed Off-Road Vehicle Engine N57D30A		o	GHA251003	
3.0 SD (210 kW)	2007.07-2009.02	Closed Off-Road Vehicle Engine M57D30(306D5)	•		GHA330026	K
	2007.07-2009.02	Closed Off-Road Vehicle Engine M57D30(306D5)		o	GHA251003	
3.0 Si (200 kW)	2007.02-2008.09	Closed Off-Road Vehicle Engine N52B30/N52B30A	•		GHA330026	K
	2007.02-2008.09	Closed Off-Road Vehicle Engine N52B30/N52B30A		o	GHA251003	
4.5 M (408 kW)	2009.04-	Closed Off-Road Vehicle Engine S63B44A		o	GHA251003	
4.8 i xDrive (261 kW)	2007.09-2008.09	Closed Off-Road Vehicle Engine N62B48B		o	GHA251003	
M 50 D (280 kW)	2011.08-	Closed Off-Road Vehicle Engine N57D30C	•		GHA330026	K
	2011.08-	Closed Off-Road Vehicle Engine N57D30C		o	GHA251003	
xDrive 30 D (173 kW)	2008.09-	Closed Off-Road Vehicle Engine N57D30A		o	GHA251003	
xDrive 30 D (180 kW)	2010.09-	Closed Off-Road Vehicle Engine N57D30A	•		GHA330026	K
	2010.09-	Closed Off-Road Vehicle Engine N57D30A		o	GHA251003	
xDrive 30 i (200 kW)	2008.09-2010.03	Closed Off-Road Vehicle Engine N52B30A		o	GHA251003	
xDrive 35 D (210 kW)	2008.09-	Closed Off-Road Vehicle Engine M57N306D5	•		GHA330026	K
	2008.09-	Closed Off-Road Vehicle Engine M57N306D5		o	GHA251003	
xDrive 35 i (225 kW)	2010.09-	Closed Off-Road Vehicle Engine N55B30A	•		GHA330026	K
	2010.09-	Closed Off-Road Vehicle Engine N55B30A		o	GHA251003	
xDrive 35 i (235 kW)	2012.02-2013.06	Closed Off-Road Vehicle Engine N55 B30 A		o	GHA251003	
xDrive 40 D (225 kW)	2010.09-	Closed Off-Road Vehicle Engine N57SD30B	•		GHA330026	K
	2010.09-	Closed Off-Road Vehicle Engine N57SD30B		o	GHA251003	
xDrive 48 i (261 kW)	2008.09-	Closed Off-Road Vehicle Engine N62B48B	•		GHA330026	K
	2008.09-	Closed Off-Road Vehicle Engine N62B48B		o	GHA251003	
xDrive 50 i (300 kW)	2010.06-	Closed Off-Road Vehicle Engine N63B44A	•		GHA330026	K
	2010.06-	Closed Off-Road Vehicle Engine N63B44A		o	GHA251003	
X5 (F15, F85)						
M (423 kW)	2014.12-	Closed Off-Road Vehicle Engine S63 B44 B		o	GHA251003	
M 50 D (280 kW)	2013.07-	Closed Off-Road Vehicle Engine N57 D30 C	•		GHA330026	K
	2013.07-	Closed Off-Road Vehicle Engine N57 D30 C		o	GHA251003	
sDrive 25 D (155 kW)	2013.11-	Closed Off-Road Vehicle Engine N47 D20 D		o	GHA251003	
sDrive 25 D (160 kW)	2013.11-	Closed Off-Road Vehicle Engine N47 D20 D		o	GHA251003	
sDrive 25 D (170 kW)	2015.07-	Closed Off-Road Vehicle Engine B47 D20 B		o	GHA251003	
xDrive 25 D (155 kW)	2013.11-	Closed Off-Road Vehicle Engine N47 D20 D		o	GHA251003	
xDrive 25 D (160 kW)	2013.11-	Closed Off-Road Vehicle Engine N47 D20 D	•		GHA330026	K
	2013.11-	Closed Off-Road Vehicle Engine N47 D20 D		o	GHA251003	
xDrive 25 D (170 kW)	2015.07-	Closed Off-Road Vehicle Engine B47 D20 B		o	GHA251003	
xDrive 30 D (190 kW)	2013.07-	Closed Off-Road Vehicle Engine N57 D30 A	•		GHA330026	K
	2013.07-	Closed Off-Road Vehicle Engine N57 D30 A		o	GHA251003	
xDrive 30 D (204 kW)	2013.11-	Closed Off-Road Vehicle Engine N57 D30 A		o	GHA251003	
xDrive 35 i (225 kW)	2013.11-	Closed Off-Road Vehicle Engine N55 B30 A	•		GHA330026	K
	2013.11-	Closed Off-Road Vehicle Engine N55 B30 A		o	GHA251003	
xDrive 35 i (240 kW)	2013.11-	Closed Off-Road Vehicle Engine N55 B30 A		o	GHA251003	
xDrive 40 D (230 kW)	2013.12-	Closed Off-Road Vehicle Engine N57 D30 B	•		GHA330026	K
	2013.12-	Closed Off-Road Vehicle Engine N57 D30 B		o	GHA251003	
xDrive 40e (155 kW)	2015.09-	Closed Off-Road Vehicle Engine N20 B20 A		o	GHA251003	
xDrive 40e (180 kW)	2015.09-	Closed Off-Road Vehicle Engine N20 B20 A		o	GHA251003	
xDrive 40e (205 kW)	2015.09-	Closed Off-Road Vehicle		o	GHA251003	
xDrive 40e (230 kW)	2015.09-	Closed Off-Road Vehicle Engine N20 B20 A		o	GHA251003	
xDrive 50 i (330 kW)	2013.07-	Closed Off-Road Vehicle Engine N63 B44 B	•		GHA330026	K
	2013.07-	Closed Off-Road Vehicle Engine N63 B44 B		o	GHA251003	
X6 (E71, E72)						
30 D (173 kW)	2008.05-	Closed Off-Road Vehicle Engine M57N2306D3	•		GHA330026	K
	2008.05-	Closed Off-Road Vehicle Engine M57N2306D3		o	GHA251003	
35 D (210 kW)	2008.05-	Closed Off-Road Vehicle Engine M57D30(306D5)	•		GHA330026	K



	 YEAR		F	R	G-AP Ref.	KIT
BMW						
X6 (E71, E72)						
35 D (210 kW)	2008.05-	Closed Off-Road Vehicle Engine M57D30(306D5)		o	GHA251003	
35 i (225 kW)	2008.05-	Closed Off-Road Vehicle Engine N54B30A	•		GHA330026	K
	2008.05-	Closed Off-Road Vehicle Engine N54B30A		o	GHA251003	
4.5 ActiveHybrid (357 kW)	2010.10-	Closed Off-Road Vehicle Engine N63B44A		o	GHA251003	
4.5 M (408 kW)	2009.09-	Closed Off-Road Vehicle Engine S63B44A		o	GHA251003	
50 i (300 kW)	2008.05-	Closed Off-Road Vehicle Engine N63B44A		o	GHA251003	
ActiveHybrid (300 kW)	2010.10-2014.06	Closed Off-Road Vehicle Engine N63 B44 A		o	GHA251003	
M 50 D (280 kW)	2011.08-	Closed Off-Road Vehicle Engine N57D30C	•		GHA330026	K
	2011.08-	Closed Off-Road Vehicle Engine N57D30C		o	GHA251003	
xDrive 30 D (155 kW)	2010.09-	Closed Off-Road Vehicle Engine N57D30A	•		GHA330026	K
	2010.09-	Closed Off-Road Vehicle Engine N57D30A		o	GHA251003	
xDrive 30 D (173 kW)	2008.09-	Closed Off-Road Vehicle Engine N57D30A		o	GHA251003	
xDrive 30 D (180 kW)	2010.09-	Closed Off-Road Vehicle Engine M57ND30(306D3)/N57D30A	•		GHA330026	K
	2010.09-	Closed Off-Road Vehicle Engine M57ND30(306D3)/N57D30A		o	GHA251003	
xDrive 35 D (210 kW)	2008.09-	Closed Off-Road Vehicle Engine M57D30(306D5)	•		GHA330026	K
	2008.09-	Closed Off-Road Vehicle Engine M57D30(306D5)		o	GHA251003	
xDrive 35 i (225 kW)	2008.09-	Closed Off-Road Vehicle Engine N54B30A/N55B30A	•		GHA330026	K
	2008.09-	Closed Off-Road Vehicle Engine N54B30A/N55B30A		o	GHA251003	
xDrive 35 i (240 kW)	2009.08-2010.03	Closed Off-Road Vehicle Engine N54 B30 A		o	GHA251003	
xDrive 40 D (225 kW)	2010.10-	Closed Off-Road Vehicle Engine N57D30B	•		GHA330026	K
	2010.10-	Closed Off-Road Vehicle Engine N57D30B		o	GHA251003	
xDrive 40 i (235 kW)	2012.01-2014.06	Closed Off-Road Vehicle Engine N55 B30 A	•		GHA330026	K
	2012.01-2014.06	Closed Off-Road Vehicle Engine N55 B30 A		o	GHA251003	
xDrive 50 i (300 kW)	2008.09-	Closed Off-Road Vehicle Engine N63B44A	•		GHA330026	K
	2008.09-	Closed Off-Road Vehicle Engine N63B44A		o	GHA251003	
xDrive 50 i (330 kW)	2009.08-2014.06	Closed Off-Road Vehicle Engine N63 B44 A		o	GHA251003	
X6 (F16, F86)						
M (423 kW)	2014.12-	Closed Off-Road Vehicle Engine S63 B44 B		o	GHA251003	
M 50 D (280 kW)	2014.08-	Closed Off-Road Vehicle Engine N57 D30 C	•		GHA330026	K
	2014.08-	Closed Off-Road Vehicle Engine N57 D30 C		o	GHA251003	
xDrive 30 D (155 kW)	2014.08-	Closed Off-Road Vehicle Engine N57 D30 A	•		GHA330026	K
	2014.08-	Closed Off-Road Vehicle Engine N57 D30 A		o	GHA251003	
xDrive 30 D (190 kW)	2014.08-	Closed Off-Road Vehicle Engine N57 D30 A	•		GHA330026	K
	2014.08-	Closed Off-Road Vehicle Engine N57 D30 A		o	GHA251003	
xDrive 30 D (204 kW)	2015.02-	Closed Off-Road Vehicle Engine N57 D30 A		o	GHA251003	
xDrive 35 i (225 kW)	2014.12-	Closed Off-Road Vehicle Engine N55 B30 A	•		GHA330026	K
	2014.12-	Closed Off-Road Vehicle Engine N55 B30 A		o	GHA251003	
xDrive 35 i (240 kW)	2015.02-	Closed Off-Road Vehicle Engine N55 B30 A		o	GHA251003	
xDrive 40 D (230 kW)	2014.12-	Closed Off-Road Vehicle Engine N57 D30 B	•		GHA330026	K
	2014.12-	Closed Off-Road Vehicle Engine N57 D30 B		o	GHA251003	
xDrive 50 i (330 kW)	2014.08-	Closed Off-Road Vehicle Engine N63 B44 B	•		GHA330026	K
	2014.08-	Closed Off-Road Vehicle Engine N63 B44 B		o	GHA251003	
Z3 (E36)						
1.8 (85 kW)	1995.10-1998.10	Convertible Engine M43B18		o	GWB3446	
1.9 (103 kW)	1995.10-1999.03	Convertible Engine M44B19/M44B19(194S1)		o	GWB3446	
1.9 (85 kW)	1999.01-2003.01	Convertible Engine M43B19(194E1)		o	GWB3446	
	1999.01-2003.01	Convertible Engine M43B19(194E1)		o	GWB3499	
1.9 (87 kW)	1998.07-2003.01	Convertible Engine M43B19(194E1)		o	GWB3446	
	1998.07-2003.01	Convertible Engine M43B19(194E1)		o	GWB3499	
2.0 (110 kW)	1999.04-2003.01	Convertible Engine M52B(206S4)/M52B20		o	GWB3499	
2.2 (125 kW)	2000.08-2003.01	Convertible Engine M54B22(226S1)		o	GWB3499	
2.8 (141 kW)	1997.04-2000.06	Convertible Engine M52B28/M52B28TU/M52B28(286S1)		o	GWB3499	
	1997.07-2000.06	Coupe Engine M52B28/M52B28(286S1)		o	GWB3499	
2.8 (143 kW)	1996.01-2000.07	Convertible Engine M52B28(286S1)/M52B28(286S2)		o	GWB3499	
3.0 (170 kW)	2000.06-2003.01	Convertible Engine M54B30(306S3)		o	GWB3499	
	2000.06-2003.06	Coupe Engine M54B30(306S3)		o	GWB3499	
M 3.2 (236 kW)	1997.03-2001.06	Convertible Engine S50B32		o	GWB3668	
	1998.02-2001.06	Coupe Engine S50B32		o	GWB3668	
M 3.2 (239 kW)	2001.06-2003.01	Convertible Engine S54B32(326S4)/S54B32		o	GWB3668	
	2001.06-2003.06	Coupe Engine S54326S4/S54B32		o	GWB3668	
Z3 (E36) M						
(252 kW)	2000.08-2003.06	Coupe Engine S50 B32 (326S4)		o	GWB3668	
3.2 (252 kW)	2000.04-2001.04	Convertible Engine S50 B32 (326S4)		o	GWB3668	



	 YEAR		F	R	G-AP Ref.	KIT
BMW						
Z4 (E85)						
2.0 i (110 kW)	2005.04-2007.08	Convertible Engine N46B20A/N46B20B		o	GWB3682	
2.2 i (125 kW)	2003.08-2005.12	Convertible Engine M54B22(226S1)		o	GWB3682	
2.5 i (130 kW)	2006.01-2007.08	Convertible Engine N52B25A		o	GWB3682	
2.5 i (141 kW)	2003.02-	Convertible Engine M54B25(256S5)		o	GWB3682	
2.5 Si (160 kW)	2006.01-2007.08	Convertible Engine N52B25A		o	GWB3682	
3.0 i (170 kW)	2003.02-	Convertible Engine M54B30(306S3)		o	GWB3682	
3.0 Si (195 kW)	2006.01-2007.08	Convertible Engine N52B30A		o	GWB3682	
M 3.2 (252 kW)	2006.01-2007.08	Convertible Engine S54B32(326S4)		o	GWB3668	
Z4 (E86)						
3.0 Si (195 kW)	2006.03-2007.08	Coupe Engine N52B30A		o	GWB3682	
M 3.2 (252 kW)	2006.03-2007.08	Coupe Engine S54B32(326S4)		o	GWB3668	
Z4 (E89)						
sDrive 18 i (115 kW)	2013.04-	Convertible Engine N20 B20 A		o	GWB3682	
sDrive 20 i (120 kW)	2011.09-	Convertible Engine N20 B20 A		o	GWB3682	
sDrive 20 i (135 kW)	2011.09-	Convertible Engine N20B20A		o	GWB3682	
sDrive 23 i (150 kW)	2009.01-	Convertible Engine N52B25A		o	GWB3682	
sDrive 28 i (180 kW)	2011.09-	Convertible Engine N20B20A		o	GWB3682	
sDrive 30 i (190 kW)	2009.01-	Convertible Engine N52B30A		o	GWB3682	
sDrive 35 i (225 kW)	2009.01-	Convertible Engine N54B30A		o	GWB3682	
sDrive 35 iS (250 kW)	2010.09-	Convertible Engine N54B30A		o	GWB3682	
Z8 (E52)						
4.9 (294 kW)	2000.06-2003.06	Convertible Engine S38B49/S62B50	•		GHA400001	K
	2000.06-2003.06	Convertible Engine S38B49/S62B50		o	GWB3668	
BUICK						
CENTURY						
2.2 (82 kW)	1991.10-1996.09	Saloon Engine LN2	•		GHA333006	
2.2 Special (87 kW)	1991.10-1996.12	Saloon Engine LN2	•		GHA333006	
3.1 (110 kW)	1991.10-1996.12	Saloon Engine LHO	•		GHA333006	
3.1 (130 kW)	1993.10-1996.09	Saloon Engine L82	•		GHA333006	
	1996.10-2005.02	Saloon Engine L82	•		GHA333083	K
CENTURY (4_35)						
2.2 (82 kW)	1991.10-1996.09	Estate Engine LN2	•		GHA333006	
2.2 Special (87 kW)	1991.10-1996.12	Estate Engine LN2	•		GHA333006	
3.1 (130 kW)	1993.10-1996.09	Estate Engine L82	•		GHA333006	
3.1 Special (110 kW)	1991.10-1996.12	Estate Engine LHO	•		GHA333006	
LE SABRE						
3.8 (127 kW)	1991.10-1995.09	Saloon Engine L27	•		GHA333006	
3.8 (153 kW)	1999.01-	Saloon Engine L36	•		GHA333083	K
PARK AVENUE						
3.8 (149 kW)	1996.10-2005.09	Saloon Engine L36	•		GHA333083	K
3.8 SuperchargeD (179 kW)	1996.10-2005.12	Saloon Engine L67	•		GHA333083	K
SKYLARK						
2.3 (119 kW)	1994.10-1995.09	Saloon Engine LD2/LD24	•		GHA333024	K
	1994.10-1995.09	Saloon Engine LD2/LD24		o	GHA400014	
2.3 (90 kW)	1993.10-1994.09	Saloon Engine L40	•		GHA333024	K
	1993.10-1994.09	Saloon Engine L40		o	GHA400014	
2.3 LimiteD (86 kW)	1992.09-1993.09	Saloon Engine L40	•		GHA333024	K
	1992.09-1993.09	Saloon Engine L40		o	GHA400014	
CADILLAC						
ALLANTE						
4.6 (220 kW)	1992.10-1993.09	Convertible Engine L37	•		GHA333006	
	1992.10-1993.09	Coupe Engine L37	•		GHA333006	
DEVILLE						
4.6 (224 kW)	1993.10-1999.09	Saloon Engine L37	•		GHA333006	
	1993.10-1999.09	Saloon Engine L37	•		GHA333083	K
4.6 Concours (205 kW)	1993.10-1999.09	Saloon Engine LD8	•		GHA333006	
	1993.10-1999.09	Saloon Engine LD8	•		GHA333083	K
4.6 DHS (205 kW)	1999.10-2005.12	Saloon Engine LD8	•		GHA333083	K
4.6 DTS (224 kW)	1999.10-2004.09	Saloon Engine L37	•		GHA333083	K
4.9 (149 kW)	1993.10-1995.09	Saloon Engine L26	•		GHA333006	
4.9 Touring (149 kW)	1990.10-1993.09	Saloon Engine L26	•		GHA333006	



	 YEAR		F	R	G-AP Ref.	KIT
CADILLAC						
ELDORADO						
4.6 (220 kW)	1991.09-1994.09	Coupe Engine L37	•		GHA333006	
4.6 (224 kW)	1994.09-2002.09	Coupe Engine L37/LD8	•		GHA333006	
	1994.09-2002.09	Coupe Engine L37/LD8	•		GHA333083	K
ESCALADE						
6.0 Hybrid (248 kW)	2010.11-2013.12	Closed Off-Road Vehicle Engine LZ1	•		GHA400286	
6.0 HYBRID AWD (248 kW)	2010.11-2013.12	Closed Off-Road Vehicle Engine LZ1	•		GHA333075	
6.2 (301 kW)	2010.01-	Pickup Engine L92/L94	•		GHA400286	
6.2 AWD (296 kW)	2006.10-2014.12	Closed Off-Road Vehicle Engine L92	•		GHA333075	
6.2 AWD (301 kW)	2006.10-2014.12	Closed Off-Road Vehicle Engine L92/L94/L9H	•		GHA333075	
	2010.01-	Pickup Engine L92 L94	•		GHA333075	
6.2 FlexFuel (301 kW)	2006.10-2014.12	Closed Off-Road Vehicle Engine L92/L94	•		GHA400286	
6.2 FlexFuel AWD (301 kW)	2006.10-2014.12	Closed Off-Road Vehicle Engine L92/L94	•		GHA333075	
FLEETWOOD						
5.7 Brougham (138 kW)	1992.09-1994.09	Saloon Engine LO5	•		GHA333006	
5.7 Brougham (194 kW)	1994.10-1997.09	Saloon Engine LT1	•		GHA333006	
SEVILLE						
4.6 (220 kW)	2000.10-2004.09	Saloon Engine L37	•		GHA333083	K
4.6 SLS V8 (205 kW)	1997.09-2004.09	Saloon Engine LH2	•		GHA333083	K
4.6 STS V8 (224 kW)	1997.09-2004.09	Saloon Engine LH2	•		GHA333083	K
SEVILLE II (K)						
4.9 (149 kW)	1990.10-1991.12	Saloon Engine L26	•		GHA333006	
XLR						
4.4 (331 kW)	2004.03-2009.09	Convertible Engine LC3	•		GHA400144	
	2004.03-2009.09	Convertible Engine LC3		o	GHA330027	
4.6 (240 kW)	2004.03-2009.09	Convertible Engine LH2	•		GHA400144	
	2004.03-2009.09	Convertible Engine LH2		o	GHA330027	
CHERY						
AMULET A15						
-	2006-			o	GHA230007	
CHEVROLET						
AVALANCHE						
5.3 FlexFuel (235 kW)	2007.01-	Pickup Engine LY5	•		GHA400286	
5.3 FlexFuel AWD (227 kW)	2007.01-	Pickup	•		GHA333075	
AVEO (T200)						
-	2003-2008		•		GHA422027	K
1.2 (53 kW)	2004.01-2008.05	Hatchback Engine F12S3	•		GWB3786	
	2004.01-2008.05	Hatchback Engine F12S3		o	GWB7573	
1.5 (62 kW)	2005.01-2008.05	Hatchback Engine F15S3	•		GWB3786	
	2005.01-2008.05	Hatchback Engine F15S3		o	GWB7573	
1.6 (77 kW)	2003.09-	Saloon Engine A16DMS/LXV	•		GWB3786	
	2003.09-	Saloon Engine A16DMS/LXV		o	GWB7573	
AVEO (T250)						
-	2006-2008		•		GHA422027	K
AVEO (T250, T255)						
1.2 (53 kW)	2006.03-2007.12	Saloon Engine F12S3/LQ5	•		GWB3786	
	2006.03-2007.12	Saloon Engine F12S3/LQ5		o	GWB7573	
	2006.03-2007.12	Saloon Engine F12S3/LQ5 With ABS		o	GHA225021	K
	2006.03-2007.12	Saloon Engine F12S3/LQ5 Without ABS		o	GHA225025	K
	2008.10-	Hatchback Engine F12S3	•		GWB3786	
	2008.10-	Hatchback Engine F12S3		o	GWB7573	
	2008.10-	Hatchback Engine F12S3 With ABS		o	GHA225021	K
	2008.10-	Hatchback Engine F12S3 Without ABS		o	GHA225025	K
1.2 (55 kW)	2008.01-	Saloon Engine B12D1/LMU	•		GWB3786	
	2008.01-	Saloon Engine B12D1/LMU		o	GWB7573	
	2008.01-	Saloon Engine B12D1/LMU With ABS		o	GHA225021	K
	2008.01-	Saloon Engine B12D1/LMU Without ABS		o	GHA225025	K
	2008.04-	Hatchback Engine LMU/B12D1	•		GWB3786	
	2008.04-	Hatchback Engine LMU/B12D1		o	GWB7573	
	2008.04-	Hatchback Engine LMU/B12D1 With ABS		o	GHA225021	K
	2008.04-	Hatchback Engine LMU/B12D1 Without ABS		o	GHA225025	K
1.2 (62 kW)	2008.01-	Saloon Engine B12D1/LMU	•		GWB3786	



	 YEAR		F	R	G-AP Ref.	KIT
CHEVROLET						
AVEO (T250, T255)						
1.2 (62 kW)	2008.01-	Saloon Engine B12D1/LMU		o	GWB7573	
	2008.01-	Saloon Engine B12D1/LMU With ABS		o	GHA225021	K
	2008.01-	Saloon Engine B12D1/LMU Without ABS		o	GHA225025	K
	2008.04-	Hatchback Engine B12D1/LMU	•		GWB3786	
	2008.04-	Hatchback Engine B12D1/LMU		o	GWB7573	
	2008.04-	Hatchback Engine B12D1/LMU With ABS		o	GHA225021	K
	2008.04-	Hatchback Engine B12D1/LMU Without ABS		o	GHA225025	K
	1.2 LPG (62 kW)	2008.04-	Hatchback Engine LMU/B12D1	•		GWB3786
2008.04-		Hatchback Engine LMU/B12D1		o	GWB7573	
2008.04-		Hatchback Engine LMU/B12D1 With ABS		o	GHA225021	K
2008.04-		Hatchback Engine LMU/B12D1 Without ABS		o	GHA225025	K
2009.01-		Saloon Engine LMU/B12D1	•		GWB3786	
2009.01-		Saloon Engine LMU/B12D1		o	GWB7573	
2009.01-		Saloon Engine LMU/B12D1 With ABS		o	GHA225021	K
2009.01-		Saloon Engine LMU/B12D1 Without ABS		o	GHA225025	K
1.4 (69 kW)	2006.03-2007.12	Saloon Engine F14D3	•		GWB3786	
	2006.03-2007.12	Saloon Engine F14D3		o	GWB7573	
	2006.03-2007.12	Saloon Engine F14D3 With ABS		o	GHA225021	K
	2006.03-2007.12	Saloon Engine F14D3 Without ABS		o	GHA225025	K
1.4 (74 kW)	2008.04-	Hatchback Engine F14D4/LDT/A14XER	•		GWB3786	
	2008.04-	Hatchback Engine F14D4/LDT/A14XER		o	GWB7573	
	2008.04-	Hatchback Engine F14D4/LDT/A14XER With ABS		o	GHA225021	K
	2008.04-	Hatchback Engine F14D4/LDT/A14XER Without ABS		o	GHA225025	K
	2008.09-	Saloon Engine F14D4	•		GWB3786	
	2008.09-	Saloon Engine F14D4		o	GWB7573	
	2008.09-	Saloon Engine F14D4 With ABS		o	GHA225021	K
	2008.09-	Saloon Engine F14D4 Without ABS		o	GHA225025	K
1.5 (62 kW)	2005.05-	Saloon Engine F15S3	•		GWB3786	
	2005.05-	Saloon Engine F15S3		o	GWB7573	
	2005.05-	Saloon Engine F15S3 With ABS		o	GHA225021	K
	2005.05-	Saloon Engine F15S3 Without ABS		o	GHA225025	K
1.6 (76 kW)	2005.05-	Saloon Engine F16D3/LXV	•		GWB3786	
	2005.05-	Saloon Engine F16D3/LXV		o	GWB7573	
	2005.05-	Saloon Engine F16D3/LXV With ABS		o	GHA225021	K
	2005.05-	Saloon Engine F16D3/LXV Without ABS		o	GHA225025	K
AVEO (T300)						
1.2 (51 kW)	2011.03-	Hatchback Engine A12XEL	•		GWB6720	
	2011.03-	Hatchback Engine A12XEL		o	GHA400259	
	2011.03-	Saloon Engine A12XEL	•		GWB6720	
	2011.03-	Saloon Engine A12XEL		o	GHA400259	
1.2 (63 kW)	2011.03-	Hatchback Engine A12XER	•		GWB6720	
	2011.03-	Hatchback Engine A12XER		o	GHA400259	
	2011.03-	Saloon Engine A12XER	•		GWB6720	
1.2 LPG (63 kW)	2011.03-	Saloon Engine A12XER		o	GHA400259	
	2012.11-	Hatchback Engine A12XER	•		GWB6720	
	2012.11-	Hatchback Engine A12XER		o	GHA400259	
	2012.11-	Saloon Engine A 12 XER	•		GWB6720	
1.3 D (55 kW)	2012.11-	Saloon Engine A 12 XER		o	GHA400259	
	2011.07-	Hatchback Engine LDV	•		GWB6720	
	2011.07-	Hatchback Engine LDV		o	GHA400259	
	2011.07-	Saloon Engine LDV	•		GWB6720	
1.3 D (70 kW)	2011.07-	Saloon Engine LDV		o	GHA400259	
	2011.07-	Hatchback Engine LSF	•		GWB6720	
	2011.07-	Hatchback Engine LSF		o	GHA400259	
	2011.07-	Saloon Engine LSF	•		GWB6720	
1.4 (74 kW)	2011.07-	Saloon Engine LSF		o	GHA400259	
	2011.03-	Hatchback Engine A14XER	•		GWB6720	
	2011.03-	Hatchback Engine A14XER		o	GHA400259	
	2011.07-	Saloon Engine A14XER	•		GWB6720	
1.4 Turbo (103 kW)	2011.07-	Saloon Engine A14XER		o	GHA400259	
	2013.08-	Hatchback Engine LUJ/LUV	•		GWB6720	
	2013.08-	Hatchback Engine LUJ/LUV		o	GHA400259	
1.6 (85 kW)	2011.03-	Hatchback Engine F16D4	•		GWB6720	
	2011.03-	Hatchback Engine F16D4		o	GHA400259	



	 YEAR		F	R	G-AP Ref.	KIT
CHEVROLET						
AVEO (T300)						
1.6 (85 kW)	2011.03-	Saloon Engine F16D4	•		GWB6720	
	2011.03-	Saloon Engine F16D4		○	GHA400259	
BERETTA (1_37)						
2.2 (71 kW)	1991.01-1996.12	Coupe Engine LN2	•		GHA333024	K
	1991.01-1996.12	Coupe Engine LN2		○	GHA400014	
2.3 (134 kW)	1992.10-1996.09	Coupe Engine LGO	•		GHA333024	K
	1992.10-1996.09	Coupe Engine LGO		○	GHA400014	
2.3 16V (130 kW)	1990.09-1996.12	Coupe Engine LGO	•		GHA333024	K
	1990.09-1996.12	Coupe Engine LGO		○	GHA400014	
3.1 LT (103 kW)	1992.10-1993.09	Coupe Engine LHO	•		GHA333024	K
	1992.10-1993.09	Coupe Engine LHO		○	GHA400014	
3.1 Z26 (119 kW)	1993.10-1996.09	Coupe Engine L82	•		GHA333024	K
	1993.10-1996.09	Coupe Engine L82		○	GHA400014	
CAPTIVA (C100, C140)						
2.0 D (110 kW)	2007.09-	Closed Off-Road Vehicle Engine Z20S	•		GHA330010	K
	2007.09-	Closed Off-Road Vehicle Engine Z20S		○	GHA330008	K
2.0 D (93 kW)	2006.10-	Closed Off-Road Vehicle Engine Z 20 S	•		GHA330010	K
	2006.10-	Closed Off-Road Vehicle Engine Z 20 S		○	GHA330008	K
2.0 D 4WD (110 kW)	2007.01-2008.03	Closed Off-Road Vehicle Engine Z20S	•		GHA330010	K
	2007.01-2008.03	Closed Off-Road Vehicle Engine Z20S		○	GHA330008	K
2.0 D 4WD (93 kW)	2006.10-	Closed Off-Road Vehicle Engine Z20S	•		GHA330010	K
	2006.10-	Closed Off-Road Vehicle Engine Z20S		○	GHA330008	K
2.2 D (120 kW)	2011.03-	Closed Off-Road Vehicle Engine Z22D1	•		GHA330032	
	2011.03-	Closed Off-Road Vehicle Engine Z22D1		○	GHA330008	K
2.2 D 4WD (120 kW)	2011.03-	Closed Off-Road Vehicle Engine Z22D1	•		GHA330032	
	2011.03-	Closed Off-Road Vehicle Engine Z22D1		○	GHA330008	K
2.2 D 4WD (135 kW)	2011.03-	Closed Off-Road Vehicle Engine A22DMH	•		GHA330032	
	2011.03-	Closed Off-Road Vehicle Engine A22DMH		○	GHA330008	K
2.4 (100 kW)	2006.06-	Closed Off-Road Vehicle Engine Z24SED	•		GHA330010	K
	2006.06-	Closed Off-Road Vehicle Engine Z24SED		○	GHA330008	K
2.4 (123 kW)	2011.03-	Closed Off-Road Vehicle Engine A24XE/LE5	•		GHA330032	
	2011.03-	Closed Off-Road Vehicle Engine A24XE/LE5		○	GHA330008	K
2.4 4WD (100 kW)	2007.01-	Closed Off-Road Vehicle Engine Z24SED	•		GHA330010	K
	2007.01-	Closed Off-Road Vehicle Engine Z24SED		○	GHA330008	K
2.4 4WD (123 kW)	2011.03-	Closed Off-Road Vehicle Engine A24XE/LE5	•		GHA330032	
	2011.03-	Closed Off-Road Vehicle Engine A24XE/LE5		○	GHA330008	K
2.4 LPG (100 kW)	2007.01-	Closed Off-Road Vehicle Engine Z24SED	•		GHA330010	K
	2007.01-	Closed Off-Road Vehicle Engine Z24SED		○	GHA330008	K
2.4 LPG 4WD (100 kW)	2007.01-	Closed Off-Road Vehicle Engine Z24SED	•		GHA330010	K
	2007.01-	Closed Off-Road Vehicle Engine Z24SED		○	GHA330008	K
3.0 4WD (190 kW)	2010.01-	Closed Off-Road Vehicle Engine A 30 XH/LF1	•		GHA330032	
	2010.01-	Closed Off-Road Vehicle Engine A 30 XH/LF1		○	GHA330008	K
3.2 4WD (169 kW)	2006.06-	Closed Off-Road Vehicle Engine 10HM	•		GHA330010	K
	2006.06-	Closed Off-Road Vehicle Engine 10HM		○	GHA330008	K
CAVALIER						
2.2 (90 kW)	1991.10-1994.12	Coupe Engine LN2	•		GHA333024	K
	1991.10-1994.12	Coupe Engine LN2		○	GHA400014	
2.2 RS (90 kW)	1991.10-1996.09	Saloon Engine LN2	•		GHA333024	K
	1991.10-1996.09	Saloon Engine LN2		○	GHA400014	
CLASSIC						
-	2004-2005			○	GHA400016	
COBALT						
1.5 (77 kW)	2014.01-	Saloon Engine L2C	•		GWB6720	
CORSICA (1_69)						
2.2 (71 kW)	1991.01-1996.12	Saloon Engine LN2	•		GHA333024	K
	1991.01-1996.12	Saloon Engine LN2		○	GHA400014	
2.2 (82 kW)	1994.01-1996.12	Saloon Engine LN2	•		GHA333024	K
	1994.01-1996.12	Saloon Engine LN2	•		GHA433013	
	1994.01-1996.12	Saloon Engine LN2		○	GHA400014	
CORVETTE						
5.7 (253 kW)	1997.01-2004.09	Coupe Engine LS1	•		GHA400144	
	1997.01-2004.09	Coupe Engine LS1		○	GHA330027	
	1997.09-2004.09	Convertible Engine LS1	•		GHA400144	



	 YEAR		F	R	G-AP Ref.	KIT
CHEVROLET						
CORVETTE						
5.7 (253 kW)	1997.09-2004.09	Convertible Engine LS1		o	GHA330027	
CORVETTE (C6)						
6 (298 kW)	2004.09-	Convertible Engine LS2	•		GHA400144	
	2004.09-	Convertible Engine LS2		o	GHA330027	
	2004.09-	Coupe Engine LS2	•		GHA400144	
	2004.09-	Coupe Engine LS2		o	GHA330027	
6.2 (316 kW)	2006.03-	Convertible Engine LS3	•		GHA400144	
	2006.03-	Convertible Engine LS3		o	GHA330027	
	2006.03-	Coupe Engine LS3	•		GHA400144	
	2006.03-	Coupe Engine LS3		o	GHA330027	
6.2 (321 kW)	2008.02-	Convertible Engine LS3	•		GHA400144	
	2008.02-	Convertible Engine LS3		o	GHA330027	
	2008.02-	Coupe Engine LS3	•		GHA400144	
	2008.02-	Coupe Engine LS3		o	GHA330027	
6.2 ZR1 (476 kW)	2008.09-	Coupe Engine LS9(6,2L)	•		GHA400144	
	2008.09-	Coupe Engine LS9(6,2L)		o	GHA330027	
Z06 7.0 (371 kW)	2006.03-	Coupe Engine LS7	•		GHA400144	
	2006.03-	Coupe Engine LS7		o	GHA330027	
Z06 7.0 (377 kW)	2006.03-	Coupe Engine LS7	•		GHA400144	
	2006.03-	Coupe Engine LS7		o	GHA330027	
CRUZE (J300)						
1.4 (74 kW)	2013.07-	Saloon Engine A 14 XER/LDD	•		GHA330019	K
1.6 (80 kW)	2009.05-	Saloon Engine F16D3/LXT/LXV	•		GHA330019	K
	2009.05-	Saloon Engine F16D3/LXT/LXV		o	GHA400193	K
	2009.05-	Saloon Engine F16D3/LXT/LXV Fits Rim Size 15(Inch)	•		GHA333080	K
	2009.05-	Saloon Engine F16D3/LXT/LXV Fits Rim Size 15(Inch)		o	GHA400164	K
1.6 (83 kW)	2009.05-	Saloon Engine F16D4	•		GHA330019	K
	2009.05-	Saloon Engine F16D4		o	GHA400193	K
	2009.05-	Saloon Engine F16D4 Fits Rim Size 15(Inch)	•		GHA333080	K
	2009.05-	Saloon Engine F16D4 Fits Rim Size 15(Inch)		o	GHA400164	K
1.6 (86 kW)	2012.12-	Saloon Engine LDE	•		GHA330019	K
1.6 (89 kW)	2012.12-	Saloon Engine F16D4	•		GHA330019	K
1.6 (91 kW)	2009.05-	Saloon Engine F16D4	•		GHA330019	K
	2009.05-	Saloon Engine F16D4		o	GHA400193	K
	2009.05-	Saloon Engine F16D4 Fits Rim Size 15(Inch)	•		GHA333080	K
	2009.05-	Saloon Engine F16D4 Fits Rim Size 15(Inch)		o	GHA400164	K
1.7 D (96 kW)	2012.01-	Saloon Engine LUD	•		GHA330019	K
	2012.01-	Saloon Engine LUD		o	GHA400193	K
	2012.01-	Saloon Engine LUD Fits Rim Size 15(Inch)		o	GHA400164	K
1.7 TD (81 kW)	2013.11-	Saloon Engine A 17 DTE	•		GHA330019	K
1.8 (103 kW)	2009.11-	Saloon Engine LUW/LWE	•		GHA330019	K
	2009.11-	Saloon Engine LUW/LWE		o	GHA400193	K
	2009.11-	Saloon Engine LUW/LWE Fits Rim Size 15(Inch)	•		GHA333080	K
	2009.11-	Saloon Engine LUW/LWE Fits Rim Size 15(Inch)		o	GHA400164	K
1.8 (104 kW)	2009.05-	Saloon Engine F18D4/2H0	•		GHA330019	K
	2009.05-	Saloon Engine F18D4/2H0		o	GHA400193	K
	2009.05-	Saloon Engine F18D4/2H0 Fits Rim Size 15(Inch)	•		GHA333080	K
	2009.05-	Saloon Engine F18D4/2H0 Fits Rim Size 15(Inch)		o	GHA400164	K
1.8 LPG (104 kW)	2011.06-	Saloon Engine 2H0 F18D4	•		GHA330019	K
	2011.06-	Saloon Engine 2H0 F18D4		o	GHA400193	K
	2011.06-	Saloon Engine 2H0 F18D4 Fits Rim Size 15(Inch)		o	GHA400164	K
2.0 CDi (110 kW)	2009.05-	Saloon Engine Z20S1	•		GHA330019	K
	2009.05-	Saloon Engine Z20S1		o	GHA400193	K
	2009.05-	Saloon Engine Z20S1 Fits Rim Size 15(Inch)	•		GHA333080	K
	2009.05-	Saloon Engine Z20S1 Fits Rim Size 15(Inch)		o	GHA400164	K
2.0 CDi (120 kW)	2010.08-	Saloon Engine Z20D1	•		GHA330019	K
	2010.08-	Saloon Engine Z20D1		o	GHA400193	K
	2010.08-	Saloon Engine Z20D1 Fits Rim Size 15(Inch)	•		GHA333080	K
	2010.08-	Saloon Engine Z20D1 Fits Rim Size 15(Inch)		o	GHA400164	K
2.0 CDi (90 kW)	2009.05-	Saloon Engine Z20S1	•		GHA330019	K
	2009.05-	Saloon Engine Z20S1		o	GHA400193	K
	2009.05-	Saloon Engine Z20S1 Fits Rim Size 15(Inch)	•		GHA333080	K
	2009.05-	Saloon Engine Z20S1 Fits Rim Size 15(Inch)		o	GHA400164	K
2.0 CDi (92 kW)	2009.05-	Saloon Engine Z20S1	•		GHA330019	K



	 YEAR		F	R	G-AP Ref.	KIT
CHEVROLET						
CRUZE (J300)						
2.0 CDi (92 kW)	2009.05-	Saloon Engine Z20S1		o	GHA400193	K
	2009.05-	Saloon Engine Z20S1 Fits Rim Size 15(Inch)	•		GHA333080	K
	2009.05-	Saloon Engine Z20S1 Fits Rim Size 15(Inch)		o	GHA400164	K
CRUZE (J305)						
1.4 (103 kW)	2012.06-	Hatchback Engine LUJ	•		GHA330019	K
1.4 (74 kW)	2013.07-	Hatchback Engine A 14 XER/LDD	•		GHA330019	K
1.6 (80 kW)	2012.01-	Hatchback Engine LXT	•		GHA330019	K
	2012.01-	Hatchback Engine LXT		o	GHA400193	K
	2012.01-	Hatchback Engine LXT Fits Rim Size 15(Inch)		o	GHA400164	K
1.6 (86 kW)	2012.12-	Hatchback Engine F16D4	•		GHA330019	K
1.6 (89 kW)	2012.12-	Hatchback Engine F16D4	•		GHA330019	K
1.6 (91 kW)	2011.06-	Hatchback Engine F16D4	•		GHA330019	K
	2011.06-	Hatchback Engine F16D4		o	GHA400193	K
	2011.06-	Hatchback Engine F16D4 Fits Rim Size 15(Inch)		o	GHA400164	K
1.7 D (96 kW)	2012.01-	Hatchback Engine LUD	•		GHA330019	K
	2012.01-	Hatchback Engine LUD		o	GHA400193	K
	2012.01-	Hatchback Engine LUD Fits Rim Size 15(Inch)		o	GHA400164	K
1.7 TD (81 kW)	2013.08-	Hatchback Engine A 17 DTE	•		GHA330019	K
1.8 (103 kW)	2011.10-	Hatchback Engine F18D4	•		GHA330019	K
	2011.10-	Hatchback Engine F18D4		o	GHA400193	K
	2011.10-	Hatchback Engine F18D4 Fits Rim Size 15(Inch)		o	GHA400164	K
1.8 (104 kW)	2011.06-	Hatchback Engine F18D4	•		GHA330019	K
	2011.06-	Hatchback Engine F18D4		o	GHA400193	K
	2011.06-	Hatchback Engine F18D4 Fits Rim Size 15(Inch)		o	GHA400164	K
1.8 LPG (104 kW)	2011.06-	Hatchback Engine F18D4	•		GHA330019	K
2.0 CDi (120 kW)	2011.06-	Hatchback Engine Z20D1	•		GHA330019	K
	2011.06-	Hatchback Engine Z20D1		o	GHA400193	K
	2011.06-	Hatchback Engine Z20D1 Fits Rim Size 15(Inch)		o	GHA400164	K
CRUZE STATION WAGON (J308)						
1.4 (103 kW)	2012.08-	Estate Engine LUJ	•		GHA330019	K
1.4 (74 kW)	2013.07-	Estate Engine A 14 XER/LDD	•		GHA330019	K
1.6 (86 kW)	2012.12-	Estate Engine LDE	•		GHA330019	K
1.6 (89 kW)	2012.12-	Estate Engine F16D4	•		GHA330019	K
1.6 (91 kW)	2012.08-	Estate Engine LDE	•		GHA330019	K
1.7 TD (96 kW)	2012.08-	Estate Engine LUD	•		GHA330019	K
1.8 (104 kW)	2012.08-	Estate Engine 2H0	•		GHA330019	K
2.0 TD (120 kW)	2012.08-	Estate Engine LNP	•		GHA330019	K
EPICA (KL1_)						
1.8 (90 kW)	2006.01-	Sedan With ABS	•		GHA328003	K
	2006.01-	Sedan With ABS		o	GHA400049	
	2006.01-	Sedan Without ABS	•		GHA328008	
	2006.01-	Sedan Without ABS		o	GHA400091	K
2.0 (105 kW)	2008.04-	Saloon Engine X20D1 With ABS	•		GHA328003	K
	2008.04-	Saloon Engine X20D1 With ABS		o	GHA400049	
	2008.04-	Saloon Engine X20D1 Without ABS	•		GHA328008	
	2008.04-	Saloon Engine X20D1 Without ABS		o	GHA400091	K
2.0 (94 kW)	2005.01-2006.12	Saloon Engine X20XEV With ABS	•		GHA328003	K
	2005.01-2006.12	Saloon Engine X20XEV With ABS		o	GHA400049	
	2005.01-2006.12	Saloon Engine X20XEV Without ABS	•		GHA328008	
	2005.01-2006.12	Saloon Engine X20XEV Without ABS		o	GHA400091	K
2.0 (96 kW)	2006.08-	Sedan With ABS	•		GHA328003	K
	2006.08-	Sedan With ABS		o	GHA400049	
	2006.08-	Sedan Without ABS	•		GHA328008	
	2006.08-	Sedan Without ABS		o	GHA400091	K
2.0 (98 kW)	2005.01-2006.12	Saloon Engine T20SED With ABS	•		GHA328003	K
	2005.01-2006.12	Saloon Engine T20SED With ABS		o	GHA400049	
	2005.01-2006.12	Saloon Engine T20SED Without ABS	•		GHA328008	
	2005.01-2006.12	Saloon Engine T20SED Without ABS		o	GHA400091	K
2.0 D (110 kW)	2008.04-	Saloon Engine Z20S With ABS	•		GHA328003	K
	2008.04-	Saloon Engine Z20S With ABS		o	GHA400049	
	2008.04-	Saloon Engine Z20S Without ABS	•		GHA328008	
	2008.04-	Saloon Engine Z20S Without ABS		o	GHA400091	K
2.5 (115 kW)	2006.06-	Saloon Engine LF4 With ABS	•		GHA328003	K
	2006.06-	Saloon Engine LF4 With ABS		o	GHA400049	



	 YEAR		F	R	G-AP Ref.	KIT
CHEVROLET						
EPICA (KL1_)						
2.5 (115 kW)	2006.06-	Saloon Engine LF4 Without ABS	•		GHA328008	
	2006.06-	Saloon Engine LF4 Without ABS		○	GHA400091	K
EVANDA						
2.0 (96 kW)	2005.03-	Saloon Engine X20SED		○	GHA400085	
	2005.03-	Saloon Engine X20SED With ABS	•		GHA328003	K
	2005.03-	Saloon Engine X20SED With ABS		○	GHA400049	
IMPALA						
3.4 V6 (134 kW)	1999.01-2005.12	Saloon Engine LA1	•		GHA333083	K
3.8 V6 (149 kW)	1999.01-2005.12	Saloon Engine L36	•		GHA333083	K
KALOS						
-	2003-2008		•		GHA422027	K
1.2 (53 kW)	2005.03-	Hatchback Engine B12S1	•		GWB3786	
	2005.03-	Hatchback Engine B12S1		○	GWB7573	
	2005.03-	Hatchback Engine B12S1 With ABS		○	GHA225021	K
	2005.03-	Hatchback Engine B12S1 Without ABS		○	GHA225025	K
	2005.03-	Saloon Engine F12S3	•		GWB3786	
	2005.03-	Saloon Engine F12S3		○	GWB7573	
	2005.03-	Saloon Engine F12S3 With ABS		○	GHA225021	K
	2005.03-	Saloon Engine F12S3 Without ABS		○	GHA225025	K
1.4 (61 kW)	2005.03-	Hatchback Engine F14S3	•		GWB3786	
	2005.03-	Hatchback Engine F14S3		○	GWB7573	
	2005.03-	Hatchback Engine F14S3 With ABS		○	GHA225021	K
	2005.03-	Hatchback Engine F14S3 Without ABS		○	GHA225025	K
	2005.03-	Saloon Engine F14S3	•		GWB3786	
	2005.03-	Saloon Engine F14S3		○	GWB7573	
	2005.03-	Saloon Engine F14S3 With ABS		○	GHA225021	K
	2005.03-	Saloon Engine F14S3 Without ABS		○	GHA225025	K
1.4 16V (69 kW)	2005.03-	Hatchback Engine F14D3	•		GWB3786	
	2005.03-	Hatchback Engine F14D3		○	GWB7573	
	2005.03-	Hatchback Engine F14D3 With ABS		○	GHA225021	K
	2005.03-	Hatchback Engine F14D3 Without ABS		○	GHA225025	K
	2005.03-	Saloon Engine F14D3	•		GWB3786	
	2005.03-	Saloon Engine F14D3		○	GWB7573	
	2005.03-	Saloon Engine F14D3 With ABS		○	GHA225021	K
	2005.03-	Saloon Engine F14D3 Without ABS		○	GHA225025	K
LACETTI						
1.4 (69 kW)	2005.03-2013.03	Saloon Engine F14D3	•		GWB3902	
	2005.03-2013.03	Saloon Engine F14D3 With ABS		○	GHA400049	
	2005.03-2013.03	Saloon Engine F14D3 Without ABS		○	GHA400091	K
1.6 (80 kW)	2005.03-2013.03	Saloon Engine F16D3	•		GWB3902	
	2005.03-2013.03	Saloon Engine F16D3 With ABS		○	GHA400049	
	2005.03-2013.03	Saloon Engine F16D3 Without ABS		○	GHA400091	K
LACETTI (J200)						
1.4 (70 kW)	2005.3-	Estate Engine	•		GWB3902	
	2005.3-	Estate Engine With ABS		○	GHA400049	
	2005.3-	Estate Engine Without ABS		○	GHA400091	K
1.4 16V (70 kW)	2005.03-	Hatchback Engine F14D3	•		GWB3902	
	2005.03-	Hatchback Engine F14D3		○	GHA400085	
	2005.03-	Hatchback Engine F14D3 With ABS		○	GHA400049	
	2005.03-	Hatchback Engine F14D3 Without ABS		○	GHA400091	K
1.6 (80 kW)	2005.03-	Estate Engine F16D3	•		GWB3902	
	2005.03-	Estate Engine F16D3 With ABS		○	GHA400049	
	2005.03-	Estate Engine F16D3 Without ABS		○	GHA400091	K
	2005.03-	Hatchback Engine F16D3	•		GWB3902	
	2005.03-	Hatchback Engine F16D3		○	GHA400085	
	2005.03-	Hatchback Engine F16D3 With ABS		○	GHA400049	
	2005.03-	Hatchback Engine F16D3 Without ABS		○	GHA400091	K
1.8 (67 kW)	2005.03-2009.12	Hatchback Engine F18D2	•		GWB3902	
	2005.03-2009.12	Hatchback Engine F18D2 With ABS		○	GHA400049	
	2005.03-2009.12	Hatchback Engine F18D2 Without ABS		○	GHA400091	K
1.8 (89 kW)	2005.08-	Hatchback Engine F18D3	•		GWB3902	
	2005.08-	Hatchback Engine F18D3		○	GHA400085	
	2005.08-	Hatchback Engine F18D3 With ABS		○	GHA400049	



	 YEAR		F	R	G-AP Ref.	KIT
CHEVROLET						
LACETTI (J200)						
1.8 (89 kW)	2005.08-	Hatchback Engine F18D3 Without ABS		o	GHA400091	K
	2005.8-	Estate Engine T18SED	•		GWB3902	
	2005.8-	Estate Engine T18SED With ABS		o	GHA400049	
	2005.8-	Estate Engine T18SED Without ABS		o	GHA400091	K
1.8 (90 kW)	2005.03-	Hatchback Engine T18SED	•		GWB3902	
	2005.03-	Hatchback Engine T18SED With ABS		o	GHA400049	
	2005.03-	Hatchback Engine T18SED Without ABS		o	GHA400091	K
2.0 D (89 kW)	2007.01-	Hatchback Engine Z20DM	•		GWB3902	
	2007.01-	Hatchback Engine Z20DM		o	GHA400085	
	2007.01-	Hatchback Engine Z20DM With ABS		o	GHA400049	
	2007.01-	Hatchback Engine Z20DM Without ABS		o	GHA400091	K
	2007.1-	Estate Engine	•		GWB3902	
	2007.1-	Estate Engine With ABS		o	GHA400049	
	2007.1-	Estate Engine Without ABS		o	GHA400091	K
LACETTI / OPTRA (J200)						
-	2003-2008		•		GHA433010	
LUMINA APV						
2.3 (101 kW)	1993.10-1996.07	MPV Engine LD2	•		GHA333006	
2.3 (108 kW)	1992.12-1996.07	MPV Engine LD2	•		GHA333006	
3.1 (119 kW)	1994.01-1996.07	MPV Engine L82	•		GHA333006	
3.8 (123 kW)	1991.10-1995.09	MPV Engine L27	•		GHA333006	
3.8 (129 kW)	1992.12-1996.07	MPV Engine L27	•		GHA333006	
MALIBU						
-	2001-2003			o	GHA400016	
MALIBU (V300)						
2.0 D (118 kW)	2012.04-	Saloon Engine LBS Without ABS	•		GHA330024	K
	2012.04-	Saloon Engine LBS Without ABS		o	GHA330024	S
2.4 (123 kW)	2012.01-	Saloon Engine LE9 Without ABS	•		GHA330024	K
	2012.01-	Saloon Engine LE9 Without ABS		o	GHA330024	S
MATIZ (M200, M250)						
0.8 (38 kW)	2005.03-	Hatchback Engine F8CV	•		GHA423018	
	2005.03-	Hatchback Engine F8CV	•		GWB3901	
	2005.03-	Hatchback Engine F8CV		o	GWB3796	
0.8 LPG (38 kW)	2005.03-	Hatchback Engine F8CV	•		GHA423018	
	2005.03-	Hatchback Engine F8CV	•		GWB3901	
	2005.03-	Hatchback Engine F8CV		o	GWB3796	
1.0 (47 kW)	2005.03-	Hatchback Engine B10S	•		GHA423018	
	2005.03-	Hatchback Engine B10S	•		GWB3901	
	2005.03-	Hatchback Engine B10S		o	GWB3796	
1.0 (48 kW)	2007.01-	Hatchback Engine LA2	•		GWB3901	
	2007.01-	Hatchback Engine LA2		o	GWB3796	
1.0 (49 kW)	2005.03-	Hatchback Engine B10S1	•		GHA423018	
	2005.03-	Hatchback Engine B10S1	•		GWB3901	
	2005.03-	Hatchback Engine B10S1		o	GWB3796	
1.0 LPG (49 kW)	2005.03-	Hatchback Engine B10S1	•		GHA423018	
	2005.03-	Hatchback Engine B10S1	•		GWB3901	
	2005.03-	Hatchback Engine B10S1		o	GWB3796	
NUBIRA						
1.4 (69 kW)	2005.1-	Saloon Engine F14D3	•		GWB3902	
	2005.1-	Saloon Engine F14D3 With ABS		o	GHA400049	
1.4 (70 kW)	2006.01-	Saloon Engine F14D3	•		GWB3902	
	2006.01-	Saloon Engine F14D3 With ABS		o	GHA400049	
1.6 (80 kW)	2005.03-	Estate Engine F16D3	•		GWB3902	
	2005.03-	Estate Engine F16D3		o	GHA400085	
	2005.03-	Estate Engine F16D3 With ABS		o	GHA400049	
	2005.03-	Saloon Engine F16D3	•		GWB3902	
	2005.03-	Saloon Engine F16D3		o	GHA400085	
	2005.03-	Saloon Engine F16D3 With ABS		o	GHA400049	
1.8 (89 kW)	2005.08-	Estate Engine F18D3	•		GWB3902	
	2005.08-	Estate Engine F18D3		o	GHA400085	
	2005.08-	Estate Engine F18D3 With ABS		o	GHA400049	
	2006.01-	Saloon Engine F18D3	•		GWB3902	
	2006.01-	Saloon Engine F18D3 With ABS		o	GHA400049	



	 YEAR		F	R	G-AP Ref.	KIT
CHEVROLET						
NUBIRA						
1.8 (90 kW)	2005.03-	Estate Engine T18SED	•		GWB3902	
	2005.03-	Estate Engine T18SED		○	GHA400085	
	2005.03-	Estate Engine T18SED With ABS		○	GHA400049	
	2005.03-	Saloon Engine T18SED	•		GWB3902	
	2005.03-	Saloon Engine T18SED		○	GHA400085	
	2005.03-	Saloon Engine T18SED With ABS		○	GHA400049	
2.0 D (89 kW)	2005.01-	Saloon Engine Z20S	•		GWB3902	
	2005.01-	Saloon Engine Z20S		○	GHA400085	
	2005.01-	Saloon Engine Z20S With ABS		○	GHA400049	
	2007.01-	Estate Engine Z20DM/Z20S	•		GWB3902	
	2007.01-	Estate Engine Z20DM/Z20S		○	GHA400085	
	2007.01-	Estate Engine Z20DM/Z20S With ABS		○	GHA400049	
OPTRA (1J_)						
1.6 (78 kW)	2003.08-2008.12	Saloon Engine LXT	•		GWB3902	
	2003.08-2008.12	Saloon Engine LXT With ABS		○	GHA400049	
	2003.08-2008.12	Saloon Engine LXT Without ABS		○	GHA400091	K
1.6 (80 kW)	2003.08-2008.12	Saloon Engine F16D3	•		GWB3902	
	2003.08-2008.12	Saloon Engine F16D3 With ABS		○	GHA400049	
	2003.08-2008.12	Saloon Engine F16D3 Without ABS		○	GHA400091	K
1.8 (90 kW)	2003.08-2008.12	Saloon Engine T18SED	•		GWB3902	
	2003.08-2008.12	Saloon Engine T18SED With ABS		○	GHA400049	
	2003.08-2008.12	Saloon Engine T18SED Without ABS		○	GHA400091	K
2.0 (97 kW)	2003.8-2008.12	Saloon Engine	•		GWB3902	
	2003.8-2008.12	Saloon Engine With ABS		○	GHA400049	
	2003.8-2008.12	Saloon Engine Without ABS		○	GHA400091	K
OPTRA Estate						
1.6 (80 kW)	2006.6-2008.12	Estate Engine F16D3	•		GWB3902	
	2006.6-2008.12	Estate Engine F16D3 With ABS		○	GHA400049	
	2006.6-2008.12	Estate Engine F16D3 Without ABS		○	GHA400091	K
ORLANDO (J309)						
1.4 (103 kW)	2012.06-	MPV Engine LUJ	•		GHA330019	K
	2012.06-	MPV Engine LUJ		○	GHA400193	K
1.8 (104 kW)	2011.02-	MPV Engine 2H0/F18D4	•		GHA330019	K
	2011.02-	MPV Engine 2H0/F18D4		○	GHA400193	K
1.8 LPG (104 kW)	2011.06-	MPV Engine 2H0	•		GHA330019	K
	2011.06-	MPV Engine 2H0		○	GHA400193	K
2.0 D (120 kW)	2011.02-	MPV Engine Z20D1	•		GHA330019	K
	2011.02-	MPV Engine Z20D1		○	GHA400193	K
2.0 D (96 kW)	2011.02-	MPV Engine Z20D1	•		GHA330019	K
	2011.02-	MPV Engine Z20D1		○	GHA400193	K
2.0 LPG (103 kW)	2012.02-	MPV Engine LTD	•		GHA330019	K
	2012.02-	MPV Engine LTD		○	GHA400193	K
PRIZM						
-	1998-2002		•		GHA426023	K
SILVERADO 1500						
5.3 AWD (232 kW)	2007.01-	Pickup Engine LH6	•		GHA333075	
5.3 FlexFuel AWD (232 kW)	2007.01-	Pickup	•		GHA333075	
SILVERADO 2500						
6.0 AWD (224 kW)	1999.10-	Pickup Engine LQ4	•		GHA333027	
SILVERADO 3500						
-	2001-2007		•		GHA333068	
SPARK						
0.8 (37 kW)	2005.05-	Hatchback Engine F8CV	•		GWB3901	
	2005.05-	Hatchback Engine F8CV		○	GWB3796	
0.8 (38 kW)	2000.09-2004.12	Hatchback Engine F8CV	•		GWB3901	
	2000.09-2004.12	Hatchback Engine F8CV		○	GWB3796	
1.0 SX (44 kW)	2009.06-	Hatchback Engine LA2	•		GWB3901	
	2009.06-	Hatchback Engine LA2		○	GWB3796	
1.0 SX (46 kW)	2005.05-	Hatchback Engine B10S/LA2	•		GWB3901	
	2005.05-	Hatchback Engine B10S/LA2		○	GWB3796	
1.0 SX (49 kW)	2005.05-	Hatchback Engine B10S1	•		GWB3901	
	2005.05-	Hatchback Engine B10S1		○	GWB3796	



	 YEAR		F	R	G-AP Ref.	KIT
CHEVROLET						
SPARK (M300)						
1.0 (50 kW)	2010.03-	Hatchback Engine B10D1	•		GWB3786	
	2010.03-	Hatchback Engine B10D1		○	GWB7573	
1.0 LPG (48 kW)	2010.07-	Hatchback Engine B10D1	•		GWB3786	
	2010.07-	Hatchback Engine B10D1		○	GWB7573	
1.0 LPG (50 kW)	2010.03-	Hatchback Engine B10D1	•		GWB3786	
	2010.03-	Hatchback Engine B10D1		○	GWB7573	
1.2 (60 kW)	2010.03-	Hatchback Engine LMU/B12D1	•		GWB3786	
	2010.03-	Hatchback Engine LMU/B12D1		○	GWB7573	
1.2 LPG (60 kW)	2010.03-	Hatchback Engine LMU/B12D1	•		GWB3786	
	2010.03-	Hatchback Engine LMU/B12D1		○	GWB7573	
SUBURBAN (GMT 900)						
5.3 FlexFuel 4WD (228 kW)	2007.01-	Closed Off-Road Vehicle Engine LMG	•		GHA333075	
TACUMA						
1.6 (77 kW)	2005.03-	MPV Engine A16DMS	•		GWB3902	
	2005.03-	MPV Engine A16DMS		○	GHA230119	K
1.6 (79 kW)	2005.08-	MPV Engine A16DMS	•		GWB3902	
	2005.08-	MPV Engine A16DMS		○	GHA230119	K
2.0 (89 kW)	2005.03-	MPV Engine T20SED	•		GWB3902	
	2005.03-	MPV Engine T20SED		○	GHA230119	K
2.0 (90 kW)	2005.08-	MPV Engine T20SED	•		GWB3902	
	2005.08-	MPV Engine T20SED		○	GHA230119	K
TAHOE (B2W)						
4.8 V8 (206 kW)	1999.12-2006.12	Closed Off-Road Vehicle Engine LR4	•		GHA333027	
5.3 (201 kW)	2000.05-2002.09	Closed Off-Road Vehicle Engine LM7	•		GHA333027	
5.3 (213 kW)	2002.10-2006.12	Closed Off-Road Vehicle Engine L59	•		GHA333027	
5.3 AWD (213 kW)	2002.10-2006.12	Closed Off-Road Vehicle Engine L59	•		GHA333027	
5.3 V8 AWD (201 kW)	1999.12-2006.12	Closed Off-Road Vehicle Engine LM7	•		GHA333027	
TRAILBLAZER (KC_)						
4.2 AWD (201 kW)	2001.09-2008.09	Closed Off-Road Vehicle Engine LL8	•		GHA327027	
TRAX						
1.4 (103 kW)	2012.12-	Closed Off-Road Vehicle Engine LUJ	•		GWB6720	
	2012.12-	Closed Off-Road Vehicle Engine LUJ		○	GHA400259	
1.4 AWD (103 kW)	2012.12-	Closed Off-Road Vehicle Engine LUJ	•		GWB6720	
1.4 LPG (103 kW)	2013.04-	Closed Off-Road Vehicle Engine A 14 NET/B 14 NET	•		GWB6720	
	2013.04-	Closed Off-Road Vehicle Engine A 14 NET/B 14 NET		○	GHA400259	
1.6 (85 kW)	2012.12-	Closed Off-Road Vehicle Engine F16D4/LDE	•		GWB6720	
	2012.12-	Closed Off-Road Vehicle Engine F16D4/LDE		○	GHA400259	
1.7 TD (96 kW)	2012.12-	Closed Off-Road Vehicle Engine LUD	•		GWB6720	
	2012.12-	Closed Off-Road Vehicle Engine LUD		○	GHA400259	
1.7 TD AWD (96 kW)	2012.12-	Closed Off-Road Vehicle Engine LUD	•		GWB6720	
1.8 (103 kW)	2013.03-	Closed Off-Road Vehicle Engine 2H0/F18D4	•		GWB6720	
	2013.03-	Closed Off-Road Vehicle Engine 2H0/F18D4		○	GHA400259	
VIVANT						
1.6 (77 kW)	2005.1-	MPV Engine A16DMS	•		GWB3902	
	2005.1-	MPV Engine A16DMS		○	GHA230119	K
2.0 CX (89 kW)	2005.1-	MPV Engine T20SED	•		GWB3902	
	2005.1-	MPV Engine T20SED		○	GHA230119	K
CHRYSLER						
300 C						
3.0 CRD (176 kW)	2011.09-	Saloon Engine EXF		○	GHA3332020	
3.6 (210 kW)	2011.09-	Saloon Engine ERB		○	GHA3332020	
3.6 (215 kW)	2011.07-	Saloon Engine ERB		○	GHA3332020	
300 C (LX)						
2.7 (130 kW)	2007.01-2012.11	Saloon Engine EES	•		GHA237013	
	2007.01-2012.11	Saloon Engine EES		○	GHA327040	K
	2007.01-2012.11	Saloon Engine EES		○	GHA3332020	
2.7 (142 kW)	2004.09-2012.11	Saloon Engine 2.7FX/EER	•		GHA237013	
	2004.09-2012.11	Saloon Engine 2.7FX/EER		○	GHA327040	K
	2004.09-2012.11	Saloon Engine 2.7FX/EER		○	GHA3332020	
3.0 CRD (160 kW)	2005.08-2007.12	Saloon Engine M664	•		GHA237013	
	2005.08-2007.12	Saloon Engine M664		○	GHA327040	K
	2005.08-2007.12	Saloon Engine M664		○	GHA3332020	



	 YEAR		F	R	G-AP Ref.	KIT
CHRYSLER						
300 C (LX)						
3.0 V6 CRD (155 kW)	2010.11-2012.11	Saloon Engine EXL	•		GHA237013	
	2010.11-2012.11	Saloon Engine EXL		◦	GHA332020	
3.5 (183 kW)	2005.08-2008.02	Saloon Engine 3.5CSP	•		GHA237013	
	2005.08-2008.02	Saloon Engine 3.5CSP		◦	GHA327040	K
	2005.08-2008.02	Saloon Engine 3.5CSP		◦	GHA332020	
3.5 (186 kW)	2005.01-2010.12	Saloon Engine EEG	•		GHA237013	
	2005.01-2010.12	Saloon Engine EEG		◦	GHA327040	K
	2005.01-2010.12	Saloon Engine EEG		◦	GHA332020	
5.7 SRT-8 (250 kW)	2004.09-2012.11	Saloon Engine EZB/EZD/EZH	•		GHA237013	
	2004.09-2012.11	Saloon Engine EZB/EZD/EZH		◦	GHA327040	K
	2004.09-2012.11	Saloon Engine EZB/EZD/EZH		◦	GHA332020	
6.1 SRT-8 (317 kW)	2006.08-2008.02	Saloon Engine ESF	•		GHA237013	
	2006.08-2008.02	Saloon Engine ESF		◦	GHA327040	K
	2006.08-2008.02	Saloon Engine ESF		◦	GHA332020	
300 C TOURING (LX)						
2.7 (130 kW)	2007.01-2010.12	Estate Engine EES	•		GHA237013	
	2007.01-2010.12	Estate Engine EES		◦	GHA327040	K
	2007.01-2010.12	Estate Engine EES		◦	GHA332020	
2.7 (142 kW)	2004.09-2010.12	Estate Engine 2.7FX/EER	•		GHA237013	
	2004.09-2010.12	Estate Engine 2.7FX/EER		◦	GHA327040	K
	2004.09-2010.12	Estate Engine 2.7FX/EER		◦	GHA332020	
3.0 CRD (160 kW)	2005.09-2010.12	Estate Engine M664	•		GHA237013	
	2005.09-2010.12	Estate Engine M664		◦	GHA327040	K
	2005.09-2010.12	Estate Engine M664		◦	GHA332020	
3.5 (183 kW)	2004.09-2010.12	Estate Engine 3.5CSP/EEG	•		GHA237013	
	2004.09-2010.12	Estate Engine 3.5CSP/EEG		◦	GHA327040	K
	2004.09-2010.12	Estate Engine 3.5CSP/EEG		◦	GHA332020	
3.5 AWD (183 kW)	2004.09-2010.12	Estate Engine 3.5CSP		◦	GHA327040	K
	2004.09-2010.12	Estate Engine 3.5CSP		◦	GHA332020	
5.7 (250 kW)	2004.09-2010.12	Estate Engine EZB/EZD/EZH	•		GHA237013	
	2004.09-2010.12	Estate Engine EZB/EZD/EZH		◦	GHA327040	K
	2004.09-2010.12	Estate Engine EZB/EZD/EZH		◦	GHA332020	
5.7 AWD (250 kW)	2005.04-2010.12	Estate Engine EZB/EZH		◦	GHA327040	K
	2005.04-2010.12	Estate Engine EZB/EZH		◦	GHA332020	
6.1 SRT-8 (317 kW)	2005.06-2010.12	Estate Engine ESF	•		GHA237013	
	2005.06-2010.12	Estate Engine ESF		◦	GHA327040	K
	2005.06-2010.12	Estate Engine ESF		◦	GHA332020	
300 M (LR)						
2.7 V6 24V (149 kW)	1998.11-2000.08	Saloon Engine EER	•		GHA333031	
	1998.11-2000.08	Saloon Engine EER With ABS		◦	GHA232005	
2.7 V6 24V (150 kW)	2000.08-2004.09	Saloon Engine EER	•		GHA333031	
	2000.08-2004.09	Saloon Engine EER With ABS		◦	GHA232005	
3.5 V6 24V (185 kW)	2000.08-2004.09	Saloon Engine EGG	•		GHA333031	
	2000.08-2004.09	Saloon Engine EGG With ABS		◦	GHA232005	
3.5 V6 24V (187 kW)	1998.07-2000.08	Saloon Engine EGG	•		GHA333031	
	1998.07-2000.08	Saloon Engine EGG With ABS		◦	GHA232005	
CIRRUS						
2.0 LX (96 kW)	1994.05-1997.09	Saloon Engine ECB		◦	GHA228011	
2.0 LX (98 kW)	1997.10-2000.09	Saloon Engine ECB		◦	GHA228011	
2.5 LX (120 kW)	1994.10-2000.09	Saloon Engine EEB		◦	GHA228011	
GRAND VOYAGER V (RT)						
2.8 CRD (120 kW)	2007.10-	MPV	•		GHA332002	
	2007.10-	MPV		◦	GHA400175	
	2007.10-	MPV Engine ENS	•		GHA332002	
	2007.10-	MPV Engine ENS		◦	GHA400175	
3.3 (125 kW)	2008.01-	MPV Engine EGV		◦	GHA400175	
3.6 (208 kW)	2011.02-	MPV Engine ERB	•		GHA332002	
3.8 (142 kW)	2007.10-	MPV Engine EGL		◦	GHA400175	
NEON (PL)						
1.8 16V (85 kW)	1997.09-1999.08	Saloon Engine EBD		◦	GHA228073	
	1997.09-1999.08	Saloon Engine EBD With ABS 5 hole		◦	GHA228016	
2.0 16V (107 kW)	1994.06-1999.08	Saloon Engine ECC		◦	GHA228073	
2.0 16V (109 kW)	1996.04-1999.08	Saloon Engine 420T		◦	GHA228073	



	 YEAR		F	R	G-AP Ref.	KIT
CHRYSLER						
NEON (PL)						
2.0 16V (98 kW)	1994.05-1999.08	Saloon Engine 420H		o	GHA228073	
NEON II						
1.6 (85 kW)	2001.11-2006.12	Saloon Engine EJD	•		GWB6590	
	2001.11-2006.12	Saloon Engine EJD	•		GWB6591	
	2001.11-2006.12	Saloon Engine EJD With ABS		o	GHA228048	
	2001.11-2006.12	Saloon Engine EJD Without ABS		o	GHA228013	
1.8 (91 kW)	2000.01-	Saloon Engine EBD	•		GWB6590	
	2000.01-	Saloon Engine EBD	•		GWB6591	
	2000.01-	Saloon Engine EBD With ABS		o	GHA228048	
2.0 16V (97 kW)	2002.10-2006.12	Saloon Engine ECB	•		GWB6591	
	2002.10-2006.12	Saloon Engine ECB With ABS		o	GHA228048	
2.0 16V (98 kW)	1999.08-2006.12	Saloon Engine 420H	•		GWB6590	
	1999.08-2006.12	Saloon Engine 420H	•		GWB6591	
	1999.08-2006.12	Saloon Engine 420H With ABS		o	GHA228048	
	1999.08-2006.12	Saloon Engine 420H Without ABS		o	GHA228013	
2.0 16V R/T (110 kW)	2001.10-2006.12	Saloon Engine ECH	•		GWB6590	
	2001.10-2006.12	Saloon Engine ECH	•		GWB6591	
	2001.10-2006.12	Saloon Engine ECH With ABS		o	GHA228048	
	2001.10-2006.12	Saloon Engine ECH Without ABS		o	GHA228013	
PACIFICA						
-	2004-2006		•		GHA326034	
	2004-2006			o	GHA326047	
PT CRUISER						
2.4 (105 kW)	2004.11-2006.10	Convertible Engine EDZ	•		GWB6591	
	2004.11-2006.10	Convertible Engine EDZ With ABS		o	GHA228048	
	2004.11-2006.10	Convertible Engine EDZ Without ABS		o	GHA228013	
2.4 GT (164 kW)	2004.03-2008.03	Convertible Engine EDV	•		GWB6591	
	2004.03-2008.03	Convertible Engine EDV With ABS		o	GHA228048	
	2004.03-2008.03	Convertible Engine EDV Without ABS		o	GHA228013	
PT CRUISER (PT_)						
1.6 (85 kW)	2001.11-2010.12	Estate Engine EJD	•		GWB6590	
	2001.11-2010.12	Estate Engine EJD	•		GWB6591	
	2001.11-2010.12	Estate Engine EJD		o	GHA228071	
	2001.11-2010.12	Estate Engine EJD With ABS		o	GHA228048	
	2001.11-2010.12	Estate Engine EJD Without ABS		o	GHA228013	
2.0 (100 kW)	2004.10-2010.12	Estate Engine ECC	•		GWB6591	
	2004.10-2010.12	Estate Engine ECC With ABS		o	GHA228048	
	2004.10-2010.12	Estate Engine ECC Without ABS		o	GHA228013	
2.0 (104 kW)	2000.06-2010.12	Estate Engine ECC	•		GWB6590	
	2000.06-2010.12	Estate Engine ECC	•		GWB6591	
	2000.06-2010.12	Estate Engine ECC		o	GHA228071	
	2000.06-2010.12	Estate Engine ECC With ABS		o	GHA228048	
	2000.06-2010.12	Estate Engine ECC Without ABS		o	GHA228013	
2.2 CRD (110 kW)	2005.08-2010.12	Estate Engine EDJ	•		GWB6591	
	2005.08-2010.12	Estate Engine EDJ With ABS		o	GHA228048	
	2005.08-2010.12	Estate Engine EDJ Without ABS		o	GHA228013	
2.2 CRD (89 kW)	2002.03-2010.12	Estate Engine EDJ	•		GWB6590	
	2002.03-2010.12	Estate Engine EDJ	•		GWB6591	
	2002.03-2010.12	Estate Engine EDJ With ABS		o	GHA228048	
	2002.03-2010.12	Estate Engine EDJ Without ABS		o	GHA228013	
2.4 (105 kW)	2005.08-2010.12	Estate Engine EDZ	•		GWB6591	
	2005.08-2010.12	Estate Engine EDZ With ABS		o	GHA228048	
	2005.08-2010.12	Estate Engine EDZ Without ABS		o	GHA228013	
2.4 (110 kW)	2000.06-2010.12	Estate Engine EDZ	•		GWB6590	
	2000.06-2010.12	Estate Engine EDZ	•		GWB6591	
	2000.06-2010.12	Estate Engine EDZ		o	GHA228071	
	2000.06-2010.12	Estate Engine EDZ With ABS		o	GHA228048	
	2000.06-2010.12	Estate Engine EDZ Without ABS		o	GHA228013	
2.4 (169 kW)	2004.09-2010.12	Estate Engine EDV	•		GWB6591	
	2004.09-2010.12	Estate Engine EDV With ABS		o	GHA228048	
2.4 GT (164 kW)	2003.08-2010.12	Estate Engine EDV	•		GWB6591	
	2003.08-2010.12	Estate Engine EDV With ABS		o	GHA228048	
	2003.08-2010.12	Estate Engine EDV Without ABS		o	GHA228013	



	 YEAR		F	R	G-AP Ref.	KIT
CHRYSLER						
SEBRING (JR)						
2.0 (104 kW)	2001.04-2007.06	Convertible Engine ECC		o	GHA228011	
	2001.04-2007.06	Saloon Engine ECC	•		GHA326008	
	2001.04-2007.06	Saloon Engine ECC		o	GHA228011	
2.4 (112 kW)	2001.04-2007.06	Convertible Engine EDZ		o	GHA228011	
	2001.04-2007.06	Saloon Engine EDZ	•		GHA326008	
	2001.04-2007.06	Saloon Engine EDZ		o	GHA228011	
2.7 V6 24V (149 kW)	2001.04-2007.06	Convertible Engine EES	•		GHA326008	
	2001.04-2007.06	Convertible Engine EES		o	GHA228011	
	2001.04-2007.06	Saloon Engine EES/EER	•		GHA326008	
	2001.04-2007.06	Saloon Engine EES/EER		o	GHA228011	
SEBRING (JS)						
2.0 CRD (103 kW)	2007.07-2010.12	Convertible Engine ECD	•		GHA332001	K
	2007.07-2010.12	Convertible Engine ECD Without ABS		o	GHA400192	
	2007.07-2010.12	Saloon Engine ECD	•		GHA332001	K
	2007.07-2010.12	Saloon Engine ECD Without ABS		o	GHA400192	
2.0 VVT (115 kW)	2007.07-2010.12	Saloon Engine ECN	•		GHA332001	K
	2007.07-2010.12	Saloon Engine ECN Without ABS		o	GHA400192	
2.7 (137 kW)	2007.07-2010.12	Convertible Engine EER	•		GHA332001	K
	2007.07-2010.12	Convertible Engine EER	•		GHA332010	K
	2007.07-2010.12	Convertible Engine EER Without ABS		o	GHA400192	
STRATUS (JA)						
2.0 16V (98 kW)	1995.12-2001.04	Saloon Engine ECB	•		GHA326008	
2.0 LE (96 kW)	1995.12-2001.04	Saloon Engine C00	•		GHA326008	
2.4 16V (103 kW)	1995.12-2001.04	Saloon Engine EDZ	•		GHA326008	
2.4 16V (112 kW)	1995.12-2001.04	Saloon Engine EDZ	•		GHA326008	
2.5 LX V6 (120 kW)	1995.12-2001.04	Saloon Engine H00/EEB	•		GHA326008	
2.5 V6 (125 kW)	1995.12-2001.04	Saloon Engine H00	•		GHA326008	
STRATUS (JX)						
2.0 LE (96 kW)	1996.06-2001.04	Convertible Engine 420X	•		GHA326008	
2.5 LX (120 kW)	1996.04-2001.04	Convertible Engine 625H	•		GHA326008	
TOWN & COUNTRY						
-	1992-1995		•		GHA426023	K
VOYAGER II (ES)						
2.5 i (72 kW)	1991.01-1995.09	MPV Engine K00	•		GHA326017	K
	1991.01-1995.09	MPV Engine K00	•		GHA326020	K
2.5 i (74 kW)	1990.08-1995.09	MPV Engine K	•		GHA326017	K
	1990.08-1995.09	MPV Engine K	•		GHA326020	K
2.5 TD (87 kW)	1992.01-1995.09	MPV Engine 09B/M00	•		GHA326017	K
	1992.01-1995.09	MPV Engine 09B/M00	•		GHA326020	K
3.0 i (108 kW)	1991.01-1995.09	MPV Engine 300/6G72	•		GHA326017	K
	1991.01-1995.09	MPV Engine 300/6G72	•		GHA326020	K
3.3 i (110 kW)	1990.08-1995.09	MPV Engine EGA	•		GHA326017	K
	1990.08-1995.09	MPV Engine EGA	•		GHA326020	K
3.3 i (120 kW)	1990.08-1995.09	MPV Engine EGA	•		GHA326017	K
	1990.08-1995.09	MPV Engine EGA	•		GHA326020	K
3.3 i AWD (110 kW)	1990.08-1995.09	MPV Engine EGA	•		GHA326017	K
	1990.08-1995.09	MPV Engine EGA	•		GHA326020	K
3.3 i AWD (120 kW)	1990.08-1995.09	MPV Engine R00	•		GHA326017	K
	1990.08-1995.09	MPV Engine R00	•		GHA326020	K
VOYAGER II (GS)						
2.0 i (98 kW)	1995.01-2001.03	MPV Engine C00	•		GHA326014	K
	1995.01-2001.03	MPV Engine C00	•		GHA326020	K
	1995.01-2001.03	MPV Engine C00		o	GHA400026	
	1995.01-2001.03	MPV Engine C00		o	GHA400030	
	1995.01-2001.03	MPV Engine C00		o	GHA400071	
2.4 AWD (111 kW)	1997.02-2001.03	MPV Engine EDZ	•		GHA326014	K
	1997.02-2001.03	MPV Engine EDZ		o	GHA326016	
2.4 i (111 kW)	1995.01-2001.03	MPV Engine B00	•		GHA326014	K
	1995.01-2001.03	MPV Engine B00	•		GHA326020	K
	1995.01-2001.03	MPV Engine B00		o	GHA400026	
	1995.01-2001.03	MPV Engine B00		o	GHA400030	
	1995.01-2001.03	MPV Engine B00		o	GHA400071	
2.5 TD (85 kW)	1995.01-2001.03	MPV Engine 425CLIRS/X/ENC	•		GHA326014	K



	 YEAR		F	R	G-AP Ref.	KIT
CHRYSLER						
VOYAGER II (GS)						
2.5 TD (85 kW)	1995.01-2001.03	MPV Engine 425CLIRS/X/ENC	•		GHA326020	K
	1995.01-2001.03	MPV Engine 425CLIRS/X/ENC		◦	GHA400026	
	1995.01-2001.03	MPV Engine 425CLIRS/X/ENC		◦	GHA400030	
	1995.01-2001.03	MPV Engine 425CLIRS/X/ENC		◦	GHA400071	
2.5 TDiC AWD (85 kW)	1995.10-2001.03	MPV Engine ENC	•		GHA326014	K
	1995.10-2001.03	MPV Engine ENC		◦	GHA326016	
3.0 (112 kW)	1995.01-2001.03	MPV Engine EFA	•		GHA326014	K
	1995.01-2001.03	MPV Engine EFA	•		GHA326020	K
	1995.01-2001.03	MPV Engine EFA		◦	GHA400026	
	1995.01-2001.03	MPV Engine EFA		◦	GHA400030	
3.3 i (116 kW)	1995.01-2001.03	MPV Engine EFA		◦	GHA400071	
	1995.01-2001.03	MPV Engine R00	•		GHA326014	K
	1995.01-2001.03	MPV Engine R00	•		GHA326020	K
	1995.01-2001.03	MPV Engine R00		◦	GHA400026	
3.8 i AWD (122 kW)	1995.01-2001.03	MPV Engine R00		◦	GHA400030	
	1995.01-2001.03	MPV Engine R00		◦	GHA400071	
	1995.01-2001.03	MPV Engine L00	•		GHA326014	K
	1995.01-2001.03	MPV Engine L00	•		GHA326020	K
3.8 i AWD (131 kW)	1995.01-2001.03	MPV Engine L00		◦	GHA326016	
	1995.01-2001.03	MPV Engine EGH	•		GHA326014	K
	1995.01-2001.03	MPV Engine EGH	•		GHA326020	K
1995.01-2001.03	MPV Engine EGH		◦	GHA326016		
VOYAGER III (RG, RS)						
2.4 (108 kW)	2000.02-2008.12	MPV Engine EDZ	•		GHA326014	K
	2000.02-2008.12	MPV Engine EDZ		◦	GHA400071	
	2000.02-2008.12	MPV Engine EDZ		◦	GHA400112	
2.5 CRD (105 kW)	2000.02-2008.12	MPV Engine ENC	•		GHA326014	K
	2000.02-2008.12	MPV Engine ENC		◦	GHA400071	
	2000.02-2008.12	MPV Engine ENC		◦	GHA400112	
2.5 CRD (88 kW)	2005.08-2008.12	MPV Engine EDK	•		GHA326014	K
	2005.08-2008.12	MPV Engine EDK		◦	GHA400071	
2.8 CRD (110 kW)	2004.04-2008.02	MPV Engine ENR	•		GHA326014	K
	2004.04-2008.02	MPV Engine ENR		◦	GHA400071	
	2004.04-2008.02	MPV Engine ENR		◦	GHA400112	
3.3 (128 kW)	2000.02-2008.12	MPV Engine EGA	•		GHA326014	K
	2000.02-2008.12	MPV Engine EGA		◦	GHA400071	
	2000.02-2008.12	MPV Engine EGA		◦	GHA400112	
3.3 AWD (128 kW)	2000.02-2008.12	MPV Engine EGA	•		GHA326014	K
	2000.02-2008.12	MPV Engine EGA		◦	GHA326016	
3.3 FlexFuel (128 kW)	2000.02-2008.12	MPV Engine EGM	•		GHA326014	K
	2000.02-2008.12	MPV Engine EGM		◦	GHA400071	
3.8 (160 kW)	2000.02-2008.12	MPV Engine EGH	•		GHA326014	K
	2000.02-2008.12	MPV Engine EGH		◦	GHA400071	
	2000.02-2008.12	MPV Engine EGH		◦	GHA400112	
3.8 AWD (160 kW)	2000.02-2008.12	MPV Engine EGH	•		GHA326014	K
	2000.02-2008.12	MPV Engine EGH		◦	GHA326016	
CITROEN						
AX (ZA-)						
1.4 4x4 (55 kW)	1991.08-1996.12	Hatchback Engine KDX(TU3M/Z)/KDY(TU3FM)/KDY(TU3M)/KDZ(TU3M/Z)	•		GWB0882	
	1991.08-1996.12	Hatchback Engine KDX(TU3M/Z)/KDY(TU3FM)/KDY(TU3M)/KDZ(TU3M/Z)		◦	GWB1327	
1.4 D (37 kW)	1991.08-1997.12	Hatchback Engine K9Y(TUD3Y)	•		GWB0882	
1.4 GTi (66 kW)	1991.08-1996.12	Hatchback Engine KFY(TU3FJ2)	•		GWB0882	
	1991.08-1996.12	Hatchback Engine KFY(TU3FJ2)		◦	GWB0961	
1.4 GTi (69 kW)	1991.06-1996.12	Hatchback Engine KFZ(TU3FJ2)	•		GWB0882	
	1991.06-1996.12	Hatchback Engine KFZ(TU3FJ2)		◦	GWB0961	
1.4 GTi (74 kW)	1991.06-1992.12	Hatchback Engine KFZ(TU3FJ2)	•		GWB0882	
	1991.06-1992.12	Hatchback Engine KFZ(TU3FJ2)		◦	GWB0961	
1.5 D (40 kW)	1994.08-1997.12	Hatchback Engine VJY(TUD5)	•		GWB0882	
1.5 D (43 kW)	1994.08-1997.12	Hatchback Engine VJZ(TUD5)	•		GWB0882	
BERLINGO						
1.6 (66 kW)	2008.04-	Box Engine NFR(TU5JP4B)	•		GHA425022	
	2008.04-	Box Engine NFR(TU5JP4B)	•		GWB3584	
	2008.04-	Box Engine NFR(TU5JP4B)		◦	GHA230148	K



			F	R	G-AP Ref.	KIT
CITROEN BERLINGO						
1.6 (66 kW)	2008.04-	Box Engine NFR(TU5JP4B)		o	GWB6549	
	2008.04-	MPV Engine NFR(TU5JP4B)	•		GHA425022	
	2008.04-	MPV Engine NFR(TU5JP4B)	•		GWB3584	
	2008.04-	MPV Engine NFR(TU5JP4B)		o	GHA230148	K
	2008.04-	MPV Engine NFR(TU5JP4B)		o	GWB6549	
1.6 (80 kW)	2008.04-	Box Engine NFU(TU5JP4)	•		GHA425022	
	2008.04-	Box Engine NFU(TU5JP4)	•		GWB3584	
	2008.04-	Box Engine NFU(TU5JP4)		o	GWB6549	
	2008.04-	MPV Engine NFU(TU5JP4)	•		GHA425022	
	2008.04-	MPV Engine NFU(TU5JP4)	•		GWB3584	
	2008.04-	MPV Engine NFU(TU5JP4)		o	GHA230148	K
	2008.04-	MPV Engine NFU(TU5JP4)		o	GWB6549	
1.6 HDi (55 kW)	2008.04-	Box Engine 9HT(DV6BUTED4)	•		GHA425022	
	2008.04-	Box Engine 9HT(DV6BUTED4)	•		GWB3584	
	2008.04-	Box Engine 9HT(DV6BUTED4)		o	GHA230148	K
	2008.04-	Box Engine 9HT(DV6BUTED4)		o	GWB6549	
	2008.04-	MPV Engine 9HT(DV6BTED4)	•		GHA425022	
	2008.04-	MPV Engine 9HT(DV6BTED4)	•		GWB3584	
	2008.04-	MPV Engine 9HT(DV6BTED4)		o	GHA230148	K
	2008.04-	MPV Engine 9HT(DV6BTED4)		o	GWB6549	
1.6 HDi (66 kW)	2008.04-	Box Engine 9HX(DV6ATED4)/9HS(DV6TED4BU)	•		GHA425022	
	2008.04-	Box Engine 9HX(DV6ATED4)/9HS(DV6TED4BU)	•		GWB3584	
	2008.04-	Box Engine 9HX(DV6ATED4)/9HS(DV6TED4BU)		o	GHA230148	K
	2008.04-	Box Engine 9HX(DV6ATED4)/9HS(DV6TED4BU)		o	GWB6549	
	2008.04-	MPV Engine 9HX(DV6ATED4)	•		GHA425022	
	2008.04-	MPV Engine 9HX(DV6ATED4)	•		GWB3584	
	2008.04-	MPV Engine 9HX(DV6ATED4)		o	GHA230148	K
	2008.04-	MPV Engine 9HX(DV6ATED4)		o	GWB6549	
	2008.04-	Platform/Chassis	•		GWB3584	
	2008.04-	Platform/Chassis		o	GHA230148	K
2008.04-	Platform/Chassis		o	GWB6549		
1.6 HDi (68 kW)	2010.07-	Box Engine 9HP(DV6DTED)	•		GHA425022	
	2010.07-	Box Engine 9HP(DV6DTED)	•		GWB3584	
	2010.07-	Box Engine 9HP(DV6DTED)		o	GWB6549	
	2010.07-	MPV Engine 9HX(DV6ATED4)	•		GHA425022	
	2010.07-	MPV Engine 9HX(DV6ATED4)	•		GWB3584	
	2010.07-	MPV Engine 9HX(DV6ATED4)		o	GHA230148	K
	2010.07-	MPV Engine 9HX(DV6ATED4)		o	GWB6549	
1.6 HDi (80 kW)	2008.04-	Box Engine 9HZ(DV6TED4)	•		GHA425022	
	2008.04-	Box Engine 9HZ(DV6TED4)	•		GWB3584	
	2008.04-	Box Engine 9HZ(DV6TED4)		o	GWB6549	
	2008.04-	MPV Engine 9HZ(DV6TED4)	•		GHA425022	
	2008.04-	MPV Engine 9HZ(DV6TED4)	•		GWB3584	
	2008.04-	MPV Engine 9HZ(DV6TED4)		o	GHA230148	K
	2008.04-	MPV Engine 9HZ(DV6TED4)		o	GWB6549	
1.6 HDi (82 kW)	2010.07-	Box Engine 9HR(DV6C)/9HL(DV6C)	•		GHA425022	
	2010.07-	Box Engine 9HR(DV6C)/9HL(DV6C)	•		GWB3584	
	2010.07-	Box Engine 9HR(DV6C)/9HL(DV6C)		o	GWB6549	
	2010.07-	MPV Engine 9HR(DV6C)/9HL(DV6C)	•		GHA425022	
	2010.07-	MPV Engine 9HR(DV6C)/9HL(DV6C)	•		GWB3584	
	2010.07-	MPV Engine 9HR(DV6C)/9HL(DV6C)		o	GWB6549	
1.6 HDi (84 kW)	2010.07-	Box Engine 9HL(DV6C)	•		GHA425022	
	2010.07-	Box Engine 9HL(DV6C)	•		GWB3584	
	2010.07-	Box Engine 9HL(DV6C)		o	GHA230148	K
	2010.07-	Box Engine 9HL(DV6C)		o	GWB6549	
	2010.07-	MPV Engine 9HR(DV6C)	•		GHA425022	
	2010.07-	MPV Engine 9HR(DV6C)	•		GWB3584	
	2010.07-	MPV Engine 9HR(DV6C)		o	GHA230148	K
	2010.07-	MPV Engine 9HR(DV6C)		o	GWB6549	
1.6 VTi (72 kW)	2010.07-	Box Engine 5FK(EP6CB)	•		GHA425022	
	2010.07-	Box Engine 5FK(EP6CB)	•		GWB3584	
	2010.07-	Box Engine 5FK(EP6CB)		o	GHA230148	K
	2010.07-	Box Engine 5FK(EP6CB)		o	GWB6549	
	2010.07-	MPV Engine 5FK(EP6CB)	•		GHA425022	



			F	R	G-AP Ref.	KIT
CITROEN BERLINGO						
1.6 VTi (72 kW)	2010.07-	MPV Engine 5FK(EP6CB)	•		GWB3584	
	2010.07-	MPV Engine 5FK(EP6CB)		◦	GHA230148	K
	2010.07-	MPV Engine 5FK(EP6CB)		◦	GWB6549	
1.6 VTi (88 kW)	2009.11-	Box Engine 5FS(EP6C)	•		GWB3584	
	2009.11-	Box Engine 5FS(EP6C)		◦	GWB6549	
	2009.11-	MPV Engine 5FS(EP6C)	•		GHA425022	
	2009.11-	MPV Engine 5FS(EP6C)	•		GWB3584	
	2009.11-	MPV Engine 5FS(EP6C)		◦	GHA230148	K
	2009.11-	MPV Engine 5FS(EP6C)		◦	GWB6549	
Electric (42 kW)	2011.09-	Box	•		GHA425022	
	2011.09-	Box	•		GWB3584	
	2011.09-	Box		◦	GWB6549	
BERLINGO (B9)						
1.6 BlueHDi 100 (73 kW)	2014.12-	Box Engine BHY (DV6FD)	•		GWB3584	
	2014.12-	Box Engine BHY (DV6FD)		◦	GWB6549	
	2014.12-	MPV Engine BHY (DV6FD)	•		GWB3584	
	2014.12-	MPV Engine BHY (DV6FD)		◦	GWB6549	
1.6 BlueHDi 120 (88 kW)	2014.12-	Box Engine BHZ (DV6FC)	•		GWB3584	
	2014.12-	Box Engine BHZ (DV6FC)		◦	GWB6549	
	2014.12-	MPV Engine BHZ (DV6FC)	•		GWB3584	
	2014.12-	MPV Engine BHZ (DV6FC)		◦	GWB6549	
1.6 BlueHDi 75 (55 kW)	2015.04-	Box Engine 9HN (DV6ETED)/BHW (DV6FE)	•		GWB3584	
	2015.04-	Box Engine 9HN (DV6ETED)/BHW (DV6FE)		◦	GWB6549	
	2015.04-	MPV Engine 9HN(DV6ETED)/BHW(DV6FE)	•		GWB3584	
	2015.04-	MPV Engine 9HN(DV6ETED)/BHW(DV6FE)		◦	GWB6549	
1.6 HDi 90 (66 kW)	2010.07-	Box Engine 9HF(DV6DTED)	•		GHA425022	
	2010.07-	Box Engine 9HF(DV6DTED)		◦	GHA230148	K
Electric (35 kW)	2013.01-	Box Engine Y4F1	•		GHA425022	
	2013.01-	Box Engine Y4F1	•		GWB3584	
	2013.01-	Box Engine Y4F1		◦	GWB6549	
Electric (49 kW)	2014.03-	Box Engine Y4F1	•		GHA425022	
	2014.03-	Box Engine Y4F1	•		GWB3584	
	2014.03-	Box Engine Y4F1		◦	GWB6549	
BERLINGO (M_)						
1.1 i (44 kW)	1996.07-	Box Engine HDZ(TU1M)/HFX(TU1JP)	•		GHA425022	
	1996.07-	Box Engine HDZ(TU1M)/HFX(TU1JP)	•		GWB0915	
	1996.07-	Box Engine HDZ(TU1M)/HFX(TU1JP)		◦	GHA232021	K
	1996.07-	Box Engine HDZ(TU1M)/HFX(TU1JP)		◦	GHA232028	K
	1996.07-	Box Engine HDZ(TU1M)/HFX(TU1JP)		◦	GHA232033	K
	1996.07-	Box Engine HDZ(TU1M)/HFX(TU1JP) With ABS		◦	GHA232032	K
	1996.07-	Box Engine HDZ(TU1M)/HFX(TU1JP) Without ABS		◦	GHA232011	K
	1996.07-	Box Engine HDZ(TU1M)/HFX(TU1JP) Without ABS		◦	GHA232012	K
1.4 Bivalent (48 kW)	2002.11-	Box Engine KFW(TU3JP)	•		GWB0915	
	2002.11-	Box Engine KFW(TU3JP)		◦	GHA232021	K
	2002.11-	Box Engine KFW(TU3JP)		◦	GHA232028	K
	2002.11-	Box Engine KFW(TU3JP) With ABS		◦	GHA232032	K
	2002.11-	Box Engine KFW(TU3JP) Without ABS		◦	GHA232012	K
1.4 i (55 kW)	1996.07-	Box Engine KFW(TU3JP)/KFX(TU3JP)	•		GHA425022	
	1996.07-	Box Engine KFW(TU3JP)/KFX(TU3JP)	•		GWB0915	
	1996.07-	Box Engine KFW(TU3JP)/KFX(TU3JP)		◦	GHA232021	K
	1996.07-	Box Engine KFW(TU3JP)/KFX(TU3JP)		◦	GHA232028	K
	1996.07-	Box Engine KFW(TU3JP)/KFX(TU3JP)		◦	GHA232033	K
	1996.07-	Box Engine KFW(TU3JP)/KFX(TU3JP) With ABS		◦	GHA232032	K
	1996.07-	Box Engine KFW(TU3JP)/KFX(TU3JP) Without ABS		◦	GHA232011	K
	1996.07-	Box Engine KFW(TU3JP)/KFX(TU3JP) Without ABS		◦	GHA232012	K
1.4 i Bivalent (55 kW)	2003.04-	Box Engine KFW(TU3JP)	•		GHA425022	
	2003.04-	Box Engine KFW(TU3JP)	•		GWB0915	
	2003.04-	Box Engine KFW(TU3JP)		◦	GHA232021	K
	2003.04-	Box Engine KFW(TU3JP)		◦	GHA232028	K
	2003.04-	Box Engine KFW(TU3JP) With ABS		◦	GHA232032	K
	2003.04-	Box Engine KFW(TU3JP) Without ABS		◦	GHA232012	K
1.6 16V (80 kW)	2000.10-	Box Engine NFU(TU5JP4)	•		GHA425022	
	2000.10-	Box Engine NFU(TU5JP4)	•		GWB0915	
	2000.10-	Box Engine NFU(TU5JP4)		◦	GHA232021	K



	 YEAR		F	R	G-AP Ref.	KIT
CITROEN BERLINGO (M_)						
1.6 16V (80 kW)	2000.10-	Box Engine NFU(TU5JP4)		o	GHA232028	K
	2000.10-	Box Engine NFU(TU5JP4) With ABS		o	GHA232032	K
	2000.10-	Box Engine NFU(TU5JP4) Without ABS		o	GHA232012	K
1.6 16V (81 kW)	2005.08-2007.12	Box Engine NFU (TU5JP4)	•		GWB0915	
	2005.08-2007.12	Box Engine NFU (TU5JP4)		o	GHA232021	K
	2005.08-2007.12	Box Engine NFU (TU5JP4) With ABS		o	GHA232032	K
1.6 HDi (55 kW)	2005.07-	Box Engine 9HW(DV6ETED)/DV6B	•		GHA425022	
	2005.07-	Box Engine 9HW(DV6ETED)/DV6B	•		GWB0915	
	2005.07-	Box Engine 9HW(DV6ETED)/DV6B		o	GHA232021	K
	2005.07-	Box Engine 9HW(DV6ETED)/DV6B With ABS		o	GHA232032	K
1.6 HDi (66 kW)	2005.07-	Box Engine 9HX(DV6ATED4)	•		GHA425022	
	2005.07-	Box Engine 9HX(DV6ATED4)	•		GWB0915	
	2005.07-	Box Engine 9HX(DV6ATED4)		o	GHA232021	K
	2005.07-	Box Engine 9HX(DV6ATED4) With ABS		o	GHA232032	K
1.8 D (43 kW)	1996.07-	Box Engine A9A(XUD7)	•		GHA425022	
	1996.07-	Box Engine A9A(XUD7)	•		GWB0915	
	1996.07-	Box Engine A9A(XUD7)		o	GHA232021	K
	1996.07-	Box Engine A9A(XUD7)		o	GHA232028	K
	1996.07-	Box Engine A9A(XUD7)		o	GHA232033	K
	1996.07-	Box Engine A9A(XUD7) With ABS		o	GHA232032	K
	1996.07-	Box Engine A9A(XUD7) Without ABS		o	GHA232011	K
	1996.07-	Box Engine A9A(XUD7) Without ABS		o	GHA232012	K
1.8 i (66 kW)	1998.06-2000.06	Box Engine LFX(XU7JB)	•		GHA425022	
	1998.06-2000.06	Box Engine LFX(XU7JB)	•		GWB0915	
	1998.06-2000.06	Box Engine LFX(XU7JB)		o	GHA232028	K
	1998.06-2000.06	Box Engine LFX(XU7JB) With ABS		o	GHA232032	K
	1998.06-2000.06	Box Engine LFX(XU7JB) Without ABS		o	GHA232012	K
1.9 D (51 kW)	1996.07-	Box Engine DJY(XUD9A)	•		GHA425022	
	1996.07-	Box Engine DJY(XUD9A)	•		GWB0915	
	1996.07-	Box Engine DJY(XUD9A)		o	GHA232021	K
	1996.07-	Box Engine DJY(XUD9A)		o	GHA232028	K
	1996.07-	Box Engine DJY(XUD9A)		o	GHA232033	K
	1996.07-	Box Engine DJY(XUD9A) With ABS		o	GHA232032	K
	1996.07-	Box Engine DJY(XUD9A) Without ABS		o	GHA232011	K
	1996.07-	Box Engine DJY(XUD9A) Without ABS		o	GHA232012	K
	1999.04-	Box Engine WJY(DW8B)/WJZ(DW8)	•		GHA425022	
	1999.04-	Box Engine WJY(DW8B)/WJZ(DW8)	•		GWB0915	
	1999.04-	Box Engine WJY(DW8B)/WJZ(DW8)		o	GHA232021	K
	1999.04-	Box Engine WJY(DW8B)/WJZ(DW8)		o	GHA232028	K
	1999.04-	Box Engine WJY(DW8B)/WJZ(DW8) With ABS		o	GHA232032	K
	1999.04-	Box Engine WJY(DW8B)/WJZ(DW8) Without ABS		o	GHA232012	K
1.9 D 4WD (51 kW)	1998.07-	Box Engine WJY(DW8B)/WJZ(DW8)	•		GHA425022	
	1998.07-	Box Engine WJY(DW8B)/WJZ(DW8)	•		GWB0915	
	1998.07-	Box Engine WJY(DW8B)/WJZ(DW8)		o	GHA232021	K
	1998.07-	Box Engine WJY(DW8B)/WJZ(DW8)		o	GHA232028	K
	1998.07-	Box Engine WJY(DW8B)/WJZ(DW8) With ABS		o	GHA232032	K
	1998.07-	Box Engine WJY(DW8B)/WJZ(DW8) Without ABS		o	GHA232012	K
2.0 HDi (66 kW)	1999.12-	Box Engine RHY(DW10TD)	•		GHA425022	
	1999.12-	Box Engine RHY(DW10TD)	•		GWB0915	
	1999.12-	Box Engine RHY(DW10TD)		o	GHA232021	K
	1999.12-	Box Engine RHY(DW10TD)		o	GHA232028	K
	1999.12-	Box Engine RHY(DW10TD) With ABS		o	GHA232032	K
	1999.12-	Box Engine RHY(DW10TD) Without ABS		o	GHA232012	K
2.0 HDi 4WD (66 kW)	2000.11-	Box Engine RHY(DW10TD)	•		GHA425022	
	2000.11-	Box Engine RHY(DW10TD)	•		GWB0915	
	2000.11-	Box Engine RHY(DW10TD)		o	GHA232021	K
	2000.11-	Box Engine RHY(DW10TD)		o	GHA232028	K
	2000.11-	Box Engine RHY(DW10TD) With ABS		o	GHA232032	K
	2000.11-	Box Engine RHY(DW10TD) Without ABS		o	GHA232012	K
Electric (27 kW)	2003.07-1992.06	Box	•		GHA425022	
	2003.07-1992.06	Box	•		GWB0915	
	2003.07-1992.06	Box		o	GHA232021	K
	2003.07-1992.06	Box With ABS		o	GHA232032	K



			F	R	G-AP Ref.	KIT
CITROEN BERLINGO (MF)						
1.1 i (44 kW)	1996.07-	MPV Engine HDZ(TU1M)/HFX(TU1JP)	•		GHA425022	
	1996.07-	MPV Engine HDZ(TU1M)/HFX(TU1JP)	•		GWB0915	
	1996.07-	MPV Engine HDZ(TU1M)/HFX(TU1JP)		o	GHA232021	K
	1996.07-	MPV Engine HDZ(TU1M)/HFX(TU1JP)		o	GHA232028	K
	1996.07-	MPV Engine HDZ(TU1M)/HFX(TU1JP)		o	GHA232033	K
	1996.07-	MPV Engine HDZ(TU1M)/HFX(TU1JP) With ABS		o	GHA232032	K
	1996.07-	MPV Engine HDZ(TU1M)/HFX(TU1JP) Without ABS		o	GHA232011	K
	1996.07-	MPV Engine HDZ(TU1M)/HFX(TU1JP) Without ABS		o	GHA232012	K
1.4 (53 kW)	2002.11-2005.10	MPV Engine KFW(TU3JP)	•		GHA425022	
	2002.11-2005.10	MPV Engine KFW(TU3JP)	•		GWB0915	
	2002.11-2005.10	MPV Engine KFW(TU3JP)		o	GHA232021	K
	2002.11-2005.10	MPV Engine KFW(TU3JP)		o	GHA232028	K
	2002.11-2005.10	MPV Engine KFW(TU3JP) With ABS		o	GHA232032	K
	2002.11-2005.10	MPV Engine KFW(TU3JP) Without ABS		o	GHA232012	K
1.4 Bivalent (48 kW)	2002.11-	MPV Engine KFW(TU3JP)	•		GWB0915	
	2002.11-	MPV Engine KFW(TU3JP)		o	GHA232021	K
	2002.11-	MPV Engine KFW(TU3JP)		o	GHA232028	K
	2002.11-	MPV Engine KFW(TU3JP) With ABS		o	GHA232032	K
	2002.11-	MPV Engine KFW(TU3JP) Without ABS		o	GHA232012	K
1.4 i (55 kW)	1996.07-	MPV Engine KFW(TU3JP)/KFX(TU3JP)	•		GHA425022	
	1996.07-	MPV Engine KFW(TU3JP)/KFX(TU3JP)	•		GWB0915	
	1996.07-	MPV Engine KFW(TU3JP)/KFX(TU3JP)		o	GHA232021	K
	1996.07-	MPV Engine KFW(TU3JP)/KFX(TU3JP)		o	GHA232028	K
	1996.07-	MPV Engine KFW(TU3JP)/KFX(TU3JP)		o	GHA232033	K
	1996.07-	MPV Engine KFW(TU3JP)/KFX(TU3JP) With ABS		o	GHA232032	K
	1996.07-	MPV Engine KFW(TU3JP)/KFX(TU3JP) Without ABS		o	GHA232011	K
	1996.07-	MPV Engine KFW(TU3JP)/KFX(TU3JP) Without ABS		o	GHA232012	K
1.4 i Bivalent (55 kW)	2003.04-	MPV Engine KFW(TU3JP)	•		GHA425022	
	2003.04-	MPV Engine KFW(TU3JP)	•		GWB0915	
	2003.04-	MPV Engine KFW(TU3JP)		o	GHA232021	K
	2003.04-	MPV Engine KFW(TU3JP)		o	GHA232028	K
	2003.04-	MPV Engine KFW(TU3JP) With ABS		o	GHA232032	K
	2003.04-	MPV Engine KFW(TU3JP) Without ABS		o	GHA232012	K
1.6 16V (80 kW)	2000.10-	MPV Engine NFU(TU5JP4)	•		GHA425022	
	2000.10-	MPV Engine NFU(TU5JP4)	•		GWB0915	
	2000.10-	MPV Engine NFU(TU5JP4)		o	GHA232021	K
	2000.10-	MPV Engine NFU(TU5JP4)		o	GHA232028	K
	2000.10-	MPV Engine NFU(TU5JP4) With ABS		o	GHA232032	K
	2000.10-	MPV Engine NFU(TU5JP4) Without ABS		o	GHA232012	K
1.6 16V (81 kW)	2005.11-	MPV Engine NFU(TU5JP4)	•		GHA425022	
	2005.11-	MPV Engine NFU(TU5JP4)	•		GWB0915	
	2005.11-	MPV Engine NFU(TU5JP4)		o	GHA232021	K
	2005.11-	MPV Engine NFU(TU5JP4)		o	GHA232028	K
	2005.11-	MPV Engine NFU(TU5JP4) With ABS		o	GHA232032	K
	2005.11-	MPV Engine NFU(TU5JP4) Without ABS		o	GHA232012	K
1.6 HDi (55 kW)	2005.10-2007.05	MPV Engine 9HW(DV6ETED)/DV6B	•		GHA425022	
	2005.10-2007.05	MPV Engine 9HW(DV6ETED)/DV6B	•		GWB0915	
	2005.10-2007.05	MPV Engine 9HW(DV6ETED)/DV6B		o	GHA232021	K
	2005.10-2007.05	MPV Engine 9HW(DV6ETED)/DV6B With ABS		o	GHA232032	K
1.6 HDi (66 kW)	2005.10-2007.05	MPV Engine 9HX(DV6ATED4)	•		GHA425022	
	2005.10-2007.05	MPV Engine 9HX(DV6ATED4)	•		GWB0915	
	2005.10-2007.05	MPV Engine 9HX(DV6ATED4)		o	GHA232021	K
	2005.10-2007.05	MPV Engine 9HX(DV6ATED4) With ABS		o	GHA232032	K
1.6 HDi (80 kW)	2005.08-	MPV Engine 9HZ(DV6TED4)	•		GHA425022	
	2005.08-	MPV Engine 9HZ(DV6TED4)	•		GWB0915	
	2005.08-	MPV Engine 9HZ(DV6TED4)		o	GHA232021	K
	2005.08-	MPV Engine 9HZ(DV6TED4) With ABS		o	GHA232032	K
1.8 D (43 kW)	1998.07-	MPV Engine A9A(XUD7)	•		GHA425022	
	1998.07-	MPV Engine A9A(XUD7)	•		GWB0915	
	1998.07-	MPV Engine A9A(XUD7)		o	GHA232021	K
	1998.07-	MPV Engine A9A(XUD7)		o	GHA232028	K
	1998.07-	MPV Engine A9A(XUD7)		o	GHA232033	K
	1998.07-	MPV Engine A9A(XUD7) With ABS		o	GHA232032	K
	1998.07-	MPV Engine A9A(XUD7) Without ABS		o	GHA232011	K



	 YEAR		F	R	G-AP Ref.	KIT
CITROEN BERLINGO (MF)						
1.8 D (43 kW)	1998.07-	MPV Engine A9A(XUD7) Without ABS		o	GHA232012	K
1.8 i (66 kW)	1997.05-	MPV Engine LFX(XU7JB)	•		GHA425022	
	1997.05-	MPV Engine LFX(XU7JB)	•		GWB0915	
	1997.05-	MPV Engine LFX(XU7JB)		o	GHA232021	K
	1997.05-	MPV Engine LFX(XU7JB)		o	GHA232028	K
	1997.05-	MPV Engine LFX(XU7JB)		o	GHA232033	K
	1997.05-	MPV Engine LFX(XU7JB) With ABS		o	GHA232032	K
	1997.05-	MPV Engine LFX(XU7JB) Without ABS		o	GHA232011	K
	1997.05-	MPV Engine LFX(XU7JB) Without ABS		o	GHA232012	K
	1.8 i 4WD (66 kW)	1997.04-	MPV Engine LFX(XU7JB)	•		GHA425022
1997.04-		MPV Engine LFX(XU7JB)	•		GWB0915	
1997.04-		MPV Engine LFX(XU7JB)		o	GHA232021	K
1997.04-		MPV Engine LFX(XU7JB)		o	GHA232028	K
1997.04-		MPV Engine LFX(XU7JB)		o	GHA232033	K
1997.04-		MPV Engine LFX(XU7JB) With ABS		o	GHA232032	K
1997.04-		MPV Engine LFX(XU7JB) Without ABS		o	GHA232011	K
1997.04-		MPV Engine LFX(XU7JB) Without ABS		o	GHA232012	K
1.9 D (50 kW)		1996.07-	MPV Engine D9B(XUD9A/L)/DJY(XUD9A)	•		GHA425022
	1996.07-	MPV Engine D9B(XUD9A/L)/DJY(XUD9A)	•		GWB0915	
	1996.07-	MPV Engine D9B(XUD9A/L)/DJY(XUD9A)		o	GHA232021	K
	1996.07-	MPV Engine D9B(XUD9A/L)/DJY(XUD9A)		o	GHA232028	K
	1996.07-	MPV Engine D9B(XUD9A/L)/DJY(XUD9A)		o	GHA232033	K
	1996.07-	MPV Engine D9B(XUD9A/L)/DJY(XUD9A) With ABS		o	GHA232032	K
	1996.07-	MPV Engine D9B(XUD9A/L)/DJY(XUD9A) Without ABS		o	GHA232011	K
	1996.07-	MPV Engine D9B(XUD9A/L)/DJY(XUD9A) Without ABS		o	GHA232012	K
	1.9 D (51 kW)	1998.07-	MPV Engine WJY(DW8B)/WJZ(DW8)	•		GHA425022
1998.07-		MPV Engine WJY(DW8B)/WJZ(DW8)	•		GWB0915	
1998.07-		MPV Engine WJY(DW8B)/WJZ(DW8)		o	GHA232021	K
1998.07-		MPV Engine WJY(DW8B)/WJZ(DW8)		o	GHA232028	K
1998.07-		MPV Engine WJY(DW8B)/WJZ(DW8)		o	GHA232033	K
1998.07-		MPV Engine WJY(DW8B)/WJZ(DW8) With ABS		o	GHA232032	K
1998.07-		MPV Engine WJY(DW8B)/WJZ(DW8) Without ABS		o	GHA232011	K
1998.07-		MPV Engine WJY(DW8B)/WJZ(DW8) Without ABS		o	GHA232012	K
1.9 D 4WD (51 kW)		1998.07-	MPV Engine WJZ(DW8)/WJY(DW8B)	•		GHA425022
	1998.07-	MPV Engine WJZ(DW8)/WJY(DW8B)	•		GWB0915	
	1998.07-	MPV Engine WJZ(DW8)/WJY(DW8B)		o	GHA232021	K
	1998.07-	MPV Engine WJZ(DW8)/WJY(DW8B)		o	GHA232028	K
	1998.07-	MPV Engine WJZ(DW8)/WJY(DW8B)		o	GHA232033	K
	1998.07-	MPV Engine WJZ(DW8)/WJY(DW8B) With ABS		o	GHA232032	K
	1998.07-	MPV Engine WJZ(DW8)/WJY(DW8B) Without ABS		o	GHA232011	K
	1998.07-	MPV Engine WJZ(DW8)/WJY(DW8B) Without ABS		o	GHA232012	K
	2.0 HDi (66 kW)	1999.12-	MPV Engine RHY(DW10TD)	•		GHA425022
1999.12-		MPV Engine RHY(DW10TD)	•		GWB0915	
1999.12-		MPV Engine RHY(DW10TD)		o	GHA232021	K
1999.12-		MPV Engine RHY(DW10TD)		o	GHA232028	K
1999.12-		MPV Engine RHY(DW10TD) With ABS		o	GHA232032	K
1999.12-		MPV Engine RHY(DW10TD) Without ABS		o	GHA232012	K
2.0 HDi 4x4 (66 kW)	2002.11-2005.10	MPV Engine RHY(DW10TD)	•		GHA425022	
	2002.11-2005.10	MPV Engine RHY(DW10TD)	•		GWB0915	
	2002.11-2005.10	MPV Engine RHY(DW10TD)		o	GHA232021	K
	2002.11-2005.10	MPV Engine RHY(DW10TD)		o	GHA232028	K
	2002.11-2005.10	MPV Engine RHY(DW10TD) With ABS		o	GHA232032	K
	2002.11-2005.10	MPV Engine RHY(DW10TD) Without ABS		o	GHA232012	K
	Electric (28 kW)	1998.01-	MPV	•		GHA425022
1998.01-		MPV	•		GWB0915	
1998.01-		MPV		o	GHA232021	K
1998.01-		MPV		o	GHA232028	K
1998.01-		MPV With ABS		o	GHA232032	K
1998.01-		MPV Without ABS		o	GHA232012	K
electricue (16 kW)	2000.01-	MPV Engine 15053	•		GHA425022	
	2000.01-	MPV Engine 15053	•		GWB0915	
	2000.01-	MPV Engine 15053		o	GHA232021	K
	2000.01-	MPV Engine 15053		o	GHA232028	K
	2000.01-	MPV Engine 15053 With ABS		o	GHA232032	K



	 YEAR		F	R	G-AP Ref.	KIT
CITROEN						
BERLINGO (MF)						
electrique (16 kW)	2000.01-	MPV Engine 15053 Without ABS		o	GHA232012	K
BX (XB-)						
1.9 (92 kW)	1992.02-1994.06	Hatchback	•		GHA425022	
16 (70 kW)	1992.02-1994.06	Hatchback Engine 171B	•		GHA425022	
BX BREAK (XB-)						
1.9 4x4 (80 kW)	1990.10-1991.05	Estate Engine DDZ(XU9M)	•		GHA425022	
	1990.10-1991.05	Estate Engine DDZ(XU9M)	•		GWB0915	
1.9 DT TXD (66 kW)	1992.02-1994.12	Estate	•		GHA425022	
16 (70 kW)	1992.02-1992.12	Estate	•		GHA425022	
	1992.02-1992.12	Estate	•		GWB0915	
	1992.02-1992.12	Estate Without ABS		o	GHA232004	K
C1 (PM_, PN_)						
1.0 (50 kW)	2005.06-	Hatchback Engine 1KR-FE	•		GWB3684	
	2005.06-	Hatchback Engine 1KR-FE		o	GHA400149	
1.4 HDi (40 kW)	2005.06-	Hatchback Engine DV4D	•		GWB3684	
	2005.06-	Hatchback Engine DV4D		o	GHA400149	
C1 II						
1.0 VTi 68 (51 kW)	2014.04-	Hatchback Engine 1KR-FE	•		GWB3684	
	2014.04-	Hatchback Engine 1KR-FE		o	GHA400149	
1.2 VTi (60 kW)	2014.04-	Hatchback	•		GWB3684	
	2014.04-	Hatchback		o	GHA400149	
C15						
1.4 (55 kW)	1991.05-1996.07	Estate Engine KDY(TU3M)	•		GWB0882	
	1991.05-1996.07	Estate Engine KDY(TU3M) Without ABS		o	GHA232004	K
C15 (VD-)						
1.0 E (37 kW)	1992.11-1996.07	Box Engine GL1/GLA	•		GWB0882	
	1992.11-1996.07	Box Engine GL1/GLA Without ABS		o	GHA232004	K
1.4 i (55 kW)	1991.05-1996.12	Box Engine KDY(TU3FM)/KDY(TU3M)	•		GWB0882	
	1991.05-1996.12	Box Engine KDY(TU3FM)/KDY(TU3M) Without ABS		o	GHA232004	K
1.9 D (44 kW)	2000.12-2005.12	Box Engine WJX(DW8B)	•		GWB0882	
	2000.12-2005.12	Box Engine WJX(DW8B) Without ABS		o	GHA232004	K
C2 (JM_)						
1.1 (44 kW)	2003.09-	Hatchback Engine HFX(TU1JP)	•		GHA421003	
	2003.09-	Hatchback Engine HFX(TU1JP)	•		GWB3554A	
	2003.09-	Hatchback Engine HFX(TU1JP)	•		GWB3657	
	2003.09-	Hatchback Engine HFX(TU1JP)		o	GHA225011	K
	2003.09-	Hatchback Engine HFX(TU1JP)		o	GWB3658	
1.4 (54 kW)	2003.09-	Hatchback Engine KFV(TU3JP)	•		GHA421003	
	2003.09-	Hatchback Engine KFV(TU3JP)	•		GWB3554A	
	2003.09-	Hatchback Engine KFV(TU3JP)	•		GWB3657	
	2003.09-	Hatchback Engine KFV(TU3JP)		o	GHA225011	K
	2003.09-	Hatchback Engine KFV(TU3JP)		o	GWB3658	
1.4 (55 kW)	2006.10-	Hatchback Engine TU3JP	•		GHA421003	
	2006.10-	Hatchback Engine TU3JP	•		GWB3554A	
	2006.10-	Hatchback Engine TU3JP	•		GWB3657	
	2006.10-	Hatchback Engine TU3JP		o	GHA225011	K
	2006.10-	Hatchback Engine TU3JP		o	GWB3658	
1.4 16V (65 kW)	2005.12-	Hatchback Engine KFV(ET3J4)	•		GHA421003	
	2005.12-	Hatchback Engine KFV(ET3J4)	•		GWB3554A	
	2005.12-	Hatchback Engine KFV(ET3J4)	•		GWB3657	
	2005.12-	Hatchback Engine KFV(ET3J4)		o	GHA225011	K
	2005.12-	Hatchback Engine KFV(ET3J4)		o	GWB3658	
1.4 HDi (50 kW)	2003.09-	Hatchback Engine 8HX(DV4TD)	•		GHA421003	
	2003.09-	Hatchback Engine 8HX(DV4TD)	•		GWB3554A	
	2003.09-	Hatchback Engine 8HX(DV4TD)	•		GWB3657	
	2003.09-	Hatchback Engine 8HX(DV4TD)		o	GHA225011	K
	2003.09-	Hatchback Engine 8HX(DV4TD)		o	GWB3658	
1.6 (80 kW)	2003.09-	Hatchback Engine NFU(TU5JP4)	•		GHA421003	
	2003.09-	Hatchback Engine NFU(TU5JP4)	•		GWB3554A	
	2003.09-	Hatchback Engine NFU(TU5JP4)	•		GWB3657	
	2003.09-	Hatchback Engine NFU(TU5JP4)		o	GHA225011	K
	2003.09-	Hatchback Engine NFU(TU5JP4)		o	GWB3658	
1.6 HDi (80 kW)	2005.09-	Hatchback Engine 9HZ-DV6TED4	•		GHA421003	



	 YEAR		F	R	G-AP Ref.	KIT
CITROEN						
C2 (JM_)						
1.6 HDi (80 kW)	2005.09-	Hatchback Engine 9HZ-DV6TED4	•		GWB3554A	
	2005.09-	Hatchback Engine 9HZ-DV6TED4	•		GWB3657	
	2005.09-	Hatchback Engine 9HZ-DV6TED4		o	GHA225011	K
	2005.09-	Hatchback Engine 9HZ-DV6TED4		o	GWB3658	
1.6 VTS (90 kW)	2005.10-2008.03	Hatchback Engine NFS(TU5JP4S)	•		GHA421003	
	2005.10-2008.03	Hatchback Engine NFS(TU5JP4S)	•		GWB3554A	
	2005.10-2008.03	Hatchback Engine NFS(TU5JP4S)	•		GWB3657	
	2005.10-2008.03	Hatchback Engine NFS(TU5JP4S)		o	GHA225011	K
	2005.10-2008.03	Hatchback Engine NFS(TU5JP4S)		o	GWB3658	
C2 ENTERPRISE						
1.4 HDi (50 kW)	2009.04-	Box Engine 8HX(DV4TD)	•		GHA421003	
	2009.04-	Box Engine 8HX(DV4TD)	•		GWB3554A	
	2009.04-	Box Engine 8HX(DV4TD)	•		GWB3657	
	2009.04-	Box Engine 8HX(DV4TD)		o	GHA225011	K
	2009.04-	Box Engine 8HX(DV4TD)		o	GWB3658	
C25 (280_, 290_)						
1.9 TD (60 kW)	1992.04-1994.02	Bus Engine M705	•		GWB1444	
	1992.04-1994.02	Bus Engine M705		o	GWB1445	
2.0 (62 kW)	1991.02-1994.02	Bus Engine 170C(XN1T)	•		GWB1444	
	1991.02-1994.02	Bus Engine 170C(XN1T)		o	GWB1445	
	1991.02-1994.03	Box Engine 170C(XN1T)	•		GWB1444	
	1991.02-1994.03	Box Engine 170C(XN1T)		o	GWB1445	
C3 I (FC_)						
1.1 i (44 kW)	2002.02-	Hatchback Engine HFX(TU1JP)	•		GHA421003	
	2002.02-	Hatchback Engine HFX(TU1JP)	•		GWB3554A	
	2002.02-	Hatchback Engine HFX(TU1JP)	•		GWB3657	
	2002.02-	Hatchback Engine HFX(TU1JP)		o	GHA225011	K
	2002.02-	Hatchback Engine HFX(TU1JP)		o	GWB3658	
1.4 16V (65 kW)	2004.01-2006.09	Hatchback Engine KFV(ET3J4)	•		GHA421003	
	2004.01-2006.09	Hatchback Engine KFV(ET3J4)	•		GWB3554A	
	2004.01-2006.09	Hatchback Engine KFV(ET3J4)	•		GWB3657	
	2004.01-2006.09	Hatchback Engine KFV(ET3J4)		o	GHA225011	K
	2004.01-2006.09	Hatchback Engine KFV(ET3J4)		o	GWB3658	
1.4 16V HDi (66 kW)	2002.02-	Hatchback Engine 8HY(DV4TED4)	•		GHA421003	
	2002.02-	Hatchback Engine 8HY(DV4TED4)	•		GWB3554A	
	2002.02-	Hatchback Engine 8HY(DV4TED4)	•		GWB3657	
	2002.02-	Hatchback Engine 8HY(DV4TED4)		o	GHA225011	K
	2002.02-	Hatchback Engine 8HY(DV4TED4)		o	GWB3658	
1.4 Bioflex (60 kW)	2009.01-	Hatchback Engine KFV (TU3JP)	•		GHA421003	
	2009.01-	Hatchback Engine KFV (TU3JP)	•		GHA425022	
	2009.01-	Hatchback Engine KFV (TU3JP)	•		GWB3554A	
	2009.01-	Hatchback Engine KFV (TU3JP)	•		GWB3657	
	2009.01-	Hatchback Engine KFV (TU3JP)		o	GHA225011	K
	2009.01-	Hatchback Engine KFV (TU3JP)		o	GWB3658	
1.4 HDi (50 kW)	2002.02-	Hatchback Engine 8HX(DV4TD)	•		GHA421003	
	2002.02-	Hatchback Engine 8HX(DV4TD)	•		GWB3554A	
	2002.02-	Hatchback Engine 8HX(DV4TD)	•		GWB3657	
	2002.02-	Hatchback Engine 8HX(DV4TD)		o	GHA225011	K
	2002.02-	Hatchback Engine 8HX(DV4TD)		o	GWB3658	
1.4 HDi (52 kW)	2003.7-	Hatchback Engine 8HZ(DV4TD)	•		GWB3554A	
	2003.7-	Hatchback Engine 8HZ(DV4TD)	•		GWB3657	
	2003.7-	Hatchback Engine 8HZ(DV4TD)		o	GHA225011	K
	2003.7-	Hatchback Engine 8HZ(DV4TD)		o	GWB3658	
1.4 HDi (55 kW)	2005.05-	Hatchback	•		GHA421003	
	2005.05-	Hatchback	•		GWB3554A	
	2005.05-	Hatchback	•		GWB3657	
	2005.05-	Hatchback		o	GHA225011	K
	2005.05-	Hatchback		o	GWB3658	
1.4 i (54 kW)	2008.01-	Hatchback Engine KFV(TU3JP)/KFV(TU3A)	•		GHA421003	
	2008.01-	Hatchback Engine KFV(TU3JP)/KFV(TU3A)	•		GWB3554A	
	2008.01-	Hatchback Engine KFV(TU3JP)/KFV(TU3A)	•		GWB3657	
	2008.01-	Hatchback Engine KFV(TU3JP)/KFV(TU3A)		o	GHA225011	K
	2008.01-	Hatchback Engine KFV(TU3JP)/KFV(TU3A)		o	GWB3658	
1.4 i Bivalent (54 kW)	2002.02-	Hatchback Engine KFV(TU3JP)	•		GHA421003	



	 YEAR		F	R	G-AP Ref.	KIT
CITROEN						
C3 I (FC_)						
1.4 i Bivalent (54 kW)	2002.02-	Hatchback Engine KFV(TU3JP)	•		GWB3554A	
	2002.02-	Hatchback Engine KFV(TU3JP)	•		GWB3657	
	2002.02-	Hatchback Engine KFV(TU3JP)		o	GHA225011	K
	2002.02-	Hatchback Engine KFV(TU3JP)		o	GWB3658	
1.6 16V (80 kW)	2002.02-	Hatchback Engine NFU(TU5JP4)	•		GHA421003	
	2002.02-	Hatchback Engine NFU(TU5JP4)	•		GHA425022	
	2002.02-	Hatchback Engine NFU(TU5JP4)	•		GWB3657	
	2002.02-	Hatchback Engine NFU(TU5JP4)		o	GHA225011	K
	2002.02-	Hatchback Engine NFU(TU5JP4)		o	GWB3658	
1.6 16V (81 kW)	2003.5-2005.9	Hatchback Engine NFU(TU5JP4)	•		GHA421003	
	2003.5-2005.9	Hatchback Engine NFU(TU5JP4)	•		GHA425022	
	2003.5-2005.9	Hatchback Engine NFU(TU5JP4)	•		GWB3657	
	2003.5-2005.9	Hatchback Engine NFU(TU5JP4)		o	GHA225011	K
	2003.5-2005.9	Hatchback Engine NFU(TU5JP4)		o	GWB3658	
1.6 16V HDi (66 kW)	2005.05-2008.03	Hatchback Engine 9HX(DV6ATED4)	•		GHA421003	
	2005.05-2008.03	Hatchback Engine 9HX(DV6ATED4)	•		GWB3554A	
	2005.05-2008.03	Hatchback Engine 9HX(DV6ATED4)	•		GWB3584	
	2005.05-2008.03	Hatchback Engine 9HX(DV6ATED4)	•		GWB3657	
	2005.05-2008.03	Hatchback Engine 9HX(DV6ATED4)		o	GHA225011	K
	2005.05-2008.03	Hatchback Engine 9HX(DV6ATED4)		o	GWB3658	
1.6 16V HDi (80 kW)	2005.10-2008.03	Hatchback Engine DV6TED4	•		GHA421003	
	2005.10-2008.03	Hatchback Engine DV6TED4	•		GWB3554A	
	2005.10-2008.03	Hatchback Engine DV6TED4	•		GWB3584	
	2005.10-2008.03	Hatchback Engine DV6TED4	•		GWB3657	
	2005.10-2008.03	Hatchback Engine DV6TED4		o	GHA225011	K
	2005.10-2008.03	Hatchback Engine DV6TED4		o	GWB3658	
1.6 Bioflex (83 kW)	2005.06-	Hatchback Engine NFU (TU5JP4)	•		GHA421003	
	2005.06-	Hatchback Engine NFU (TU5JP4)	•		GWB3554A	
	2005.06-	Hatchback Engine NFU (TU5JP4)	•		GWB3657	
	2005.06-	Hatchback Engine NFU (TU5JP4)		o	GHA225011	K
	2005.06-	Hatchback Engine NFU (TU5JP4)		o	GWB3658	
C3 II						
1.0 VTi (50 kW)	2012.08-	Hatchback	•		GHA421003	
	2012.08-	Hatchback	•		GHA425022	
	2012.08-	Hatchback	•		GWB3584	
	2012.08-	Hatchback	•		GWB3657	
	2012.08-	Hatchback		o	GWB6544	
	2012.08-	Hatchback		o	GWB6726	
1.1 (44 kW)	2009.11-	Hatchback Engine HFX(TU1JP)	•		GWB3584	
	2009.11-	Hatchback Engine HFX(TU1JP)	•		GWB3657	
	2009.11-	Hatchback Engine HFX(TU1JP)		o	GWB6544	
	2009.11-	Hatchback Engine HFX(TU1JP)		o	GWB6726	
1.1 BiFuel (44 kW)	2010.11-	Hatchback Engine HFX (TU1A)	•		GHA421003	
	2010.11-	Hatchback Engine HFX (TU1A)	•		GHA425022	
	2010.11-	Hatchback Engine HFX (TU1A)	•		GWB3584	
	2010.11-	Hatchback Engine HFX (TU1A)	•		GWB3657	
	2010.11-	Hatchback Engine HFX (TU1A)		o	GWB6544	
	2010.11-	Hatchback Engine HFX (TU1A)		o	GWB6726	
1.2 VTi (60 kW)	2012.06-	Hatchback	•		GHA421003	
	2012.06-	Hatchback	•		GHA425022	
	2012.06-	Hatchback	•		GWB3584	
	2012.06-	Hatchback	•		GWB3657	
	2012.06-	Hatchback		o	GWB6544	
	2012.06-	Hatchback		o	GWB6726	
1.2 VTi (81 kW)	2014.10-	Hatchback	•		GHA421003	
	2014.10-	Hatchback	•		GHA425022	
	2014.10-	Hatchback	•		GWB3584	
	2014.10-	Hatchback	•		GWB3657	
	2014.10-	Hatchback		o	GWB6544	
	2014.10-	Hatchback		o	GWB6726	
1.4 (54 kW)	2009.11-	Hatchback Engine KFT(TU3A)	•		GHA421003	
	2009.11-	Hatchback Engine KFT(TU3A)	•		GHA425022	
	2009.11-	Hatchback Engine KFT(TU3A)	•		GWB3584	
	2009.11-	Hatchback Engine KFT(TU3A)	•		GWB3657	



	 YEAR		F	R	G-AP Ref.	KIT
CITROEN						
C3 II						
1.4 (54 kW)	2009.11-	Hatchback Engine KFT(TU3A)		o	GWB6544	
	2009.11-	Hatchback Engine KFT(TU3A)		o	GWB6726	
1.4 HDi (50 kW)	2009.11-	Hatchback Engine 8HR(DV4C)/8HZ(DV4TD)	•		GHA421003	
	2009.11-	Hatchback Engine 8HR(DV4C)/8HZ(DV4TD)	•		GHA425022	
	2009.11-	Hatchback Engine 8HR(DV4C)/8HZ(DV4TD)	•		GWB3584	
	2009.11-	Hatchback Engine 8HR(DV4C)/8HZ(DV4TD)	•		GWB3657	
	2009.11-	Hatchback Engine 8HR(DV4C)/8HZ(DV4TD)		o	GWB6544	
	2009.11-	Hatchback Engine 8HR(DV4C)/8HZ(DV4TD)		o	GWB6726	
1.4 LPG (70 kW)	2013.06-	Hatchback Engine 8FN (EP3)	•		GWB3584	
	2013.06-	Hatchback Engine 8FN (EP3)	•		GWB3657	
	2013.06-	Hatchback Engine 8FN (EP3)		o	GWB6544	
	2013.06-	Hatchback Engine 8FN (EP3)		o	GWB6726	
1.4 VTi (70 kW)	2009.11-	Hatchback Engine 8FP(EP3)	•		GHA421003	
	2009.11-	Hatchback Engine 8FP(EP3)	•		GHA425022	
	2009.11-	Hatchback Engine 8FP(EP3)	•		GWB3584	
	2009.11-	Hatchback Engine 8FP(EP3)	•		GWB3657	
	2009.11-	Hatchback Engine 8FP(EP3)		o	GWB6544	
	2009.11-	Hatchback Engine 8FP(EP3)		o	GWB6726	
1.6 BlueHDi 100 (73 kW)	2014.07-	Hatchback Engine BHY(DV6FD)	•		GWB3584	
	2014.07-	Hatchback Engine BHY(DV6FD)	•		GWB3657	
	2014.07-	Hatchback Engine BHY(DV6FD)		o	GWB6544	
	2014.07-	Hatchback Engine BHY(DV6FD)		o	GWB6726	
1.6 BlueHDi 75 (55 kW)	2015.04-	Hatchback Engine BHY(DV6FE)	•		GWB3584	
	2015.04-	Hatchback Engine BHY(DV6FE)	•		GWB3657	
	2015.04-	Hatchback Engine BHY(DV6FE)		o	GWB6544	
	2015.04-	Hatchback Engine BHY(DV6FE)		o	GWB6726	
1.6 HDi (66 kW)	2009.11-	Hatchback Engine 9HX(DV6ATED4)	•		GHA421003	
	2009.11-	Hatchback Engine 9HX(DV6ATED4)	•		GHA425022	
	2009.11-	Hatchback Engine 9HX(DV6ATED4)	•		GWB3584	
	2009.11-	Hatchback Engine 9HX(DV6ATED4)	•		GWB3657	
	2009.11-	Hatchback Engine 9HX(DV6ATED4)		o	GWB6544	
	2009.11-	Hatchback Engine 9HX(DV6ATED4)		o	GWB6726	
1.6 HDi (68 kW)	2009.11-	Hatchback Engine 9HP(DV6DTED)	•		GHA421003	
	2009.11-	Hatchback Engine 9HP(DV6DTED)	•		GHA425022	
	2009.11-	Hatchback Engine 9HP(DV6DTED)	•		GWB3584	
	2009.11-	Hatchback Engine 9HP(DV6DTED)	•		GWB3657	
	2009.11-	Hatchback Engine 9HP(DV6DTED)		o	GWB6544	
	2009.11-	Hatchback Engine 9HP(DV6DTED)		o	GWB6726	
1.6 HDi (82 kW)	2009.11-	Hatchback Engine 9HR(DV6C)	•		GHA421003	
	2009.11-	Hatchback Engine 9HR(DV6C)	•		GWB3584	
	2009.11-	Hatchback Engine 9HR(DV6C)	•		GWB3657	
	2009.11-	Hatchback Engine 9HR(DV6C)		o	GWB6544	
	2009.11-	Hatchback Engine 9HR(DV6C)		o	GWB6726	
1.6 HDi (84 kW)	2012.09-	Hatchback	•		GWB3584	
	2012.09-	Hatchback	•		GWB3657	
	2012.09-	Hatchback		o	GWB6544	
	2012.09-	Hatchback		o	GWB6726	
1.6 VTi (88 kW)	2009.11-	Hatchback Engine 5FS(EP6C)	•		GHA421003	
	2009.11-	Hatchback Engine 5FS(EP6C)	•		GHA425022	
	2009.11-	Hatchback Engine 5FS(EP6C)	•		GWB3584	
	2009.11-	Hatchback Engine 5FS(EP6C)	•		GWB3657	
	2009.11-	Hatchback Engine 5FS(EP6C)		o	GWB6544	
	2009.11-	Hatchback Engine 5FS(EP6C)		o	GWB6726	
C3 PICASSO						
1.2 THP 110 (81 kW)	2015.01-	MPV Engine HNZ (EB2DT)	•		GWB3584	
	2015.01-	MPV Engine HNZ (EB2DT)		o	GWB6544	
1.4 VTi (70 kW)	2009.02-	MPV Engine 8FS(EP3)	•		GHA425022	
	2009.02-	MPV Engine 8FS(EP3)	•		GWB3584	
	2009.02-	MPV Engine 8FS(EP3)		o	GWB6544	
1.4 VTi LPG (70 kW)	2012.01-	MPV Engine 8FP(EP3)	•		GWB3584	
	2012.01-	MPV Engine 8FP(EP3)		o	GWB6544	
1.6 BlueHDi 100 (73 kW)	2015.01-	MPV Engine BHY (DV6FD)	•		GWB3584	
	2015.01-	MPV Engine BHY (DV6FD)		o	GWB6544	
1.6 HDi (66 kW)	2009.02-	MPV Engine 9HX(DV6ATED4)	•		GHA425022	



	 YEAR		F	R	G-AP Ref.	KIT
CITROEN						
C3 PICASSO						
1.6 HDi (66 kW)	2009.02-	MPV Engine 9HX(DV6ATED4)	•		GWB3584	
	2009.02-	MPV Engine 9HX(DV6ATED4)		◦	GWB6544	
1.6 HDi (68 kW)	2010.07-	MPV Engine 9HP(DV6DTED)	•		GHA421003	
	2010.07-	MPV Engine 9HP(DV6DTED)	•		GHA425022	
	2010.07-	MPV Engine 9HP(DV6DTED)	•		GWB3584	
	2010.07-	MPV Engine 9HP(DV6DTED)		◦	GWB6544	
	2010.07-	MPV Engine 9HP(DV6DTED)		◦	GWB6544	
1.6 HDi (80 kW)	2009.02-	MPV Engine 9HZ(DV6TED4)	•		GHA425022	
	2009.02-	MPV Engine 9HZ(DV6TED4)	•		GWB3584	
	2009.02-	MPV Engine 9HZ(DV6TED4)		◦	GWB6544	
1.6 HDi (82 kW)	2010.05-	MPV Engine 9HR(DV6C)	•		GHA421003	
	2010.05-	MPV Engine 9HR(DV6C)	•		GHA425022	
	2010.05-	MPV Engine 9HR(DV6C)	•		GWB3584	
	2010.05-	MPV Engine 9HR(DV6C)		◦	GWB6544	
1.6 HDi (84 kW)	2013.01-	MPV Engine 9HL(DV6C)	•		GHA421003	
	2013.01-	MPV Engine 9HL(DV6C)	•		GHA425022	
	2013.01-	MPV Engine 9HL(DV6C)	•		GWB3584	
	2013.01-	MPV Engine 9HL(DV6C)		◦	GWB6544	
1.6 VTi (88 kW)	2009.02-	MPV Engine 5FS(EP6C)/5FW(EP6)	•		GHA425022	
	2009.02-	MPV Engine 5FS(EP6C)/5FW(EP6)	•		GWB3584	
	2009.02-	MPV Engine 5FS(EP6C)/5FW(EP6)		◦	GWB6544	
C3 PLURIEL (HB_)						
1.4 (54 kW)	2003.05-	Convertible Engine KFV(TU3JP)	•		GHA421003	
	2003.05-	Convertible Engine KFV(TU3JP)	•		GWB3554A	
	2003.05-	Convertible Engine KFV(TU3JP)	•		GWB3657	
	2003.05-	Convertible Engine KFV(TU3JP)		◦	GHA225011	K
	2003.05-	Convertible Engine KFV(TU3JP)		◦	GWB3658	
1.4 HDi (50 kW)	2005.10-2006.11	Convertible Engine 8HX(DV4TD)	•		GHA421003	
	2005.10-2006.11	Convertible Engine 8HX(DV4TD)	•		GWB3554A	
	2005.10-2006.11	Convertible Engine 8HX(DV4TD)	•		GWB3657	
	2005.10-2006.11	Convertible Engine 8HX(DV4TD)		◦	GHA225011	K
	2005.10-2006.11	Convertible Engine 8HX(DV4TD)		◦	GWB3658	
1.4 HybrID (54 kW)	2006.01-2008.04	Convertible Engine KFV(TU3JP)	•		GHA421003	
	2006.01-2008.04	Convertible Engine KFV(TU3JP)	•		GWB3554A	
	2006.01-2008.04	Convertible Engine KFV(TU3JP)	•		GWB3657	
	2006.01-2008.04	Convertible Engine KFV(TU3JP)		◦	GHA225011	K
	2006.01-2008.04	Convertible Engine KFV(TU3JP)		◦	GWB3658	
1.6 (80 kW)	2003.05-	Convertible Engine NFU(TU5JP4)	•		GHA421003	
	2003.05-	Convertible Engine NFU(TU5JP4)	•		GWB3554A	
	2003.05-	Convertible Engine NFU(TU5JP4)	•		GWB3657	
	2003.05-	Convertible Engine NFU(TU5JP4)		◦	GHA225011	K
	2003.05-	Convertible Engine NFU(TU5JP4)		◦	GWB3658	
C4						
1.6 16V (80 kW)	2006.07-	Saloon Engine NFU(TU5JP4)	•		GHA425022	
	2006.07-	Saloon Engine NFU(TU5JP4)	•		GWB3584	
	2006.07-	Saloon Engine NFU(TU5JP4)		◦	GHA225014	K
	2006.07-	Saloon Engine NFU(TU5JP4)		◦	GHA230145	K
	2006.07-	Saloon Engine NFU(TU5JP4)		◦	GWB3680	
	2006.07-	Saloon Engine NFU(TU5JP4)		◦	GWB6544	
1.6 HDi (80 kW)	2006.07-	Saloon Engine DV6TED4	•		GHA425022	
	2006.07-	Saloon Engine DV6TED4	•		GWB3584	
	2006.07-	Saloon Engine DV6TED4		◦	GHA225014	K
	2006.07-	Saloon Engine DV6TED4		◦	GHA230145	K
	2006.07-	Saloon Engine DV6TED4		◦	GWB3680	
	2006.07-	Saloon Engine DV6TED4		◦	GWB6544	
2.0 16V (103 kW)	2006.07-	Saloon Engine RFJ(EW10A)	•		GHA425022	
	2006.07-	Saloon Engine RFJ(EW10A)	•		GWB3584	
	2006.07-	Saloon Engine RFJ(EW10A)		◦	GHA225014	K
	2006.07-	Saloon Engine RFJ(EW10A)		◦	GHA230145	K
	2006.07-	Saloon Engine RFJ(EW10A)		◦	GWB3680	
	2006.07-	Saloon Engine RFJ(EW10A)		◦	GWB6544	
C4 (LA_)						
1.4 16V (65 kW)	2004.11-	Coupe Engine KFV(ET3J4)	•		GHA425022	
	2004.11-	Coupe Engine KFV(ET3J4)	•		GWB3584	
	2004.11-	Coupe Engine KFV(ET3J4)		◦	GHA225014	K



	 YEAR		F	R	G-AP Ref.	KIT
CITROEN						
C4 (LA_)						
1.4 16V (65 kW)	2004.11-	Coupe Engine KFU(ET3J4)		o	GHA225042	K
	2004.11-	Coupe Engine KFU(ET3J4)		o	GHA230145	K
	2004.11-	Coupe Engine KFU(ET3J4)		o	GWB3680	
	2004.11-	Coupe Engine KFU(ET3J4)		o	GWB6544	
1.6 16V (80 kW)	2004.11-	Coupe Engine NFU(TU5JP4)	•		GHA425022	
	2004.11-	Coupe Engine NFU(TU5JP4)	•		GWB3584	
	2004.11-	Coupe Engine NFU(TU5JP4)		o	GHA225014	K
	2004.11-	Coupe Engine NFU(TU5JP4)		o	GHA225042	K
	2004.11-	Coupe Engine NFU(TU5JP4)		o	GHA230145	K
	2004.11-	Coupe Engine NFU(TU5JP4)		o	GWB3680	
	2004.11-	Coupe Engine NFU(TU5JP4)		o	GWB6544	
1.6 HDi (66 kW)	2004.11-	Coupe Engine 9HX(DV6ATED4)	•		GHA425022	
	2004.11-	Coupe Engine 9HX(DV6ATED4)	•		GWB3584	
	2004.11-	Coupe Engine 9HX(DV6ATED4)		o	GHA225014	K
	2004.11-	Coupe Engine 9HX(DV6ATED4)		o	GHA225042	K
	2004.11-	Coupe Engine 9HX(DV6ATED4)		o	GHA230145	K
	2004.11-	Coupe Engine 9HX(DV6ATED4)		o	GWB3680	
	2004.11-	Coupe Engine 9HX(DV6ATED4)		o	GWB6544	
1.6 HDi (80 kW)	2006.02-	Coupe Engine 9HY(DV6TED4)/9HZ(DV6TED4)	•		GHA425022	
	2006.02-	Coupe Engine 9HY(DV6TED4)/9HZ(DV6TED4)	•		GWB3584	
	2006.02-	Coupe Engine 9HY(DV6TED4)/9HZ(DV6TED4)		o	GHA225014	K
	2006.02-	Coupe Engine 9HY(DV6TED4)/9HZ(DV6TED4)		o	GHA225042	K
	2006.02-	Coupe Engine 9HY(DV6TED4)/9HZ(DV6TED4)		o	GHA230145	K
	2006.02-	Coupe Engine 9HY(DV6TED4)/9HZ(DV6TED4)		o	GWB3680	
	2006.02-	Coupe Engine 9HY(DV6TED4)/9HZ(DV6TED4)		o	GWB6544	
1.6 THP (110 kW)	2008.07-	Coupe Engine 5FX(EP6DT)	•		GHA425022	
	2008.07-	Coupe Engine 5FX(EP6DT)	•		GWB3584	
	2008.07-	Coupe Engine 5FX(EP6DT)		o	GHA225014	K
	2008.07-	Coupe Engine 5FX(EP6DT)		o	GHA230145	K
	2008.07-	Coupe Engine 5FX(EP6DT)		o	GWB3680	
	2008.07-	Coupe Engine 5FX(EP6DT)		o	GWB6544	
1.6 VTi (88 kW)	2008.07-	Coupe Engine 5FW(EP6)	•		GHA425022	
	2008.07-	Coupe Engine 5FW(EP6)	•		GWB3584	
	2008.07-	Coupe Engine 5FW(EP6)		o	GHA225014	K
	2008.07-	Coupe Engine 5FW(EP6)		o	GHA230145	K
	2008.07-	Coupe Engine 5FW(EP6)		o	GWB3680	
	2008.07-	Coupe Engine 5FW(EP6)		o	GWB6544	
2.0 16V (100 kW)	2004.11-	Coupe Engine RFN(EW10J4)	•		GHA425022	
	2004.11-	Coupe Engine RFN(EW10J4)	•		GWB3584	
	2004.11-	Coupe Engine RFN(EW10J4)		o	GHA225014	K
	2004.11-	Coupe Engine RFN(EW10J4)		o	GHA225042	K
	2004.11-	Coupe Engine RFN(EW10J4)		o	GWB3680	
	2004.11-	Coupe Engine RFN(EW10J4)		o	GWB6544	
2.0 16V (130 kW)	2004.11-	Coupe Engine RFK(EW10J4S)	•		GHA425022	
	2004.11-	Coupe Engine RFK(EW10J4S)	•		GWB3584	
	2004.11-	Coupe Engine RFK(EW10J4S)		o	GHA225014	K
	2004.11-	Coupe Engine RFK(EW10J4S)		o	GHA225042	K
	2004.11-	Coupe Engine RFK(EW10J4S)		o	GHA230145	K
	2004.11-	Coupe Engine RFK(EW10J4S)		o	GWB3680	
	2004.11-	Coupe Engine RFK(EW10J4S)		o	GWB6544	
2.0 HDi (100 kW)	2004.11-	Coupe Engine RHR(DW10BTED4)	•		GHA425022	
	2004.11-	Coupe Engine RHR(DW10BTED4)	•		GWB3584	
	2004.11-	Coupe Engine RHR(DW10BTED4)		o	GHA225014	K
	2004.11-	Coupe Engine RHR(DW10BTED4)		o	GHA225042	K
	2004.11-	Coupe Engine RHR(DW10BTED4)		o	GHA230145	K
	2004.11-	Coupe Engine RHR(DW10BTED4)		o	GWB3680	
	2004.11-	Coupe Engine RHR(DW10BTED4)		o	GWB6544	
2.0 HDi (103 kW)	2008.07-	Coupe Engine RHF(DW10BTED4)	•		GHA425022	
	2008.07-	Coupe Engine RHF(DW10BTED4)	•		GWB3584	
	2008.07-	Coupe Engine RHF(DW10BTED4)		o	GHA225014	K
	2008.07-	Coupe Engine RHF(DW10BTED4)		o	GHA230145	K
	2008.07-	Coupe Engine RHF(DW10BTED4)		o	GWB3680	
	2008.07-	Coupe Engine RHF(DW10BTED4)		o	GWB6544	
2.0 VTR (103 kW)	2006.10-2007.12	Coupe Engine RFJ(EW10A)	•		GHA425022	



	 YEAR		F	R	G-AP Ref.	KIT
CITROEN						
C4 (LA_)						
2.0 VTR (103 kW)	2006.10-2007.12	Coupe Engine RFJ(EW10A)	•		GWB3584	
	2006.10-2007.12	Coupe Engine RFJ(EW10A)		◦	GHA225014	K
	2006.10-2007.12	Coupe Engine RFJ(EW10A)		◦	GHA230145	K
	2006.10-2007.12	Coupe Engine RFJ(EW10A)		◦	GWB3680	
	2006.10-2007.12	Coupe Engine RFJ(EW10A)		◦	GWB6544	
C4 AIRCROSS						
1.6 (86 kW)	2012.04-	Closed Off-Road Vehicle Engine 4A92	•		GWB7408	
1.6 HDi (84 kW)	2012.04-	Closed Off-Road Vehicle Engine 9HL(DV6C)	•		GWB7408	
1.6 HDi AWC (84 kW)	2012.05-	Closed Off-Road Vehicle Engine 9HL(DV6C)	•		GWB7408	
	2012.05-	Closed Off-Road Vehicle Engine 9HL(DV6C)		◦	GHA325018	K
1.8 HDi (110 kW)	2012.04-	Closed Off-Road Vehicle Engine 4N13	•		GWB7408	
1.8 HDi AWC (110 kW)	2012.04-	Closed Off-Road Vehicle Engine 4N13	•		GWB7408	
	2012.04-	Closed Off-Road Vehicle Engine 4N13		◦	GHA325018	K
C4 CACTUS						
1.2 THP (81 kW)	2014.09-	Hatchback	•		GWB3657	
	2014.09-	Hatchback		◦	GWB6544	
	2014.09-	Hatchback		◦	GWB6726	
1.2 VTi (55 kW)	2014.09-	Hatchback	•		GWB3657	
	2014.09-	Hatchback		◦	GWB6544	
	2014.09-	Hatchback		◦	GWB6726	
1.2 VTi (60 kW)	2014.09-	Hatchback	•		GWB3657	
	2014.09-	Hatchback		◦	GWB6544	
	2014.09-	Hatchback		◦	GWB6726	
1.6 BlueHDi (73 kW)	2014.09-	Hatchback	•		GWB3657	
	2014.09-	Hatchback		◦	GWB6544	
	2014.09-	Hatchback		◦	GWB6726	
1.6 HDi (68 kW)	2014.09-	Hatchback	•		GWB3657	
	2014.09-	Hatchback		◦	GWB6544	
	2014.09-	Hatchback		◦	GWB6726	
C4 GRAND PICASSO I (UA_)						
1.6 16V (103 kW)	2008.07-	MPV Engine 5FT(EP6DT)	•		GHA425022	
	2008.07-	MPV Engine 5FT(EP6DT)	•		GWB3584	
	2008.07-	MPV Engine 5FT(EP6DT)		◦	GHA230148	K
	2008.07-	MPV Engine 5FT(EP6DT)		◦	GWB6549	
1.6 16V (110 kW)	2008.10-	MPV Engine 5FX(EP6DT)	•		GHA425022	
	2008.10-	MPV Engine 5FX(EP6DT)	•		GWB3584	
	2008.10-	MPV Engine 5FX(EP6DT)		◦	GHA230148	K
	2008.10-	MPV Engine 5FX(EP6DT)		◦	GWB6549	
1.6 HDi (80 kW)	2006.12-	MPV Engine 9HY(DV6TED4)/9HZ(DV6TED4)	•		GHA425022	
	2006.12-	MPV Engine 9HY(DV6TED4)/9HZ(DV6TED4)	•		GWB3584	
	2006.12-	MPV Engine 9HY(DV6TED4)/9HZ(DV6TED4)		◦	GHA230148	K
	2006.12-	MPV Engine 9HY(DV6TED4)/9HZ(DV6TED4)		◦	GWB6549	
1.6 HDi (82 kW)	2010.09-	MPV Engine 9HR(DV6C)/9HL(DV6C)	•		GHA425022	
	2010.09-	MPV Engine 9HR(DV6C)/9HL(DV6C)	•		GWB3584	
	2010.09-	MPV Engine 9HR(DV6C)/9HL(DV6C)		◦	GHA230148	K
	2010.09-	MPV Engine 9HR(DV6C)/9HL(DV6C)		◦	GWB6549	
1.6 THP (115 kW)	2010.09-	MPV Engine 5FV(EP6CDT)	•		GHA425022	
	2010.09-	MPV Engine 5FV(EP6CDT)	•		GWB3584	
	2010.09-	MPV Engine 5FV(EP6CDT)		◦	GHA230148	K
	2010.09-	MPV Engine 5FV(EP6CDT)		◦	GWB6549	
1.6 VTi (88 kW)	2008.07-	MPV Engine 5FW(EP6)	•		GHA425022	
	2008.07-	MPV Engine 5FW(EP6)	•		GWB3584	
	2008.07-	MPV Engine 5FW(EP6)		◦	GHA230148	K
	2008.07-	MPV Engine 5FW(EP6)		◦	GWB6549	
1.8 i 16V (92 kW)	2006.12-	MPV Engine 6FY(EW7A)	•		GHA425022	
	2006.12-	MPV Engine 6FY(EW7A)	•		GWB3584	
	2006.12-	MPV Engine 6FY(EW7A)		◦	GHA230148	K
	2006.12-	MPV Engine 6FY(EW7A)		◦	GWB6549	
2.0 HDi (100 kW)	2006.12-	MPV Engine RHJ-DW10BTED4/RHR(DW10BTED4)	•		GHA425022	
	2006.12-	MPV Engine RHJ-DW10BTED4/RHR(DW10BTED4)	•		GWB3584	
	2006.12-	MPV Engine RHJ-DW10BTED4/RHR(DW10BTED4)		◦	GHA230148	K
	2006.12-	MPV Engine RHJ-DW10BTED4/RHR(DW10BTED4)		◦	GWB6549	
2.0 HDi (110 kW)	2009.07-	MPV Engine RHE(DW10CTED4)	•		GHA425022	
	2009.07-	MPV Engine RHE(DW10CTED4)	•		GWB3584	



	 YEAR		F	R	G-AP Ref.	KIT
CITROEN						
C4 GRAND PICASSO I (UA_)						
2.0 HDi (110 kW)	2009.07-	MPV Engine RHE(DW10CTED4)		o	GHA230148	K
	2009.07-	MPV Engine RHE(DW10CTED4)		o	GWB6549	
2.0 HDi (120 kW)	2010.09-	MPV Engine RHH(DW10CTED4)	•		GHA425022	
	2010.09-	MPV Engine RHH(DW10CTED4)	•		GWB3584	
	2010.09-	MPV Engine RHH(DW10CTED4)		o	GHA230148	K
	2010.09-	MPV Engine RHH(DW10CTED4)		o	GWB6549	
2.0 i 16V (103 kW)	2006.12-	MPV Engine RFJ(EW10A)	•		GHA425022	
	2006.12-	MPV Engine RFJ(EW10A)	•		GWB3584	
	2006.12-	MPV Engine RFJ(EW10A)		o	GHA230148	K
	2006.12-	MPV Engine RFJ(EW10A)		o	GWB6549	
2.0 i 16V (105 kW)	2010.01-	MPV Engine RFJ (EW10A)	•		GHA425022	
	2010.01-	MPV Engine RFJ (EW10A)	•		GWB3584	
	2010.01-	MPV Engine RFJ (EW10A)		o	GWB6549	
C4 GRAND PICASSO II						
1.2 THP 130 (96 kW)	2014.04-	MPV Engine HNY(EB2DTS)		o	GHA400335	K
1.6 BlueHDi 100 (73 kW)	2015.01-	MPV Engine BHY(DV6FD)		o	GHA400335	K
1.6 BlueHDi 120 (88 kW)	2014.07-			o	GHA400335	K
1.6 HDi (68 kW)	2013.09-	MPV Engine 9HP(DV6DTED)		o	GHA400335	K
1.6 HDi (85 kW)	2013.09-	MPV		o	GHA400335	K
1.6 THP (115 kW)	2013.09-	MPV Engine 5FV(EP6CDT)		o	GHA400335	K
1.6 THP 165 (121 kW)	2014.07-			o	GHA400335	K
1.6 VTi (88 kW)	2013.09-	MPV Engine 5FS(EP6C)		o	GHA400335	K
2.0 BlueHDi (110 kW)	2013.09-	MPV		o	GHA400335	K
C4 I (LC_)						
1.4 16V (65 kW)	2004.11-	Hatchback Engine KFU(ET3J4)	•		GHA425022	
	2004.11-	Hatchback Engine KFU(ET3J4)	•		GWB3584	
	2004.11-	Hatchback Engine KFU(ET3J4)		o	GHA225014	K
	2004.11-	Hatchback Engine KFU(ET3J4)		o	GHA225042	K
	2004.11-	Hatchback Engine KFU(ET3J4)		o	GHA230145	K
	2004.11-	Hatchback Engine KFU(ET3J4)		o	GWB3680	
1.6 16V (80 kW)	2004.11-	Hatchback Engine NFU(TU5JP4)	•		GHA425022	
	2004.11-	Hatchback Engine NFU(TU5JP4)	•		GWB3584	
	2004.11-	Hatchback Engine NFU(TU5JP4)		o	GHA225014	K
	2004.11-	Hatchback Engine NFU(TU5JP4)		o	GHA225042	K
	2004.11-	Hatchback Engine NFU(TU5JP4)		o	GHA230145	K
	2004.11-	Hatchback Engine NFU(TU5JP4)		o	GWB3680	
1.6 16V Bio-Flex (80 kW)	2007.09-	Hatchback Engine NFU(TU5JP4)	•		GHA425022	
	2007.09-	Hatchback Engine NFU(TU5JP4)	•		GWB3584	
	2007.09-	Hatchback Engine NFU(TU5JP4)		o	GHA225014	K
	2007.09-	Hatchback Engine NFU(TU5JP4)		o	GHA230145	K
	2007.09-	Hatchback Engine NFU(TU5JP4)		o	GWB3680	
1.6 Flex (81 kW)	2009.02-2011.07	Hatchback	•		GHA425022	
	2009.02-2011.07	Hatchback	•		GWB3584	
	2009.02-2011.07	Hatchback		o	GHA225014	K
	2009.02-2011.07	Hatchback		o	GWB3680	
	2009.02-2011.07	Hatchback		o	GWB6544	
1.6 HDi (66 kW)	2004.11-	Hatchback Engine 9HX(DV6ATED4)	•		GHA425022	
	2004.11-	Hatchback Engine 9HX(DV6ATED4)	•		GWB3584	
	2004.11-	Hatchback Engine 9HX(DV6ATED4)		o	GHA225014	K
	2004.11-	Hatchback Engine 9HX(DV6ATED4)		o	GHA225042	K
	2004.11-	Hatchback Engine 9HX(DV6ATED4)		o	GHA230145	K
	2004.11-	Hatchback Engine 9HX(DV6ATED4)		o	GWB3680	
1.6 HDi (80 kW)	2004.11-	Hatchback Engine 9HY(DV6TED4)/9HZ(DV6TED4)	•		GHA425022	
	2004.11-	Hatchback Engine 9HY(DV6TED4)/9HZ(DV6TED4)	•		GWB3584	
	2004.11-	Hatchback Engine 9HY(DV6TED4)/9HZ(DV6TED4)		o	GHA225014	K
	2004.11-	Hatchback Engine 9HY(DV6TED4)/9HZ(DV6TED4)		o	GHA225042	K
	2004.11-	Hatchback Engine 9HY(DV6TED4)/9HZ(DV6TED4)		o	GHA230145	K
	2004.11-	Hatchback Engine 9HY(DV6TED4)/9HZ(DV6TED4)		o	GWB3680	
1.6 THP (103 kW)	2008.07-	Hatchback Engine 5FT(EP6DT)	•		GHA425022	



	 YEAR		F	R	G-AP Ref.	KIT
CITROEN						
C4 I (LC_)						
1.6 THP (103 kW)	2008.07-	Hatchback Engine 5FT(EP6DT)	•		GWB3584	
	2008.07-	Hatchback Engine 5FT(EP6DT)		◦	GHA225014	K
	2008.07-	Hatchback Engine 5FT(EP6DT)		◦	GHA230145	K
	2008.07-	Hatchback Engine 5FT(EP6DT)		◦	GWB3680	
	2008.07-	Hatchback Engine 5FT(EP6DT)		◦	GWB6544	
1.6 THP (110 kW)	2008.07-	Hatchback Engine 5FX(EP6DT)	•		GHA425022	
	2008.07-	Hatchback Engine 5FX(EP6DT)	•		GWB3584	
	2008.07-	Hatchback Engine 5FX(EP6DT)		◦	GHA225014	K
	2008.07-	Hatchback Engine 5FX(EP6DT)		◦	GHA230145	K
	2008.07-	Hatchback Engine 5FX(EP6DT)		◦	GWB3680	
	2008.07-	Hatchback Engine 5FX(EP6DT)		◦	GWB6544	
1.6 VTi (88 kW)	2008.07-	Hatchback Engine 5FW(EP6)	•		GHA425022	
	2008.07-	Hatchback Engine 5FW(EP6)	•		GWB3584	
	2008.07-	Hatchback Engine 5FW(EP6)		◦	GHA225014	K
	2008.07-	Hatchback Engine 5FW(EP6)		◦	GHA230145	K
	2008.07-	Hatchback Engine 5FW(EP6)		◦	GWB3680	
2.0 16V (100 kW)	2004.11-	Hatchback Engine RFN(EW10J4)	•		GHA425022	
	2004.11-	Hatchback Engine RFN(EW10J4)	•		GWB3584	
	2004.11-	Hatchback Engine RFN(EW10J4)		◦	GHA225014	K
	2004.11-	Hatchback Engine RFN(EW10J4)		◦	GHA225042	K
	2004.11-	Hatchback Engine RFN(EW10J4)		◦	GWB3680	
2.0 16V (103 kW)	2004.11-	Hatchback Engine RFJ(EW10A)	•		GHA425022	
	2004.11-	Hatchback Engine RFJ(EW10A)	•		GWB3584	
	2004.11-	Hatchback Engine RFJ(EW10A)		◦	GHA225014	K
	2004.11-	Hatchback Engine RFJ(EW10A)		◦	GHA225042	K
	2004.11-	Hatchback Engine RFJ(EW10A)		◦	GHA230145	K
	2004.11-	Hatchback Engine RFJ(EW10A)		◦	GWB3680	
2.0 16V (130 kW)	2004.11-	Hatchback Engine RFK(EW10J4S)	•		GHA425022	
	2004.11-	Hatchback Engine RFK(EW10J4S)	•		GWB3584	
	2004.11-	Hatchback Engine RFK(EW10J4S)		◦	GHA225014	K
	2004.11-	Hatchback Engine RFK(EW10J4S)		◦	GWB3680	
	2004.11-	Hatchback Engine RFK(EW10J4S)		◦	GWB6544	
2.0 HDi (100 kW)	2006.02-2007.10	Hatchback Engine RHR(DW10BTED4)	•		GHA425022	
	2006.02-2007.10	Hatchback Engine RHR(DW10BTED4)	•		GWB3584	
	2006.02-2007.10	Hatchback Engine RHR(DW10BTED4)		◦	GHA225014	K
	2006.02-2007.10	Hatchback Engine RHR(DW10BTED4)		◦	GHA225042	K
	2006.02-2007.10	Hatchback Engine RHR(DW10BTED4)		◦	GHA230145	K
	2006.02-2007.10	Hatchback Engine RHR(DW10BTED4)		◦	GWB3680	
2.0 HDi (103 kW)	2008.07-	Hatchback Engine RHF(DW10BTED4)	•		GHA425022	
	2008.07-	Hatchback Engine RHF(DW10BTED4)	•		GWB3584	
	2008.07-	Hatchback Engine RHF(DW10BTED4)		◦	GHA225014	K
	2008.07-	Hatchback Engine RHF(DW10BTED4)		◦	GHA230145	K
	2008.07-	Hatchback Engine RHF(DW10BTED4)		◦	GWB3680	
	2008.07-	Hatchback Engine RHF(DW10BTED4)		◦	GWB6544	
2.0 HDi (81 kW)	2007.04-2008.07	Hatchback Engine RHZ (DW10ATED)	•		GHA425022	
C4 II (B7)						
1.2 THP (96 kW)	2014.04-	Hatchback	•		GWB3584	
	2014.04-	Hatchback	•		GWB3683	
	2014.04-	Hatchback		◦	GWB6549	
1.2 THP 110 (81 kW)	2015.02-	Hatchback Engine HNZ(EB2DT)	•		GWB3584	
	2015.02-	Hatchback Engine HNZ(EB2DT)	•		GWB3683	
	2015.02-	Hatchback Engine HNZ(EB2DT)		◦	GWB6549	
1.4 VTi (70 kW)	2009.11-	Hatchback Engine 8FP(EP3)	•		GHA425022	
	2009.11-	Hatchback Engine 8FP(EP3)	•		GWB3584	
	2009.11-	Hatchback Engine 8FP(EP3)		◦	GWB6549	
1.6 BlueHDi (73 kW)	2014.07-	Hatchback Engine BHY (DV6FD)	•		GWB3584	
	2014.07-	Hatchback Engine BHY (DV6FD)	•		GWB3683	
	2014.07-	Hatchback Engine BHY (DV6FD)		◦	GWB6549	
1.6 BlueHDi 120 (88 kW)	2015.02-	Hatchback Engine BHZ (DV6FC)	•		GWB3584	
	2015.02-	Hatchback Engine BHZ (DV6FC)	•		GWB3683	



	 YEAR		F	R	G-AP Ref.	KIT
CITROEN						
C4 II (B7)						
1.6 BlueHDI 120 (88 kW)	2015.02-	Hatchback Engine BHZ (DV6FC)		o	GWB6549	
1.6 HDi (68 kW)	2009.11-	Hatchback Engine 9HP(DV6DTED)	•		GWB3584	
	2009.11-	Hatchback Engine 9HP(DV6DTED)		o	GWB6549	
1.6 HDi (82 kW)	2009.11-	Hatchback Engine 9HR(DV6C)	•		GHA425022	
	2009.11-	Hatchback Engine 9HR(DV6C)	•		GWB3584	
	2009.11-	Hatchback Engine 9HR(DV6C)		o	GWB6549	
1.6 HDi (84 kW)	2012.07-	Hatchback Engine 9HR(DV6C)	•		GHA425022	
	2012.07-	Hatchback Engine 9HR(DV6C)	•		GWB3584	
	2012.07-	Hatchback Engine 9HR(DV6C)		o	GWB6549	
1.6 THP (115 kW)	2009.11-	Hatchback Engine 5FV(EP6CDT)	•		GHA425022	
	2009.11-	Hatchback Engine 5FV(EP6CDT)	•		GWB3584	
	2009.11-	Hatchback Engine 5FV(EP6CDT)	•		GWB3683	
	2009.11-	Hatchback Engine 5FV(EP6CDT)		o	GWB6549	
1.6 VTi (88 kW)	2009.11-	Hatchback Engine 5FS(EP6C)	•		GHA425022	
	2009.11-	Hatchback Engine 5FS(EP6C)	•		GWB3584	
	2009.11-	Hatchback Engine 5FS(EP6C)	•		GWB3683	
	2009.11-	Hatchback Engine 5FS(EP6C)		o	GWB6549	
1.6 VTi LPG (88 kW)	2011.09-	Hatchback Engine 5FS(EP6C)	•		GHA425022	
	2011.09-	Hatchback Engine 5FS(EP6C)	•		GWB3584	
	2011.09-	Hatchback Engine 5FS(EP6C)		o	GWB6549	
2.0 HDi (110 kW)	2009.11-	Hatchback Engine RHE(DW10CTED4)	•		GHA425022	
	2009.11-	Hatchback Engine RHE(DW10CTED4)	•		GWB3584	
	2009.11-	Hatchback Engine RHE(DW10CTED4)	•		GWB3683	
	2009.11-	Hatchback Engine RHE(DW10CTED4)		o	GWB6549	
C4 PICASSO I (UD_)						
1.6 16V (110 kW)	2008.07-	MPV Engine 5FX(EP6DT)	•		GHA425022	
	2008.07-	MPV Engine 5FX(EP6DT)	•		GWB3584	
	2008.07-	MPV Engine 5FX(EP6DT)		o	GHA230148	K
	2008.07-	MPV Engine 5FX(EP6DT)		o	GWB6549	
1.6 HDi (80 kW)	2007.03-	MPV Engine 9HY(DV6TED4)/9HZ(DV6TED4)	•		GHA425022	
	2007.03-	MPV Engine 9HY(DV6TED4)/9HZ(DV6TED4)	•		GWB3584	
	2007.03-	MPV Engine 9HY(DV6TED4)/9HZ(DV6TED4)		o	GHA230148	K
	2007.03-	MPV Engine 9HY(DV6TED4)/9HZ(DV6TED4)		o	GWB6549	
1.6 HDi (82 kW)	2010.09-	MPV Engine 9HR(DV6C)	•		GHA425022	
	2010.09-	MPV Engine 9HR(DV6C)	•		GWB3584	
	2010.09-	MPV Engine 9HR(DV6C)		o	GHA230148	K
	2010.09-	MPV Engine 9HR(DV6C)		o	GWB6549	
1.6 THP (103 kW)	2008.07-	MPV Engine 5FT(EP6DT)	•		GHA425022	
	2008.07-	MPV Engine 5FT(EP6DT)	•		GWB3584	
	2008.07-	MPV Engine 5FT(EP6DT)		o	GHA230148	K
	2008.07-	MPV Engine 5FT(EP6DT)		o	GWB6549	
1.6 THP (115 kW)	2010.09-	MPV Engine 5FV(EP6CDT)	•		GHA425022	
	2010.09-	MPV Engine 5FV(EP6CDT)	•		GWB3584	
	2010.09-	MPV Engine 5FV(EP6CDT)		o	GHA230148	K
	2010.09-	MPV Engine 5FV(EP6CDT)		o	GWB6549	
1.6 VTi (88 kW)	2008.07-	MPV Engine 5FW(EP6)	•		GHA425022	
	2008.07-	MPV Engine 5FW(EP6)	•		GWB3584	
	2008.07-	MPV Engine 5FW(EP6)		o	GHA230148	K
	2008.07-	MPV Engine 5FW(EP6)		o	GWB6549	
1.8 i 16V (92 kW)	2007.03-	MPV Engine 6FY(EW7A)	•		GHA425022	
	2007.03-	MPV Engine 6FY(EW7A)	•		GWB3584	
	2007.03-	MPV Engine 6FY(EW7A)		o	GHA230148	K
	2007.03-	MPV Engine 6FY(EW7A)		o	GWB6549	
	2009.01-	MPV Engine 6FY(EW7A)	•		GHA425022	
	2009.01-	MPV Engine 6FY(EW7A)	•		GWB3584	
	2009.01-	MPV Engine 6FY(EW7A)		o	GWB6549	
2.0 HDi (100 kW)	2007.03-	MPV Engine RHJ-DW10BTED4/RHR(DW10BTED4)	•		GHA425022	
	2007.03-	MPV Engine RHJ-DW10BTED4/RHR(DW10BTED4)	•		GWB3584	
	2007.03-	MPV Engine RHJ-DW10BTED4/RHR(DW10BTED4)		o	GHA230148	K
	2007.03-	MPV Engine RHJ-DW10BTED4/RHR(DW10BTED4)		o	GWB6549	
2.0 HDi (110 kW)	2009.07-	MPV Engine RHE(DW10CTED4)	•		GHA425022	
	2009.07-	MPV Engine RHE(DW10CTED4)	•		GWB3584	
	2009.07-	MPV Engine RHE(DW10CTED4)		o	GHA230148	K
	2009.07-	MPV Engine RHE(DW10CTED4)		o	GWB6549	



	 YEAR		F	R	G-AP Ref.	KIT
CITROEN						
C4 PICASSO I (UD_)						
2.0 HDi (120 kW)	2010.09-	MPV Engine RHH(DW10CTED4)	•		GHA425022	
	2010.09-	MPV Engine RHH(DW10CTED4)	•		GWB3584	
	2010.09-	MPV Engine RHH(DW10CTED4)		o	GHA230148	K
	2010.09-	MPV Engine RHH(DW10CTED4)		o	GWB6549	
2.0 i 16V (103 kW)	2007.03-	MPV Engine RFJ(EW10A)	•		GHA425022	
	2007.03-	MPV Engine RFJ(EW10A)	•		GWB3584	
	2007.03-	MPV Engine RFJ(EW10A)		o	GHA230148	K
	2007.03-	MPV Engine RFJ(EW10A)		o	GWB6549	
C4 PICASSO II						
1.2 THP 130 (96 kW)	2014.04-	MPV Engine HNY(EB2DTS)		o	GHA400335	K
1.6 BlueHDi 120 (88 kW)	2014.07-			o	GHA400335	K
1.6 HDi (85 kW)	2013.02-	MPV		o	GHA400335	K
1.6 HDi 90 (68 kW)	2013.02-	MPV Engine 9HP(DV6DTE)		o	GHA400335	K
1.6 THP (115 kW)	2013.02-	MPV Engine 5FV(EP6CDT)		o	GHA400335	K
1.6 THP 165 (121 kW)	2014.07-			o	GHA400335	K
1.6 VTi (88 kW)	2013.02-	MPV Engine 5FS(EP6C)		o	GHA400335	K
2.0 BLUE HDi (110 kW)	2013.09-	MPV		o	GHA400335	K
C5 I (DC_)						
1.8 16V (85 kW)	2001.03-2004.08	Hatchback Engine 6FZ(EW7J4)	•		GWB3584	
	2001.03-2004.08	Hatchback Engine 6FZ(EW7J4)		o	GHA232030	K
2.0 16V (100 kW)	2001.03-2004.08	Hatchback Engine RFN(EW10J4)	•		GWB3584	
	2001.03-2004.08	Hatchback Engine RFN(EW10J4)		o	GHA232030	K
2.0 16V HPI (103 kW)	2001.03-2004.08	Hatchback Engine RLZ(EW10D)	•		GWB3584	
	2001.03-2004.08	Hatchback Engine RLZ(EW10D)		o	GHA232030	K
2.0 HDi (66 kW)	2001.03-2004.08	Hatchback Engine RHY(DW10TD)	•		GWB3584	
	2001.03-2004.08	Hatchback Engine RHY(DW10TD)		o	GHA232030	K
2.0 HDi (79 kW)	2001.03-2004.08	Hatchback Engine RHS(DW10ATED)/RHZ(DW10ATED)	•		GWB3584	
	2001.03-2004.08	Hatchback Engine RHS(DW10ATED)/RHZ(DW10ATED)		o	GHA232030	K
2.0 HDi (80 kW)	2001.03-2004.08	Hatchback Engine RHZ(DW10ATED)	•		GWB3584	
	2001.03-2004.08	Hatchback Engine RHZ(DW10ATED)		o	GHA232030	K
2.2 HDi (98 kW)	2001.03-2004.08	Hatchback Engine 4HX(DW12TED4/FAP)	•		GWB3584	
	2001.03-2004.08	Hatchback Engine 4HX(DW12TED4/FAP)		o	GHA232030	K
3.0 V6 (152 kW)	2001.03-2004.08	Hatchback Engine XFX(ES9J4S)	•		GWB3584	
	2001.03-2004.08	Hatchback Engine XFX(ES9J4S)		o	GHA232030	K
C5 I (DE_)						
1.8 16V (85 kW)	2001.06-2004.08	Estate Engine 6FZ(EW7J4)	•		GWB3584	
	2001.06-2004.08	Estate Engine 6FZ(EW7J4)		o	GHA232030	K
2.0 16V (100 kW)	2001.06-2004.08	Estate Engine RFN(EW10J4)	•		GWB3584	
	2001.06-2004.08	Estate Engine RFN(EW10J4)		o	GHA232030	K
2.0 16V HPI (103 kW)	2001.06-2004.08	Estate Engine RLZ(EW10D)	•		GWB3584	
	2001.06-2004.08	Estate Engine RLZ(EW10D)		o	GHA232030	K
2.0 HDi (66 kW)	2001.06-2004.08	Estate Engine RHY(DW10TD)	•		GWB3584	
	2001.06-2004.08	Estate Engine RHY(DW10TD)		o	GHA232030	K
2.0 HDi (79 kW)	2001.06-2004.08	Estate Engine RHS(DW10ATED)/RHZ(DW10ATED)	•		GWB3584	
	2001.06-2004.08	Estate Engine RHS(DW10ATED)/RHZ(DW10ATED)		o	GHA232030	K
2.0 HDi (80 kW)	2001.06-2004.08	Estate Engine RHZ(DW10ATED)	•		GWB3584	
	2001.06-2004.08	Estate Engine RHZ(DW10ATED)		o	GHA232030	K
2.2 HDi (98 kW)	2001.06-2004.08	Estate Engine 4HX(DW12TED4/FAP)	•		GWB3584	
	2001.06-2004.08	Estate Engine 4HX(DW12TED4/FAP)		o	GHA232030	K
3.0 Carlsso (173 kW)	2003.09-2004.08	Estate	•		GWB3584	
	2003.09-2004.08	Estate		o	GHA232030	K
3.0 V6 (152 kW)	2001.06-2004.08	Estate Engine XFX(ES9J4S)	•		GWB3584	
	2001.06-2004.08	Estate Engine XFX(ES9J4S)		o	GHA232030	K
C5 II (RC_)						
1.6 HDi (80 kW)	2004.09-2007.06	Hatchback Engine 9HY(DV6TED4)	•		GWB3584	
	2004.09-2007.06	Hatchback Engine 9HY(DV6TED4)		o	GHA232030	K
1.8 16V (85 kW)	2004.09-2005.10	Hatchback Engine 6FZ(EW7J4)	•		GWB3584	
	2004.09-2005.10	Hatchback Engine 6FZ(EW7J4)		o	GHA232030	K
1.8 16V (92 kW)	2005.10-2007.06	Hatchback Engine 6FY-EW7A	•		GWB3584	
	2005.10-2007.06	Hatchback Engine 6FY-EW7A		o	GHA232030	K
2.0 16V (103 kW)	2004.09-	Hatchback Engine RFJ(EW10A)	•		GWB3584	
	2004.09-	Hatchback Engine RFJ(EW10A)		o	GHA232030	K
2.0 HDi (100 kW)	2007.12-	Hatchback Engine RHR(DW10BTED4)	•		GWB3584	



	 YEAR		F	R	G-AP Ref.	KIT
CITROEN						
C5 II (RC_)						
2.0 HDi (100 kW)	2007.12-	Hatchback Engine RHR(DW10BTED4)		o	GHA232030	K
2.2 HDi (125 kW)	2006.08-	Hatchback Engine 4HT(DW12BTED4)	•		GWB3584	
	2006.08-	Hatchback Engine 4HT(DW12BTED4)		o	GHA232030	K
2.2 HDi (98 kW)	2004.09-	Hatchback Engine 4HX(DW12TED4/FAP)	•		GWB3584	
	2004.09-	Hatchback Engine 4HX(DW12TED4/FAP)		o	GHA232030	K
3.0 V6 (152 kW)	2004.09-	Hatchback Engine XfV(ES9A)/XfX(ES9J4S)/XfU(ES9A)	•		GWB3584	
	2004.09-	Hatchback Engine XfV(ES9A)/XfX(ES9J4S)/XfU(ES9A)		o	GHA232030	K
3.0 V6 (155 kW)	2004.10-2007.04	Hatchback Engine XfV (ES9A)	•		GWB3584	
	2004.10-2007.04	Hatchback Engine XfV (ES9A)		o	GHA232030	K
C5 II BREAK (RE_)						
1.6 HDi (80 kW)	2004.09-2007.06	Estate Engine 9HY(DV6TED4)/9HZ(DV6TED4)	•		GWB3584	
	2004.09-2007.06	Estate Engine 9HY(DV6TED4)/9HZ(DV6TED4)		o	GHA232030	K
1.8 16V (85 kW)	2004.09-	Estate Engine 6FZ(EW7J4)	•		GWB3584	
	2004.09-	Estate Engine 6FZ(EW7J4)		o	GHA232030	K
1.8 16V (92 kW)	2005.10-2006.11	Estate Engine 6FY-EW7A	•		GWB3584	
	2005.10-2006.11	Estate Engine 6FY-EW7A		o	GHA232030	K
2.0 16V (103 kW)	2004.09-	Estate Engine RFJ(EW10A)	•		GWB3584	
	2004.09-	Estate Engine RFJ(EW10A)		o	GHA232030	K
2.0 HDi (100 kW)	2004.09-	Estate Engine RHR(DW10BTED4)	•		GWB3584	
	2004.09-	Estate Engine RHR(DW10BTED4)		o	GHA232030	K
2.2 HDi (120 kW)	2006.05-	Estate Engine 4HR (DW12BTED4)/4HP (DW12BTED4)	•		GWB3584	
	2006.05-	Estate Engine 4HR (DW12BTED4)/4HP (DW12BTED4)		o	GHA232030	K
2.2 HDi (125 kW)	2006.08-	Estate Engine 4HT(DW12BTED4)	•		GWB3584	
	2006.08-	Estate Engine 4HT(DW12BTED4)		o	GHA232030	K
2.2 HDi (98 kW)	2004.09-	Estate Engine 4HX(DW12TED4/FAP)	•		GWB3584	
	2004.09-	Estate Engine 4HX(DW12TED4/FAP)		o	GHA232030	K
3.0 (173 kW)	2004.09-	Estate	•		GWB3584	
	2004.09-	Estate		o	GHA232030	K
3.0 V6 (152 kW)	2004.09-2006.11	Estate Engine XfV(ES9A)	•		GWB3584	
	2004.09-2006.11	Estate Engine XfV(ES9A)		o	GHA232030	K
3.0 V6 (155 kW)	2004.10-2007.04	Estate Engine XfU (ES9A)	•		GWB3584	
	2004.10-2007.04	Estate Engine XfU (ES9A)		o	GHA232030	K
C5 III (RD_)						
1.6 HDi (80 kW)	2008.02-	Saloon Engine 9HZ(DV6TED4)	•		GWB3683	
	2008.02-	Saloon Engine 9HZ(DV6TED4)		o	GHA232029	K
1.6 HDi (82 kW)	2010.07-	Saloon Engine 9HR(DV6C)	•		GWB3683	
	2010.07-	Saloon Engine 9HR(DV6C)		o	GHA232029	K
1.6 HDi (84 kW)	2012.01-	Saloon Engine 9HR(DV6C)	•		GWB3683	
	2012.01-	Saloon Engine 9HR(DV6C)		o	GHA232029	K
1.6 THP (110 kW)	2010.07-	Saloon Engine 5FN(EP6CDT)	•		GWB3683	
	2010.07-	Saloon Engine 5FN(EP6CDT)		o	GHA232029	K
1.6 THP (115 kW)	2009.04-	Saloon Engine 5FV(EP6DT)	•		GWB3683	
	2009.04-	Saloon Engine 5FV(EP6DT)		o	GHA232029	K
1.6 VTi (88 kW)	2010.07-	Saloon Engine 5FS(EP6C)	•		GWB3683	
	2010.07-	Saloon Engine 5FS(EP6C)		o	GHA232029	K
1.8 16V (92 kW)	2008.02-	Saloon Engine 6FY(EW7A)	•		GWB3683	
	2008.02-	Saloon Engine 6FY(EW7A)		o	GHA232029	K
2.0 16V (103 kW)	2008.02-	Saloon Engine RFJ(EW10A)	•		GWB3683	
	2008.02-	Saloon Engine RFJ(EW10A)		o	GHA232029	K
2.0 16V BioFlex (103 kW)	2008.02-	Saloon Engine RFJ(EW10A)	•		GWB3683	
	2008.02-	Saloon Engine RFJ(EW10A)		o	GHA232029	K
2.0 HDi (100 kW)	2008.02-	Saloon Engine RHF(DW10BTED4)/RHR(DW10BTED4)	•		GWB3683	
	2008.02-	Saloon Engine RHF(DW10BTED4)/RHR(DW10BTED4)		o	GHA232029	K
2.0 HDi (103 kW)	2009.04-	Saloon Engine RHF(DW10BTED4)	•		GWB3683	
	2009.04-	Saloon Engine RHF(DW10BTED4)		o	GHA232029	K
2.0 HDi (120 kW)	2009.04-	Saloon Engine RHH(DW10CTED4)	•		GWB3683	
	2009.04-	Saloon Engine RHH(DW10CTED4)		o	GHA232029	K
2.0 HDi 150 / BlueHDi 150 (110 kW)	2009.04-	Saloon Engine AHR (DW10FD)/RHE (DW10CTED4)	•		GWB3683	
	2009.04-	Saloon Engine AHR (DW10FD)/RHE (DW10CTED4)		o	GHA232029	K
2.0 HDi 180 (133 kW)	2015.03-	Saloon Engine AHW (DW10FC)	•		GWB3683	
	2015.03-	Saloon Engine AHW (DW10FC)		o	GHA232029	K
2.2 HDi (125 kW)	2008.02-	Saloon Engine 4HT(DW12BTED4)	•		GWB3683	
	2008.02-	Saloon Engine 4HT(DW12BTED4)		o	GHA232029	K
2.2 HDi (150 kW)	2010.07-	Saloon Engine 4HL(DW12C)	•		GWB3683	



	 YEAR		F	R	G-AP Ref.	KIT
CITROEN						
C5 III (RD_)						
2.2 HDi (150 kW)	2010.07-	Saloon Engine 4HL(DW12C)		o	GHA232029	K
2.7 HDi (150 kW)	2008.02-	Saloon Engine DT17ED4	•		GWB3683	
	2008.02-	Saloon Engine DT17ED4		o	GHA232029	K
3.0 HDi (177 kW)	2009.04-	Saloon Engine DT20C	•		GWB3683	
	2009.04-	Saloon Engine DT20C		o	GHA232029	K
3.0 V6 (155 kW)	2008.02-	Saloon Engine XFU(ES9A)	•		GWB3683	
	2008.02-	Saloon Engine XFU(ES9A)		o	GHA232029	K
C5 III BREAK (TD_)						
1.6 HDi (80 kW)	2008.02-	Estate Engine 9HZ(DV6TED4)	•		GWB3683	
	2008.02-	Estate Engine 9HZ(DV6TED4)		o	GHA232029	K
1.6 HDi (82 kW)	2010.07-	Estate Engine 9HR(DV6C)	•		GWB3683	
	2010.07-	Estate Engine 9HR(DV6C)		o	GHA232029	K
1.6 HDi (84 kW)	2012.01-	Estate Engine 9HR(DV6C)	•		GWB3683	
	2012.01-	Estate Engine 9HR(DV6C)		o	GHA232029	K
1.6 THP (110 kW)	2009.04-	Estate Engine 5FN(EP6CDT)	•		GWB3683	
	2009.04-	Estate Engine 5FN(EP6CDT)		o	GHA232029	K
1.6 THP (115 kW)	2009.04-	Estate Engine 5FV(EP6DT)	•		GWB3683	
	2009.04-	Estate Engine 5FV(EP6DT)		o	GHA232029	K
1.6 VTi (88 kW)	2010.07-	Estate Engine 5FS(EP6C)	•		GWB3683	
	2010.07-	Estate Engine 5FS(EP6C)		o	GHA232029	K
1.8 16V (92 kW)	2008.02-	Estate Engine 6FY(EW7A)	•		GWB3683	
	2008.02-	Estate Engine 6FY(EW7A)		o	GHA232029	K
2.0 16V (103 kW)	2008.02-	Estate Engine RFJ(EW10A)	•		GWB3683	
	2008.02-	Estate Engine RFJ(EW10A)		o	GHA232029	K
2.0 16V BioFlex (103 kW)	2008.02-	Estate Engine RFJ(EW10A)	•		GWB3683	
	2008.02-	Estate Engine RFJ(EW10A)		o	GHA232029	K
2.0 HDi (100 kW)	2008.02-	Estate Engine RHR(DW10BTED4)	•		GWB3683	
	2008.02-	Estate Engine RHR(DW10BTED4)		o	GHA232029	K
2.0 HDi (103 kW)	2009.04-	Estate Engine RHF(DW10BTED4)	•		GWB3683	
	2009.04-	Estate Engine RHF(DW10BTED4)		o	GHA232029	K
2.0 HDi (110 kW)	2009.04-	Estate Engine RHE(DW10CTED4)	•		GWB3683	
	2009.04-	Estate Engine RHE(DW10CTED4)		o	GHA232029	K
2.0 HDi (120 kW)	2009.04-	Estate Engine RHH(DW10CTED4)	•		GWB3683	
	2009.04-	Estate Engine RHH(DW10CTED4)		o	GHA232029	K
2.0 HDi 180 (133 kW)	2015.03-	Estate Engine AHW (DW10FC)	•		GWB3683	
	2015.03-	Estate Engine AHW (DW10FC)		o	GHA232029	K
2.2 HDi (120 kW)	2008.02-	Estate Engine 4HP(DW12BTED4)	•		GWB3683	
	2008.02-	Estate Engine 4HP(DW12BTED4)		o	GHA232029	K
2.2 HDi (125 kW)	2008.02-	Estate Engine 4HT(DW12BTED4)	•		GWB3683	
	2008.02-	Estate Engine 4HT(DW12BTED4)		o	GHA232029	K
2.2 HDi (150 kW)	2010.07-	Estate Engine 4HL(DW12C)	•		GWB3683	
	2010.07-	Estate Engine 4HL(DW12C)		o	GHA232029	K
2.7 HDi (150 kW)	2008.02-	Estate Engine DT17ED4/UHZ(DT17BTED4)	•		GWB3683	
	2008.02-	Estate Engine DT17ED4/UHZ(DT17BTED4)		o	GHA232029	K
3.0 HDi (177 kW)	2009.04-	Estate Engine DT20C	•		GWB3683	
	2009.04-	Estate Engine DT20C		o	GHA232029	K
3.0 V6 (155 kW)	2008.02-	Estate Engine XFU(ES9A)	•		GWB3683	
	2008.02-	Estate Engine XFU(ES9A)		o	GHA232029	K
C6 (TD_)						
2.2 HDi (120 kW)	2006.06-	Estate Engine 4HP(DW12BTED4)	•		GWB3683	
	2006.06-	Estate Engine 4HP(DW12BTED4)		o	GHA232029	K
2.2 HDi (125 kW)	2006.11-	Saloon Engine 4HT(DW12BTED4)	•		GWB3683	
	2006.11-	Saloon Engine 4HT(DW12BTED4)		o	GHA232029	K
2.7 HDi (150 kW)	2006.02-	Saloon Engine DT17ED4/UHZ(DT17BTED4)	•		GWB3683	
	2006.02-	Saloon Engine DT17ED4/UHZ(DT17BTED4)		o	GHA232029	K
3.0 HDi (177 kW)	2009.04-	Saloon Engine DT20C	•		GWB3683	
	2009.04-	Saloon Engine DT20C		o	GHA232029	K
3.0 V6 (155 kW)	2006.02-	Saloon Engine XFV(ES9J4S)/XFV(ES9A)	•		GWB3683	
	2006.02-	Saloon Engine XFV(ES9J4S)/XFV(ES9A)		o	GHA232029	K
C8 (EA_, EB_)						
2.0 (100 kW)	2002.07-	MPV Engine RFN(EW10J4)	•		GWB3633	
	2002.07-	MPV Engine RFN(EW10J4)		o	GHA230121	K
2.0 16V (103 kW)	2005.10-2008.03	MPV Engine RFJ(EW10A)	•		GWB3633	
	2005.10-2008.03	MPV Engine RFJ(EW10A)		o	GHA230121	K



	 YEAR		F	R	G-AP Ref.	KIT
CITROEN						
C8 (EA_, EB_)						
2.0 16V (104 kW)	2005.09-	MPV Engine RFJ(EW10A)	•		GWB3633	
	2005.09-	MPV Engine RFJ(EW10A)		◦	GHA230121	K
2.0 HDi (100 kW)	2006.07-2008.03	MPV Engine RHR(DW10BTED4)	•		GWB3633	
	2006.07-2008.03	MPV Engine RHR(DW10BTED4)		◦	GHA230121	K
2.0 HDi (120 kW)	2006.03-	MPV Engine RHE(DW10CTED4)/RHH(DW10CTED4)	•		GWB3633	
	2006.03-	MPV Engine RHE(DW10CTED4)/RHH(DW10CTED4)		◦	GHA230121	K
2.0 HDi (79 kW)	2002.07-	MPV Engine RHM(DW10ATED4)/RHT(DW10ATED4)	•		GWB3633	
	2002.07-	MPV Engine RHM(DW10ATED4)/RHT(DW10ATED4)		◦	GHA230121	K
2.0 HDi (80 kW)	2002.07-	MPV Engine RHW (DW10ATED4)	•		GWB3633	
	2002.07-	MPV Engine RHW (DW10ATED4)		◦	GHA230121	K
2.0 HDi (88 kW)	2006.07-2008.03	MPV Engine RHK(DW10UTED4)	•		GWB3633	
	2006.07-2008.03	MPV Engine RHK(DW10UTED4)		◦	GHA230121	K
2.2 (116 kW)	2002.07-	MPV Engine 3FZ(EW12J4)	•		GWB3633	
	2002.07-	MPV Engine 3FZ(EW12J4)		◦	GHA230121	K
2.2 HDi (120 kW)	2007.06-	MPV Engine 4HP(DW12BTED4)/4HR(DW12BTED4)	•		GWB3633	
	2007.06-	MPV Engine 4HP(DW12BTED4)/4HR(DW12BTED4)		◦	GHA230121	K
2.2 HDi (125 kW)	2006.06-	MPV Engine 4HT(DW12BTED4)		◦	GHA230121	K
2.2 HDi (94 kW)	2002.07-	MPV Engine 4HW(DW12TED4)	•		GWB3633	
	2002.07-	MPV Engine 4HW(DW12TED4)		◦	GHA230121	K
3.0 V6 (150 kW)	2002.07-	MPV Engine XFX(ES9J4S)	•		GWB3649	
	2002.07-	MPV Engine XFX(ES9J4S)		◦	GHA230121	K
C-CROSSER (EP_)						
2.0 (108 kW)	2010.11-	Closed Off-Road Vehicle Engine 4B11	•		GWB7408	
	2010.11-	Closed Off-Road Vehicle Engine 4B11	•		GWB7408	
	2010.11-	Closed Off-Road Vehicle Engine 4B11		◦	GHA325018	K
2.2 HDi (115 kW)	2007.07-	Closed Off-Road Vehicle Engine 4HN(DW12MTED4)	•		GWB7408	
	2007.07-	Closed Off-Road Vehicle Engine 4HN(DW12MTED4)		◦	GHA327044	K
2.4 16V (125 kW)	2008.08-	Closed Off-Road Vehicle Engine SFZ(4B12-MMC)	•		GWB7408	
	2008.08-	Closed Off-Road Vehicle Engine SFZ(4B12-MMC)		◦	GHA327044	K
C-CROSSER ENTERPRISE						
2.2 HDi (115 kW)	2009.01-	Box Engine 4HN(DW12MTED4)	•		GWB7408	
	2009.01-	Box Engine 4HN(DW12MTED4)		◦	GHA327044	K
2.4 16V (125 kW)	2009.01-	Box Engine 4B12	•		GWB7408	
	2009.01-	Box Engine 4B12		◦	GHA327044	K
C-ELYSEE						
1.2 VTi (53 kW)	2012.11-	Saloon	•		GWB3584	
	2012.11-	Saloon	•		GWB3657	
	2012.11-	Saloon		◦	GWB6726	
1.2 VTi 82 (60 kW)	2014.12-	Saloon	•		GWB3584	
	2014.12-	Saloon	•		GWB3657	
	2014.12-	Saloon		◦	GWB6726	
1.6 BlueHDi 100 (73 kW)	2014.11-	Saloon Engine BHY (DV6FD)	•		GWB3584	
	2014.11-	Saloon Engine BHY (DV6FD)	•		GWB3657	
	2014.11-	Saloon Engine BHY (DV6FD)		◦	GWB6726	
1.6 HDi (68 kW)	2012.11-	Saloon	•		GWB3584	
	2012.11-	Saloon	•		GWB3657	
	2012.11-	Saloon		◦	GWB6726	
1.6 VTi (85 kW)	2012.11-	Saloon Engine NFP(EC5)	•		GWB3584	
	2012.11-	Saloon Engine NFP(EC5)	•		GWB3657	
	2012.11-	Saloon Engine NFP(EC5)		◦	GWB6726	
DISPATCH						
1.6 HDi (66 kW)	2007.01-	Box Engine 9HU(DV6UTED4)	•		GWB6575	
	2007.01-	Box Engine 9HU(DV6UTED4)		◦	GHA400182	K
	2007.01-	MPV Engine 9HU(DV6UTED4)	•		GWB6575	
	2007.01-	MPV Engine 9HU(DV6UTED4)		◦	GHA400182	K
1.6 HDi 8V (66 kW)	2007.01-	Box Engine 9HH(DV6DUM)/9HM(DV6UC)	•		GWB6575	
	2007.01-	Box Engine 9HH(DV6DUM)/9HM(DV6UC)		◦	GHA400182	K
	2007.01-	MPV Engine 9HH(DV6DUM)/9HM(DV6UC)	•		GWB6575	
	2007.01-	MPV Engine 9HH(DV6DUM)/9HM(DV6UC)		◦	GHA400182	K
2.0 HDi (100 kW)	2007.01-	Box Engine RHR(DW10BTED4)	•		GWB6575	
	2007.01-	Box Engine RHR(DW10BTED4)		◦	GHA400182	K
	2007.01-	MPV Engine RHR(DW10BTED4)	•		GWB6575	
	2007.01-	MPV Engine RHR(DW10BTED4)		◦	GHA400182	K



	 YEAR		F	R	G-AP Ref.	KIT
CITROEN						
DISPATCH						
2.0 HDi (120 kW)	2010.07- 2010.07-	Box Engine RHH(DW10CTED4) MPV Engine RHH(DW10CTED4)	• •		GWB6575 GWB6575	
2.0 HDi (72 kW)	2011.07- 2011.07-	Box MPV	• •		GWB6575 GWB6575	
2.0 HDi (88 kW)	2007.01- 2007.01- 2007.01- 2007.01-	Box Engine RHK(DW10UTED4) Box Engine RHK(DW10UTED4) MPV Engine RHK(DW10UTED4) MPV Engine RHK(DW10UTED4)	• • • •		GWB6575 GHA400182 GWB6575 GHA400182	 K K
2.0 HDi (94 kW)	2011.07- 2011.07-	Box MPV	• •		GWB6575 GWB6575	
2.0 i (103 kW)	2007.01- 2007.01- 2007.01- 2007.01-	Box Engine RFH(EW10A) Box Engine RFH(EW10A) MPV Engine RFH(EW10A) MPV Engine RFH(EW10A)	• • • •		GWB6575 GHA400182 GWB6575 GHA400182	 K K
DISPATCH (BU_, BV_, BW_, BX_)						
2.0 (100 kW)	2003.12-2006.10 2003.12-2006.10	Platform/Chassis Engine RFN(EW10J4) Platform/Chassis Engine RFN(EW10J4)	• •		GWB3423 GHA230111	 K
DISPATCH (U6U)						
1.6 (58 kW)	1995.10- 1995.10-	MPV Engine 1580SPI/220A2.000 MPV Engine 1580SPI/220A2.000	• •		GWB3423 GHA230111	 K
1.9 D (51 kW)	1995.10-1998.04 1995.10-1998.04 1998.04- 1998.04-	MPV Engine D9B(XUD9A/U) MPV Engine D9B(XUD9A/U) MPV Engine WJZ(DW8) MPV Engine WJZ(DW8)	• • • •		GWB3423 GHA230111 GWB3423 GHA230111	 K K
1.9 TD (66 kW)	1995.10- 1995.10-	MPV Engine DHX(XUD9TF/BTF) MPV Engine DHX(XUD9TF/BTF)	• •		GWB3423 GHA230111	 K
1.9 TD (68 kW)	1996.04- 1996.04-	MPV Engine D8B(XUD9TF) MPV Engine D8B(XUD9TF)	• •		GWB3423 GHA230111	 K
2.0 (100 kW)	2000.04-2006.12 2000.04-2006.12	MPV Engine RFN(EW10J4) MPV Engine RFN(EW10J4)	• •		GWB3423 GHA230111	 K
2.0 HDi (69 kW)	1999.10- 1999.10-	MPV Engine RHX MPV Engine RHX	• •		GWB3423 GHA230111	 K
2.0 HDi (80 kW)	2000.03- 2000.03- 2000.03- 2000.03-	MPV Engine RHW(DW10ATED4) MPV Engine RHW(DW10ATED4) MPV Engine RHZ(DW10ATED) MPV Engine RHZ(DW10ATED)	• • • •		GWB3423 GHA230111 GWB3423 GHA230111	 K K
2.0 i 16V (102 kW)	2000.03- 2000.03-	MPV MPV	• •		GWB3423 GHA230111	 K
DISPATCH VAN (BS_, BT_, BY_, BZ_)						
1.6 i (58 kW)	1995.10- 1995.10-	Box Engine 1580SPI/220A2.000 Box Engine 1580SPI/220A2.000	• •		GWB3423 GHA230111	 K
1.9 D (51 kW)	1995.10-1998.08 1995.10-1998.08 1998.04- 1998.04-	Box Engine D9B(XUD9A/U) Box Engine D9B(XUD9A/U) Box Engine WJY(DW8B)/WJZ(DW8) Box Engine WJY(DW8B)/WJZ(DW8)	• • • •		GWB3423 GHA230111 GWB3423 GHA230111	 K K
1.9 TD (66 kW)	1995.10- 1995.10-	Box Engine DHX(XUD9TF/BTF) Box Engine DHX(XUD9TF/BTF)	• •		GWB3423 GHA230111	 K
2.0 HDi (69 kW)	1999.10- 1999.10-	Box Engine RHX(DW10BTED) Box Engine RHX(DW10BTED)	• •		GWB3423 GHA230111	 K
2.0 HDi (80 kW)	2002.01- 2002.01- 2002.01- 2002.01-	Box Engine RHW(DW10ATED4) Box Engine RHW(DW10ATED4) Box Engine RHZ(DW10ATED) Box Engine RHZ(DW10ATED)	• • • •		GWB3423 GHA230111 GWB3423 GHA230111	 K K
2.0 i 16V (102 kW)	2000.03- 2000.03-	Box Box	• •		GWB3423 GHA230111	 K
DISPATCH VAN (BU_, BV_, BW_, BX_)						
1.9 TD (68 kW)	1999.10- 1999.10-	Platform/Chassis Engine D8B(XUD9TF) Platform/Chassis Engine D8B(XUD9TF)	• •		GWB3423 GHA230111	 K
2.0 HDi (69 kW)	1999.10- 1999.10-	Platform/Chassis Engine RHX(DW10BTED) Platform/Chassis Engine RHX(DW10BTED)	• •		GWB3423 GHA230111	 K
2.0 HDi (80 kW)	2003.12-2006.10 2003.12-2006.10	Platform/Chassis Engine RHW(DW10ATED4) Platform/Chassis Engine RHW(DW10ATED4)	• •		GWB3423 GHA230111	 K
2.0 HDi 16V (80 kW)	2003.12-2006.10	Platform/Chassis Engine RHZ(DW10ATED)	•		GWB3423	



	 YEAR		F	R	G-AP Ref.	KIT
CITROEN						
DISPATCH VAN (BU_, BV_, BW_, BX_)						
2.0 HDi 16V (80 kW)	2003.12-2006.10	Platform/Chassis Engine RHZ(DW10ATED)		o	GHA230111	K
DS3						
1.2 THP 110 (81 kW)	2014.10-2015.03	Hatchback Engine HNE(EB2DT)	•		GWB3584	
	2014.10-2015.03	Hatchback Engine HNE(EB2DT)	•		GWB3657	
	2014.10-2015.03	Hatchback Engine HNE(EB2DT)		o	GWB6544	
	2014.10-2015.03	Hatchback Engine HNE(EB2DT)		o	GWB6726	
	2014.10-2015.07	Convertible Engine HNZ(EB2DT)	•		GWB3584	
	2014.10-2015.07	Convertible Engine HNZ(EB2DT)	•		GWB3657	
	2014.10-2015.07	Convertible Engine HNZ(EB2DT)		o	GWB6544	
	2014.10-2015.07	Convertible Engine HNZ(EB2DT)		o	GWB6726	
1.2 VTi (60 kW)	2013.01-	Convertible	•		GHA421003	
	2013.01-	Convertible	•		GHA425022	
	2013.01-	Convertible	•		GWB3584	
	2013.01-	Convertible	•		GWB3657	
	2013.01-	Convertible		o	GWB6544	
	2013.01-	Convertible		o	GWB6726	
	2013.01-	Hatchback	•		GHA421003	
	2013.01-	Hatchback	•		GHA425022	
	2013.01-	Hatchback	•		GWB3584	
	2013.01-	Hatchback	•		GWB3657	
	2013.01-	Hatchback		o	GWB6544	
	2013.01-	Hatchback		o	GWB6726	
1.4 HDi 70 (50 kW)	2010.04-2015.07	Hatchback Engine 8HR(DV4C)	•		GHA421003	
	2010.04-2015.07	Hatchback Engine 8HR(DV4C)	•		GHA425022	
	2010.04-2015.07	Hatchback Engine 8HR(DV4C)	•		GWB3584	
	2010.04-2015.07	Hatchback Engine 8HR(DV4C)	•		GWB3657	
	2010.04-2015.07	Hatchback Engine 8HR(DV4C)		o	GWB6544	
	2010.04-2015.07	Hatchback Engine 8HR(DV4C)		o	GWB6726	
1.4 VTi (70 kW)	2010.04-	Hatchback Engine 8FP(EP3)	•		GHA421003	
	2010.04-	Hatchback Engine 8FP(EP3)	•		GHA425022	
	2010.04-	Hatchback Engine 8FP(EP3)	•		GWB3584	
	2010.04-	Hatchback Engine 8FP(EP3)	•		GWB3657	
	2010.04-	Hatchback Engine 8FP(EP3)		o	GWB6544	
	2010.04-	Hatchback Engine 8FP(EP3)		o	GWB6726	
1.4 VTi (72 kW)	2009.11-	Hatchback Engine 8FR(EP3)	•		GHA421003	
	2009.11-	Hatchback Engine 8FR(EP3)	•		GHA425022	
	2009.11-	Hatchback Engine 8FR(EP3)	•		GWB3584	
	2009.11-	Hatchback Engine 8FR(EP3)	•		GWB3657	
	2009.11-	Hatchback Engine 8FR(EP3)		o	GWB6544	
	2009.11-	Hatchback Engine 8FR(EP3)		o	GWB6726	
1.4 VTi LPG (70 kW)	2012.08-	Hatchback Engine 8FN(EP3)	•		GWB3584	
	2012.08-	Hatchback Engine 8FN(EP3)	•		GWB3657	
	2012.08-	Hatchback Engine 8FN(EP3)		o	GWB6544	
	2012.08-	Hatchback Engine 8FN(EP3)		o	GWB6726	
1.6 BlueHDi (73 kW)	2014.07-	Convertible	•		GWB3584	
	2014.07-	Convertible	•		GWB3657	
	2014.07-	Convertible		o	GWB6544	
	2014.07-	Convertible		o	GWB6726	
	2014.07-	Hatchback	•		GWB3584	
	2014.07-	Hatchback	•		GWB3657	
	2014.07-	Hatchback		o	GWB6544	
	2014.07-	Hatchback		o	GWB6726	
1.6 BlueHDi (88 kW)	2014.07-	Convertible	•		GWB3584	
	2014.07-	Convertible	•		GWB3657	
	2014.07-	Convertible		o	GWB6544	
	2014.07-	Convertible		o	GWB6726	
1.6 HDi (68 kW)	2009.11-	Hatchback Engine 9HP(DV6DTED)	•		GHA421003	
	2009.11-	Hatchback Engine 9HP(DV6DTED)	•		GHA425022	
	2009.11-	Hatchback Engine 9HP(DV6DTED)	•		GWB3584	
	2009.11-	Hatchback Engine 9HP(DV6DTED)	•		GWB3657	
	2009.11-	Hatchback Engine 9HP(DV6DTED)		o	GWB6544	
	2009.11-	Hatchback Engine 9HP(DV6DTED)		o	GWB6726	
1.6 HDi (69 kW)	2013.01-	Convertible Engine 9HP(DV6DTED)	•		GHA421003	
	2013.01-	Convertible Engine 9HP(DV6DTED)	•		GHA425022	



	 YEAR		F	R	G-AP Ref.	KIT
CITROEN						
DS3						
1.6 HDi (69 kW)	2013.01-	Convertible Engine 9HP(DV6DTEd)	•		GWB3584	
	2013.01-	Convertible Engine 9HP(DV6DTEd)	•		GWB3657	
	2013.01-	Convertible Engine 9HP(DV6DTEd)		o	GWB6544	
	2013.01-	Convertible Engine 9HP(DV6DTEd)		o	GWB6726	
1.6 HDi (82 kW)	2009.11-	Hatchback Engine 5HR(DV6C)	•		GHA421003	
	2009.11-	Hatchback Engine 5HR(DV6C)	•		GHA425022	
	2009.11-	Hatchback Engine 5HR(DV6C)	•		GWB3584	
	2009.11-	Hatchback Engine 5HR(DV6C)	•		GWB3657	
	2009.11-	Hatchback Engine 5HR(DV6C)		o	GWB6544	
	2009.11-	Hatchback Engine 5HR(DV6C)		o	GWB6726	
1.6 HDi (84 kW)	2012.08-	Hatchback Engine 9HL(DV6C)	•		GHA421003	
	2012.08-	Hatchback Engine 9HL(DV6C)	•		GHA425022	
	2012.08-	Hatchback Engine 9HL(DV6C)	•		GWB3584	
	2012.08-	Hatchback Engine 9HL(DV6C)	•		GWB3657	
	2012.08-	Hatchback Engine 9HL(DV6C)		o	GWB6544	
	2012.08-	Hatchback Engine 9HL(DV6C)		o	GWB6726	
1.6 HDi (85 kW)	2013.10-	Hatchback Engine BHX(DV6FC)	•		GWB3584	
	2013.10-	Hatchback Engine BHX(DV6FC)	•		GWB3657	
	2013.10-	Hatchback Engine BHX(DV6FC)		o	GWB6726	
1.6 HDi (88 kW)	2013.10-	Hatchback Engine BHZ(DV6FC)	•		GWB3584	
	2013.10-	Hatchback Engine BHZ(DV6FC)	•		GWB3657	
	2013.10-	Hatchback Engine BHZ(DV6FC)		o	GWB6544	
	2013.10-	Hatchback Engine BHZ(DV6FC)		o	GWB6726	
1.6 Racing (149 kW)	2011.02-	Hatchback Engine 5FU(EP6CDTX)	•		GHA421003	
	2011.02-	Hatchback Engine 5FU(EP6CDTX)	•		GHA425022	
	2011.02-	Hatchback Engine 5FU(EP6CDTX)	•		GWB3584	
	2011.02-	Hatchback Engine 5FU(EP6CDTX)	•		GWB3657	
	2011.02-	Hatchback Engine 5FU(EP6CDTX)		o	GWB6544	
1.6 Racing (152 kW)	2011.02-	Hatchback Engine 5FD(EP6DTS)	•		GHA425022	
	2011.02-	Hatchback Engine 5FD(EP6DTS)	•		GWB3584	
	2011.02-	Hatchback Engine 5FD(EP6DTS)	•		GWB3657	
	2011.02-	Hatchback Engine 5FD(EP6DTS)		o	GWB6544	
	2014.03-2015.07	Convertible Engine 5FD(EP26DTS)	•		GWB3584	
	2014.03-2015.07	Convertible Engine 5FD(EP26DTS)	•		GWB3657	
	2014.03-2015.07	Convertible Engine 5FD(EP26DTS)		o	GWB6544	
1.6 THP (110 kW)	2010.01-	Hatchback Engine 5FX(EP6DT)	•		GHA421003	
	2010.01-	Hatchback Engine 5FX(EP6DT)	•		GHA425022	
	2010.01-	Hatchback Engine 5FX(EP6DT)	•		GWB3584	
	2010.01-	Hatchback Engine 5FX(EP6DT)	•		GWB3657	
	2010.01-	Hatchback Engine 5FX(EP6DT)		o	GWB6544	
	2010.01-	Hatchback Engine 5FX(EP6DT)		o	GWB6726	
	2013.01-	Convertible Engine 5FN(EP6DT)	•		GHA421003	
	2013.01-	Convertible Engine 5FN(EP6DT)	•		GHA425022	
	2013.01-	Convertible Engine 5FN(EP6DT)	•		GWB3584	
	2013.01-	Convertible Engine 5FN(EP6DT)	•		GWB3657	
	2013.01-	Convertible Engine 5FN(EP6DT)		o	GWB6544	
	2013.01-	Convertible Engine 5FN(EP6DT)		o	GWB6726	
1.6 THP (115 kW)	2010.04-	Hatchback Engine 5FR(EP6DT)	•		GHA421003	
	2010.04-	Hatchback Engine 5FR(EP6DT)	•		GHA425022	
	2010.04-	Hatchback Engine 5FR(EP6DT)	•		GWB3584	
	2010.04-	Hatchback Engine 5FR(EP6DT)	•		GWB3657	
	2010.04-	Hatchback Engine 5FR(EP6DT)		o	GWB6544	
	2010.04-	Hatchback Engine 5FR(EP6DT)		o	GWB6726	
	2013.01-	Convertible Engine 5FR(EP6DT)/5FV(EP6CDT)	•		GHA421003	
	2013.01-	Convertible Engine 5FR(EP6DT)/5FV(EP6CDT)	•		GHA425022	
	2013.01-	Convertible Engine 5FR(EP6DT)/5FV(EP6CDT)	•		GWB3584	
	2013.01-	Convertible Engine 5FR(EP6DT)/5FV(EP6CDT)	•		GWB3657	
	2013.01-	Convertible Engine 5FR(EP6DT)/5FV(EP6CDT)		o	GWB6544	
	2013.01-	Convertible Engine 5FR(EP6DT)/5FV(EP6CDT)		o	GWB6726	
1.6 THP (121 kW)	2014.10-2015.07	Convertible Engine 5GZ(EP6FDT)	•		GWB3584	
	2014.10-2015.07	Convertible Engine 5GZ(EP6FDT)	•		GWB3657	
	2014.10-2015.07	Convertible Engine 5GZ(EP6FDT)		o	GWB6544	
1.6 THP 165 (121 kW)	2014.10-2015.06	Hatchback Engine 5GZ(EP6FDT)	•		GWB3584	
	2014.10-2015.06	Hatchback Engine 5GZ(EP6FDT)	•		GWB3657	



	 YEAR		F	R	G-AP Ref.	KIT
CITROEN						
DS3						
1.6 THP 165 (121 kW)	2014.10-2015.06	Hatchback Engine 5GZ(EP6FDT)		o	GWB6544	
1.6 VTi (88 kW)	2010.04-	Hatchback Engine 5FS(EP6C)	•		GHA421003	
	2010.04-	Hatchback Engine 5FS(EP6C)	•		GHA425022	
	2010.04-	Hatchback Engine 5FS(EP6C)	•		GWB3584	
	2010.04-	Hatchback Engine 5FS(EP6C)	•		GWB3657	
	2010.04-	Hatchback Engine 5FS(EP6C)		o	GWB6544	
	2010.04-	Hatchback Engine 5FS(EP6C)		o	GWB6726	
	2013.01-	Convertible Engine 5FS(EP6C)	•		GHA421003	
	2013.01-	Convertible Engine 5FS(EP6C)	•		GHA425022	
	2013.01-	Convertible Engine 5FS(EP6C)	•		GWB3584	
	2013.01-	Convertible Engine 5FS(EP6C)	•		GWB3657	
	2013.01-	Convertible Engine 5FS(EP6C)		o	GWB6544	
	2013.01-	Convertible Engine 5FS(EP6C)		o	GWB6726	
DS4						
1.2 (96 kW)	2014.07-	Hatchback	•		GWB3584	
	2014.07-	Hatchback	•		GWB3683	
	2014.07-	Hatchback		o	GWB6549	
1.6 (121 kW)	2012.01-	Hatchback Engine 5FM(EP6DT)	•		GHA425022	
	2012.01-	Hatchback Engine 5FM(EP6DT)	•		GWB3584	
	2012.01-	Hatchback Engine 5FM(EP6DT)	•		GWB3683	
	2012.01-	Hatchback Engine 5FM(EP6DT)		o	GWB6549	
1.6 BlueHDi 120 (88 kW)	2014.07-	Hatchback Engine BHZ (DV6FC)	•		GWB3584	
	2014.07-	Hatchback Engine BHZ (DV6FC)	•		GWB3683	
1.6 HDi (68 kW)	2011.05-	Hatchback Engine 9HP(DV6DTED)	•		GHA425022	
	2011.05-	Hatchback Engine 9HP(DV6DTED)	•		GWB3584	
	2011.05-	Hatchback Engine 9HP(DV6DTED)		o	GWB6549	
1.6 HDi (81 kW)	2011.04-	Hatchback	•		GWB3584	
	2011.04-	Hatchback		o	GWB6549	
1.6 HDi (82 kW)	2011.04-	Hatchback Engine 9HR(DV6C)	•		GHA425022	
	2011.04-	Hatchback Engine 9HR(DV6C)	•		GWB3584	
	2011.04-	Hatchback Engine 9HR(DV6C)		o	GWB6549	
1.6 HDi (84 kW)	2012.08-	Hatchback Engine 9HL(DV6C)	•		GHA425022	
	2012.08-	Hatchback Engine 9HL(DV6C)	•		GWB3584	
	2012.08-	Hatchback Engine 9HL(DV6C)		o	GWB6549	
1.6 THP (115 kW)	2011.04-	Hatchback Engine 5FV(EP6CDT)	•		GHA425022	
	2011.04-	Hatchback Engine 5FV(EP6CDT)	•		GWB3584	
	2011.04-	Hatchback Engine 5FV(EP6CDT)	•		GWB3683	
	2011.04-	Hatchback Engine 5FV(EP6CDT)		o	GWB6549	
1.6 THP (120 kW)	2012.04-	Hatchback Engine 5FM(EP6DT)	•		GHA425022	
	2012.04-	Hatchback Engine 5FM(EP6DT)	•		GWB3584	
	2012.04-	Hatchback Engine 5FM(EP6DT)	•		GWB3683	
	2012.04-	Hatchback Engine 5FM(EP6DT)		o	GWB6549	
1.6 THP (147 kW)	2011.04-	Hatchback Engine 5FU(EP6DTX)	•		GWB3683	
1.6 VTi (88 kW)	2011.04-	Hatchback Engine 5FS(EP6C)	•		GHA425022	
	2011.04-	Hatchback Engine 5FS(EP6C)	•		GWB3584	
	2011.04-	Hatchback Engine 5FS(EP6C)	•		GWB3683	
	2011.04-	Hatchback Engine 5FS(EP6C)		o	GWB6549	
2.0 BlueHDi 150 (110 kW)	2014.07-	Hatchback Engine AHX (DW10FD)	•		GWB3584	
	2014.07-	Hatchback Engine AHX (DW10FD)	•		GWB3683	
	2014.07-	Hatchback Engine AHX (DW10FD)		o	GWB6549	
2.0 BlueHDi 180 (133 kW)	2014.07-	Hatchback Engine AHW (DW10FC)	•		GWB3584	
	2014.07-	Hatchback Engine AHW (DW10FC)	•		GWB3683	
	2014.07-	Hatchback Engine AHW (DW10FC)		o	GWB6549	
2.0 HDi (100 kW)	2011.09-	Hatchback Engine RHE (DW10CTED4)	•		GWB3584	
	2011.09-	Hatchback Engine RHE (DW10CTED4)		o	GWB6549	
2.0 HDi (120 kW)	2011.04-	Hatchback Engine RHH(DW10CTED4)	•		GHA425022	
	2011.04-	Hatchback Engine RHH(DW10CTED4)	•		GWB3584	
	2011.04-	Hatchback Engine RHH(DW10CTED4)		o	GWB6549	
DS5						
1.6 BlueHDi 120 (88 kW)	2014.07-	Hatchback Engine BHZ (DV6FC)	•		GWB3584	
	2014.07-	Hatchback Engine BHZ (DV6FC)	•		GWB3683	
	2014.07-	Hatchback Engine BHZ (DV6FC)		o	GWB6549	
1.6 HDi (82 kW)	2011.11-	Hatchback Engine 9HR(DV6C)	•		GHA425022	
	2011.11-	Hatchback Engine 9HR(DV6C)	•		GWB3584	



	 YEAR		F	R	G-AP Ref.	KIT
CITROEN						
DS5						
1.6 HDi (82 kW)	2011.11-	Hatchback Engine 9HR(DV6C)	•		GWB3683	
	2011.11-	Hatchback Engine 9HR(DV6C)		◦	GWB6549	
1.6 HDi (84 kW)	2012.06-	Hatchback	•		GHA425022	
	2012.06-	Hatchback	•		GWB3584	
	2012.06-	Hatchback	•		GWB3683	
	2012.06-	Hatchback		◦	GWB6549	
1.6 HDi (85 kW)	2013.11-	Hatchback Engine BHX (DV6FC)	•		GWB3584	
	2013.11-	Hatchback Engine BHX (DV6FC)	•		GWB3683	
	2013.11-	Hatchback Engine BHX (DV6FC)		◦	GWB6549	
1.6 THP (115 kW)	2011.11-	Hatchback Engine 5FV(EP6CDT)	•		GHA425022	
	2011.11-	Hatchback Engine 5FV(EP6CDT)	•		GWB3584	
	2011.11-	Hatchback Engine 5FV(EP6CDT)	•		GWB3683	
	2011.11-	Hatchback Engine 5FV(EP6CDT)		◦	GWB6549	
1.6 THP (147 kW)	2011.11-	Hatchback Engine 5FU(EP6DTX)	•		GWB3584	
	2011.11-	Hatchback Engine 5FU(EP6DTX)	•		GWB3683	
1.6 THP 165 (121 kW)	2012.01-2015.07	Hatchback Engine 5FM (EP6DT)/5GZ (EP6FDT)	•		GWB3584	
	2012.01-2015.07	Hatchback Engine 5FM (EP6DT)/5GZ (EP6FDT)	•		GWB3683	
	2012.01-2015.07	Hatchback Engine 5FM (EP6DT)/5GZ (EP6FDT)		◦	GWB6549	
1.6 THP 165 Hybrid (121 kW)	2012.06-2015.07	Hatchback Engine 5GZ (EP6FDT)	•		GWB3584	
	2012.06-2015.07	Hatchback Engine 5GZ (EP6FDT)	•		GWB3683	
2.0 BlueHDi 150 (110 kW)	2014.07-	Hatchback	•		GWB3584	
	2014.07-	Hatchback	•		GWB3683	
	2014.07-	Hatchback		◦	GWB6549	
2.0 HDi (100 kW)	2011.11-	Hatchback	•		GHA425022	
	2011.11-	Hatchback	•		GWB3584	
	2011.11-	Hatchback	•		GWB3683	
	2011.11-	Hatchback		◦	GWB6549	
2.0 HDi (120 kW)	2011.11-	Hatchback Engine RHH(DW10CTED4)	•		GHA425022	
	2011.11-	Hatchback Engine RHH(DW10CTED4)	•		GWB3584	
	2011.11-	Hatchback Engine RHH(DW10CTED4)	•		GWB3683	
	2011.11-	Hatchback Engine RHH(DW10CTED4)		◦	GWB6549	
2.0 HDi (133 kW)	2013.08-	Hatchback	•		GWB3584	
	2013.08-	Hatchback	•		GWB3683	
	2013.08-	Hatchback		◦	GWB6549	
2.0 HDi 150 Hybrid (110 kW)	2011.11-2015.07	Hatchback Engine AHX (DW10FD)	•		GWB3584	
	2011.11-2015.07	Hatchback Engine AHX (DW10FD)	•		GWB3683	
2.0 HDi 200 Hybrid4 (147 kW)	2011.12-2015.07	Hatchback	•		GWB3584	
	2011.12-2015.07	Hatchback	•		GWB3683	
2.0 HDi Hybrid4 4x4 (120 kW)	2011.12-	Hatchback Engine RHC(DW10CTED4)	•		GHA425022	
	2011.12-	Hatchback Engine RHC(DW10CTED4)	•		GWB3584	
	2011.12-	Hatchback Engine RHC(DW10CTED4)	•		GWB3683	
EVASION (22, U6)						
1.8 (76 kW)	1996.02-1996.12	MPV	•		GWB3423	
	1996.02-1996.12	MPV		◦	GHA230111	K
JUMPER						
2.0 BlueHDi 110 (81 kW)	2015.07-	Bus	•		GWB6570	
	2015.07-	Bus		◦	GHA242007	K
	2015.07-	Bus		◦	GHA242008	K
2.0 BlueHDi 130 (96 kW)	2015.07-	Bus Engine AHN (DW10FUD)	•		GWB6570	
	2015.07-	Bus Engine AHN (DW10FUD)		◦	GHA242007	K
	2015.07-	Bus Engine AHN (DW10FUD)		◦	GHA242008	K
2.0 BlueHDi 160 (120 kW)	2015.07-	Bus Engine AHP (DW10FUC)	•		GWB6570	
	2015.07-	Bus Engine AHP (DW10FUC)		◦	GHA242007	K
	2015.07-	Bus Engine AHP (DW10FUC)		◦	GHA242008	K
JUMPER (230)						
2.8 HDi (93 kW)	2000.10-2002.01	Platform/Chassis Engine 8140.43S	•		GWB1444	
	2000.10-2002.01	Platform/Chassis Engine 8140.43S	•		GWB3428	
	2000.10-2002.01	Platform/Chassis Engine 8140.43S	•		GWB3640	
	2000.10-2002.01	Platform/Chassis Engine 8140.43S	•		GWB3641	
	2000.10-2002.01	Platform/Chassis Engine 8140.43S		◦	GWB3429	
	2000.10-2002.01	Platform/Chassis Engine 8140.43S		◦	GWB3430	
	2000.10-2002.01	Platform/Chassis Engine 8140.43S		◦	GWB3642	



	 YEAR		F	R	G-AP Ref.	KIT
CITROEN						
JUMPER (244)						
2.2 HDi (74 kW)	2002.02-2006.06	Platform/Chassis Engine 4HY (DW12UTED)	•		GHA428006	
	2002.02-2006.06	Platform/Chassis Engine 4HY (DW12UTED)	•		GHA435002	
	2002.02-2006.06	Platform/Chassis Engine 4HY (DW12UTED)	•		GWB3640	
	2002.02-2006.06	Platform/Chassis Engine 4HY (DW12UTED)	•		GWB3641	
	2002.02-2006.06	Platform/Chassis Engine 4HY (DW12UTED)	•		GWB3690	
	2002.02-2006.06	Platform/Chassis Engine 4HY (DW12UTED)		○	GWB3642	
JUMPY						
2.0 HDi 120 4x4 (88 kW)	2010.01-	Box Engine RHK (DW10UTED4)	•		GWB6575	
	2010.01-	Box Engine RHK (DW10UTED4)		○	GHA400182	K
JUMPY (BS_, BT_, BY_, BZ_)						
1.9 DT (65 kW)	1995.10-2000.08	Box	•		GWB3423	
	1995.10-2000.08	Box		○	GHA230111	K
NEMO						
1.3 HDi (55 kW)	2010.10-	Estate Engine FHZ(F13DTE5)	•		GWB3539	
	2010.10-	Estate Engine FHZ(F13DTE5)	•		GWB6540	
	2010.10-	Estate Engine FHZ(F13DTE5) With ABS		○	GHA230046	K
1.4 (54 kW)	2009.04-	Estate Engine KFV(TU3A)/KFT(TU3A)	•		GWB3538	
	2009.04-	Estate Engine KFV(TU3A)/KFT(TU3A) With ABS		○	GHA230046	K
1.4 HDi (50 kW)	2009.04-	Estate Engine 8HS(DV4TD)	•		GWB3539	
	2009.04-	Estate Engine 8HS(DV4TD)	•		GWB6540	
	2009.04-	Estate Engine 8HS(DV4TD) With ABS		○	GHA230046	K
NEMO (AA_)						
1.3 HDi (55 kW)	2010.10-	Box Engine FHZ(F13DTE5)	•		GWB3539	
	2010.10-	Box Engine FHZ(F13DTE5)	•		GWB6540	
	2010.10-	Box Engine FHZ(F13DTE5) With ABS		○	GHA230046	K
1.4 (54 kW)	2008.02-	Box Engine KFV(TU3A)	•		GWB3538	
	2008.02-	Box Engine KFV(TU3A) With ABS		○	GHA230046	K
1.4 HDi (50 kW)	2008.02-	Box Engine 8HS(DV4TD)	•		GWB3539	
	2008.02-	Box Engine 8HS(DV4TD)	•		GWB6540	
	2008.02-	Box Engine 8HS(DV4TD) With ABS		○	GHA230046	K
RELAY						
2.2 HDi (110 kW)	2011.07-	Bus	•		GWB6570	
	2011.07-	Bus		○	GHA242007	K
	2011.07-	Bus		○	GHA242008	K
	2011.07-	Platform/Chassis	•		GWB6570	
	2011.07-	Platform/Chassis		○	GHA242007	K
	2011.07-	Platform/Chassis		○	GHA242008	K
2.2 HDi (74 kW)	2006.04-	Bus Engine 4HV(P22DTE)	•		GWB6570	
	2006.04-	Bus Engine 4HV(P22DTE)		○	GHA242007	K
	2006.04-	Bus Engine 4HV(P22DTE)		○	GHA242008	K
	2006.04-	Platform/Chassis Engine 4HV(P22DTE)	•		GWB6570	
	2006.04-	Platform/Chassis Engine 4HV(P22DTE)		○	GHA242007	K
	2006.04-	Platform/Chassis Engine 4HV(P22DTE)		○	GHA242008	K
2.2 HDi (81 kW)	2011.07-	Bus	•		GWB6570	
	2011.07-	Bus		○	GHA242007	K
	2011.07-	Bus		○	GHA242008	K
	2011.07-	Platform/Chassis	•		GWB6570	
	2011.07-	Platform/Chassis		○	GHA242007	K
	2011.07-	Platform/Chassis		○	GHA242008	K
2.2 HDi (88 kW)	2006.04-	Bus Engine 4HU(P22DTE)	•		GWB6570	
	2006.04-	Bus Engine 4HU(P22DTE)		○	GHA242007	K
	2006.04-	Bus Engine 4HU(P22DTE)		○	GHA242008	K
	2006.04-	Platform/Chassis Engine 4HU(P22DTE)	•		GWB6570	
	2006.04-	Platform/Chassis Engine 4HU(P22DTE)		○	GHA242007	K
	2006.04-	Platform/Chassis Engine 4HU(P22DTE)		○	GHA242008	K
2.2 HDi (96 kW)	2011.07-	Bus	•		GWB6570	
	2011.07-	Bus		○	GHA242007	K
	2011.07-	Bus		○	GHA242008	K
	2011.07-	Platform/Chassis	•		GWB6570	
	2011.07-	Platform/Chassis		○	GHA242007	K
	2011.07-	Platform/Chassis		○	GHA242008	K
3.0 HDi (107 kW)	2010.07-	Platform/Chassis Engine F1CE3481N	•		GWB6570	
	2010.07-	Platform/Chassis Engine F1CE3481N		○	GHA242007	K



	 YEAR		F	R	G-AP Ref.	KIT
CITROEN						
RELAY						
3.0 HDi (107 kW)	2010.07-	Platform/Chassis Engine F1CE3481N		o	GHA242008	K
3.0 HDi (115 kW)	2010.07-	Bus Engine F1CE0481D(F30DT)	•		GWB6570	
	2010.07-	Bus Engine F1CE0481D(F30DT)		o	GHA242007	K
	2010.07-	Bus Engine F1CE0481D(F30DT)		o	GHA242008	K
3.0 HDi (116 kW)	2006.09-	Bus Engine F1CE0481D(F30DT)	•		GWB6570	
	2006.09-	Bus Engine F1CE0481D(F30DT)		o	GHA242007	K
	2006.09-	Bus Engine F1CE0481D(F30DT)		o	GHA242008	K
	2006.09-	Platform/Chassis Engine F1CE0481D(F30DT)	•		GWB6570	
	2006.09-	Platform/Chassis Engine F1CE0481D(F30DT)		o	GHA242007	K
	2006.09-	Platform/Chassis Engine F1CE0481D(F30DT)		o	GHA242008	K
3.0 HDi (130 kW)	2011.07-	Bus	•		GWB6570	
	2011.07-	Bus		o	GHA242007	K
	2011.07-	Bus		o	GHA242008	K
	2011.07-	Platform/Chassis	•		GWB6570	
	2011.07-	Platform/Chassis		o	GHA242007	K
	2011.07-	Platform/Chassis		o	GHA242008	K
RELAY (230)						
1.9 TD (66 kW)	1994.03-2002.04	Platform/Chassis Engine DHX(XUD9TF/BTF)	•		GHA428004	
	1994.03-2002.04	Platform/Chassis Engine DHX(XUD9TF/BTF)	•		GHA428006	
	1994.03-2002.04	Platform/Chassis Engine DHX(XUD9TF/BTF)	•		GHA435001	
	1994.03-2002.04	Platform/Chassis Engine DHX(XUD9TF/BTF)	•		GHA435002	
	1994.03-2002.04	Platform/Chassis Engine DHX(XUD9TF/BTF)	•		GWB1444	
	1994.03-2002.04	Platform/Chassis Engine DHX(XUD9TF/BTF)	•		GWB3428	
	1994.03-2002.04	Platform/Chassis Engine DHX(XUD9TF/BTF)	•		GWB3640	
	1994.03-2002.04	Platform/Chassis Engine DHX(XUD9TF/BTF)	•		GWB3641	
	1994.03-2002.04	Platform/Chassis Engine DHX(XUD9TF/BTF)		o	GWB3429	
	1994.03-2002.04	Platform/Chassis Engine DHX(XUD9TF/BTF)		o	GWB3430	
	1994.03-2002.04	Platform/Chassis Engine DHX(XUD9TF/BTF)		o	GWB3642	
1.9 TD (68 kW)	1994.03-2002.04	Platform/Chassis Engine D8C(XUD9UTF)	•		GHA428004	
	1994.03-2002.04	Platform/Chassis Engine D8C(XUD9UTF)	•		GHA428006	
	1994.03-2002.04	Platform/Chassis Engine D8C(XUD9UTF)	•		GHA435001	
	1994.03-2002.04	Platform/Chassis Engine D8C(XUD9UTF)	•		GHA435002	
	1994.03-2002.04	Platform/Chassis Engine D8C(XUD9UTF)	•		GWB1444	
	1994.03-2002.04	Platform/Chassis Engine D8C(XUD9UTF)	•		GWB3428	
	1994.03-2002.04	Platform/Chassis Engine D8C(XUD9UTF)	•		GWB3640	
	1994.03-2002.04	Platform/Chassis Engine D8C(XUD9UTF)	•		GWB3641	
	1994.03-2002.04	Platform/Chassis Engine D8C(XUD9UTF)		o	GWB3429	
	1994.03-2002.04	Platform/Chassis Engine D8C(XUD9UTF)		o	GWB3430	
	1994.03-2002.04	Platform/Chassis Engine D8C(XUD9UTF)		o	GWB3642	
2.0 (80 kW)	1994.03-2002.04	Platform/Chassis Engine RFW(XU10J2U)	•		GHA428004	
	1994.03-2002.04	Platform/Chassis Engine RFW(XU10J2U)	•		GHA428006	
	1994.03-2002.04	Platform/Chassis Engine RFW(XU10J2U)	•		GHA435002	
	1994.03-2002.04	Platform/Chassis Engine RFW(XU10J2U)	•		GWB1444	
	1994.03-2002.04	Platform/Chassis Engine RFW(XU10J2U)	•		GWB3428	
	1994.03-2002.04	Platform/Chassis Engine RFW(XU10J2U)	•		GWB3640	
	1994.03-2002.04	Platform/Chassis Engine RFW(XU10J2U)	•		GWB3641	
	1994.03-2002.04	Platform/Chassis Engine RFW(XU10J2U)		o	GWB3429	
	1994.03-2002.04	Platform/Chassis Engine RFW(XU10J2U)		o	GWB3430	
	1994.03-2002.04	Platform/Chassis Engine RFW(XU10J2U)		o	GWB3642	
2.5 D (63 kW)	1994.03-2002.04	Platform/Chassis Engine T9A(DJ5)	•		GHA428004	
	1994.03-2002.04	Platform/Chassis Engine T9A(DJ5)	•		GHA428006	
	1994.03-2002.04	Platform/Chassis Engine T9A(DJ5)	•		GHA435001	
	1994.03-2002.04	Platform/Chassis Engine T9A(DJ5)	•		GHA435002	
	1994.03-2002.04	Platform/Chassis Engine T9A(DJ5)	•		GWB1444	
	1994.03-2002.04	Platform/Chassis Engine T9A(DJ5)	•		GWB3428	
	1994.03-2002.04	Platform/Chassis Engine T9A(DJ5)	•		GWB3640	
	1994.03-2002.04	Platform/Chassis Engine T9A(DJ5)	•		GWB3641	
	1994.03-2002.04	Platform/Chassis Engine T9A(DJ5)		o	GWB3429	
	1994.03-2002.04	Platform/Chassis Engine T9A(DJ5)		o	GWB3430	
	1994.03-2002.04	Platform/Chassis Engine T9A(DJ5)		o	GWB3642	
2.5 D 4x4 (63 kW)	2000.03-2002.04	Platform/Chassis Engine T9A(DJ5)	•		GHA428004	
	2000.03-2002.04	Platform/Chassis Engine T9A(DJ5)	•		GHA428006	
	2000.03-2002.04	Platform/Chassis Engine T9A(DJ5)	•		GHA435001	
	2000.03-2002.04	Platform/Chassis Engine T9A(DJ5)	•		GHA435002	



	 YEAR		F	R	G-AP Ref.	KIT	
CITROEN							
RELAY (230)							
2.5 D 4x4 (63 kW)	2000.03-2002.04	Platform/Chassis Engine T9A(DJ5)	•		GWB1444		
	2000.03-2002.04	Platform/Chassis Engine T9A(DJ5)	•		GWB3428		
	2000.03-2002.04	Platform/Chassis Engine T9A(DJ5)	•		GWB3640		
	2000.03-2002.04	Platform/Chassis Engine T9A(DJ5)	•		GWB3641		
	2000.03-2002.04	Platform/Chassis Engine T9A(DJ5)		◦	GWB3679		
2.5 TD (76 kW)	1994.03-2002.04	Platform/Chassis Engine T8A(DJ5T)	•		GHA428004		
	1994.03-2002.04	Platform/Chassis Engine T8A(DJ5T)	•		GHA428006		
	1994.03-2002.04	Platform/Chassis Engine T8A(DJ5T)	•		GHA435001		
	1994.03-2002.04	Platform/Chassis Engine T8A(DJ5T)	•		GHA435002		
	1994.03-2002.04	Platform/Chassis Engine T8A(DJ5T)	•		GWB1444		
	1994.03-2002.04	Platform/Chassis Engine T8A(DJ5T)	•		GWB3428		
	1994.03-2002.04	Platform/Chassis Engine T8A(DJ5T)	•		GWB3640		
	1994.03-2002.04	Platform/Chassis Engine T8A(DJ5T)	•		GWB3641		
	1994.03-2002.04	Platform/Chassis Engine T8A(DJ5T)		◦	GWB3429		
	1994.03-2002.04	Platform/Chassis Engine T8A(DJ5T)		◦	GWB3430		
2.5 TDi (79 kW)	1996.12-2002.04	Platform/Chassis Engine THX(DJ5TED)	•		GHA428004		
	1996.12-2002.04	Platform/Chassis Engine THX(DJ5TED)	•		GHA428006		
	1996.12-2002.04	Platform/Chassis Engine THX(DJ5TED)	•		GHA435001		
	1996.12-2002.04	Platform/Chassis Engine THX(DJ5TED)	•		GHA435002		
	1996.12-2002.04	Platform/Chassis Engine THX(DJ5TED)	•		GWB1444		
	1996.12-2002.04	Platform/Chassis Engine THX(DJ5TED)	•		GWB3428		
	1996.12-2002.04	Platform/Chassis Engine THX(DJ5TED)	•		GWB3640		
	1996.12-2002.04	Platform/Chassis Engine THX(DJ5TED)	•		GWB3641		
	1996.12-2002.04	Platform/Chassis Engine THX(DJ5TED)		◦	GWB3429		
	1996.12-2002.04	Platform/Chassis Engine THX(DJ5TED)		◦	GWB3430		
2.5 TDi 4x4 (79 kW)	2000.03-2002.04	Platform/Chassis Engine THX(DJ5TED)	•		GHA428004		
	2000.03-2002.04	Platform/Chassis Engine THX(DJ5TED)	•		GHA428006		
	2000.03-2002.04	Platform/Chassis Engine THX(DJ5TED)	•		GHA435001		
	2000.03-2002.04	Platform/Chassis Engine THX(DJ5TED)	•		GHA435002		
	2000.03-2002.04	Platform/Chassis Engine THX(DJ5TED)	•		GWB1444		
	2000.03-2002.04	Platform/Chassis Engine THX(DJ5TED)	•		GWB3428		
	2000.03-2002.04	Platform/Chassis Engine THX(DJ5TED)	•		GWB3640		
	2000.03-2002.04	Platform/Chassis Engine THX(DJ5TED)	•		GWB3641		
	2000.03-2002.04	Platform/Chassis Engine THX(DJ5TED)		◦	GWB3679		
	2.8 D (64 kW)	1999.01-2002.02	Platform/Chassis Engine 8140.63(F28D)	•		GHA428004	
1999.01-2002.02		Platform/Chassis Engine 8140.63(F28D)	•		GHA428006		
1999.01-2002.02		Platform/Chassis Engine 8140.63(F28D)	•		GHA435002		
1999.01-2002.02		Platform/Chassis Engine 8140.63(F28D)	•		GWB1444		
1999.01-2002.02		Platform/Chassis Engine 8140.63(F28D)	•		GWB3428		
1999.01-2002.02		Platform/Chassis Engine 8140.63(F28D)	•		GWB3640		
1999.01-2002.02		Platform/Chassis Engine 8140.63(F28D)	•		GWB3641		
1999.01-2002.02		Platform/Chassis Engine 8140.63(F28D)		◦	GWB3429		
1999.01-2002.02		Platform/Chassis Engine 8140.63(F28D)		◦	GWB3430		
1999.01-2002.02		Platform/Chassis Engine 8140.63(F28D)		◦	GWB3642		
2.8 HDi (94 kW)	2000.09-2002.04	Platform/Chassis Engine 8140.43S	•		GHA428004		
	2000.09-2002.04	Platform/Chassis Engine 8140.43S	•		GHA428006		
	2000.09-2002.04	Platform/Chassis Engine 8140.43S	•		GHA435001		
	2000.09-2002.04	Platform/Chassis Engine 8140.43S	•		GHA435002		
	2000.09-2002.04	Platform/Chassis Engine 8140.43S	•		GWB1444		
	2000.09-2002.04	Platform/Chassis Engine 8140.43S	•		GWB3428		
	2000.09-2002.04	Platform/Chassis Engine 8140.43S	•		GWB3640		
	2000.09-2002.04	Platform/Chassis Engine 8140.43S	•		GWB3641		
	2000.09-2002.04	Platform/Chassis Engine 8140.43S		◦	GWB3429		
	2000.09-2002.04	Platform/Chassis Engine 8140.43S		◦	GWB3430		
RELAY (230L)							
	1.9 D (50 kW)	1999.07-2002.04	Box Engine DJY(XUD9A)	•		GHA435001	
		1999.07-2002.04	Box Engine DJY(XUD9A)	•		GWB1444	
		1999.07-2002.04	Box Engine DJY(XUD9A)	•		GWB3428	
		1999.07-2002.04	Box Engine DJY(XUD9A)	•		GWB3640	
		1999.07-2002.04	Box Engine DJY(XUD9A)	•		GWB3641	
1999.07-2002.04		Box Engine DJY(XUD9A)		◦	GWB3429		



	 YEAR		F	R	G-AP Ref.	KIT
CITROEN RELAY (230L)						
1.9 D (50 kW)	1999.07-2002.04	Box Engine DJY(XUD9A)		o	GWB3430	
	1999.07-2002.04	Box Engine DJY(XUD9A)		o	GWB3642	
1.9 D (51 kW)	1994.02-2002.04	Box Engine D9B(XUD9A/U)	•		GHA428004	
	1994.02-2002.04	Box Engine D9B(XUD9A/U)	•		GHA428006	
	1994.02-2002.04	Box Engine D9B(XUD9A/U)	•		GHA435001	
	1994.02-2002.04	Box Engine D9B(XUD9A/U)	•		GHA435002	
	1994.02-2002.04	Box Engine D9B(XUD9A/U)	•		GWB1444	
	1994.02-2002.04	Box Engine D9B(XUD9A/U)	•		GWB3428	
	1994.02-2002.04	Box Engine D9B(XUD9A/U)	•		GWB3640	
	1994.02-2002.04	Box Engine D9B(XUD9A/U)	•		GWB3641	
	1994.02-2002.04	Box Engine D9B(XUD9A/U)		o	GWB3429	
	1994.02-2002.04	Box Engine D9B(XUD9A/U)		o	GWB3430	
1.9 TD (66 kW)	1994.03-2002.04	Box Engine DHX(XUD9TF/BTF)	•		GHA428004	
	1994.03-2002.04	Box Engine DHX(XUD9TF/BTF)	•		GHA428006	
	1994.03-2002.04	Box Engine DHX(XUD9TF/BTF)	•		GHA435001	
	1994.03-2002.04	Box Engine DHX(XUD9TF/BTF)	•		GHA435002	
	1994.03-2002.04	Box Engine DHX(XUD9TF/BTF)	•		GWB1444	
	1994.03-2002.04	Box Engine DHX(XUD9TF/BTF)	•		GWB3428	
	1994.03-2002.04	Box Engine DHX(XUD9TF/BTF)	•		GWB3640	
	1994.03-2002.04	Box Engine DHX(XUD9TF/BTF)		o	GWB3641	
	1994.03-2002.04	Box Engine DHX(XUD9TF/BTF)		o	GWB3429	
	1994.03-2002.04	Box Engine DHX(XUD9TF/BTF)		o	GWB3430	
1.9 TD (68 kW)	1994.03-2002.04	Box Engine D8C(XUD9UTF)	•		GHA428004	
	1994.03-2002.04	Box Engine D8C(XUD9UTF)	•		GHA428006	
	1994.03-2002.04	Box Engine D8C(XUD9UTF)	•		GHA435001	
	1994.03-2002.04	Box Engine D8C(XUD9UTF)	•		GHA435002	
	1994.03-2002.04	Box Engine D8C(XUD9UTF)	•		GWB1444	
	1994.03-2002.04	Box Engine D8C(XUD9UTF)	•		GWB3428	
	1994.03-2002.04	Box Engine D8C(XUD9UTF)	•		GWB3640	
	1994.03-2002.04	Box Engine D8C(XUD9UTF)		o	GWB3641	
	1994.03-2002.04	Box Engine D8C(XUD9UTF)		o	GWB3429	
	1994.03-2002.04	Box Engine D8C(XUD9UTF)		o	GWB3430	
2.0 (80 kW)	1994.03-2002.04	Box Engine RFW(XU10J2U)	•		GHA428004	
	1994.03-2002.04	Box Engine RFW(XU10J2U)	•		GHA428006	
	1994.03-2002.04	Box Engine RFW(XU10J2U)	•		GHA435002	
	1994.03-2002.04	Box Engine RFW(XU10J2U)	•		GWB1444	
	1994.03-2002.04	Box Engine RFW(XU10J2U)	•		GWB3428	
	1994.03-2002.04	Box Engine RFW(XU10J2U)	•		GWB3640	
	1994.03-2002.04	Box Engine RFW(XU10J2U)	•		GWB3641	
	1994.03-2002.04	Box Engine RFW(XU10J2U)		o	GWB3429	
	1994.03-2002.04	Box Engine RFW(XU10J2U)		o	GWB3430	
	1994.03-2002.04	Box Engine RFW(XU10J2U)		o	GWB3642	
2.0 HDi (62 kW)	2001.11-2002.04	Box Engine RHV(DW10UTD)	•		GHA428004	
	2001.11-2002.04	Box Engine RHV(DW10UTD)	•		GHA428006	
	2001.11-2002.04	Box Engine RHV(DW10UTD)	•		GHA435001	
	2001.11-2002.04	Box Engine RHV(DW10UTD)	•		GHA435002	
	2001.11-2002.04	Box Engine RHV(DW10UTD)	•		GWB1444	
	2001.11-2002.04	Box Engine RHV(DW10UTD)	•		GWB3428	
	2001.11-2002.04	Box Engine RHV(DW10UTD)	•		GWB3640	
	2001.11-2002.04	Box Engine RHV(DW10UTD)	•		GWB3641	
	2001.11-2002.04	Box Engine RHV(DW10UTD)		o	GWB3429	
	2001.11-2002.04	Box Engine RHV(DW10UTD)		o	GWB3430	
2.5 D (63 kW)	1994.03-2002.04	Box Engine T9A(DJ5)	•		GHA428004	
	1994.03-2002.04	Box Engine T9A(DJ5)	•		GHA428006	
	1994.03-2002.04	Box Engine T9A(DJ5)	•		GHA435001	
	1994.03-2002.04	Box Engine T9A(DJ5)	•		GHA435002	
	1994.03-2002.04	Box Engine T9A(DJ5)	•		GWB1444	
	1994.03-2002.04	Box Engine T9A(DJ5)	•		GWB3428	
	1994.03-2002.04	Box Engine T9A(DJ5)	•		GWB3640	
	1994.03-2002.04	Box Engine T9A(DJ5)	•		GWB3641	



	 YEAR		F	R	G-AP Ref.	KIT
CITROEN RELAY (230L)						
2.5 D (63 kW)	1994.03-2002.04	Box Engine T9A(DJ5)		o	GWB3429	
	1994.03-2002.04	Box Engine T9A(DJ5)		o	GWB3430	
	1994.03-2002.04	Box Engine T9A(DJ5)		o	GWB3642	
2.5 D 4x4 (63 kW)	2000.03-2002.04	Box Engine T9A(DJ5)	•		GHA428004	
	2000.03-2002.04	Box Engine T9A(DJ5)	•		GHA428006	
	2000.03-2002.04	Box Engine T9A(DJ5)	•		GHA435001	
	2000.03-2002.04	Box Engine T9A(DJ5)	•		GHA435002	
	2000.03-2002.04	Box Engine T9A(DJ5)	•		GWB1444	
	2000.03-2002.04	Box Engine T9A(DJ5)	•		GWB3428	
	2000.03-2002.04	Box Engine T9A(DJ5)	•		GWB3640	
	2000.03-2002.04	Box Engine T9A(DJ5)	•		GWB3641	
	2000.03-2002.04	Box Engine T9A(DJ5)		o	GWB3679	
2.5 DT 4x4 (76 kW)	1996.10-1997.08	Box	•		GHA428004	
	1996.10-1997.08	Box	•		GHA428006	
	1996.10-1997.08	Box	•		GHA435002	
2.5 TD (76 kW)	1994.03-2002.04	Box Engine T8A(DJ5T)	•		GHA428004	
	1994.03-2002.04	Box Engine T8A(DJ5T)	•		GHA428006	
	1994.03-2002.04	Box Engine T8A(DJ5T)	•		GHA435001	
	1994.03-2002.04	Box Engine T8A(DJ5T)	•		GHA435002	
	1994.03-2002.04	Box Engine T8A(DJ5T)	•		GWB1444	
	1994.03-2002.04	Box Engine T8A(DJ5T)	•		GWB3428	
	1994.03-2002.04	Box Engine T8A(DJ5T)	•		GWB3640	
	1994.03-2002.04	Box Engine T8A(DJ5T)	•		GWB3641	
	1994.03-2002.04	Box Engine T8A(DJ5T)		o	GWB3429	
	1994.03-2002.04	Box Engine T8A(DJ5T)		o	GWB3430	
	1994.03-2002.04	Box Engine T8A(DJ5T)		o	GWB3642	
	2.5 TDi (79 kW)	1996.12-2000.11	Box Engine THX(DJ5TED)	•		GHA428004
1996.12-2000.11		Box Engine THX(DJ5TED)	•		GHA428006	
1996.12-2000.11		Box Engine THX(DJ5TED)	•		GHA435001	
1996.12-2000.11		Box Engine THX(DJ5TED)	•		GHA435002	
1996.12-2000.11		Box Engine THX(DJ5TED)	•		GWB1444	
1996.12-2000.11		Box Engine THX(DJ5TED)	•		GWB3428	
1996.12-2000.11		Box Engine THX(DJ5TED)	•		GWB3640	
1996.12-2000.11		Box Engine THX(DJ5TED)	•		GWB3641	
1996.12-2000.11		Box Engine THX(DJ5TED)		o	GWB3429	
1996.12-2000.11		Box Engine THX(DJ5TED)		o	GWB3430	
1996.12-2000.11		Box Engine THX(DJ5TED)		o	GWB3642	
2.5 TDi 4x4 (79 kW)		2000.03-2000.11	Box Engine THX(DJ5TED)	•		GHA428004
	2000.03-2000.11	Box Engine THX(DJ5TED)	•		GHA428006	
	2000.03-2000.11	Box Engine THX(DJ5TED)	•		GHA435001	
	2000.03-2000.11	Box Engine THX(DJ5TED)	•		GHA435002	
	2000.03-2000.11	Box Engine THX(DJ5TED)	•		GWB1444	
	2000.03-2000.11	Box Engine THX(DJ5TED)	•		GWB3428	
	2000.03-2000.11	Box Engine THX(DJ5TED)	•		GWB3640	
	2000.03-2000.11	Box Engine THX(DJ5TED)	•		GWB3641	
	2000.03-2000.11	Box Engine THX(DJ5TED)		o	GWB3679	
	2.8 D (64 kW)	1999.01-2002.02	Box Engine 8140.63(F28D)	•		GHA428004
1999.01-2002.02		Box Engine 8140.63(F28D)	•		GHA428006	
1999.01-2002.02		Box Engine 8140.63(F28D)	•		GHA435002	
1999.01-2002.02		Box Engine 8140.63(F28D)	•		GWB1444	
1999.01-2002.02		Box Engine 8140.63(F28D)	•		GWB3428	
1999.01-2002.02		Box Engine 8140.63(F28D)	•		GWB3640	
1999.01-2002.02		Box Engine 8140.63(F28D)	•		GWB3641	
1999.01-2002.02		Box Engine 8140.63(F28D)		o	GWB3429	
1999.01-2002.02		Box Engine 8140.63(F28D)		o	GWB3430	
1999.01-2002.02		Box Engine 8140.63(F28D)		o	GWB3642	
2.8 HDi (94 kW)		2000.09-2002.04	Box Engine 8140.43S	•		GHA428004
	2000.09-2002.04	Box Engine 8140.43S	•		GHA428006	
	2000.09-2002.04	Box Engine 8140.43S	•		GHA435001	
	2000.09-2002.04	Box Engine 8140.43S	•		GHA435002	
	2000.09-2002.04	Box Engine 8140.43S	•		GWB1444	
	2000.09-2002.04	Box Engine 8140.43S	•		GWB3428	
	2000.09-2002.04	Box Engine 8140.43S	•		GWB3640	
	2000.09-2002.04	Box Engine 8140.43S	•		GWB3641	



	 YEAR		F	R	G-AP Ref.	KIT
CITROEN						
RELAY (230L)						
2.8 HDi (94 kW)	2000.09-2002.04	Box Engine 8140.43S		o	GWB3429	
	2000.09-2002.04	Box Engine 8140.43S		o	GWB3430	
	2000.09-2002.04	Box Engine 8140.43S		o	GWB3642	
2.8 HDi 4x4 (94 kW)	2000.09-2002.04	Box Engine 8140.43S	•		GHA428004	
	2000.09-2002.04	Box Engine 8140.43S	•		GHA428006	
	2000.09-2002.04	Box Engine 8140.43S	•		GHA435001	
	2000.09-2002.04	Box Engine 8140.43S	•		GHA435002	
	2000.09-2002.04	Box Engine 8140.43S	•		GWB1444	
	2000.09-2002.04	Box Engine 8140.43S	•		GWB3428	
	2000.09-2002.04	Box Engine 8140.43S	•		GWB3640	
	2000.09-2002.04	Box Engine 8140.43S	•		GWB3641	
	2000.09-2002.04	Box Engine 8140.43S		o	GWB3679	
RELAY (230P)						
1.9 D (51 kW)	1999.01-2002.04	Bus Engine D9B(XUD9A/U)	•		GHA428004	
	1999.01-2002.04	Bus Engine D9B(XUD9A/U)	•		GHA428006	
	1999.01-2002.04	Bus Engine D9B(XUD9A/U)	•		GHA435001	
	1999.01-2002.04	Bus Engine D9B(XUD9A/U)	•		GHA435002	
	1999.01-2002.04	Bus Engine D9B(XUD9A/U)	•		GWB1444	
	1999.01-2002.04	Bus Engine D9B(XUD9A/U)	•		GWB3428	
	1999.01-2002.04	Bus Engine D9B(XUD9A/U)	•		GWB3640	
	1999.01-2002.04	Bus Engine D9B(XUD9A/U)	•		GWB3641	
	1999.01-2002.04	Bus Engine D9B(XUD9A/U)		o	GWB3429	
	1999.01-2002.04	Bus Engine D9B(XUD9A/U)		o	GWB3430	
1.9 TD (66 kW)	1994.08-2002.04	Bus Engine D8C(XUD9UTF)	•		GHA428004	
	1994.08-2002.04	Bus Engine D8C(XUD9UTF)	•		GHA428006	
	1994.08-2002.04	Bus Engine D8C(XUD9UTF)	•		GHA435001	
	1994.08-2002.04	Bus Engine D8C(XUD9UTF)	•		GHA435002	
	1994.08-2002.04	Bus Engine D8C(XUD9UTF)	•		GWB1444	
	1994.08-2002.04	Bus Engine D8C(XUD9UTF)	•		GWB3428	
	1994.08-2002.04	Bus Engine D8C(XUD9UTF)	•		GWB3640	
	1994.08-2002.04	Bus Engine D8C(XUD9UTF)	•		GWB3641	
	1994.08-2002.04	Bus Engine D8C(XUD9UTF)		o	GWB3429	
	1994.08-2002.04	Bus Engine D8C(XUD9UTF)		o	GWB3430	
1.9 TD (68 kW)	1994.02-2002.04	Bus Engine D8C(XUD9UTF)	•		GHA428004	
	1994.02-2002.04	Bus Engine D8C(XUD9UTF)	•		GHA428006	
	1994.02-2002.04	Bus Engine D8C(XUD9UTF)	•		GHA435001	
	1994.02-2002.04	Bus Engine D8C(XUD9UTF)	•		GHA435002	
	1994.02-2002.04	Bus Engine D8C(XUD9UTF)	•		GWB1444	
	1994.02-2002.04	Bus Engine D8C(XUD9UTF)	•		GWB3428	
	1994.02-2002.04	Bus Engine D8C(XUD9UTF)	•		GWB3640	
	1994.02-2002.04	Bus Engine D8C(XUD9UTF)	•		GWB3641	
	1994.02-2002.04	Bus Engine D8C(XUD9UTF)		o	GWB3429	
	1994.02-2002.04	Bus Engine D8C(XUD9UTF)		o	GWB3430	
1.9 TD 4x4 (68 kW)	1996.08-2002.04	Bus Engine D8C(XUD9UTF)	•		GHA435001	
	1996.08-2002.04	Bus Engine D8C(XUD9UTF)	•		GWB1444	
	1996.08-2002.04	Bus Engine D8C(XUD9UTF)	•		GWB3428	
	1996.08-2002.04	Bus Engine D8C(XUD9UTF)	•		GWB3640	
	1996.08-2002.04	Bus Engine D8C(XUD9UTF)	•		GWB3641	
	1996.08-2002.04	Bus Engine D8C(XUD9UTF)		o	GWB3679	
2.0 (80 kW)	1994.02-2002.04	Bus Engine RFW(XU10J2U)	•		GHA428004	
	1994.02-2002.04	Bus Engine RFW(XU10J2U)	•		GHA428006	
	1994.02-2002.04	Bus Engine RFW(XU10J2U)	•		GHA435002	
	1994.02-2002.04	Bus Engine RFW(XU10J2U)	•		GWB1444	
	1994.02-2002.04	Bus Engine RFW(XU10J2U)	•		GWB3428	
	1994.02-2002.04	Bus Engine RFW(XU10J2U)	•		GWB3640	
	1994.02-2002.04	Bus Engine RFW(XU10J2U)	•		GWB3641	
	1994.02-2002.04	Bus Engine RFW(XU10J2U)		o	GWB3429	
	1994.02-2002.04	Bus Engine RFW(XU10J2U)		o	GWB3430	
	1994.02-2002.04	Bus Engine RFW(XU10J2U)		o	GWB3642	
2.0 4x4 (80 kW)	1996.08-2002.04	Bus Engine RFW(XU10J2U)	•		GWB1444	
	1996.08-2002.04	Bus Engine RFW(XU10J2U)	•		GWB3428	



	 YEAR		F	R	G-AP Ref.	KIT
CITROEN RELAY (230P)						
2.0 4x4 (80 kW)	1996.08-2002.04	Bus Engine RFW(XU10J2U)	•		GWB3640	
	1996.08-2002.04	Bus Engine RFW(XU10J2U)	•		GWB3641	
	1996.08-2002.04	Bus Engine RFW(XU10J2U)		o	GWB3679	
2.5 D (63 kW)	1994.08-2002.04	Bus Engine T9A(DJ5)	•		GHA428004	
	1994.08-2002.04	Bus Engine T9A(DJ5)	•		GHA428006	
	1994.08-2002.04	Bus Engine T9A(DJ5)	•		GHA435001	
	1994.08-2002.04	Bus Engine T9A(DJ5)	•		GHA435002	
	1994.08-2002.04	Bus Engine T9A(DJ5)	•		GWB1444	
	1994.08-2002.04	Bus Engine T9A(DJ5)	•		GWB3428	
	1994.08-2002.04	Bus Engine T9A(DJ5)	•		GWB3640	
	1994.08-2002.04	Bus Engine T9A(DJ5)	•		GWB3641	
	1994.08-2002.04	Bus Engine T9A(DJ5)		o	GWB3429	
	1994.08-2002.04	Bus Engine T9A(DJ5)		o	GWB3430	
	1994.08-2002.04	Bus Engine T9A(DJ5)		o	GWB3642	
2.5 D 4x4 (63 kW)	1996.08-2002.04	Bus Engine T9A(DJ5)	•		GHA428004	
	1996.08-2002.04	Bus Engine T9A(DJ5)	•		GHA428006	
	1996.08-2002.04	Bus Engine T9A(DJ5)	•		GHA435001	
	1996.08-2002.04	Bus Engine T9A(DJ5)	•		GHA435002	
	1996.08-2002.04	Bus Engine T9A(DJ5)	•		GWB1444	
	1996.08-2002.04	Bus Engine T9A(DJ5)	•		GWB3428	
	1996.08-2002.04	Bus Engine T9A(DJ5)	•		GWB3640	
	1996.08-2002.04	Bus Engine T9A(DJ5)	•		GWB3641	
	1996.08-2002.04	Bus Engine T9A(DJ5)		o	GWB3679	
2.5 TD (76 kW)	1994.08-2002.04	Bus Engine T8A(DJ5T)	•		GHA428004	
	1994.08-2002.04	Bus Engine T8A(DJ5T)	•		GHA428006	
	1994.08-2002.04	Bus Engine T8A(DJ5T)	•		GHA435001	
	1994.08-2002.04	Bus Engine T8A(DJ5T)	•		GHA435002	
	1994.08-2002.04	Bus Engine T8A(DJ5T)	•		GWB1444	
	1994.08-2002.04	Bus Engine T8A(DJ5T)	•		GWB3428	
	1994.08-2002.04	Bus Engine T8A(DJ5T)	•		GWB3640	
	1994.08-2002.04	Bus Engine T8A(DJ5T)	•		GWB3641	
	1994.08-2002.04	Bus Engine T8A(DJ5T)		o	GWB3429	
	1994.08-2002.04	Bus Engine T8A(DJ5T)		o	GWB3430	
1994.08-2002.04	Bus Engine T8A(DJ5T)		o	GWB3642		
2.5 TD 4x4 (76 kW)	1996.08-2002.04	Bus Engine T8A(DJ5T)	•		GHA428004	
	1996.08-2002.04	Bus Engine T8A(DJ5T)	•		GHA428006	
	1996.08-2002.04	Bus Engine T8A(DJ5T)	•		GHA435001	
	1996.08-2002.04	Bus Engine T8A(DJ5T)	•		GHA435002	
	1996.08-2002.04	Bus Engine T8A(DJ5T)	•		GWB1444	
	1996.08-2002.04	Bus Engine T8A(DJ5T)	•		GWB3428	
	1996.08-2002.04	Bus Engine T8A(DJ5T)	•		GWB3640	
	1996.08-2002.04	Bus Engine T8A(DJ5T)	•		GWB3641	
2.5 TDi (79 kW)	1996.12-2000.11	Bus Engine THX(DJ5TED)	•		GHA428004	
	1996.12-2000.11	Bus Engine THX(DJ5TED)	•		GHA428006	
	1996.12-2000.11	Bus Engine THX(DJ5TED)	•		GHA435001	
	1996.12-2000.11	Bus Engine THX(DJ5TED)	•		GHA435002	
	1996.12-2000.11	Bus Engine THX(DJ5TED)	•		GWB1444	
	1996.12-2000.11	Bus Engine THX(DJ5TED)	•		GWB3428	
	1996.12-2000.11	Bus Engine THX(DJ5TED)	•		GWB3640	
	1996.12-2000.11	Bus Engine THX(DJ5TED)	•		GWB3641	
	1996.12-2000.11	Bus Engine THX(DJ5TED)		o	GWB3429	
	1996.12-2000.11	Bus Engine THX(DJ5TED)		o	GWB3430	
	1996.12-2000.11	Bus Engine THX(DJ5TED)		o	GWB3642	
2.5 TDi 4x4 (79 kW)	1996.12-2000.11	Bus Engine THX(DJ5TED)	•		GHA428004	
	1996.12-2000.11	Bus Engine THX(DJ5TED)	•		GHA428006	
	1996.12-2000.11	Bus Engine THX(DJ5TED)	•		GHA435001	
	1996.12-2000.11	Bus Engine THX(DJ5TED)	•		GHA435002	
	1996.12-2000.11	Bus Engine THX(DJ5TED)	•		GWB1444	
	1996.12-2000.11	Bus Engine THX(DJ5TED)	•		GWB3428	
	1996.12-2000.11	Bus Engine THX(DJ5TED)	•		GWB3640	
	1996.12-2000.11	Bus Engine THX(DJ5TED)	•		GWB3641	
	1996.12-2000.11	Bus Engine THX(DJ5TED)		o	GWB3679	
2.8 D (64 kW)	1999.01-2002.02	Bus Engine 8140.63(F28D)	•		GHA428004	



	 YEAR		F	R	G-AP Ref.	KIT
CITROEN RELAY (230P)						
2.8 D (64 kW)	1999.01-2002.02	Bus Engine 8140.63(F28D)	•		GHA428006	
	1999.01-2002.02	Bus Engine 8140.63(F28D)	•		GHA435002	
	1999.01-2002.02	Bus Engine 8140.63(F28D)	•		GWB1444	
	1999.01-2002.02	Bus Engine 8140.63(F28D)	•		GWB3428	
	1999.01-2002.02	Bus Engine 8140.63(F28D)	•		GWB3640	
	1999.01-2002.02	Bus Engine 8140.63(F28D)	•		GWB3641	
	1999.01-2002.02	Bus Engine 8140.63(F28D)		○	GWB3429	
	1999.01-2002.02	Bus Engine 8140.63(F28D)		○	GWB3430	
	1999.01-2002.02	Bus Engine 8140.63(F28D)		○	GWB3642	
2.8 HDi (94 kW)	2000.09-2002.04	Bus Engine 8140.43S	•		GHA428004	
	2000.09-2002.04	Bus Engine 8140.43S	•		GHA428006	
	2000.09-2002.04	Bus Engine 8140.43S	•		GHA435001	
	2000.09-2002.04	Bus Engine 8140.43S	•		GHA435002	
	2000.09-2002.04	Bus Engine 8140.43S	•		GWB1444	
	2000.09-2002.04	Bus Engine 8140.43S	•		GWB3428	
	2000.09-2002.04	Bus Engine 8140.43S	•		GWB3640	
	2000.09-2002.04	Bus Engine 8140.43S	•		GWB3641	
	2000.09-2002.04	Bus Engine 8140.43S		○	GWB3429	
	2000.09-2002.04	Bus Engine 8140.43S		○	GWB3430	
	2000.09-2002.04	Bus Engine 8140.43S		○	GWB3642	
2.8 HDi 4x4 (94 kW)	2000.09-2002.04	Bus Engine 8140.43S	•		GHA428004	
	2000.09-2002.04	Bus Engine 8140.43S	•		GHA428006	
	2000.09-2002.04	Bus Engine 8140.43S	•		GHA435001	
	2000.09-2002.04	Bus Engine 8140.43S	•		GHA435002	
	2000.09-2002.04	Bus Engine 8140.43S	•		GWB1444	
	2000.09-2002.04	Bus Engine 8140.43S	•		GWB3428	
	2000.09-2002.04	Bus Engine 8140.43S	•		GWB3640	
	2000.09-2002.04	Bus Engine 8140.43S	•		GWB3641	
	2000.09-2002.04	Bus Engine 8140.43S		○	GWB3679	
RELAY (244)						
2.0 (81 kW)	2002.04-	Box Engine XU10J2	•		GHA428006	
	2002.04-	Box Engine XU10J2	•		GHA435002	
	2002.04-	Box Engine XU10J2	•		GWB3640	
	2002.04-	Box Engine XU10J2	•		GWB3641	
	2002.04-	Box Engine XU10J2	•		GWB3690	
	2002.04-	Box Engine XU10J2		○	GWB3642	
2.0 Bivalent (81 kW)	2003.02-	Box Engine XU10J2	•		GHA428006	
	2003.02-	Box Engine XU10J2	•		GHA435002	
	2003.02-	Box Engine XU10J2	•		GWB3640	
	2003.02-	Box Engine XU10J2	•		GWB3641	
	2003.02-	Box Engine XU10J2	•		GWB3690	
	2003.02-	Box Engine XU10J2		○	GWB3642	
2.0 HDi (62 kW)	2002.04-	Box Engine RHV(DW10TD)/RHV(DW10UTD)	•		GHA428006	
	2002.04-	Box Engine RHV(DW10TD)/RHV(DW10UTD)	•		GHA435002	
	2002.04-	Box Engine RHV(DW10TD)/RHV(DW10UTD)	•		GWB3640	
	2002.04-	Box Engine RHV(DW10TD)/RHV(DW10UTD)	•		GWB3641	
	2002.04-	Box Engine RHV(DW10TD)/RHV(DW10UTD)	•		GWB3690	
	2002.04-	Box Engine RHV(DW10TD)/RHV(DW10UTD)		○	GWB3642	
	2002.04-	Platform/Chassis Engine RHV(DW10UTD)	•		GHA428006	
	2002.04-	Platform/Chassis Engine RHV(DW10UTD)	•		GHA435002	
	2002.04-	Platform/Chassis Engine RHV(DW10UTD)	•		GWB3640	
	2002.04-	Platform/Chassis Engine RHV(DW10UTD)	•		GWB3641	
	2002.04-	Platform/Chassis Engine RHV(DW10UTD)	•		GWB3690	
	2002.04-	Platform/Chassis Engine RHV(DW10UTD)		○	GWB3642	
2.2 HDi (74 kW)	2002.04-	Box Engine 4HY(DW12UTED)	•		GHA428006	
	2002.04-	Box Engine 4HY(DW12UTED)	•		GHA435002	
	2002.04-	Box Engine 4HY(DW12UTED)	•		GWB3640	
	2002.04-	Box Engine 4HY(DW12UTED)	•		GWB3641	
	2002.04-	Box Engine 4HY(DW12UTED)	•		GWB3690	
	2002.04-	Box Engine 4HY(DW12UTED)		○	GWB3642	
	2002.04-	Platform/Chassis Engine DW12TED	•		GHA428006	
	2002.04-	Platform/Chassis Engine DW12TED	•		GHA435002	
2002.04-	Platform/Chassis Engine DW12TED	•		GWB3640		
2002.04-	Platform/Chassis Engine DW12TED	•		GWB3641		



	 YEAR		F	R	G-AP Ref.	KIT
CITROEN RELAY (244)						
2.2 HDi (74 kW)	2002.04-	Platform/Chassis Engine DW12TED	•		GWB3690	
	2002.04-	Platform/Chassis Engine DW12TED		○	GWB3642	
2.8 HDi (107 kW)	2004.05-	Box Engine 8140.43N	•		GHA428006	
	2004.05-	Box Engine 8140.43N	•		GHA435002	
	2004.05-	Box Engine 8140.43N	•		GWB3640	
	2004.05-	Box Engine 8140.43N	•		GWB3641	
	2004.05-	Box Engine 8140.43N	•		GWB3690	
	2004.05-	Box Engine 8140.43N		○	GWB3642	
	2004.05-	Platform/Chassis Engine 8140.43N	•		GHA428006	
	2004.05-	Platform/Chassis Engine 8140.43N	•		GHA435002	
	2004.05-	Platform/Chassis Engine 8140.43N	•		GWB3640	
	2004.05-	Platform/Chassis Engine 8140.43N	•		GWB3641	
	2004.05-	Platform/Chassis Engine 8140.43N	•		GWB3690	
	2004.05-	Platform/Chassis Engine 8140.43N		○	GWB3642	
2.8 HDi (94 kW)	2002.04-	Box Engine 8140.43S	•		GHA428006	
	2002.04-	Box Engine 8140.43S	•		GHA435002	
	2002.04-	Box Engine 8140.43S	•		GWB3640	
	2002.04-	Box Engine 8140.43S	•		GWB3641	
	2002.04-	Box Engine 8140.43S	•		GWB3690	
	2002.04-	Box Engine 8140.43S		○	GWB3642	
	2002.04-	Platform/Chassis Engine 8140.43S	•		GWB3640	
	2002.04-	Platform/Chassis Engine 8140.43S	•		GWB3641	
	2002.04-	Platform/Chassis Engine 8140.43S	•		GWB3690	
	2002.04-	Platform/Chassis Engine 8140.43S		○	GWB3642	
2.8 HDi 4x4 (94 kW)	2002.02-2006.06	Platform/Chassis Engine F28TDCR	•		GHA428006	
	2002.02-2006.06	Platform/Chassis Engine F28TDCR	•		GHA435002	
	2002.02-2006.06	Platform/Chassis Engine F28TDCR	•		GWB3640	
	2002.02-2006.06	Platform/Chassis Engine F28TDCR	•		GWB3641	
	2002.02-2006.06	Platform/Chassis Engine F28TDCR	•		GWB3690	
	2002.02-2006.06	Platform/Chassis Engine F28TDCR		○	GWB3679	
	2002.04-	Box Engine 8140.43S	•		GHA428006	
	2002.04-	Box Engine 8140.43S	•		GHA435002	
	2002.04-	Box Engine 8140.43S	•		GWB3640	
	2002.04-	Box Engine 8140.43S	•		GWB3641	
	2002.04-	Box Engine 8140.43S	•		GWB3690	
	2002.04-	Box Engine 8140.43S		○	GWB3679	
RELAY (244, Z_)						
2.0 (81 kW)	2002.04-	Bus Engine XU10J2	•		GHA428006	
	2002.04-	Bus Engine XU10J2	•		GHA435002	
	2002.04-	Bus Engine XU10J2	•		GWB3640	
	2002.04-	Bus Engine XU10J2	•		GWB3641	
	2002.04-	Bus Engine XU10J2	•		GWB3690	
	2002.04-	Bus Engine XU10J2		○	GWB3642	
2.0 Bivalent (81 kW)	2003.02-	Bus Engine XU10J2	•		GHA428006	
	2003.02-	Bus Engine XU10J2	•		GHA435002	
	2003.02-	Bus Engine XU10J2	•		GWB3640	
	2003.02-	Bus Engine XU10J2	•		GWB3641	
	2003.02-	Bus Engine XU10J2	•		GWB3690	
	2003.02-	Bus Engine XU10J2		○	GWB3642	
2.0 HDi (62 kW)	2002.04-	Bus Engine RHV(DW10UTD)	•		GWB3640	
	2002.04-	Bus Engine RHV(DW10UTD)	•		GWB3641	
	2002.04-	Bus Engine RHV(DW10UTD)	•		GWB3690	
	2002.04-	Bus Engine RHV(DW10UTD)		○	GWB3642	
2.2 HDi (74 kW)	2002.04-	Bus Engine 4HY(DW12UTED)	•		GHA428006	
	2002.04-	Bus Engine 4HY(DW12UTED)	•		GHA435002	
	2002.04-	Bus Engine 4HY(DW12UTED)	•		GWB3640	
	2002.04-	Bus Engine 4HY(DW12UTED)	•		GWB3641	
	2002.04-	Bus Engine 4HY(DW12UTED)	•		GWB3690	
	2002.04-	Bus Engine 4HY(DW12UTED)		○	GWB3642	
2.8 HDi (94 kW)	2002.04-	Bus Engine 8140.43S	•		GHA428006	
	2002.04-	Bus Engine 8140.43S	•		GHA428006	
	2002.04-	Bus Engine 8140.43S	•		GHA435002	
	2002.04-	Bus Engine 8140.43S	•		GHA435002	
	2002.04-	Bus Engine 8140.43S	•		GWB3640	



	 YEAR		F	R	G-AP Ref.	KIT
CITROEN						
RELAY (244, Z_)						
2.8 HDi (94 kW)	2002.04-	Bus Engine 8140.43S	•		GWB3640	
	2002.04-	Bus Engine 8140.43S	•		GWB3641	
	2002.04-	Bus Engine 8140.43S	•		GWB3641	
	2002.04-	Bus Engine 8140.43S	•		GWB3690	
	2002.04-	Bus Engine 8140.43S	•		GWB3690	
	2002.04-	Bus Engine 8140.43S		o	GWB3642	
	2002.04-	Bus Engine 8140.43S		o	GWB3679	
RELAY VNA						
2.2 HDi (110 kW)	2011.07-	Box	•		GWB6570	
	2011.07-	Box		o	GHA242007	K
	2011.07-	Box		o	GHA242008	K
2.2 HDi (74 kW)	2006.04-	Box Engine 4HV(P22DTE)	•		GWB6570	
	2006.04-	Box Engine 4HV(P22DTE)		o	GHA242007	K
	2006.04-	Box Engine 4HV(P22DTE)		o	GHA242008	K
2.2 HDi (81 kW)	2011.07-	Box	•		GWB6570	
	2011.07-	Box		o	GHA242007	K
	2011.07-	Box		o	GHA242008	K
2.2 HDi (88 kW)	2006.04-	Box Engine 4HU(P22DTE)	•		GWB6570	
	2006.04-	Box Engine 4HU(P22DTE)		o	GHA242007	K
	2006.04-	Box Engine 4HU(P22DTE)		o	GHA242008	K
2.2 HDi (96 kW)	2011.07-	Box	•		GWB6570	
	2011.07-	Box		o	GHA242007	K
	2011.07-	Box		o	GHA242008	K
3.0 HDi (107 kW)	2010.07-	Box Engine F1CE3481N	•		GWB6570	
	2010.07-	Box Engine F1CE3481N		o	GHA242007	K
	2010.07-	Box Engine F1CE3481N		o	GHA242008	K
3.0 HDi (115 kW)	2010.07-	Box Engine F1CE0481D(F30DT)	•		GWB6570	
	2010.07-	Box Engine F1CE0481D(F30DT)		o	GHA242007	K
	2010.07-	Box Engine F1CE0481D(F30DT)		o	GHA242008	K
3.0 HDi (116 kW)	2006.09-	Box Engine F1CE0481D(F30DT)	•		GWB6570	
	2006.09-	Box Engine F1CE0481D(F30DT)		o	GHA242007	K
	2006.09-	Box Engine F1CE0481D(F30DT)		o	GHA242008	K
3.0 HDi (130 kW)	2011.07-	Box	•		GWB6570	
	2011.07-	Box		o	GHA242007	K
	2011.07-	Box		o	GHA242008	K
SAXO (S0, S1)						
1.0 X (33 kW)	1996.05-1998.11	Hatchback Engine CDZ(TU9M)	•		GHA421003	
	1996.05-1998.11	Hatchback Engine CDZ(TU9M)	•		GWB0882	
	1996.05-1998.11	Hatchback Engine CDZ(TU9M)	•		GWB1327	
	1996.05-1998.11	Hatchback Engine CDZ(TU9M)		o	GWB0961	
1.0 X (37 kW)	1998.05-2003.06	Hatchback Engine CDZ(TU9M)	•		GHA421003	
	1998.05-2003.06	Hatchback Engine CDZ(TU9M)	•		GWB0882	
	1998.05-2003.06	Hatchback Engine CDZ(TU9M)	•		GWB1327	
	1998.05-2003.06	Hatchback Engine CDZ(TU9M)	•		GWB3554A	
	1998.05-2003.06	Hatchback Engine CDZ(TU9M)		o	GWB0961	
	1998.05-2003.06	Hatchback Engine CDZ(TU9M)		o	GWB3556	
1.1 X,SX (40 kW)	1996.05-2003.09	Hatchback Engine HDZ(TU1M)	•		GWB0882	
	1996.05-2003.09	Hatchback Engine HDZ(TU1M)	•		GWB1327	
	1996.05-2003.09	Hatchback Engine HDZ(TU1M)	•		GWB3554A	
	1996.05-2003.09	Hatchback Engine HDZ(TU1M)		o	GWB0961	
	1996.05-2003.09	Hatchback Engine HDZ(TU1M)		o	GWB3556	
1.1 X,SX (44 kW)	1996.05-2003.09	Hatchback Engine HDZ(TU1M)/HFX(TU1JP)	•		GHA421003	
	1996.05-2003.09	Hatchback Engine HDZ(TU1M)/HFX(TU1JP)	•		GWB0882	
	1996.05-2003.09	Hatchback Engine HDZ(TU1M)/HFX(TU1JP)	•		GWB1327	
	1996.05-2003.09	Hatchback Engine HDZ(TU1M)/HFX(TU1JP)	•		GWB3554A	
	1996.05-2003.09	Hatchback Engine HDZ(TU1M)/HFX(TU1JP)		o	GWB0961	
	1996.05-2003.09	Hatchback Engine HDZ(TU1M)/HFX(TU1JP)		o	GWB3556	
1.4 VTS (55 kW)	1996.05-2003.06	Hatchback Engine KFW(TU3JP)/KFX(TU3JP)	•		GHA421003	
	1996.05-2003.06	Hatchback Engine KFW(TU3JP)/KFX(TU3JP)	•		GWB0882	
	1996.05-2003.06	Hatchback Engine KFW(TU3JP)/KFX(TU3JP)	•		GWB1327	
	1996.05-2003.06	Hatchback Engine KFW(TU3JP)/KFX(TU3JP)	•		GWB3554A	
	1996.05-2003.06	Hatchback Engine KFW(TU3JP)/KFX(TU3JP)		o	GWB0961	
	1996.05-2003.06	Hatchback Engine KFW(TU3JP)/KFX(TU3JP)		o	GWB3556	
1.5 D (40 kW)	1996.09-2003.09	Hatchback Engine VJY(TUD5)	•		GHA421003	



			F	R	G-AP Ref.	KIT
CITROEN SAXO (S0, S1)						
1.5 D (40 kW)	1996.09-2003.09	Hatchback Engine VJY(TUD5)	•		GWB0882	
	1996.09-2003.09	Hatchback Engine VJY(TUD5)	•		GWB1327	
	1996.09-2003.09	Hatchback Engine VJY(TUD5)	•		GWB3554A	
	1996.09-2003.09	Hatchback Engine VJY(TUD5)		○	GWB0961	
	1996.09-2003.09	Hatchback Engine VJY(TUD5)		○	GWB3556	
1.5 D (42 kW)	1996.09-2001.06	Hatchback Engine VJZ(TUD5)	•		GHA421003	
	1996.09-2001.06	Hatchback Engine VJZ(TUD5)	•		GWB0882	
	1996.09-2001.06	Hatchback Engine VJZ(TUD5)	•		GWB1327	
	1996.09-2001.06	Hatchback Engine VJZ(TUD5)	•		GWB3554A	
	1996.09-2001.06	Hatchback Engine VJZ(TUD5)		○	GWB0961	
	1996.09-2001.06	Hatchback Engine VJZ(TUD5)		○	GWB3556	
1.5 D (43 kW)	2001.07-2004.04	Hatchback	•		GHA421003	
	2001.07-2004.04	Hatchback	•		GWB3554A	
	2001.07-2004.04	Hatchback		○	GWB3556	
1.6 (66 kW)	1996.02-2003.06	Hatchback Engine NFZ(TU5JP)	•		GHA421003	
	1996.02-2003.06	Hatchback Engine NFZ(TU5JP)	•		GWB0882	
	1996.02-2003.06	Hatchback Engine NFZ(TU5JP)	•		GWB1327	
	1996.02-2003.06	Hatchback Engine NFZ(TU5JP)	•		GWB3554A	
	1996.02-2003.06	Hatchback Engine NFZ(TU5JP)		○	GHA225031	K
	1996.02-2003.06	Hatchback Engine NFZ(TU5JP)		○	GWB0961	
	1996.02-2003.06	Hatchback Engine NFZ(TU5JP)		○	GWB3556	
1.6 (74 kW)	2001.02-2004.04	Hatchback Engine NFT	•		GHA421003	
	2001.02-2004.04	Hatchback Engine NFT	•		GWB3554A	
	2001.02-2004.04	Hatchback Engine NFT		○	GHA225031	K
	2001.02-2004.04	Hatchback Engine NFT		○	GWB3556	
1.6 (88 kW)	1996.02-2004.04	Hatchback Engine NFX(TU5JP4)	•		GWB0882	
	1996.02-2004.04	Hatchback Engine NFX(TU5JP4)	•		GWB1327	
	1996.02-2004.04	Hatchback Engine NFX(TU5JP4)	•		GWB3554A	
	1996.02-2004.04	Hatchback Engine NFX(TU5JP4)		○	GHA225031	K
	1996.02-2004.04	Hatchback Engine NFX(TU5JP4)		○	GWB0961	
	1996.02-2004.04	Hatchback Engine NFX(TU5JP4)		○	GWB3556	
1.6 VTL,VTR (65 kW)	1996.05-2003.06	Hatchback Engine NFZ(TU5JP)	•		GHA421003	
	1996.05-2003.06	Hatchback Engine NFZ(TU5JP)	•		GWB0882	
	1996.05-2003.06	Hatchback Engine NFZ(TU5JP)	•		GWB1327	
	1996.05-2003.06	Hatchback Engine NFZ(TU5JP)	•		GWB3554A	
	1996.05-2003.06	Hatchback Engine NFZ(TU5JP)		○	GHA225031	K
	1996.05-2003.06	Hatchback Engine NFZ(TU5JP)		○	GWB0961	
	1996.05-2003.06	Hatchback Engine NFZ(TU5JP)		○	GWB3556	
1.6 VTS (72 kW)	2000.09-2003.09	Hatchback Engine NFT	•		GHA421003	
	2000.09-2003.09	Hatchback Engine NFT	•		GWB3554A	
	2000.09-2003.09	Hatchback Engine NFT		○	GHA225031	K
	2000.09-2003.09	Hatchback Engine NFT		○	GWB3556	
1.6 VTS (87 kW)	1996.06-2003.09	Hatchback Engine NFX(TU5JP4)	•		GWB0882	
	1996.06-2003.09	Hatchback Engine NFX(TU5JP4)	•		GWB1327	
	1996.06-2003.09	Hatchback Engine NFX(TU5JP4)	•		GWB3554A	
	1996.06-2003.09	Hatchback Engine NFX(TU5JP4)		○	GHA225031	K
	1996.06-2003.09	Hatchback Engine NFX(TU5JP4)		○	GWB0961	
	1996.06-2003.09	Hatchback Engine NFX(TU5JP4)		○	GWB3556	
Electric (20 kW)	1996.11-2003.06	Hatchback	•		GWB0882	
	1996.11-2003.06	Hatchback	•		GWB1327	
	1996.11-2003.06	Hatchback	•		GWB3554A	
	1996.11-2003.06	Hatchback		○	GWB0961	
SYNERGIE (22, U6)						
1.8 (73 kW)	1997.05-2002.07	MPV Engine LFZ(XU7JP)	•		GWB3423	
	1997.05-2002.07	MPV Engine LFZ(XU7JP)		○	GHA230111	K
1.9 TD (66 kW)	1994.11-2002.07	MPV Engine D8B(XUD9TF)/DHX(XUD9TF/BTF)	•		GWB3423	
	1994.11-2002.07	MPV Engine D8B(XUD9TF)/DHX(XUD9TF/BTF)		○	GHA230111	K
1.9 TD (68 kW)	1995.10-1998.12	MPV Engine D8B(XUD9TF)	•		GWB3423	
	1995.10-1998.12	MPV Engine D8B(XUD9TF)		○	GHA230111	K
2.0 (89 kW)	1994.06-2002.07	MPV Engine RFU(XU10J2/C)	•		GWB3423	
	1994.06-2002.07	MPV Engine RFU(XU10J2/C)		○	GHA230111	K
2.0 16V (100 kW)	2000.05-2002.07	MPV Engine RFN(EW10J4)	•		GWB3423	
	2000.05-2002.07	MPV Engine RFN(EW10J4)		○	GHA230111	K
2.0 16V (97 kW)	1998.05-2000.04	MPV Engine RFV(XU10J4R)	•		GWB3423	



	 YEAR		F	R	G-AP Ref.	KIT
CITROEN						
SYNERGIE (22, U6)						
2.0 16V (97 kW)	1998.05-2000.04	MPV Engine RFV(XU10J4R)		o	GHA230111	K
2.0 HDi (80 kW)	1999.08-2002.07	MPV Engine RHZ(DW10ATED)	•		GWB3423	
	1999.08-2002.07	MPV Engine RHZ(DW10ATED)		o	GHA230111	K
2.0 HDi 16V (80 kW)	1999.09-2002.07	MPV Engine RHW(DW10ATED4)	•		GWB3423	
	1999.09-2002.07	MPV Engine RHW(DW10ATED4)		o	GHA230111	K
2.0 Turbo C.T. (108 kW)	1994.06-2002.07	MPV Engine RGX(XU10J2TE)	•		GWB3423	
	1994.06-2002.07	MPV Engine RGX(XU10J2TE)		o	GHA230111	K
2.1 TD (80 kW)	1996.05-2002.07	MPV Engine P8C(XUD11BTE)	•		GWB3423	
	1996.05-2002.07	MPV Engine P8C(XUD11BTE)		o	GHA230111	K
XANTIA (X1)						
1.6 i (65 kW)	1993.03-1998.01	Hatchback Engine BFZ(XU5JP)	•		GHA425022	
	1993.03-1998.01	Hatchback Engine BFZ(XU5JP)	•		GWB0915	
	1993.03-1998.01	Hatchback Engine BFZ(XU5JP) With ABS		o	GHA232007	F
	1993.03-1998.01	Hatchback Engine BFZ(XU5JP) With ABS		o	GHA232022	K
	1993.03-1998.01	Hatchback Engine BFZ(XU5JP) Without ABS		o	GHA232004	K
	1993.03-1998.01	Hatchback Engine BFZ(XU5JP) Without ABS		o	GHA232011	K
1.8 i (66 kW)	1997.04-1998.01	Estate Engine LFX(XU7JB)	•		GHA425022	
	1997.04-1998.01	Estate Engine LFX(XU7JB)	•		GWB0915	
	1997.04-1998.01	Estate Engine LFX(XU7JB) With ABS		o	GHA232007	F
	1997.04-1998.01	Estate Engine LFX(XU7JB) Without ABS		o	GHA232011	K
	1997.04-1998.01	Hatchback Engine LFX(XU7JB)	•		GHA425022	
	1997.04-1998.01	Hatchback Engine LFX(XU7JB)	•		GWB0915	
	1997.04-1998.01	Hatchback Engine LFX(XU7JB) With ABS		o	GHA232007	F
	1997.04-1998.01	Hatchback Engine LFX(XU7JB) Without ABS		o	GHA232011	K
1.8 i (74 kW)	1993.03-1998.01	Hatchback Engine LFZ(XU7JP)	•		GHA425022	
	1993.03-1998.01	Hatchback Engine LFZ(XU7JP)	•		GWB0915	
	1993.03-1998.01	Hatchback Engine LFZ(XU7JP) With ABS		o	GHA232007	F
	1993.03-1998.01	Hatchback Engine LFZ(XU7JP) With ABS		o	GHA232022	K
	1993.03-1998.01	Hatchback Engine LFZ(XU7JP) Without ABS		o	GHA232004	K
	1993.03-1998.01	Hatchback Engine LFZ(XU7JP) Without ABS		o	GHA232011	K
	1995.06-1998.01	Estate Engine LFZ(XU7JP)	•		GHA425022	
	1995.06-1998.01	Estate Engine LFZ(XU7JP)	•		GWB0915	
	1995.06-1998.01	Estate Engine LFZ(XU7JP) With ABS		o	GHA232007	F
	1995.06-1998.01	Estate Engine LFZ(XU7JP) Without ABS		o	GHA232011	K
1.8 i 16V (81 kW)	1995.06-1998.01	Estate Engine LFY(XU7JP4)	•		GHA425022	
	1995.06-1998.01	Estate Engine LFY(XU7JP4)	•		GWB0915	
	1995.06-1998.01	Estate Engine LFY(XU7JP4) With ABS		o	GHA232007	F
	1995.06-1998.01	Estate Engine LFY(XU7JP4) Without ABS		o	GHA232011	K
	1995.06-1998.01	Hatchback Engine LFY(XU7JP4)	•		GHA425022	
	1995.06-1998.01	Hatchback Engine LFY(XU7JP4)	•		GWB0915	
	1995.06-1998.01	Hatchback Engine LFY(XU7JP4) With ABS		o	GHA232007	F
	1995.06-1998.01	Hatchback Engine LFY(XU7JP4) Without ABS		o	GHA232011	K
1.9 D (50 kW)	1994.06-1998.01	Hatchback Engine DJZ(XUD9Y)	•		GWB0915	
	1994.06-1998.01	Hatchback Engine DJZ(XUD9Y) With ABS		o	GHA232007	F
	1994.06-1998.01	Hatchback Engine DJZ(XUD9Y) With ABS		o	GHA232022	K
	1994.06-1998.01	Hatchback Engine DJZ(XUD9Y) Without ABS		o	GHA232004	K
	1994.06-1998.01	Hatchback Engine DJZ(XUD9Y) Without ABS		o	GHA232011	K
1.9 D (51 kW)	1994.06-1998.01	Hatchback Engine D9B(XUD9A/L)	•		GWB0915	
	1994.06-1998.01	Hatchback Engine D9B(XUD9A/L) With ABS		o	GHA232007	F
	1994.06-1998.01	Hatchback Engine D9B(XUD9A/L) With ABS		o	GHA232022	K
	1994.06-1998.01	Hatchback Engine D9B(XUD9A/L) Without ABS		o	GHA232004	K
	1994.06-1998.01	Hatchback Engine D9B(XUD9A/L) Without ABS		o	GHA232011	K
1.9 SD (55 kW)	1996.02-1998.01	Hatchback Engine DHW(XUD9SD)	•		GHA425022	
	1996.02-1998.01	Hatchback Engine DHW(XUD9SD)	•		GWB0915	
	1996.02-1998.01	Hatchback Engine DHW(XUD9SD) With ABS		o	GHA232007	F
	1996.02-1998.01	Hatchback Engine DHW(XUD9SD) Without ABS		o	GHA232011	K
	1997.04-1998.01	Estate Engine DHW(XUD9SD)	•		GHA425022	
	1997.04-1998.01	Estate Engine DHW(XUD9SD)	•		GWB0915	
	1997.04-1998.01	Estate Engine DHW(XUD9SD) With ABS		o	GHA232007	F
1997.04-1998.01	Estate Engine DHW(XUD9SD) Without ABS		o	GHA232011	K	
1.9 Turbo D (66 kW)	1994.10-1998.01	Hatchback Engine DHX(XUD9TF/BTF)/DHY(XUD9TE/Y)	•		GHA425022	
	1994.10-1998.01	Hatchback Engine DHX(XUD9TF/BTF)/DHY(XUD9TE/Y)	•		GWB0915	
	1994.10-1998.01	Hatchback Engine DHX(XUD9TF/BTF)/DHY(XUD9TE/Y) With ABS		o	GHA232007	F
	1994.10-1998.01	Hatchback Engine DHX(XUD9TF/BTF)/DHY(XUD9TE/Y) With ABS		o	GHA232022	K



	 YEAR		F	R	G-AP Ref.	KIT
CITROEN						
XANTIA (X1)						
1.9 Turbo D (66 kW)	1994.10-1998.01	Hatchback Engine DHX(XUD9TF/BTF)/DHY(XUD9TE/Y) Without ABS		o	GHA232004	K
	1994.10-1998.01	Hatchback Engine DHX(XUD9TF/BTF)/DHY(XUD9TE/Y) Without ABS		o	GHA232011	K
	1995.06-1998.01	Estate Engine D8B(XUD9TF)/DHX(XUD9TF/BTF)/DHY(XUD9TE/Y)	•		GWB0915	
	1995.06-1998.01	Estate Engine D8B(XUD9TF)/DHX(XUD9TF/BTF)/DHY(XUD9TE/Y) With ABS		o	GHA232007	F
	1995.06-1998.01	Estate Engine D8B(XUD9TF)/DHX(XUD9TF/BTF)/DHY(XUD9TE/Y) Without ABS		o	GHA232011	K
2.0 (95 kW)	1993.03-1995.05	Hatchback	•		GHA425022	
	1993.03-1995.05	Hatchback	•		GWB0915	
	1993.03-1995.05	Hatchback With ABS		o	GHA232022	K
	1993.03-1995.05	Hatchback Without ABS		o	GHA232004	K
2.0 i (89 kW)	1993.03-1998.01	Hatchback Engine RFX(XU10J2C)	•		GWB0915	
	1993.03-1998.01	Hatchback Engine RFX(XU10J2C) With ABS		o	GHA232007	F
	1993.03-1998.01	Hatchback Engine RFX(XU10J2C) With ABS		o	GHA232022	K
	1993.03-1998.01	Hatchback Engine RFX(XU10J2C) Without ABS		o	GHA232004	K
	1993.03-1998.01	Hatchback Engine RFX(XU10J2C) Without ABS		o	GHA232011	K
	1995.06-1998.01	Estate Engine RFX(XU10J2C)	•		GWB0915	
	1995.06-1998.01	Estate Engine RFX(XU10J2C) With ABS		o	GHA232007	F
	1995.06-1998.01	Estate Engine RFX(XU10J2C) Without ABS		o	GHA232011	K
2.0 i 16V (110 kW)	1994.06-1998.01	Hatchback Engine RFT(XU10J4/Z)	•		GWB0915	
	1994.06-1998.01	Hatchback Engine RFT(XU10J4/Z) With ABS		o	GHA232007	F
	1994.06-1998.01	Hatchback Engine RFT(XU10J4/Z) With ABS		o	GHA232022	K
	1994.06-1998.01	Hatchback Engine RFT(XU10J4/Z) Without ABS		o	GHA232004	K
	1994.06-1998.01	Hatchback Engine RFT(XU10J4/Z) Without ABS		o	GHA232011	K
2.0 i 16V (112 kW)	1993.03-1998.01	Hatchback Engine RFY(XU10J4/Z)	•		GHA425022	
	1993.03-1998.01	Hatchback Engine RFY(XU10J4/Z)	•		GWB0915	
	1993.03-1998.01	Hatchback Engine RFY(XU10J4/Z) With ABS		o	GHA232007	F
	1993.03-1998.01	Hatchback Engine RFY(XU10J4/Z) With ABS		o	GHA232022	K
	1993.03-1998.01	Hatchback Engine RFY(XU10J4/Z) Without ABS		o	GHA232004	K
	1993.03-1998.01	Hatchback Engine RFY(XU10J4/Z) Without ABS		o	GHA232011	K
2.0 i 16V (97 kW)	1995.06-1998.01	Estate Engine RFV(XU10J4R)	•		GHA425022	
	1995.06-1998.01	Estate Engine RFV(XU10J4R)	•		GWB0915	
	1995.06-1998.01	Estate Engine RFV(XU10J4R) With ABS		o	GHA232007	F
	1995.06-1998.01	Estate Engine RFV(XU10J4R) Without ABS		o	GHA232011	K
	1995.06-1998.01	Hatchback Engine RFV(XU10J4R)	•		GHA425022	
	1995.06-1998.01	Hatchback Engine RFV(XU10J4R)	•		GWB0915	
	1995.06-1998.01	Hatchback Engine RFV(XU10J4R) With ABS		o	GHA232007	F
	1995.06-1998.01	Hatchback Engine RFV(XU10J4R) Without ABS		o	GHA232011	K
2.0 Turbo (108 kW)	1995.06-1998.01	Estate Engine RGX(XU10J2TE)	•		GWB0915	
	1995.06-1998.01	Estate Engine RGX(XU10J2TE) With ABS		o	GHA232007	F
	1995.06-1998.01	Estate Engine RGX(XU10J2TE) Without ABS		o	GHA232011	K
	1995.06-1998.01	Hatchback Engine RGX(XU10J2TE)	•		GWB0915	
	1995.06-1998.01	Hatchback Engine RGX(XU10J2TE) With ABS		o	GHA232007	F
	1995.06-1998.01	Hatchback Engine RGX(XU10J2TE) Without ABS		o	GHA232011	K
2.1 Turbo D 12V (80 kW)	1995.06-1998.01	Hatchback Engine P8C(XUD11BTE)	•		GWB0915	
	1995.06-1998.01	Hatchback Engine P8C(XUD11BTE) With ABS		o	GHA232007	F
	1995.06-1998.01	Hatchback Engine P8C(XUD11BTE) Without ABS		o	GHA232011	K
	1996.06-1998.01	Estate Engine P8C(XUD11BTE)	•		GWB0915	
	1996.06-1998.01	Estate Engine P8C(XUD11BTE) With ABS		o	GHA232007	F
	1996.06-1998.01	Estate Engine P8C(XUD11BTE) Without ABS		o	GHA232011	K
3.0 i 24V (140 kW)	1997.01-1998.01	Hatchback Engine XFZ(ES9J4)	•		GWB0915	
	1997.01-1998.01	Hatchback Engine XFZ(ES9J4) With ABS		o	GHA232007	F
	1997.01-1998.01	Hatchback Engine XFZ(ES9J4) Without ABS		o	GHA232011	K
XANTIA (X2)						
1.6 i SX (65 kW)	1998.01-2001.03	Hatchback Engine BFZ(XU5JP)	•		GHA425022	
	1998.01-2001.03	Hatchback Engine BFZ(XU5JP)	•		GWB0915	
	1998.01-2001.03	Hatchback Engine BFZ(XU5JP)		o	GHA232035	K
	1998.01-2001.03	Hatchback Engine BFZ(XU5JP) With ABS		o	GHA232007	F
	1998.01-2001.03	Hatchback Engine BFZ(XU5JP) With ABS		o	GHA232032	K
	1998.01-2001.03	Hatchback Engine BFZ(XU5JP) Without ABS		o	GHA232011	K
1.8 i (66 kW)	1998.01-2003.04	Estate Engine LFX(XU7JB)	•		GHA425022	
	1998.01-2003.04	Estate Engine LFX(XU7JB)	•		GWB0915	
	1998.01-2003.04	Estate Engine LFX(XU7JB)		o	GHA232035	K
	1998.01-2003.04	Estate Engine LFX(XU7JB) With ABS		o	GHA232007	F
	1998.01-2003.04	Estate Engine LFX(XU7JB) With ABS		o	GHA232032	K
	1998.01-2003.04	Estate Engine LFX(XU7JB) Without ABS		o	GHA232011	K



	 YEAR		F	R	G-AP Ref.	KIT	
CITROEN							
XANTIA (X2)							
1.8 i (66 kW)	1998.01-2003.04	Hatchback Engine LFX(XU7JB)	•		GHA425022		
	1998.01-2003.04	Hatchback Engine LFX(XU7JB)	•		GWB0915		
	1998.01-2003.04	Hatchback Engine LFX(XU7JB)		o	GHA232035	K	
	1998.01-2003.04	Hatchback Engine LFX(XU7JB) With ABS		o	GHA232007	F	
	1998.01-2003.04	Hatchback Engine LFX(XU7JB) With ABS		o	GHA232032	K	
	1998.01-2003.04	Hatchback Engine LFX(XU7JB) Without ABS		o	GHA232011	K	
1.8 i 16V (81 kW)	1998.01-2003.04	Estate Engine LFY(XU7JP4)	•		GHA425022		
	1998.01-2003.04	Estate Engine LFY(XU7JP4)	•		GWB0915		
	1998.01-2003.04	Estate Engine LFY(XU7JP4)		o	GHA232035	K	
	1998.01-2003.04	Estate Engine LFY(XU7JP4) With ABS		o	GHA232007	F	
	1998.01-2003.04	Estate Engine LFY(XU7JP4) With ABS		o	GHA232032	K	
	1998.01-2003.04	Estate Engine LFY(XU7JP4) Without ABS		o	GHA232011	K	
	1998.01-2003.04	Hatchback Engine LFY(XU7JP4)	•		GHA425022		
	1998.01-2003.04	Hatchback Engine LFY(XU7JP4)	•		GWB0915		
	1998.01-2003.04	Hatchback Engine LFY(XU7JP4)		o	GHA232035	K	
	1998.01-2003.04	Hatchback Engine LFY(XU7JP4) With ABS		o	GHA232007	F	
	1998.01-2003.04	Hatchback Engine LFY(XU7JP4) With ABS		o	GHA232032	K	
	1998.01-2003.04	Hatchback Engine LFY(XU7JP4) Without ABS		o	GHA232011	K	
	1.9 SD (55 kW)	1998.01-2003.04	Estate Engine DHW(XUD9SD)	•		GHA425022	
		1998.01-2003.04	Estate Engine DHW(XUD9SD)	•		GWB0915	
1998.01-2003.04		Estate Engine DHW(XUD9SD)		o	GHA232035	K	
1998.01-2003.04		Estate Engine DHW(XUD9SD) With ABS		o	GHA232007	F	
1998.01-2003.04		Estate Engine DHW(XUD9SD) With ABS		o	GHA232032	K	
1998.01-2003.04		Estate Engine DHW(XUD9SD) Without ABS		o	GHA232011	K	
1998.01-2003.04		Hatchback Engine DHW(XUD9SD)	•		GHA425022		
1998.01-2003.04		Hatchback Engine DHW(XUD9SD)	•		GWB0915		
1998.01-2003.04		Hatchback Engine DHW(XUD9SD)		o	GHA232035	K	
1998.01-2003.04		Hatchback Engine DHW(XUD9SD) With ABS		o	GHA232007	F	
1998.01-2003.04		Hatchback Engine DHW(XUD9SD) With ABS		o	GHA232032	K	
1998.01-2003.04		Hatchback Engine DHW(XUD9SD) Without ABS		o	GHA232011	K	
1.9 Turbo D (66 kW)		1998.01-2003.04	Estate Engine D8B(XUD9TF)/DHX(XUD9TF/BTF)	•		GWB0915	
		1998.01-2003.04	Estate Engine D8B(XUD9TF)/DHX(XUD9TF/BTF)		o	GHA232035	K
	1998.01-2003.04	Estate Engine D8B(XUD9TF)/DHX(XUD9TF/BTF) With ABS		o	GHA232007	F	
	1998.01-2003.04	Estate Engine D8B(XUD9TF)/DHX(XUD9TF/BTF) With ABS		o	GHA232032	K	
	1998.01-2003.04	Estate Engine D8B(XUD9TF)/DHX(XUD9TF/BTF) Without ABS		o	GHA232011	K	
	1998.01-2003.04	Hatchback Engine DHX(XUD9TF/BTF)/DHY(XUD9TE/Y)	•		GHA425022		
	1998.01-2003.04	Hatchback Engine DHX(XUD9TF/BTF)/DHY(XUD9TE/Y)	•		GWB0915		
	1998.01-2003.04	Hatchback Engine DHX(XUD9TF/BTF)/DHY(XUD9TE/Y)		o	GHA232035	K	
	1998.01-2003.04	Hatchback Engine DHX(XUD9TF/BTF)/DHY(XUD9TE/Y) With ABS		o	GHA232007	F	
	1998.01-2003.04	Hatchback Engine DHX(XUD9TF/BTF)/DHY(XUD9TE/Y) With ABS		o	GHA232032	K	
2.0 HDi (66 kW)	1999.03-2003.04	Estate Engine RHY(DW10TD)	•		GHA425022		
	1999.03-2003.04	Estate Engine RHY(DW10TD)	•		GWB0915		
	1999.03-2003.04	Estate Engine RHY(DW10TD)		o	GHA232035	K	
	1999.03-2003.04	Estate Engine RHY(DW10TD) With ABS		o	GHA232007	F	
	1999.03-2003.04	Estate Engine RHY(DW10TD) With ABS		o	GHA232032	K	
	1999.03-2003.04	Estate Engine RHY(DW10TD) Without ABS		o	GHA232011	K	
	1999.03-2003.04	Hatchback Engine RHY(DW10TD)	•		GHA425022		
	1999.03-2003.04	Hatchback Engine RHY(DW10TD)	•		GWB0915		
	1999.03-2003.04	Hatchback Engine RHY(DW10TD)		o	GHA232035	K	
	1999.03-2003.04	Hatchback Engine RHY(DW10TD) With ABS		o	GHA232007	F	
	1999.03-2003.04	Hatchback Engine RHY(DW10TD) With ABS		o	GHA232032	K	
	1999.03-2003.04	Hatchback Engine RHY(DW10TD) Without ABS		o	GHA232011	K	
	2.0 HDi (80 kW)	1999.02-2003.04	Estate Engine RHZ(DW10ATED)	•		GWB0915	
		1999.02-2003.04	Estate Engine RHZ(DW10ATED)		o	GHA232035	K
1999.02-2003.04		Estate Engine RHZ(DW10ATED) With ABS		o	GHA232007	F	
1999.02-2003.04		Estate Engine RHZ(DW10ATED) With ABS		o	GHA232032	K	
1999.02-2003.04		Estate Engine RHZ(DW10ATED) Without ABS		o	GHA232011	K	
1999.02-2003.04		Hatchback Engine RHZ(DW10ATED)	•		GWB0915		
1999.02-2003.04		Hatchback Engine RHZ(DW10ATED)		o	GHA232035	K	
1999.02-2003.04		Hatchback Engine RHZ(DW10ATED) With ABS		o	GHA232007	F	
1999.02-2003.04		Hatchback Engine RHZ(DW10ATED) With ABS		o	GHA232032	K	
1999.02-2003.04		Hatchback Engine RHZ(DW10ATED) Without ABS		o	GHA232011	K	
2.0 i (89 kW)	1998.01-2003.04	Estate Engine RFX(XU10J2C)	•		GWB0915		



	 YEAR		F	R	G-AP Ref.	KIT	
CITROEN							
XANTIA (X2)							
2.0 i (89 kW)	1998.01-2003.04	Estate Engine RFX(XU10J2C)		o	GHA232035	K	
	1998.01-2003.04	Estate Engine RFX(XU10J2C) With ABS		o	GHA232007	F	
	1998.01-2003.04	Estate Engine RFX(XU10J2C) With ABS		o	GHA232032	K	
	1998.01-2003.04	Estate Engine RFX(XU10J2C) Without ABS		o	GHA232011	K	
	1998.01-2003.04	Hatchback Engine RFX(XU10J2C)	•		GWB0915		
	1998.01-2003.04	Hatchback Engine RFX(XU10J2C)		o	GHA232035	K	
	1998.01-2003.04	Hatchback Engine RFX(XU10J2C) With ABS		o	GHA232007	F	
	1998.01-2003.04	Hatchback Engine RFX(XU10J2C) With ABS		o	GHA232032	K	
	1998.01-2003.04	Hatchback Engine RFX(XU10J2C) Without ABS		o	GHA232011	K	
	2.0 i 16V (97 kW)	1998.01-2003.04	Estate Engine RFV(XU10J4R)	•		GHA425022	
		1998.01-2003.04	Estate Engine RFV(XU10J4R)	•		GWB0915	
		1998.01-2003.04	Estate Engine RFV(XU10J4R)		o	GHA232035	K
		1998.01-2003.04	Estate Engine RFV(XU10J4R) With ABS		o	GHA232007	F
		1998.01-2003.04	Estate Engine RFV(XU10J4R) With ABS		o	GHA232032	K
1998.01-2003.04		Estate Engine RFV(XU10J4R) Without ABS		o	GHA232011	K	
1998.01-2003.04		Hatchback Engine RFV(XU10J4R)	•		GHA425022		
1998.01-2003.04		Hatchback Engine RFV(XU10J4R)	•		GWB0915		
1998.01-2003.04		Hatchback Engine RFV(XU10J4R)		o	GHA232035	K	
1998.01-2003.04		Hatchback Engine RFV(XU10J4R) With ABS		o	GHA232007	F	
1998.01-2003.04		Hatchback Engine RFV(XU10J4R) With ABS		o	GHA232032	K	
1998.01-2003.04		Hatchback Engine RFV(XU10J4R) Without ABS		o	GHA232011	K	
2.0 Turbo (108 kW)		1998.01-2003.04	Estate Engine RGX(XU10J2TE)	•		GWB0915	
		1998.01-2003.04	Estate Engine RGX(XU10J2TE)		o	GHA232035	K
	1998.01-2003.04	Estate Engine RGX(XU10J2TE) With ABS		o	GHA232007	F	
	1998.01-2003.04	Estate Engine RGX(XU10J2TE) With ABS		o	GHA232032	K	
	1998.01-2003.04	Estate Engine RGX(XU10J2TE) Without ABS		o	GHA232011	K	
	1998.01-2003.04	Hatchback Engine RGX(XU10J2TE)	•		GWB0915		
	1998.01-2003.04	Hatchback Engine RGX(XU10J2TE)		o	GHA232035	K	
	1998.01-2003.04	Hatchback Engine RGX(XU10J2TE) With ABS		o	GHA232007	F	
	1998.01-2003.04	Hatchback Engine RGX(XU10J2TE) With ABS		o	GHA232032	K	
	1998.01-2003.04	Hatchback Engine RGX(XU10J2TE) Without ABS		o	GHA232011	K	
2.1 Turbo D 12V (80 kW)	1998.01-1999.02	Estate Engine P8C(XUD11BTE)	•		GWB0915		
	1998.01-1999.02	Estate Engine P8C(XUD11BTE) With ABS		o	GHA232007	F	
	1998.01-1999.02	Estate Engine P8C(XUD11BTE) Without ABS		o	GHA232011	K	
	1998.01-1999.02	Hatchback Engine P8C(XUD11BTE)	•		GWB0915		
	1998.01-1999.02	Hatchback Engine P8C(XUD11BTE) With ABS		o	GHA232007	F	
	1998.01-1999.02	Hatchback Engine P8C(XUD11BTE) Without ABS		o	GHA232011	K	
3.0 V6 (140 kW)	1998.01-2003.04	Estate Engine XFZ(ES9J4)	•		GWB0915		
	1998.01-2003.04	Estate Engine XFZ(ES9J4)		o	GHA232035	K	
	1998.01-2003.04	Estate Engine XFZ(ES9J4) With ABS		o	GHA232007	F	
	1998.01-2003.04	Estate Engine XFZ(ES9J4) With ABS		o	GHA232032	K	
	1998.01-2003.04	Estate Engine XFZ(ES9J4) Without ABS		o	GHA232011	K	
	1998.01-2003.04	Hatchback Engine XFZ(ES9J4)	•		GWB0915		
	1998.01-2003.04	Hatchback Engine XFZ(ES9J4)		o	GHA232035	K	
	1998.01-2003.04	Hatchback Engine XFZ(ES9J4) With ABS		o	GHA232007	F	
	1998.01-2003.04	Hatchback Engine XFZ(ES9J4) With ABS		o	GHA232032	K	
	1998.01-2003.04	Hatchback Engine XFZ(ES9J4) Without ABS		o	GHA232011	K	
XM (Y3)							
2.0 i (79 kW)	1991.11-1994.04	Estate Engine RDZ(XU10MZ)/XU102C			GWB1412		
2.0 i (89 kW)	1991.11-1994.04	Estate Engine RFZ(XU10J2)			GWB1412		
2.0 i Turbo (104 kW)	1992.09-1994.06	Hatchback Engine RGY(XU10J2TE/Z)			GWB1412		
2.0 Turbo (104 kW)	1992.09-1994.04	Estate Engine RGY(XU10J2TE/Z)			GWB1412		
2.1 D 12V (60 kW)	1991.11-1994.04	Estate Engine P9A(XUD11A)			GWB1412		
2.1 TD 12V (80 kW)	1991.11-1994.04	Estate Engine P8A(XUD11ATE)/P8C(XUD11BTE)/PHZ(XUD11ATE)/PJZ(XUD11ATE)			GWB1412		
3.0 V6 (123 kW)	1991.11-1994.04	Estate Engine SFZ(ZPJ/Z)/UFZ(ZPJ/Z)			GWB1412		
3.0 V6 24V (147 kW)	1990.07-1994.06	Hatchback Engine SKZ(ZPJ4/Z)/UKZ(ZPJ4/Z)			GWB1412		
XM (Y4)							
2.0 i 16V (97 kW)	1994.05-2000.10	Estate Engine RFV(XU10J4R)	•		GWB3490		
	1994.05-2000.10	Estate Engine RFV(XU10J4R)			GWB1412		
	1994.05-2000.10	Hatchback Engine RFV(XU10J4R)	•		GWB3490		
	1994.05-2000.10	Hatchback Engine RFV(XU10J4R)			GWB1412		
2.0 Turbo (108 kW)	1994.05-2000.10	Estate Engine RGX(XU10J2TE)/RGY(XU10J2TE/Z)	•		GWB3490		
	1994.05-2000.10	Estate Engine RGX(XU10J2TE)/RGY(XU10J2TE/Z)			GWB1412		
	1994.05-2000.10	Hatchback Engine RGX(XU10J2TE)	•		GWB3490		



	 YEAR		F	R	G-AP Ref.	KIT
CITROEN						
XM (Y4)						
2.0 Turbo (108 kW)	1994.05-2000.10	Hatchback Engine RGX(XU10J2TE)			GWB1412	
2.1 D12 (60 kW)	1994.07-1996.06	Estate Engine P9A(XUD11A)			GWB1412	
2.1 TD 12V (80 kW)	1994.05-2000.10	Estate Engine P8C(XUD11BTE)/PHZ(XUD11ATE)/PJZ(XUD11ATE)	•		GWB3490	
	1994.05-2000.10	Estate Engine P8C(XUD11BTE)/PHZ(XUD11ATE)/PJZ(XUD11ATE)			GWB1412	
	1994.05-2000.10	Hatchback Engine P8A(XUD11ATE)/P8C(XUD11BTE)/PHZ(XUD11ATE)/PJZ(XUD11ATE)	•		GWB3490	
	1994.05-2000.10	Hatchback Engine P8A(XUD11ATE)/P8C(XUD11BTE)/PHZ(XUD11ATE)/PJZ(XUD11ATE)			GWB1412	
2.5 TD (95 kW)	1994.05-2000.10	Estate Engine THY(DK5ATE)	•		GWB3490	
	1994.05-2000.10	Estate Engine THY(DK5ATE)			GWB1412	
	1994.05-2000.10	Hatchback Engine THY(DK5ATE)	•		GWB3490	
	1994.05-2000.10	Hatchback Engine THY(DK5ATE)			GWB1412	
3.0 V6 (123 kW)	1994.05-2000.10	Estate Engine SFZ(ZPJ/Z)/UFZ(ZPJ/Z)	•		GWB3490	
	1994.05-2000.10	Estate Engine SFZ(ZPJ/Z)/UFZ(ZPJ/Z)			GWB1412	
	1994.05-2000.10	Hatchback Engine SFZ(ZPJ/Z)/UFZ(ZPJ/Z)	•		GWB3490	
	1994.05-2000.10	Hatchback Engine SFZ(ZPJ/Z)/UFZ(ZPJ/Z)			GWB1412	
3.0 V6 (140 kW)	1997.04-2000.10	Estate Engine XFZ(ES9J4)	•		GWB3490	
	1997.04-2000.10	Estate Engine XFZ(ES9J4)			GWB1412	
	1997.04-2000.10	Hatchback Engine XFZ(ES9J4)	•		GWB3490	
	1997.04-2000.10	Hatchback Engine XFZ(ES9J4)			GWB1412	
3.0 V6 24V (147 kW)	1994.05-2000.10	Hatchback Engine SKZ(ZPJ4/Z)/UKZ(ZPJ4/Z)	•		GWB3490	
	1994.05-2000.10	Hatchback Engine SKZ(ZPJ4/Z)/UKZ(ZPJ4/Z)			GWB1412	
XSARA						
2.0 HDi (66 kW)	2000.09-2005.03	Box Engine RHY(DW10TD)	•		GHA425022	
	2000.09-2005.03	Box Engine RHY(DW10TD)	•		GWB0915	
	2000.09-2005.03	Box Engine RHY(DW10TD)		o	GHA225009	A
	2000.09-2005.03	Box Engine RHY(DW10TD)		o	GHA225012	K
	2000.09-2005.03	Box Engine RHY(DW10TD)		o	GHA225013	K
	2000.09-2005.03	Box Engine RHY(DW10TD)		o	GWB3556	
XSARA (N0)						
1.4 HDi (50 kW)	2003.01-2005.03	Coupe Engine 8HX(DV4TD)	•		GHA425022	
	2003.01-2005.03	Coupe Engine 8HX(DV4TD)	•		GWB0915	
	2003.01-2005.03	Coupe Engine 8HX(DV4TD)		o	GHA225009	A
	2003.01-2005.03	Coupe Engine 8HX(DV4TD)		o	GHA225012	K
	2003.01-2005.03	Coupe Engine 8HX(DV4TD)		o	GHA225013	K
	2003.01-2005.03	Coupe Engine 8HX(DV4TD)		o	GWB3556	
1.4 i (55 kW)	1998.03-2005.03	Coupe Engine KFW(TU3JP)/KFX(TU3JP)	•		GHA421003	
	1998.03-2005.03	Coupe Engine KFW(TU3JP)/KFX(TU3JP)	•		GHA425022	
	1998.03-2005.03	Coupe Engine KFW(TU3JP)/KFX(TU3JP)	•		GWB0882	
	1998.03-2005.03	Coupe Engine KFW(TU3JP)/KFX(TU3JP)	•		GWB0915	
	1998.03-2005.03	Coupe Engine KFW(TU3JP)/KFX(TU3JP)	•		GWB3554A	
	1998.03-2005.03	Coupe Engine KFW(TU3JP)/KFX(TU3JP)		o	GHA225009	A
	1998.03-2005.03	Coupe Engine KFW(TU3JP)/KFX(TU3JP)		o	GHA225012	K
	1998.03-2005.03	Coupe Engine KFW(TU3JP)/KFX(TU3JP)		o	GHA225013	K
	1998.03-2005.03	Coupe Engine KFW(TU3JP)/KFX(TU3JP)		o	GHA225037	K
	1998.03-2005.03	Coupe Engine KFW(TU3JP)/KFX(TU3JP)		o	GWB0961	
1.6 16V (80 kW)	2000.09-2005.03	Coupe Engine NFU(TU5JP4)	•		GHA421003	
	2000.09-2005.03	Coupe Engine NFU(TU5JP4)	•		GHA425022	
	2000.09-2005.03	Coupe Engine NFU(TU5JP4)	•		GWB0915	
	2000.09-2005.03	Coupe Engine NFU(TU5JP4)	•		GWB3554A	
	2000.09-2005.03	Coupe Engine NFU(TU5JP4)		o	GHA225009	A
	2000.09-2005.03	Coupe Engine NFU(TU5JP4)		o	GHA225012	K
	2000.09-2005.03	Coupe Engine NFU(TU5JP4)		o	GHA225013	K
	2000.09-2005.03	Coupe Engine NFU(TU5JP4)		o	GWB3556	
1.6 i (65 kW)	1998.02-2000.09	Coupe Engine NFZ(TU5JP)	•		GHA421003	
	1998.02-2000.09	Coupe Engine NFZ(TU5JP)	•		GHA425022	
	1998.02-2000.09	Coupe Engine NFZ(TU5JP)	•		GWB0882	
	1998.02-2000.09	Coupe Engine NFZ(TU5JP)	•		GWB0915	
	1998.02-2000.09	Coupe Engine NFZ(TU5JP)	•		GWB3554A	
	1998.02-2000.09	Coupe Engine NFZ(TU5JP)		o	GHA225012	K
	1998.02-2000.09	Coupe Engine NFZ(TU5JP)		o	GHA225013	K
	1998.02-2000.09	Coupe Engine NFZ(TU5JP)		o	GHA225037	K
	1998.02-2000.09	Coupe Engine NFZ(TU5JP)		o	GWB0961	
	1998.02-2000.09	Coupe Engine NFZ(TU5JP)		o	GWB3556	
1.8 i (66 kW)	1998.02-2000.09	Coupe Engine LFX(XU7JB)	•		GHA425022	



	 YEAR		F	R	G-AP Ref.	KIT
CITROEN XSARA (N0)						
1.8 i (66 kW)	1998.02-2000.09	Coupe Engine LFX(XU7JB)	•		GWB0882	
	1998.02-2000.09	Coupe Engine LFX(XU7JB)	•		GWB0915	
	1998.02-2000.09	Coupe Engine LFX(XU7JB)	•		GWB3554A	
	1998.02-2000.09	Coupe Engine LFX(XU7JB)		○	GHA225009	A
	1998.02-2000.09	Coupe Engine LFX(XU7JB)		○	GHA225012	K
	1998.02-2000.09	Coupe Engine LFX(XU7JB)		○	GHA225013	K
	1998.02-2000.09	Coupe Engine LFX(XU7JB)		○	GHA225037	K
	1998.02-2000.09	Coupe Engine LFX(XU7JB)		○	GWB0961	
	1998.02-2000.09	Coupe Engine LFX(XU7JB)		○	GWB3556	
	1.8 i (74 kW)	1998.02-2000.09	Coupe Engine LFZ(XU7JP)	•		GHA425022
1998.02-2000.09		Coupe Engine LFZ(XU7JP)	•		GWB0882	
1998.02-2000.09		Coupe Engine LFZ(XU7JP)	•		GWB0915	
1998.02-2000.09		Coupe Engine LFZ(XU7JP)	•		GWB3554A	
1998.02-2000.09		Coupe Engine LFZ(XU7JP)		○	GHA225009	A
1998.02-2000.09		Coupe Engine LFZ(XU7JP)		○	GHA225012	K
1998.02-2000.09		Coupe Engine LFZ(XU7JP)		○	GHA225013	K
1998.02-2000.09		Coupe Engine LFZ(XU7JP)		○	GHA225037	K
1998.02-2000.09		Coupe Engine LFZ(XU7JP)		○	GWB0961	
1998.02-2000.09		Coupe Engine LFZ(XU7JP)		○	GWB3556	
1.8 i 16V (81 kW)	1998.02-2000.09	Coupe Engine LFX(XU7JP4)	•		GHA425022	
	1998.02-2000.09	Coupe Engine LFX(XU7JP4)	•		GWB0882	
	1998.02-2000.09	Coupe Engine LFX(XU7JP4)	•		GWB0915	
	1998.02-2000.09	Coupe Engine LFX(XU7JP4)	•		GWB3554A	
	1998.02-2000.09	Coupe Engine LFX(XU7JP4)		○	GHA225009	A
	1998.02-2000.09	Coupe Engine LFX(XU7JP4)		○	GHA225012	K
	1998.02-2000.09	Coupe Engine LFX(XU7JP4)		○	GHA225013	K
	1998.02-2000.09	Coupe Engine LFX(XU7JP4)		○	GHA225037	K
	1998.02-2000.09	Coupe Engine LFX(XU7JP4)		○	GWB0961	
	1998.02-2000.09	Coupe Engine LFX(XU7JP4)		○	GWB3556	
1.9 D (50 kW)	1998.02-2000.09	Coupe Engine DJY(XUD9A)	•		GHA425022	
	1998.02-2000.09	Coupe Engine DJY(XUD9A)	•		GWB0882	
	1998.02-2000.09	Coupe Engine DJY(XUD9A)	•		GWB0915	
	1998.02-2000.09	Coupe Engine DJY(XUD9A)	•		GWB3554A	
	1998.02-2000.09	Coupe Engine DJY(XUD9A)		○	GHA225009	A
	1998.02-2000.09	Coupe Engine DJY(XUD9A)		○	GHA225012	K
	1998.02-2000.09	Coupe Engine DJY(XUD9A)		○	GHA225013	K
	1998.02-2000.09	Coupe Engine DJY(XUD9A)		○	GHA225037	K
	1998.02-2000.09	Coupe Engine DJY(XUD9A)		○	GWB0961	
	1998.02-2000.09	Coupe Engine DJY(XUD9A)		○	GWB3556	
1.9 D (51 kW)	1999.02-2005.03	Coupe Engine WJY(DW8B)/WJZ(DW8)	•		GHA425022	
	1999.02-2005.03	Coupe Engine WJY(DW8B)/WJZ(DW8)	•		GWB0915	
	1999.02-2005.03	Coupe Engine WJY(DW8B)/WJZ(DW8)	•		GWB3554A	
	1999.02-2005.03	Coupe Engine WJY(DW8B)/WJZ(DW8)		○	GHA225009	A
	1999.02-2005.03	Coupe Engine WJY(DW8B)/WJZ(DW8)		○	GHA225012	K
	1999.02-2005.03	Coupe Engine WJY(DW8B)/WJZ(DW8)		○	GHA225013	K
	1999.02-2005.03	Coupe Engine WJY(DW8B)/WJZ(DW8)		○	GWB3556	
1.9 D (55 kW)	1998.02-1999.05	Coupe	•		GHA425022	
	1998.02-1999.05	Coupe	•		GWB0882	
	1998.02-1999.05	Coupe	•		GWB0915	
	1998.02-1999.05	Coupe	•		GWB3554A	
1.9 TD (66 kW)	1998.02-2000.09	Coupe Engine DHY(XUD9TE/Y)	•		GHA425022	
	1998.02-2000.09	Coupe Engine DHY(XUD9TE/Y)	•		GWB0882	
	1998.02-2000.09	Coupe Engine DHY(XUD9TE/Y)	•		GWB0915	
	1998.02-2000.09	Coupe Engine DHY(XUD9TE/Y)	•		GWB3554A	
	1998.02-2000.09	Coupe Engine DHY(XUD9TE/Y)		○	GHA225009	A
	1998.02-2000.09	Coupe Engine DHY(XUD9TE/Y)		○	GHA225012	K
	1998.02-2000.09	Coupe Engine DHY(XUD9TE/Y)		○	GHA225013	K
	1998.02-2000.09	Coupe Engine DHY(XUD9TE/Y)		○	GHA225037	K
	1998.02-2000.09	Coupe Engine DHY(XUD9TE/Y)		○	GWB0961	
	1998.02-2000.09	Coupe Engine DHY(XUD9TE/Y)		○	GWB3556	
2.0 16V (100 kW)	2000.09-2005.03	Coupe Engine RFN(EW10J4)	•		GHA425022	
	2000.09-2005.03	Coupe Engine RFN(EW10J4)	•		GWB0915	
	2000.09-2005.03	Coupe Engine RFN(EW10J4)		○	GHA225009	A
	2000.09-2005.03	Coupe Engine RFN(EW10J4)		○	GHA225012	K



	 YEAR		F	R	G-AP Ref.	KIT
CITROEN						
XSARA (N0)						
2.0 16V (100 kW)	2000.09-2005.03	Coupe Engine RFN(EW10J4)		o	GHA225013	K
	2000.09-2005.03	Coupe Engine RFN(EW10J4)		o	GWB3556	
2.0 HDi (66 kW)	1999.02-2005.03	Coupe Engine RHY(DW10TD)	•		GHA425022	
	1999.02-2005.03	Coupe Engine RHY(DW10TD)	•		GWB0915	
	1999.02-2005.03	Coupe Engine RHY(DW10TD)		o	GHA225009	A
	1999.02-2005.03	Coupe Engine RHY(DW10TD)		o	GHA225012	K
	1999.02-2005.03	Coupe Engine RHY(DW10TD)		o	GHA225013	K
	1999.02-2005.03	Coupe Engine RHY(DW10TD)		o	GWB3556	
2.0 HDi (80 kW)	2001.05-2005.03	Coupe Engine RHZ(DW10ATED)	•		GHA425022	
	2001.05-2005.03	Coupe Engine RHZ(DW10ATED)	•		GWB0915	
	2001.05-2005.03	Coupe Engine RHZ(DW10ATED)		o	GHA225009	A
	2001.05-2005.03	Coupe Engine RHZ(DW10ATED)		o	GHA225012	K
	2001.05-2005.03	Coupe Engine RHZ(DW10ATED)		o	GHA225013	K
	2001.05-2005.03	Coupe Engine RHZ(DW10ATED)		o	GWB3556	
2.0 i 16V (120 kW)	1998.02-2005.03	Coupe Engine RFS(XU10J4RS)	•		GHA425022	
	1998.02-2005.03	Coupe Engine RFS(XU10J4RS)	•		GWB0882	
	1998.02-2005.03	Coupe Engine RFS(XU10J4RS)	•		GWB0915	
	1998.02-2005.03	Coupe Engine RFS(XU10J4RS)	•		GWB3554A	
	1998.02-2005.03	Coupe Engine RFS(XU10J4RS)		o	GHA225009	A
	1998.02-2005.03	Coupe Engine RFS(XU10J4RS)		o	GHA225012	K
	1998.02-2005.03	Coupe Engine RFS(XU10J4RS)		o	GHA225013	K
	1998.02-2005.03	Coupe Engine RFS(XU10J4RS)		o	GHA225037	K
	1998.02-2005.03	Coupe Engine RFS(XU10J4RS)		o	GWB0961	
1998.02-2005.03	Coupe Engine RFS(XU10J4RS)		o	GWB3556		
XSARA (N1)						
1.4 HDi (50 kW)	2003.01-2005.03	Hatchback Engine 8HX(DV4TD)	•		GHA425022	
	2003.01-2005.03	Hatchback Engine 8HX(DV4TD)	•		GWB0915	
	2003.01-2005.03	Hatchback Engine 8HX(DV4TD)		o	GHA225009	A
	2003.01-2005.03	Hatchback Engine 8HX(DV4TD)		o	GHA225012	K
	2003.01-2005.03	Hatchback Engine 8HX(DV4TD)		o	GHA225013	K
	2003.01-2005.03	Hatchback Engine 8HX(DV4TD)		o	GWB3556	
1.4 i (55 kW)	1997.04-2005.03	Hatchback Engine KFW(TU3JP)/KFX(TU3JP)	•		GHA421003	
	1997.04-2005.03	Hatchback Engine KFW(TU3JP)/KFX(TU3JP)	•		GHA425022	
	1997.04-2005.03	Hatchback Engine KFW(TU3JP)/KFX(TU3JP)	•		GWB0882	
	1997.04-2005.03	Hatchback Engine KFW(TU3JP)/KFX(TU3JP)	•		GWB0915	
	1997.04-2005.03	Hatchback Engine KFW(TU3JP)/KFX(TU3JP)	•		GWB3554A	
	1997.04-2005.03	Hatchback Engine KFW(TU3JP)/KFX(TU3JP)		o	GHA225009	A
	1997.04-2005.03	Hatchback Engine KFW(TU3JP)/KFX(TU3JP)		o	GHA225012	K
	1997.04-2005.03	Hatchback Engine KFW(TU3JP)/KFX(TU3JP)		o	GHA225013	K
	1997.04-2005.03	Hatchback Engine KFW(TU3JP)/KFX(TU3JP)		o	GHA225037	K
	1997.04-2005.03	Hatchback Engine KFW(TU3JP)/KFX(TU3JP)		o	GWB0961	
1997.04-2005.03	Hatchback Engine KFW(TU3JP)/KFX(TU3JP)		o	GWB3556		
1.4 LPG (55 kW)	1998.05-2000.08	Hatchback Engine KFW (TU3JP)	•		GHA421003	
	1998.05-2000.08	Hatchback Engine KFW (TU3JP)	•		GHA425022	
1.5 D (42 kW)	1997.04-2000.09	Hatchback Engine VJZ(TUD5)	•		GHA421003	
	1997.04-2000.09	Hatchback Engine VJZ(TUD5)	•		GHA425022	
	1997.04-2000.09	Hatchback Engine VJZ(TUD5)	•		GWB0882	
	1997.04-2000.09	Hatchback Engine VJZ(TUD5)	•		GWB0915	
	1997.04-2000.09	Hatchback Engine VJZ(TUD5)	•		GWB3554A	
	1997.04-2000.09	Hatchback Engine VJZ(TUD5)		o	GHA225012	K
	1997.04-2000.09	Hatchback Engine VJZ(TUD5)		o	GHA225013	K
	1997.04-2000.09	Hatchback Engine VJZ(TUD5)		o	GHA225037	K
	1997.04-2000.09	Hatchback Engine VJZ(TUD5)		o	GWB0961	
	1997.04-2000.09	Hatchback Engine VJZ(TUD5)		o	GWB3556	
1.6 16V (80 kW)	2000.09-2005.03	Hatchback Engine NFU(TU5JP4)	•		GHA421003	
	2000.09-2005.03	Hatchback Engine NFU(TU5JP4)	•		GHA425022	
	2000.09-2005.03	Hatchback Engine NFU(TU5JP4)	•		GWB0915	
	2000.09-2005.03	Hatchback Engine NFU(TU5JP4)	•		GWB3554A	
	2000.09-2005.03	Hatchback Engine NFU(TU5JP4)		o	GHA225009	A
	2000.09-2005.03	Hatchback Engine NFU(TU5JP4)		o	GHA225012	K
	2000.09-2005.03	Hatchback Engine NFU(TU5JP4)		o	GHA225013	K
1.6 i (65 kW)	1997.04-2000.09	Hatchback Engine NFZ(TU5JP)	•		GHA421003	
	1997.04-2000.09	Hatchback Engine NFZ(TU5JP)	•		GHA425022	



	 YEAR		F	R	G-AP Ref.	KIT
CITROEN XSARA (N1)						
1.6 i (65 kW)	1997.04-2000.09	Hatchback Engine NFZ(TU5JP)	•		GWB0882	
	1997.04-2000.09	Hatchback Engine NFZ(TU5JP)	•		GWB0915	
	1997.04-2000.09	Hatchback Engine NFZ(TU5JP)	•		GWB3554A	
	1997.04-2000.09	Hatchback Engine NFZ(TU5JP)		○	GHA225012	K
	1997.04-2000.09	Hatchback Engine NFZ(TU5JP)		○	GHA225013	K
	1997.04-2000.09	Hatchback Engine NFZ(TU5JP)		○	GHA225037	K
	1997.04-2000.09	Hatchback Engine NFZ(TU5JP)		○	GWB0961	
	1997.04-2000.09	Hatchback Engine NFZ(TU5JP)		○	GWB3556	
1.8 D (43 kW)	1997.04-2000.09	Hatchback Engine 161A(XUD7)/A9A(XUD7)	•		GHA425022	
	1997.04-2000.09	Hatchback Engine 161A(XUD7)/A9A(XUD7)	•		GWB0882	
	1997.04-2000.09	Hatchback Engine 161A(XUD7)/A9A(XUD7)	•		GWB0915	
	1997.04-2000.09	Hatchback Engine 161A(XUD7)/A9A(XUD7)	•		GWB3554A	
	1997.04-2000.09	Hatchback Engine 161A(XUD7)/A9A(XUD7)		○	GHA225009	A
	1997.04-2000.09	Hatchback Engine 161A(XUD7)/A9A(XUD7)		○	GHA225012	K
	1997.04-2000.09	Hatchback Engine 161A(XUD7)/A9A(XUD7)		○	GHA225013	K
	1997.04-2000.09	Hatchback Engine 161A(XUD7)/A9A(XUD7)		○	GHA225037	K
	1997.04-2000.09	Hatchback Engine 161A(XUD7)/A9A(XUD7)		○	GWB0961	
1997.04-2000.09	Hatchback Engine 161A(XUD7)/A9A(XUD7)		○	GWB3556		
1.8 i (66 kW)	1997.04-2000.09	Hatchback Engine LFX(XU7JB)	•		GHA425022	
	1997.04-2000.09	Hatchback Engine LFX(XU7JB)	•		GWB0882	
	1997.04-2000.09	Hatchback Engine LFX(XU7JB)	•		GWB0915	
	1997.04-2000.09	Hatchback Engine LFX(XU7JB)	•		GWB3554A	
	1997.04-2000.09	Hatchback Engine LFX(XU7JB)		○	GHA225009	A
	1997.04-2000.09	Hatchback Engine LFX(XU7JB)		○	GHA225013	K
	1997.04-2000.09	Hatchback Engine LFX(XU7JB)		○	GWB0961	
1997.04-2000.09	Hatchback Engine LFX(XU7JB)		○	GWB3556		
1.8 i 16V (81 kW)	1997.04-2000.09	Hatchback Engine LFY(XU7JP4)	•		GHA425022	
	1997.04-2000.09	Hatchback Engine LFY(XU7JP4)	•		GWB0882	
	1997.04-2000.09	Hatchback Engine LFY(XU7JP4)	•		GWB0915	
	1997.04-2000.09	Hatchback Engine LFY(XU7JP4)	•		GWB3554A	
	1997.04-2000.09	Hatchback Engine LFY(XU7JP4)		○	GHA225009	A
	1997.04-2000.09	Hatchback Engine LFY(XU7JP4)		○	GHA225013	K
	1997.04-2000.09	Hatchback Engine LFY(XU7JP4)		○	GWB0961	
1997.04-2000.09	Hatchback Engine LFY(XU7JP4)		○	GWB3556		
1.8 i Aut. (74 kW)	1997.04-2000.09	Hatchback Engine LFZ(XU7JP)	•		GHA425022	
	1997.04-2000.09	Hatchback Engine LFZ(XU7JP)	•		GWB0882	
	1997.04-2000.09	Hatchback Engine LFZ(XU7JP)	•		GWB0915	
	1997.04-2000.09	Hatchback Engine LFZ(XU7JP)	•		GWB3554A	
	1997.04-2000.09	Hatchback Engine LFZ(XU7JP)		○	GHA225009	A
	1997.04-2000.09	Hatchback Engine LFZ(XU7JP)		○	GHA225013	K
	1997.04-2000.09	Hatchback Engine LFZ(XU7JP)		○	GWB0961	
1997.04-2000.09	Hatchback Engine LFZ(XU7JP)		○	GWB3556		
1.8 VTS (85 kW)	2000.03-2000.10	Hatchback Engine 6FZ(EW7J4)	•		GHA425022	
1.9 D (50 kW)	1997.04-2000.09	Hatchback Engine DJY(XUD9A)	•		GHA425022	
	1997.04-2000.09	Hatchback Engine DJY(XUD9A)	•		GWB0882	
	1997.04-2000.09	Hatchback Engine DJY(XUD9A)	•		GWB0915	
	1997.04-2000.09	Hatchback Engine DJY(XUD9A)	•		GWB3554A	
	1997.04-2000.09	Hatchback Engine DJY(XUD9A)		○	GHA225009	A
	1997.04-2000.09	Hatchback Engine DJY(XUD9A)		○	GHA225012	K
	1997.04-2000.09	Hatchback Engine DJY(XUD9A)		○	GHA225013	K
	1997.04-2000.09	Hatchback Engine DJY(XUD9A)		○	GHA225037	K
	1997.04-2000.09	Hatchback Engine DJY(XUD9A)		○	GWB0961	
	1997.04-2000.09	Hatchback Engine DJY(XUD9A)		○	GWB3556	
1.9 D (51 kW)	1998.07-2005.03	Hatchback Engine WJY(DW8B)/WJZ(DW8)	•		GHA425022	
	1998.07-2005.03	Hatchback Engine WJY(DW8B)/WJZ(DW8)	•		GWB0882	
	1998.07-2005.03	Hatchback Engine WJY(DW8B)/WJZ(DW8)	•		GWB0915	
	1998.07-2005.03	Hatchback Engine WJY(DW8B)/WJZ(DW8)	•		GWB3554A	
	1998.07-2005.03	Hatchback Engine WJY(DW8B)/WJZ(DW8)		○	GHA225009	A
	1998.07-2005.03	Hatchback Engine WJY(DW8B)/WJZ(DW8)		○	GHA225012	K
	1998.07-2005.03	Hatchback Engine WJY(DW8B)/WJZ(DW8)		○	GHA225013	K
	1998.07-2005.03	Hatchback Engine WJY(DW8B)/WJZ(DW8)		○	GHA225037	K
	1998.07-2005.03	Hatchback Engine WJY(DW8B)/WJZ(DW8)		○	GWB0961	
	1998.07-2005.03	Hatchback Engine WJY(DW8B)/WJZ(DW8)		○	GWB3556	
1.9 SD (55 kW)	1998.01-2000.09	Hatchback Engine DHV(XUD9BSD)	•		GHA425022	



	 YEAR		F	R	G-AP Ref.	KIT
CITROEN						
XSARA (N1)						
1.9 SD (55 kW)	1998.01-2000.09	Hatchback Engine DHV(XUD9BSD)	•		GWB0882	
	1998.01-2000.09	Hatchback Engine DHV(XUD9BSD)	•		GWB0915	
	1998.01-2000.09	Hatchback Engine DHV(XUD9BSD)	•		GWB3554A	
	1998.01-2000.09	Hatchback Engine DHV(XUD9BSD)		o	GHA225009	A
	1998.01-2000.09	Hatchback Engine DHV(XUD9BSD)		o	GHA225012	K
	1998.01-2000.09	Hatchback Engine DHV(XUD9BSD)		o	GHA225013	K
	1998.01-2000.09	Hatchback Engine DHV(XUD9BSD)		o	GHA225037	K
	1998.01-2000.09	Hatchback Engine DHV(XUD9BSD)		o	GWB0961	
	1998.01-2000.09	Hatchback Engine DHV(XUD9BSD)		o	GWB3556	
	1.9 TD (66 kW)	1997.04-2000.09	Hatchback Engine DHY(XUD9TE/Y)	•		GHA425022
1997.04-2000.09		Hatchback Engine DHY(XUD9TE/Y)	•		GWB0882	
1997.04-2000.09		Hatchback Engine DHY(XUD9TE/Y)	•		GWB0915	
1997.04-2000.09		Hatchback Engine DHY(XUD9TE/Y)	•		GWB3554A	
1997.04-2000.09		Hatchback Engine DHY(XUD9TE/Y)		o	GHA225009	A
1997.04-2000.09		Hatchback Engine DHY(XUD9TE/Y)		o	GHA225012	K
1997.04-2000.09		Hatchback Engine DHY(XUD9TE/Y)		o	GHA225013	K
1997.04-2000.09		Hatchback Engine DHY(XUD9TE/Y)		o	GHA225037	K
1997.04-2000.09		Hatchback Engine DHY(XUD9TE/Y)		o	GWB0961	
1997.04-2000.09		Hatchback Engine DHY(XUD9TE/Y)		o	GWB3556	
2.0 16V (100 kW)	2000.09-2005.03	Hatchback Engine RFN(EW10J4)	•		GHA425022	
	2000.09-2005.03	Hatchback Engine RFN(EW10J4)	•		GWB0915	
	2000.09-2005.03	Hatchback Engine RFN(EW10J4)		o	GHA225009	A
	2000.09-2005.03	Hatchback Engine RFN(EW10J4)		o	GHA225012	K
	2000.09-2005.03	Hatchback Engine RFN(EW10J4)		o	GHA225013	K
	2000.09-2005.03	Hatchback Engine RFN(EW10J4)		o	GWB3556	
2.0 16V (120 kW)	1997.04-2000.09	Hatchback Engine RFS(XU10J4RS)	•		GHA425022	
	1997.04-2000.09	Hatchback Engine RFS(XU10J4RS)	•		GWB0882	
	1997.04-2000.09	Hatchback Engine RFS(XU10J4RS)	•		GWB0915	
	1997.04-2000.09	Hatchback Engine RFS(XU10J4RS)	•		GWB3554A	
	1997.04-2000.09	Hatchback Engine RFS(XU10J4RS)		o	GHA225012	K
	1997.04-2000.09	Hatchback Engine RFS(XU10J4RS)		o	GHA225013	K
	1997.04-2000.09	Hatchback Engine RFS(XU10J4RS)		o	GHA225037	K
	1997.04-2000.09	Hatchback Engine RFS(XU10J4RS)		o	GWB0961	
2.0 16V (97 kW)	1998.07-2000.09	Hatchback Engine RFV(XU10J4R)	•		GHA425022	
	1998.07-2000.09	Hatchback Engine RFV(XU10J4R)	•		GWB0882	
	1998.07-2000.09	Hatchback Engine RFV(XU10J4R)	•		GWB0915	
	1998.07-2000.09	Hatchback Engine RFV(XU10J4R)	•		GWB3554A	
	1998.07-2000.09	Hatchback Engine RFV(XU10J4R)		o	GHA225012	K
	1998.07-2000.09	Hatchback Engine RFV(XU10J4R)		o	GHA225013	K
	1998.07-2000.09	Hatchback Engine RFV(XU10J4R)		o	GHA225037	K
	1998.07-2000.09	Hatchback Engine RFV(XU10J4R)		o	GWB0961	
2.0 HDi (66 kW)	1999.02-2005.03	Hatchback Engine RHY(DW10TD)	•		GHA425022	
	1999.02-2005.03	Hatchback Engine RHY(DW10TD)	•		GWB0915	
	1999.02-2005.03	Hatchback Engine RHY(DW10TD)		o	GHA225009	A
	1999.02-2005.03	Hatchback Engine RHY(DW10TD)		o	GHA225012	K
	1999.02-2005.03	Hatchback Engine RHY(DW10TD)		o	GHA225013	K
	1999.02-2005.03	Hatchback Engine RHY(DW10TD)		o	GWB3556	
2.0 HDi (80 kW)	2001.05-2005.03	Hatchback Engine RHZ(DW10ATED)	•		GHA425022	
	2001.05-2005.03	Hatchback Engine RHZ(DW10ATED)	•		GWB0915	
	2001.05-2005.03	Hatchback Engine RHZ(DW10ATED)		o	GHA225009	A
	2001.05-2005.03	Hatchback Engine RHZ(DW10ATED)		o	GHA225012	K
	2001.05-2005.03	Hatchback Engine RHZ(DW10ATED)		o	GHA225013	K
	2001.05-2005.03	Hatchback Engine RHZ(DW10ATED)		o	GWB3556	
XSARA (N2)						
1.4 HDi (50 kW)	2003.01-2005.08	Estate Engine 8HX(DV4TD)	•		GHA425022	
	2003.01-2005.08	Estate Engine 8HX(DV4TD)	•		GWB0915	
	2003.01-2005.08	Estate Engine 8HX(DV4TD)		o	GHA225009	A
	2003.01-2005.08	Estate Engine 8HX(DV4TD)		o	GHA225012	K
	2003.01-2005.08	Estate Engine 8HX(DV4TD)		o	GHA225013	K
	2003.01-2005.08	Estate Engine 8HX(DV4TD)		o	GWB3556	
1.4 i (55 kW)	1997.10-2005.08	Estate Engine KFW(TU3JP)/KFX(TU3JP)	•		GHA421003	
	1997.10-2005.08	Estate Engine KFW(TU3JP)/KFX(TU3JP)	•		GHA425022	



	 YEAR		F	R	G-AP Ref.	KIT	
CITROEN							
XSARA (N2)							
1.4 i (55 kW)	1997.10-2005.08	Estate Engine KFW(TU3JP)/KFX(TU3JP)	•		GWB0882		
	1997.10-2005.08	Estate Engine KFW(TU3JP)/KFX(TU3JP)	•		GWB0915		
	1997.10-2005.08	Estate Engine KFW(TU3JP)/KFX(TU3JP)	•		GWB3554A		
	1997.10-2005.08	Estate Engine KFW(TU3JP)/KFX(TU3JP)		○	GHA225009	A	
	1997.10-2005.08	Estate Engine KFW(TU3JP)/KFX(TU3JP)		○	GHA225012	K	
	1997.10-2005.08	Estate Engine KFW(TU3JP)/KFX(TU3JP)		○	GHA225013	K	
	1997.10-2005.08	Estate Engine KFW(TU3JP)/KFX(TU3JP)		○	GHA225037	K	
	1997.10-2005.08	Estate Engine KFW(TU3JP)/KFX(TU3JP)		○	GWB0961		
	1997.10-2005.08	Estate Engine KFW(TU3JP)/KFX(TU3JP)		○	GWB3556		
1.5 D (42 kW)	1997.10-2000.09	Estate Engine VJZ(TUD5)	•		GHA421003		
	1997.10-2000.09	Estate Engine VJZ(TUD5)	•		GHA425022		
	1997.10-2000.09	Estate Engine VJZ(TUD5)	•		GWB0882		
	1997.10-2000.09	Estate Engine VJZ(TUD5)	•		GWB0915		
	1997.10-2000.09	Estate Engine VJZ(TUD5)	•		GWB3554A		
	1997.10-2000.09	Estate Engine VJZ(TUD5)		○	GHA225009	A	
	1997.10-2000.09	Estate Engine VJZ(TUD5)		○	GHA225012	K	
	1997.10-2000.09	Estate Engine VJZ(TUD5)		○	GHA225013	K	
	1997.10-2000.09	Estate Engine VJZ(TUD5)		○	GHA225037	K	
	1997.10-2000.09	Estate Engine VJZ(TUD5)		○	GWB0961		
	1997.10-2000.09	Estate Engine VJZ(TUD5)		○	GWB3556		
1.6 16V (80 kW)	2000.09-2005.08	Estate Engine NFU(TU5JP4)	•		GHA421003		
	2000.09-2005.08	Estate Engine NFU(TU5JP4)	•		GHA425022		
	2000.09-2005.08	Estate Engine NFU(TU5JP4)	•		GWB0915		
	2000.09-2005.08	Estate Engine NFU(TU5JP4)	•		GWB3554A		
	2000.09-2005.08	Estate Engine NFU(TU5JP4)		○	GHA225009	A	
	2000.09-2005.08	Estate Engine NFU(TU5JP4)		○	GHA225012	K	
	2000.09-2005.08	Estate Engine NFU(TU5JP4)		○	GHA225013	K	
	2000.09-2005.08	Estate Engine NFU(TU5JP4)		○	GWB3556		
1.6 i (65 kW)	1997.10-2000.09	Estate Engine NFZ(TU5JP)	•		GHA421003		
	1997.10-2000.09	Estate Engine NFZ(TU5JP)	•		GHA425022		
	1997.10-2000.09	Estate Engine NFZ(TU5JP)	•		GWB0882		
	1997.10-2000.09	Estate Engine NFZ(TU5JP)	•		GWB0915		
	1997.10-2000.09	Estate Engine NFZ(TU5JP)	•		GWB3554A		
	1997.10-2000.09	Estate Engine NFZ(TU5JP)		○	GHA225009	A	
	1997.10-2000.09	Estate Engine NFZ(TU5JP)		○	GHA225012	K	
	1997.10-2000.09	Estate Engine NFZ(TU5JP)		○	GHA225013	K	
	1997.10-2000.09	Estate Engine NFZ(TU5JP)		○	GHA225037	K	
	1997.10-2000.09	Estate Engine NFZ(TU5JP)		○	GWB0961		
	1997.10-2000.09	Estate Engine NFZ(TU5JP)		○	GWB3556		
	1.8 D (43 kW)	1997.10-2000.09	Estate Engine A9A(XUD7)	•		GHA425022	
		1997.10-2000.09	Estate Engine A9A(XUD7)	•		GWB0882	
1997.10-2000.09		Estate Engine A9A(XUD7)	•		GWB0915		
1997.10-2000.09		Estate Engine A9A(XUD7)	•		GWB3554A		
1997.10-2000.09		Estate Engine A9A(XUD7)		○	GHA225009	A	
1997.10-2000.09		Estate Engine A9A(XUD7)		○	GHA225012	K	
1997.10-2000.09		Estate Engine A9A(XUD7)		○	GHA225013	K	
1997.10-2000.09		Estate Engine A9A(XUD7)		○	GHA225037	K	
1997.10-2000.09		Estate Engine A9A(XUD7)		○	GWB0961		
1997.10-2000.09		Estate Engine A9A(XUD7)		○	GWB3556		
1.8 i (66 kW)	1997.10-2000.09	Estate Engine LFX(XU7JB)	•		GHA425022		
	1997.10-2000.09	Estate Engine LFX(XU7JB)	•		GWB0882		
	1997.10-2000.09	Estate Engine LFX(XU7JB)	•		GWB0915		
	1997.10-2000.09	Estate Engine LFX(XU7JB)	•		GWB3554A		
	1997.10-2000.09	Estate Engine LFX(XU7JB)		○	GHA225009	A	
	1997.10-2000.09	Estate Engine LFX(XU7JB)		○	GHA225012	K	
	1997.10-2000.09	Estate Engine LFX(XU7JB)		○	GHA225013	K	
	1997.10-2000.09	Estate Engine LFX(XU7JB)		○	GHA225037	K	
1.8 i 16V (81 kW)	1997.10-2000.09	Estate Engine LFY(XU7JP4)	•		GHA425022		
	1997.10-2000.09	Estate Engine LFY(XU7JP4)	•		GWB0882		
	1997.10-2000.09	Estate Engine LFY(XU7JP4)	•		GWB0915		
	1997.10-2000.09	Estate Engine LFY(XU7JP4)	•		GWB3554A		
	1997.10-2000.09	Estate Engine LFY(XU7JP4)		○	GHA225009	A	
	1997.10-2000.09	Estate Engine LFY(XU7JP4)		○	GHA225012	K	
	1997.10-2000.09	Estate Engine LFY(XU7JP4)		○	GHA225013	K	



	 YEAR		F	R	G-AP Ref.	KIT
CITROEN XSARA (N2)						
1.8 i 16V (81 kW)	1997.10-2000.09	Estate Engine LFY(XU7JP4)		o	GHA225037	K
	1997.10-2000.09	Estate Engine LFY(XU7JP4)		o	GWB0961	
	1997.10-2000.09	Estate Engine LFY(XU7JP4)		o	GWB3556	
1.8 i Aut. (74 kW)	1997.10-2000.09	Estate Engine LFZ(XU7JP)	•		GHA425022	
	1997.10-2000.09	Estate Engine LFZ(XU7JP)	•		GWB0882	
	1997.10-2000.09	Estate Engine LFZ(XU7JP)	•		GWB0915	
	1997.10-2000.09	Estate Engine LFZ(XU7JP)	•		GWB3554A	
	1997.10-2000.09	Estate Engine LFZ(XU7JP)		o	GHA225009	A
	1997.10-2000.09	Estate Engine LFZ(XU7JP)		o	GHA225012	K
	1997.10-2000.09	Estate Engine LFZ(XU7JP)		o	GHA225013	K
	1997.10-2000.09	Estate Engine LFZ(XU7JP)		o	GHA225037	K
	1997.10-2000.09	Estate Engine LFZ(XU7JP)		o	GWB0961	
	1997.10-2000.09	Estate Engine LFZ(XU7JP)		o	GWB3556	
1.8 LPG (81 kW)	1998.05-2000.08	Estate Engine LFY(XU7JP4)	•		GHA425022	
	1998.05-2000.08	Estate Engine LFY(XU7JP4)	•		GWB0882	
	1998.05-2000.08	Estate Engine LFY(XU7JP4)	•		GWB0915	
	1998.05-2000.08	Estate Engine LFY(XU7JP4)	•		GWB3554A	
	1998.05-2000.08	Estate Engine LFY(XU7JP4)		o	GHA225009	A
	1998.05-2000.08	Estate Engine LFY(XU7JP4)		o	GHA225012	K
	1998.05-2000.08	Estate Engine LFY(XU7JP4)		o	GHA225013	K
	1998.05-2000.08	Estate Engine LFY(XU7JP4)		o	GHA225037	K
	1998.05-2000.08	Estate Engine LFY(XU7JP4)		o	GWB0961	
	1998.05-2000.08	Estate Engine LFY(XU7JP4)		o	GWB3556	
1.9 D (50 kW)	1997.10-2000.09	Estate Engine DJY(XUD9A)	•		GHA425022	
	1997.10-2000.09	Estate Engine DJY(XUD9A)	•		GWB0882	
	1997.10-2000.09	Estate Engine DJY(XUD9A)	•		GWB0915	
	1997.10-2000.09	Estate Engine DJY(XUD9A)	•		GWB3554A	
	1997.10-2000.09	Estate Engine DJY(XUD9A)		o	GHA225009	A
	1997.10-2000.09	Estate Engine DJY(XUD9A)		o	GHA225012	K
	1997.10-2000.09	Estate Engine DJY(XUD9A)		o	GHA225013	K
	1997.10-2000.09	Estate Engine DJY(XUD9A)		o	GHA225037	K
	1997.10-2000.09	Estate Engine DJY(XUD9A)		o	GWB0961	
	1997.10-2000.09	Estate Engine DJY(XUD9A)		o	GWB3556	
1.9 D (51 kW)	1998.07-2005.08	Estate Engine WJY(DW8B)/WJZ(DW8)	•		GHA425022	
	1998.07-2005.08	Estate Engine WJY(DW8B)/WJZ(DW8)	•		GWB0882	
	1998.07-2005.08	Estate Engine WJY(DW8B)/WJZ(DW8)	•		GWB0915	
	1998.07-2005.08	Estate Engine WJY(DW8B)/WJZ(DW8)	•		GWB3554A	
	1998.07-2005.08	Estate Engine WJY(DW8B)/WJZ(DW8)		o	GHA225009	A
	1998.07-2005.08	Estate Engine WJY(DW8B)/WJZ(DW8)		o	GHA225012	K
	1998.07-2005.08	Estate Engine WJY(DW8B)/WJZ(DW8)		o	GHA225013	K
	1998.07-2005.08	Estate Engine WJY(DW8B)/WJZ(DW8)		o	GHA225037	K
	1998.07-2005.08	Estate Engine WJY(DW8B)/WJZ(DW8)		o	GWB0961	
	1998.07-2005.08	Estate Engine WJY(DW8B)/WJZ(DW8)		o	GWB3556	
1.9 D (55 kW)	1998.01-2000.09	Estate Engine DHV(XUD9BSD)	•		GHA425022	
	1998.01-2000.09	Estate Engine DHV(XUD9BSD)	•		GWB0882	
	1998.01-2000.09	Estate Engine DHV(XUD9BSD)	•		GWB0915	
	1998.01-2000.09	Estate Engine DHV(XUD9BSD)	•		GWB3554A	
	1998.01-2000.09	Estate Engine DHV(XUD9BSD)		o	GHA225009	A
	1998.01-2000.09	Estate Engine DHV(XUD9BSD)		o	GHA225012	K
	1998.01-2000.09	Estate Engine DHV(XUD9BSD)		o	GHA225013	K
	1998.01-2000.09	Estate Engine DHV(XUD9BSD)		o	GHA225037	K
	1998.01-2000.09	Estate Engine DHV(XUD9BSD)		o	GWB0961	
	1998.01-2000.09	Estate Engine DHV(XUD9BSD)		o	GWB3556	
1.9 TD (66 kW)	1997.10-2000.09	Estate Engine DHY(XUD9TE/Y)	•		GHA425022	
	1997.10-2000.09	Estate Engine DHY(XUD9TE/Y)	•		GWB0882	
	1997.10-2000.09	Estate Engine DHY(XUD9TE/Y)	•		GWB0915	
	1997.10-2000.09	Estate Engine DHY(XUD9TE/Y)	•		GWB3554A	
	1997.10-2000.09	Estate Engine DHY(XUD9TE/Y)		o	GHA225009	A
	1997.10-2000.09	Estate Engine DHY(XUD9TE/Y)		o	GHA225012	K
	1997.10-2000.09	Estate Engine DHY(XUD9TE/Y)		o	GHA225013	K
	1997.10-2000.09	Estate Engine DHY(XUD9TE/Y)		o	GHA225037	K
	1997.10-2000.09	Estate Engine DHY(XUD9TE/Y)		o	GWB0961	
	1997.10-2000.09	Estate Engine DHY(XUD9TE/Y)		o	GWB3556	
2.0 16V (100 kW)	2000.09-2005.08	Estate Engine RFN(EW10J4)	•		GHA425022	



	 YEAR		F	R	G-AP Ref.	KIT
CITROEN						
XSARA (N2)						
2.0 16V (100 kW)	2000.09-2005.08	Estate Engine RFN(EW10J4)	•		GWB0915	
	2000.09-2005.08	Estate Engine RFN(EW10J4)		◦	GHA225009	A
	2000.09-2005.08	Estate Engine RFN(EW10J4)		◦	GHA225012	K
	2000.09-2005.08	Estate Engine RFN(EW10J4)		◦	GHA225013	K
	2000.09-2005.08	Estate Engine RFN(EW10J4)		◦	GWB3556	
2.0 16V (97 kW)	1998.07-2000.09	Estate Engine RFV(XU10J4R)	•		GHA425022	
	1998.07-2000.09	Estate Engine RFV(XU10J4R)	•		GWB0882	
	1998.07-2000.09	Estate Engine RFV(XU10J4R)	•		GWB0915	
	1998.07-2000.09	Estate Engine RFV(XU10J4R)	•		GWB3554A	
	1998.07-2000.09	Estate Engine RFV(XU10J4R)		◦	GHA225009	A
	1998.07-2000.09	Estate Engine RFV(XU10J4R)		◦	GHA225012	K
	1998.07-2000.09	Estate Engine RFV(XU10J4R)		◦	GHA225013	K
	1998.07-2000.09	Estate Engine RFV(XU10J4R)		◦	GHA225037	K
	1998.07-2000.09	Estate Engine RFV(XU10J4R)		◦	GWB0961	
	1998.07-2000.09	Estate Engine RFV(XU10J4R)		◦	GWB3556	
2.0 HDi (66 kW)	1999.02-2005.08	Estate Engine RHY(DW10TD)	•		GHA425022	
	1999.02-2005.08	Estate Engine RHY(DW10TD)	•		GWB0915	
	1999.02-2005.08	Estate Engine RHY(DW10TD)		◦	GHA225009	A
	1999.02-2005.08	Estate Engine RHY(DW10TD)		◦	GHA225012	K
	1999.02-2005.08	Estate Engine RHY(DW10TD)		◦	GHA225013	K
	1999.02-2005.08	Estate Engine RHY(DW10TD)		◦	GWB3556	
2.0 HDi (80 kW)	2001.05-2005.08	Estate Engine RHZ(DW10ATED)	•		GHA425022	
	2001.05-2005.08	Estate Engine RHZ(DW10ATED)	•		GWB0915	
	2001.05-2005.08	Estate Engine RHZ(DW10ATED)		◦	GHA225009	A
	2001.05-2005.08	Estate Engine RHZ(DW10ATED)		◦	GHA225012	K
	2001.05-2005.08	Estate Engine RHZ(DW10ATED)		◦	GHA225013	K
	2001.05-2005.08	Estate Engine RHZ(DW10ATED)		◦	GWB3556	
XSARA PICASSO (N68)						
1.6 (65 kW)	1999.12-	MPV Engine NFZ(TU5JP)	•		GHA425022	
	1999.12-	MPV Engine NFZ(TU5JP)	•		GWB0915	
	1999.12-	MPV Engine NFZ(TU5JP)		◦	GHA232021	K
	1999.12-	MPV Engine NFZ(TU5JP)		◦	GHA232028	K
	1999.12-	MPV Engine NFZ(TU5JP) With ABS		◦	GHA232032	K
	1999.12-	MPV Engine NFZ(TU5JP) Without ABS		◦	GHA232012	K
1.6 (67 kW)	2002.06-	MPV	•		GHA425022	
	2002.06-	MPV	•		GWB0915	
	2002.06-	MPV		◦	GHA232021	K
	2002.06-	MPV		◦	GHA232028	K
	2002.06-	MPV With ABS		◦	GHA232032	K
	2002.06-	MPV Without ABS		◦	GHA232012	K
1.6 (70 kW)	1999.12-	MPV Engine NFV(TU5JP)	•		GHA425022	
	1999.12-	MPV Engine NFV(TU5JP)	•		GWB0915	
	1999.12-	MPV Engine NFV(TU5JP)		◦	GHA232021	K
	1999.12-	MPV Engine NFV(TU5JP)		◦	GHA232028	K
	1999.12-	MPV Engine NFV(TU5JP) With ABS		◦	GHA232032	K
	1999.12-	MPV Engine NFV(TU5JP) Without ABS		◦	GHA232012	K
1.6 16V (80 kW)	2005.10-	MPV Engine NFU(TU5JP4)	•		GHA425022	
	2005.10-	MPV Engine NFU(TU5JP4)	•		GWB0915	
	2005.10-	MPV Engine NFU(TU5JP4)		◦	GHA232021	K
	2005.10-	MPV Engine NFU(TU5JP4) With ABS		◦	GHA232032	K
1.6 16V (81 kW)	2005.06-2006.09	MPV Engine NFU(TU5JP4)	•		GHA425022	
	2005.06-2006.09	MPV Engine NFU(TU5JP4)	•		GWB0915	
	2005.06-2006.09	MPV Engine NFU(TU5JP4)		◦	GHA232021	K
	2005.06-2006.09	MPV Engine NFU(TU5JP4) With ABS		◦	GHA232032	K
1.6 Chrono (74 kW)	2001.04-2004.10	MPV	•		GHA425022	
	2001.04-2004.10	MPV	•		GWB0915	
	2001.04-2004.10	MPV		◦	GHA232028	K
	2001.04-2004.10	MPV With ABS		◦	GHA232032	K
	2001.04-2004.10	MPV Without ABS		◦	GHA232012	K
1.6 HDi (66 kW)	2005.10-2007.03	MPV Engine 9HX(DV6ATED4)	•		GHA425022	
	2005.10-2007.03	MPV Engine 9HX(DV6ATED4)	•		GWB0915	
	2005.10-2007.03	MPV Engine 9HX(DV6ATED4)		◦	GHA232021	K
	2005.10-2007.03	MPV Engine 9HX(DV6ATED4) With ABS		◦	GHA232032	K
1.6 HDi (80 kW)	2004.02-2007.03	MPV Engine 9HY(DV6TED4)/9HZ(DV6TED4)	•		GHA425022	



	 YEAR		F	R	G-AP Ref.	KIT
CITROEN						
XSARA PICASSO (N68)						
1.6 HDi (80 kW)	2004.02-2007.03	MPV Engine 9HY(DV6TED4)/9HZ(DV6TED4)	•		GWB0915	
	2004.02-2007.03	MPV Engine 9HY(DV6TED4)/9HZ(DV6TED4)		◦	GHA232021	K
	2004.02-2007.03	MPV Engine 9HY(DV6TED4)/9HZ(DV6TED4)		◦	GHA232028	K
	2004.02-2007.03	MPV Engine 9HY(DV6TED4)/9HZ(DV6TED4) With ABS		◦	GHA232032	K
	2004.02-2007.03	MPV Engine 9HY(DV6TED4)/9HZ(DV6TED4) Without ABS		◦	GHA232012	K
1.8 16V (85 kW)	2000.02-	MPV Engine 6FZ(EW7J4)	•		GHA425022	
	2000.02-	MPV Engine 6FZ(EW7J4)	•		GWB0915	
	2000.02-	MPV Engine 6FZ(EW7J4)		◦	GHA232021	K
	2000.02-	MPV Engine 6FZ(EW7J4)		◦	GHA232028	K
	2000.02-	MPV Engine 6FZ(EW7J4) With ABS		◦	GHA232032	K
	2000.02-	MPV Engine 6FZ(EW7J4) Without ABS		◦	GHA232012	K
1.8 SX (76 kW)	2000.06-2005.08	MPV	•		GHA425022	
	2000.06-2005.08	MPV	•		GWB0915	
	2000.06-2005.08	MPV		◦	GHA232021	K
	2000.06-2005.08	MPV		◦	GHA232028	K
	2000.06-2005.08	MPV With ABS		◦	GHA232032	K
	2000.06-2005.08	MPV Without ABS		◦	GHA232012	K
2.0 16V (100 kW)	2003.01-2007.03	MPV Engine RFN(EW10J4)	•		GHA425022	
	2003.01-2007.03	MPV Engine RFN(EW10J4)	•		GWB0915	
	2003.01-2007.03	MPV Engine RFN(EW10J4)		◦	GHA232021	K
	2003.01-2007.03	MPV Engine RFN(EW10J4)		◦	GHA232028	K
	2003.01-2007.03	MPV Engine RFN(EW10J4) With ABS		◦	GHA232032	K
	2003.01-2007.03	MPV Engine RFN(EW10J4) Without ABS		◦	GHA232012	K
2.0 HDi (66 kW)	1999.12-	MPV Engine RHY(DW10TD)	•		GHA425022	
	1999.12-	MPV Engine RHY(DW10TD)	•		GWB0915	
	1999.12-	MPV Engine RHY(DW10TD)		◦	GHA232021	K
	1999.12-	MPV Engine RHY(DW10TD)		◦	GHA232028	K
	1999.12-	MPV Engine RHY(DW10TD) With ABS		◦	GHA232032	K
	1999.12-	MPV Engine RHY(DW10TD) Without ABS		◦	GHA232012	K
2.0 HDi (80 kW)	1999.12-	MPV Engine RHZ(DW10ATED)	•		GWB0915	
	1999.12-	MPV Engine RHZ(DW10ATED)		◦	GHA232021	K
	1999.12-	MPV Engine RHZ(DW10ATED)		◦	GHA232028	K
	1999.12-	MPV Engine RHZ(DW10ATED) With ABS		◦	GHA232032	K
	1999.12-	MPV Engine RHZ(DW10ATED) Without ABS		◦	GHA232012	K
ZX (N2)						
1.1 (40 kW)	1991.03-1993.08	Hatchback Engine H1A/H1B	•		GHA425022	
	1991.03-1993.08	Hatchback Engine H1A/H1B	•		GWB0882	
	1991.03-1993.08	Hatchback Engine H1A/H1B	•		GWB0915	
	1991.03-1993.08	Hatchback Engine H1A/H1B		◦	GWB0961	
1.1 (44 kW)	1991.03-1997.06	Hatchback Engine HDZ(TU1M)	•		GHA425022	
	1991.03-1997.06	Hatchback Engine HDZ(TU1M)	•		GWB0882	
	1991.03-1997.06	Hatchback Engine HDZ(TU1M)	•		GWB0915	
	1991.03-1997.06	Hatchback Engine HDZ(TU1M)		◦	GWB0961	
1.4 (55 kW)	1991.03-1997.06	Hatchback Engine KDZ(TU3M/Z)	•		GWB0882	
	1991.03-1997.06	Hatchback Engine KDZ(TU3M/Z)	•		GWB0915	
	1991.03-1997.06	Hatchback Engine KDZ(TU3M/Z)		◦	GWB0961	
1.4 D (37 kW)	1994.07-1997.1	Hatchback Engine K9Y (TUD3Y)	•		GWB0882	
	1994.07-1997.1	Hatchback Engine K9Y (TUD3Y)	•		GWB0915	
	1994.07-1997.1	Hatchback Engine K9Y (TUD3Y)		◦	GWB0961	
1.4 i (55 kW)	1991.03-1997.06	Hatchback Engine KDX(TU3M/Z)/KDZ(TU3M/Z)/KFX(TU3JP)	•		GHA425022	
	1991.03-1997.06	Hatchback Engine KDX(TU3M/Z)/KDZ(TU3M/Z)/KFX(TU3JP)	•		GWB0882	
	1991.03-1997.06	Hatchback Engine KDX(TU3M/Z)/KDZ(TU3M/Z)/KFX(TU3JP)	•		GWB0915	
	1991.03-1997.06	Hatchback Engine KDX(TU3M/Z)/KDZ(TU3M/Z)/KFX(TU3JP)		◦	GWB0961	
	1993.10-1997.10	Estate Engine KDX(TU3M/Z)/KDY(TU3M)/KFX(TU3JP)	•		GHA425022	
	1993.10-1997.10	Estate Engine KDX(TU3M/Z)/KDY(TU3M)/KFX(TU3JP)	•		GWB0882	
	1993.10-1997.10	Estate Engine KDX(TU3M/Z)/KDY(TU3M)/KFX(TU3JP)	•		GWB0915	
	1993.10-1997.10	Estate Engine KDX(TU3M/Z)/KDY(TU3M)/KFX(TU3JP)		◦	GHA225037	K
1.6 (66 kW)	1994.07-1997.10	Hatchback	•		GHA425022	
	1994.07-1997.10	Hatchback	•		GWB0915	
	1994.07-1997.10	Hatchback		◦	GHA225009	A
	1994.07-1997.10	Hatchback		◦	GWB0961	
1.6 i (65 kW)	1991.03-1997.06	Hatchback Engine BDY(XU5M)/BFZ(XU5JP)	•		GHA425022	
	1991.03-1997.06	Hatchback Engine BDY(XU5M)/BFZ(XU5JP)	•		GWB0915	
	1991.03-1997.06	Hatchback Engine BDY(XU5M)/BFZ(XU5JP)		◦	GHA225009	A



	 YEAR		F	R	G-AP Ref.	KIT
CITROEN						
ZX (N2)						
1.6 i (65 kW)	1991.03-1997.06	Hatchback Engine BDY(XU5M)/BFZ(XU5JP)		o	GWB0961	
	1993.10-1997.10	Estate Engine BDY(XU5M)/BFZ(XU5JP)	•		GHA425022	
	1993.10-1997.10	Estate Engine BDY(XU5M)/BFZ(XU5JP)	•		GWB0915	
	1993.10-1997.10	Estate Engine BDY(XU5M)/BFZ(XU5JP)		o	GHA225037	K
1.8 (76 kW)	1994.07-1997.10	Hatchback Engine LFZ(XU7JP)	•		GHA425022	
	1994.07-1997.10	Hatchback Engine LFZ(XU7JP)	•		GWB0915	
	1994.07-1997.10	Hatchback Engine LFZ(XU7JP)		o	GHA225009	A
	1994.07-1997.10	Hatchback Engine LFZ(XU7JP)		o	GWB0961	
1.8 (82 kW)	1996.04-1997.1	Hatchback Engine LFY (XU7JP4)	•		GWB0915	
	1996.04-1997.1	Hatchback Engine LFY (XU7JP4)		o	GWB0961	
1.8 D (44 kW)	1993.06-1997.06	Hatchback Engine 161A(XUD7)	•		GHA425022	
	1993.06-1997.06	Hatchback Engine 161A(XUD7)	•		GWB0915	
	1993.06-1997.06	Hatchback Engine 161A(XUD7)		o	GWB0961	
	1993.10-1997.10	Estate Engine 161A(XUD7)	•		GHA425022	
	1993.10-1997.10	Estate Engine 161A(XUD7)	•		GWB0915	
	1993.10-1997.10	Estate Engine 161A(XUD7)		o	GHA225037	K
1.8 i (74 kW)	1992.07-1997.06	Hatchback Engine LFZ(XU7JP)	•		GHA425022	
	1992.07-1997.06	Hatchback Engine LFZ(XU7JP)	•		GWB0915	
	1992.07-1997.06	Hatchback Engine LFZ(XU7JP)		o	GHA225009	A
	1992.07-1997.06	Hatchback Engine LFZ(XU7JP)		o	GWB0961	
	1993.10-1997.10	Estate Engine LFZ(XU7JP)	•		GHA425022	
	1993.10-1997.10	Estate Engine LFZ(XU7JP)	•		GWB0915	
	1993.10-1997.10	Estate Engine LFZ(XU7JP)		o	GHA225037	K
1.8 i 16V (81 kW)	1996.01-1997.06	Hatchback Engine LFY(XU7JP4)	•		GHA425022	
	1996.01-1997.06	Hatchback Engine LFY(XU7JP4)	•		GWB0915	
	1996.01-1997.06	Hatchback Engine LFY(XU7JP4)		o	GHA225009	A
	1996.01-1997.06	Hatchback Engine LFY(XU7JP4)		o	GWB0961	
	1996.01-1998.02	Estate Engine LFY(XU7JP4)	•		GHA425022	
	1996.01-1998.02	Estate Engine LFY(XU7JP4)	•		GWB0915	
	1996.01-1998.02	Estate Engine LFY(XU7JP4)		o	GHA225037	K
1.9 (93 kW)	1991.03-1997.06	Hatchback Engine D6E(XU9JA)	•		GWB0915	
	1991.03-1997.06	Hatchback Engine D6E(XU9JA)		o	GHA225009	A
	1991.03-1997.06	Hatchback Engine D6E(XU9JA)		o	GWB0961	
1.9 (96 kW)	1991.03-1993.09	Hatchback	•		GHA425022	
	1991.03-1993.09	Hatchback	•		GWB0915	
	1991.03-1993.09	Hatchback		o	GWB0961	
1.9 D (47 kW)	1991.03-1997.06	Hatchback Engine DJZ(XUD9Y)	•		GHA425022	
	1991.03-1997.06	Hatchback Engine DJZ(XUD9Y)	•		GWB0915	
	1991.03-1997.06	Hatchback Engine DJZ(XUD9Y)		o	GWB0961	
	1993.10-1997.10	Estate Engine DJZ(XUD9Y)	•		GHA425022	
	1993.10-1997.10	Estate Engine DJZ(XUD9Y)	•		GWB0915	
	1993.10-1997.10	Estate Engine DJZ(XUD9Y)		o	GHA225037	K
1.9 D (50 kW)	1993.07-1997.06	Hatchback Engine D9B(XUD9A/U)/DJY(XUD9A)	•		GHA425022	
	1993.07-1997.06	Hatchback Engine D9B(XUD9A/U)/DJY(XUD9A)	•		GWB0915	
	1993.07-1997.06	Hatchback Engine D9B(XUD9A/U)/DJY(XUD9A)		o	GWB0961	
	1994.06-1997.10	Estate Engine D9B(XUD9A/U)	•		GHA425022	
	1994.06-1997.10	Estate Engine D9B(XUD9A/U)	•		GWB0915	
	1994.06-1997.10	Estate Engine D9B(XUD9A/U)		o	GHA225037	K
1.9 DT (65 kW)	1994.07-1997.10	Hatchback	•		GHA425022	
	1994.07-1997.10	Hatchback	•		GWB0915	
	1994.07-1997.10	Hatchback		o	GHA225009	A
	1994.07-1997.10	Hatchback		o	GWB0961	
1.9 DT (68 kW)	1992.06-1994.06	Hatchback	•		GHA425022	
	1992.06-1994.06	Hatchback	•		GWB0915	
	1992.06-1994.06	Hatchback		o	GHA225009	A
	1992.06-1994.06	Hatchback		o	GWB0961	
1.9 i (88 kW)	1991.03-1997.06	Hatchback Engine DKZ(XU9JA)	•		GHA425022	
	1991.03-1997.06	Hatchback Engine DKZ(XU9JA)	•		GWB0915	
	1991.03-1997.06	Hatchback Engine DKZ(XU9JA)		o	GHA225009	A
	1991.03-1997.06	Hatchback Engine DKZ(XU9JA)		o	GWB0961	
1.9 TD (66 kW)	1992.07-1997.06	Hatchback Engine DHY(XUD9TE/Y)	•		GHA425022	
	1992.07-1997.06	Hatchback Engine DHY(XUD9TE/Y)	•		GWB0915	
	1992.07-1997.06	Hatchback Engine DHY(XUD9TE/Y)		o	GWB0961	
	1993.10-1997.10	Estate Engine DHY(XUD9TE/Y)	•		GHA425022	



	 YEAR		F	R	G-AP Ref.	KIT
CITROEN						
ZX (N2)						
1.9 TD (66 kW)	1993.10-1997.10	Estate Engine DHY(XUD9TE/Y)	•		GWB0915	
	1993.10-1997.10	Estate Engine DHY(XUD9TE/Y)		◦	GHA225037	K
2.0 (122 kW)	1996.09-1997.10	Hatchback Engine RFS(XU10J4RS)	•		GHA425022	
	1996.09-1997.10	Hatchback Engine RFS(XU10J4RS)	•		GWB0915	
	1996.09-1997.10	Hatchback Engine RFS(XU10J4RS)		◦	GHA225009	A
	1996.09-1997.10	Hatchback Engine RFS(XU10J4RS)		◦	GWB0961	
	1996.09-1997.10	Hatchback Engine RFS(XU10J4RS)		◦	GWB0961	
2.0 (90 kW)	1994.07-1997.10	Hatchback Engine RFX(XU10J2C)	•		GWB0915	
	1994.07-1997.10	Hatchback Engine RFX(XU10J2C)		◦	GHA225009	A
	1994.07-1997.10	Hatchback Engine RFX(XU10J2C)		◦	GWB0961	
2.0 i (89 kW)	1992.07-1997.06	Hatchback Engine RFX(XU10J2C)	•		GHA425022	
	1992.07-1997.06	Hatchback Engine RFX(XU10J2C)	•		GWB0915	
	1992.07-1997.06	Hatchback Engine RFX(XU10J2C)		◦	GHA225009	A
	1992.07-1997.06	Hatchback Engine RFX(XU10J2C)		◦	GWB0961	
2.0 i 16V (110 kW)	1994.06-1997.06	Hatchback Engine RFT(XU10J4/Z)	•		GWB0915	
	1994.06-1997.06	Hatchback Engine RFT(XU10J4/Z)		◦	GWB0961	
2.0 i 16V (112 kW)	1992.07-1994.10	Hatchback Engine RFT(XU10J4/Z)/RFY(XU10J4/Z)	•		GHA425022	
	1992.07-1994.10	Hatchback Engine RFT(XU10J4/Z)/RFY(XU10J4/Z)	•		GWB0915	
	1992.07-1994.10	Hatchback Engine RFT(XU10J4/Z)/RFY(XU10J4/Z)		◦	GHA225009	A
	1992.07-1994.10	Hatchback Engine RFT(XU10J4/Z)/RFY(XU10J4/Z)		◦	GWB0961	
2.0 i 16V (114 kW)	1992.07-1997.10	Hatchback Engine RFT(XU10J4/Z)/RFY(XU10J4/Z)	•		GHA425022	
	1992.07-1997.10	Hatchback Engine RFT(XU10J4/Z)/RFY(XU10J4/Z)	•		GWB0915	
	1992.07-1997.10	Hatchback Engine RFT(XU10J4/Z)/RFY(XU10J4/Z)		◦	GHA225009	A
	1992.07-1997.10	Hatchback Engine RFT(XU10J4/Z)/RFY(XU10J4/Z)		◦	GWB0961	
2.0 i 16V (120 kW)	1996.05-1997.06	Hatchback Engine RFS(XU10J4RS)	•		GHA425022	
	1996.05-1997.06	Hatchback Engine RFS(XU10J4RS)	•		GWB0915	
	1996.05-1997.06	Hatchback Engine RFS(XU10J4RS)		◦	GHA225009	A
	1996.05-1997.06	Hatchback Engine RFS(XU10J4RS)		◦	GWB0961	
DACIA						
DOKKER						
1.2 TCE (85 kW)	2012.11-	Estate Engine H5F402		◦	GWB6799	
1.5 DCi (55 kW)	2012.11-	Estate Engine K9K612		◦	GWB6799	
1.5 DCi (66 kW)	2012.11-	Estate		◦	GWB6799	
1.6 16V (61 kW)	2012.11-	Estate		◦	GWB6799	
1.6 LPG (61 kW)	2013.11-	Estate Engine K7M 812/K7M 828		◦	GWB6799	
DOKKER EXPRESS						
1.2 TCE (84 kW)	2012.12-	Box Engine H5F402		◦	GWB6799	
1.5 DCi (55 kW)	2012.12-	Box Engine K9K612		◦	GWB6799	
1.5 DCi (66 kW)	2012.12-	Box		◦	GWB6799	
1.6 16V (61 kW)	2012.12-	Box		◦	GWB6799	
1.6 LPG (61 kW)	2013.11-	Box Engine K7M 812/K7M 828		◦	GWB6799	
DUSTER						
1.2 TCe 125 (92 kW)	2013.10-	Closed Off-Road Vehicle		◦	GWB6799	
1.5 DCi (63 kW)	2010.04-	Closed Off-Road Vehicle Engine K9K796		◦	GWB6799	
1.5 DCi (66 kW)	2010.10-	Closed Off-Road Vehicle Engine K9K892		◦	GWB6799	
1.5 DCi (79 kW)	2010.06-	Closed Off-Road Vehicle Engine K9K896		◦	GWB6799	
1.5 DCi (80 kW)	2013.08-	Closed Off-Road Vehicle Engine K9K856		◦	GWB6799	
1.6 16V (77 kW)	2010.04-	Closed Off-Road Vehicle Engine K4M690/K4M696		◦	GWB6799	
1.6 16V Hi-Flex (77 kW)	2010.08-	Closed Off-Road Vehicle Engine K4M696		◦	GWB6799	
1.6 16V LPG (77 kW)	2011.04-	Closed Off-Road Vehicle Engine K4M696		◦	GWB6799	
LODGY						
1.2 TCE (85 kW)	2012.03-	Estate Engine H5F402		◦	GWB6799	
1.5 DCi (66 kW)	2012.03-	Estate		◦	GWB6799	
1.5 DCi (79 kW)	2010.06-	Estate		◦	GWB6799	
1.6 (61 kW)	2012.03-	Estate Engine K7MA8		◦	GWB6799	
1.6 LPG (61 kW)	2013.11-	Estate Engine K7M 812/K7M 828		◦	GWB6799	
LOGAN (LS_)						
1.2 16V (55 kW)	2006.02-	Saloon Engine D4F732	•		GHA421012	
	2006.02-	Saloon Engine D4F732	•		GWB3596	
	2006.02-	Saloon Engine D4F732	•		GWB3637	
	2006.02-	Saloon Engine D4F732	•		GWB6561	
	2006.02-	Saloon Engine D4F732		◦	GWB3525	
	2006.02-	Saloon Engine D4F732		◦	GWB6658	
1.2 16V LPG (55 kW)	2006.02-	Saloon	•		GWB3596	



	 YEAR		F	R	G-AP Ref.	KIT
DACIA						
LOGAN (LS_)						
1.2 16V LPG (55 kW)	2006.02-	Saloon	•		GWB3637	
	2006.02-	Saloon	•		GWB6561	
	2006.02-	Saloon		○	GWB3525	
	2006.02-	Saloon		○	GWB6658	
1.4 (55 kW)	2004.09-	Saloon Engine K7J710	•		GHA421012	
	2004.09-	Saloon Engine K7J710	•		GWB3596	
	2004.09-	Saloon Engine K7J710	•		GWB3637	
	2004.09-	Saloon Engine K7J710	•		GWB6561	
	2004.09-	Saloon Engine K7J710		○	GWB3525	
	2004.09-	Saloon Engine K7J710		○	GWB6658	
1.4 MPI LPG (55 kW)	2006.02-	Saloon Engine K7J710/K7J714	•		GHA421012	
	2006.02-	Saloon Engine K7J710/K7J714	•		GWB3596	
	2006.02-	Saloon Engine K7J710/K7J714	•		GWB3637	
	2006.02-	Saloon Engine K7J710/K7J714	•		GWB6561	
	2006.02-	Saloon Engine K7J710/K7J714		○	GWB3525	
	2006.02-	Saloon Engine K7J710/K7J714		○	GWB6658	
1.5 DCi (48 kW)	2005.09-	Saloon Engine K9K790	•		GHA423003	K
	2005.09-	Saloon Engine K9K790	•		GWB3596	
	2005.09-	Saloon Engine K9K790	•		GWB3637	
	2005.09-	Saloon Engine K9K790	•		GWB6561	
	2005.09-	Saloon Engine K9K790		○	GWB3525	
	2005.09-	Saloon Engine K9K790		○	GWB6658	
1.5 DCi (50 kW)	2006.01-	Saloon Engine K9K792	•		GHA423003	K
	2006.01-	Saloon Engine K9K792	•		GWB3596	
	2006.01-	Saloon Engine K9K792	•		GWB3637	
	2006.01-	Saloon Engine K9K792	•		GWB6561	
	2006.01-	Saloon Engine K9K792		○	GWB3525	
	2006.01-	Saloon Engine K9K792		○	GWB6658	
1.5 DCi (55 kW)	2010.05-	Saloon Engine K9K892	•		GWB3596	
	2010.05-	Saloon Engine K9K892	•		GWB3637	
	2010.05-	Saloon Engine K9K892		○	GWB3525	
	2010.05-	Saloon Engine K9K892		○	GWB6658	
1.5 DCi (63 kW)	2007.09-	Saloon Engine K9K796	•		GHA423003	K
	2007.09-	Saloon Engine K9K796	•		GWB3596	
	2007.09-	Saloon Engine K9K796	•		GWB3637	
	2007.09-	Saloon Engine K9K796		○	GWB3525	
	2007.09-	Saloon Engine K9K796		○	GWB6658	
1.5 DCi (65 kW)	2010.05-	Saloon Engine K9K892	•		GWB3596	
	2010.05-	Saloon Engine K9K892	•		GWB3637	
	2010.05-	Saloon Engine K9K892		○	GWB3525	
	2010.05-	Saloon Engine K9K892		○	GWB6658	
1.6 (64 kW)	2004.09-	Saloon Engine K7M710	•		GHA421012	
	2004.09-	Saloon Engine K7M710	•		GWB3596	
	2004.09-	Saloon Engine K7M710	•		GWB3637	
	2004.09-	Saloon Engine K7M710	•		GWB6561	
	2004.09-	Saloon Engine K7M710		○	GWB3525	
	2004.09-	Saloon Engine K7M710		○	GWB6658	
1.6 16V (77 kW)	2006.02-	Saloon Engine K4M690/K4M696	•		GHA423003	K
	2006.02-	Saloon Engine K4M690/K4M696	•		GWB3596	
	2006.02-	Saloon Engine K4M690/K4M696	•		GWB3637	
	2006.02-	Saloon Engine K4M690/K4M696	•		GWB6561	
	2006.02-	Saloon Engine K4M690/K4M696		○	GWB3525	
	2006.02-	Saloon Engine K4M690/K4M696		○	GWB6658	
1.6 16V FlexFuel (77 kW)	2010.07-	Saloon Engine K4M696	•		GWB3596	
	2010.07-	Saloon Engine K4M696	•		GWB3637	
	2010.07-	Saloon Engine K4M696		○	GWB3525	
	2010.07-	Saloon Engine K4M696		○	GWB6658	
1.6 Bifuel (62 kW)	2010.05-	Saloon Engine K7M718	•		GHA421012	
	2010.05-	Saloon Engine K7M718	•		GWB3596	
	2010.05-	Saloon Engine K7M718	•		GWB3637	
	2010.05-	Saloon Engine K7M718		○	GWB3525	
	2010.05-	Saloon Engine K7M718		○	GWB6658	
1.6 MPI (62 kW)	2010.05-	Saloon Engine K7M800	•		GWB3596	
	2010.05-	Saloon Engine K7M800	•		GWB3637	



	 YEAR		F	R	G-AP Ref.	KIT
DACIA						
LOGAN (LS_)						
1.6 MPI (62 kW)	2010.05-	Saloon Engine K7M800		o	GWB3525	
	2010.05-	Saloon Engine K7M800		o	GWB6658	
LOGAN (US_)						
1.4 (55 kW)	2009.01-	Pickup Engine K7J710	•		GWB3596	
	2009.01-	Pickup Engine K7J710	•		GWB3637	
	2009.01-	Pickup Engine K7J710		o	GWB3525	
	2009.01-	Pickup Engine K7J710		o	GWB6658	
1.5 DCi (50 kW)	2008.03-	Pickup Engine K9K792	•		GHA423003	K
	2008.03-	Pickup Engine K9K792	•		GWB3596	
	2008.03-	Pickup Engine K9K792	•		GWB3637	
	2008.03-	Pickup Engine K9K792		o	GWB3525	
	2008.03-	Pickup Engine K9K792		o	GWB6658	
1.5 DCi (55 kW)	2010.05-	Pickup Engine K9K892	•		GWB3596	
	2010.05-	Pickup Engine K9K892	•		GWB3637	
	2010.05-	Pickup Engine K9K892		o	GWB3525	
	2010.05-	Pickup Engine K9K892		o	GWB6658	
1.5 DCi (63 kW)	2008.03-	Pickup Engine K9K796	•		GHA423003	K
	2008.03-	Pickup Engine K9K796	•		GWB3596	
	2008.03-	Pickup Engine K9K796	•		GWB3637	
	2008.03-	Pickup Engine K9K796		o	GWB3525	
	2008.03-	Pickup Engine K9K796		o	GWB6658	
1.5 DCi (65 kW)	2010.05-	Pickup Engine K9K892	•		GWB3596	
	2010.05-	Pickup Engine K9K892	•		GWB3637	
	2010.05-	Pickup Engine K9K892		o	GWB3525	
	2010.05-	Pickup Engine K9K892		o	GWB6658	
1.6 (64 kW)	2008.03-	Pickup Engine K7M710	•		GHA423003	K
	2008.03-	Pickup Engine K7M710	•		GWB3596	
	2008.03-	Pickup Engine K7M710	•		GWB3637	
	2008.03-	Pickup Engine K7M710		o	GWB3525	
	2008.03-	Pickup Engine K7M710		o	GWB6658	
1.6 Bifuel (62 kW)	2010.05-	Pickup Engine K7M800	•		GWB3596	
	2010.05-	Pickup Engine K7M800	•		GWB3637	
	2010.05-	Pickup Engine K7M800		o	GWB3525	
	2010.05-	Pickup Engine K7M800		o	GWB6658	
1.6 MPI (62 kW)	2010.05-	Pickup Engine K7M800	•		GWB3596	
	2010.05-	Pickup Engine K7M800	•		GWB3637	
	2010.05-	Pickup Engine K7M800		o	GWB3525	
	2010.05-	Pickup Engine K7M800		o	GWB6658	
LOGAN EXPRESS (FS_)						
1.4 (55 kW)	2009.03-	Box Engine K7J710	•		GHA423003	K
	2009.03-	Box Engine K7J710	•		GWB3596	
	2009.03-	Box Engine K7J710	•		GWB3637	
	2009.03-	Box Engine K7J710		o	GWB3525	
	2009.03-	Box Engine K7J710		o	GWB6658	
1.5 DCi (50 kW)	2009.03-	Box Engine K9K792	•		GHA423003	K
	2009.03-	Box Engine K9K792	•		GWB3596	
	2009.03-	Box Engine K9K792	•		GWB3637	
	2009.03-	Box Engine K9K792		o	GWB3525	
	2009.03-	Box Engine K9K792		o	GWB6658	
1.5 DCi (55 kW)	2010.05-	Box Engine K9K892	•		GWB3596	
	2010.05-	Box Engine K9K892	•		GWB3637	
	2010.05-	Box Engine K9K892		o	GWB3525	
	2010.05-	Box Engine K9K892		o	GWB6658	
1.5 DCi (63 kW)	2009.03-	Box Engine K9K796	•		GHA423003	K
	2009.03-	Box Engine K9K796	•		GWB3596	
	2009.03-	Box Engine K9K796	•		GWB3637	
	2009.03-	Box Engine K9K796		o	GWB3525	
	2009.03-	Box Engine K9K796		o	GWB6658	
1.5 DCi (65 kW)	2010.05-	Box Engine K9K892	•		GWB3596	
	2010.05-	Box Engine K9K892	•		GWB3637	
	2010.05-	Box Engine K9K892		o	GWB3525	
	2010.05-	Box Engine K9K892		o	GWB6658	
1.6 (64 kW)	2009.03-	Box Engine K7M710	•		GHA423003	K
	2009.03-	Box Engine K7M710	•		GWB3596	



	 YEAR		F	R	G-AP Ref.	KIT
DACIA						
LOGAN EXPRESS (FS_)						
1.6 (64 kW)	2009.03-	Box Engine K7M710	•		GWB3637	
	2009.03-	Box Engine K7M710		○	GWB3525	
	2009.03-	Box Engine K7M710		○	GWB6658	
1.6 MPI (62 kW)	2010.05-	Box Engine K7M800	•		GWB3596	
	2010.05-	Box Engine K7M800	•		GWB3637	
	2010.05-	Box Engine K7M800		○	GWB3525	
	2010.05-	Box Engine K7M800		○	GWB6658	
LOGAN II						
0.9 TCE (66 kW)	2012.10-	Saloon	•		GWB3596	
	2012.10-	Saloon	•		GWB3637	
	2012.10-	Saloon		○	GWB6658	
1.2 (55 kW)	2012.10-	Saloon	•		GWB3596	
	2012.10-	Saloon	•		GWB3637	
	2012.10-	Saloon		○	GWB6658	
1.2 LPG (55 kW)	2012.10-	Saloon Engine D4F734	•		GWB3596	
	2012.10-	Saloon Engine D4F734	•		GWB3637	
	2012.10-	Saloon Engine D4F734		○	GWB6658	
1.5 DCi (55 kW)	2012.10-	Saloon	•		GWB3596	
	2012.10-	Saloon	•		GWB3637	
	2012.10-	Saloon		○	GWB6658	
1.5 DCi (63 kW)	2013.01-	Saloon	•		GWB3596	
	2013.01-	Saloon	•		GWB3637	
	2013.01-	Saloon		○	GWB6658	
1.5 DCi (66 kW)	2012.10-	Saloon Engine K9K612	•		GWB3596	
	2012.10-	Saloon Engine K9K612	•		GWB3637	
	2012.10-	Saloon Engine K9K612		○	GWB6658	
1.6 16V (77 kW)	2013.01-	Saloon	•		GWB3596	
	2013.01-	Saloon	•		GWB3637	
	2013.01-	Saloon		○	GWB6658	
LOGAN MCV (KS_)						
1.4 (55 kW)	2007.02-	Estate Engine K7J710	•		GWB3596	
	2007.02-	Estate Engine K7J710	•		GWB3637	
	2007.02-	Estate Engine K7J710	•		GWB6561	
	2007.02-	Estate Engine K7J710		○	GWB3525	
	2007.02-	Estate Engine K7J710		○	GWB6658	
1.5 DCi (50 kW)	2007.02-	Estate Engine K9K792	•		GHA423003	K
	2007.02-	Estate Engine K9K792	•		GWB3596	
	2007.02-	Estate Engine K9K792	•		GWB3637	
	2007.02-	Estate Engine K9K792	•		GWB6561	
	2007.02-	Estate Engine K9K792		○	GWB3525	
	2007.02-	Estate Engine K9K792		○	GWB6658	
1.5 DCi (55 kW)	2010.05-	Estate Engine K9K892	•		GWB3596	
	2010.05-	Estate Engine K9K892	•		GWB3637	
	2010.05-	Estate Engine K9K892		○	GWB3525	
	2010.05-	Estate Engine K9K892		○	GWB6658	
1.5 DCi (63 kW)	2007.09-	Estate Engine K9K796	•		GHA423003	K
	2007.09-	Estate Engine K9K796	•		GWB3596	
	2007.09-	Estate Engine K9K796	•		GWB3637	
	2007.09-	Estate Engine K9K796		○	GWB3525	
	2007.09-	Estate Engine K9K796		○	GWB6658	
	2007.09-	Estate Engine K9K796		○	GWB6658	
1.5 DCi (65 kW)	2010.05-	Estate Engine K9K892	•		GWB3596	
	2010.05-	Estate Engine K9K892	•		GWB3637	
	2010.05-	Estate Engine K9K892		○	GWB3525	
	2010.05-	Estate Engine K9K892		○	GWB6658	
1.6 (64 kW)	2007.02-	Estate Engine K7M710	•		GWB3596	
	2007.02-	Estate Engine K7M710	•		GWB3637	
	2007.02-	Estate Engine K7M710	•		GWB6561	
	2007.02-	Estate Engine K7M710		○	GWB3525	
	2007.02-	Estate Engine K7M710		○	GWB6658	
1.6 16V (77 kW)	2007.02-	Estate Engine K4M690/K4M696	•		GHA423003	K
	2007.02-	Estate Engine K4M690/K4M696	•		GWB3596	
	2007.02-	Estate Engine K4M690/K4M696	•		GWB3637	
	2007.02-	Estate Engine K4M690/K4M696	•		GWB6561	
	2007.02-	Estate Engine K4M690/K4M696		○	GWB3525	



	 YEAR		F	R	G-AP Ref.	KIT
DACIA						
LOGAN MCV (KS_)						
1.6 16V (77 kW)	2007.02-	Estate Engine K4M690/K4M696		o	GWB6658	
1.6 16V Hi-Flex (77 kW)	2009.11-	Estate Engine K4M690/K4M694	•		GWB3596	
	2009.11-	Estate Engine K4M690/K4M694	•		GWB3637	
	2009.11-	Estate Engine K4M690/K4M694		o	GWB3525	
	2009.11-	Estate Engine K4M690/K4M694		o	GWB6658	
1.6 Bifuel (64 kW)	2008.11-	Estate Engine K7M710	•		GWB3596	
	2008.11-	Estate Engine K7M710	•		GWB3637	
	2008.11-	Estate Engine K7M710		o	GWB3525	
	2008.11-	Estate Engine K7M710		o	GWB6658	
1.6 MPI (62 kW)	2010.05-	Estate Engine K7M800	•		GWB3596	
	2010.05-	Estate Engine K7M800	•		GWB3637	
	2010.05-	Estate Engine K7M800		o	GWB3525	
	2010.05-	Estate Engine K7M800		o	GWB6658	
LOGAN MCV II						
0.9 TCE (66 kW)	2013.02-	Estate	•		GWB3596	
	2013.02-	Estate	•		GWB3637	
	2013.02-	Estate		o	GWB6658	
1.2 (55 kW)	2013.02-	Estate	•		GWB3596	
	2013.02-	Estate	•		GWB3637	
	2013.02-	Estate		o	GWB6658	
1.2 LPG (55 kW)	2013.02-	Estate	•		GWB3596	
	2013.02-	Estate	•		GWB3637	
	2013.02-	Estate		o	GWB6658	
1.5 DCi (55 kW)	2013.02-	Estate Engine K9K612	•		GWB3596	
	2013.02-	Estate Engine K9K612	•		GWB3637	
	2013.02-	Estate Engine K9K612		o	GWB6658	
1.5 DCi (63 kW)	2013.02-	Estate Engine K9K 830	•		GWB3596	
	2013.02-	Estate Engine K9K 830	•		GWB3637	
	2013.02-	Estate Engine K9K 830		o	GWB6658	
1.5 DCi (66 kW)	2013.02-	Estate Engine K9K612	•		GWB3596	
	2013.02-	Estate Engine K9K612	•		GWB3637	
	2013.02-	Estate Engine K9K612		o	GWB6658	
NOVA						
1.4 (48 kW)	1996.04-2001.03	Hatchback Engine C2J	•		GWB3496	
	1996.04-2001.03	Hatchback Engine C2J		o	GWB0961	
1.6 (53 kW)	1996.04-2003.03	Hatchback	•		GWB3496	
	1996.04-2003.03	Hatchback		o	GWB0961	
SANDERO						
1.2 16V (55 kW)	2008.11-	Hatchback Engine D4F732	•		GHA421012	
	2008.11-	Hatchback Engine D4F732	•		GWB3596	
	2008.11-	Hatchback Engine D4F732	•		GWB3637	
	2008.11-	Hatchback Engine D4F732		o	GWB3525	
	2008.11-	Hatchback Engine D4F732		o	GWB6658	
1.2 16V LPG (55 kW)	2008.11-	Hatchback Engine D4F732	•		GWB3596	
	2008.11-	Hatchback Engine D4F732	•		GWB3637	
	2008.11-	Hatchback Engine D4F732		o	GWB3525	
	2008.11-	Hatchback Engine D4F732		o	GWB6658	
1.4 (55 kW)	2008.06-	Hatchback Engine K7J710	•		GHA421012	
	2008.06-	Hatchback Engine K7J710	•		GWB3596	
	2008.06-	Hatchback Engine K7J710	•		GWB3637	
	2008.06-	Hatchback Engine K7J710		o	GWB3525	
	2008.06-	Hatchback Engine K7J710		o	GWB6658	
1.4 MPI LPG (53 kW)	2009.01-	Hatchback Engine K7J714	•		GHA421012	
	2009.01-	Hatchback Engine K7J714	•		GWB3596	
	2009.01-	Hatchback Engine K7J714	•		GWB3637	
	2009.01-	Hatchback Engine K7J714		o	GWB3525	
	2009.01-	Hatchback Engine K7J714		o	GWB6658	
1.5 DCi (50 kW)	2008.11-	Hatchback Engine K9K792	•		GHA423003	K
	2008.11-	Hatchback Engine K9K792	•		GWB3596	
	2008.11-	Hatchback Engine K9K792	•		GWB3637	
	2008.11-	Hatchback Engine K9K792		o	GWB3525	
	2008.11-	Hatchback Engine K9K792		o	GWB6658	
1.5 DCi (55 kW)	2010.05-	Hatchback Engine K9K892	•		GWB3596	
	2010.05-	Hatchback Engine K9K892	•		GWB3637	



	 YEAR		F	R	G-AP Ref.	KIT
DACIA						
SANDERO						
1.5 DCi (55 kW)	2010.05-	Hatchback Engine K9K892		o	GWB3525	
	2010.05-	Hatchback Engine K9K892		o	GWB6658	
1.5 DCi (63 kW)	2008.11-	Hatchback Engine K9K796	•		GHA423003	K
	2008.11-	Hatchback Engine K9K796	•		GWB3596	
	2008.11-	Hatchback Engine K9K796	•		GWB3637	
	2008.11-	Hatchback Engine K9K796		o	GWB3525	
	2008.11-	Hatchback Engine K9K796		o	GWB6658	
1.5 DCi (65 kW)	2010.05-	Hatchback Engine K9K892	•		GWB3596	
	2010.05-	Hatchback Engine K9K892	•		GWB3637	
	2010.05-	Hatchback Engine K9K892		o	GWB3525	
	2010.05-	Hatchback Engine K9K892		o	GWB6658	
1.6 (64 kW)	2008.06-	Hatchback Engine K7M710	•		GHA421012	
	2008.06-	Hatchback Engine K7M710	•		GWB3596	
	2008.06-	Hatchback Engine K7M710	•		GWB3637	
	2008.06-	Hatchback Engine K7M710		o	GWB3525	
	2008.06-	Hatchback Engine K7M710		o	GWB6658	
1.6 16V (77 kW)	2011.07-	Hatchback Engine K4M690	•		GWB3596	
	2011.07-	Hatchback Engine K4M690	•		GWB3637	
	2011.07-	Hatchback Engine K4M690		o	GWB3525	
	2011.07-	Hatchback Engine K4M690		o	GWB6658	
1.6 16V Bifuel (77 kW)	2011.01-	Hatchback Engine K4M690/K4M696/K4M694	•		GWB3596	
	2011.01-	Hatchback Engine K4M690/K4M696/K4M694	•		GWB3637	
	2011.01-	Hatchback Engine K4M690/K4M696/K4M694		o	GWB3525	
	2011.01-	Hatchback Engine K4M690/K4M696/K4M694		o	GWB6658	
1.6 MPI (62 kW)	2010.05-	Hatchback Engine K7M800	•		GWB3596	
	2010.05-	Hatchback Engine K7M800	•		GWB3637	
	2010.05-	Hatchback Engine K7M800		o	GWB3525	
	2010.05-	Hatchback Engine K7M800		o	GWB6658	
SANDERO II						
0.9 TCE (66 kW)	2013.01-	Hatchback	•		GWB3596	
	2013.01-	Hatchback	•		GWB3637	
	2013.01-	Hatchback		o	GWB6658	
1.2 (55 kW)	2013.01-	Hatchback Engine D4F732	•		GWB3596	
	2013.01-	Hatchback Engine D4F732	•		GWB3637	
	2013.01-	Hatchback Engine D4F732		o	GWB6658	
1.2 LPG (55 kW)	2013.01-	Hatchback	•		GWB3596	
	2013.01-	Hatchback	•		GWB3637	
	2013.01-	Hatchback		o	GWB6658	
1.5 DCi (55 kW)	2013.01-	Hatchback Engine K9K612	•		GWB3596	
	2013.01-	Hatchback Engine K9K612	•		GWB3637	
	2013.01-	Hatchback Engine K9K612		o	GWB6658	
1.5 DCi (63 kW)	2013.01-	Hatchback	•		GWB3596	
	2013.01-	Hatchback	•		GWB3637	
	2013.01-	Hatchback		o	GWB6658	
1.5 DCi (66 kW)	2013.01-	Hatchback Engine K9K612	•		GWB3596	
	2013.01-	Hatchback Engine K9K612	•		GWB3637	
	2013.01-	Hatchback Engine K9K612		o	GWB6658	
1.6 16V (77 kW)	2013.01-	Hatchback Engine K4M 694/K4M 842/K4M 845	•		GWB3596	
	2013.01-	Hatchback Engine K4M 694/K4M 842/K4M 845	•		GWB3637	
	2013.01-	Hatchback Engine K4M 694/K4M 842/K4M 845		o	GWB6658	
SOLENZA						
1.4 (55 kW)	2003.02-	Hatchback Engine K7J710	•		GWB3496	
	2003.02-	Hatchback Engine K7J710		o	GWB0961	
1.9 D (46 kW)	2003.02-	Hatchback Engine F8Q630	•		GWB3496	
	2003.02-	Hatchback Engine F8Q630		o	GWB0961	
SUPERNOVA						
1.4 (55 kW)	2000.04-2003.03	Hatchback	•		GWB3496	
	2000.04-2003.03	Hatchback		o	GWB0961	
DAEWOO						
CIELO						
1.5 (66 kW)	1994.06-1998.07	Saloon Engine V15L	•		GWB3256	
	1994.06-1998.07	Saloon Engine V15L	•		GWB3257	
	1994.06-1998.07	Saloon Engine V15L		o	GWB3255	



	 YEAR		F	R	G-AP Ref.	KIT
DAEWOO						
ESPERO (KLEJ)						
1.5 16V (65 kW)	1993.10-1994.09	Saloon Engine A15MF	•		GWB3257	
	1993.10-1994.09	Saloon Engine A15MF		◦	GWB3255	
1.5 16V (66 kW)	1995.02-1999.06	Saloon Engine A15MF	•		GWB3257	
	1995.02-1999.06	Saloon Engine A15MF		◦	GWB3255	
1.8 (66 kW)	1995.02-1999.09	Saloon Engine C18LE	•		GWB3257	
	1995.02-1999.09	Saloon Engine C18LE		◦	GWB3255	
1.8 (70 kW)	1995.02-1999.06	Saloon Engine C18LE	•		GWB3257	
	1995.02-1999.06	Saloon Engine C18LE		◦	GWB3255	
2.0 (74 kW)	1991.10-1993.09	Saloon Engine C20LZ	•		GWB3257	
	1991.10-1993.09	Saloon Engine C20LZ		◦	GWB3255	
2.0 (77 kW)	1995.02-1999.06	Saloon Engine C20LE	•		GWB3257	
	1995.02-1999.06	Saloon Engine C20LE		◦	GWB3255	
2.0 (81 kW)	1993.10-1994.09	Saloon Engine C20LE	•		GWB3257	
	1993.10-1994.09	Saloon Engine C20LE		◦	GWB3255	
EVANDA (KLAL)						
2.0 (96 kW)	2002.08-	Saloon Engine L88/X20SED		◦	GHA400085	
	2002.08-	Saloon Engine L88/X20SED With ABS	•		GHA328003	K
	2002.08-	Saloon Engine L88/X20SED With ABS		◦	GHA400049	
KALOS (KLAS)						
1.2 (53 kW)	2003.04-	Hatchback Engine B12S1/F12S3	•		GWB3786	
	2003.04-	Hatchback Engine B12S1/F12S3		◦	GWB7573	
	2003.04-	Hatchback Engine B12S1/F12S3 With ABS		◦	GHA225021	K
	2003.04-	Hatchback Engine B12S1/F12S3 Without ABS		◦	GHA225025	K
1.4 (61 kW)	2002.09-	Hatchback Engine F14S3	•		GWB3786	
	2002.09-	Hatchback Engine F14S3		◦	GWB7573	
	2002.09-	Hatchback Engine F14S3 With ABS		◦	GHA225021	K
	2002.09-	Hatchback Engine F14S3 Without ABS		◦	GHA225025	K
	2002.11-2004.12	Saloon Engine F14S3	•		GWB3786	
	2002.11-2004.12	Saloon Engine F14S3		◦	GWB7573	
	2002.11-2004.12	Saloon Engine F14S3 With ABS		◦	GHA225021	K
	2002.11-2004.12	Saloon Engine F14S3 Without ABS		◦	GHA225025	K
1.4 (69 kW)	2003.05-2004.12	Saloon Engine F14D3	•		GWB3786	
	2003.05-2004.12	Saloon Engine F14D3		◦	GWB7573	
	2003.05-2004.12	Saloon Engine F14D3 With ABS		◦	GHA225021	K
	2003.05-2004.12	Saloon Engine F14D3 Without ABS		◦	GHA225025	K
1.4 16V (69 kW)	2003.04-	Hatchback Engine F14D3	•		GWB3786	
	2003.04-	Hatchback Engine F14D3		◦	GWB7573	
	2003.04-	Hatchback Engine F14D3 With ABS		◦	GHA225021	K
	2003.04-	Hatchback Engine F14D3 Without ABS		◦	GHA225025	K
1.5 (62 kW)	2002.11-2004.12	Saloon Engine F15S	•		GWB3786	
	2002.11-2004.12	Saloon Engine F15S		◦	GWB7573	
	2002.11-2004.12	Saloon Engine F15S With ABS		◦	GHA225021	K
	2002.11-2004.12	Saloon Engine F15S Without ABS		◦	GHA225025	K
LACETTI (J200)						
1.8 CDX (J200) (67 kW)	2003.8-2004.12	Saloon Engine F18D2	•		GWB3902	
	2003.8-2004.12	Saloon Engine F18D2 With ABS		◦	GHA400049	
	2003.8-2004.12	Saloon Engine F18D2 Without ABS		◦	GHA400091	K
LACETTI (KLAN)						
1.4 (70 kW)	2004.03-2005.04	Hatchback Engine F14D3	•		GWB3902	
	2004.03-2005.04	Hatchback Engine F14D3 With ABS		◦	GHA400049	
	2004.03-2005.04	Hatchback Engine F14D3 Without ABS		◦	GHA400091	K
1.6 (80 kW)	2004.03-2005.04	Hatchback Engine F16D3	•		GWB3902	
	2004.03-2005.04	Hatchback Engine F16D3 With ABS		◦	GHA400049	
	2004.03-2005.04	Hatchback Engine F16D3 Without ABS		◦	GHA400091	K
1.8 (90 kW)	2004.02-	Hatchback Engine T18SED	•		GWB3902	
	2004.02-	Hatchback Engine T18SED With ABS		◦	GHA400049	
	2004.02-	Hatchback Engine T18SED Without ABS		◦	GHA400091	K
LANOS (KLAT)						
1.4 (55 kW)	1997.05-	Hatchback Engine A14SMS	•		GWB3786	
	1997.05-	Hatchback Engine A14SMS		◦	GWB3255	
	1997.05-	Saloon Engine A14SMS	•		GWB3786	
	1997.05-	Saloon Engine A14SMS		◦	GWB3255	
1.5 (63 kW)	1997.05-	Hatchback Engine A15SMS	•		GWB3785	



	 YEAR		F	R	G-AP Ref.	KIT
DAEWOO						
LANOS (KLAT)						
1.5 (63 kW)	1997.05-	Hatchback Engine A15SMS	•		GWB3786	
	1997.05-	Hatchback Engine A15SMS		○	GWB3255	
	1997.05-	Saloon Engine A15SMS	•		GWB3785	
	1997.05-	Saloon Engine A15SMS	•		GWB3786	
	1997.05-	Saloon Engine A15SMS		○	GWB3255	
1.5 (73 kW)	1997.10-1999.06	Hatchback Engine A15SMS	•		GWB3785	
	1997.10-1999.06	Hatchback Engine A15SMS	•		GWB3786	
	1997.10-1999.06	Hatchback Engine A15SMS		○	GWB3255	
1.6 16V (78 kW)	1997.05-	Hatchback Engine A16DMS	•		GWB3785	
	1997.05-	Hatchback Engine A16DMS		○	GWB3255	
	1997.05-	Saloon Engine A16DMS	•		GWB3785	
	1997.05-	Saloon Engine A16DMS		○	GWB3255	
LEGANZA (KLAV)						
2.0 16V (93 kW)	2000.03-2002.11	Saloon Engine T20SED	•		GWB3902	
	2000.03-2002.11	Saloon Engine T20SED		○	GHA230131	
	2000.03-2002.11	Saloon Engine T20SED With ABS		○	GHA230123	K
2.0 16V (98 kW)	1997.06-2002.12	Saloon Engine X20SED	•		GWB3902	
	1997.06-2002.12	Saloon Engine X20SED		○	GHA230131	
	1997.06-2002.12	Saloon Engine X20SED With ABS		○	GHA230123	K
2.2 16V (100 kW)	1999.04-2002.12	Saloon Engine T22SED	•		GWB3902	
	1999.04-2002.12	Saloon Engine T22SED		○	GHA230131	
	1999.04-2002.12	Saloon Engine T22SED With ABS		○	GHA230123	K
MATIZ (KLYA)						
0.8 (38 kW)	1998.09-	Hatchback Engine F8CV	•		GHA423010	
	1998.09-	Hatchback Engine F8CV	•		GWB3901	
	1998.09-	Hatchback Engine F8CV		○	GWB3796	
1.0 (47 kW)	2003.01-	Hatchback Engine B10S	•		GHA423010	
	2003.01-	Hatchback Engine B10S	•		GWB3901	
	2003.01-	Hatchback Engine B10S		○	GWB3796	
NEXIA (KLETN)						
1.5 (52 kW)	1995.02-1997.08	Hatchback Engine G15MF	•		GWB3256	
	1995.02-1997.08	Hatchback Engine G15MF	•		GWB3257	
	1995.02-1997.08	Hatchback Engine G15MF		○	GWB3255	
	1995.02-1997.08	Hatchback Engine G15MF		○	GWB0663	
	1995.02-1997.08	Saloon Engine G15MF	•		GWB3256	
	1995.02-1997.08	Saloon Engine G15MF	•		GWB3257	
	1995.02-1997.08	Saloon Engine G15MF		○	GWB3255	
	1995.02-1997.08	Saloon Engine G15MF		○	GWB0663	
1.5 (55 kW)	1995.02-1997.08	Hatchback Engine G15MF	•		GWB3256	
	1995.02-1997.08	Hatchback Engine G15MF	•		GWB3257	
	1995.02-1997.08	Hatchback Engine G15MF		○	GWB3255	
	1995.02-1997.08	Hatchback Engine G15MF		○	GWB0663	
	1995.02-1997.08	Saloon Engine G15MF	•		GWB3256	
	1995.02-1997.08	Saloon Engine G15MF	•		GWB3257	
	1995.02-1997.08	Saloon Engine G15MF		○	GWB3255	
	1995.02-1997.08	Saloon Engine G15MF		○	GWB0663	
1.5 16V (66 kW)	1995.02-1997.08	Hatchback Engine A15MF	•		GWB3256	
	1995.02-1997.08	Hatchback Engine A15MF	•		GWB3257	
	1995.02-1997.08	Hatchback Engine A15MF		○	GWB3255	
	1995.02-1997.08	Hatchback Engine A15MF		○	GWB0663	
	1995.02-1997.08	Saloon Engine A15MF	•		GWB3256	
	1995.02-1997.08	Saloon Engine A15MF	•		GWB3257	
	1995.02-1997.08	Saloon Engine A15MF		○	GWB3255	
	1995.02-1997.08	Saloon Engine A15MF		○	GWB0663	
NUBIRA						
-			•		GHA433001	
NUBIRA (KLAJ)						
1.6 16V (76 kW)	1999.07-2002.11	Saloon Engine A16DMS	•		GWB3785	
	1999.07-2002.11	Saloon Engine A16DMS		○	GWB3255	
1.6 16V (78 kW)	1997.05-	Hatchback Engine A16DMS	•		GWB3785	
	1997.05-	Hatchback Engine A16DMS		○	GWB3255	
	1997.05-	Saloon Engine A16DMS	•		GWB3785	
	1997.05-	Saloon Engine A16DMS		○	GWB3255	



	 YEAR		F	R	G-AP Ref.	KIT
DAEWOO						
NUBIRA (KLAJ)						
2.0 (81 kW)	1999.06-2003.07	Saloon Engine C20SED	•		GWB3785	
	1999.06-2003.07	Saloon Engine C20SED		◦	GWB3255	
2.0 16V (93 kW)	2000.12-	Saloon Engine T20SED	•		GWB3785	
	2000.12-	Saloon Engine T20SED		◦	GWB3255	
2.0 16V (98 kW)	1997.05-	Hatchback Engine X20SED	•		GWB3785	
	1997.05-	Hatchback Engine X20SED		◦	GWB3255	
	1997.05-	Saloon Engine X20SED	•		GWB3785	
	1997.05-	Saloon Engine X20SED		◦	GWB3255	
NUBIRA (KLAN)						
1.4 (69 kW)	2003.10-2004.12	Saloon Engine F14D3	•		GWB3902	
	2003.10-2004.12	Saloon Engine F14D3 With ABS		◦	GHA400049	
1.6 (80 kW)	2003.07-	Saloon Engine F16D3	•		GWB3902	
	2003.07-	Saloon Engine F16D3		◦	GHA400085	
	2003.07-	Saloon Engine F16D3 With ABS		◦	GHA400049	
1.8 (90 kW)	2003.07-	Saloon Engine T18SED	•		GWB3902	
	2003.07-	Saloon Engine T18SED		◦	GHA400085	
	2003.07-	Saloon Engine T18SED With ABS		◦	GHA400049	
NUBIRA WAGON (KLAJ)						
1.6 16V (66 kW)	1997.06-	Estate	•		GWB3785	
	1997.06-	Estate		◦	GWB3255	
1.6 16V (76 kW)	1999.07-2002.11	Estate Engine A16DMS	•		GWB3785	
	1999.07-2002.11	Estate Engine A16DMS		◦	GWB3255	
1.6 16V (78 kW)	1997.05-	Estate Engine A16DMS	•		GWB3785	
	1997.05-	Estate Engine A16DMS		◦	GWB3255	
2.0 16V (93 kW)	2000.12-	Estate Engine T20SED	•		GWB3785	
	2000.12-	Estate Engine T20SED		◦	GWB3255	
2.0 16V (98 kW)	1997.05-	Estate Engine X20SED	•		GWB3785	
	1997.05-	Estate Engine X20SED		◦	GWB3255	
NUBIRA WAGON (KLAN)						
1.6 (80 kW)	2003.07-	Estate Engine F16D3	•		GWB3902	
	2003.07-	Estate Engine F16D3		◦	GHA400085	
	2003.07-	Estate Engine F16D3 With ABS		◦	GHA400049	
1.8 (90 kW)	2003.07-	Estate Engine T18SED	•		GWB3902	
	2003.07-	Estate Engine T18SED		◦	GHA400085	
	2003.07-	Estate Engine T18SED With ABS		◦	GHA400049	
TACUMA (KLAU)						
1.6 (77 kW)	2000.09-	MPV Engine A16DMS	•		GWB3902	
	2000.09-	MPV Engine A16DMS		◦	GHA230119	K
1.6 SX (66 kW)	2001.08-2004.12	MPV Engine A16SMS	•		GWB3902	
	2001.08-2004.12	MPV Engine A16SMS		◦	GHA230119	K
1.8 (67 kW)	2000.09-	MPV Engine F18D2	•		GWB3902	
	2000.09-	MPV Engine F18D2		◦	GHA230119	K
1.8 (72 kW)	2000.09-	MPV Engine A18DMS	•		GWB3902	
	2000.09-	MPV Engine A18DMS		◦	GHA230119	K
1.8 (74 kW)	2000.09-	MPV Engine F18S2	•		GWB3902	
	2000.09-	MPV Engine F18S2		◦	GHA230119	K
2.0 (89 kW)	2001.09-	MPV Engine X20SED	•		GWB3902	
	2001.09-	MPV Engine X20SED		◦	GHA230119	K
2.0 (94 kW)	2000.09-	MPV Engine T20SED	•		GWB3902	
	2000.09-	MPV Engine T20SED		◦	GHA230119	K
TICO (KLY3)						
0.8 (35 kW)	1995.02-2000.12	Hatchback Engine F8C	•		GWB3797	
	1995.02-2000.12	Hatchback Engine F8C		◦	GWB1931	
DAIHATSU						
APPLAUSE II (A101)						
1.6 16V (73 kW)	1997.07-2000.05	Saloon Engine HD-E	•		GWB6967	
	1997.07-2000.05	Saloon Engine HD-E		◦	GWB6966	
BEGO						
1.3 DVVT 4x4 (63 kW)	2005.11-	Closed Off-Road Vehicle Engine K3-VE	•		GWB6967	
	2005.11-	Closed Off-Road Vehicle Engine K3-VE	•		GWB7549	
CHARADE						
1.33 16V (73 kW)	2011.05-	Hatchback Engine 1NR-FE	•		GWB6878	



	 YEAR		F	R	G-AP Ref.	KIT
DAIHATSU						
CHARADE						
1.33 16V (73 kW)	2011.05-	Hatchback Engine 1NR-FE With ABS		o	GHA400087	K
CHARADE (L2_)						
1.0 (43 kW)	2003.03-2006.06	Hatchback Engine EJ-VE	•		GWB6966	
CHARADE III (G100, G101, G102)						
1.0 (40 kW)	1990.11-1992.12	Hatchback Engine CB90	•		GWB6967	
CHARADE III (G102)						
1.3 (66 kW)	1990.11-1993.02	Saloon Engine HCE	•		GWB6967	
CHARADE IV (G200, G202)						
1.0 (38 kW)	1994.09-1996.03	Hatchback Engine CB 22	•		GWB6967	
1.3 (44 kW)	1996.09-1999.11	Hatchback Engine HC	•		GWB6967	
1.3 16V (55 kW)	1996.05-1999.11	Hatchback Engine HCE	•		GWB6967	
1.3 i 16V (62 kW)	1993.01-2000.09	Hatchback Engine HC/HCE	•		GWB6967	
1.5 HG (55 kW)	1994.06-1996.03	Hatchback Engine HEE/HEEG	•		GWB6967	
1.5 i 16V (66 kW)	1997.01-1999.11	Hatchback Engine HEE	•		GWB6967	
1.6 GTi (77 kW)	1993.03-1999.11	Hatchback Engine HD-E	•		GWB6967	
CHARADE IV (G203)						
1.5 16V (55 kW)	1994.10-	Saloon Engine HEE	•		GWB6967	
1.5 i 16V (66 kW)	1994.08-	Saloon Engine HEE	•		GWB6967	
	1994.08-	Saloon Engine HEE		o	GHA228009	
COPEN						
0.7 (47 kW)	2003.09-	Convertible	•		GWB6966	
0.7 (50 kW)	2003.09-	Convertible Engine JB/JB-DET	•		GWB6966	
1.3 (64 kW)	2006.05-	Convertible Engine K3-VE	•		GWB6966	
CUORE VI (L7_)						
1.0 (40 kW)	1998.11-2000.09	Hatchback Engine EJ-DE	•		GWB6966	
1.0 DVVT (43 kW)	2000.10-2003.02	Hatchback Engine EJ-VE	•		GWB6966	
1.0 i (41 kW)	1998.10-2003.05	Hatchback Engine EJ-DE	•		GWB6966	
CUORE VII (L251)						
1.0 (43 kW)	2003.05-	Hatchback Engine EJ-VE	•		GWB6966	
	2003.05-	Hatchback Engine EJ-VE		o	GHA400115	
CUORE VIII						
1.0 (51 kW)	2007.04-	Hatchback Engine 1KR-FE		o	GHA400224	
EXTOL						
1.3 (66 kW)	2000.07-	Box Engine K3-VE	•		GWB6966	
EXTOL (S22_, S23_)						
1.3 (63 kW)	2000.07-	Bus Engine K3-VE	•		GWB6966	
1.3 4x4 (66 kW)	2000.07-2003.09	Bus Engine K3-VE	•		GWB6966	
1.3 4x4 (68 kW)	2003.10-2005.12	Bus Engine K3-VE	•		GWB6966	
GRAN MOVE (G3)						
1.5 16V (66 kW)	1996.10-1998.07	MPV Engine HEEG	•		GWB6967	
	1996.10-1998.07	MPV Engine HEEG		o	GHA228009	
1.6 16V (67 kW)	1998.05-	MPV Engine HDEP	•		GWB6967	
	1998.05-	MPV Engine HDEP		o	GHA228009	
1.6 GLX (77 kW)	1998.06-2002.07	MPV Engine HDEP	•		GWB6967	
1.6 GX (67 kW)	1998.06-2002.07	MPV Engine HDEP	•		GWB6967	
MATERIA (M4_)						
1.3 (67 kW)	2006.10-	MPV Engine K3-VE		o	GHA400099	
1.5 (76 kW)	2007.04-	MPV Engine 3SZ-VE		o	GHA400099	
MOVE (L6, L9)						
1.0 i (41 kW)	1998.10-	MPV Engine EJ-DE	•		GWB6966	
SIRION (M1)						
1.0 (40 kW)	1998.06-2000.10	Hatchback Engine EJ-DE	•		GWB6966	
1.0 i (41 kW)	1998.04-2000.09	Hatchback Engine EJ-DE	•		GWB6966	
1.0 i (43 kW)	2000.09-2005.01	Hatchback Engine EJ-VE	•		GWB6966	
1.0 i 4WD (41 kW)	1999.04-2000.09	Hatchback Engine EJ-DE	•		GWB6966	
1.0 i 4WD (43 kW)	2000.09-2005.01	Hatchback Engine EJ-VE	•		GWB6966	
1.3 Sport (75 kW)	2000.08-2005.01	Hatchback Engine K3-VE2	•		GWB6966	
1.3 Sport 4WD (75 kW)	2000.08-2005.03	Hatchback Engine K3-VE2	•		GWB6966	
SIRION (M3_)						
1.0 (51 kW)	2005.02-2007.12	Hatchback Engine 1KR-FE	•		GWB6966	
	2005.02-2007.12	Hatchback Engine 1KR-FE		o	GHA400099	
1.3 (64 kW)	2005.02-2007.12	Hatchback Engine K3-VE	•		GWB6966	



	 YEAR		F	R	G-AP Ref.	KIT
DAIHATSU						
SIRION (M3_)						
1.3 (64 kW)	2005.02-2007.12	Hatchback Engine K3-VE		o	GHA400099	
1.3 (67 kW)	2008.03-	Hatchback Engine K3-VE	•		GWB6966	
	2008.03-	Hatchback Engine K3-VE		o	GHA400099	
1.3 4WD (64 kW)	2005.04-	Hatchback Engine K3-VE	•		GWB6966	
1.3 4WD (67 kW)	2008.03-	Hatchback Engine K3-VE	•		GWB6966	
1.5 (76 kW)	2008.03-	Hatchback Engine 3SZ-VE	•		GWB6966	
	2008.03-	Hatchback Engine 3SZ-VE		o	GHA400099	
TERIOS (J1)						
1.3 (63 kW)	2001.09-2005.10	Closed Off-Road Vehicle Engine K3-VE	•		GWB6967	
1.3 4WD (61 kW)	1997.10-2000.10	Closed Off-Road Vehicle Engine HE-EJ	•		GWB6967	
1.3 4WD (63 kW)	2000.10-2005.10	Closed Off-Road Vehicle Engine K3-VE	•		GWB6967	
TERIOS (J2_)						
1.3 DVVT 4x4 (63 kW)	2005.11-	Closed Off-Road Vehicle Engine K3-VE	•		GWB6967	
	2005.11-	Closed Off-Road Vehicle Engine K3-VE	•		GWB7549	
1.5 (77 kW)	2005.11-	Closed Off-Road Vehicle Engine 3SZ-VE	•		GWB6967	
	2005.11-	Closed Off-Road Vehicle Engine 3SZ-VE	•		GWB7549	
1.5 4WD (77 kW)	2006.01-2007.12	Closed Off-Road Vehicle Engine 3SZ-VE	•		GWB6967	
	2006.01-2007.12	Closed Off-Road Vehicle Engine 3SZ-VE	•		GWB7549	
1.5 DVVT (75 kW)	2010.09-	Closed Off-Road Vehicle Engine 3SZ-VE	•		GWB6967	
	2010.09-	Closed Off-Road Vehicle Engine 3SZ-VE	•		GWB7549	
1.5 DVVT 4x4 (75 kW)	2010.09-	Closed Off-Road Vehicle	•		GWB6967	
	2010.09-	Closed Off-Road Vehicle	•		GWB7549	
1.5 VVT-i [RWD] (77 kW)	2005.11-	Closed Off-Road Vehicle Engine 3SZ-VE	•		GWB6967	
	2005.11-	Closed Off-Road Vehicle Engine 3SZ-VE	•		GWB7549	
TREVIS						
1.0 (43 kW)	2006.06-	Hatchback Engine EJ-VE	•		GWB6966	
	2006.06-	Hatchback Engine EJ-VE		o	GHA400115	
YRV (M2)						
	2001.02-	Estate Engine EJ-VE	•		GWB6966	
1.3 (64 kW)	2001.02-	Estate Engine K3-VE	•		GWB6966	
1.3 4WD (64 kW)	2001.02-	Estate Engine K3-VE	•		GWB6966	
1.3 GTTi (95 kW)	2002.07-	Estate Engine K3-VET	•		GWB6966	
DODGE						
AVENGER						
2.0 (115 kW)	2007.06-	Saloon Engine ECN	•		GHA332001	K
	2007.06-	Saloon Engine ECN	•		GHA332010	K
	2007.06-	Saloon Engine ECN Without ABS		o	GHA400192	
2.0 CRD (103 kW)	2007.06-	Saloon Engine ECD	•		GHA332001	K
	2007.06-	Saloon Engine ECD	•		GHA332010	K
	2007.06-	Saloon Engine ECD Without ABS		o	GHA400192	
2.4 (125 kW)	2007.06-	Saloon Engine EDG	•		GHA332001	K
	2007.06-	Saloon Engine EDG Without ABS		o	GHA400192	
2.4 (129 kW)	2007.06-	Saloon Engine ED3/EDG	•		GHA332001	K
	2007.06-	Saloon Engine ED3/EDG	•		GHA332010	K
	2007.06-	Saloon Engine ED3/EDG Without ABS		o	GHA400192	
2.7 FlexFuel (139 kW)	2007.06-	Saloon	•		GHA332001	K
	2007.06-	Saloon Without ABS		o	GHA400192	
CALIBER						
1.8 (110 kW)	2006.06-	Hatchback Engine EBA	•		GWB7408	
	2006.06-	Hatchback Engine EBA		o	GHA325029	
	2006.06-	Hatchback Engine EBA Without ABS		o	GHA400192	
2.0 (115 kW)	2006.06-	Hatchback Engine ECN	•		GWB7408	
	2006.06-	Hatchback Engine ECN		o	GHA325029	
	2006.06-	Hatchback Engine ECN Without ABS		o	GHA400192	
2.0 CRD (103 kW)	2006.06-	Hatchback Engine ECD/ECE	•		GWB7408	
	2006.06-	Hatchback Engine ECD/ECE		o	GHA325029	
	2006.06-	Hatchback Engine ECD/ECE Without ABS		o	GHA400192	
2.2 CRD (120 kW)	2010.07-	Hatchback Engine ENE	•		GWB7408	
	2010.07-	Hatchback Engine ENE Without ABS		o	GHA400192	
2.4 (125 kW)	2006.10-	MPV Engine ED3	•		GWB7408	
	2006.10-	MPV Engine ED3 Without ABS		o	GHA400192	
2.4 (126 kW)	2006.10-	Hatchback Engine ED3	•		GWB7408	



	 YEAR		F	R	G-AP Ref.	KIT
DODGE						
CALIBER						
2.4 AWD (125 kW)	2006.10-	Hatchback Engine ED3	•		GWB7408	
	2006.10-	Hatchback Engine ED3		◦	GHA325018	K
2.4 SRT4 AWD (223 kW)	2006.10-	Hatchback Engine ED4	•		GWB7408	
	2006.10-	Hatchback Engine ED4		◦	GHA325018	K
2.4 Turbo (217 kW)	2007.12-	Hatchback Engine ED4	•		GWB7408	
	2007.12-	Hatchback Engine ED4 Without ABS		◦	GHA400192	
CARAVAN						
2.0 i (98 kW)	1995.01-2001.03	MPV	•		GHA326014	K
	1995.01-2001.03	MPV		◦	GHA400071	
2.4 i (111 kW)	1995.01-2001.03	MPV Engine EDZ	•		GHA326014	K
	1995.01-2001.03	MPV Engine EDZ		◦	GHA400071	
2.5 TD (85 kW)	1995.01-2001.03	MPV Engine ENC	•		GHA326014	K
	1995.01-2001.03	MPV Engine ENC		◦	GHA400071	
2.8 CRD (120 kW)	2009.1-	MPV Engine ENS		◦	GHA400175	
3.0 (112 kW)	1995.01-2001.03	MPV Engine EFA	•		GHA326014	K
	1995.01-2001.03	MPV Engine EFA		◦	GHA400071	
3.3 (131 kW)	2008.1-	MPV		◦	GHA400175	
3.3 i (116 kW)	1995.01-2001.03	MPV Engine EGP	•		GHA326014	K
	1995.01-2001.03	MPV Engine EGP		◦	GHA400071	
3.8 (142 kW)	2008.1-	MPV		◦	GHA400175	
3.8 i (122 kW)	1995.01-2001.03	MPV Engine EGH	•		GHA326014	K
	1995.01-2001.03	MPV Engine EGH		◦	GHA400071	
3.8 i (131 kW)	1995.01-2001.03	MPV Engine EGH	•		GHA326014	K
	1995.01-2001.03	MPV Engine EGH		◦	GHA400071	
3.8 i AWD (122 kW)	1995.01-2001.03	MPV Engine EGH	•		GHA326014	K
	1995.01-2001.03	MPV Engine EGH		◦	GHA326016	
3.8 i AWD (131 kW)	1995.01-2001.03	MPV Engine EGH	•		GHA326014	K
	1995.01-2001.03	MPV Engine EGH		◦	GHA326016	
4.0 (189 kW)	2009.1-	MPV		◦	GHA400175	
CARAVAN (RG_)						
2.4 (111 kW)	2000.02-2007.12	MPV Engine EDZ	•		GHA326014	K
	2000.02-2007.12	MPV Engine EDZ		◦	GHA400071	
	2000.02-2007.12	MPV Engine EDZ		◦	GHA400112	
3.3 (128 kW)	2000.02-2007.12	MPV Engine EGA	•		GHA326014	K
	2000.02-2007.12	MPV Engine EGA		◦	GHA400071	
	2000.02-2007.12	MPV Engine EGA		◦	GHA400112	
3.3 (132 kW)	2001.04-2007.05	MPV Engine EGM	•		GHA326014	K
	2001.04-2007.05	MPV Engine EGM		◦	GHA400071	
3.3 AWD (128 kW)	2000.02-2007.12	MPV Engine EGA	•		GHA326014	K
3.8 (154 kW)	2001.04-2007.05	MPV Engine EGH	•		GHA326014	K
	2001.04-2007.05	MPV Engine EGH		◦	GHA400071	
3.8 (160 kW)	2000.02-2007.12	MPV Engine EGH	•		GHA326014	K
	2000.02-2007.12	MPV Engine EGH		◦	GHA400071	
	2000.02-2007.12	MPV Engine EGH		◦	GHA400112	
3.8 AWD (160 kW)	2000.02-2007.12	MPV Engine EGH	•		GHA326014	K
3.8 Turbo AWD (153 kW)	2001.04-2007.12	MPV Engine EGH	•		GHA326014	K
	2001.04-2007.12	MPV Engine EGH		◦	GHA326016	
	2001.04-2007.12	MPV Engine EGH		◦	GHA400112	
CHALLENGER						
3.5 (186 kW)	2008.09-2010.12	Coupe Engine EGG	•		GHA237013	
	2008.09-2010.12	Coupe Engine EGG		◦	GHA332020	
3.6 (227 kW)	2011.01-	Coupe	•		GHA237013	
	2011.01-	Coupe		◦	GHA332020	
5.7 (277 kW)	2008.09-	Coupe Engine EZH	•		GHA237013	
	2008.09-	Coupe Engine EZH		◦	GHA332020	
5.7 (280 kW)	2010.01-	Coupe	•		GHA237013	
	2010.01-	Coupe		◦	GHA332020	
6.1 SRT8 (317 kW)	2007.09-	Coupe Engine ESF	•		GHA237013	
	2007.09-	Coupe Engine ESF		◦	GHA332020	
6.4 SRT8 (346 kW)	2011.08-	Coupe Engine ESH		◦	GHA332020	
6.4 SRT8 (351 kW)	2011.01-	Coupe Engine ESG	•		GHA237013	
	2011.01-	Coupe Engine ESG		◦	GHA332020	



	 YEAR		F	R	G-AP Ref.	KIT
DODGE						
CHARGER						
2.7 (141 kW)	2006.04-2010.12	Saloon Engine EER	•		GHA237013	
	2006.04-2010.12	Saloon Engine EER		◦	GHA327040	K
	2006.04-2010.12	Saloon Engine EER		◦	GHA332020	
3.5 (186 kW)	2005.06-2010.12	Saloon Engine EGG	•		GHA237013	
	2005.06-2010.12	Saloon Engine EGG		◦	GHA327040	K
	2005.06-2010.12	Saloon Engine EGG		◦	GHA332020	
3.6 (218 kW)	2011.09-	Saloon Engine ERB		◦	GHA332020	
5.7 R/T (254 kW)	2005.06-2008.12	Saloon Engine EZA	•		GHA237013	
	2005.06-2008.12	Saloon Engine EZA		◦	GHA327040	K
	2005.06-2008.12	Saloon Engine EZA		◦	GHA332020	
5.7 R/T (276 kW)	2011.09-	Saloon Engine EZH		◦	GHA332020	
5.7 R/T AWD (276 kW)	2011.09-	Saloon Engine EZH		◦	GHA332020	
6.1 SRT8 (317 kW)	2005.09-2010.12	Saloon Engine ESF	•		GHA237013	
	2005.09-2010.12	Saloon Engine ESF		◦	GHA327040	K
	2005.09-2010.12	Saloon Engine ESF		◦	GHA332020	
6.4 SRT8 (351 kW)	2011.09-	Saloon Engine ESG		◦	GHA332020	
DAKOTA						
-	1997-2004		•		GHA331001	
	1997-2004		•		GHA331004	
	1997-2004		•		GHA331006	K
	2005-2010		•		GHA333090	
DURANGO						
-	1998-		•		GHA331001	
	1998-		•		GHA331004	
	1998-		•		GHA331006	K
	1999-2003		•		GHA331001	
	1999-2003		•		GHA331004	
	1999-2003		•		GHA331006	K
GRAND CARAVAN						
3.3 (127 kW)	2007.06-	MPV Engine EGM		◦	GHA400175	
3.8 (148 kW)	2007.06-	MPV Engine EGH		◦	GHA400175	
JOURNEY						
2.0 CRD (103 kW)	2008.06-	MPV Engine ECE	•		GHA332009	K
	2008.06-	MPV Engine ECE		◦	GHA332018	
	2008.06-	MPV Engine ECE		◦	GHA400178	
	2008.06-	MPV Engine ECE		◦	GHA400179	
2.4 (125 kW)	2009.01-	MPV Engine ED3	•		GHA332009	K
	2009.01-	MPV Engine ED3		◦	GHA332018	
	2009.01-	MPV Engine ED3		◦	GHA400178	
	2009.01-	MPV Engine ED3		◦	GHA400179	
2.4 (129 kW)	2008.09-	MPV Engine ED3/EDG		◦	GHA332018	
2.4 ECO+ (125 kW)	2009.03-	MPV Engine EDG	•		GHA332009	K
	2009.03-	MPV Engine EDG		◦	GHA332018	
2.7 (136 kW)	2009.01-	MPV Engine EER	•		GHA332009	K
	2009.01-	MPV Engine EER		◦	GHA332018	
	2009.01-	MPV Engine EER		◦	GHA400178	
2.7 FlexFuel (136 kW)	2009.01-	MPV Engine EER	•		GHA332009	K
	2009.01-	MPV Engine EER		◦	GHA332018	
3.5 (173 kW)	2008.06-	MPV Engine EGF	•		GHA332009	K
	2008.06-	MPV Engine EGF		◦	GHA332018	
3.5 AWD (173 kW)	2008.06-	MPV Engine EGF	•		GHA332009	K
	2008.06-	MPV Engine EGF		◦	GHA332018	
3.6 (211 kW)	2012.01-	MPV Engine ERB		◦	GHA332018	
NEON						
2.0 16V (107 kW)	1994.06-1999.08	Saloon Engine ECC		◦	GHA228073	
2.0 16V (109 kW)	1996.04-1999.08	Saloon Engine ECC		◦	GHA228073	
2.0 16V (112 kW)	1996.04-1999.08	Saloon Engine ECC		◦	GHA228073	
2.0 16V (98 kW)	1994.05-1999.08	Saloon Engine ECB		◦	GHA228073	
NEON II						
2.0 16V (112 kW)	1999.08-	Saloon Engine ECH	•		GWB6590	
	1999.08-	Saloon Engine ECH	•		GWB6591	
	1999.08-	Saloon Engine ECH With ABS		◦	GHA228048	
	1999.08-	Saloon Engine ECH Without ABS		◦	GHA228013	



	 YEAR		F	R	G-AP Ref.	KIT
DODGE						
NEON II						
2.0 16V (98 kW)	1999.08-	Saloon Engine ECB	•		GWB6590	
	1999.08-	Saloon Engine ECB	•		GWB6591	
	1999.08-	Saloon Engine ECB With ABS		○	GHA228048	
	1999.08-	Saloon Engine ECB Without ABS		○	GHA228013	
NITRO						
2.8 CRD (130 kW)	2007.06-	Closed Off-Road Vehicle Engine ENR/ENS	•		GHA332006	
2.8 CRD 4WD (130 kW)	2007.06-	Closed Off-Road Vehicle Engine ENR/ENS	•		GHA332006	
3.7 V6 (154 kW)	2007.06-2012.12	Closed Off-Road Vehicle Engine EKG	•		GHA332006	
3.7 V6 4WD (151 kW)	2007.06-	Closed Off-Road Vehicle Engine EKG	•		GHA332006	
4.0 4WD (191 kW)	2007.06-	Closed Off-Road Vehicle Engine EGS	•		GHA332006	
RAM 1500						
-	1994-1999		•		GHA333022	
	1997-1999		•		GHA333060	
	1997-1999		•		GHA333062	
	2000-2001		•		GHA333047	
	2000-2001		•		GHA333048	
	2006-2008		•		GHA333077	
	2009-2010		•		GHA333107	
2011-		•		GHA333107		
RAM 1500 PICKUP (D1, DC, DH, DM, DR)						
5.7 (257 kW)	2001.06-2008.09	Pickup Engine EZA	•		GHA333038	
	2001.06-2008.09	Pickup Engine EZA	•		GHA333110	
RAM 2500						
-	1994-1999		•		GHA333039	
	1994-1999		•		GHA333058	
	2003-2005		•		GHA333082	
	2006-2008		•		GHA333077	
	2009-2010		•		GHA335001	
	2011-		•		GHA335001	
RAM 2500 PICKUP (D1, DC, DH, DM, DR)						
5.7 (257 kW)	2002.01-2009.12	Pickup Engine EZA	•		GHA333084	
	2002.01-2009.12	Pickup Engine EZA	•		GHA333086	
RAM 3500						
-	1997-1999		•		GHA333042	
	2003-2005		•		GHA333082	
	2006-2008		•		GHA333077	
	2009-2010		•		GHA335001	
	2011-		•		GHA335001	
STRATUS						
2.0 16V (98 kW)	1995.12-2001.04	Saloon Engine ECB		○	GHA228011	
2.4 16V (103 kW)	1995.12-2001.04	Saloon Engine EDZ		○	GHA228011	
2.4 16V (112 kW)	1995.12-2001.04	Saloon Engine EDZ		○	GHA228011	
2.5 V6 (125 kW)	1995.12-2001.04	Saloon Engine EEB		○	GHA228011	
FIAT						
500						
0.9 (48 kW)	2012.09-	Hatchback Engine 312A4.000	•		GHA425008	
	2012.09-	Hatchback Engine 312A4.000	•		GWB3539	
	2012.09-	Hatchback Engine 312A4.000	•		GWB6540	
	2012.09-	Hatchback Engine 312A4.000 With ABS		○	GHA230046	K
0.9 (63 kW)	2010.07-	Hatchback Engine 312A2.000	•		GHA425008	
	2010.07-	Hatchback Engine 312A2.000	•		GWB3539	
	2010.07-	Hatchback Engine 312A2.000	•		GWB6540	
	2010.07-	Hatchback Engine 312A2.000 With ABS		○	GHA230046	K
1.2 (51 kW)	2008.01-	Hatchback Engine 169A4.000	•		GHA422015	
	2008.01-	Hatchback Engine 169A4.000	•		GWB3577	
	2008.01-	Hatchback Engine 169A4.000 With ABS		○	GHA230046	K
1.2 LPG (51 kW)	2010.12-	Hatchback Engine 169A4.000	•		GHA422015	
	2010.12-	Hatchback Engine 169A4.000	•		GWB3577	
	2010.12-	Hatchback Engine 169A4.000 With ABS		○	GHA230046	K
1.3 D Multijet (55 kW)	2008.01-	Hatchback Engine 169A1.000	•		GHA425008	
	2008.01-	Hatchback Engine 169A1.000	•		GWB3539	
	2008.01-	Hatchback Engine 169A1.000	•		GWB6540	



	 YEAR		F	R	G-AP Ref.	KIT
FIAT						
500						
1.3 D Multijet (55 kW)	2008.01-	Hatchback Engine 169A1.000 With ABS		o	GHA230046	K
1.3 D Multijet (70 kW)	2009.12-	Hatchback Engine 199B1.000	•		GHA425008	
	2009.12-	Hatchback Engine 199B1.000	•		GWB3539	
	2009.12-	Hatchback Engine 199B1.000	•		GWB6540	
	2009.12-	Hatchback Engine 199B1.000 With ABS		o	GHA230046	K
1.4 (74 kW)	2008.01-	Hatchback Engine 169A3.000	•		GHA425008	
	2008.01-	Hatchback Engine 169A3.000	•		GWB3539	
	2008.01-	Hatchback Engine 169A3.000	•		GWB6540	
	2008.01-	Hatchback Engine 169A3.000 With ABS		o	GHA230046	K
1.4 Abarth (118 kW)	2008.08-	Hatchback Engine 312A1.000	•		GHA425008	
1.4 Abarth (132 kW)	2008.08-	Hatchback Engine 312A3.000	•		GHA425008	
1.4 Abarth (140 kW)	2008.08-	Hatchback Engine 312A1.000	•		GHA425008	
1.4 Abarth (99 kW)	2008.08-	Hatchback Engine 312A1.000	•		GHA425008	
500 (312)						
0.9 (44 kW)	2013.12-	Hatchback Engine 312 A4.000/312 A6.000	•		GHA425008	
0.9 (59 kW)	2013.12-	Hatchback Engine 312 A5.000	•		GHA425008	
0.9 (77 kW)	2013.10-	Hatchback Engine 199 B6.000	•		GHA425008	
500 C						
0.9 (48 kW)	2012.09-	Convertible Engine 312A4.000	•		GWB3539	
	2012.09-	Convertible Engine 312A4.000	•		GWB6540	
	2012.09-	Convertible Engine 312A4.000 With ABS		o	GHA230046	K
0.9 (63 kW)	2009.09-	Convertible Engine 312A2.000	•		GWB3539	
	2009.09-	Convertible Engine 312A2.000	•		GWB6540	
	2009.09-	Convertible Engine 312A2.000 With ABS		o	GHA230046	K
	2009.09-	Convertible Engine 169A4.000	•		GHA422015	
1.2 (51 kW)	2009.09-	Convertible Engine 169A4.000	•		GHA425008	
	2009.09-	Convertible Engine 169A4.000	•		GWB3539	
	2009.09-	Convertible Engine 169A4.000	•		GWB6540	
	2009.09-	Convertible Engine 169A4.000 With ABS		o	GHA230046	K
	2009.09-	Convertible Engine 169A1.000	•		GWB3539	
1.3 D Multijet (55 kW)	2009.09-	Convertible Engine 169A1.000	•		GWB6540	
	2009.09-	Convertible Engine 169A1.000 With ABS		o	GHA230046	K
	2009.09-	Convertible Engine 199B1.000	•		GWB3539	
1.3 D Multijet (70 kW)	2009.09-	Convertible Engine 199B1.000	•		GWB6540	
	2009.09-	Convertible Engine 199B1.000 With ABS		o	GHA230046	K
	2009.09-	Convertible Engine 169A3.000	•		GWB3539	
	2009.09-	Convertible Engine 169A3.000	•		GWB6540	
1.4 (74 kW)	2009.09-	Convertible Engine 169A3.000 With ABS		o	GHA230046	K
	2009.09-	Convertible Engine 312A3.000	•		GHA425008	
	2011.05-	Convertible Engine 312A1.000	•		GHA425008	
1.4 Abarth (103 kW)	2009.09-	Convertible Engine 312A3.000	•		GHA425008	
1.4 Abarth (118 kW)	2011.05-	Convertible Engine 312A1.000	•		GHA425008	
1.4 Abarth (132 kW)	2009.09-	Convertible Engine 312A3.000	•		GHA425008	
500 C (312)						
0.9 (77 kW)	2013.12-	Convertible Engine 199 B6.000	•		GWB3539	
	2013.12-	Convertible Engine 199 B6.000	•		GWB6540	
	2013.12-	Convertible Engine 199 B6.000 With ABS		o	GHA230046	K
1.4 (75 kW)	2011.09-	Convertible Engine 169 A3.000	•		GWB3539	
	2011.09-	Convertible Engine 169 A3.000	•		GWB6540	
	2011.09-	Convertible Engine 169 A3.000 With ABS		o	GHA230046	K
500L						
0.9 (77 kW)	2012.09-	Hatchback Engine 199B6.000	•		GWB3598	
	2012.09-	Hatchback Engine 199B6.000		o	GHA230086	K
0.9 Natural Power (63 kW)	2013.03-	Hatchback Engine 312 A2.000	•		GWB3598	
	2013.03-	Hatchback Engine 312 A2.000		o	GHA230086	K
1.3 D Multijet (62 kW)	2012.09-	Hatchback Engine 199B4.000	•		GWB3598	
	2012.09-	Hatchback Engine 199B4.000		o	GHA230086	K
1.3 D Multijet (70 kW)	2014.06-	Hatchback Engine 330 A1.000	•		GWB3598	
	2014.06-	Hatchback Engine 330 A1.000		o	GHA230086	K
1.4 (70 kW)	2012.09-	Hatchback Engine 843A1.000	•		GWB3598	
	2012.09-	Hatchback Engine 843A1.000		o	GHA230086	K
1.6 D Multijet (77 kW)	2012.09-	Hatchback Engine 199 B5.000	•		GWB3598	
	2012.09-	Hatchback Engine 199 B5.000		o	GHA230086	K
BARCETTA (183)						
1.8 16V (96 kW)	1995.04-2005.05	Convertible Engine 183A1.000/188A6.000	•		GHA425008	



	 YEAR		F	R	G-AP Ref.	KIT	
FIAT							
BARCETTA (183)							
1.8 16V (96 kW)	1995.04-2005.05	Convertible Engine 183A1.000/188A6.000	•		GWB1439		
	1995.04-2005.05	Convertible Engine 183A1.000/188A6.000	•		GWB3539		
	1995.04-2005.05	Convertible Engine 183A1.000/188A6.000	•		GWB6540		
	1995.04-2005.05	Convertible Engine 183A1.000/188A6.000		○	GHA230090	K	
	1995.04-2005.05	Convertible Engine 183A1.000/188A6.000 With ABS		○	GHA230046	K	
	1995.04-2005.05	Convertible Engine 183A1.000/188A6.000 Without ABS		○	GHA230044	K	
BRAVA (182)							
1.2 16V (59 kW)	2000.10-2001.10	Hatchback Engine 188A5.000	•		GHA422015		
	2000.10-2001.10	Hatchback Engine 188A5.000	•		GWB3414		
	2000.10-2001.10	Hatchback Engine 188A5.000	•		GWB3538		
	2000.10-2001.10	Hatchback Engine 188A5.000 With ABS		○	GHA230046	K	
	2000.10-2001.10	Hatchback Engine 188A5.000 Without ABS		○	GHA230044	K	
	1.2 16V (60 kW)	1998.12-2002.12	Hatchback Engine 182B2.000	•		GHA422015	
1998.12-2002.12		Hatchback Engine 182B2.000	•		GWB3414		
1998.12-2002.12		Hatchback Engine 182B2.000	•		GWB3538		
1998.12-2002.12		Hatchback Engine 182B2.000 With ABS		○	GHA230046	K	
1998.12-2002.12		Hatchback Engine 182B2.000 Without ABS		○	GHA230044	K	
1.2 16V (64 kW)		1998.12-2002.12	Hatchback Engine 182B2.000	•		GWB3414	
	1998.12-2002.12	Hatchback Engine 182B2.000	•		GWB3538		
	1998.12-2002.12	Hatchback Engine 182B2.000 With ABS		○	GHA230046	K	
	1998.12-2002.12	Hatchback Engine 182B2.000 Without ABS		○	GHA230044	K	
	1.4 (55 kW)	1995.10-2001.10	Hatchback Engine 182A5.000	•		GHA422015	
		1995.10-2001.10	Hatchback Engine 182A5.000	•		GWB3414	
1995.10-2001.10		Hatchback Engine 182A5.000		○	GHA230090	K	
1995.10-2001.10		Hatchback Engine 182A5.000 With ABS		○	GHA230046	K	
1995.10-2001.10		Hatchback Engine 182A5.000 Without ABS		○	GHA230044	K	
1.4 12V (59 kW)		1995.10-1998.08	Hatchback Engine 182A3.000	•		GHA422015	
	1995.10-1998.08	Hatchback Engine 182A3.000	•		GWB3414		
	1995.10-1998.08	Hatchback Engine 182A3.000		○	GHA230090	K	
	1995.10-1998.08	Hatchback Engine 182A3.000 Without ABS		○	GHA230044	K	
	1.6 16V (66 kW)	1995.10-2001.10	Hatchback Engine 182A6.000	•		GHA422015	
		1995.10-2001.10	Hatchback Engine 182A6.000	•		GHA425008	
1995.10-2001.10		Hatchback Engine 182A6.000	•		GWB3414		
1995.10-2001.10		Hatchback Engine 182A6.000		○	GHA230090	K	
1995.10-2001.10		Hatchback Engine 182A6.000 With ABS		○	GHA230046	K	
1995.10-2001.10		Hatchback Engine 182A6.000 Without ABS		○	GHA230044	K	
1.6 16V (76 kW)	1996.02-2001.10	Hatchback Engine 182A4.000	•		GHA422015		
	1996.02-2001.10	Hatchback Engine 182A4.000	•		GHA425008		
	1996.02-2001.10	Hatchback Engine 182A4.000	•		GWB1439		
	1996.02-2001.10	Hatchback Engine 182A4.000	•		GWB3414		
	1996.02-2001.10	Hatchback Engine 182A4.000	•		GWB3538		
	1996.02-2001.10	Hatchback Engine 182A4.000	•		GWB3539		
	1996.02-2001.10	Hatchback Engine 182A4.000	•		GWB6540		
	1996.02-2001.10	Hatchback Engine 182A4.000		○	GHA230090	K	
	1996.02-2001.10	Hatchback Engine 182A4.000 With ABS		○	GHA230046	K	
	1996.02-2001.10	Hatchback Engine 182A4.000 Without ABS		○	GHA230044	K	
	1999.01-2002.12	Hatchback Engine 182B6.000	•		GWB1439		
	1999.01-2002.12	Hatchback Engine 182B6.000	•		GWB3414		
	1999.01-2002.12	Hatchback Engine 182B6.000	•		GWB3538		
	1999.01-2002.12	Hatchback Engine 182B6.000	•		GWB3539		
	1999.01-2002.12	Hatchback Engine 182B6.000	•		GWB6540		
	1999.01-2002.12	Hatchback Engine 182B6.000 With ABS		○	GHA230046	K	
	1999.01-2002.12	Hatchback Engine 182B6.000 Without ABS		○	GHA230044	K	
	1.8 GT 16V (83 kW)	1995.10-2001.10	Hatchback Engine 182A2.000	•		GHA425008	
		1995.10-2001.10	Hatchback Engine 182A2.000	•		GWB1439	
		1995.10-2001.10	Hatchback Engine 182A2.000	•		GWB3539	
1995.10-2001.10		Hatchback Engine 182A2.000	•		GWB6540		
1995.10-2001.10		Hatchback Engine 182A2.000		○	GHA230090	K	
1995.10-2001.10		Hatchback Engine 182A2.000 With ABS		○	GHA230046	K	
1995.10-2001.10		Hatchback Engine 182A2.000 Without ABS		○	GHA230044	K	
1.9 D (48 kW)	1995.10-2001.10	Hatchback Engine 160A7.000	•		GHA422015		
	1995.10-2001.10	Hatchback Engine 160A7.000	•		GWB3414		
	1995.10-2001.10	Hatchback Engine 160A7.000		○	GHA230090	K	
	1995.10-2001.10	Hatchback Engine 160A7.000 With ABS		○	GHA230046	K	



	 YEAR		F	R	G-AP Ref.	KIT
FIAT						
BRAVA (182)						
1.9 D (48 kW)	1995.10-2001.10	Hatchback Engine 160A7.000 Without ABS		o	GHA230044	K
1.9 JTD (74 kW)	2000.09-2001.10	Hatchback Engine 182B9.000	•		GHA425008	
	2000.09-2001.10	Hatchback Engine 182B9.000	•		GWB1439	
	2000.09-2001.10	Hatchback Engine 182B9.000	•		GWB3539	
	2000.09-2001.10	Hatchback Engine 182B9.000	•		GWB6540	
	2000.09-2001.10	Hatchback Engine 182B9.000 With ABS		o	GHA230046	K
	2000.09-2001.10	Hatchback Engine 182B9.000 Without ABS		o	GHA230044	K
1.9 JTD (77 kW)	1998.12-2001.10	Hatchback Engine 182B4.000	•		GWB1439	
	1998.12-2001.10	Hatchback Engine 182B4.000	•		GWB3539	
	1998.12-2001.10	Hatchback Engine 182B4.000	•		GWB6540	
	1998.12-2001.10	Hatchback Engine 182B4.000 With ABS		o	GHA230046	K
	1998.12-2001.10	Hatchback Engine 182B4.000 Without ABS		o	GHA230044	K
1.9 TD S (55 kW)	1996.03-2001.10	Hatchback Engine 182A8.000	•		GHA425008	
	1996.03-2001.10	Hatchback Engine 182A8.000	•		GWB1439	
	1996.03-2001.10	Hatchback Engine 182A8.000	•		GWB3539	
	1996.03-2001.10	Hatchback Engine 182A8.000	•		GWB6540	
	1996.03-2001.10	Hatchback Engine 182A8.000		o	GHA230090	K
	1996.03-2001.10	Hatchback Engine 182A8.000 With ABS		o	GHA230046	K
	1996.03-2001.10	Hatchback Engine 182A8.000 Without ABS		o	GHA230044	K
1.9 TD S (74 kW)	1996.03-2001.10	Hatchback Engine 182A7.000	•		GHA425008	
	1996.03-2001.10	Hatchback Engine 182A7.000	•		GWB1439	
	1996.03-2001.10	Hatchback Engine 182A7.000	•		GWB3539	
	1996.03-2001.10	Hatchback Engine 182A7.000	•		GWB6540	
	1996.03-2001.10	Hatchback Engine 182A7.000		o	GHA230090	K
	1996.03-2001.10	Hatchback Engine 182A7.000 With ABS		o	GHA230046	K
	1996.03-2001.10	Hatchback Engine 182A7.000 Without ABS		o	GHA230044	K
BRAVO I (182)						
1.2 16V (59 kW)	2000.10-2001.10	Hatchback Engine 188A5.000	•		GHA422015	
	2000.10-2001.10	Hatchback Engine 188A5.000	•		GWB3414	
	2000.10-2001.10	Hatchback Engine 188A5.000	•		GWB3538	
	2000.10-2001.10	Hatchback Engine 188A5.000 With ABS		o	GHA230046	K
	2000.10-2001.10	Hatchback Engine 188A5.000 Without ABS		o	GHA230044	K
1.2 16V (60 kW)	1998.12-2000.10	Hatchback Engine 182B2.000	•		GHA422015	
	1998.12-2000.10	Hatchback Engine 182B2.000	•		GWB3414	
	1998.12-2000.10	Hatchback Engine 182B2.000	•		GWB3538	
	1998.12-2000.10	Hatchback Engine 182B2.000 With ABS		o	GHA230046	K
	1998.12-2000.10	Hatchback Engine 182B2.000 Without ABS		o	GHA230044	K
1.2 16V (64 kW)	1998.12-2001.10	Hatchback Engine 182B2.000	•		GWB3414	
	1998.12-2001.10	Hatchback Engine 182B2.000	•		GWB3538	
	1998.12-2001.10	Hatchback Engine 182B2.000 With ABS		o	GHA230046	K
	1998.12-2001.10	Hatchback Engine 182B2.000 Without ABS		o	GHA230044	K
1.4 (55 kW)	1995.10-2001.10	Hatchback Engine 182A5.000	•		GHA422015	
	1995.10-2001.10	Hatchback Engine 182A5.000	•		GWB3414	
	1995.10-2001.10	Hatchback Engine 182A5.000		o	GHA230090	K
	1995.10-2001.10	Hatchback Engine 182A5.000 With ABS		o	GHA230046	K
	1995.10-2001.10	Hatchback Engine 182A5.000 Without ABS		o	GHA230044	K
1.4 (59 kW)	1995.10-2001.10	Hatchback Engine 182A3.000	•		GHA422015	
	1995.10-2001.10	Hatchback Engine 182A3.000	•		GWB3414	
	1995.10-2001.10	Hatchback Engine 182A3.000		o	GHA230090	K
	1995.10-2001.10	Hatchback Engine 182A3.000 With ABS		o	GHA230046	K
	1995.10-2001.10	Hatchback Engine 182A3.000 Without ABS		o	GHA230044	K
1.6 (76 kW)	2000.09-2000.02	Hatchback Engine 182B6.000	•		GHA422015	
	2000.09-2000.02	Hatchback Engine 182B6.000	•		GHA425008	
	2000.09-2000.02	Hatchback Engine 182B6.000	•		GWB3414	
	2000.09-2000.02	Hatchback Engine 182B6.000	•		GWB3538	
	2000.09-2000.02	Hatchback Engine 182B6.000 With ABS		o	GHA230046	K
	2000.09-2000.02	Hatchback Engine 182B6.000 Without ABS		o	GHA230044	K
1.6 16V (66 kW)	1995.10-2001.10	Hatchback Engine 182A6.000	•		GHA422015	
	1995.10-2001.10	Hatchback Engine 182A6.000	•		GHA425008	
	1995.10-2001.10	Hatchback Engine 182A6.000	•		GWB3414	
	1995.10-2001.10	Hatchback Engine 182A6.000	•		GWB3538	
	1995.10-2001.10	Hatchback Engine 182A6.000		o	GHA230090	K
	1995.10-2001.10	Hatchback Engine 182A6.000 With ABS		o	GHA230046	K
	1995.10-2001.10	Hatchback Engine 182A6.000 Without ABS		o	GHA230044	K



	 YEAR		F	R	G-AP Ref.	KIT
FIAT						
BRAVO I (182)						
1.6 16V (76 kW)	1996.03-2001.10	Hatchback Engine 182A4.000	•		GHA422015	
	1996.03-2001.10	Hatchback Engine 182A4.000	•		GHA425008	
	1996.03-2001.10	Hatchback Engine 182A4.000	•		GWB3414	
	1996.03-2001.10	Hatchback Engine 182A4.000	•		GWB3538	
	1996.03-2001.10	Hatchback Engine 182A4.000		○	GHA230090	K
	1996.03-2001.10	Hatchback Engine 182A4.000 With ABS		○	GHA230046	K
	1996.03-2001.10	Hatchback Engine 182A4.000 Without ABS		○	GHA230044	K
1.8 GT (83 kW)	1995.10-2001.10	Hatchback Engine 182A2.000	•		GHA425008	
	1995.10-2001.10	Hatchback Engine 182A2.000	•		GWB1439	
	1995.10-2001.10	Hatchback Engine 182A2.000	•		GWB3539	
	1995.10-2001.10	Hatchback Engine 182A2.000	•		GWB6540	
	1995.10-2001.10	Hatchback Engine 182A2.000 With ABS		○	GHA230090	K
	1995.10-2001.10	Hatchback Engine 182A2.000 Without ABS		○	GHA230046	K
1.9 D (48 kW)	1995.10-2001.10	Hatchback Engine 160A7.000	•		GHA422015	
	1995.10-2001.10	Hatchback Engine 160A7.000	•		GWB3414	
	1995.10-2001.10	Hatchback Engine 160A7.000		○	GHA230090	K
	1995.10-2001.10	Hatchback Engine 160A7.000 With ABS		○	GHA230046	K
	1995.10-2001.10	Hatchback Engine 160A7.000 Without ABS		○	GHA230044	K
1.9 JTD (74 kW)	2000.09-2001.10	Hatchback Engine 182B9.000	•		GHA425008	
	2000.09-2001.10	Hatchback Engine 182B9.000	•		GWB1439	
	2000.09-2001.10	Hatchback Engine 182B9.000	•		GWB3539	
	2000.09-2001.10	Hatchback Engine 182B9.000	•		GWB6540	
	2000.09-2001.10	Hatchback Engine 182B9.000 With ABS		○	GHA230046	K
	2000.09-2001.10	Hatchback Engine 182B9.000 Without ABS		○	GHA230044	K
1.9 JTD (77 kW)	1998.12-2001.10	Hatchback Engine 182B4.000	•		GWB1439	
	1998.12-2001.10	Hatchback Engine 182B4.000	•		GWB3539	
	1998.12-2001.10	Hatchback Engine 182B4.000	•		GWB6540	
	1998.12-2001.10	Hatchback Engine 182B4.000 With ABS		○	GHA230046	K
	1998.12-2001.10	Hatchback Engine 182B4.000 Without ABS		○	GHA230044	K
1.9 TD S (55 kW)	1996.03-2001.10	Hatchback Engine 182A8.000	•		GHA425008	
	1996.03-2001.10	Hatchback Engine 182A8.000	•		GWB1439	
	1996.03-2001.10	Hatchback Engine 182A8.000	•		GWB3539	
	1996.03-2001.10	Hatchback Engine 182A8.000	•		GWB6540	
	1996.03-2001.10	Hatchback Engine 182A8.000		○	GHA230090	K
	1996.03-2001.10	Hatchback Engine 182A8.000 With ABS		○	GHA230046	K
	1996.03-2001.10	Hatchback Engine 182A8.000 Without ABS		○	GHA230044	K
1.9 TD S (74 kW)	1996.03-2001.10	Hatchback Engine 182A7.000	•		GHA425008	
	1996.03-2001.10	Hatchback Engine 182A7.000	•		GWB1439	
	1996.03-2001.10	Hatchback Engine 182A7.000	•		GWB3539	
	1996.03-2001.10	Hatchback Engine 182A7.000	•		GWB6540	
	1996.03-2001.10	Hatchback Engine 182A7.000		○	GHA230090	K
	1996.03-2001.10	Hatchback Engine 182A7.000 With ABS		○	GHA230046	K
	1996.03-2001.10	Hatchback Engine 182A7.000 Without ABS		○	GHA230044	K
	1996.03-2001.10	Hatchback Engine 182A7.000 Without ABS		○	GHA230044	K
2.0 HGT 20V (108 kW)	1995.10-1998.07	Hatchback Engine 182A1.000	•		GWB1488	
	1995.10-1998.07	Hatchback Engine 182A1.000		○	GHA230090	K
	1995.10-1998.07	Hatchback Engine 182A1.000 Without ABS		○	GHA230044	K
2.0 HGT 20V (113 kW)	1998.07-2001.10	Hatchback Engine 182B7.000		○	GHA230090	K
	1998.07-2001.10	Hatchback Engine 182B7.000 With ABS		○	GHA230046	K
	1998.07-2001.10	Hatchback Engine 182B7.000 Without ABS		○	GHA230044	K
BRAVO II (198)						
1.4 (66 kW)	2007.05-	Hatchback Engine 192B2.000	•		GHA425008	
	2007.05-	Hatchback Engine 192B2.000	•		GWB3598	
	2007.05-	Hatchback Engine 192B2.000 With ABS		○	GHA230046	K
1.4 16V (103 kW)	2008.03-	Hatchback Engine 198A7.000	•		GHA425008	
	2008.03-	Hatchback Engine 198A7.000	•		GWB3598	
	2008.03-	Hatchback Engine 198A7.000 With ABS		○	GHA230046	K
1.4 LPG (66 kW)	2009.11-	Hatchback Engine 192B2.000	•		GHA425008	
	2009.11-	Hatchback Engine 192B2.000	•		GWB3598	
	2009.11-	Hatchback Engine 192B2.000 With ABS		○	GHA230046	K
1.4 T-Jet (110 kW)	2007.05-	Hatchback Engine 198A1.000	•		GHA425008	
	2007.05-	Hatchback Engine 198A1.000	•		GWB3598	
	2007.05-	Hatchback Engine 198A1.000 With ABS		○	GHA230046	K
1.4 T-Jet (88 kW)	2007.10-	Hatchback Engine 198A4.000	•		GHA425008	



	 YEAR		F	R	G-AP Ref.	KIT
FIAT						
BRAVO II (198)						
1.4 T-Jet (88 kW)	2007.10-	Hatchback Engine 198A4.000	•		GWB3598	
	2007.10-	Hatchback Engine 198A4.000 With ABS		◦	GHA230046	K
1.6 D Multijet (66 kW)	2008.03-	Hatchback Engine 198A6.000	•		GHA425008	
	2008.03-	Hatchback Engine 198A6.000	•		GWB3598	
1.6 D Multijet (77 kW)	2008.03-	Hatchback Engine 198A6.000 With ABS		◦	GHA230046	K
	2008.03-	Hatchback Engine 198A3.000	•		GHA425008	
1.6 D Multijet (85 kW)	2008.03-	Hatchback Engine 198A3.000	•		GWB3598	
	2008.03-	Hatchback Engine 198A3.000 With ABS		◦	GHA230046	K
1.6 D Multijet (88 kW)	2008.11-	Hatchback Engine 955A4.000	•		GWB3598	
	2008.11-	Hatchback Engine 955A4.000 With ABS		◦	GHA230046	K
1.6 D Multijet (88 kW)	2008.03-	Hatchback Engine 198A2.000	•		GHA425008	
	2008.03-	Hatchback Engine 198A2.000	•		GWB3598	
1.9 D Multijet (110 kW)	2008.03-	Hatchback Engine 198A2.000 With ABS		◦	GHA230046	K
	2007.04-	Hatchback Engine 937A5.000	•		GWB3599	
1.9 D Multijet (66 kW)	2007.04-	Hatchback Engine 937A5.000 With ABS		◦	GHA230046	K
	2007.04-2008.12	Hatchback Engine 192B5.000	•		GHA425008	
1.9 D Multijet (85 kW)	2007.04-2008.12	Hatchback Engine 192B5.000	•		GWB3598	
	2007.04-2008.12	Hatchback Engine 192B5.000 With ABS		◦	GHA230046	K
1.9 D Multijet (88 kW)	2006.11-	Hatchback Engine 192 A1.000/192 B4.000	•		GHA425008	
	2007.04-	Hatchback Engine 192A8.000	•		GHA425008	
2.0 D Multijet (120 kW)	2007.04-	Hatchback Engine 192A8.000	•		GWB3598	
	2007.04-	Hatchback Engine 192A8.000 With ABS		◦	GHA230046	K
2.0 D Multijet (121 kW)	2008.09-	Hatchback Engine 844A2.000	•		GWB3599	
	2008.09-	Hatchback Engine 844A2.000 With ABS		◦	GHA230046	K
BRAVO VAN (198)	2008.09-	Hatchback Engine 198A5.000	•		GWB3599	
	2008.09-	Hatchback Engine 198A5.000 With ABS		◦	GHA230046	K
BRAVO VAN (198)						
1.6 D Multijet (77 kW)	2008.03-	Box Engine 198A3.000	•		GHA425008	
	2008.03-	Box Engine 198A3.000	•		GWB3598	
	2008.03-	Box Engine 198A3.000 With ABS		◦	GHA230046	K
CINQUECENTO (170)						
0.7 (23 kW)	1991.12-1996.01	Hatchback Engine 170A.000	•		GHA422015	
	1991.12-1996.01	Hatchback Engine 170A.000	•		GWB1401	
	1991.12-1996.01	Hatchback Engine 170A.000		◦	GHA230002	S
0.7 i (22 kW)	1994.07-1998.01	Hatchback Engine 170A.046	•		GHA422015	
	1994.07-1998.01	Hatchback Engine 170A.046	•		GWB1401	
	1994.07-1998.01	Hatchback Engine 170A.046		◦	GHA230002	S
0.9 (30 kW)	1991.07-1993.12	Hatchback Engine 170A1.000	•		GHA422015	
	1991.07-1993.12	Hatchback Engine 170A1.000	•		GWB1401	
	1991.07-1993.12	Hatchback Engine 170A1.000		◦	GHA230002	S
0.9 i.e. (30 kW)	1991.07-1993.12	Hatchback Engine 170A1.046	•		GHA422015	
	1991.07-1993.12	Hatchback Engine 170A1.046	•		GWB1401	
	1991.07-1993.12	Hatchback Engine 170A1.046		◦	GHA230002	S
0.9 i.e. S (29 kW)	1991.07-1999.07	Hatchback Engine 1170A1.000/1170A1.046	•		GHA422015	
	1991.07-1999.07	Hatchback Engine 1170A1.000/1170A1.046	•		GWB1401	
	1991.07-1999.07	Hatchback Engine 1170A1.000/1170A1.046		◦	GHA230002	S
1.1 Sporting (40 kW)	1994.10-1998.01	Hatchback Engine 176B2.000	•		GHA422015	
	1994.10-1998.01	Hatchback Engine 176B2.000	•		GWB1401	
	1994.10-1998.01	Hatchback Engine 176B2.000		◦	GHA230002	S
COUPE (FA/175)						
1.8 16V (96 kW)	1996.03-2000.08	Coupe Engine 183A1.000	•		GHA425008	
	1996.03-2000.08	Coupe Engine 183A1.000	•		GWB1439	
	1996.03-2000.08	Coupe Engine 183A1.000		◦	GHA230028	K
	1996.03-2000.08	Coupe Engine 183A1.000 Without ABS		◦	GHA230044	K
2.0 16V (102 kW)	1993.11-1996.08	Coupe Engine 836A3.000	•		GWB1439	
	1993.11-1996.08	Coupe Engine 836A3.000		◦	GHA230028	K
2.0 16V Turbo (140 kW)	1993.11-1996.08	Coupe Engine 175A1.000	•		GWB1488	
	1993.11-1996.08	Coupe Engine 175A1.000		◦	GHA230028	K
2.0 20V (108 kW)	1996.08-1998.04	Coupe Engine 182A1.000	•		GHA425008	
	1996.08-1998.04	Coupe Engine 182A1.000	•		GWB1439	
	1996.08-1998.04	Coupe Engine 182A1.000		◦	GHA230028	K
2.0 20V (113 kW)	1998.04-2000.08	Coupe Engine 182B3.000	•		GHA425008	
	1998.04-2000.08	Coupe Engine 182B3.000	•		GWB1439	
	1998.04-2000.08	Coupe Engine 182B3.000		◦	GHA230028	K



	 YEAR		F	R	G-AP Ref.	KIT
FIAT						
COUPE (FA/175)						
2.0 20V Turbo (162 kW)	1996.08-2000.08	Coupe Engine 175A3.000	•		GWB1488	
	1996.08-2000.08	Coupe Engine 175A3.000		◦	GHA230028	K
CROMA (154)						
2.0 16V (101 kW)	1992.08-1996.08	Hatchback Engine 154E1.000	•		GHA425008	
	1992.08-1996.08	Hatchback Engine 154E1.000	•		GWB1488	
	1992.08-1996.08	Hatchback Engine 154E1.000		◦	GHA235014	K
2.0 CHT (74 kW)	1991.01-1992.09	Hatchback	•		GHA425008	
	1991.01-1992.09	Hatchback		◦	GHA235014	K
2.0 Turbo D i.D. (69 kW)	1992.11-1996.12	Hatchback Engine 154D1.000	•		GWB1488	
	1992.11-1996.12	Hatchback Engine 154D1.000		◦	GHA235014	K
2.5 TDE (77 kW)	1991.12-1996.08	Hatchback Engine 8144.97S	•		GHA425008	
	1991.12-1996.08	Hatchback Engine 8144.97S	•		GWB1488	
	1991.12-1996.08	Hatchback Engine 8144.97S		◦	GHA235014	K
2.5 V6 (119 kW)	1993.06-1996.08	Hatchback Engine 834G.000	•		GWB1488	
	1993.06-1996.08	Hatchback Engine 834G.000		◦	GHA235014	K
CROMA (194)						
1.8 16V (103 kW)	2006.02-	Estate Engine 939A4.000	•		GHA330011	K
	2006.02-	Estate Engine 939A4.000		◦	GHA400137	K
1.9 D Multijet (100 kW)	2005.12-	Estate Engine 939A8.000	•		GHA330011	K
	2005.12-	Estate Engine 939A8.000		◦	GHA400137	K
1.9 D Multijet (110 kW)	2005.08-	Estate Engine 939A2.000	•		GHA330011	K
	2005.08-	Estate Engine 939A2.000		◦	GHA400137	K
1.9 D Multijet (85 kW)	2005.06-	Estate Engine 939A7.000	•		GHA330011	K
	2005.06-	Estate Engine 939A7.000		◦	GHA400137	K
1.9 D Multijet (88 kW)	2005.08-	Estate Engine 939A1.000	•		GHA330011	K
	2005.08-	Estate Engine 939A1.000		◦	GHA400137	K
2.2 16V (108 kW)	2005.08-	Estate Engine 194A1.000	•		GHA330011	K
	2005.08-	Estate Engine 194A1.000		◦	GHA400137	K
2.4 D Multijet (147 kW)	2005.08-	Estate Engine 939A3.000	•		GHA330011	K
	2005.08-	Estate Engine 939A3.000		◦	GHA400137	K
DOBLO (119)						
1.2 (48 kW)	2001.03-	MPV Engine 223A5.000	•		GHA422007	
	2001.03-	MPV Engine 223A5.000	•		GWB3416	
	2001.03-	MPV Engine 223A5.000	•		GWB3581	
	2001.03-	MPV Engine 223A5.000 With ABS		◦	GHA230047	K
1.3 D Multijet (62 kW)	2005.10-	MPV Engine 223A9.000	•		GWB1439	
	2005.10-	MPV Engine 223A9.000	•		GWB3539	
	2005.10-	MPV Engine 223A9.000	•		GWB6540	
	2005.10-	MPV Engine 223A9.000 With ABS		◦	GHA230047	K
1.3 JTD (55 kW)	2005.05-	MPV Engine 199A2.000	•		GWB1439	
	2005.05-	MPV Engine 199A2.000	•		GWB3539	
	2005.05-	MPV Engine 199A2.000	•		GWB6540	
	2005.05-	MPV Engine 199A2.000 With ABS		◦	GHA230047	K
1.3 JTD 16V (51 kW)	2004.12-2005.05	MPV Engine 188A9.000	•		GWB1439	
	2004.12-2005.05	MPV Engine 188A9.000	•		GWB3581	
	2004.12-2005.05	MPV Engine 188A9.000 With ABS		◦	GHA230047	K
1.4 (57 kW)	2005.12-	MPV Engine 350A1.000	•		GWB3416	
	2005.12-	MPV Engine 350A1.000	•		GWB3581	
	2005.12-	MPV Engine 350A1.000 With ABS		◦	GHA230047	K
1.6 16V (76 kW)	2001.10-	MPV Engine 182B6.000	•		GHA422007	
	2001.10-	MPV Engine 182B6.000	•		GWB3416	
	2001.10-	MPV Engine 182B6.000	•		GWB3581	
	2001.10-	MPV Engine 182B6.000 With ABS		◦	GHA230047	K
1.6 Natural Power (76 kW)	2002.09-	MPV Engine 182B6.000	•		GWB1439	
	2002.09-	MPV Engine 182B6.000	•		GWB3539	
	2002.09-	MPV Engine 182B6.000	•		GWB6540	
	2002.09-	MPV Engine 182B6.000 With ABS		◦	GHA230047	K
1.9 D (46 kW)	2001.03-	MPV Engine 223A6.000	•		GHA422007	
	2001.03-	MPV Engine 223A6.000	•		GWB3416	
	2001.03-	MPV Engine 223A6.000	•		GWB3581	
	2001.03-	MPV Engine 223A6.000 With ABS		◦	GHA230047	K
1.9 D Multijet (88 kW)	2005.12-	MPV Engine 186A9.000	•		GWB1439	
	2005.12-	MPV Engine 186A9.000	•		GWB3539	
	2005.12-	MPV Engine 186A9.000	•		GWB6540	



	 YEAR		F	R	G-AP Ref.	KIT
FIAT						
DOBLO (119)						
1.9 D Multijet (88 kW)	2005.12-	MPV Engine 186A9.000 With ABS		o	GHA230047	K
1.9 JTD (74 kW)	2001.10-	MPV Engine 182B9.000/223B2.000	•		GHA425009	
	2001.10-	MPV Engine 182B9.000/223B2.000	•		GWB1439	
	2001.10-	MPV Engine 182B9.000/223B2.000	•		GWB3539	
	2001.10-	MPV Engine 182B9.000/223B2.000	•		GWB6540	
	2001.10-	MPV Engine 182B9.000/223B2.000 With ABS		o	GHA230047	K
1.9 JTD (77 kW)	2004.11-2005.11	MPV Engine 223A7.000/223B1.000	•		GHA425009	
	2004.11-2005.11	MPV Engine 223A7.000/223B1.000	•		GWB1439	
	2004.11-2005.11	MPV Engine 223A7.000/223B1.000	•		GWB3539	
	2004.11-2005.11	MPV Engine 223A7.000/223B1.000	•		GWB6540	
	2004.11-2005.11	MPV Engine 223A7.000/223B1.000 With ABS		o	GHA230047	K
DOBLO (152)						
1.4 (88 kW)	2011.10-	MPV Engine 198.A4.000	•		GWB3598	
	2011.10-	MPV Engine 198.A4.000	•		GWB3599	
	2011.10-	MPV Engine 198.A4.000		o	GHA230086	K
	2011.10-	MPV Engine 198.A4.000 With ABS		o	GHA230128	
	2011.10-	MPV Engine 198.A4.000 Without ABS		o	GHA230127	
1.4 Natural Power (88 kW)	2010.02-	MPV Engine 198.A4.000	•		GWB3599	
	2010.02-	MPV Engine 198.A4.000 With ABS		o	GHA230128	
1.6 D Multijet (70 kW)	2015.03-	MPV Engine 263 A7.000		o	GHA230086	K
	2015.03-	MPV Engine 263 A7.000 With ABS		o	GHA230128	
1.6 D Multijet (88 kW)	2015.03-	MPV Engine 940 C1.000		o	GHA230086	K
	2015.03-	MPV Engine 940 C1.000 With ABS		o	GHA230128	
DOBLO (152, 263)						
1.3 D Multijet (66 kW)	2010.02-	MPV Engine 199A3.000/263A2.000	•		GWB3598	
	2010.02-	MPV Engine 199A3.000/263A2.000		o	GHA230086	K
	2010.02-	MPV Engine 199A3.000/263A2.000 With ABS		o	GHA230128	
	2010.02-	MPV Engine 199A3.000/263A2.000 Without ABS		o	GHA230127	
1.4 (70 kW)	2010.02-	MPV Engine 843A1.000	•		GWB3598	
	2010.02-	MPV Engine 843A1.000	•		GWB3599	
	2010.02-	MPV Engine 843A1.000		o	GHA230086	K
	2010.02-	MPV Engine 843A1.000 With ABS		o	GHA230128	
	2010.02-	MPV Engine 843A1.000 Without ABS		o	GHA230127	
1.6 D Multijet (66 kW)	2010.02-	MPV Engine 263A4.000	•		GHA425028	
	2010.02-	MPV Engine 263A4.000	•		GWB3598	
	2010.02-	MPV Engine 263A4.000	•		GWB3599	
	2010.02-	MPV Engine 263A4.000		o	GHA230086	K
	2010.02-	MPV Engine 263A4.000 With ABS		o	GHA230128	
1.6 D Multijet (77 kW)	2010.02-	MPV Engine 263A4.000 Without ABS		o	GHA230127	
	2010.02-	MPV Engine 198A3.000	•		GHA425028	
	2010.02-	MPV Engine 198A3.000	•		GWB3598	
	2010.02-	MPV Engine 198A3.000	•		GWB3599	
	2010.02-	MPV Engine 198A3.000		o	GHA230086	K
2.0 D Multijet (99 kW)	2010.02-	MPV Engine 198A3.000 With ABS		o	GHA230128	
	2010.02-	MPV Engine 198A3.000 Without ABS		o	GHA230127	
	2010.02-	MPV Engine 263A1.000	•		GHA425028	
	2010.02-	MPV Engine 263A1.000	•		GWB3599	
	2010.02-	MPV Engine 263A1.000		o	GHA230086	K
2.0 D Multijet (99 kW)	2010.02-	MPV Engine 263A1.000 With ABS		o	GHA230128	
	2010.02-	MPV Engine 263A1.000 Without ABS		o	GHA230127	
	2010.02-	MPV Engine 263A1.000		o	GHA230086	K
	2010.02-	MPV Engine 263A1.000 With ABS		o	GHA230128	
	2010.02-	MPV Engine 263A1.000 Without ABS		o	GHA230127	
DOBLO (263)						
1.3 D Multijet (55 kW)	2013.11-	Box Body/Estate Engine 263 A6.000 Without ABS		o	GHA230127	
	2013.11-	Platform/Chassis Engine 263 A6.000 Without ABS		o	GHA230127	
1.3 D Multijet (66 kW)	2010.02-	Box Body / Estate Engine 199A3.000/263A2.000	•		GWB3598	
	2010.02-	Box Body / Estate Engine 199A3.000/263A2.000	•		GWB6774	
	2010.02-	Box Body / Estate Engine 199A3.000/263A2.000		o	GHA230086	K
	2010.02-	Box Body / Estate Engine 199A3.000/263A2.000 With ABS		o	GHA230128	
	2010.02-	Box Body / Estate Engine 199A3.000/263A2.000 Without ABS		o	GHA230127	
	2010.02-	Platform/Chassis Engine 199A3.000/263A2.000	•		GWB3598	
	2010.02-	Platform/Chassis Engine 199A3.000/263A2.000	•		GWB6774	
	2010.02-	Platform/Chassis Engine 199A3.000/263A2.000		o	GHA230086	K
	2010.02-	Platform/Chassis Engine 199A3.000/263A2.000 With ABS		o	GHA230128	
2010.02-	Platform/Chassis Engine 199A3.000/263A2.000 Without ABS		o	GHA230127		
1.4 (70 kW)	2010.02-	Box Body / Estate Engine 843A1.000	•		GWB3598	



	 YEAR		F	R	G-AP Ref.	KIT
FIAT						
DOBLO (263)						
1.4 (70 kW)	2010.02-	Box Body / Estate Engine 843A1.000	•		GWB6774	
	2010.02-	Box Body / Estate Engine 843A1.000		◦	GHA230086	K
	2010.02-	Box Body / Estate Engine 843A1.000 With ABS		◦	GHA230128	
	2010.02-	Box Body / Estate Engine 843A1.000 Without ABS		◦	GHA230127	
	2010.04-	Platform/Chassis Engine 843A1.000	•		GWB3598	
	2010.04-	Platform/Chassis Engine 843A1.000	•		GWB6774	
	2010.04-	Platform/Chassis Engine 843A1.000		◦	GHA230086	K
	2010.04-	Platform/Chassis Engine 843A1.000 With ABS		◦	GHA230128	
1.4 (88 kW)	2010.04-	Platform/Chassis Engine 843A1.000 Without ABS		◦	GHA230127	
	2011.10-	Box Body / Estate Engine 198A4.000	•		GWB3598	
	2011.10-	Box Body / Estate Engine 198A4.000	•		GWB6774	
	2011.10-	Box Body / Estate Engine 198A4.000		◦	GHA230086	K
1.4 Natural Power (88 kW)	2011.10-	Box Body / Estate Engine 198A4.000 With ABS		◦	GHA230128	
	2010.06-	Box Body / Estate Engine 198A4.000	•		GWB3599	
	2010.06-	Box Body / Estate Engine 198A4.000 With ABS		◦	GHA230128	
	2010.06-	Box Body / Estate Engine 198A4.000 Without ABS		◦	GHA230127	
1.6 D Multijet (66 kW)	2010.02-	Box Body / Estate Engine 263A4.000	•		GHA425028	
	2010.02-	Box Body / Estate Engine 263A4.000	•		GWB3598	
	2010.02-	Box Body / Estate Engine 263A4.000	•		GWB3599	
	2010.02-	Box Body / Estate Engine 263A4.000	•		GWB6774	
	2010.02-	Box Body / Estate Engine 263A4.000		◦	GHA230086	K
	2010.02-	Box Body / Estate Engine 263A4.000 With ABS		◦	GHA230128	
	2010.02-	Box Body / Estate Engine 263A4.000 Without ABS		◦	GHA230127	
	2010.02-	Platform/Chassis Engine 263A4.000	•		GHA425028	
	2010.02-	Platform/Chassis Engine 263A4.000	•		GWB3598	
	2010.02-	Platform/Chassis Engine 263A4.000	•		GWB3599	
	2010.02-	Platform/Chassis Engine 263A4.000	•		GWB6774	
	2010.02-	Platform/Chassis Engine 263A4.000		◦	GHA230086	K
1.6 D Multijet (74 kW)	2010.02-	Platform/Chassis Engine 263A4.000 With ABS		◦	GHA230128	
	2010.02-	Box Body / Estate Engine 263A3.000	•		GWB3598	
	2010.02-	Box Body / Estate Engine 263A3.000	•		GWB3599	
	2010.02-	Box Body / Estate Engine 263A3.000	•		GWB6774	
	2010.02-	Box Body / Estate Engine 263A3.000		◦	GHA230086	K
	2010.02-	Box Body / Estate Engine 263A3.000 With ABS		◦	GHA230128	
	2010.02-	Box Body / Estate Engine 263A3.000 Without ABS		◦	GHA230127	
	2011.02-	Platform/Chassis Engine 263A3.000	•		GWB3598	
	2011.02-	Platform/Chassis Engine 263A3.000	•		GWB3599	
	2011.02-	Platform/Chassis Engine 263A3.000	•		GWB6774	
	2011.02-	Platform/Chassis Engine 263A3.000		◦	GHA230086	K
	2011.02-	Platform/Chassis Engine 263A3.000 With ABS		◦	GHA230128	
1.6 D Multijet (77 kW)	2011.02-	Platform/Chassis Engine 263A3.000 Without ABS		◦	GHA230127	
	2010.02-	Box Body / Estate Engine 198A3.000	•		GHA425028	
	2010.02-	Box Body / Estate Engine 198A3.000	•		GWB3598	
	2010.02-	Box Body / Estate Engine 198A3.000	•		GWB3599	
	2010.02-	Box Body / Estate Engine 198A3.000	•		GWB6774	
	2010.02-	Box Body / Estate Engine 198A3.000		◦	GHA230086	K
	2010.02-	Box Body / Estate Engine 198A3.000		◦	GHA230128	
	2010.02-	Box Body / Estate Engine 198A3.000 With ABS		◦	GHA230128	
	2010.02-	Box Body / Estate Engine 198A3.000 Without ABS		◦	GHA230127	
	2010.02-	Platform/Chassis Engine 198A3.000	•		GHA425028	
	2010.02-	Platform/Chassis Engine 198A3.000	•		GWB3598	
	2010.02-	Platform/Chassis Engine 198A3.000	•		GWB3599	
2.0 D Multijet (99 kW)	2010.02-	Platform/Chassis Engine 198A3.000	•		GWB6774	
	2010.02-	Platform/Chassis Engine 198A3.000		◦	GHA230086	K
	2010.02-	Platform/Chassis Engine 198A3.000 With ABS		◦	GHA230128	
	2010.02-	Platform/Chassis Engine 198A3.000 Without ABS		◦	GHA230127	
	2010.02-	Box Body / Estate Engine 263A1.000	•		GHA425028	
	2010.02-	Box Body / Estate Engine 263A1.000	•		GWB3598	
	2010.02-	Box Body / Estate Engine 263A1.000	•		GWB3599	
	2010.02-	Box Body / Estate Engine 263A1.000		◦	GHA230086	K
	2010.02-	Box Body / Estate Engine 263A1.000 With ABS		◦	GHA230128	
	2010.02-	Box Body / Estate Engine 263A1.000 Without ABS		◦	GHA230127	
	2010.02-	Platform/Chassis Engine 163A1.000	•		GHA425028	
	2010.02-	Platform/Chassis Engine 163A1.000	•		GWB3598	



	 YEAR		F	R	G-AP Ref.	KIT
FIAT						
DOBLO (263)						
2.0 D Multijet (99 kW)	2010.02-	Platform/Chassis Engine 163A1.000	•		GWB3599	
	2010.02-	Platform/Chassis Engine 163A1.000		○	GHA230086	K
	2010.02-	Platform/Chassis Engine 163A1.000 With ABS		○	GHA230128	
	2010.02-	Platform/Chassis Engine 163A1.000 Without ABS		○	GHA230127	
DOBLO CARGO (223)						
1.2 (48 kW)	2001.03-	Box Engine 223A5.000	•		GHA422007	
	2001.03-	Box Engine 223A5.000	•		GWB3416	
	2001.03-	Box Engine 223A5.000	•		GWB3581	
	2001.03-	Box Engine 223A5.000 With ABS		○	GHA230047	K
1.3 D Multijet (55 kW)	2005.10-2010.01	Box Engine 199A2.000	•		GWB1439	
	2005.10-2010.01	Box Engine 199A2.000	•		GWB3539	
	2005.10-2010.01	Box Engine 199A2.000	•		GWB6540	
	2005.10-2010.01	Box Engine 199A2.000 With ABS		○	GHA230047	K
1.3 JTD 16V (51 kW)	2004.02-2006.01	Box Engine 188A9.000/188A8.000	•		GWB1439	
	2004.02-2006.01	Box Engine 188A9.000/188A8.000	•		GWB3539	
	2004.02-2006.01	Box Engine 188A9.000/188A8.000	•		GWB6540	
	2004.02-2006.01	Box Engine 188A9.000/188A8.000 With ABS		○	GHA230047	K
1.3 JTD 16V Multijet (62 kW)	2006.08-	Box Engine 223A9.000	•		GWB1439	
	2006.08-	Box Engine 223A9.000	•		GWB3539	
	2006.08-	Box Engine 223A9.000	•		GWB6540	
	2006.08-	Box Engine 223A9.000 With ABS		○	GHA230047	K
1.4 (57 kW)	2005.10-	Box Engine 350A1.000	•		GWB3416	
	2005.10-	Box Engine 350A1.000	•		GWB3581	
	2005.10-	Box Engine 350A1.000 With ABS		○	GHA230047	K
1.6 16V (76 kW)	2001.10-	Box Engine 182B6.000	•		GHA422007	
	2001.10-	Box Engine 182B6.000	•		GWB3416	
	2001.10-	Box Engine 182B6.000	•		GWB3581	
	2001.10-	Box Engine 182B6.000 With ABS		○	GHA230047	K
1.6 Natural Power (76 kW)	2002.09-	Box Engine 182B6.000	•		GWB1439	
	2002.09-	Box Engine 182B6.000	•		GWB3539	
	2002.09-	Box Engine 182B6.000	•		GWB6540	
	2002.09-	Box Engine 182B6.000 With ABS		○	GHA230047	K
1.9 D (46 kW)	2001.03-	Box Engine 223A6.000	•		GHA422007	
	2001.03-	Box Engine 223A6.000	•		GWB3416	
	2001.03-	Box Engine 223A6.000	•		GWB3581	
	2001.03-	Box Engine 223A6.000 With ABS		○	GHA230047	K
1.9 JTD (74 kW)	2001.10-	Box Engine 182B9.000	•		GHA425009	
	2001.10-	Box Engine 182B9.000	•		GWB1439	
	2001.10-	Box Engine 182B9.000	•		GWB3539	
	2001.10-	Box Engine 182B9.000	•		GWB6540	
	2001.10-	Box Engine 182B9.000 With ABS		○	GHA230047	K
1.9 JTD (77 kW)	2003.07-	Box Engine 223A7.000/223B1.000	•		GHA425009	
	2003.07-	Box Engine 223A7.000/223B1.000	•		GWB1439	
	2003.07-	Box Engine 223A7.000/223B1.000	•		GWB3539	
	2003.07-	Box Engine 223A7.000/223B1.000	•		GWB6540	
	2003.07-	Box Engine 223A7.000/223B1.000 With ABS		○	GHA230047	K
1.9 JTD Multijet (88 kW)	2006.12-	Box Engine 186A9.000	•		GWB1439	
	2006.12-	Box Engine 186A9.000	•		GWB3539	
	2006.12-	Box Engine 186A9.000	•		GWB6540	
	2006.12-	Box Engine 186A9.000 With ABS		○	GHA230047	K
DOBLO MPV (223, 119)						
1.6 (68 kW)	2002.09-	MPV Engine 182 B6.000	•		GWB3416	
	2002.09-	MPV Engine 182 B6.000	•		GWB3581	
	2002.09-	MPV Engine 182 B6.000 With ABS		○	GHA230047	K
DUCATO (230)						
1.9 D (50 kW)	1998.04-2002.04	Bus Engine D9B/D9B(XUD9A)/DJY	•		GHA428004	
	1998.04-2002.04	Bus Engine D9B/D9B(XUD9A)/DJY	•		GHA435001	
	1998.04-2002.04	Bus Engine D9B/D9B(XUD9A)/DJY	•		GWB1444	
	1998.04-2002.04	Bus Engine D9B/D9B(XUD9A)/DJY	•		GWB3428	
	1998.04-2002.04	Bus Engine D9B/D9B(XUD9A)/DJY	•		GWB3640	
	1998.04-2002.04	Bus Engine D9B/D9B(XUD9A)/DJY	•		GWB3641	
	1998.04-2002.04	Bus Engine D9B/D9B(XUD9A)/DJY		○	GWB3429	
	1998.04-2002.04	Bus Engine D9B/D9B(XUD9A)/DJY		○	GWB3430	
	1998.04-2002.04	Bus Engine D9B/D9B(XUD9A)/DJY		○	GWB3642	



	 YEAR		F	R	G-AP Ref.	KIT	
FIAT							
DUCATO (230)							
1.9 D (50 kW)	1998.04-2002.04	Platform/Chassis Engine DJY	•		GHA428004		
	1998.04-2002.04	Platform/Chassis Engine DJY	•		GHA435001		
	1998.04-2002.04	Platform/Chassis Engine DJY	•		GWB1444		
	1998.04-2002.04	Platform/Chassis Engine DJY	•		GWB3428		
	1998.04-2002.04	Platform/Chassis Engine DJY	•		GWB3640		
	1998.04-2002.04	Platform/Chassis Engine DJY	•		GWB3641		
	1998.04-2002.04	Platform/Chassis Engine DJY		o	GWB3429		
	1998.04-2002.04	Platform/Chassis Engine DJY		o	GWB3430		
	1998.04-2002.04	Platform/Chassis Engine DJY		o	GWB3642		
1.9 D (51 kW)	1994.03-2002.04	Platform/Chassis Engine 230A2.000	•		GHA428004		
	1994.03-2002.04	Platform/Chassis Engine 230A2.000	•		GHA435001		
	1994.03-2002.04	Platform/Chassis Engine 230A2.000	•		GWB1444		
	1994.03-2002.04	Platform/Chassis Engine 230A2.000	•		GWB3428		
	1994.03-2002.04	Platform/Chassis Engine 230A2.000	•		GWB3640		
	1994.03-2002.04	Platform/Chassis Engine 230A2.000	•		GWB3641		
	1994.03-2002.04	Platform/Chassis Engine 230A2.000		o	GWB3429		
	1994.03-2002.04	Platform/Chassis Engine 230A2.000		o	GWB3430		
	1994.03-2002.04	Platform/Chassis Engine 230A2.000		o	GWB3642		
1.9 D (59 kW)	1998.05-2001.11	Bus Engine DHX	•		GHA428004		
1.9 D Combinato (51 kW)	1995.06-2002.04	Bus Engine 230A2.000	•		GHA428004		
	1995.06-2002.04	Bus Engine 230A2.000	•		GHA435001		
	1995.06-2002.04	Bus Engine 230A2.000	•		GWB1444		
	1995.06-2002.04	Bus Engine 230A2.000	•		GWB3428		
	1995.06-2002.04	Bus Engine 230A2.000	•		GWB3640		
	1995.06-2002.04	Bus Engine 230A2.000	•		GWB3641		
	1995.06-2002.04	Bus Engine 230A2.000		o	GWB3429		
	1995.06-2002.04	Bus Engine 230A2.000		o	GWB3430		
	1995.06-2002.04	Bus Engine 230A2.000		o	GWB3642		
1.9 TD (60 kW)	1994.03-2002.04	Platform/Chassis Engine 230A3.000	•		GHA428004		
	1994.03-2002.04	Platform/Chassis Engine 230A3.000	•		GHA435001		
	1994.03-2002.04	Platform/Chassis Engine 230A3.000	•		GWB1444		
	1994.03-2002.04	Platform/Chassis Engine 230A3.000	•		GWB3428		
	1994.03-2002.04	Platform/Chassis Engine 230A3.000	•		GWB3640		
	1994.03-2002.04	Platform/Chassis Engine 230A3.000	•		GWB3641		
	1994.03-2002.04	Platform/Chassis Engine 230A3.000		o	GWB3429		
	1994.03-2002.04	Platform/Chassis Engine 230A3.000		o	GWB3430		
	1994.03-2002.04	Platform/Chassis Engine 230A3.000		o	GWB3642		
1.9 TD (66 kW)	1998.04-2002.04	Bus Engine DHX(XUD9TF/L)	•		GHA428004		
	1998.04-2002.04	Bus Engine DHX(XUD9TF/L)	•		GHA435001		
	1998.04-2002.04	Bus Engine DHX(XUD9TF/L)	•		GWB1444		
	1998.04-2002.04	Bus Engine DHX(XUD9TF/L)	•		GWB3428		
	1998.04-2002.04	Bus Engine DHX(XUD9TF/L)	•		GWB3640		
	1998.04-2002.04	Bus Engine DHX(XUD9TF/L)	•		GWB3641		
	1998.04-2002.04	Bus Engine DHX(XUD9TF/L)		o	GWB3429		
	1998.04-2002.04	Bus Engine DHX(XUD9TF/L)		o	GWB3430		
	1998.04-2002.04	Bus Engine DHX(XUD9TF/L)		o	GWB3642		
	1998.04-2002.04	Platform/Chassis Engine DHX(XUD9TF/L)	•		GHA428004		
	1998.04-2002.04	Platform/Chassis Engine DHX(XUD9TF/L)	•		GHA435001		
	1998.04-2002.04	Platform/Chassis Engine DHX(XUD9TF/L)	•		GWB1444		
	1998.04-2002.04	Platform/Chassis Engine DHX(XUD9TF/L)	•		GWB3428		
	1998.04-2002.04	Platform/Chassis Engine DHX(XUD9TF/L)	•		GWB3640		
	1998.04-2002.04	Platform/Chassis Engine DHX(XUD9TF/L)	•		GWB3641		
	1998.04-2002.04	Platform/Chassis Engine DHX(XUD9TF/L)		o	GWB3429		
	1998.04-2002.04	Platform/Chassis Engine DHX(XUD9TF/L)		o	GWB3430		
	1998.04-2002.04	Platform/Chassis Engine DHX(XUD9TF/L)		o	GWB3642		
	1.9 TD CAT (59 kW)	1994.08-2002.04	Platform/Chassis Engine 230A4.000	•		GHA428004	
		1994.08-2002.04	Platform/Chassis Engine 230A4.000	•		GHA435001	
		1994.08-2002.04	Platform/Chassis Engine 230A4.000	•		GWB1444	
1994.08-2002.04		Platform/Chassis Engine 230A4.000	•		GWB3428		
1994.08-2002.04		Platform/Chassis Engine 230A4.000	•		GWB3640		
1994.08-2002.04		Platform/Chassis Engine 230A4.000	•		GWB3641		
1994.08-2002.04		Platform/Chassis Engine 230A4.000		o	GWB3429		
1994.08-2002.04		Platform/Chassis Engine 230A4.000		o	GWB3430		
1994.08-2002.04		Platform/Chassis Engine 230A4.000		o	GWB3642		



	 YEAR		F	R	G-AP Ref.	KIT
FIAT						
DUCATO (230)						
1.9 TD Combinato (59 kW)	1994.08-2002.04	Bus Engine 230A4.000	•		GHA428004	
	1994.08-2002.04	Bus Engine 230A4.000	•		GHA435001	
	1994.08-2002.04	Bus Engine 230A4.000	•		GWB1444	
	1994.08-2002.04	Bus Engine 230A4.000	•		GWB3428	
	1994.08-2002.04	Bus Engine 230A4.000	•		GWB3640	
	1994.08-2002.04	Bus Engine 230A4.000	•		GWB3641	
	1994.08-2002.04	Bus Engine 230A4.000		o	GWB3429	
	1994.08-2002.04	Bus Engine 230A4.000		o	GWB3430	
	1994.08-2002.04	Bus Engine 230A4.000		o	GWB3642	
1.9 TD Panorama/Combinato (60 kW)	1994.03-2002.04	Bus Engine 230A3.000	•		GHA428004	
	1994.03-2002.04	Bus Engine 230A3.000	•		GHA435001	
	1994.03-2002.04	Bus Engine 230A3.000	•		GWB1444	
	1994.03-2002.04	Bus Engine 230A3.000	•		GWB3428	
	1994.03-2002.04	Bus Engine 230A3.000	•		GWB3640	
	1994.03-2002.04	Bus Engine 230A3.000	•		GWB3641	
	1994.03-2002.04	Bus Engine 230A3.000		o	GWB3429	
	1994.03-2002.04	Bus Engine 230A3.000		o	GWB3430	
	1994.03-2002.04	Bus Engine 230A3.000		o	GWB3642	
2.0 (80 kW)	1998.06-2002.04	Platform/Chassis Engine RFW	•		GHA428004	
	1998.06-2002.04	Platform/Chassis Engine RFW	•		GWB1444	
	1998.06-2002.04	Platform/Chassis Engine RFW	•		GWB3428	
	1998.06-2002.04	Platform/Chassis Engine RFW	•		GWB3640	
	1998.06-2002.04	Platform/Chassis Engine RFW	•		GWB3641	
	1998.06-2002.04	Platform/Chassis Engine RFW		o	GWB3429	
	1998.06-2002.04	Platform/Chassis Engine RFW		o	GWB3430	
	1998.06-2002.04	Platform/Chassis Engine RFW		o	GWB3642	
2.0 4x4 (80 kW)	1994.11-2001.11	Bus Engine RFW	•		GHA428004	
	1994.11-2001.11	Bus Engine RFW	•		GHA435002	
	1994.11-2001.11	Bus Engine RFW	•		GWB1444	
	1994.11-2001.11	Bus Engine RFW	•		GWB3428	
	1994.11-2001.11	Bus Engine RFW	•		GWB3640	
	1994.11-2001.11	Bus Engine RFW	•		GWB3641	
	1994.11-2001.11	Bus Engine RFW		o	GWB3679	
2.0 JTD (62 kW)	2001.07-2002.04	Platform/Chassis Engine RHV(DW10)	•		GHA428004	
	2001.07-2002.04	Platform/Chassis Engine RHV(DW10)	•		GWB1444	
	2001.07-2002.04	Platform/Chassis Engine RHV(DW10)	•		GWB3428	
	2001.07-2002.04	Platform/Chassis Engine RHV(DW10)	•		GWB3640	
	2001.07-2002.04	Platform/Chassis Engine RHV(DW10)	•		GWB3641	
	2001.07-2002.04	Platform/Chassis Engine RHV(DW10)		o	GWB3429	
	2001.07-2002.04	Platform/Chassis Engine RHV(DW10)		o	GWB3430	
	2001.07-2002.04	Platform/Chassis Engine RHV(DW10)		o	GWB3642	
	2001.10-2002.04	Bus Engine RHV(DW10)	•		GHA435001	
	2001.10-2002.04	Bus Engine RHV(DW10)	•		GWB1444	
	2001.10-2002.04	Bus Engine RHV(DW10)	•		GWB3428	
	2001.10-2002.04	Bus Engine RHV(DW10)	•		GWB3640	
	2001.10-2002.04	Bus Engine RHV(DW10)	•		GWB3641	
	2001.10-2002.04	Bus Engine RHV(DW10)		o	GWB3429	
	2001.10-2002.04	Bus Engine RHV(DW10)		o	GWB3430	
	2001.10-2002.04	Bus Engine RHV(DW10)		o	GWB3642	
2.0 Panorama/Combinato (80 kW)	1994.03-2002.04	Bus Engine RFW	•		GHA428004	
	1994.03-2002.04	Bus Engine RFW	•		GHA435002	
	1994.03-2002.04	Bus Engine RFW	•		GWB1444	
	1994.03-2002.04	Bus Engine RFW	•		GWB3428	
	1994.03-2002.04	Bus Engine RFW	•		GWB3640	
	1994.03-2002.04	Bus Engine RFW	•		GWB3641	
	1994.03-2002.04	Bus Engine RFW		o	GWB3429	
	1994.03-2002.04	Bus Engine RFW		o	GWB3430	
	1994.03-2002.04	Bus Engine RFW		o	GWB3642	
2.5 D (62 kW)	1994.03-2002.04	Platform/Chassis Engine 8140.67	•		GHA428004	
	1994.03-2002.04	Platform/Chassis Engine 8140.67	•		GHA435001	
	1994.03-2002.04	Platform/Chassis Engine 8140.67	•		GWB1444	
	1994.03-2002.04	Platform/Chassis Engine 8140.67	•		GWB3428	
	1994.03-2002.04	Platform/Chassis Engine 8140.67	•		GWB3640	
	1994.03-2002.04	Platform/Chassis Engine 8140.67	•		GWB3641	



	 YEAR		F	R	G-AP Ref.	KIT
FIAT						
DUCATO (230)						
2.5 D (62 kW)	1994.03-2002.04	Platform/Chassis Engine 8140.67		o	GWB3429	
	1994.03-2002.04	Platform/Chassis Engine 8140.67		o	GWB3430	
	1994.03-2002.04	Platform/Chassis Engine 8140.67		o	GWB3642	
2.5 D 4x4 (62 kW)	1994.03-2002.04	Platform/Chassis Engine 8140.67	•		GHA428004	
	1994.03-2002.04	Platform/Chassis Engine 8140.67	•		GHA435001	
	1994.03-2002.04	Platform/Chassis Engine 8140.67	•		GWB1444	
	1994.03-2002.04	Platform/Chassis Engine 8140.67	•		GWB3428	
	1994.03-2002.04	Platform/Chassis Engine 8140.67	•		GWB3640	
	1994.03-2002.04	Platform/Chassis Engine 8140.67	•		GWB3641	
	1994.03-2002.04	Platform/Chassis Engine 8140.67		o	GWB3679	
2.5 D Combinato (62 kW)	1994.08-2002.04	Bus Engine 8140.67	•		GHA428004	
	1994.08-2002.04	Bus Engine 8140.67	•		GHA435001	
	1994.08-2002.04	Bus Engine 8140.67	•		GWB1444	
	1994.08-2002.04	Bus Engine 8140.67	•		GWB3428	
	1994.08-2002.04	Bus Engine 8140.67	•		GWB3640	
	1994.08-2002.04	Bus Engine 8140.67	•		GWB3641	
	1994.08-2002.04	Bus Engine 8140.67		o	GWB3429	
	1994.08-2002.04	Bus Engine 8140.67		o	GWB3430	
	1994.08-2002.04	Bus Engine 8140.67		o	GWB3642	
	1994.08-2002.04	Bus Engine 8140.67		o	GWB3642	
2.5 TD (80 kW)	1994.06-1998.08	Bus Engine 8140.47	•		GHA428004	
	1994.06-1998.08	Bus Engine 8140.47	•		GWB1444	
	1994.06-1998.08	Bus Engine 8140.47	•		GWB3428	
	1994.06-1998.08	Bus Engine 8140.47		o	GWB3429	
	1994.06-1998.08	Bus Engine 8140.47		o	GWB3430	
	1994.06-1998.08	Platform/Chassis Engine 8140.47	•		GHA428004	
	1994.06-1998.08	Platform/Chassis Engine 8140.47	•		GWB1444	
	1994.06-1998.08	Platform/Chassis Engine 8140.47	•		GWB3428	
2.5 TD (85 kW)	1994.06-1998.08	Platform/Chassis Engine 8140.47		o	GWB3429	
	1994.06-1998.08	Platform/Chassis Engine 8140.47		o	GWB3430	
	1994.06-1998.08	Platform/Chassis Engine 8140.47	•		GHA428004	
	1994.06-1998.08	Platform/Chassis Engine 8140.47	•		GWB1444	
	1994.06-1998.08	Platform/Chassis Engine 8140.47	•		GWB3428	
	1994.06-1998.08	Platform/Chassis Engine 8140.47		o	GWB3429	
2.5 TD 4x4 (80 kW)	1994.11-1998.04	Platform/Chassis Engine 8140.47	•		GWB3430	
	1994.11-1998.04	Platform/Chassis Engine 8140.47	•		GHA428004	
	1994.11-1998.04	Platform/Chassis Engine 8140.47	•		GWB1444	
	1994.11-1998.04	Platform/Chassis Engine 8140.47	•		GWB3428	
	1994.11-1998.04	Platform/Chassis Engine 8140.47	•		GHA428004	
2.5 TD 4x4 (85 kW)	1994.11-1998.04	Platform/Chassis Engine 8140.47	•		GHA428004	
	1994.11-1998.04	Platform/Chassis Engine 8140.47	•		GWB1444	
	1994.11-1998.04	Platform/Chassis Engine 8140.47	•		GWB3428	
2.5 TDi (80 kW)	1994.03-2002.04	Platform/Chassis Engine 8140.47R	•		GHA428004	
	1994.03-2002.04	Platform/Chassis Engine 8140.47R	•		GHA435001	
	1994.03-2002.04	Platform/Chassis Engine 8140.47R	•		GWB1444	
	1994.03-2002.04	Platform/Chassis Engine 8140.47R	•		GWB3428	
	1994.03-2002.04	Platform/Chassis Engine 8140.47R	•		GWB3640	
	1994.03-2002.04	Platform/Chassis Engine 8140.47R	•		GWB3641	
	1994.03-2002.04	Platform/Chassis Engine 8140.47R		o	GWB3429	
	1994.03-2002.04	Platform/Chassis Engine 8140.47R		o	GWB3430	
2.5 TDi (85 kW)	1994.03-2002.04	Platform/Chassis Engine 8140.47		o	GWB3642	
	1994.03-2002.04	Platform/Chassis Engine 8140.47	•		GHA428004	
	1994.03-2002.04	Platform/Chassis Engine 8140.47	•		GHA435001	
	1994.03-2002.04	Platform/Chassis Engine 8140.47	•		GWB1444	
	1994.03-2002.04	Platform/Chassis Engine 8140.47	•		GWB3428	
	1994.03-2002.04	Platform/Chassis Engine 8140.47	•		GWB3640	
	1994.03-2002.04	Platform/Chassis Engine 8140.47	•		GWB3641	
	1994.03-2002.04	Platform/Chassis Engine 8140.47		o	GWB3429	
	1994.03-2002.04	Platform/Chassis Engine 8140.47		o	GWB3430	
2.5 TDi 4x4 (85 kW)	1997.04-2002.04	Platform/Chassis Engine 8140.47		o	GWB3642	
	1997.04-2002.04	Bus Engine 8140.47	•		GHA428004	
	1997.04-2002.04	Bus Engine 8140.47	•		GHA435001	
	1997.04-2002.04	Bus Engine 8140.47	•		GWB1444	
	1997.04-2002.04	Bus Engine 8140.47	•		GWB3428	



	 YEAR		F	R	G-AP Ref.	KIT	
FIAT							
DUCATO (230)							
2.5 TDi 4x4 (85 kW)	1997.04-2002.04	Bus Engine 8140.47	•		GWB3640		
	1997.04-2002.04	Bus Engine 8140.47	•		GWB3641		
	1997.04-2002.04	Bus Engine 8140.47		○	GWB3679		
	1998.06-2002.04	Platform/Chassis Engine 8140.47	•		GHA428004		
	1998.06-2002.04	Platform/Chassis Engine 8140.47	•		GHA435001		
	1998.06-2002.04	Platform/Chassis Engine 8140.47	•		GWB1444		
	1998.06-2002.04	Platform/Chassis Engine 8140.47	•		GWB3428		
	1998.06-2002.04	Platform/Chassis Engine 8140.47	•		GWB3640		
	1998.06-2002.04	Platform/Chassis Engine 8140.47	•		GWB3641		
	1998.06-2002.04	Platform/Chassis Engine 8140.47		○	GWB3679		
	2.5 TDi Panorama/Combinato (80 kW)	1994.07-2002.04	Bus Engine 8140.47R	•		GHA428004	
		1994.07-2002.04	Bus Engine 8140.47R	•		GHA435001	
		1994.07-2002.04	Bus Engine 8140.47R	•		GWB1444	
		1994.07-2002.04	Bus Engine 8140.47R	•		GWB3428	
1994.07-2002.04		Bus Engine 8140.47R	•		GWB3640		
1994.07-2002.04		Bus Engine 8140.47R	•		GWB3641		
1994.07-2002.04		Bus Engine 8140.47R		○	GWB3429		
1994.07-2002.04		Bus Engine 8140.47R		○	GWB3430		
1994.07-2002.04		Bus Engine 8140.47R		○	GWB3642		
2.5 TDi Panorama/Combinato (85 kW)		1994.03-2002.04	Bus Engine 8140.47	•		GHA428004	
	1994.03-2002.04	Bus Engine 8140.47	•		GHA435001		
	1994.03-2002.04	Bus Engine 8140.47	•		GWB1444		
	1994.03-2002.04	Bus Engine 8140.47	•		GWB3428		
	1994.03-2002.04	Bus Engine 8140.47	•		GWB3640		
	1994.03-2002.04	Bus Engine 8140.47	•		GWB3641		
	1994.03-2002.04	Bus Engine 8140.47		○	GWB3429		
	1994.03-2002.04	Bus Engine 8140.47		○	GWB3430		
	1994.03-2002.04	Bus Engine 8140.47		○	GWB3642		
	2.8 D (64 kW)	1998.02-2002.04	Bus Engine 8140.63	•		GHA428004	
1998.02-2002.04		Bus Engine 8140.63	•		GHA435001		
1998.02-2002.04		Bus Engine 8140.63	•		GWB1444		
1998.02-2002.04		Bus Engine 8140.63	•		GWB3428		
1998.02-2002.04		Bus Engine 8140.63	•		GWB3640		
1998.02-2002.04		Bus Engine 8140.63	•		GWB3641		
1998.02-2002.04		Bus Engine 8140.63		○	GWB3429		
1998.02-2002.04		Bus Engine 8140.63		○	GWB3430		
1998.02-2002.04		Bus Engine 8140.63		○	GWB3642		
1998.02-2002.04		Platform/Chassis Engine 8140.63	•		GHA428004		
1998.02-2002.04		Platform/Chassis Engine 8140.63	•		GHA435001		
1998.02-2002.04		Platform/Chassis Engine 8140.63	•		GWB1444		
1998.02-2002.04		Platform/Chassis Engine 8140.63	•		GWB3428		
1998.02-2002.04		Platform/Chassis Engine 8140.63	•		GWB3640		
1998.02-2002.04		Platform/Chassis Engine 8140.63	•		GWB3641		
1998.02-2002.04		Platform/Chassis Engine 8140.63		○	GWB3429		
1998.02-2002.04		Platform/Chassis Engine 8140.63		○	GWB3430		
1998.02-2002.04		Platform/Chassis Engine 8140.63		○	GWB3642		
2.8 iDTD 4x4 (90 kW)		1998.05-2001.09	Platform/Chassis Engine 8140.43	•		GHA428004	
		1998.05-2001.09	Platform/Chassis Engine 8140.43	•		GHA435001	
	1998.05-2001.09	Platform/Chassis Engine 8140.43	•		GHA435002		
	1998.05-2001.09	Platform/Chassis Engine 8140.43	•		GWB1444		
	1998.05-2001.09	Platform/Chassis Engine 8140.43	•		GWB3428		
2.8 JTD (94 kW)	2000.11-2002.04	Bus Engine 8140.43S	•		GHA428004		
	2000.11-2002.04	Bus Engine 8140.43S	•		GHA435001		
	2000.11-2002.04	Bus Engine 8140.43S	•		GHA435002		
	2000.11-2002.04	Bus Engine 8140.43S	•		GWB1444		
	2000.11-2002.04	Bus Engine 8140.43S	•		GWB3428		
	2000.11-2002.04	Bus Engine 8140.43S	•		GWB3640		
	2000.11-2002.04	Bus Engine 8140.43S	•		GWB3641		
	2000.11-2002.04	Bus Engine 8140.43S		○	GWB3429		
	2000.11-2002.04	Bus Engine 8140.43S		○	GWB3430		
	2000.11-2002.04	Bus Engine 8140.43S		○	GWB3642		
	2000.11-2002.04	Platform/Chassis Engine 8140.43S	•		GHA428004		
	2000.11-2002.04	Platform/Chassis Engine 8140.43S	•		GHA435001		
	2000.11-2002.04	Platform/Chassis Engine 8140.43S	•		GHA435002		
	2000.11-2002.04	Platform/Chassis Engine 8140.43S	•		GWB1444		



	 YEAR		F	R	G-AP Ref.	KIT
FIAT						
DUCATO (230)						
2.8 JTD (94 kW)	2000.11-2002.04	Platform/Chassis Engine 8140.43S	•		GWB1444	
	2000.11-2002.04	Platform/Chassis Engine 8140.43S	•		GWB3428	
	2000.11-2002.04	Platform/Chassis Engine 8140.43S	•		GWB3640	
	2000.11-2002.04	Platform/Chassis Engine 8140.43S	•		GWB3641	
	2000.11-2002.04	Platform/Chassis Engine 8140.43S		○	GWB3429	
	2000.11-2002.04	Platform/Chassis Engine 8140.43S		○	GWB3430	
	2000.11-2002.04	Platform/Chassis Engine 8140.43S		○	GWB3642	
	2001.03-2002.04	Platform/Chassis Engine 8140.43S	•		GHA428004	
	2001.03-2002.04	Platform/Chassis Engine 8140.43S	•		GHA435001	
	2001.03-2002.04	Platform/Chassis Engine 8140.43S	•		GHA435002	
	2001.03-2002.04	Platform/Chassis Engine 8140.43S	•		GWB1444	
	2001.03-2002.04	Platform/Chassis Engine 8140.43S	•		GWB3428	
	2001.03-2002.04	Platform/Chassis Engine 8140.43S	•		GWB3640	
	2001.03-2002.04	Platform/Chassis Engine 8140.43S	•		GWB3641	
	2001.03-2002.04	Platform/Chassis Engine 8140.43S		○	GWB3429	
	2001.03-2002.04	Platform/Chassis Engine 8140.43S		○	GWB3430	
	2001.03-2002.04	Platform/Chassis Engine 8140.43S		○	GWB3642	
2.8 JTD 4x4 (94 kW)	2000.11-2002.04	Bus Engine 8140.43S	•		GHA428004	
	2000.11-2002.04	Bus Engine 8140.43S	•		GHA435001	
	2000.11-2002.04	Bus Engine 8140.43S	•		GHA435002	
	2000.11-2002.04	Bus Engine 8140.43S	•		GWB1444	
	2000.11-2002.04	Bus Engine 8140.43S	•		GWB3428	
	2000.11-2002.04	Bus Engine 8140.43S	•		GWB3640	
	2000.11-2002.04	Bus Engine 8140.43S	•		GWB3641	
	2000.11-2002.04	Bus Engine 8140.43S		○	GWB3679	
	2001.10-2002.04	Platform/Chassis Engine 8140.43S	•		GHA428004	
	2001.10-2002.04	Platform/Chassis Engine 8140.43S	•		GHA435002	
	2001.10-2002.04	Platform/Chassis Engine 8140.43S	•		GWB1444	
	2001.10-2002.04	Platform/Chassis Engine 8140.43S	•		GWB3428	
	2001.10-2002.04	Platform/Chassis Engine 8140.43S	•		GWB3640	
	2001.10-2002.04	Platform/Chassis Engine 8140.43S	•		GWB3641	
	2001.10-2002.04	Platform/Chassis Engine 8140.43S		○	GWB3679	
2.8 TD 4x4 (64 kW)	1998.05-2001.11	Platform/Chassis Engine 8140.63	•		GHA428004	
	1998.05-2001.11	Platform/Chassis Engine 8140.63	•		GWB1444	
	1998.05-2001.11	Platform/Chassis Engine 8140.63	•		GWB3428	
	1998.05-2001.11	Platform/Chassis Engine 8140.63	•		GWB3640	
	1998.05-2001.11	Platform/Chassis Engine 8140.63	•		GWB3641	
	1998.05-2001.11	Platform/Chassis Engine 8140.63		○	GWB3679	
2.8 TDi (90 kW)	1997.10-2002.04	Bus Engine 8140.43	•		GHA428004	
	1997.10-2002.04	Bus Engine 8140.43	•		GHA435001	
	1997.10-2002.04	Bus Engine 8140.43	•		GHA435002	
	1997.10-2002.04	Bus Engine 8140.43	•		GWB1444	
	1997.10-2002.04	Bus Engine 8140.43	•		GWB3428	
	1997.10-2002.04	Bus Engine 8140.43	•		GWB3640	
	1997.10-2002.04	Bus Engine 8140.43	•		GWB3641	
	1997.10-2002.04	Bus Engine 8140.43		○	GWB3429	
	1997.10-2002.04	Bus Engine 8140.43		○	GWB3430	
	1997.10-2002.04	Bus Engine 8140.43		○	GWB3642	
	1998.12-2002.04	Platform/Chassis Engine 8140.43	•		GHA428004	
	1998.12-2002.04	Platform/Chassis Engine 8140.43	•		GHA435001	
	1998.12-2002.04	Platform/Chassis Engine 8140.43	•		GHA435002	
	1998.12-2002.04	Platform/Chassis Engine 8140.43	•		GWB1444	
	1998.12-2002.04	Platform/Chassis Engine 8140.43	•		GWB3428	
	1998.12-2002.04	Platform/Chassis Engine 8140.43	•		GWB3640	
	1998.12-2002.04	Platform/Chassis Engine 8140.43	•		GWB3641	
	1998.12-2002.04	Platform/Chassis Engine 8140.43		○	GWB3429	
	1998.12-2002.04	Platform/Chassis Engine 8140.43		○	GWB3430	
	1998.12-2002.04	Platform/Chassis Engine 8140.43		○	GWB3642	
2.8 TDi 4x4 (90 kW)	1999.07-2002.04	Bus Engine 8140.43	•		GHA428004	
	1999.07-2002.04	Bus Engine 8140.43	•		GHA435001	
	1999.07-2002.04	Bus Engine 8140.43	•		GHA435002	
	1999.07-2002.04	Bus Engine 8140.43	•		GWB1444	
	1999.07-2002.04	Bus Engine 8140.43	•		GWB3428	
	1999.07-2002.04	Bus Engine 8140.43	•		GWB3640	



	 YEAR		F	R	G-AP Ref.	KIT
FIAT						
DUCATO (230)						
2.8 TDi 4x4 (90 kW)	1999.07-2002.04	Bus Engine 8140.43	•		GWB3641	
	1999.07-2002.04	Bus Engine 8140.43		o	GWB3679	
DUCATO (230L)						
1.9 D (50 kW)	1998.04-2002.04	Box Engine DJY	•		GHA428004	
	1998.04-2002.04	Box Engine DJY	•		GHA435001	
	1998.04-2002.04	Box Engine DJY	•		GWB1444	
	1998.04-2002.04	Box Engine DJY	•		GWB3428	
	1998.04-2002.04	Box Engine DJY	•		GWB3640	
	1998.04-2002.04	Box Engine DJY	•		GWB3641	
	1998.04-2002.04	Box Engine DJY		o	GWB3429	
	1998.04-2002.04	Box Engine DJY		o	GWB3430	
1.9 D (51 kW)	1994.03-2002.04	Box Engine 230A2.000	•		GHA428004	
	1994.03-2002.04	Box Engine 230A2.000	•		GHA435001	
	1994.03-2002.04	Box Engine 230A2.000	•		GWB1444	
	1994.03-2002.04	Box Engine 230A2.000	•		GWB3428	
	1994.03-2002.04	Box Engine 230A2.000	•		GWB3640	
	1994.03-2002.04	Box Engine 230A2.000	•		GWB3641	
	1994.03-2002.04	Box Engine 230A2.000		o	GWB3429	
	1994.03-2002.04	Box Engine 230A2.000		o	GWB3430	
1.9 TD (59 kW)	1998.05-2001.11	Box Engine DHX	•		GHA428004	
1.9 TD (60 kW)	1994.03-2002.04	Box Engine 230A3.000	•		GHA428004	
	1994.03-2002.04	Box Engine 230A3.000	•		GHA435001	
	1994.03-2002.04	Box Engine 230A3.000	•		GWB1444	
	1994.03-2002.04	Box Engine 230A3.000	•		GWB3428	
	1994.03-2002.04	Box Engine 230A3.000	•		GWB3640	
	1994.03-2002.04	Box Engine 230A3.000	•		GWB3641	
	1994.03-2002.04	Box Engine 230A3.000		o	GWB3429	
	1994.03-2002.04	Box Engine 230A3.000		o	GWB3430	
1.9 TD (66 kW)	1994.03-2002.04	Box Engine 230A3.000		o	GWB3642	
	1998.04-2002.04	Box Engine DHX(XUD9TF/L)	•		GHA428004	
	1998.04-2002.04	Box Engine DHX(XUD9TF/L)	•		GHA435001	
	1998.04-2002.04	Box Engine DHX(XUD9TF/L)	•		GWB1444	
	1998.04-2002.04	Box Engine DHX(XUD9TF/L)	•		GWB3428	
	1998.04-2002.04	Box Engine DHX(XUD9TF/L)	•		GWB3640	
	1998.04-2002.04	Box Engine DHX(XUD9TF/L)	•		GWB3641	
	1998.04-2002.04	Box Engine DHX(XUD9TF/L)		o	GWB3429	
1.9 TD CAT (59 kW)	1998.04-2002.04	Box Engine DHX(XUD9TF/L)		o	GWB3430	
	1998.04-2002.04	Box Engine DHX(XUD9TF/L)		o	GWB3642	
	1994.08-2002.04	Box Engine 230A4.000	•		GHA428004	
	1994.08-2002.04	Box Engine 230A4.000	•		GHA435001	
	1994.08-2002.04	Box Engine 230A4.000	•		GWB1444	
	1994.08-2002.04	Box Engine 230A4.000	•		GWB3428	
	1994.08-2002.04	Box Engine 230A4.000	•		GWB3640	
	1994.08-2002.04	Box Engine 230A4.000	•		GWB3641	
2.0 (80 kW)	1994.08-2002.04	Box Engine 230A4.000		o	GWB3429	
	1994.08-2002.04	Box Engine 230A4.000		o	GWB3430	
	1994.08-2002.04	Box Engine 230A4.000		o	GWB3642	
	1994.03-2002.04	Box Engine RFW	•		GHA428004	
	1994.03-2002.04	Box Engine RFW	•		GWB1444	
	1994.03-2002.04	Box Engine RFW	•		GWB3428	
	1994.03-2002.04	Box Engine RFW	•		GWB3640	
	1994.03-2002.04	Box Engine RFW	•		GWB3641	
2.0 4x4 (80 kW)	1994.03-2002.04	Box Engine RFW		o	GWB3429	
	1994.03-2002.04	Box Engine RFW		o	GWB3430	
	1994.03-2002.04	Box Engine RFW		o	GWB3642	
	1994.11-2002.04	Box Engine RFW	•		GHA428004	
	1994.11-2002.04	Box Engine RFW	•		GWB1444	
	1994.11-2002.04	Box Engine RFW	•		GWB3428	
2.0 JTD (62 kW)	1994.11-2002.04	Box Engine RFW	•		GWB3640	
	1994.11-2002.04	Box Engine RFW	•		GWB3641	
	1994.11-2002.04	Box Engine RFW		o	GWB3679	
2001.10-2002.04	Box Engine RHV(DW10)	•		GHA428004		



	 YEAR		F	R	G-AP Ref.	KIT	
FIAT							
DUCATO (230L)							
2.0 JTD (62 kW)	2001.10-2002.04	Box Engine RHV(DW10)	•		GHA435001		
	2001.10-2002.04	Box Engine RHV(DW10)	•		GWB1444		
	2001.10-2002.04	Box Engine RHV(DW10)	•		GWB3428		
	2001.10-2002.04	Box Engine RHV(DW10)	•		GWB3640		
	2001.10-2002.04	Box Engine RHV(DW10)	•		GWB3641		
	2001.10-2002.04	Box Engine RHV(DW10)		○	GWB3429		
	2001.10-2002.04	Box Engine RHV(DW10)		○	GWB3430		
	2001.10-2002.04	Box Engine RHV(DW10)		○	GWB3642		
2.5 D (62 kW)	1994.03-2002.04	Box Engine 8140.67	•		GHA428004		
	1994.03-2002.04	Box Engine 8140.67	•		GHA435001		
	1994.03-2002.04	Box Engine 8140.67	•		GWB1444		
	1994.03-2002.04	Box Engine 8140.67	•		GWB3428		
	1994.03-2002.04	Box Engine 8140.67	•		GWB3640		
	1994.03-2002.04	Box Engine 8140.67	•		GWB3641		
	1994.03-2002.04	Box Engine 8140.67		○	GWB3429		
	1994.03-2002.04	Box Engine 8140.67		○	GWB3430		
2.5 TD (80 kW)	1994.06-1998.08	Box Engine 8140.47	•		GHA428004		
	1994.06-1998.08	Box Engine 8140.47	•		GWB1444		
	1994.06-1998.08	Box Engine 8140.47	•		GWB3428		
	1994.06-1998.08	Box Engine 8140.47		○	GWB3429		
	1994.06-1998.08	Box Engine 8140.47		○	GWB3430		
2.5 TD 4x4 (80 kW)	1994.11-1998.04	Box Engine 8140.47	•		GHA428004		
	1994.11-1998.04	Box Engine 8140.47	•		GWB1444		
	1994.11-1998.04	Box Engine 8140.47	•		GWB3428		
2.5 TD 4x4 (85 kW)	1994.11-1998.04	Box Engine 8140.47	•		GHA428004		
	1994.11-1998.04	Box Engine 8140.47	•		GWB1444		
	1994.11-1998.04	Box Engine 8140.47	•		GWB3428		
2.5 TDi (80 kW)	1994.03-2002.04	Box Engine 8140.47R	•		GHA428004		
	1994.03-2002.04	Box Engine 8140.47R	•		GHA435001		
	1994.03-2002.04	Box Engine 8140.47R	•		GWB1444		
	1994.03-2002.04	Box Engine 8140.47R	•		GWB3428		
	1994.03-2002.04	Box Engine 8140.47R	•		GWB3640		
	1994.03-2002.04	Box Engine 8140.47R	•		GWB3641		
	1994.03-2002.04	Box Engine 8140.47R		○	GWB3429		
	1994.03-2002.04	Box Engine 8140.47R		○	GWB3430		
2.5 TDi (85 kW)	1994.03-2002.04	Box Engine 8140.47	•		GHA428004		
	1994.03-2002.04	Box Engine 8140.47	•		GHA435001		
	1994.03-2002.04	Box Engine 8140.47	•		GWB1444		
	1994.03-2002.04	Box Engine 8140.47	•		GWB3428		
	1994.03-2002.04	Box Engine 8140.47	•		GWB3640		
	1994.03-2002.04	Box Engine 8140.47	•		GWB3641		
	1994.03-2002.04	Box Engine 8140.47		○	GWB3429		
	1994.03-2002.04	Box Engine 8140.47		○	GWB3430		
2.5 TDi 4x4 (85 kW)	1998.05-2002.04	Box Engine 8140.47	•		GHA435001		
	1998.05-2002.04	Box Engine 8140.47	•		GWB1444		
	1998.05-2002.04	Box Engine 8140.47	•		GWB3428		
	1998.05-2002.04	Box Engine 8140.47	•		GWB3640		
	1998.05-2002.04	Box Engine 8140.47	•		GWB3641		
	1998.05-2002.04	Box Engine 8140.47		○	GWB3679		
	2.8 D (64 kW)	1998.05-2002.04	Box Engine 8140.63	•		GHA428004	
		1998.05-2002.04	Box Engine 8140.63	•		GHA435001	
1998.05-2002.04		Box Engine 8140.63	•		GWB1444		
1998.05-2002.04		Box Engine 8140.63	•		GWB3428		
1998.05-2002.04		Box Engine 8140.63	•		GWB3640		
1998.05-2002.04		Box Engine 8140.63	•		GWB3641		
1998.05-2002.04		Box Engine 8140.63		○	GWB3429		
1998.05-2002.04		Box Engine 8140.63		○	GWB3430		
2.8 D 4x4 (64 kW)	1998.08-2002.04	Box Engine 8140.63	•		GHA428004		
	1998.08-2002.04	Box Engine 8140.63	•		GHA435001		
	1998.08-2002.04	Box Engine 8140.63	•		GWB1444		



	 YEAR		F	R	G-AP Ref.	KIT
FIAT						
DUCATO (230L)						
2.8 D 4x4 (64 kW)	1998.08-2002.04	Box Engine 8140.63	•		GWB3428	
	1998.08-2002.04	Box Engine 8140.63	•		GWB3640	
	1998.08-2002.04	Box Engine 8140.63	•		GWB3641	
	1998.08-2002.04	Box Engine 8140.63		○	GWB3679	
2.8 JTD (94 kW)	2000.11-2002.04	Box Engine 8140.43S	•		GHA428004	
	2000.11-2002.04	Box Engine 8140.43S	•		GHA435001	
	2000.11-2002.04	Box Engine 8140.43S	•		GHA435002	
	2000.11-2002.04	Box Engine 8140.43S	•		GWB1444	
	2000.11-2002.04	Box Engine 8140.43S	•		GWB3428	
	2000.11-2002.04	Box Engine 8140.43S	•		GWB3640	
	2000.11-2002.04	Box Engine 8140.43S	•		GWB3641	
	2000.11-2002.04	Box Engine 8140.43S		○	GWB3429	
	2000.11-2002.04	Box Engine 8140.43S		○	GWB3430	
2.8 JTD 4x4 (94 kW)	2000.11-2002.04	Box Engine 8140.43S	•		GHA428004	
	2000.11-2002.04	Box Engine 8140.43S	•		GHA435001	
	2000.11-2002.04	Box Engine 8140.43S	•		GHA435002	
	2000.11-2002.04	Box Engine 8140.43S	•		GWB1444	
	2000.11-2002.04	Box Engine 8140.43S	•		GWB3428	
	2000.11-2002.04	Box Engine 8140.43S	•		GWB3640	
	2000.11-2002.04	Box Engine 8140.43S	•		GWB3641	
	2000.11-2002.04	Box Engine 8140.43S		○	GWB3679	
2.8 TD 4x4 (90 kW)	1998.05-2001.09	Box Engine 8140.43	•		GHA428004	
	1998.05-2001.09	Box Engine 8140.43	•		GHA435002	
	1998.05-2001.09	Box Engine 8140.43	•		GWB1444	
	1998.05-2001.09	Box Engine 8140.43	•		GWB3428	
2.8 TDi (90 kW)	1997.10-2002.04	Box Engine 8140.43	•		GHA428004	
	1997.10-2002.04	Box Engine 8140.43	•		GHA435001	
	1997.10-2002.04	Box Engine 8140.43	•		GHA435002	
	1997.10-2002.04	Box Engine 8140.43	•		GWB1444	
	1997.10-2002.04	Box Engine 8140.43	•		GWB3428	
	1997.10-2002.04	Box Engine 8140.43	•		GWB3640	
	1997.10-2002.04	Box Engine 8140.43	•		GWB3641	
	1997.10-2002.04	Box Engine 8140.43		○	GWB3429	
	1997.10-2002.04	Box Engine 8140.43		○	GWB3430	
	1997.10-2002.04	Box Engine 8140.43		○	GWB3642	
2.8 TDi 4x4 (90 kW)	1999.06-2002.04	Box Engine 8140.43	•		GHA435001	
	1999.06-2002.04	Box Engine 8140.43	•		GWB1444	
	1999.06-2002.04	Box Engine 8140.43	•		GWB3428	
	1999.06-2002.04	Box Engine 8140.43	•		GWB3640	
	1999.06-2002.04	Box Engine 8140.43		○	GWB3679	
DUCATO (244)						
2.0 (81 kW)	2002.04-	Box Engine RFL	•		GHA428006	
	2002.04-	Box Engine RFL	•		GWB3640	
	2002.04-	Box Engine RFL	•		GWB3641	
	2002.04-	Box Engine RFL	•		GWB3689	
	2002.04-	Box Engine RFL	•		GWB3690	
	2002.04-	Box Engine RFL		○	GWB3642	
	2002.04-2006.07	Platform/Chassis Engine RFL	•		GHA428006	
	2002.04-2006.07	Platform/Chassis Engine RFL	•		GWB3640	
	2002.04-2006.07	Platform/Chassis Engine RFL	•		GWB3689	
	2002.04-2006.07	Platform/Chassis Engine RFL		○	GWB3642	
2.0 4x4 (81 kW)	2002.05-2006.07	Box Engine RFL	•		GHA428006	
	2002.05-2006.07	Box Engine RFL	•		GWB3640	
	2002.05-2006.07	Box Engine RFL	•		GWB3641	
	2002.05-2006.07	Box Engine RFL	•		GWB3689	
	2002.05-2006.07	Box Engine RFL	•		GWB3690	
	2002.05-2006.07	Box Engine RFL		○	GWB3679	
2.0 Bipower (81 kW)	2002.11-	Box Engine RFL	•		GHA428006	
	2002.11-	Box Engine RFL	•		GWB3640	
	2002.11-	Box Engine RFL	•		GWB3641	
	2002.11-	Box Engine RFL	•		GWB3689	
	2002.11-	Box Engine RFL	•		GWB3690	



	 YEAR		F	R	G-AP Ref.	KIT
FIAT						
DUCATO (244)						
2.0 Bipower (81 kW)	2002.11-	Box Engine RFL		o	GWB3642	
2.0 JTD (62 kW)	2002.04-	Box Engine RHV(DW10)	•		GHA428006	
	2002.04-	Box Engine RHV(DW10)	•		GWB3640	
	2002.04-	Box Engine RHV(DW10)	•		GWB3689	
	2002.04-	Box Engine RHV(DW10)		o	GWB3642	
	2002.04-2006.07	Platform/Chassis Engine RHV(DW10)	•		GHA428006	
	2002.04-2006.07	Platform/Chassis Engine RHV(DW10)	•		GWB3640	
	2002.04-2006.07	Platform/Chassis Engine RHV(DW10)	•		GWB3689	
	2002.04-2006.07	Platform/Chassis Engine RHV(DW10)		o	GWB3642	
2.3 JTD (81 kW)	2002.04-	Box Engine F1AE0481C	•		GHA428006	
	2002.04-	Box Engine F1AE0481C	•		GHA435002	
	2002.04-	Box Engine F1AE0481C	•		GWB3640	
	2002.04-	Box Engine F1AE0481C	•		GWB3641	
	2002.04-	Box Engine F1AE0481C	•		GWB3689	
	2002.04-	Box Engine F1AE0481C	•		GWB3690	
	2002.04-	Box Engine F1AE0481C		o	GWB3642	
	2002.04-2006.07	Platform/Chassis Engine F1AE0481C	•		GHA428006	
	2002.04-2006.07	Platform/Chassis Engine F1AE0481C	•		GHA435002	
	2002.04-2006.07	Platform/Chassis Engine F1AE0481C	•		GWB3640	
	2002.04-2006.07	Platform/Chassis Engine F1AE0481C	•		GWB3641	
	2002.04-2006.07	Platform/Chassis Engine F1AE0481C	•		GWB3689	
2.8 JTD (90 kW)	2003.11-2006.07	Platform/Chassis Engine 8140.43	•		GHA428006	
	2003.11-2006.07	Platform/Chassis Engine 8140.43	•		GHA435002	
2.8 JTD (94 kW)	2002.04-	Box Engine 8140.43S	•		GHA428006	
	2002.04-	Box Engine 8140.43S	•		GHA435002	
	2002.04-	Box Engine 8140.43S	•		GWB3640	
	2002.04-	Box Engine 8140.43S	•		GWB3641	
	2002.04-	Box Engine 8140.43S	•		GWB3689	
	2002.04-	Box Engine 8140.43S	•		GWB3690	
	2002.04-	Box Engine 8140.43S		o	GWB3642	
	2002.04-2006.07	Platform/Chassis Engine 8140.43S	•		GHA428006	
	2002.04-2006.07	Platform/Chassis Engine 8140.43S	•		GHA435002	
	2002.04-2006.07	Platform/Chassis Engine 8140.43S	•		GWB3640	
	2002.04-2006.07	Platform/Chassis Engine 8140.43S	•		GWB3641	
	2002.04-2006.07	Platform/Chassis Engine 8140.43S	•		GWB3689	
	2002.04-2006.07	Platform/Chassis Engine 8140.43S	•		GWB3690	
	2002.04-2006.07	Platform/Chassis Engine 8140.43S		o	GWB3642	
2.8 JTD 4x4 (90 kW)	2003.11-2006.07	Platform/Chassis Engine 8140.43	•		GHA428006	
	2003.11-2006.07	Platform/Chassis Engine 8140.43	•		GHA435002	
2.8 JTD 4x4 (94 kW)	2002.07-	Box Engine 8140.43S	•		GHA428006	
	2002.07-	Box Engine 8140.43S	•		GHA435002	
	2002.07-	Box Engine 8140.43S	•		GWB3640	
	2002.07-	Box Engine 8140.43S	•		GWB3641	
	2002.07-	Box Engine 8140.43S	•		GWB3689	
	2002.07-	Box Engine 8140.43S	•		GWB3690	
	2002.07-	Box Engine 8140.43S		o	GWB3679	
	2002.10-2006.07	Platform/Chassis Engine 8140.43S	•		GHA428006	
	2002.10-2006.07	Platform/Chassis Engine 8140.43S	•		GHA435002	
	2002.10-2006.07	Platform/Chassis Engine 8140.43S	•		GWB3640	
	2002.10-2006.07	Platform/Chassis Engine 8140.43S	•		GWB3641	
	2002.10-2006.07	Platform/Chassis Engine 8140.43S	•		GWB3689	
	2002.10-2006.07	Platform/Chassis Engine 8140.43S	•		GWB3690	
	2002.10-2006.07	Platform/Chassis Engine 8140.43S		o	GWB3679	
2.8 JTD Power (107 kW)	2004.05-	Box Engine 8140.43N	•		GHA428006	
	2004.05-	Box Engine 8140.43N	•		GHA435002	
	2004.05-	Box Engine 8140.43N	•		GWB3640	
	2004.05-	Box Engine 8140.43N	•		GWB3641	
	2004.05-	Box Engine 8140.43N	•		GWB3689	
	2004.05-	Box Engine 8140.43N	•		GWB3690	
	2004.05-	Box Engine 8140.43N		o	GWB3642	
	2004.05-2006.07	Platform/Chassis Engine 8140.43N	•		GHA428006	
2004.05-2006.07	Platform/Chassis Engine 8140.43N	•		GHA435002		



	 YEAR		F	R	G-AP Ref.	KIT
FIAT						
DUCATO (244)						
2.8 JTD Power (107 kW)	2004.05-2006.07	Platform/Chassis Engine 8140.43N	•		GWB3640	
	2004.05-2006.07	Platform/Chassis Engine 8140.43N	•		GWB3641	
	2004.05-2006.07	Platform/Chassis Engine 8140.43N	•		GWB3689	
	2004.05-2006.07	Platform/Chassis Engine 8140.43N	•		GWB3690	
	2004.05-2006.07	Platform/Chassis Engine 8140.43N		◦	GWB3642	
2.8 TD (90 kW)	2003.11-2006.07	Box Engine 8140.43	•		GHA428006	
	2003.11-2006.07	Box Engine 8140.43	•		GHA435002	
2.8 TD 4x4 (90 kW)	2003.11-2006.07	Box Engine 8140.43	•		GHA428006	
	2003.11-2006.07	Box Engine 8140.43	•		GHA435002	
DUCATO (244, Z_)						
2.0 (81 kW)	2002.04-	Bus Engine RFL	•		GHA428006	
	2002.04-	Bus Engine RFL	•		GWB3640	
	2002.04-	Bus Engine RFL	•		GWB3641	
	2002.04-	Bus Engine RFL	•		GWB3689	
	2002.04-	Bus Engine RFL	•		GWB3690	
2.0 4x4 (81 kW)	2002.04-	Bus Engine RFL		◦	GWB3642	
	2002.05-2006.07	Bus Engine RFL	•		GHA428006	
	2002.05-2006.07	Bus Engine RFL	•		GWB3640	
	2002.05-2006.07	Bus Engine RFL	•		GWB3641	
	2002.05-2006.07	Bus Engine RFL	•		GWB3689	
2.0 Bipower (81 kW)	2002.05-2006.07	Bus Engine RFL	•		GWB3690	
	2002.05-2006.07	Bus Engine RFL		◦	GWB3679	
	2002.11-	Bus Engine RFL	•		GHA428006	
	2002.11-	Bus Engine RFL	•		GWB3640	
	2002.11-	Bus Engine RFL	•		GWB3641	
2.0 JTD (62 kW)	2002.11-	Bus Engine RFL	•		GWB3689	
	2002.11-	Bus Engine RFL	•		GWB3690	
	2002.11-	Bus Engine RFL		◦	GWB3642	
	2002.04-	Bus Engine RHV(DW10)	•		GHA428006	
	2002.04-	Bus Engine RHV(DW10)	•		GWB3640	
2.3 JTD (81 kW)	2002.04-	Bus Engine RHV(DW10)	•		GWB3689	
	2002.04-	Bus Engine RHV(DW10)	•		GWB3642	
	2002.04-	Bus Engine F1AE0481C	•		GHA428006	
	2002.04-	Bus Engine F1AE0481C	•		GHA435002	
	2002.04-	Bus Engine F1AE0481C	•		GWB3640	
2.8 JTD (107 kW)	2002.04-	Bus Engine F1AE0481C	•		GWB3641	
	2002.04-	Bus Engine F1AE0481C	•		GWB3689	
	2002.04-	Bus Engine F1AE0481C	•		GWB3690	
	2002.04-	Bus Engine F1AE0481C		◦	GWB3642	
	2002.04-	Bus Engine F1AE0481C	•		GWB3642	
2.8 JTD (94 kW)	2004.04-2006.07	Bus Engine 8140.43N	•		GHA428006	
	2004.04-2006.07	Bus Engine 8140.43N	•		GHA435002	
	2004.04-2006.07	Bus Engine 8140.43N	•		GWB3640	
	2004.04-2006.07	Bus Engine 8140.43N	•		GWB3641	
	2004.04-2006.07	Bus Engine 8140.43N	•		GWB3689	
	2004.04-2006.07	Bus Engine 8140.43N	•		GWB3690	
	2004.04-2006.07	Bus Engine 8140.43N		◦	GWB3642	
2.8 JTD 4x4 (94 kW)	2002.04-	Bus Engine 8140.43S	•		GHA428006	
	2002.04-	Bus Engine 8140.43S	•		GHA435002	
	2002.04-	Bus Engine 8140.43S	•		GWB3640	
	2002.04-	Bus Engine 8140.43S	•		GWB3641	
	2002.04-	Bus Engine 8140.43S	•		GWB3689	
	2002.04-	Bus Engine 8140.43S	•		GWB3690	
	2002.04-	Bus Engine 8140.43S		◦	GWB3642	
2.8 TD (90 kW)	2002.07-	Bus Engine 8140.43S	•		GHA428006	
	2002.07-	Bus Engine 8140.43S	•		GHA435002	
	2002.07-	Bus Engine 8140.43S	•		GWB3640	
	2002.07-	Bus Engine 8140.43S	•		GWB3641	
	2002.07-	Bus Engine 8140.43S	•		GWB3689	
	2002.07-	Bus Engine 8140.43S	•		GWB3690	
2.8 TD 4x4 (90 kW)	2002.07-	Bus Engine 8140.43S		◦	GWB3679	
	2003.11-2006.07	Bus Engine 8140.43	•		GHA428006	
2.8 TD 4x4 (90 kW)	2003.11-2006.07	Bus Engine 8140.43	•		GHA435002	
	2003.11-2006.07	Bus Engine 8140.43	•		GHA428006	
2.8 TD 4x4 (90 kW)	2003.11-2006.07	Bus Engine 8140.43	•		GHA435002	
	2003.11-2006.07	Bus Engine 8140.43	•		GHA428006	



	 YEAR		F	R	G-AP Ref.	KIT
FIAT						
DUCATO (250)						
2,0 D Multijet (85 kW)	2011.06-	Box Engine 250A1.000	•		GWB6570	
	2011.06-	Box Engine 250A1.000		◦	GHA242007	K
	2011.06-	Box Engine 250A1.000		◦	GHA242008	K
	2011.06-	Bus Engine 250A1.000	•		GWB6570	
	2011.06-	Bus Engine 250A1.000		◦	GHA242007	K
	2011.06-	Bus Engine 250A1.000		◦	GHA242008	K
	2011.06-	Platform/Chassis Engine 250A1.000	•		GWB6570	
	2011.06-	Platform/Chassis Engine 250A1.000		◦	GHA242007	K
	2011.06-	Platform/Chassis Engine 250A1.000		◦	GHA242008	K
	2,2 D Multijet (74 kW)	2006.07-	Box Engine 4HV	•		GWB6570
2006.07-		Box Engine 4HV		◦	GHA242007	K
2006.07-		Box Engine 4HV		◦	GHA242008	K
2006.07-		Bus Engine 4HV	•		GWB6570	
2006.07-		Bus Engine 4HV		◦	GHA242007	K
2006.07-		Bus Engine 4HV		◦	GHA242008	K
2006.07-		Platform/Chassis Engine 4HV	•		GWB6570	
2006.07-		Platform/Chassis Engine 4HV		◦	GHA242007	K
2,3 D Multijet (109 kW)	2011.06-	Box Engine F1AE3481E	•		GWB6570	
	2011.06-	Box Engine F1AE3481E		◦	GHA242007	K
	2011.06-	Box Engine F1AE3481E		◦	GHA242008	K
	2011.06-	Bus Engine F1AE3481E	•		GWB6570	
	2011.06-	Bus Engine F1AE3481E		◦	GHA242007	K
	2011.06-	Bus Engine F1AE3481E		◦	GHA242008	K
	2011.06-	Platform/Chassis Engine F1AE3481E	•		GWB6570	
	2011.06-	Platform/Chassis Engine F1AE3481E		◦	GHA242007	K
2,3 D Multijet (83 kW)	2011.10-	Box Engine F1AE3481G	•		GWB6570	
	2011.10-	Box Engine F1AE3481G		◦	GHA242007	K
	2011.10-	Box Engine F1AE3481G		◦	GHA242008	K
	2011.10-	Bus Engine F1AE3481G	•		GWB6570	
	2011.10-	Bus Engine F1AE3481G		◦	GHA242007	K
	2011.10-	Bus Engine F1AE3481G		◦	GHA242008	K
	2011.10-	Platform/Chassis Engine F1AE3481G	•		GWB6570	
	2011.10-	Platform/Chassis Engine F1AE3481G		◦	GHA242007	K
2,3 D Multijet (88 kW)	2006.07-	Box Engine F1AE0481D	•		GHA435002	
	2006.07-	Box Engine F1AE0481D	•		GWB6570	
	2006.07-	Box Engine F1AE0481D		◦	GHA242007	K
	2006.07-	Box Engine F1AE0481D		◦	GHA242008	K
	2006.07-	Bus Engine F1AE0481D	•		GHA435002	
	2006.07-	Bus Engine F1AE0481D	•		GWB6570	
	2006.07-	Bus Engine F1AE0481D		◦	GHA242007	K
	2006.07-	Bus Engine F1AE0481D		◦	GHA242008	K
	2006.07-	Platform/Chassis Engine F1AE0481D	•		GHA435002	
	2006.07-	Platform/Chassis Engine F1AE0481D	•		GWB6570	
	2006.07-	Platform/Chassis Engine F1AE0481D		◦	GHA242007	K
	2006.07-	Platform/Chassis Engine F1AE0481D		◦	GHA242008	K
	2010.03-	Platform/Chassis Engine F1AE0481D	•		GWB6570	
	2010.03-	Platform/Chassis Engine F1AE0481D		◦	GHA242007	K
2,3 D Multijet (96 kW)	2007.01-	Box Engine F1AE0481N/F1AE3481D	•		GHA435002	
	2007.01-	Box Engine F1AE0481N/F1AE3481D	•		GWB6570	
	2007.01-	Box Engine F1AE0481N/F1AE3481D		◦	GHA242007	K
	2007.01-	Box Engine F1AE0481N/F1AE3481D		◦	GHA242008	K
	2007.01-	Bus Engine F1AE3481D	•		GWB6570	
	2007.01-	Bus Engine F1AE3481D		◦	GHA242007	K
	2007.01-	Bus Engine F1AE3481D		◦	GHA242008	K
	2007.01-	Platform/Chassis Engine F1AE0481N/F1AE3481D	•		GHA435002	
	2007.01-	Platform/Chassis Engine F1AE0481N/F1AE3481D	•		GWB6570	
	2007.01-	Platform/Chassis Engine F1AE0481N/F1AE3481D		◦	GHA242007	K
	2007.01-	Platform/Chassis Engine F1AE0481N/F1AE3481D		◦	GHA242008	K
2,3 D Multijet 4x4 (88 kW)	2010.03-	Box Engine F1AE0481D	•		GWB6570	
	2010.03-	Box Engine F1AE0481D		◦	GHA242007	K



	 YEAR		F	R	G-AP Ref.	KIT	
FIAT							
DUCATO (250)							
2,3 D Multijet 4x4 (88 kW)	2010.03-	Box Engine F1AE0481D		o	GHA242008	K	
3.0 D Multijet (107 kW)	2010.04-	Box Engine F1CE3481N	•		GWB6570		
	2010.04-	Box Engine F1CE3481N		o	GHA242007	K	
	2010.04-	Box Engine F1CE3481N		o	GHA242008	K	
	2010.04-	Bus Engine F1CE3481N	•		GWB6570		
	2010.04-	Bus Engine F1CE3481N		o	GHA242007	K	
	2010.04-	Bus Engine F1CE3481N		o	GHA242008	K	
	2010.04-	Platform/Chassis Engine F1CE3481N	•		GWB6570		
	2010.04-	Platform/Chassis Engine F1CE3481N		o	GHA242007	K	
3.0 D Multijet (115 kW)	2010.04-	Platform/Chassis Engine F1CE3481N		o	GHA242008	K	
	2006.07-	Box Engine F1CE3481M		o	GHA242007	K	
	2006.07-	Box Engine F1CE3481M		o	GHA242008	K	
	2006.07-	Platform/Chassis Engine F1CE3481M	•		GWB6570		
	2006.07-	Platform/Chassis Engine F1CE3481M		o	GHA242007	K	
3.0 D Multijet (116 kW)	2006.07-	Platform/Chassis Engine F1CE3481M		o	GHA242008	K	
	2006.07-	Box Engine F1CE0481D	•		GWB6570		
	2006.07-	Box Engine F1CE0481D		o	GHA242007	K	
	2006.07-	Box Engine F1CE0481D		o	GHA242008	K	
	2006.07-	Bus Engine F1CE0481D/F1CE3481M	•		GWB6570		
	2006.07-	Bus Engine F1CE0481D/F1CE3481M		o	GHA242007	K	
	2006.07-	Bus Engine F1CE0481D/F1CE3481M		o	GHA242008	K	
	2006.07-	Platform/Chassis Engine F1CE0481D	•		GWB6570		
	2006.07-	Platform/Chassis Engine F1CE0481D		o	GHA242007	K	
	2006.07-	Platform/Chassis Engine F1CE0481D		o	GHA242008	K	
3.0 D Multijet (130 kW)	2011.06-	Box Engine F1CE3481E	•		GWB6570		
	2011.06-	Box Engine F1CE3481E		o	GHA242007	K	
	2011.06-	Box Engine F1CE3481E		o	GHA242008	K	
	2011.06-	Bus Engine F1CE3481E	•		GWB6570		
	2011.06-	Bus Engine F1CE3481E		o	GHA242007	K	
	2011.06-	Bus Engine F1CE3481E		o	GHA242008	K	
	2011.06-	Platform/Chassis Engine F1CE3481E	•		GWB6570		
	2011.06-	Platform/Chassis Engine F1CE3481E		o	GHA242007	K	
3.0 Natural Power (100 kW)	2011.06-	Platform/Chassis Engine F1CE3481E		o	GHA242008	K	
	2009.04-	Box Engine F1CE0441A	•		GWB6570		
	2009.04-	Box Engine F1CE0441A		o	GHA242007	K	
	2009.04-	Box Engine F1CE0441A		o	GHA242008	K	
	2009.04-	Bus Engine F1CE0441A	•		GWB6570		
	2009.04-	Bus Engine F1CE0441A		o	GHA242007	K	
	2009.04-	Bus Engine F1CE0441A		o	GHA242008	K	
	2009.04-	Platform/Chassis Engine F1CE0441A	•		GWB6570		
DUCATO (250, 290)	2009.04-	Platform/Chassis Engine F1CE0441A		o	GHA242007	K	
	2009.04-	Platform/Chassis Engine F1CE0441A		o	GHA242008	K	
	2006.08-	Platform/Chassis Engine F1AE0481T	•		GHA435002		
	2006.08-	Platform/Chassis Engine F1AE0481T	•		GWB6570		
	2006.08-	Platform/Chassis Engine F1AE0481T		o	GHA242007	K	
	2006.08-	Platform/Chassis Engine F1AE0481T		o	GHA242008	K	
	2010.01-	Bus Engine F1AE0481T	•		GHA435002		
	2010.01-	Bus Engine F1AE0481T	•		GWB6570		
DUCATO (290)	2010.01-	Bus Engine F1AE0481T		o	GHA242007	K	
	2010.01-	Bus Engine F1AE0481T		o	GHA242008	K	
	1.9 D (52 kW)	1990.07-1994.03	Box Engine 149B1.000	•		GWB1444	
		1990.07-1994.03	Box Engine 149B1.000		o	GWB1445	
	2.0 (62 kW)	1990.07-1994.03	Platform/Chassis Engine 170D	•		GWB1444	
		1990.07-1994.03	Platform/Chassis Engine 170D		o	GWB1445	
	2.0 (63 kW)	1990.06-1994.05	Box Engine 170D	•		GWB1444	
	2.0 4x4 (63 kW)	1990.06-1994.05	Platform/Chassis Engine 170 D	•		GWB1444	
2.5 D (55 kW)	1990.06-1994.05	Box Engine 8144.67	•		GWB1444		
	1990.06-1994.05	Box Engine 8144.67		o	GWB1445		
	1990.07-1994.03	Platform/Chassis Engine 8144.67	•		GWB1444		
	1990.07-1994.03	Platform/Chassis Engine 8144.67		o	GWB1445		
	2.5 D 4x4 (55 kW)	1990.07-1994.03	Box Engine 8144.67	•		GWB1444	
	1990.07-1994.03	Platform/Chassis Engine 8144.67	•		GWB1444		



	 YEAR		F	R	G-AP Ref.	KIT
FIAT						
DUCATO (290)						
2.5 TD (70 kW)	1990.07-1994.03	Box Engine 8140.27	•		GWB1444	
	1990.07-1994.03	Box Engine 8140.27		◦	GWB1445	
	1990.07-1994.03	Platform/Chassis Engine 8140.27	•		GWB1444	
	1990.07-1994.03	Platform/Chassis Engine 8140.27		◦	GWB1445	
2.5 TD 4x4 (70 kW)	1990.07-1994.03	Box Engine 8140.27	•		GWB1444	
	1990.07-1994.03	Platform/Chassis Engine 8140.27	•		GWB1444	
DUCATO 250)						
130 Multijet 2,3 D (93 kW)	2006.08-	Box Engine F1AE0481T	•		GHA435002	
DUCATO PANORAMA (290)						
1.9 D (52 kW)	1990.07-1994.03	Bus Engine 149B1.000	•		GWB1444	
	1990.07-1994.03	Bus Engine 149B1.000		◦	GWB1445	
1.9 TD (60 kW)	1990.07-1994.03	Bus Engine 280A1.000	•		GWB1444	
	1990.07-1994.03	Bus Engine 280A1.000		◦	GWB1445	
2.0 (62 kW)	1990.07-1994.03	Bus Engine 170D	•		GWB1444	
	1990.07-1994.03	Bus Engine 170D		◦	GWB1445	
2.0 4x4 (63 kW)	1990.06-1994.05	Bus Engine 170D	•		GWB1444	
2.5 D (55 kW)	1990.07-1994.03	Bus Engine 8144.67	•		GWB1444	
	1990.07-1994.03	Bus Engine 8144.67		◦	GWB1445	
2.5 D 4x4 (55 kW)	1990.07-1994.03	Bus Engine 8144.67	•		GWB1444	
2.5 TD (70 kW)	1990.08-1994.03	Bus Engine 8140.27	•		GWB1444	
	1990.08-1994.03	Bus Engine 8140.27		◦	GWB1445	
2.5 TD 4x4 (70 kW)	1991.01-1994.03	Bus Engine 8140.27	•		GWB1444	
FIORINO (146)						
1.4 (49 kW)	1994.05-2001.05	Pickup Engine 146D5.000	•		GHA422001	
	1994.05-2001.05	Pickup Engine 146D5.000	•		GHA422007	
	1994.05-2001.05	Pickup Engine 146D5.000	•		GWB3416	
	1994.05-2001.05	Pickup Engine 146D5.000		◦	GHA230107	
1.4 (52 kW)	1992.11-1996.1	Box Engine 146 C5.000	•		GWB3416	
1.4 i.e. (49 kW)	1994.05-2001.05	Box Engine 146C5.000/146D5.000	•		GWB3416	
	1994.05-2001.05	Box Engine 146C5.000/146D5.000		◦	GHA230107	
1.6 (55 kW)	1994.01-2001.05	Pickup Engine 146C6.000/146D6.000	•		GHA422007	
	1994.01-2001.05	Pickup Engine 146C6.000/146D6.000	•		GWB3416	
	1994.01-2001.05	Pickup Engine 146C6.000/146D6.000		◦	GHA230107	
1.6 i.e. (55 kW)	1993.10-2001.05	Box Engine 146C6.000/146D6.000	•		GHA422007	
	1993.10-2001.05	Box Engine 146C6.000/146D6.000	•		GWB3416	
	1993.10-2001.05	Box Engine 146C6.000/146D6.000		◦	GHA230107	
1.7 D (42 kW)	1993.10-1999.10	Pickup Engine 146B2.000	•		GHA422007	
	1993.10-1999.10	Pickup Engine 146B2.000	•		GWB3416	
	1993.10-1999.10	Pickup Engine 146B2.000		◦	GHA230107	
1.7 TD (46 kW)	1997.01-2001.05	Box Engine 146D7.000	•		GHA422007	
	1997.01-2001.05	Box Engine 146D7.000	•		GWB3416	
	1997.01-2001.05	Box Engine 146D7.000		◦	GHA230107	
	1997.01-2001.05	Pickup Engine 146D7.000	•		GHA422007	
	1997.01-2001.05	Pickup Engine 146D7.000	•		GWB3416	
	1997.01-2001.05	Pickup Engine 146D7.000		◦	GHA230107	
FIORINO (225)						
1.3 D Multijet (55 kW)	2007.11-	Box Body / Estate Engine 199A2.000/199A9.000	•		GHA425008	
	2007.11-	Box Body / Estate Engine 199A2.000/199A9.000	•		GWB3539	
	2007.11-	Box Body / Estate Engine 199A2.000/199A9.000	•		GWB6540	
	2007.11-	Box Body / Estate Engine 199A2.000/199A9.000 With ABS		◦	GHA230046	K
1.3 D Multijet (70 kW)	2009.07-	Box Body / Estate Engine 199B1.000	•		GHA425008	
	2009.07-	Box Body / Estate Engine 199B1.000	•		GWB3539	
	2009.07-	Box Body / Estate Engine 199B1.000	•		GWB6540	
	2009.07-	Box Body / Estate Engine 199B1.000 With ABS		◦	GHA230046	K
1.4 (54 kW)	2007.11-	Box Body / Estate Engine KFT/KFV With ABS		◦	GHA230046	K
1.4 Natural Power (57 kW)	2009.10-	Box Body / Estate Engine 350A1.000 With ABS		◦	GHA230046	K
FREEMONT (JF_)						
2.0 JTD (100 kW)	2011.08-	Estate Engine 939 B5.000		◦	GHA332018	
2.0 JTD (103 kW)	2011.08-	Estate Engine 939 B5.000/940 A5.000		◦	GHA332018	
2.0 JTD (120 kW)	2011.08-	Estate Engine 939 B5.000		◦	GHA332018	
2.0 JTD (125 kW)	2011.08-	Estate Engine 939 B5.000		◦	GHA332018	
2.0 JTD 4x4 (120 kW)	2011.08-	Estate Engine 939 B5.000		◦	GHA332018	
2.0 JTD 4x4 (125 kW)	2011.08-	Estate Engine 939 B5.000		◦	GHA332018	



	 YEAR		F	R	G-AP Ref.	KIT
FIAT						
FREEMONT (JF_)						
2.4 (125 kW)	2011.08-	Estate Engine ED3/EDG		o	GHA332018	
3.6 (206 kW)	2011.08-	Estate Engine ERB		o	GHA332018	
3.6 4x4 (206 kW)	2011.08-	Estate Engine ERB		o	GHA332018	
GRANDE PUNTO (199)						
1.2 (51 kW)	2010.09-	Hatchback Engine 169 A4.000		o	GHA230092	K
1.2 LPG (51 kW)	2008.07-	Hatchback Engine 199 A4.000		o	GHA230092	K
1.9 D Multijet (85 kW)	2006.06-	Hatchback Engine 939 A7.000	•		GWB3539	
	2006.06-	Hatchback Engine 939 A7.000	•		GWB6540	
	2006.06-	Hatchback Engine 939 A7.000		o	GHA230092	K
IDEA						
1.2 16V (59 kW)	2004.01-	MPV Engine 188A5.000	•		GHA422015	
	2004.01-	MPV Engine 188A5.000	•		GHA425008	
	2004.01-	MPV Engine 188A5.000	•		GWB3538	
	2004.01-	MPV Engine 188A5.000 With ABS		o	GHA230046	K
1.3 D Multijet (66 kW)	2005.10-	MPV Engine 199A3.000	•		GHA425008	
	2005.10-	MPV Engine 199A3.000	•		GWB3539	
	2005.10-	MPV Engine 199A3.000	•		GWB6540	
	2005.10-	MPV Engine 199A3.000 With ABS		o	GHA230046	K
1.3 D Multijet (70 kW)	2008.05-	MPV Engine 199B1.000	•		GHA425008	
	2008.05-	MPV Engine 199B1.000	•		GWB3539	
	2008.05-	MPV Engine 199B1.000	•		GWB6540	
	2008.05-	MPV Engine 199B1.000 With ABS		o	GHA230046	K
1.3 JTD (51 kW)	2004.01-	MPV Engine 188A9.000	•		GHA425008	
	2004.01-	MPV Engine 188A9.000	•		GWB3539	
	2004.01-	MPV Engine 188A9.000	•		GWB6540	
	2004.01-	MPV Engine 188A9.000 With ABS		o	GHA230046	K
1.4 (57 kW)	2005.10-	MPV Engine 350A1.000	•		GHA422015	
	2005.10-	MPV Engine 350A1.000	•		GWB3538	
	2005.10-	MPV Engine 350A1.000 With ABS		o	GHA230046	K
1.4 (66 kW)	2003.12-	MPV Engine 192B2.000	•		GHA422015	
	2003.12-	MPV Engine 192B2.000	•		GWB3538	
	2003.12-	MPV Engine 192B2.000 With ABS		o	GHA230046	K
1.4 16V (70 kW)	2004.01-	MPV Engine 843A1.000	•		GHA422015	
	2004.01-	MPV Engine 843A1.000	•		GWB3538	
	2004.01-	MPV Engine 843A1.000 With ABS		o	GHA230046	K
1.4 LPG (57 kW)	2009.03-	MPV Engine 350A1.000	•		GWB3538	
	2009.03-	MPV Engine 350A1.000 With ABS		o	GHA230046	K
1.6 D Multijet (88 kW)	2008.05-	MPV Engine 350A2.000	•		GHA425008	
	2008.05-	MPV Engine 350A2.000	•		GWB3539	
	2008.05-	MPV Engine 350A2.000	•		GWB6540	
	2008.05-	MPV Engine 350A2.000 With ABS		o	GHA230046	K
1.9 JTD (74 kW)	2004.01-	MPV Engine 188B2.000	•		GHA425008	
	2004.01-	MPV Engine 188B2.000	•		GWB3539	
	2004.01-	MPV Engine 188B2.000	•		GWB6540	
	2004.01-	MPV Engine 188B2.000 With ABS		o	GHA230046	K
LINEA (323)						
1.3 D Multijet (66 kW)	2007.06-	Saloon Engine 199A3.000	•		GWB1439	
	2007.06-	Saloon Engine 199A3.000	•		GWB3539	
	2007.06-	Saloon Engine 199A3.000	•		GWB6540	
	2007.06-	Saloon Engine 199A3.000 With ABS		o	GHA230046	K
	2007.06-	Saloon Engine 199A3.000 Without ABS		o	GHA230044	K
1.3 D Multijet (70 kW)	2009.09-	Saloon Engine 199 A3.000	•		GWB1439	
	2009.09-	Saloon Engine 199 A3.000	•		GWB3539	
	2009.09-	Saloon Engine 199 A3.000	•		GWB6540	
	2009.09-	Saloon Engine 199 A3.000 With ABS		o	GHA230046	K
	2009.09-	Saloon Engine 199 A3.000 Without ABS		o	GHA230044	K
1.4 (57 kW)	2007.06-	Saloon Engine 350A1.000	•		GWB1438	
	2007.06-	Saloon Engine 350A1.000	•		GWB3538	
	2007.06-	Saloon Engine 350A1.000 With ABS		o	GHA230046	K
	2007.06-	Saloon Engine 350A1.000 Without ABS		o	GHA230044	K
1.4 T-Jet (88 kW)	2007.09-	Saloon Engine 198A4.000	•		GHA425008	
	2007.09-	Saloon Engine 198A4.000	•		GWB1438	
	2007.09-	Saloon Engine 198A4.000	•		GWB3538	
	2007.09-	Saloon Engine 198A4.000 With ABS		o	GHA230046	K



	 YEAR		F	R	G-AP Ref.	KIT
FIAT						
LINEA (323)						
1.4 T-Jet (88 kW)	2007.09-	Saloon Engine 198A4.000 Without ABS		o	GHA230044	K
1.6 D Multijet (77 kW)	2009.06-	Saloon Engine 198A3.000	•		GHA425008	
	2009.06-	Saloon Engine 198A3.000	•		GWB1439	
	2009.06-	Saloon Engine 198A3.000	•		GWB3539	
	2009.06-	Saloon Engine 198A3.000	•		GWB6540	
	2009.06-	Saloon Engine 198A3.000 With ABS		o	GHA230046	K
	2009.06-	Saloon Engine 198A3.000 Without ABS		o	GHA230044	K
MAREA (185)						
1.2 16V (60 kW)	1998.10-2002.05	Saloon Engine 182B2.000	•		GHA422015	
	1998.10-2002.05	Saloon Engine 182B2.000	•		GWB3414	
	1998.10-2002.05	Saloon Engine 182B2.000	•		GWB3538	
	1998.10-2002.05	Saloon Engine 182B2.000 With ABS		o	GHA230046	K
	1998.10-2002.05	Saloon Engine 182B2.000 Without ABS		o	GHA230044	K
1.4 12V (59 kW)	1996.09-2002.05	Saloon Engine 182A3.000	•		GHA422015	
	1996.09-2002.05	Saloon Engine 182A3.000	•		GWB3414	
	1996.09-2002.05	Saloon Engine 182A3.000	•		GWB3538	
	1996.09-2002.05	Saloon Engine 182A3.000		o	GHA230090	K
	1996.09-2002.05	Saloon Engine 182A3.000 With ABS		o	GHA230046	K
	1996.09-2002.05	Saloon Engine 182A3.000 Without ABS		o	GHA230044	K
1.6 (68 kW)	1999.03-2000.08	Saloon Engine 185A3.000	•		GHA425008	
1.6 (76 kW)	2000.09-2002.08	Saloon Engine 182B6.000	•		GHA425008	
1.6 100 16V Bipower (76 kW)	1999.04-2002.05	Saloon Engine 185A3.000/186A4.000	•		GHA425008	
	1999.04-2002.05	Saloon Engine 185A3.000/186A4.000	•		GWB1439	
	1999.04-2002.05	Saloon Engine 185A3.000/186A4.000	•		GWB3539	
	1999.04-2002.05	Saloon Engine 185A3.000/186A4.000	•		GWB6540	
	1999.04-2002.05	Saloon Engine 185A3.000/186A4.000 With ABS		o	GHA230046	K
	1999.04-2002.05	Saloon Engine 185A3.000/186A4.000 Without ABS		o	GHA230044	K
1.6 16V (75 kW)	1997.04-1999.02	Saloon Engine 185A3.000	•		GHA425008	
	1997.04-1999.02	Saloon Engine 185A3.000	•		GWB1439	
	1997.04-1999.02	Saloon Engine 185A3.000	•		GWB3539	
	1997.04-1999.02	Saloon Engine 185A3.000	•		GWB6540	
	1997.04-1999.02	Saloon Engine 185A3.000		o	GHA230090	K
	1997.04-1999.02	Saloon Engine 185A3.000 With ABS		o	GHA230046	K
1997.04-1999.02	Saloon Engine 185A3.000 Without ABS		o	GHA230044	K	
1.6 16V (76 kW)	1996.09-2002.05	Saloon Engine 182A4.000	•		GHA425008	
	1996.09-2002.05	Saloon Engine 182A4.000	•		GWB1439	
	1996.09-2002.05	Saloon Engine 182A4.000	•		GWB3539	
	1996.09-2002.05	Saloon Engine 182A4.000	•		GWB6540	
	1996.09-2002.05	Saloon Engine 182A4.000		o	GHA230090	K
	1996.09-2002.05	Saloon Engine 182A4.000 With ABS		o	GHA230046	K
	1996.09-2002.05	Saloon Engine 182A4.000 Without ABS		o	GHA230044	K
1.6 SX (72 kW)	2000.09-2002.08	Saloon Engine 182B5.098	•		GHA425008	
1.8 16V (83 kW)	1996.09-2002.05	Saloon Engine 182A2.000	•		GHA425008	
	1996.09-2002.05	Saloon Engine 182A2.000	•		GWB1439	
	1996.09-2002.05	Saloon Engine 182A2.000	•		GWB3539	
	1996.09-2002.05	Saloon Engine 182A2.000	•		GWB6540	
	1996.09-2002.05	Saloon Engine 182A2.000		o	GHA230090	K
	1996.09-2002.05	Saloon Engine 182A2.000 With ABS		o	GHA230046	K
1996.09-2002.05	Saloon Engine 182A2.000 Without ABS		o	GHA230044	K	
1.9 JTD (77 kW)	1999.04-2001.01	Saloon Engine 182B4.000	•		GHA425008	
	1999.04-2001.01	Saloon Engine 182B4.000	•		GWB1439	
	1999.04-2001.01	Saloon Engine 182B4.000	•		GWB3539	
	1999.04-2001.01	Saloon Engine 182B4.000	•		GWB6540	
	1999.04-2001.01	Saloon Engine 182B4.000 With ABS		o	GHA230046	K
	1999.04-2001.01	Saloon Engine 182B4.000 Without ABS		o	GHA230044	K
1.9 JTD (81 kW)	2001.01-2002.05	Saloon Engine 186A6.000	•		GHA425008	
	2001.01-2002.05	Saloon Engine 186A6.000	•		GWB1439	
	2001.01-2002.05	Saloon Engine 186A6.000	•		GWB3539	
	2001.01-2002.05	Saloon Engine 186A6.000	•		GWB6540	
	2001.01-2002.05	Saloon Engine 186A6.000 With ABS		o	GHA230046	K
	2001.01-2002.05	Saloon Engine 186A6.000 Without ABS		o	GHA230044	K
1.9 TD (55 kW)	1996.09-2002.05	Saloon Engine 182A8.000	•		GHA425008	
	1996.09-2002.05	Saloon Engine 182A8.000	•		GWB1439	
	1996.09-2002.05	Saloon Engine 182A8.000	•		GWB3539	



	 YEAR		F	R	G-AP Ref.	KIT
FIAT						
MAREA (185)						
1.9 TD (55 kW)	1996.09-2002.05	Saloon Engine 182A8.000	•		GWB6540	
	1996.09-2002.05	Saloon Engine 182A8.000		◦	GHA230090	K
	1996.09-2002.05	Saloon Engine 182A8.000 With ABS		◦	GHA230046	K
	1996.09-2002.05	Saloon Engine 182A8.000 Without ABS		◦	GHA230044	K
1.9 TD (74 kW)	1996.09-2002.05	Saloon Engine 182A7.000	•		GHA425008	
	1996.09-2002.05	Saloon Engine 182A7.000	•		GWB1439	
	1996.09-2002.05	Saloon Engine 182A7.000	•		GWB3539	
	1996.09-2002.05	Saloon Engine 182A7.000	•		GWB6540	
	1996.09-2002.05	Saloon Engine 182A7.000		◦	GHA230090	K
	1996.09-2002.05	Saloon Engine 182A7.000 With ABS		◦	GHA230046	K
	1996.09-2002.05	Saloon Engine 182A7.000 Without ABS		◦	GHA230044	K
2.0 20V (108 kW)	1996.09-1999.04	Saloon Engine 182A1.000	•		GWB1488	
	1996.09-1999.04	Saloon Engine 182A1.000		◦	GHA230090	K
	1996.09-1999.04	Saloon Engine 182A1.000 With ABS		◦	GHA230046	K
	1996.09-1999.04	Saloon Engine 182A1.000 Without ABS		◦	GHA230044	K
2.0 20V (110 kW)	1997.03-2003.02	Saloon Engine 185A8.000	•		GWB1488	
	1997.03-2003.02	Saloon Engine 185A8.000 With ABS		◦	GHA230046	K
	1997.03-2003.02	Saloon Engine 185A8.000 Without ABS		◦	GHA230044	K
2.0 20V (113 kW)	1999.04-2001.01	Saloon Engine 182B7.000	•		GWB1488	
	1999.04-2001.01	Saloon Engine 182B7.000 With ABS		◦	GHA230046	K
	1999.04-2001.01	Saloon Engine 182B7.000 Without ABS		◦	GHA230044	K
2.4 JTD (96 kW)	1999.04-2002.05	Saloon Engine 185A6.000/839A5.000	•		GWB1488	
	1999.04-2002.05	Saloon Engine 185A6.000/839A5.000 With ABS		◦	GHA230046	K
	1999.04-2002.05	Saloon Engine 185A6.000/839A5.000 Without ABS		◦	GHA230044	K
2.4 TD (91 kW)	1996.09-1999.04	Saloon Engine 185A2.000	•		GWB1488	
	1996.09-1999.04	Saloon Engine 185A2.000		◦	GHA230090	K
	1996.09-1999.04	Saloon Engine 185A2.000 With ABS		◦	GHA230046	K
	1996.09-1999.04	Saloon Engine 185A2.000 Without ABS		◦	GHA230044	K
MAREA WEEKEND (185)						
1.2 16V (60 kW)	1998.10-2002.05	Estate Engine 182B2.000	•		GHA422015	
	1998.10-2002.05	Estate Engine 182B2.000	•		GWB3414	
	1998.10-2002.05	Estate Engine 182B2.000	•		GWB3538	
	1998.10-2002.05	Estate Engine 182B2.000 With ABS		◦	GHA230046	K
	1998.10-2002.05	Estate Engine 182B2.000 Without ABS		◦	GHA230044	K
1.4 12V (59 kW)	1996.09-2002.05	Estate Engine 182A3.000	•		GHA422015	
	1996.09-2002.05	Estate Engine 182A3.000	•		GWB3414	
	1996.09-2002.05	Estate Engine 182A3.000	•		GWB3538	
	1996.09-2002.05	Estate Engine 182A3.000		◦	GHA230090	K
	1996.09-2002.05	Estate Engine 182A3.000 With ABS		◦	GHA230046	K
	1996.09-2002.05	Estate Engine 182A3.000 Without ABS		◦	GHA230044	K
1.6 (76 kW)	2000.09-2002.08	Estate Engine 182B6.000	•		GHA425008	
1.6 16V (76 kW)	1996.09-2002.05	Estate Engine 182A4.000	•		GHA425008	
	1996.09-2002.05	Estate Engine 182A4.000	•		GWB1439	
	1996.09-2002.05	Estate Engine 182A4.000	•		GWB3539	
	1996.09-2002.05	Estate Engine 182A4.000	•		GWB6540	
	1996.09-2002.05	Estate Engine 182A4.000		◦	GHA230090	K
	1996.09-2002.05	Estate Engine 182A4.000 With ABS		◦	GHA230046	K
	1996.09-2002.05	Estate Engine 182A4.000 Without ABS		◦	GHA230044	K
1.8 16V (83 kW)	1996.09-2002.05	Estate Engine 182A2.000	•		GHA425008	
	1996.09-2002.05	Estate Engine 182A2.000	•		GWB1439	
	1996.09-2002.05	Estate Engine 182A2.000	•		GWB3539	
	1996.09-2002.05	Estate Engine 182A2.000	•		GWB6540	
	1996.09-2002.05	Estate Engine 182A2.000		◦	GHA230090	K
	1996.09-2002.05	Estate Engine 182A2.000 With ABS		◦	GHA230046	K
	1996.09-2002.05	Estate Engine 182A2.000 Without ABS		◦	GHA230044	K
	1996.09-2002.05	Estate Engine 182A2.000 Without ABS		◦	GHA230044	K
1.9 JTD (77 kW)	1999.04-2002.05	Estate Engine 182B4.000	•		GHA425008	
	1999.04-2002.05	Estate Engine 182B4.000	•		GWB1439	
	1999.04-2002.05	Estate Engine 182B4.000	•		GWB3539	
	1999.04-2002.05	Estate Engine 182B4.000	•		GWB6540	
	1999.04-2002.05	Estate Engine 182B4.000 With ABS		◦	GHA230046	K
	1999.04-2002.05	Estate Engine 182B4.000 Without ABS		◦	GHA230044	K
1.9 JTD (81 kW)	1999.03-2003.02	Estate Engine 186A6.000	•		GHA425008	
	1999.03-2003.02	Estate Engine 186A6.000	•		GWB1439	
	1999.03-2003.02	Estate Engine 186A6.000	•		GWB3539	



	 YEAR		F	R	G-AP Ref.	KIT
FIAT						
MAREA WEEKEND (185)						
1.9 JTD (81 kW)	1999.03-2003.02	Estate Engine 186A6.000	•		GWB6540	
	1999.03-2003.02	Estate Engine 186A6.000 With ABS		◦	GHA230046	K
	1999.03-2003.02	Estate Engine 186A6.000 Without ABS		◦	GHA230044	K
1.9 TD (55 kW)	1996.09-2002.05	Estate Engine 182A8.000	•		GHA425008	
	1996.09-2002.05	Estate Engine 182A8.000	•		GWB1439	
	1996.09-2002.05	Estate Engine 182A8.000	•		GWB3539	
	1996.09-2002.05	Estate Engine 182A8.000	•		GWB6540	
	1996.09-2002.05	Estate Engine 182A8.000		◦	GHA230090	K
	1996.09-2002.05	Estate Engine 182A8.000 With ABS		◦	GHA230046	K
	1996.09-2002.05	Estate Engine 182A8.000 Without ABS		◦	GHA230044	K
1.9 TD (74 kW)	1996.09-2002.05	Estate Engine 182A7.000/182B9.000	•		GHA425008	
	1996.09-2002.05	Estate Engine 182A7.000/182B9.000	•		GWB1439	
	1996.09-2002.05	Estate Engine 182A7.000/182B9.000	•		GWB3539	
	1996.09-2002.05	Estate Engine 182A7.000/182B9.000	•		GWB6540	
	1996.09-2002.05	Estate Engine 182A7.000/182B9.000		◦	GHA230090	K
	1996.09-2002.05	Estate Engine 182A7.000/182B9.000 With ABS		◦	GHA230046	K
	1996.09-2002.05	Estate Engine 182A7.000/182B9.000 Without ABS		◦	GHA230044	K
2.0 20V (108 kW)	1996.09-1999.04	Estate Engine 182A1.000	•		GWB1488	
	1996.09-1999.04	Estate Engine 182A1.000		◦	GHA230090	K
	1996.09-1999.04	Estate Engine 182A1.000 With ABS		◦	GHA230046	K
	1996.09-1999.04	Estate Engine 182A1.000 Without ABS		◦	GHA230044	K
2.0 20V (110 kW)	2001.01-2002.05	Estate Engine 185A8.000	•		GWB1488	
	2001.01-2002.05	Estate Engine 185A8.000 With ABS		◦	GHA230046	K
	2001.01-2002.05	Estate Engine 185A8.000 Without ABS		◦	GHA230044	K
2.0 20V (113 kW)	1999.04-2003.02	Estate Engine 182B7.000	•		GWB1488	
	1999.04-2003.02	Estate Engine 182B7.000 With ABS		◦	GHA230046	K
	1999.04-2003.02	Estate Engine 182B7.000 Without ABS		◦	GHA230044	K
2.4 JTD (96 kW)	1999.04-2002.05	Estate Engine 185A6.000/839A5.000	•		GWB1488	
	1999.04-2002.05	Estate Engine 185A6.000/839A5.000 With ABS		◦	GHA230046	K
	1999.04-2002.05	Estate Engine 185A6.000/839A5.000 Without ABS		◦	GHA230044	K
2.4 TD (91 kW)	1996.09-1999.04	Estate Engine 185A2.000	•		GWB1488	
	1996.09-1999.04	Estate Engine 185A2.000		◦	GHA230090	K
	1996.09-1999.04	Estate Engine 185A2.000 With ABS		◦	GHA230046	K
	1996.09-1999.04	Estate Engine 185A2.000 Without ABS		◦	GHA230044	K
MULTIPLA (186)						
1.6 (68 kW)	2004.05-2005.08	MPV Engine 182 B6.000	•		GHA425008	
	2004.05-2005.08	MPV Engine 182 B6.000	•		GWB1439	
	2004.05-2005.08	MPV Engine 182 B6.000	•		GWB3539	
	2004.05-2005.08	MPV Engine 182 B6.000	•		GWB6540	
	2004.05-2005.08	MPV Engine 182 B6.000 With ABS		◦	GHA230046	K
	2004.05-2005.08	MPV Engine 182 B6.000 Without ABS		◦	GHA230044	K
1.6 (74 kW)	2001.03-2005.08	MPV Engine 182 B6.000	•		GHA425008	
	2001.03-2005.08	MPV Engine 182 B6.000	•		GWB1439	
	2001.03-2005.08	MPV Engine 182 B6.000	•		GWB3539	
	2001.03-2005.08	MPV Engine 182 B6.000	•		GWB6540	
	2001.03-2005.08	MPV Engine 182 B6.000 With ABS		◦	GHA230046	K
	2001.03-2005.08	MPV Engine 182 B6.000 Without ABS		◦	GHA230044	K
1.6 (76 kW)	2000.09-2010.06	MPV Engine 182B6.000	•		GHA425008	
	2000.09-2010.06	MPV Engine 182B6.000	•		GWB1439	
	2000.09-2010.06	MPV Engine 182B6.000	•		GWB3539	
	2000.09-2010.06	MPV Engine 182B6.000	•		GWB6540	
	2000.09-2010.06	MPV Engine 182B6.000 With ABS		◦	GHA230046	K
	2000.09-2010.06	MPV Engine 182B6.000 Without ABS		◦	GHA230044	K
1.6 16V (70 kW)	2002.04-2010.06	MPV Engine 182B6.000	•		GHA425008	
	2002.04-2010.06	MPV Engine 182B6.000	•		GWB1439	
	2002.04-2010.06	MPV Engine 182B6.000	•		GWB3539	
	2002.04-2010.06	MPV Engine 182B6.000	•		GWB6540	
	2002.04-2010.06	MPV Engine 182B6.000 With ABS		◦	GHA230046	K
	2002.04-2010.06	MPV Engine 182B6.000 Without ABS		◦	GHA230044	K
1.6 16V (76 kW)	1999.04-2010.06	MPV Engine 182A4.000	•		GHA425008	
	1999.04-2010.06	MPV Engine 182A4.000	•		GWB1439	
	1999.04-2010.06	MPV Engine 182A4.000	•		GWB3539	
	1999.04-2010.06	MPV Engine 182A4.000	•		GWB6540	
	1999.04-2010.06	MPV Engine 182A4.000 With ABS		◦	GHA230046	K



	 YEAR		F	R	G-AP Ref.	KIT
FIAT						
MULTIPLA (186)						
1.6 16V (76 kW)	1999.04-2010.06	MPV Engine 182A4.000 Without ABS		o	GHA230044	K
1.6 16V Bipower (76 kW)	1999.04-2010.06	MPV Engine 186A4.000	•		GHA425008	
	1999.04-2010.06	MPV Engine 186A4.000	•		GWB1439	
	1999.04-2010.06	MPV Engine 186A4.000	•		GWB3539	
	1999.04-2010.06	MPV Engine 186A4.000	•		GWB6540	
	1999.04-2010.06	MPV Engine 186A4.000 With ABS		o	GHA230046	K
	1999.04-2010.06	MPV Engine 186A4.000 Without ABS		o	GHA230044	K
	2001.10-2010.06	MPV Engine 182B6.000	•		GHA425008	
	2001.10-2010.06	MPV Engine 182B6.000	•		GWB1439	
	2001.10-2010.06	MPV Engine 182B6.000	•		GWB3539	
	2001.10-2010.06	MPV Engine 182B6.000	•		GWB6540	
	2001.10-2010.06	MPV Engine 182B6.000 With ABS		o	GHA230046	K
	2001.10-2010.06	MPV Engine 182B6.000 Without ABS		o	GHA230044	K
1.6 16V Blupower (70 kW)	1999.04-2010.06	MPV Engine 186A3.000	•		GHA425008	
	1999.04-2010.06	MPV Engine 186A3.000	•		GWB1439	
	1999.04-2010.06	MPV Engine 186A3.000	•		GWB3539	
	1999.04-2010.06	MPV Engine 186A3.000	•		GWB6540	
	1999.04-2010.06	MPV Engine 186A3.000 With ABS		o	GHA230046	K
	1999.04-2010.06	MPV Engine 186A3.000 Without ABS		o	GHA230044	K
1.6 16V GPL (76 kW)	2001.10-2010.06	MPV Engine 182 B6.000	•		GHA425008	
1.9 JTD (77 kW)	1999.04-2010.06	MPV Engine 182B4.000	•		GHA425008	
	1999.04-2010.06	MPV Engine 182B4.000	•		GWB1439	
	1999.04-2010.06	MPV Engine 182B4.000	•		GWB3539	
	1999.04-2010.06	MPV Engine 182B4.000	•		GWB6540	
	1999.04-2010.06	MPV Engine 182B4.000 With ABS		o	GHA230046	K
	1999.04-2010.06	MPV Engine 182B4.000 Without ABS		o	GHA230044	K
1.9 JTD (81 kW)	2001.03-2002.07	MPV Engine 186A6.000	•		GHA425008	
	2001.03-2002.07	MPV Engine 186A6.000	•		GWB1439	
	2001.03-2002.07	MPV Engine 186A6.000	•		GWB3539	
	2001.03-2002.07	MPV Engine 186A6.000	•		GWB6540	
	2001.03-2002.07	MPV Engine 186A6.000 With ABS		o	GHA230046	K
	2001.03-2002.07	MPV Engine 186A6.000 Without ABS		o	GHA230044	K
1.9 JTD (85 kW)	2002.07-2010.06	MPV Engine 186A8.000	•		GHA425008	
	2002.07-2010.06	MPV Engine 186A8.000	•		GWB1439	
	2002.07-2010.06	MPV Engine 186A8.000	•		GWB3539	
	2002.07-2010.06	MPV Engine 186A8.000	•		GWB6540	
	2002.07-2010.06	MPV Engine 186A8.000 With ABS		o	GHA230046	K
	2002.07-2010.06	MPV Engine 186A8.000 Without ABS		o	GHA230044	K
1.9 JTD (88 kW)	2006.02-2010.06	MPV Engine 186A9.000	•		GHA425008	
	2006.02-2010.06	MPV Engine 186A9.000	•		GWB1439	
	2006.02-2010.06	MPV Engine 186A9.000	•		GWB3539	
	2006.02-2010.06	MPV Engine 186A9.000	•		GWB6540	
	2006.02-2010.06	MPV Engine 186A9.000 With ABS		o	GHA230046	K
	2006.02-2010.06	MPV Engine 186A9.000 Without ABS		o	GHA230044	K
PALIO (178BX)						
1.0 (45 kW)	1996.04-	Hatchback	•		GHA422018	
	1996.04-	Hatchback	•		GWB3528	
	1996.04-	Hatchback	•		GWB6502	
	1996.04-	Hatchback		o	GHA230090	K
	1996.04-	Hatchback With ABS		o	GHA230046	K
	1996.04-	Hatchback Without ABS		o	GHA230044	K
1.0 (56 kW)	1996.04-	Hatchback	•		GHA422018	
1.1 (40 kW)	1997.07-2003.1	Hatchback Engine 178 B9.033	•		GHA422018	
1.2 (44 kW)	1997.07-2002.08	Hatchback Engine 178B7.045/178C4.066/188A4.000	•		GHA422018	
	1997.07-2002.08	Hatchback Engine 178B7.045/178C4.066/188A4.000	•		GWB3528	
	1997.07-2002.08	Hatchback Engine 178B7.045/178C4.066/188A4.000	•		GWB6502	
	1997.07-2002.08	Hatchback Engine 178B7.045/178C4.066/188A4.000		o	GHA230090	K
	1997.07-2002.08	Hatchback Engine 178B7.045/178C4.066/188A4.000 With ABS		o	GHA230046	K
	1997.07-2002.08	Hatchback Engine 178B7.045/178C4.066/188A4.000 Without ABS		o	GHA230044	K
1.2 (50 kW)	1999.06-2000.10	Hatchback Engine 178E2.000	•		GHA422018	
	1999.06-2000.10	Hatchback Engine 178E2.000	•		GWB3528	
	1999.06-2000.10	Hatchback Engine 178E2.000		o	GHA230090	K
	1999.06-2000.10	Hatchback Engine 178E2.000 Without ABS		o	GHA230044	K
1.2 (54 kW)	1998.06-	Hatchback Engine 176A8.000/178B5.000/178E2.000	•		GHA422018	



	 YEAR		F	R	G-AP Ref.	KIT
FIAT						
PALIO (178BX)						
1.2 (54 kW)	1998.06-	Hatchback Engine 176A8.000/178B5.000/178E2.000	•		GWB3528	
	1998.06-	Hatchback Engine 176A8.000/178B5.000/178E2.000	•		GWB6502	
	1998.06-	Hatchback Engine 176A8.000/178B5.000/178E2.000		○	GHA230090	K
	1998.06-	Hatchback Engine 176A8.000/178B5.000/178E2.000 With ABS		○	GHA230046	K
	1998.06-	Hatchback Engine 176A8.000/178B5.000/178E2.000 Without ABS		○	GHA230044	K
1.2 (59 kW)	2001.09-	Hatchback Engine 188 A5.000	•		GHA422018	
1.4 (51 kW)	1996.04-	Hatchback Engine 178B2.000	•		GHA422018	
	1996.04-	Hatchback Engine 178B2.000	•		GWB3528	
	1996.04-	Hatchback Engine 178B2.000	•		GWB6502	
	1996.04-	Hatchback Engine 178B2.000		○	GHA230090	K
	1996.04-	Hatchback Engine 178B2.000 With ABS		○	GHA230046	K
	1996.04-	Hatchback Engine 178B2.000 Without ABS		○	GHA230044	K
1.4 (57 kW)	2005.10-	Hatchback	•		GHA422018	
1.4 (70 kW)	2003.06-	Hatchback Engine 834 A1.000	•		GHA422018	
	2003.06-	Hatchback Engine 834 A1.000	•		GWB3528	
	2003.06-	Hatchback Engine 834 A1.000	•		GWB6502	
	2003.06-	Hatchback Engine 834 A1.000 With ABS		○	GHA230046	K
	2003.06-	Hatchback Engine 834 A1.000 Without ABS		○	GHA230044	K
1.4 CAT (51 kW)	1996.04-	Hatchback Engine 178B2.016	•		GHA422018	
	1996.04-	Hatchback Engine 178B2.016	•		GWB3528	
	1996.04-	Hatchback Engine 178B2.016	•		GWB6502	
	1996.04-	Hatchback Engine 178B2.016		○	GHA230090	K
	1996.04-	Hatchback Engine 178B2.016 With ABS		○	GHA230046	K
	1996.04-	Hatchback Engine 178B2.016 Without ABS		○	GHA230044	K
1.5 (62 kW)	2004.06-	Hatchback Engine 178E5.022	•		GWB3528	
	2004.06-	Hatchback Engine 178E5.022	•		GWB6502	
	2004.06-	Hatchback Engine 178E5.022 With ABS		○	GHA230046	K
1.6 (68 kW)	1997.07-2000.1	Hatchback Engine 178 C7.098/178 D2.011	•		GHA422018	
1.6 (70 kW)	1999.06-	Hatchback Engine 178 D2.011	•		GHA422018	
1.6 16V (74 kW)	1996.04-	Hatchback Engine 178B3.000	•		GHA422018	
	1996.04-	Hatchback Engine 178B3.000	•		GWB3528	
	1996.04-	Hatchback Engine 178B3.000	•		GWB6502	
	1996.04-	Hatchback Engine 178B3.000		○	GHA230090	K
	1996.04-	Hatchback Engine 178B3.000 With ABS		○	GHA230046	K
	1996.04-	Hatchback Engine 178B3.000 Without ABS		○	GHA230044	K
PALIO WEEKEND (178DX)						
1.2 (44 kW)	2001.02-	Estate Engine 178C4.066/188A4.000	•		GWB3528	
	2001.02-	Estate Engine 178C4.066/188A4.000	•		GWB6502	
	2001.02-	Estate Engine 178C4.066/188A4.000		○	GHA230090	K
	2001.02-	Estate Engine 178C4.066/188A4.000 With ABS		○	GHA230046	K
	2001.02-	Estate Engine 178C4.066/188A4.000 Without ABS		○	GHA230044	K
1.2 (52 kW)	2004.06-	Estate Engine 178 E9.011	•		GWB6502	
	2004.06-	Estate Engine 178 E9.011 With ABS		○	GHA230046	K
1.2 (54 kW)	1996.04-2001.02	Estate Engine 178B5.000	•		GWB3528	
	1996.04-2001.02	Estate Engine 178B5.000		○	GHA230090	K
	1996.04-2001.02	Estate Engine 178B5.000 Without ABS		○	GHA230044	K
1.2 (59 kW)	2001.09-	Estate Engine 188A5.000	•		GHA422018	
1.6 16V (74 kW)	1996.04-2001.02	Estate Engine 178B3.000	•		GWB3528	
	1996.04-2001.02	Estate Engine 178B3.000		○	GHA230090	K
	1996.04-2001.02	Estate Engine 178B3.000 Without ABS		○	GHA230044	K
1.6 16V (76 kW)	2001.02-	Estate Engine 182B6.000	•		GWB3528	
	2001.02-	Estate Engine 182B6.000	•		GWB6502	
	2001.02-	Estate Engine 182B6.000		○	GHA230090	K
	2001.02-	Estate Engine 182B6.000 With ABS		○	GHA230046	K
	2001.02-	Estate Engine 182B6.000 Without ABS		○	GHA230044	K
1.7 TD (51 kW)	1996.04-2001.03	Estate Engine 176A3.000	•		GHA422018	
	1996.04-2001.03	Estate Engine 176A3.000	•		GWB3528	
	1996.04-2001.03	Estate Engine 176A3.000		○	GHA230090	K
	1996.04-2001.03	Estate Engine 176A3.000 Without ABS		○	GHA230044	K
1.9 D (46 kW)	2001.03-	Estate Engine 223A6.000	•		GWB3528	
	2001.03-	Estate Engine 223A6.000	•		GWB6502	
	2001.03-	Estate Engine 223A6.000		○	GHA230090	K
	2001.03-	Estate Engine 223A6.000 With ABS		○	GHA230046	K
	2001.03-	Estate Engine 223A6.000 Without ABS		○	GHA230044	K



	 YEAR		F	R	G-AP Ref.	KIT
FIAT						
PALIO WEEKEND (178DX)						
1.9 JTD (59 kW)	2001.09-	Estate Engine 188A2.000	•		GHA425009	
	2001.09-	Estate Engine 188A2.000		◦	GHA232001	K
PANDA (141A_)						
1.1 (37 kW)	1991.05-1999.12	Hatchback Engine 156C.046	•		GHA320001	K
	1991.05-1999.12	Hatchback Engine 156C.046		◦	GHA230002	S
1.1 (40 kW)	1995.02-2003.09	Hatchback Engine 176B2.000/187A1.000	•		GHA320001	K
	1995.02-2003.09	Hatchback Engine 176B2.000/187A1.000		◦	GHA230002	S
1.1 4x4 (40 kW)	1995.02-2004.07	Hatchback Engine 176B2.000	•		GHA320001	K
1.1 Trekking 4x4 (37 kW)	1991.10-2004.07	Hatchback Engine 156C.046	•		GHA320001	K
750 CAT (25 kW)	1995.01-2003.10	Hatchback Engine 156A4.048	•		GHA320001	K
	1995.01-2003.10	Hatchback Engine 156A4.048		◦	GHA230002	S
900 (29 kW)	1992.04-1996.12	Hatchback Engine 1170A1.046	•		GHA320001	K
	1992.04-1996.12	Hatchback Engine 1170A1.046		◦	GHA230002	S
PANDA (169)						
1.1 (40 kW)	2004.01-2006.01	Hatchback Engine 187A1.000	•		GHA422015	
	2004.01-2006.01	Hatchback Engine 187A1.000	•		GWB1401	
	2004.01-2006.01	Hatchback Engine 187A1.000	•		GWB3577	
	2004.01-2006.01	Hatchback Engine 187A1.000 With ABS		◦	GHA230046	K
	2004.01-2006.01	Hatchback Engine 187A1.000 Without ABS		◦	GHA230044	K
1.2 (44 kW)	2004.01-2007.12	Hatchback Engine 188A4.000	•		GHA422015	
	2004.01-2007.12	Hatchback Engine 188A4.000	•		GWB1401	
	2004.01-2007.12	Hatchback Engine 188A4.000	•		GWB3577	
	2004.01-2007.12	Hatchback Engine 188A4.000 With ABS		◦	GHA230046	K
	2004.01-2007.12	Hatchback Engine 188A4.000 Without ABS		◦	GHA230044	K
1.2 (51 kW)	2010.03-	Hatchback Engine 169A4.000	•		GHA422015	
	2010.03-	Hatchback Engine 169A4.000	•		GWB3577	
	2010.03-	Hatchback Engine 169A4.000 With ABS		◦	GHA230046	K
1.2 4x4 (44 kW)	2005.01-	Hatchback Engine 188A4.000	•		GHA422015	
	2005.01-	Hatchback Engine 188A4.000	•		GHA425008	
	2005.01-	Hatchback Engine 188A4.000	•		GWB3539	
	2005.01-	Hatchback Engine 188A4.000	•		GWB6540	
	2005.01-	Hatchback Engine 188A4.000		◦	GWB3577	
1.2 4x4 (51 kW)	2009.11-	Hatchback Engine 169A4.000	•		GHA425008	
	2009.11-	Hatchback Engine 169A4.000	•		GWB3539	
	2009.11-	Hatchback Engine 169A4.000	•		GWB6540	
	2009.11-	Hatchback Engine 169A4.000		◦	GHA422015	
	2009.11-	Hatchback Engine 169A4.000		◦	GWB3577	
1.2 Bi-Power/Natural Power (44 kW)	2007.01-	Hatchback Engine 188A4.000	•		GHA422015	
	2007.01-	Hatchback Engine 188A4.000	•		GWB3539	
	2007.01-	Hatchback Engine 188A4.000	•		GWB6540	
	2007.01-	Hatchback Engine 188A4.000 With ABS		◦	GHA230046	K
1.2 LPG (44 kW)	2009.04-	Box Body / Estate Engine 188A4.000	•		GHA422015	
	2009.04-	Box Body / Estate Engine 188A4.000	•		GWB1401	
	2009.04-	Box Body / Estate Engine 188A4.000 With ABS		◦	GHA230046	K
	2009.04-	Box Body / Estate Engine 188A4.000 Without ABS		◦	GHA230044	K
	2009.04-	Hatchback Engine 188A4.000	•		GHA422015	
	2009.04-	Hatchback Engine 188A4.000	•		GWB1401	
	2009.04-	Hatchback Engine 188A4.000	•		GWB3577	
	2009.04-	Hatchback Engine 188A4.000 With ABS		◦	GHA230046	K
	2009.04-	Hatchback Engine 188A4.000 Without ABS		◦	GHA230044	K
1.2 LPG (51 kW)	2010.11-	Hatchback Engine 169A4.000	•		GHA422015	
	2010.11-	Hatchback Engine 169A4.000	•		GWB1401	
	2010.11-	Hatchback Engine 169A4.000	•		GWB3577	
	2010.11-	Hatchback Engine 169A4.000 With ABS		◦	GHA230046	K
	2010.11-	Hatchback Engine 169A4.000 Without ABS		◦	GHA230044	K
1.3 D Multijet (51 kW)	2004.01-2006.12	Hatchback Engine 188A9.000	•		GHA422015	
	2004.01-2006.12	Hatchback Engine 188A9.000	•		GHA425008	
	2004.01-2006.12	Hatchback Engine 188A9.000	•		GWB3539	
	2004.01-2006.12	Hatchback Engine 188A9.000	•		GWB6540	
	2004.01-2006.12	Hatchback Engine 188A9.000 With ABS		◦	GHA230046	K
	2004.01-2006.12	Hatchback Engine 188A9.000 Without ABS		◦	GHA230044	K
1.3 D Multijet (55 kW)	2006.06-	Hatchback Engine 169A1.000	•		GHA422015	
	2006.06-	Hatchback Engine 169A1.000	•		GHA425008	
	2006.06-	Hatchback Engine 169A1.000	•		GWB3539	



	 YEAR		F	R	G-AP Ref.	KIT
FIAT						
PANDA (169)						
1.3 D Multijet (55 kW)	2006.06-	Hatchback Engine 169A1.000	•		GWB6540	
	2006.06-	Hatchback Engine 169A1.000 With ABS		○	GHA230046	K
	2006.06-	Hatchback Engine 169A1.000 Without ABS		○	GHA230044	K
1.3 D Multijet 4x4 (51 kW)	2004.10-	Hatchback Engine 188A9.000/188A8.000	•		GHA425008	
	2004.10-	Hatchback Engine 188A9.000/188A8.000	•		GWB3539	
	2004.10-	Hatchback Engine 188A9.000/188A8.000	•		GWB6540	
	2004.10-	Hatchback Engine 188A9.000/188A8.000		○	GHA422015	
	2004.10-	Hatchback Engine 188A9.000/188A8.000		○	GWB3577	
1.3 D Multijet 4x4 (55 kW)	2010.09-	Hatchback Engine 169A1.000/169A5.000	•		GHA425008	
	2010.09-	Hatchback Engine 169A1.000/169A5.000	•		GWB3539	
	2010.09-	Hatchback Engine 169A1.000/169A5.000	•		GWB6540	
	2010.09-	Hatchback Engine 169A1.000/169A5.000		○	GHA422015	
	2010.09-	Hatchback Engine 169A1.000/169A5.000		○	GWB3577	
1.4 (74 kW)	2006.10-	Hatchback Engine 169A3.000	•		GHA425008	
	2006.10-	Hatchback Engine 169A3.000	•		GWB3539	
	2006.10-	Hatchback Engine 169A3.000	•		GWB6540	
	2006.10-	Hatchback Engine 169A3.000 With ABS		○	GHA230046	K
	2006.10-	Hatchback Engine 169A3.000 Without ABS		○	GHA230044	K
1.4 Bi-Power/Natural Power (57 kW)	2010.09-	Hatchback Engine 350A1.000	•		GHA422015	
	2010.09-	Hatchback Engine 350A1.000	•		GWB3539	
	2010.09-	Hatchback Engine 350A1.000	•		GWB6540	
	2010.09-	Hatchback Engine 350A1.000 With ABS		○	GHA230046	K
1.4 Natural Power (51 kW)	2010.01-	Hatchback Engine 350A1.000	•		GHA422015	
	2010.01-	Hatchback Engine 350A1.000	•		GWB3539	
	2010.01-	Hatchback Engine 350A1.000	•		GWB6540	
	2010.01-	Hatchback Engine 350A1.000 With ABS		○	GHA230046	K
PANDA (312, 319)						
0.9 (48 kW)	2012.02-	Hatchback Engine 312A4.000	•		GWB3539	
	2012.02-	Hatchback Engine 312A4.000	•		GWB6540	
	2012.02-	Hatchback Engine 312A4.000 With ABS		○	GHA230046	K
0.9 (57 kW)	2012.02-	Hatchback Engine 312A2.000	•		GWB3577	
	2012.02-	Hatchback Engine 312A2.000 With ABS		○	GHA230046	K
0.9 (63 kW)	2012.02-	Hatchback Engine 312A2.000	•		GWB3539	
	2012.02-	Hatchback Engine 312A2.000	•		GWB6540	
	2012.02-	Hatchback Engine 312A2.000 With ABS		○	GHA230046	K
0.9 4x4 (63 kW)	2012.09-	Hatchback Engine 312A2.000	•		GWB3539	
	2012.09-	Hatchback Engine 312A2.000	•		GWB6540	
	2012.09-	Hatchback Engine 312A2.000		○	GWB3577	
1.2 (51 kW)	2012.02-	Hatchback Engine 169A4.000	•		GWB3577	
	2012.02-	Hatchback Engine 169A4.000 With ABS		○	GHA230046	K
1.2 LPG (51 kW)	2012.06-	Hatchback Engine 169A4.000	•		GWB3577	
	2012.06-	Hatchback Engine 169A4.000 With ABS		○	GHA230046	K
1.3 D Multijet (55 kW)	2012.02-	Hatchback Engine 199A9.000	•		GWB3539	
	2012.02-	Hatchback Engine 199A9.000	•		GWB6540	
	2012.02-	Hatchback Engine 199A9.000 With ABS		○	GHA230046	K
1.3 D Multijet 4x4 (55 kW)	2012.06-	Hatchback Engine 199A9.000	•		GWB3539	
	2012.06-	Hatchback Engine 199A9.000	•		GWB6540	
	2012.06-	Hatchback Engine 199A9.000		○	GWB3577	
PANDA VAN (141_)						
1.0 i.e (33 kW)	1992.08-2004.02	Box Engine 156A2.246	•		GHA320001	K
	1992.08-2004.02	Box Engine 156A2.246		○	GHA230002	S
1.1 (40 kW)	2000.09-2004.02	Box Engine 187A1.000	•		GHA320001	K
	2000.09-2004.02	Box Engine 187A1.000		○	GHA230002	S
PANDA VAN (169)						
	2004.09-	Box Body / Estate Engine 187A1.000	•		GHA422015	
	2004.09-	Box Body / Estate Engine 187A1.000	•		GWB1401	
	2004.09-	Box Body / Estate Engine 187A1.000	•		GWB3577	
	2004.09-	Box Body / Estate Engine 187A1.000 With ABS		○	GHA230046	K
	2004.09-	Box Body / Estate Engine 187A1.000 Without ABS		○	GHA230044	K
1.2 (44 kW)	2004.09-	Box Body / Estate Engine 188A4.000	•		GHA422015	
	2004.09-	Box Body / Estate Engine 188A4.000	•		GWB1401	
	2004.09-	Box Body / Estate Engine 188A4.000	•		GWB3577	
	2004.09-	Box Body / Estate Engine 188A4.000 With ABS		○	GHA230046	K
	2004.09-	Box Body / Estate Engine 188A4.000 Without ABS		○	GHA230044	K



	 YEAR		F	R	G-AP Ref.	KIT
FIAT						
PANDA VAN (169)						
1.2 (51 kW)	2010.09-	Box Body / Estate Engine 169A4.000	•		GHA422015	
	2010.09-	Box Body / Estate Engine 169A4.000	•		GWB3577	
	2010.09-	Box Body / Estate Engine 169A4.000 With ABS		○	GHA230046	K
1.2 4x4 (44 kW)	2004.09-	Box Body / Estate Engine 188A4.000	•		GHA422015	
	2004.09-	Box Body / Estate Engine 188A4.000	•		GHA425008	
	2004.09-	Box Body / Estate Engine 188A4.000	•		GWB3539	
	2004.09-	Box Body / Estate Engine 188A4.000	•		GWB6540	
	2004.09-	Box Body / Estate Engine 188A4.000		○	GWB3577	
1.2 4x4 (51 kW)	2010.09-	Box Body / Estate Engine 169A4.000	•		GHA425008	
	2010.09-	Box Body / Estate Engine 169A4.000	•		GWB3539	
	2010.09-	Box Body / Estate Engine 169A4.000	•		GWB6540	
	2010.09-	Box Body / Estate Engine 169A4.000		○	GHA422015	
	2010.09-	Box Body / Estate Engine 169A4.000		○	GWB3577	
1.2 LPG (51 kW)	2010.09-	Box Body / Estate Engine 169A4.000	•		GHA422015	
	2010.09-	Box Body / Estate Engine 169A4.000	•		GWB1401	
	2010.09-	Box Body / Estate Engine 169A4.000	•		GWB3577	
	2010.09-	Box Body / Estate Engine 169A4.000 With ABS		○	GHA230046	K
	2010.09-	Box Body / Estate Engine 169A4.000 Without ABS		○	GHA230044	K
1.2 Natural Power (44 kW)	2007.01-2009.11	Box Body/Estate Engine 188 A4.000	•		GHA422015	
	2007.01-2009.11	Box Body/Estate Engine 188 A4.000	•		GWB3539	
	2007.01-2009.11	Box Body/Estate Engine 188 A4.000	•		GWB6540	
	2007.01-2009.11	Box Body/Estate Engine 188 A4.000 With ABS		○	GHA230046	K
1.3 JTD (51 kW)	2004.03-	Box Body / Estate Engine 188A8.000/188A9.000	•		GHA422015	
	2004.03-	Box Body / Estate Engine 188A8.000/188A9.000	•		GHA425008	
	2004.03-	Box Body / Estate Engine 188A8.000/188A9.000	•		GWB3539	
	2004.03-	Box Body / Estate Engine 188A8.000/188A9.000	•		GWB6540	
	2004.03-	Box Body / Estate Engine 188A8.000/188A9.000 With ABS		○	GHA230046	K
	2004.03-	Box Body / Estate Engine 188A8.000/188A9.000 Without ABS		○	GHA230044	K
1.3 JTD (55 kW)	2006.01-	Box Body / Estate Engine 169A1.000	•		GHA422015	
	2006.01-	Box Body / Estate Engine 169A1.000	•		GHA425008	
	2006.01-	Box Body / Estate Engine 169A1.000	•		GWB3539	
	2006.01-	Box Body / Estate Engine 169A1.000	•		GWB6540	
	2006.01-	Box Body / Estate Engine 169A1.000 With ABS		○	GHA230046	K
	2006.01-	Box Body / Estate Engine 169A1.000 Without ABS		○	GHA230044	K
1.3 Multijet 4x4 (55 kW)	2006.01-	Box Body / Estate Engine 169A1.000	•		GHA425008	
	2006.01-	Box Body / Estate Engine 169A1.000	•		GWB3539	
	2006.01-	Box Body / Estate Engine 169A1.000	•		GWB6540	
	2006.01-	Box Body / Estate Engine 169A1.000		○	GHA422015	
	2006.01-	Box Body / Estate Engine 169A1.000		○	GWB3577	
1.4 Natural Power (57 kW)	2009.10-	Box Body / Estate Engine 350A1.000	•		GHA422015	
	2009.10-	Box Body / Estate Engine 350A1.000	•		GWB3539	
	2009.10-	Box Body / Estate Engine 350A1.000	•		GWB6540	
	2009.10-	Box Body / Estate Engine 350A1.000 With ABS		○	GHA230046	K
PANDA VAN (312)						
0.9 (48 kW)	2012.02-	Hatchback Engine 312 A4.000	•		GWB3539	
	2012.02-	Hatchback Engine 312 A4.000	•		GWB3577	
	2012.02-	Hatchback Engine 312 A4.000	•		GWB6540	
	2012.02-	Hatchback Engine 312 A4.000 With ABS		○	GHA230046	K
0.9 (63 kW)	2012.02-	Hatchback Engine 312 A2.000	•		GWB3539	
	2012.02-	Hatchback Engine 312 A2.000	•		GWB3577	
	2012.02-	Hatchback Engine 312 A2.000	•		GWB6540	
	2012.02-	Hatchback Engine 312 A2.000 With ABS		○	GHA230046	K
0.9 4x4 (63 kW)	2012.09-	Hatchback Engine 312 A2.000	•		GWB3539	
	2012.09-	Hatchback Engine 312 A2.000	•		GWB3577	
	2012.09-	Hatchback Engine 312 A2.000	•		GWB6540	
1.2 (51 kW)	2012.02-	Hatchback Engine 169 A4.000	•		GWB3577	
	2012.02-	Hatchback Engine 169 A4.000 With ABS		○	GHA230046	K
PANDA VAN(169)						
1.3 D Multijet	2004.10	Box body / Estate	•		GWB3539	
	2004.10	Box body / Estate	•		GWB6540	
	2004.10	Box body / Estate		○	GWB3577	
PUNTO (176)						
1.1 (40 kW)	1993.09-1999.09	Hatchback Engine 176A6.000/176B2.000	•		GHA422015	
	1993.09-1999.09	Hatchback Engine 176A6.000/176B2.000	•		GWB3413	



	 YEAR		F	R	G-AP Ref.	KIT
FIAT						
PUNTO (176)						
1.1 (40 kW)	1993.09-1999.09	Hatchback Engine 176A6.000/176B2.000		o	GHA230090	K
	1993.09-1999.09	Hatchback Engine 176A6.000/176B2.000 Without ABS		o	GHA230044	K
1.2 (43 kW)	1994.01-1999.09	Hatchback Engine 176A7.000	•		GHA422015	
	1994.01-1999.09	Hatchback Engine 176A7.000	•		GWB3414	
	1994.01-1999.09	Hatchback Engine 176A7.000		o	GHA230090	K
	1994.01-1999.09	Hatchback Engine 176A7.000 Without ABS		o	GHA230044	K
	1994.03-1999.09	Hatchback Engine 176B1.000/176B4.000	•		GHA422015	
1.2 (44 kW)	1994.03-1999.09	Hatchback Engine 176B1.000/176B4.000	•		GWB3414	
	1994.03-1999.09	Hatchback Engine 176B1.000/176B4.000		o	GHA230090	K
	1994.03-1999.09	Hatchback Engine 176B1.000/176B4.000 Without ABS		o	GHA230044	K
	1993.10-1999.09	Hatchback Engine 176A8.000	•		GHA422015	
1.2 (54 kW)	1993.10-1999.09	Hatchback Engine 176A8.000	•		GWB3414	
	1993.10-1999.09	Hatchback Engine 176A8.000		o	GHA230090	K
	1993.10-1999.09	Hatchback Engine 176A8.000 Without ABS		o	GHA230044	K
	1997.04-1999.09	Hatchback Engine 176B9.000	•		GHA422015	
1.2 16V (63 kW)	1997.04-1999.09	Hatchback Engine 176B9.000	•		GWB3414	
	1997.04-1999.09	Hatchback Engine 176B9.000		o	GHA230090	K
	1997.04-1999.09	Hatchback Engine 176B9.000 Without ABS		o	GHA230044	K
	1996.09-1999.09	Hatchback Engine 176B6.000	•		GHA425008	
1.4 GT Turbo (96 kW)	1996.09-1999.09	Hatchback Engine 176B6.000	•		GWB1439	
	1996.09-1999.09	Hatchback Engine 176B6.000		o	GHA230090	K
	1996.09-1999.09	Hatchback Engine 176B6.000 Without ABS		o	GHA230044	K
	1994.01-1996.09	Hatchback Engine 176A4.000	•		GHA425008	
1.4 GT Turbo (98 kW)	1994.01-1996.09	Hatchback Engine 176A4.000	•		GWB1439	
	1994.01-1996.09	Hatchback Engine 176A4.000		o	GHA230090	K
	1994.01-1996.09	Hatchback Engine 176A4.000 Without ABS		o	GHA230044	K
	1994.01-1997.04	Hatchback Engine 176A9.000	•		GHA422015	
1.6 (65 kW)	1994.01-1997.04	Hatchback Engine 176A9.000	•		GWB3414	
	1994.01-1997.04	Hatchback Engine 176A9.000		o	GHA230090	K
	1994.01-1997.04	Hatchback Engine 176A9.000 Without ABS		o	GHA230044	K
	1994.04-1997.09	Hatchback Engine 176B3.000	•		GWB3414	
1.7 D (42 kW)	1994.04-1997.09	Hatchback Engine 176B3.000		o	GHA230090	K
	1994.04-1997.09	Hatchback Engine 176B3.000 Without ABS		o	GHA230044	K
	1996.09-1999.09	Hatchback Engine 176B7.000	•		GWB3414	
1.7 TD (46 kW)	1996.09-1999.09	Hatchback Engine 176B7.000		o	GHA230090	K
	1996.09-1999.09	Hatchback Engine 176B7.000 Without ABS		o	GHA230044	K
	1994.01-1999.09	Hatchback Engine 176A3.000	•		GHA425008	
1.7 TD (51 kW)	1994.01-1999.09	Hatchback Engine 176A3.000	•		GWB1439	
	1994.01-1999.09	Hatchback Engine 176A3.000		o	GHA230090	K
	1994.01-1999.09	Hatchback Engine 176A3.000 Without ABS		o	GHA230044	K
	1994.01-1999.09	Hatchback Engine 176A5.000	•		GHA425008	
1.7 TD (52 kW)	1994.01-1999.09	Hatchback Engine 176A5.000	•		GWB1439	
	1994.01-1999.09	Hatchback Engine 176A5.000		o	GHA230090	K
	1994.01-1999.09	Hatchback Engine 176A5.000 Without ABS		o	GHA230044	K
	PUNTO (176C)					
1.2 (43 kW)	1994.04-2000.06	Convertible Engine 176A7.000	•		GHA422015	
	1994.04-2000.06	Convertible Engine 176A7.000	•		GWB3414	
	1994.04-2000.06	Convertible Engine 176A7.000		o	GHA230090	K
	1994.04-2000.06	Convertible Engine 176A7.000 Without ABS		o	GHA230044	K
1.2 (44 kW)	1995.05-2000.06	Convertible Engine 176B1.000/176B4.000	•		GHA422015	
	1995.05-2000.06	Convertible Engine 176B1.000/176B4.000	•		GWB3414	
	1995.05-2000.06	Convertible Engine 176B1.000/176B4.000		o	GHA230090	K
	1995.05-2000.06	Convertible Engine 176B1.000/176B4.000 Without ABS		o	GHA230044	K
1.2 16V (63 kW)	1997.04-2000.06	Convertible Engine 176B9.000	•		GHA422015	
	1997.04-2000.06	Convertible Engine 176B9.000	•		GWB3414	
	1997.04-2000.06	Convertible Engine 176B9.000		o	GHA230090	K
	1997.04-2000.06	Convertible Engine 176B9.000 Without ABS		o	GHA230044	K
1.6 (65 kW)	1994.04-1997.04	Convertible Engine 176A9.000	•		GHA422015	
	1994.04-1997.04	Convertible Engine 176A9.000	•		GWB3414	
	1994.04-1997.04	Convertible Engine 176A9.000		o	GHA230090	K
	1994.04-1997.04	Convertible Engine 176A9.000 Without ABS		o	GHA230044	K
PUNTO (188)						
1.2 (44 kW)	1999.09-	Hatchback Engine 188A4.000	•		GHA422015	
	1999.09-	Hatchback Engine 188A4.000	•		GWB3414	



	 YEAR		F	R	G-AP Ref.	KIT
FIAT						
PUNTO (188)						
1.2 (44 kW)	1999.09-	Hatchback Engine 188A4.000	•		GWB3538	
	1999.09-	Hatchback Engine 188A4.000 With ABS		◦	GHA230046	K
	1999.09-	Hatchback Engine 188A4.000 Without ABS		◦	GHA230044	K
1.2 16V (59 kW)	1999.09-	Hatchback Engine 188A5.000	•		GHA422015	
	1999.09-	Hatchback Engine 188A5.000	•		GWB3414	
	1999.09-	Hatchback Engine 188A5.000	•		GWB3538	
	1999.09-	Hatchback Engine 188A5.000 With ABS		◦	GHA230046	K
	1999.09-	Hatchback Engine 188A5.000 Without ABS		◦	GHA230044	K
1.2 Bifuel (44 kW)	2007.08-	Hatchback Engine 188 A4.000	•		GHA422015	
	2007.08-	Hatchback Engine 188 A4.000	•		GWB3538	
	2007.08-	Hatchback Engine 188 A4.000 With ABS		◦	GHA230046	K
	2007.08-	Hatchback Engine 188 A4.000 Without ABS		◦	GHA230044	K
1.2 Natural Power (44 kW)	2003.09-	Hatchback Engine 188A4.000	•		GHA422015	
	2003.09-	Hatchback Engine 188A4.000	•		GWB3414	
	2003.09-	Hatchback Engine 188A4.000	•		GWB3538	
	2003.09-	Hatchback Engine 188A4.000 With ABS		◦	GHA230046	K
	2003.09-	Hatchback Engine 188A4.000 Without ABS		◦	GHA230044	K
1.3 JTD 16V (51 kW)	2003.06-	Hatchback Engine 188A9.000	•		GHA425008	
	2003.06-	Hatchback Engine 188A9.000	•		GWB1439	
	2003.06-	Hatchback Engine 188A9.000	•		GWB3539	
	2003.06-	Hatchback Engine 188A9.000	•		GWB6540	
	2003.06-	Hatchback Engine 188A9.000 With ABS		◦	GHA230046	K
1.4 (70 kW)	2003.07-2006.01	Hatchback Engine 843A1.000	•		GHA422015	
	2003.07-2006.01	Hatchback Engine 843A1.000	•		GWB3414	
	2003.07-2006.01	Hatchback Engine 843A1.000	•		GWB3538	
	2003.07-2006.01	Hatchback Engine 843A1.000 With ABS		◦	GHA230046	K
	2003.07-2006.01	Hatchback Engine 843A1.000 Without ABS		◦	GHA230044	K
1.8 HGT (96 kW)	1999.09-	Hatchback Engine 183A1.000/188A6.000	•		GHA425008	
	1999.09-	Hatchback Engine 183A1.000/188A6.000	•		GWB3539	
	1999.09-	Hatchback Engine 183A1.000/188A6.000	•		GWB6540	
	1999.09-	Hatchback Engine 183A1.000/188A6.000 With ABS		◦	GHA230046	K
	1999.09-	Hatchback Engine 183A1.000/188A6.000 Without ABS		◦	GHA230044	K
1.9 DS (44 kW)	1999.09-	Hatchback Engine 188A3.000	•		GHA422015	
	1999.09-	Hatchback Engine 188A3.000	•		GWB3414	
	1999.09-	Hatchback Engine 188A3.000	•		GWB3538	
	1999.09-	Hatchback Engine 188A3.000 With ABS		◦	GHA230046	K
	1999.09-	Hatchback Engine 188A3.000 Without ABS		◦	GHA230044	K
1.9 JTD (59 kW)	1999.09-	Hatchback Engine 188A2.000	•		GHA425008	
	1999.09-	Hatchback Engine 188A2.000	•		GWB1439	
	1999.09-	Hatchback Engine 188A2.000	•		GWB3539	
	1999.09-	Hatchback Engine 188A2.000	•		GWB6540	
	1999.09-	Hatchback Engine 188A2.000 With ABS		◦	GHA230046	K
	1999.09-	Hatchback Engine 188A2.000 Without ABS		◦	GHA230044	K
1.9 JTD (63 kW)	2001.10-	Hatchback Engine 188A7.000	•		GHA425008	
	2001.10-	Hatchback Engine 188A7.000	•		GWB1439	
	2001.10-	Hatchback Engine 188A7.000	•		GWB3539	
	2001.10-	Hatchback Engine 188A7.000	•		GWB6540	
	2001.10-	Hatchback Engine 188A7.000 With ABS		◦	GHA230046	K
	2001.10-	Hatchback Engine 188A7.000 Without ABS		◦	GHA230044	K
1.9 JTD (74 kW)	2003.07-2006.01	Hatchback Engine 188B2.000	•		GHA425008	
	2003.07-2006.01	Hatchback Engine 188B2.000	•		GWB1439	
	2003.07-2006.01	Hatchback Engine 188B2.000	•		GWB3539	
	2003.07-2006.01	Hatchback Engine 188B2.000	•		GWB6540	
	2003.07-2006.01	Hatchback Engine 188B2.000 With ABS		◦	GHA230046	K
	2003.07-2006.01	Hatchback Engine 188B2.000 Without ABS		◦	GHA230044	K
PUNTO (199)						
0.9 (74 kW)	2013.12-	Hatchback Engine 199 B6.000		◦	GHA230092	K
0.9 (77 kW)	2013.07-	Hatchback Engine 199 B6.000		◦	GHA230092	K
0.9 Bifuel (63 kW)	2012.03-	Hatchback Engine 312A2.000		◦	GHA230092	K
0.9 Twinair Turbo (63 kW)	2012.03-	Hatchback Engine 312A2.000		◦	GHA230092	K
1.2 (49 kW)	2014.02-	Hatchback Engine 199 B9.000		◦	GHA230092	K
1.2 (51 kW)	2012.03-	Hatchback Engine 169A4.000		◦	GHA230092	K
1.3 D Multijet (55 kW)	2012.03-	Hatchback Engine 199A2.000/199A9.000	•		GWB3539	



	 YEAR		F	R	G-AP Ref.	KIT
FIAT						
PUNTO (199)						
1.3 D Multijet (55 kW)	2012.03-	Hatchback Engine 199A2.000/199A9.000	•		GWB6540	
	2012.03-	Hatchback Engine 199A2.000/199A9.000		◦	GHA230092	K
1.3 D Multijet (62 kW)	2012.03-	Hatchback Engine 198B4.000	•		GWB3539	
	2012.03-	Hatchback Engine 198B4.000	•		GWB6540	
	2012.03-	Hatchback Engine 198B4.000		◦	GHA230092	K
1.3 D Multijet (70 kW)	2012.03-	Hatchback Engine 199B1.000	•		GWB3539	
	2012.03-	Hatchback Engine 199B1.000	•		GWB6540	
	2012.03-	Hatchback Engine 199B1.000		◦	GHA230092	K
1.4 (55 kW)	2012.03-	Hatchback Engine 199A7.000		◦	GHA230092	K
1.4 (57 kW)	2012.03-	Hatchback Engine 350A1.000		◦	GHA230092	K
1.4 Bifuel (57 kW)	2012.03-	Hatchback Engine 350A1.000		◦	GHA230092	K
1.4 Multi Air (77 kW)	2012.03-	Hatchback Engine 955A6.000		◦	GHA230092	K
1.4 Natural Power (57 kW)	2012.03-	Hatchback Engine 350A1.000		◦	GHA230092	K
1.4 Turbo Multi Air (99 kW)	2012.03-	Hatchback Engine 955A2.000	•		GWB3539	
	2012.03-	Hatchback Engine 955A2.000	•		GWB6540	
	2012.03-	Hatchback Engine 955A2.000		◦	GHA230092	K
PUNTO / GRANDE PUNTO (199)						
1.2 (48 kW)	2006.01-	Hatchback Engine 199A4.000		◦	GHA230092	K
1.3 D Multijet (51 kW)	2008.07-	Hatchback Engine 199B2.000	•		GWB3539	
	2008.07-	Hatchback Engine 199B2.000	•		GWB6540	
	2008.07-	Hatchback Engine 199B2.000		◦	GHA230092	K
1.3 D Multijet (55 kW)	2006.01-2007.03	Hatchback Engine 199A2.000	•		GWB3539	
	2006.01-2007.03	Hatchback Engine 199A2.000	•		GWB6540	
	2006.01-2007.03	Hatchback Engine 199A2.000		◦	GHA230092	K
1.3 D Multijet (62 kW)	2010.04-	Hatchback Engine 199B4.000/233A9.000	•		GWB3539	
	2010.04-	Hatchback Engine 199B4.000/233A9.000	•		GWB6540	
	2010.04-	Hatchback Engine 199B4.000/233A9.000		◦	GHA230092	K
1.3 D Multijet (66 kW)	2006.01-2007.03	Hatchback Engine 199A3.000	•		GWB3539	
	2006.01-2007.03	Hatchback Engine 199A3.000	•		GWB6540	
	2006.01-2007.03	Hatchback Engine 199A3.000		◦	GHA230092	K
1.4 (55 kW)	2006.06-	Hatchback Engine 199A7.000		◦	GHA230092	K
1.4 (57 kW)	2006.01-2007.03	Hatchback Engine 350A1.000		◦	GHA230092	K
1.4 16V (70 kW)	2005.10-	Hatchback Engine 199A6.000		◦	GHA230092	K
1.4 LPG (57 kW)	2008.12-	Hatchback Engine 350A1.000		◦	GHA230092	K
1.4 Natural Power (57 kW)	2008.07-	Hatchback Engine 350A1.000		◦	GHA230092	K
1.4 T-Jet (88 kW)	2007.08-	Hatchback Engine 198A4.000	•		GWB3539	
	2007.08-	Hatchback Engine 198A4.000	•		GWB6540	
	2007.08-	Hatchback Engine 198A4.000		◦	GHA230092	K
1.6 D Multijet (88 kW)	2008.07-	Hatchback Engine 955A3.000	•		GWB3539	
	2008.07-	Hatchback Engine 955A3.000	•		GWB6540	
	2008.07-	Hatchback Engine 955A3.000		◦	GHA230092	K
1.9 D Multijet (88 kW)	2006.01-2007.03	Hatchback Engine 939A1.000	•		GWB3539	
	2006.01-2007.03	Hatchback Engine 939A1.000	•		GWB6540	
	2006.01-2007.03	Hatchback Engine 939A1.000		◦	GHA230092	K
1.9 D Multijet (96 kW)	2006.01-	Hatchback Engine 199A5.000	•		GWB3539	
	2006.01-	Hatchback Engine 199A5.000	•		GWB6540	
	2006.01-	Hatchback Engine 199A5.000		◦	GHA230092	K
PUNTO EVO (199)						
1.2 (48 kW)	2009.10-2012.02	Hatchback Engine 199A4.000		◦	GHA230092	K
1.2 (51 kW)	2009.10-2012.02	Hatchback Engine 169A4.000		◦	GHA230092	K
1.3 D Multijet (51 kW)	2008.07-2012.02	Hatchback Engine 199B2.000	•		GWB3539	
	2008.07-2012.02	Hatchback Engine 199B2.000	•		GWB6540	
	2008.07-2012.02	Hatchback Engine 199B2.000		◦	GHA230092	K
1.3 D Multijet (55 kW)	2009.10-2012.02	Hatchback Engine 199A2.000/199A9.000	•		GWB3539	
	2009.10-2012.02	Hatchback Engine 199A2.000/199A9.000	•		GWB6540	
	2009.10-2012.02	Hatchback Engine 199A2.000/199A9.000		◦	GHA230092	K
1.3 D Multijet (62 kW)	2009.10-2012.02	Hatchback Engine 199B4.000/223A9.000	•		GWB3539	
	2009.10-2012.02	Hatchback Engine 199B4.000/223A9.000	•		GWB6540	
	2009.10-2012.02	Hatchback Engine 199B4.000/223A9.000		◦	GHA230092	K
1.3 D Multijet (66 kW)	2009.10-2012.02	Hatchback Engine 199A3.000	•		GWB3539	
	2009.10-2012.02	Hatchback Engine 199A3.000	•		GWB6540	
	2009.10-2012.02	Hatchback Engine 199A3.000		◦	GHA230092	K
1.3 D Multijet (70 kW)	2009.10-2012.02	Hatchback Engine 199B1.000	•		GWB3539	
	2009.10-2012.02	Hatchback Engine 199B1.000	•		GWB6540	



	 YEAR		F	R	G-AP Ref.	KIT	
FIAT							
PUNTO EVO (199)							
1.3 D Multijet (70 kW)	2009.10-2012.02	Hatchback Engine 199B1.000		o	GHA230092	K	
1.4 (55 kW)	2009.07-2012.02	Hatchback Engine 199A7.000		o	GHA230092	K	
1.4 (57 kW)	2009.10-2012.02	Hatchback Engine 350A1.000		o	GHA230092	K	
1.4 16V (77 kW)	2009.10-2012.02	Hatchback Engine 955A6.000		o	GHA230092	K	
1.4 16V (99 kW)	2009.10-2012.02	Hatchback Engine 955A2.000	•		GWB3539		
	2009.10-2012.02	Hatchback Engine 955A2.000	•		GWB6540		
	2009.10-2012.02	Hatchback Engine 955A2.000		o	GHA230092	K	
1.4 LPG (57 kW)	2009.06-2012.02	Hatchback Engine 350A1.000		o	GHA230092	K	
1.4 Natural Power (57 kW)	2009.10-2012.02	Hatchback Engine 350A1.000		o	GHA230092	K	
1.6 D Multijet (88 kW)	2009.10-2012.02	Hatchback Engine 955A3.000	•		GWB3539		
	2009.10-2012.02	Hatchback Engine 955A3.000	•		GWB6540		
	2009.10-2012.02	Hatchback Engine 955A3.000		o	GHA230092	K	
PUNTO VAN (176L)							
1.1 (40 kW)	1996.04-2000.02	Box Engine 176B2.000	•		GHA422015		
	1996.04-2000.02	Box Engine 176B2.000	•		GWB3413		
	1996.04-2000.02	Box Engine 176B2.000		o	GHA230090	K	
	1996.04-2000.02	Box Engine 176B2.000 Without ABS		o	GHA230044	K	
1.7 D (42 kW)	1996.04-2000.02	Box Engine 176B3.000	•		GWB3414		
	1996.04-2000.02	Box Engine 176B3.000		o	GHA230090	K	
	1996.04-2000.02	Box Engine 176B3.000 Without ABS		o	GHA230044	K	
1.7 TD (52 kW)	1996.04-2000.02	Box Engine 176A5.000	•		GHA425008		
	1996.04-2000.02	Box Engine 176A5.000	•		GWB1439		
	1996.04-2000.02	Box Engine 176A5.000		o	GHA230090	K	
	1996.04-2000.02	Box Engine 176A5.000 Without ABS		o	GHA230044	K	
PUNTO VAN (188AX)							
1.2 (44 kW)	2000.02-2009.10	Box Engine 188A4.000	•		GHA422015		
	2000.02-2009.10	Box Engine 188A4.000	•		GWB3414		
	2000.02-2009.10	Box Engine 188A4.000	•		GWB3538		
	2000.02-2009.10	Box Engine 188A4.000 With ABS		o	GHA230046	K	
	2000.02-2009.10	Box Engine 188A4.000 Without ABS		o	GHA230044	K	
1.3 JTD (51 kW)	2003.06-2005.1	Box Engine 188 A9.000	•		GHA425008		
	2003.06-2005.1	Box Engine 188 A9.000	•		GWB1439		
	2003.06-2005.1	Box Engine 188 A9.000	•		GWB3539		
	2003.06-2005.1	Box Engine 188 A9.000	•		GWB6540		
	2003.06-2005.1	Box Engine 188 A9.000 With ABS		o	GHA230046	K	
	2003.06-2005.1	Box Engine 188 A9.000 Without ABS		o	GHA230044	K	
1.9 D (44 kW)	2000.02-2009.10	Box Engine 188A3.000	•		GHA422015		
	2000.02-2009.10	Box Engine 188A3.000	•		GWB3414		
	2000.02-2009.10	Box Engine 188A3.000	•		GWB3538		
	2000.02-2009.10	Box Engine 188A3.000 With ABS		o	GHA230046	K	
	2000.02-2009.10	Box Engine 188A3.000 Without ABS		o	GHA230044	K	
	2000.02-2009.10	Box Engine 188A7.000	•		GHA425008		
1.9 JTD (63 kW)	2000.02-2009.10	Box Engine 188A7.000	•		GWB1439		
	2000.02-2009.10	Box Engine 188A7.000	•		GWB3539		
	2000.02-2009.10	Box Engine 188A7.000	•		GWB6540		
	2000.02-2009.10	Box Engine 188A7.000 With ABS		o	GHA230046	K	
	2000.02-2009.10	Box Engine 188A7.000 Without ABS		o	GHA230044	K	
	PUNTO VAN (199)						
	1.3 D Multijet (55 kW)	2008.04-	Box Engine 199A2.000/199A9.000	•		GWB3539	
2008.04-		Box Engine 199A2.000/199A9.000	•		GWB6540		
2008.04-		Box Engine 199A2.000/199A9.000		o	GHA230092	K	
1.3 D Multijet (62 kW)	2012.03-	Box Engine 199B4.000	•		GWB3539		
	2012.03-	Box Engine 199B4.000	•		GWB6540		
	2012.03-	Box Engine 199B4.000		o	GHA230092	K	
1.3 D Multijet (66 kW)	2010.01-2012.02	Box Engine 199A3.000	•		GWB3539		
	2010.01-2012.02	Box Engine 199A3.000	•		GWB6540		
	2010.01-2012.02	Box Engine 199A3.000		o	GHA230092	K	
1.3 D Multijet (70 kW)	2009.03-	Box Engine 199B1.000	•		GWB3539		
	2009.03-	Box Engine 199B1.000	•		GWB6540		
	2009.03-	Box Engine 199B1.000		o	GHA230092	K	
1.4 (57 kW)	2008.04-	Box Engine 350A1.000		o	GHA230092	K	
1.4 LPG (57 kW)	2009.03-	Box Engine 350A1.000		o	GHA230092	K	
1.4 Natural Power (57 kW)	2009.03-	Box Engine 350A1.000		o	GHA230092	K	



	 YEAR		F	R	G-AP Ref.	KIT
FIAT						
QUBO (225)						
1.3 D Multijet (55 kW)	2008.02-	MPV Engine 199A2.000	•		GHA425008	
	2008.02-	MPV Engine 199A2.000	•		GWB3539	
	2008.02-	MPV Engine 199A2.000	•		GWB6540	
	2008.02-	MPV Engine 199A2.000 With ABS		○	GHA230046	K
1.3 D Multijet (70 kW)	2010.07-	MPV Engine 199B1.000	•		GHA425008	
	2010.07-	MPV Engine 199B1.000	•		GWB3539	
	2010.07-	MPV Engine 199B1.000	•		GWB6540	
	2010.07-	MPV Engine 199B1.000 With ABS		○	GHA230046	K
1.4 (54 kW)	2008.02-	MPV Engine KFT/KFV With ABS		○	GHA230046	K
1.4 Natural Power (57 kW)	2009.10-	MPV Engine 350A1.000 With ABS		○	GHA230046	K
SCUDO (220L)						
1.6 (58 kW)	1996.02-2006.12	Box Engine 220A2.000	•		GWB3423	
	1996.02-2006.12	Box Engine 220A2.000		○	GHA230111	K
1.9 D (51 kW)	1996.02-2006.12	Box Engine D9B	•		GWB3423	
	1996.02-2006.12	Box Engine D9B		○	GHA230111	K
	1998.04-2006.12	Box Engine WJZ(DW8)	•		GWB3423	
	1998.04-2006.12	Box Engine WJZ(DW8)		○	GHA230111	K
1.9 TD (66 kW)	1996.02-2006.12	Box Engine DHX(XUD9TF/L)	•		GWB3423	
	1996.02-2006.12	Box Engine DHX(XUD9TF/L)		○	GHA230111	K
1.9 TD (68 kW)	1998.02-2006.12	Box Engine D8B	•		GWB3423	
	1998.02-2006.12	Box Engine D8B		○	GHA230111	K
2.0 (100 kW)	2000.05-2006.12	Box Engine RFN	•		GWB3423	
	2000.05-2006.12	Box Engine RFN		○	GHA230111	K
2.0 JTD (69 kW)	1999.12-2006.12	Box Engine RHX	•		GWB3423	
	1999.12-2006.12	Box Engine RHX		○	GHA230111	K
2.0 JTD (80 kW)	2002.12-2006.12	Box Engine RHZ	•		GWB3423	
	2002.12-2006.12	Box Engine RHZ		○	GHA230111	K
2.0 JTD 16V (80 kW)	1999.05-2006.12	Box Engine RHW(DW10ATED4)	•		GWB3423	
	1999.05-2006.12	Box Engine RHW(DW10ATED4)		○	GHA230111	K
SCUDO (270_)						
1.6 D Multijet (66 kW)	2007.01-	Box Engine 9HU	•		GWB6575	
	2007.01-	Box Engine 9HU		○	GHA400182	K
	2007.01-	MPV Engine 9HU	•		GWB6575	
	2007.01-	MPV Engine 9HU		○	GHA400182	K
	2007.01-	Platform/Chassis Engine 9HU	•		GWB6575	
	2007.01-	Platform/Chassis Engine 9HU		○	GHA400182	K
2.0 D Multijet (100 kW)	2007.01-	Box Engine RHR	•		GWB6575	
	2007.01-	Box Engine RHR		○	GHA400182	K
	2007.01-	MPV Engine RHR	•		GWB6575	
	2007.01-	MPV Engine RHR		○	GHA400182	K
	2007.01-	Platform/Chassis Engine DW10BTED4/RHR	•		GWB6575	
	2007.01-	Platform/Chassis Engine DW10BTED4/RHR		○	GHA400182	K
2.0 D Multijet (120 kW)	2010.07-	Box Engine RHH	•		GWB6575	
	2010.07-	MPV Engine RHH	•		GWB6575	
	2010.07-	Platform/Chassis Engine RHH	•		GWB6575	
2.0 D Multijet (88 kW)	2007.01-	Box Engine RHK	•		GWB6575	
	2007.01-	Box Engine RHK		○	GHA400182	K
	2007.01-	MPV Engine RHK	•		GWB6575	
	2007.01-	MPV Engine RHK		○	GHA400182	K
	2007.01-	Platform/Chassis Engine RHK	•		GWB6575	
	2007.01-	Platform/Chassis Engine RHK		○	GHA400182	K
2.0 D Multijet (94 kW)	2011.04-	MPV Engine RH02	•		GWB6575	
	2011.05-	Box Engine RH02	•		GWB6575	
	2011.05-	Platform/Chassis Engine RH02	•		GWB6575	
2.0 D Multijet 4x4 (88 kW)	2007.01-	Box Engine RHK	•		GWB6575	
SCUDO (272, 270)						
	2007.01-	MPV Engine RHK	•		GWB6575	
2.0 D Multijet 4x4 (94 kW)	2011.04-	MPV Engine RH02	•		GWB6575	
SCUDO COMBINATO (220P)						
1.6 (58 kW)	1996.02-2006.12	Estate Engine 220A2.000	•		GWB3423	
	1996.02-2006.12	Estate Engine 220A2.000		○	GHA230111	K
1.9 D (51 kW)	1996.02-1998.04	Estate Engine D9B	•		GWB3423	
	1996.02-1998.04	Estate Engine D9B		○	GHA230111	K



	 YEAR		F	R	G-AP Ref.	KIT
FIAT						
SCUDO COMBINATO (220P)						
1.9 D (51 kW)	1998.04-2006.12	Estate Engine WJZ(DW8)	•		GWB3423	
	1998.04-2006.12	Estate Engine WJZ(DW8)		◦	GHA230111	K
1.9 TD (68 kW)	1996.02-2006.12	Estate Engine D8B	•		GWB3423	
	1996.02-2006.12	Estate Engine D8B		◦	GHA230111	K
1.9 TD Eco (66 kW)	1996.02-2006.12	Estate Engine DHX(XUD9TF/L)	•		GWB3423	
	1996.02-2006.12	Estate Engine DHX(XUD9TF/L)		◦	GHA230111	K
2.0 16V (100 kW)	2000.06-2006.12	Estate Engine RFN	•		GWB3423	
	2000.06-2006.12	Estate Engine RFN		◦	GHA230111	K
2.0 JTD (69 kW)	2004.01-2006.12	Estate Engine RHX	•		GWB3423	
	2004.01-2006.12	Estate Engine RHX		◦	GHA230111	K
2.0 JTD (80 kW)	1999.12-2006.12	Estate Engine RHZ	•		GWB3423	
	1999.12-2006.12	Estate Engine RHZ		◦	GHA230111	K
2.0 JTD 16V (80 kW)	1999.05-2006.12	Estate Engine RHW(DW10ATED4)	•		GWB3423	
	1999.05-2006.12	Estate Engine RHW(DW10ATED4)		◦	GHA230111	K
SEDICI						
1.6 16V (79 kW)	2006.06-	Closed Off-Road Vehicle Engine M16A	•		GWB6578	
	2006.06-	Closed Off-Road Vehicle Engine M16A		◦	GHA400188	K
1.6 16V (88 kW)	2006.06-	Closed Off-Road Vehicle Engine M16A	•		GWB6578	
	2006.06-	Closed Off-Road Vehicle Engine M16A		◦	GHA400188	K
1.6 16V 4x4 (79 kW)	2006.06-	Closed Off-Road Vehicle Engine M16A	•		GWB6578	
	2006.06-	Closed Off-Road Vehicle Engine M16A		◦	GHA324003	
1.6 16V 4x4 (88 kW)	2006.06-	Closed Off-Road Vehicle Engine M16A	•		GWB6578	
	2006.06-	Closed Off-Road Vehicle Engine M16A		◦	GHA324003	
1.9 D Multijet (88 kW)	2006.06-	Closed Off-Road Vehicle Engine D19AA	•		GWB6578	
	2006.06-	Closed Off-Road Vehicle Engine D19AA		◦	GHA400188	K
1.9 D Multijet 4x4 (88 kW)	2006.06-	Closed Off-Road Vehicle Engine D19AA	•		GWB6578	
	2006.06-	Closed Off-Road Vehicle Engine D19AA		◦	GHA324003	
2.0 D Multijet (99 kW)	2006.06-	Closed Off-Road Vehicle Engine D20AA	•		GWB6578	
	2006.06-	Closed Off-Road Vehicle Engine D20AA		◦	GHA400188	K
2.0 D Multijet 4x4 (99 kW)	2006.06-	Closed Off-Road Vehicle Engine D20AA	•		GWB6578	
	2006.06-	Closed Off-Road Vehicle Engine D20AA		◦	GHA324003	
SEICENTO (187)						
0.9 (29 kW)	1998.01-2010.01	Hatchback Engine 1170A1.046	•		GHA422015	
	1998.01-2010.01	Hatchback Engine 1170A1.046	•		GWB1401	
	1998.01-2010.01	Hatchback Engine 1170A1.046	•		GWB3577	
	1998.01-2010.01	Hatchback Engine 1170A1.046		◦	GHA230002	S
1.1 (40 kW)	1998.01-2010.01	Hatchback Engine 176B2.000/187A1.000	•		GWB1401	
	1998.01-2010.01	Hatchback Engine 176B2.000/187A1.000	•		GWB3577	
	1998.01-2010.01	Hatchback Engine 176B2.000/187A1.000		◦	GHA230002	S
SEICENTO / 600 (187)						
Elektra (30 kW)	1999.01-2005.01	Hatchback	•		GHA422015	
Elettrica (21 kW)	1998.06-2000.02	Hatchback	•		GHA422015	
SEICENTO VAN (187)						
0.9 (29 kW)	1998.01-2010.01	Box Engine 1170A1.046	•		GWB1401	
	1998.01-2010.01	Box Engine 1170A1.046	•		GWB3577	
	1998.01-2010.01	Box Engine 1170A1.046		◦	GHA230002	S
1.1 (40 kW)	1998.01-2010.01	Box Engine 176B2.000	•		GWB1401	
	1998.01-2010.01	Box Engine 176B2.000	•		GWB3577	
	1998.01-2010.01	Box Engine 176B2.000		◦	GHA230002	S
SIENA						
1.3 JTD (51 kW)	2007.11-	Saloon Engine 188A9.000	•		GWB1439	
	2007.11-	Saloon Engine 188A9.000	•		GWB3539	
	2007.11-	Saloon Engine 188A9.000	•		GWB6540	
	2007.11-	Saloon Engine 188A9.000 Without ABS		◦	GHA230044	K
1.4 (57 kW)	2007.11-	Saloon	•		GWB3528	
	2007.11-	Saloon	•		GWB6502	
	2007.11-	Saloon Without ABS		◦	GHA230044	K
SIENA (178_)						
1.0 (45 kW)	1998.09-	Saloon	•		GHA422018	
	1998.09-	Saloon	•		GWB3528	
	1998.09-	Saloon		◦	GHA230090	K
	1998.09-	Saloon With ABS		◦	GHA230046	K
	1998.09-	Saloon Without ABS		◦	GHA230044	K



	 YEAR		F	R	G-AP Ref.	KIT
FIAT						
SIENA (178_)						
1.2 (44 kW)	2001.09-	Saloon Engine 178C4.066/188A4.000	•		GHA422018	
1.2 (54 kW)	1998.09-	Saloon Engine 178B5.000	•		GHA422018	
	1998.09-	Saloon Engine 178B5.000	•		GWB3528	
	1998.09-	Saloon Engine 178B5.000	•		GWB6502	
	1998.09-	Saloon Engine 178B5.000		○	GHA230090	K
	1998.09-	Saloon Engine 178B5.000 With ABS		○	GHA230046	K
	1998.09-	Saloon Engine 178B5.000 Without ABS		○	GHA230044	K
	2001.09-2009.12	Saloon Engine 188 A5.000	•		GHA422018	
1.3 JTD (51 kW)	2003.09-	Saloon Engine 188A9.000	•		GHA425009	
1.4 (51 kW)	1996.04-	Saloon Engine 178B2.000	•		GHA422018	
	1996.04-	Saloon Engine 178B2.000	•		GWB3528	
	1996.04-	Saloon Engine 178B2.000	•		GWB6502	
	1996.04-	Saloon Engine 178B2.000		○	GHA230090	K
	1996.04-	Saloon Engine 178B2.000 With ABS		○	GHA230046	K
	1996.04-	Saloon Engine 178B2.000 Without ABS		○	GHA230044	K
	2007.01-	Saloon Engine 199A1.000	•		GHA422018	
1.4 CAT (51 kW)	1996.04-	Saloon Engine 178B2.016	•		GHA422018	
	1996.04-	Saloon Engine 178B2.016	•		GWB3528	
	1996.04-	Saloon Engine 178B2.016	•		GWB6502	
	1996.04-	Saloon Engine 178B2.016		○	GHA230090	K
	1996.04-	Saloon Engine 178B2.016 With ABS		○	GHA230046	K
	1996.04-	Saloon Engine 178B2.016 Without ABS		○	GHA230044	K
	2003.09-2005.12	Saloon	•		GHA422018	
1.6 (76 kW)	2000.11-	Saloon Engine 182B6.000	•		GHA422018	
1.6 16V (78 kW)	1998.09-	Saloon Engine 178B3.000	•		GHA422018	
	1998.09-	Saloon Engine 178B3.000	•		GWB3528	
	1998.09-	Saloon Engine 178B3.000	•		GWB6502	
	1998.09-	Saloon Engine 178B3.000		○	GHA230090	K
	1998.09-	Saloon Engine 178B3.000 With ABS		○	GHA230046	K
	1998.09-	Saloon Engine 178B3.000 Without ABS		○	GHA230044	K
	2006.02-	Saloon Engine 176A3.000	•		GHA422018	
1.7 TD (51 kW)						
STILO (192)						
1.2 16V (59 kW)	2002.02-2006.11	Hatchback Engine 188A5.000	•		GHA422015	
	2002.02-2006.11	Hatchback Engine 188A5.000	•		GWB3538	
	2002.02-2006.11	Hatchback Engine 188A5.000 With ABS		○	GHA230046	K
1.4 16V (66 kW)	2005.03-2006.11	Hatchback Engine 192B2.000	•		GHA425008	
	2005.03-2006.11	Hatchback Engine 192B2.000	•		GWB3598	
	2005.03-2006.11	Hatchback Engine 192B2.000 With ABS		○	GHA230046	K
1.4 16V (70 kW)	2004.01-2006.11	Hatchback Engine 843A1.000	•		GHA425008	
	2004.01-2006.11	Hatchback Engine 843A1.000	•		GWB3598	
	2004.01-2006.11	Hatchback Engine 843A1.000 With ABS		○	GHA230046	K
1.6 (100 kW)	2005.04-2006.11	Hatchback Engine 182 B6.000	•		GHA425008	
1.6 16V (76 kW)	2001.10-2006.11	Hatchback Engine 182B6.000	•		GHA425008	
	2001.10-2006.11	Hatchback Engine 182B6.000	•		GWB3598	
	2001.10-2006.11	Hatchback Engine 182B6.000 With ABS		○	GHA230046	K
1.6 16V (77 kW)	2005.05-2006.11	Hatchback Engine 192B30	•		GHA425008	
	2005.05-2006.11	Hatchback Engine 192B30	•		GWB3598	
	2005.05-2006.11	Hatchback Engine 192B30 With ABS		○	GHA230046	K
1.8 16V (98 kW)	2001.10-2006.11	Hatchback Engine 192A4.000	•		GHA425008	
	2001.10-2006.11	Hatchback Engine 192A4.000	•		GWB3598	
	2001.10-2006.11	Hatchback Engine 192A4.000 With ABS		○	GHA230046	K
1.9 D Multijet (110 kW)	2005.09-2006.11	Hatchback Engine 937A5.000	•		GWB3599	
	2005.09-2006.11	Hatchback Engine 937A5.000 With ABS		○	GHA230046	K
1.9 D Multijet (74 kW)	2005.09-2006.11	Hatchback Engine 192A9.000	•		GWB3598	
	2005.09-2006.11	Hatchback Engine 192A9.000 With ABS		○	GHA230046	K
1.9 D Multijet (88 kW)	2006.01-2007.06	Hatchback Engine 192A8.000	•		GHA425008	
	2006.01-2007.06	Hatchback Engine 192A8.000	•		GWB3598	
	2006.01-2007.06	Hatchback Engine 192A8.000 With ABS		○	GHA230046	K
1.9 JTD (100 kW)	2004.04-2006.11	Hatchback Engine 192 B1.000	•		GWB3598	
	2004.04-2006.11	Hatchback Engine 192 B1.000	•		GWB3599	
	2004.04-2006.11	Hatchback Engine 192 B1.000 With ABS		○	GHA230046	K
1.9 JTD (103 kW)	2004.01-2006.11	Hatchback Engine 192A5.000	•		GWB3598	
	2004.01-2006.11	Hatchback Engine 192A5.000	•		GWB3599	
	2004.01-2006.11	Hatchback Engine 192A5.000 With ABS		○	GHA230046	K



	 YEAR		F	R	G-AP Ref.	KIT
FIAT						
STILO (192)						
1.9 JTD (59 kW)	2002.02-2006.11	Hatchback Engine 192A3.000	•		GHA425008	
	2002.02-2006.11	Hatchback Engine 192A3.000	•		GWB3598	
	2002.02-2006.11	Hatchback Engine 192A3.000	•		GWB3599	
	2002.02-2006.11	Hatchback Engine 192A3.000 With ABS		○	GHA230046	K
1.9 JTD (66 kW)	2004.09-2006.11	Hatchback Engine 192B5.000	•		GHA425008	
	2004.09-2006.11	Hatchback Engine 192B5.000	•		GWB3598	
	2004.09-2006.11	Hatchback Engine 192B5.000	•		GWB3599	
	2004.09-2006.11	Hatchback Engine 192B5.000 With ABS		○	GHA230046	K
1.9 JTD (85 kW)	2001.10-2006.11	Hatchback Engine 192A1.000/937A7.000	•		GHA425008	
	2001.10-2006.11	Hatchback Engine 192A1.000/937A7.000	•		GWB3598	
	2001.10-2006.11	Hatchback Engine 192A1.000/937A7.000	•		GWB3599	
	2001.10-2006.11	Hatchback Engine 192A1.000/937A7.000 With ABS		○	GHA230046	K
1.9 JTD (93 kW)	2003.09-2006.11	Hatchback Engine 937A4.000	•		GWB3598	
	2003.09-2006.11	Hatchback Engine 937A4.000	•		GWB3599	
	2003.09-2006.11	Hatchback Engine 937A4.000 With ABS		○	GHA230046	K
2.4 20V (125 kW)	2001.10-2006.11	Hatchback Engine 192A2.000	•		GWB3599	
	2001.10-2006.11	Hatchback Engine 192A2.000 With ABS		○	GHA230046	K
STILO MULTI WAGON (192)						
1.4 16V (66 kW)	2005.03-2008.08	Estate Engine 192B2.000	•		GHA425008	
	2005.03-2008.08	Estate Engine 192B2.000	•		GWB3598	
	2005.03-2008.08	Estate Engine 192B2.000 With ABS		○	GHA230047	K
1.4 16V (70 kW)	2004.01-2008.08	Estate Engine 843A1.000	•		GHA425008	
	2004.01-2008.08	Estate Engine 843A1.000	•		GWB3598	
	2004.01-2008.08	Estate Engine 843A1.000		○	GHA230097	K
	2004.01-2008.08	Estate Engine 843A1.000 With ABS		○	GHA230047	K
1.6 16V (76 kW)	2003.01-2008.08	Estate Engine 182B6.000	•		GHA425008	
	2003.01-2008.08	Estate Engine 182B6.000	•		GWB3598	
	2003.01-2008.08	Estate Engine 182B6.000		○	GHA230097	K
	2003.01-2008.08	Estate Engine 182B6.000 With ABS		○	GHA230047	K
1.6 16V (77 kW)	2005.03-2007.12	Estate Engine 192 B3.000	•		GHA425008	
	2005.03-2007.12	Estate Engine 192 B3.000	•		GWB3598	
	2005.03-2007.12	Estate Engine 192 B3.000 With ABS		○	GHA230047	K
1.8 16V (98 kW)	2003.01-2008.08	Estate Engine 192A4.000	•		GHA425008	
	2003.01-2008.08	Estate Engine 192A4.000	•		GWB3598	
	2003.01-2008.08	Estate Engine 192A4.000		○	GHA230097	K
	2003.01-2008.08	Estate Engine 192A4.000 With ABS		○	GHA230047	K
1.9 D (66 kW)	2004.09-2008.08	Estate Engine 192B5.000	•		GHA425008	
	2004.09-2008.08	Estate Engine 192B5.000	•		GWB3598	
	2004.09-2008.08	Estate Engine 192B5.000 With ABS		○	GHA230047	K
1.9 D Multijet (110 kW)	2005.09-2008.08	Estate Engine 937A5.000	•		GWB3599	
	2005.09-2008.08	Estate Engine 937A5.000 With ABS		○	GHA230047	K
1.9 D Multijet (74 kW)	2005.09-2008.08	Estate Engine 192A9.000	•		GWB3598	
	2005.09-2008.08	Estate Engine 192A9.000 With ABS		○	GHA230047	K
1.9 D Multijet (88 kW)	2005.09-2008.08	Estate Engine 192A8.000	•		GHA425008	
	2005.09-2008.08	Estate Engine 192A8.000	•		GWB3598	
	2005.09-2008.08	Estate Engine 192A8.000 With ABS		○	GHA230047	K
1.9 JTD (100 kW)	2004.04-2008.08	Estate Engine 192 B1.000	•		GWB3598	
	2004.04-2008.08	Estate Engine 192 B1.000	•		GWB3599	
	2004.04-2008.08	Estate Engine 192 B1.000 With ABS		○	GHA230047	K
1.9 JTD (103 kW)	2004.01-2008.08	Estate Engine 192A5.000	•		GWB3598	
	2004.01-2008.08	Estate Engine 192A5.000	•		GWB3599	
	2004.01-2008.08	Estate Engine 192A5.000		○	GHA230097	K
	2004.01-2008.08	Estate Engine 192A5.000 With ABS		○	GHA230047	K
1.9 JTD (59 kW)	2003.01-2008.08	Estate Engine 192A3.000	•		GHA425008	
	2003.01-2008.08	Estate Engine 192A3.000	•		GWB3598	
	2003.01-2008.08	Estate Engine 192A3.000	•		GWB3599	
	2003.01-2008.08	Estate Engine 192A3.000		○	GHA230097	K
	2003.01-2008.08	Estate Engine 192A3.000 With ABS		○	GHA230047	K
1.9 JTD (85 kW)	2003.01-2008.08	Estate Engine 192A1.000/937A7.000	•		GHA425008	
	2003.01-2008.08	Estate Engine 192A1.000/937A7.000	•		GWB3598	
	2003.01-2008.08	Estate Engine 192A1.000/937A7.000	•		GWB3599	
	2003.01-2008.08	Estate Engine 192A1.000/937A7.000		○	GHA230097	K
	2003.01-2008.08	Estate Engine 192A1.000/937A7.000 With ABS		○	GHA230047	K
1.9 JTD (93 kW)	2003.09-2008.08	Estate Engine 937A4.000	•		GWB3598	



	 YEAR		F	R	G-AP Ref.	KIT	
FIAT							
STILO MULTI WAGON (192)							
1.9 JTD (93 kW)	2003.09-2008.08	Estate Engine 937A4.000	•		GWB3599		
	2003.09-2008.08	Estate Engine 937A4.000		○	GHA230097	K	
	2003.09-2008.08	Estate Engine 937A4.000 With ABS		○	GHA230047	K	
STRADA (178E)							
1.2 (44 kW)	2003.04-	Pickup Engine 188A4.000	•		GHA422007		
	2003.04-	Pickup Engine 188A4.000	•		GWB3416		
	2003.04-	Pickup Engine 188A4.000	•		GWB3581		
	2003.04-	Pickup Engine 188A4.000		○	GHA230107		
1.2 (54 kW)	1999.06-	Pickup Engine 178B5.000	•		GHA422007		
	1999.06-	Pickup Engine 178B5.000	•		GWB3416		
	1999.06-	Pickup Engine 178B5.000	•		GWB3581		
	1999.06-	Pickup Engine 178B5.000		○	GHA230107		
1.3 D Multijet (62 kW)	2006.05-	Pickup Engine 223A9.000	•		GHA425009		
	2006.05-	Pickup Engine 223A9.000	•		GWB1439		
	2006.05-	Pickup Engine 223A9.000	•		GWB3539		
	2006.05-	Pickup Engine 223A9.000	•		GWB6540		
	2006.05-	Pickup Engine 223A9.000		○	GHA230107		
1.7 TD (51 kW)	1999.06-	Pickup Engine 176A3.000	•		GHA422007		
	1999.06-	Pickup Engine 176A3.000	•		GHA422018		
	1999.06-	Pickup Engine 176A3.000	•		GWB3416		
	1999.06-	Pickup Engine 176A3.000	•		GWB3528		
	1999.06-	Pickup Engine 176A3.000	•		GWB3581		
	1999.06-	Pickup Engine 176A3.000	•		GWB6502		
	1999.06-	Pickup Engine 176A3.000		○	GHA230107		
	1.9 D (46 kW)	2000.12-	Pickup Engine 223A6.000	•		GHA422007	
		2000.12-	Pickup Engine 223A6.000	•		GWB3416	
2000.12-		Pickup Engine 223A6.000	•		GWB3581		
2000.12-		Pickup Engine 223A6.000		○	GHA230107		
1.9 JTD (59 kW)	2003.04-	Pickup Engine 188A2.000	•		GHA425009		
	2003.04-	Pickup Engine 188A2.000	•		GWB1439		
	2003.04-	Pickup Engine 188A2.000	•		GWB3539		
	2003.04-	Pickup Engine 188A2.000	•		GWB6540		
	2003.04-	Pickup Engine 188A2.000		○	GHA230107		
STRADA (578_)							
1.3 D Multijet (70 kW)	2010.10-	Pickup Engine 199 B1.000		○	GHA230107		
TEMPRA (159)							
1.4 i.e. (51 kW)	1992.03-1996.08	Saloon Engine 160A1.046/836A4.000	•		GHA422015		
	1992.03-1996.08	Saloon Engine 160A1.046/836A4.000	•		GHA425008		
	1992.03-1996.08	Saloon Engine 160A1.046/836A4.000	•		GWB1438		
	1992.03-1996.08	Saloon Engine 160A1.046/836A4.000		○	GHA230028	K	
	1992.03-1996.08	Saloon Engine 160A1.046/836A4.000 Without ABS		○	GHA230044	K	
1.4 i.e. (57 kW)	1991.03-1996.08	Saloon Engine 159A2.000	•		GHA422015		
	1991.03-1996.08	Saloon Engine 159A2.000	•		GHA425008		
	1991.03-1996.08	Saloon Engine 159A2.000	•		GWB1438		
	1991.03-1996.08	Saloon Engine 159A2.000		○	GHA230028	K	
	1991.03-1996.08	Saloon Engine 159A2.000 Without ABS		○	GHA230044	K	
1.6 (51 kW)	1990.04-1993.06	Saloon Engine 159 A3.048	•		GWB1438		
	1990.04-1993.06	Saloon Engine 159 A3.048	•		GWB3416		
	1990.04-1993.06	Saloon Engine 159 A3.048		○	GHA230028	K	
	1990.04-1993.06	Saloon Engine 159 A3.048 Without ABS		○	GHA230044	K	
1.6 (63 kW)	1990.03-1993.04	Saloon Engine 159A3.000	•		GHA422015		
	1990.03-1993.04	Saloon Engine 159A3.000	•		GHA425008		
	1990.03-1993.04	Saloon Engine 159A3.000	•		GWB1438		
	1990.03-1993.04	Saloon Engine 159A3.000	•		GWB3416		
	1990.03-1993.04	Saloon Engine 159A3.000		○	GHA230028	K	
	1990.03-1993.04	Saloon Engine 159A3.000 Without ABS		○	GHA230044	K	
1.6 i.e. (55 kW)	1992.06-1996.08	Saloon Engine 159A3.048/835C1.000	•		GHA422015		
	1992.06-1996.08	Saloon Engine 159A3.048/835C1.000	•		GHA425008		
	1992.06-1996.08	Saloon Engine 159A3.048/835C1.000	•		GWB1438		
	1992.06-1996.08	Saloon Engine 159A3.048/835C1.000	•		GWB3416		
	1992.06-1996.08	Saloon Engine 159A3.048/835C1.000		○	GHA230028	K	
	1992.06-1996.08	Saloon Engine 159A3.048/835C1.000 Without ABS		○	GHA230044	K	
1.6 i.e. (57 kW)	1990.06-1992.07	Saloon Engine 159A3.046	•		GHA422015		
	1990.06-1992.07	Saloon Engine 159A3.046	•		GHA425008		



	 YEAR		F	R	G-AP Ref.	KIT
FIAT						
TEMPRA (159)						
1.6 i.e. (57 kW)	1990.06-1992.07	Saloon Engine 159A3.046	•		GWB1438	
	1990.06-1992.07	Saloon Engine 159A3.046	•		GWB3416	
	1990.06-1992.07	Saloon Engine 159A3.046 Without ABS		○	GHA230044	K
1.6 i.e. (63 kW)	1994.06-1996.08	Saloon Engine 159B9.000	•		GHA422015	
	1994.06-1996.08	Saloon Engine 159B9.000	•		GHA425008	
	1994.06-1996.08	Saloon Engine 159B9.000	•		GWB1438	
	1994.06-1996.08	Saloon Engine 159B9.000	•		GWB3416	
	1994.06-1996.08	Saloon Engine 159B9.000		○	GHA230028	K
	1994.06-1996.08	Saloon Engine 159B9.000 Without ABS		○	GHA230044	K
1.6 i.e. (66 kW)	1994.06-1996.08	Saloon Engine 159B9.000	•		GHA422015	
	1994.06-1996.08	Saloon Engine 159B9.000	•		GHA425008	
	1994.06-1996.08	Saloon Engine 159B9.000	•		GWB1438	
	1994.06-1996.08	Saloon Engine 159B9.000	•		GWB3416	
	1994.06-1996.08	Saloon Engine 159B9.000		○	GHA230028	K
	1994.06-1996.08	Saloon Engine 159B9.000 Without ABS		○	GHA230044	K
1.8 i.e. (66 kW)	1993.09-1996.08	Saloon Engine 835C4.000	•		GWB1439	
	1993.09-1996.08	Saloon Engine 835C4.000		○	GHA230028	K
	1993.09-1996.08	Saloon Engine 835C4.000		○	GHA425008	
	1993.09-1996.08	Saloon Engine 835C4.000 Without ABS		○	GHA230044	K
1.8 i.e. (74 kW)	1994.10-1996.08	Saloon Engine 836A5.000	•		GWB1439	
	1994.10-1996.08	Saloon Engine 836A5.000		○	GHA230028	K
	1994.10-1996.08	Saloon Engine 836A5.000		○	GHA425008	
	1994.10-1996.08	Saloon Engine 836A5.000 Without ABS		○	GHA230044	K
1.8 i.e. (76 kW)	1993.09-1996.08	Saloon Engine 835C2.000	•		GWB1439	
	1993.09-1996.08	Saloon Engine 835C2.000		○	GHA230028	K
	1993.09-1996.08	Saloon Engine 835C2.000		○	GHA425008	
	1993.09-1996.08	Saloon Engine 835C2.000 Without ABS		○	GHA230044	K
1.8 i.e. (77 kW)	1992.03-1996.08	Saloon Engine 159A4.046	•		GWB1439	
	1992.03-1996.08	Saloon Engine 159A4.046		○	GHA230028	K
	1992.03-1996.08	Saloon Engine 159A4.046		○	GHA425008	
	1992.03-1996.08	Saloon Engine 159A4.046 Without ABS		○	GHA230044	K
1.8 i.e. (81 kW)	1990.03-1996.08	Saloon Engine 159A4.000	•		GWB1439	
	1990.03-1996.08	Saloon Engine 159A4.000		○	GHA230028	K
	1990.03-1996.08	Saloon Engine 159A4.000		○	GHA425008	
	1990.03-1996.08	Saloon Engine 159A4.000 Without ABS		○	GHA230044	K
1.9 D (48 kW)	1991.07-1996.08	Saloon Engine 149A1.000/160A7.000	•		GHA422015	
	1991.07-1996.08	Saloon Engine 149A1.000/160A7.000	•		GWB1438	
	1991.07-1996.08	Saloon Engine 149A1.000/160A7.000		○	GHA230028	K
	1991.07-1996.08	Saloon Engine 149A1.000/160A7.000 Without ABS		○	GHA230044	K
1.9 TD (59 kW)	1992.07-1996.08	Saloon Engine 160B6.046	•		GHA425008	
	1992.07-1996.08	Saloon Engine 160B6.046	•		GWB1439	
	1992.07-1996.08	Saloon Engine 160B6.046		○	GHA230028	K
	1992.07-1996.08	Saloon Engine 160B6.046 Without ABS		○	GHA230044	K
1.9 TD (66 kW)	1990.05-1996.08	Saloon Engine 160A6.000/160D1.000	•		GHA425008	
	1990.05-1996.08	Saloon Engine 160A6.000/160D1.000	•		GWB1439	
	1990.05-1996.08	Saloon Engine 160A6.000/160D1.000		○	GHA230028	K
	1990.05-1996.08	Saloon Engine 160A6.000/160D1.000 Without ABS		○	GHA230044	K
2.0 i.e. (83 kW)	1990.10-1996.08	Saloon Engine 159A6.046	•		GWB1439	
	1990.10-1996.08	Saloon Engine 159A6.046		○	GHA230028	K
	1990.10-1996.08	Saloon Engine 159A6.046		○	GHA425008	
	1990.10-1996.08	Saloon Engine 159A6.046 Without ABS		○	GHA230044	K
TEMPRA S.W. (159)						
1.4 i.e. (51 kW)	1992.10-1996.08	Estate Engine 160A1.046/836A4.000	•		GHA422015	
	1992.10-1996.08	Estate Engine 160A1.046/836A4.000	•		GHA425008	
	1992.10-1996.08	Estate Engine 160A1.046/836A4.000	•		GWB1438	
	1992.10-1996.08	Estate Engine 160A1.046/836A4.000		○	GHA230028	K
	1992.10-1996.08	Estate Engine 160A1.046/836A4.000 Without ABS		○	GHA230044	K
1.4 i.e. (57 kW)	1991.03-1996.08	Estate Engine 159A2.000	•		GHA422015	
	1991.03-1996.08	Estate Engine 159A2.000	•		GHA425008	
	1991.03-1996.08	Estate Engine 159A2.000	•		GWB1438	
	1991.03-1996.08	Estate Engine 159A2.000		○	GHA230028	K
	1991.03-1996.08	Estate Engine 159A2.000 Without ABS		○	GHA230044	K
1.6 (63 kW)	1990.12-1993.04	Estate Engine 159A3.000	•		GHA422015	
	1990.12-1993.04	Estate Engine 159A3.000	•		GHA425008	



	 YEAR		F	R	G-AP Ref.	KIT
FIAT						
TEMPRA S.W. (159)						
1.6 (63 kW)	1990.12-1993.04	Estate Engine 159A3.000	•		GWB1438	
	1990.12-1993.04	Estate Engine 159A3.000	•		GWB3416	
	1990.12-1993.04	Estate Engine 159A3.000		○	GHA230028	K
	1990.12-1993.04	Estate Engine 159A3.000 Without ABS		○	GHA230044	K
1.6 i.e. (55 kW)	1992.10-1996.08	Estate Engine 159A3.048/835C1.000	•		GHA422015	
	1992.10-1996.08	Estate Engine 159A3.048/835C1.000	•		GHA425008	
	1992.10-1996.08	Estate Engine 159A3.048/835C1.000	•		GWB1438	
	1992.10-1996.08	Estate Engine 159A3.048/835C1.000	•		GWB3416	
	1992.10-1996.08	Estate Engine 159A3.048/835C1.000		○	GHA230028	K
	1992.10-1996.08	Estate Engine 159A3.048/835C1.000 Without ABS		○	GHA230044	K
1.6 i.e. (57 kW)	1990.10-1996.08	Estate Engine 159A3.046/835C1.000	•		GHA422015	
	1990.10-1996.08	Estate Engine 159A3.046/835C1.000	•		GHA425008	
	1990.10-1996.08	Estate Engine 159A3.046/835C1.000	•		GWB1438	
	1990.10-1996.08	Estate Engine 159A3.046/835C1.000	•		GWB3416	
	1990.10-1996.08	Estate Engine 159A3.046/835C1.000		○	GHA230028	K
	1990.10-1996.08	Estate Engine 159A3.046/835C1.000		○	GHA230044	K
	1990.10-1996.08	Estate Engine 159A3.046/835C1.000 Without ABS		○	GHA230044	K
	1990.10-1996.08	Estate Engine 159A3.046/835C1.000 Without ABS		○	GHA230044	K
1.6 i.e. (66 kW)	1994.06-1996.08	Estate Engine 159B9.000	•		GHA422015	
	1994.06-1996.08	Estate Engine 159B9.000	•		GHA425008	
	1994.06-1996.08	Estate Engine 159B9.000	•		GWB1438	
	1994.06-1996.08	Estate Engine 159B9.000	•		GWB3416	
	1994.06-1996.08	Estate Engine 159B9.000		○	GHA230028	K
	1994.06-1996.08	Estate Engine 159B9.000 Without ABS		○	GHA230044	K
1.8 i.e. (66 kW)	1993.09-1996.08	Estate Engine 835C4.000	•		GWB1439	
	1993.09-1996.08	Estate Engine 835C4.000		○	GHA230028	K
	1993.09-1996.08	Estate Engine 835C4.000		○	GHA425008	
	1993.09-1996.08	Estate Engine 835C4.000 Without ABS		○	GHA230044	K
1.8 i.e. (74 kW)	1994.10-1996.08	Estate Engine 836A5.000	•		GWB1439	
	1994.10-1996.08	Estate Engine 836A5.000		○	GHA230028	K
	1994.10-1996.08	Estate Engine 836A5.000		○	GHA425008	
	1994.10-1996.08	Estate Engine 836A5.000 Without ABS		○	GHA230044	K
1.8 i.e. (76 kW)	1993.09-1996.08	Estate Engine 835C2.000	•		GWB1439	
	1993.09-1996.08	Estate Engine 835C2.000		○	GHA230028	K
	1993.09-1996.08	Estate Engine 835C2.000		○	GHA425008	
	1993.09-1996.08	Estate Engine 835C2.000 Without ABS		○	GHA230044	K
1.8 i.e. (77 kW)	1992.03-1993.12	Estate Engine 159A4.046	•		GWB1439	
	1992.03-1993.12	Estate Engine 159A4.046		○	GHA230028	K
	1992.03-1993.12	Estate Engine 159A4.046		○	GHA425008	
	1992.03-1993.12	Estate Engine 159A4.046 Without ABS		○	GHA230044	K
1.8 i.e. (81 kW)	1990.03-1996.08	Estate Engine 159A4.000	•		GWB1439	
	1990.03-1996.08	Estate Engine 159A4.000		○	GHA230028	K
	1990.03-1996.08	Estate Engine 159A4.000		○	GHA425008	
	1990.03-1996.08	Estate Engine 159A4.000 Without ABS		○	GHA230044	K
1.9 D (48 kW)	1991.07-1996.08	Estate Engine 149A1.000/160A7.000	•		GHA422015	
	1991.07-1996.08	Estate Engine 149A1.000/160A7.000	•		GWB1438	
	1991.07-1996.08	Estate Engine 149A1.000/160A7.000		○	GHA230028	K
	1991.07-1996.08	Estate Engine 149A1.000/160A7.000 Without ABS		○	GHA230044	K
1.9 TD (59 kW)	1992.03-1993.06	Estate Engine 160B6.046	•		GHA425008	
	1992.03-1993.06	Estate Engine 160B6.046	•		GWB1439	
	1992.03-1993.06	Estate Engine 160B6.046		○	GHA230028	K
	1992.03-1993.06	Estate Engine 160B6.046 Without ABS		○	GHA230044	K
1.9 TD (66 kW)	1991.07-1995.02	Estate Engine 160A6.000/160D1.000	•		GHA425008	
	1991.07-1995.02	Estate Engine 160A6.000/160D1.000	•		GWB1439	
	1991.07-1995.02	Estate Engine 160A6.000/160D1.000		○	GHA230028	K
	1991.07-1995.02	Estate Engine 160A6.000/160D1.000 Without ABS		○	GHA230044	K
2.0 i.e. (83 kW)	1991.01-1995.03	Estate Engine 159A6.046	•		GWB1439	
	1991.01-1995.03	Estate Engine 159A6.046		○	GHA230028	K
	1991.01-1995.03	Estate Engine 159A6.046		○	GHA425008	
	1991.01-1995.03	Estate Engine 159A6.046 Without ABS		○	GHA230044	K
2.0 i.e. 4x4 (83 kW)	1992.03-1995.03	Estate Engine 159A6.046	•		GWB1439	
	1992.03-1995.03	Estate Engine 159A6.046		○	GHA425008	
TIPO (160)						
1.6 (56 kW)	1993.03-1995.1	Hatchback	•		GHA422015	
	1993.03-1995.1	Hatchback	•		GHA425008	
1.6 i.e. (55 kW)	1992.10-1995.04	Hatchback Engine 159A3.048/835C1.000	•		GHA422015	



	 YEAR		F	R	G-AP Ref.	KIT
FIAT						
TIPO (160)						
1.6 i.e. (55 kW)	1992.10-1995.04	Hatchback Engine 159A3.048/835C1.000	•		GHA425008	
	1992.10-1995.04	Hatchback Engine 159A3.048/835C1.000	•		GWB1438	
	1992.10-1995.04	Hatchback Engine 159A3.048/835C1.000		◦	GHA230028	K
	1992.10-1995.04	Hatchback Engine 159A3.048/835C1.000 Without ABS		◦	GHA230044	K
1.6 i.e. (57 kW)	1990.07-1993.01	Hatchback Engine 159A3.046	•		GHA422015	
	1990.07-1993.01	Hatchback Engine 159A3.046	•		GHA425008	
	1990.07-1993.01	Hatchback Engine 159A3.046	•		GWB1438	
	1990.07-1993.01	Hatchback Engine 159A3.046		◦	GHA230028	K
	1990.07-1993.01	Hatchback Engine 159A3.046 Without ABS		◦	GHA230044	K
1.8 i.e. (71 kW)	1993.03-1995.04	Hatchback Engine 836A5.000	•		GHA425008	
	1993.03-1995.04	Hatchback Engine 836A5.000	•		GWB1439	
	1993.03-1995.04	Hatchback Engine 836A5.000		◦	GHA230028	K
	1993.03-1995.04	Hatchback Engine 836A5.000 Without ABS		◦	GHA230044	K
1.8 i.e. (66 kW)	1993.09-1995.04	Hatchback Engine 835C4.000	•		GHA425008	
	1993.09-1995.04	Hatchback Engine 835C4.000	•		GWB1439	
	1993.09-1995.04	Hatchback Engine 835C4.000		◦	GHA230028	K
	1993.09-1995.04	Hatchback Engine 835C4.000 Without ABS		◦	GHA230044	K
1.8 i.e. (74 kW)	1994.10-1995.04	Hatchback Engine 159A4.000	•		GWB1439	
	1994.10-1995.04	Hatchback Engine 159A4.000		◦	GHA230028	K
	1994.10-1995.04	Hatchback Engine 159A4.000 Without ABS		◦	GHA230044	K
1.8 i.e. (76 kW)	1993.04-1995.04	Hatchback Engine 835C2.000	•		GHA425008	
	1993.04-1995.04	Hatchback Engine 835C2.000	•		GWB1439	
	1993.04-1995.04	Hatchback Engine 835C2.000		◦	GHA230028	K
	1993.04-1995.04	Hatchback Engine 835C2.000 Without ABS		◦	GHA230044	K
1.8 i.e. (77 kW)	1990.10-1993.06	Hatchback Engine 159A4.046	•		GWB1439	
	1990.10-1993.06	Hatchback Engine 159A4.046		◦	GHA230028	K
	1990.10-1993.06	Hatchback Engine 159A4.046 Without ABS		◦	GHA230044	K
1.8 i.e. (81 kW)	1990.10-1993.06	Hatchback Engine 159A4.000	•		GHA425008	
	1990.10-1993.06	Hatchback Engine 159A4.000	•		GWB1439	
	1990.10-1993.06	Hatchback Engine 159A4.000		◦	GHA230028	K
	1990.10-1993.06	Hatchback Engine 159A4.000 Without ABS		◦	GHA230044	K
1.9 D (48 kW)	1991.07-1996.08	Hatchback Engine 149A1.000/160A7.000	•		GHA422015	
	1991.07-1996.08	Hatchback Engine 149A1.000/160A7.000	•		GWB1438	
	1991.07-1996.08	Hatchback Engine 149A1.000/160A7.000		◦	GHA230028	K
	1991.07-1996.08	Hatchback Engine 149A1.000/160A7.000 Without ABS		◦	GHA230044	K
1.9 TD (59 kW)	1992.03-1993.06	Hatchback Engine 160B6.046	•		GHA425008	
	1992.03-1993.06	Hatchback Engine 160B6.046	•		GWB1439	
	1992.03-1993.06	Hatchback Engine 160B6.046		◦	GHA230028	K
	1992.03-1993.06	Hatchback Engine 160B6.046 Without ABS		◦	GHA230044	K
1.9 TD (66 kW)	1990.09-1995.04	Hatchback Engine 160A6.000/160A6.046/160D1.000	•		GHA425008	
	1990.09-1995.04	Hatchback Engine 160A6.000/160A6.046/160D1.000	•		GWB1439	
	1990.09-1995.04	Hatchback Engine 160A6.000/160A6.046/160D1.000		◦	GHA230028	K
	1990.09-1995.04	Hatchback Engine 160A6.000/160A6.046/160D1.000 Without ABS		◦	GHA230044	K
2.0 (104 kW)	1993.03-1995.04	Hatchback Engine 836 A3.011	•		GHA425008	
2.0 (85 kW)	1990.10-1992.1	Hatchback Engine 159 A5.046/159 A6.046	•		GHA425008	
2.0 16V (107 kW)	1991.07-1995.04	Hatchback Engine 160A8.046	•		GHA425008	
	1991.07-1995.04	Hatchback Engine 160A8.046	•		GWB1439	
	1991.07-1995.04	Hatchback Engine 160A8.046		◦	GHA230028	K
	1991.07-1995.04	Hatchback Engine 160A8.046 Without ABS		◦	GHA230044	K
2.0 i.e. (80 kW)	1990.06-1992.03	Hatchback Engine 159A5.046	•		GHA425008	
	1990.06-1992.03	Hatchback Engine 159A5.046	•		GWB1439	
	1990.06-1992.03	Hatchback Engine 159A5.046		◦	GHA230028	K
	1990.06-1992.03	Hatchback Engine 159A5.046 Without ABS		◦	GHA230044	K
2.0 i.e. (83 kW)	1990.03-1995.04	Hatchback Engine 159A6.046	•		GHA425008	
	1990.03-1995.04	Hatchback Engine 159A6.046	•		GWB1439	
	1990.03-1995.04	Hatchback Engine 159A6.046		◦	GHA230028	K
	1990.03-1995.04	Hatchback Engine 159A6.046 Without ABS		◦	GHA230044	K
2.0 i.e. 16V Sport (102 kW)	1993.03-1995.04	Hatchback Engine 836A3.000	•		GHA425008	
	1993.03-1995.04	Hatchback Engine 836A3.000	•		GWB1439	
	1993.03-1995.04	Hatchback Engine 836A3.000		◦	GHA230028	K
	1993.03-1995.04	Hatchback Engine 836A3.000 Without ABS		◦	GHA230044	K
ULYSSE (179AX)						
2.0 (100 kW)	2002.08-2011.06	MPV Engine RFN(EW10J4)	•		GWB3633	
	2002.08-2011.06	MPV Engine RFN(EW10J4)	•		GWB3649	



	 YEAR		F	R	G-AP Ref.	KIT
FIAT						
ULYSSE (179AX)						
2.0 (100 kW)	2002.08-2011.06	MPV Engine RFN(EW10J4)		o	GHA230121	K
2.0 D Multijet (100 kW)	2006.05-2011.06	MPV Engine RHR	•		GWB3633	
	2006.05-2011.06	MPV Engine RHR	•		GWB3649	
2.0 D Multijet (88 kW)	2006.05-2011.06	MPV Engine RHR		o	GHA230121	K
	2006.05-2011.06	MPV Engine RHK	•		GWB3633	
	2006.05-2011.06	MPV Engine RHK	•		GWB3649	
2.0 JTD (79 kW)	2006.05-2011.06	MPV Engine RHK		o	GHA230121	K
	2003.07-2005.01	MPV Engine RHM(DW10ATED4)	•		GWB3633	
2.0 JTD (80 kW)	2003.07-2005.01	MPV Engine RHM(DW10ATED4)		o	GHA230121	K
	2002.08-2006.08	MPV Engine RHW(DW10ATED4)	•		GWB3633	
2.2 D Multijet (125 kW)	2002.08-2006.08	MPV Engine RHW(DW10ATED4)		o	GHA230121	K
	2008.03-2011.06	MPV Engine 4HS/4HT(DW12BTED4)	•		GWB3649	
2.2 JTD (120 kW)	2008.03-2011.06	MPV Engine 4HS/4HT(DW12BTED4)		o	GHA230121	K
	2008.03-2011.06	MPV Engine 4HP/4HR	•		GWB3649	
2.2 JTD (94 kW)	2008.03-2011.06	MPV Engine 4HP/4HR		o	GHA230121	K
	2002.08-2006.08	MPV Engine 4HW(DW12ATED4)	•		GWB3633	
3.0 (150 kW)	2002.08-2006.08	MPV Engine 4HW(DW12ATED4)		o	GHA230121	K
	2002.08-2011.06	MPV Engine XFW	•		GWB3649	
2002.08-2011.06	2002.08-2011.06	MPV Engine XFW		o	GHA230121	K
	ULYSSE (220)					
1.8 (73 kW)	1997.05-2002.08	MPV Engine LFW	•		GWB3423	
1.9 TD (66 kW)	1997.05-2002.08	MPV Engine LFW		o	GHA230111	K
	1995.02-2002.08	MPV Engine DHX(XUD9TF/L)	•		GWB3423	
2.0 (89 kW)	1995.02-2002.08	MPV Engine DHX(XUD9TF/L)		o	GHA230111	K
	1994.06-2002.08	MPV Engine RFU(XU10J2C)	•		GWB3423	
2.0 16V (100 kW)	1994.06-2002.08	MPV Engine RFU(XU10J2C)		o	GHA230111	K
	2000.09-2002.08	MPV Engine RFN(EW10J4)	•		GWB3423	
2.0 16V (97 kW)	2000.09-2002.08	MPV Engine RFN(EW10J4)		o	GHA230111	K
	1998.05-2000.09	MPV Engine RFV	•		GWB3423	
2.0 JTD (80 kW)	1998.05-2000.09	MPV Engine RFV		o	GHA230111	K
	1999.10-2002.08	MPV Engine RHZ	•		GWB3423	
2.0 JTD 16V (80 kW)	1999.10-2002.08	MPV Engine RHZ		o	GHA230111	K
	1999.05-2002.08	MPV Engine RHW(DW10ATED4)	•		GWB3423	
2.0 Turbo (108 kW)	1999.05-2002.08	MPV Engine RHW(DW10ATED4)		o	GHA230111	K
	1994.06-2002.08	MPV Engine RGX(XU10J2CTE)	•		GWB3423	
2.1 TD (80 kW)	1994.06-2002.08	MPV Engine RGX(XU10J2CTE)		o	GHA230111	K
	1996.03-1999.10	MPV Engine P8C	•		GWB3423	
1996.03-1999.10	1996.03-1999.10	MPV Engine P8C		o	GHA230111	K
	UNO (146A/E)					
1.0 iE (34 kW)	1998.05-2000.08	Hatchback Engine 156 A2.246	•		GHA420004	
1.1 (37 kW)	1990.01-1993.12	Hatchback Engine 156C.046	•		GHA420004	
	1990.01-1993.12	Hatchback Engine 156C.046		o	GHA230002	F
1.4 (51 kW)	1991.07-1996.07	Hatchback Engine 160 A1.046	•		GHA420004	
	1991.07-1996.07	Hatchback Engine 160 A1.046		o	GHA230002	F
1.4 i.e. (36 kW)	1992.06-1993.12	Hatchback Engine 146C3.000	•		GHA420004	
	1992.06-1993.12	Hatchback Engine 146C3.000		o	GHA230002	F
1.6 R (66 kW)	1992.12-1995.12	Hatchback Engine 159A3.048	•		GHA420004	
FORD						
B-MAX						
1.0 EcoBoost (74 kW)	2012.10-	MPV Engine SFJA/SFJB	•		GWB6653	
	2012.10-	MPV Engine SFJA/SFJB		o	GHA400336	K
1.0 EcoBoost (88 kW)	2012.10-	MPV Engine M1JA	•		GWB6653	
	2012.10-	MPV Engine M1JA		o	GHA400336	K
1.0 EcoBoost (92 kW)	2012.12-	MPV Engine M1JE	•		GWB6653	
	2012.12-	MPV Engine M1JE		o	GHA400336	K
1.4 (66 kW)	2012.10-	MPV Engine SPJD	•		GWB6653	
	2012.10-	MPV Engine SPJD		o	GHA400336	K
1.5 TDCi (55 kW)	2012.10-	MPV Engine UGJC	•		GWB6653	
	2012.10-	MPV Engine UGJC		o	GHA400336	K
1.6 TDCi (70 kW)	2012.10-	MPV Engine T3JB	•		GWB6653	
	2012.10-	MPV Engine T3JB		o	GHA400336	K
1.6 TI (77 kW)	2012.10-	MPV Engine IQJA	•		GWB6653	
	2012.10-	MPV Engine IQJA		o	GHA400336	K



	 YEAR		F	R	G-AP Ref.	KIT
FORD						
B-MAX (JK)						
1.4 LPG (63 kW)	2013.08-	MPV Engine RTJC	•		GWB6653	
1.4 LPG (66 kW)	2013.08-	MPV Engine RTJC	•		GWB6653	
	2013.08-	MPV Engine RTJC		○	GHA400336	K
1.5 TDCi (70 kW)	2015.04-	MPV Engine XVJA/XVJC	•		GWB6653	
B-MAX VAN						
1.0 EcoBoost (74 kW)	2012.10-	Box Engine SFJA/SFJB/SFJC	•		GWB6653	
1.0 EcoBoost (92 kW)	2012.10-	Box Engine M1JE	•		GWB6653	
1.4 (66 kW)	2012.10-	Box Engine SPJD	•		GWB6653	
1.5 TDCi (55 kW)	2012.10-	Box Engine UGJC	•		GWB6653	
1.5 TDCi (70 kW)	2015.04-	Box Engine XVJA/XVJC	•		GWB6653	
1.6 TDCi (70 kW)	2012.10-	Box Engine T3JB	•		GWB6653	
1.6 Ti (77 kW)	2012.10-	Box Engine IQJA	•		GWB6653	
C-MAX						
1.6 (74 kW)	2007.03-2008.03	MPV Engine HWDA/HWDB/SHDA/SHDB/SHDC	•		GHA336003	K
	2007.03-2008.03	MPV Engine HWDA/HWDB/SHDA/SHDB/SHDC With ABS		○	GHA400084	K
	2007.03-2008.03	MPV Engine HWDA/HWDB/SHDA/SHDB/SHDC Without ABS		○	GHA400105	
1.6 TDCi (66 kW)	2007.03-2008.03	MPV Engine GPDA/HHDA/HHDB	•		GHA336003	K
	2007.03-2008.03	MPV Engine GPDA/HHDA/HHDB With ABS		○	GHA400084	K
	2007.03-2008.03	MPV Engine GPDA/HHDA/HHDB Without ABS		○	GHA400105	
1.6 TDCi (74 kW)	2007.02-	MPV Engine G8DC/MTDA	•		GHA336003	K
	2007.02-	MPV Engine G8DC/MTDA With ABS		○	GHA400084	K
1.6 TDCi (80 kW)	2007.03-2008.03	MPV Engine G8DA/G8DB/G8DD	•		GHA336003	K
	2007.03-2008.03	MPV Engine G8DA/G8DB/G8DD With ABS		○	GHA400084	K
	2007.03-2008.03	MPV Engine G8DA/G8DB/G8DD Without ABS		○	GHA400105	
1.8 (90 kW)	2007.02-	MPV Engine QQDC	•		GHA336003	K
	2007.02-	MPV Engine QQDC With ABS		○	GHA400084	K
1.8 (92 kW)	2007.03-2008.03	MPV Engine QQDA/QQDB	•		GHA336003	K
	2007.03-2008.03	MPV Engine QQDA/QQDB With ABS		○	GHA400084	K
	2007.03-2008.03	MPV Engine QQDA/QQDB Without ABS		○	GHA400105	
1.8 FlexFuel (92 kW)	2007.02-	MPV Engine Q7DA	•		GHA336003	K
	2007.02-	MPV Engine Q7DA With ABS		○	GHA400084	K
	2007.02-	MPV Engine Q7DA Without ABS		○	GHA400105	
1.8 TDCi (85 kW)	2007.02-	MPV Engine KKDA	•		GHA336003	K
	2007.02-	MPV Engine KKDA With ABS		○	GHA400084	K
	2007.02-	MPV Engine KKDA Without ABS		○	GHA400105	
2.0 (107 kW)	2007.03-2008.03	MPV Engine AODA/AODB/AODE/SYDA	•		GHA336003	K
	2007.03-2008.03	MPV Engine AODA/AODB/AODE/SYDA With ABS		○	GHA400084	K
	2007.03-2008.03	MPV Engine AODA/AODB/AODE/SYDA Without ABS		○	GHA400105	
2.0 CNG (107 kW)	2009.04-	MPV Engine SYDA	•		GHA336003	K
	2009.04-	MPV Engine SYDA With ABS		○	GHA400084	K
	2009.04-	MPV Engine SYDA Without ABS		○	GHA400105	
2.0 LPG (107 kW)	2008.06-	MPV Engine SYDA	•		GHA336003	K
	2008.06-	MPV Engine SYDA With ABS		○	GHA400084	K
	2008.06-	MPV Engine SYDA Without ABS		○	GHA400105	
2.0 TDCi (100 kW)	2007.03-2008.03	MPV Engine G6DA/G6DB/G6DD/G6DG	•		GHA336003	K
	2007.03-2008.03	MPV Engine G6DA/G6DB/G6DD/G6DG With ABS		○	GHA400084	K
	2007.03-2008.03	MPV Engine G6DA/G6DB/G6DD/G6DG Without ABS		○	GHA400105	
2.0 TDCi (81 kW)	2008.02-	MPV Engine IXDA	•		GHA336003	K
	2008.02-	MPV Engine IXDA With ABS		○	GHA400084	K
	2008.02-	MPV Engine IXDA Without ABS		○	GHA400105	
2.0 TDCi (98 kW)	2007.02-	MPV Engine G6DF/G6DE/G6DC	•		GHA336003	K
	2007.02-	MPV Engine G6DF/G6DE/G6DC With ABS		○	GHA400084	K
C-MAX (DM2)						
1.6 (85 kW)	2007.04-2010.09	MPV Engine HXDA/HXDB	•		GHA336003	K
	2007.04-2010.09	MPV Engine HXDA/HXDB With ABS		○	GHA400084	K
COUGAR (EC_)						
2.0 16V (96 kW)	1998.08-2001.12	Coupe Engine EDDB/EDBB/EDBC/EDBD	•		GWB1480	
	1998.08-2001.12	Coupe Engine EDDB/EDBB/EDBC/EDBD With ABS		○	GHA235005	K
	1998.08-2001.12	Coupe Engine EDDB/EDBB/EDBC/EDBD Without ABS		○	GHA235009	K
2.5 ST (151 kW)	2000.01-2001.12	Coupe Engine SGA	•		GWB1480	
	2000.01-2001.12	Coupe Engine SGA With ABS		○	GHA235005	K
	2000.01-2001.12	Coupe Engine SGA Without ABS		○	GHA235009	K
2.5 V6 24V (125 kW)	1998.08-2001.12	Coupe Engine LCBA	•		GWB1480	



	 YEAR		F	R	G-AP Ref.	KIT
FORD						
COUGAR (EC_)						
2.5 V6 24V (125 kW)	1998.08-2001.12	Coupe Engine LCBA With ABS		o	GHA235005	K
	1998.08-2001.12	Coupe Engine LCBA Without ABS		o	GHA235009	K
	2000.06-2001.12	Coupe Engine LCBB/LCBC/LCBE	•		GWB1480	
	2000.06-2001.12	Coupe Engine LCBB/LCBC/LCBE With ABS		o	GHA235005	K
	2000.06-2001.12	Coupe Engine LCBB/LCBC/LCBE Without ABS		o	GHA235009	K
COURIER (F3L, F5L)						
1.3 (44 kW)	1991.09-1996.02	Box Engine J6B	•		GHA423002	
	1991.09-1996.02	Box Engine J6B	•		GHA425004	K
	1991.09-1996.02	Box Engine J6B	•		GWB1431	
	1991.09-1996.02	Box Engine J6B	•		GWB1432	
	1991.09-1996.02	Box Engine J6B		o	GWB1455	
	1991.09-1996.02	Box Engine J6B Without ABS		o	GHA235009	K
1.8 D (44 kW)	1991.09-1996.02	Box Engine RTC/RTD/RTG	•		GHA423002	
	1991.09-1996.02	Box Engine RTC/RTD/RTG	•		GHA425004	K
	1991.09-1996.02	Box Engine RTC/RTD/RTG	•		GWB1431	
	1991.09-1996.02	Box Engine RTC/RTD/RTG	•		GWB1432	
	1991.09-1996.02	Box Engine RTC/RTD/RTG		o	GWB1455	
	1991.09-1996.02	Box Engine RTC/RTD/RTG Without ABS		o	GHA235009	K
COURIER (J5_, J3_)						
1.3 (44 kW)	1996.02-	Box Engine J4C	•		GHA425004	K
	1996.02-	Box Engine J4C	•		GWB1432	
	1996.02-	Box Engine J4C With ABS		o	GHA235005	K
	1996.02-	Box Engine J4C Without ABS		o	GHA235009	K
1.4 i (66 kW)	1996.04-1999.10	Box Engine FHA	•		GHA425004	K
	1996.04-1999.10	Box Engine FHA	•		GWB1432	
	1996.04-1999.10	Box Engine FHA With ABS		o	GHA235005	K
	1996.04-1999.10	Box Engine FHA Without ABS		o	GHA235009	K
1.8 D (44 kW)	1996.02-	Box Engine RTK	•		GHA425004	K
	1996.02-	Box Engine RTK	•		GWB1432	
	1996.02-	Box Engine RTK With ABS		o	GHA235005	K
	1996.02-	Box Engine RTK Without ABS		o	GHA235009	K
1.8 Di (55 kW)	2000.09-	Box Engine RTN/RTP	•		GHA425004	K
	2000.09-	Box Engine RTN/RTP	•		GWB1432	
	2000.09-	Box Engine RTN/RTP With ABS		o	GHA235005	K
	2000.09-	Box Engine RTN/RTP Without ABS		o	GHA235009	K
COURIER (JV_)						
1.8 D (44 kW)	1998.05-	Box Engine RTJ/RTK	•		GHA425004	K
	1998.05-	Box Engine RTJ/RTK	•		GWB1432	
	1998.05-	Box Engine RTJ/RTK		o	GWB3666	
1.8 TD (55 kW)	2000.03-	Box Engine RTN/RTP/RTQ	•		GHA425004	K
	2000.03-	Box Engine RTN/RTP/RTQ	•		GWB1432	
	2000.03-	Box Engine RTN/RTP/RTQ		o	GWB3666	
CROWN VICTORIA						
-	2002-1997	With ABS	•		GHA237006	
ECOSPORT						
1.0 EcoBoost (92 kW)	2013.10-		•		GWB6653	
	2013.10-			o	GHA400336	K
1.5 TDCi (66 kW)	2013.10-		•		GWB6653	
	2013.10-			o	GHA400336	K
1.5 TDCi (70 kW)	2015.05-	Closed Off-Road Vehicle Engine XVJD	•		GWB6653	
1.5 Ti (82 kW)	2013.10-		•		GWB6653	
	2013.10-			o	GHA400336	K
1.6 Ti-VCT (90 kW)	2012.08-	Closed Off-Road Vehicle Engine HXJD/IQJB	•		GWB6653	
ESCORT '91 EXPRESS (AVL)						
1.3 (46 kW)	1990.07-1994.12	Box Engine JBD	•		GHA425004	K
	1990.07-1994.12	Box Engine JBD	•		GWB1431	
	1990.07-1994.12	Box Engine JBD	•		GWB1432	
	1990.07-1994.12	Box Engine JBD		o	GWB1433	
1.4 (52 kW)	1990.07-1994.12	Box Engine F6F/F6G	•		GHA425004	K
	1990.07-1994.12	Box Engine F6F/F6G	•		GWB1431	
	1990.07-1994.12	Box Engine F6F/F6G	•		GWB1432	
	1990.07-1994.12	Box Engine F6F/F6G		o	GWB1433	
1.8 D (44 kW)	1990.07-1994.12	Box Engine RTH	•		GHA425004	K



	 YEAR		F	R	G-AP Ref.	KIT
FORD						
ESCORT '91 EXPRESS (AVL)						
1.8 D (44 kW)	1990.07-1994.12	Box Engine RTH	•		GWB1432	
	1990.07-1994.12	Box Engine RTH		○	GWB1433	
ESCORT '95 (AVL)						
1.4 (54 kW)	1995.01-	Box Engine F4B	•		GHA425004	K
	1995.01-	Box Engine F4B	•		GWB1432	
	1995.01-	Box Engine F4B		○	GWB1433	
1.8 D (44 kW)	1995.01-	Box Engine RTF/RTH	•		GHA425004	K
	1995.01-	Box Engine RTF/RTH	•		GWB1432	
	1995.01-	Box Engine RTF/RTH		○	GWB1433	
1.8 TD (66 kW)	1995.01-	Box Engine RFD/RFK/RFS	•		GWB1432	
	1995.01-	Box Engine RFD/RFK/RFS		○	GWB1433	
1.8 Turbo D (51 kW)	1995.12-2001.06	Box Engine RVA	•		GHA425004	K
	1995.12-2001.06	Box Engine RVA	•		GWB1432	
	1995.12-2001.06	Box Engine RVA		○	GWB1433	
ESCORT CLASSIC (AAL, ABL)						
1.6 16V (66 kW)	1998.10-2000.07	Hatchback Engine L1E	•		GHA425004	K
	1998.10-2000.07	Hatchback Engine L1E	•		GWB1432	
	1998.10-2000.07	Hatchback Engine L1E		○	GWB3666	
1.8 TD (66 kW)	1998.10-2000.07	Hatchback Engine RFD/RFK	•		GHA425004	K
	1998.10-2000.07	Hatchback Engine RFD/RFK	•		GWB1432	
	1998.10-2000.07	Hatchback Engine RFD/RFK		○	GWB3666	
ESCORT CLASSIC TURNIER (ANL)						
1.6 16V (66 kW)	1999.02-2000.07	Estate Engine L1E	•		GHA425004	K
	1999.02-2000.07	Estate Engine L1E	•		GWB1432	
	1999.02-2000.07	Estate Engine L1E		○	GWB3666	
1.8 TD (66 kW)	1999.02-2000.07	Estate Engine RFD/RFK	•		GHA425004	K
	1999.02-2000.07	Estate Engine RFD/RFK	•		GWB1432	
	1999.02-2000.07	Estate Engine RFD/RFK		○	GWB3666	
ESCORT V (ALL)						
1.4 (52 kW)	1990.07-1992.12	Convertible Engine F6F/F6G	•		GHA425004	K
	1990.07-1992.12	Convertible Engine F6F/F6G	•		GWB1431	
	1990.07-1992.12	Convertible Engine F6F/F6G	•		GWB1432	
	1990.07-1992.12	Convertible Engine F6F/F6G		○	GWB1333	
1.6 (77 kW)	1990.07-1992.12	Convertible Engine LJF	•		GHA425004	K
	1990.07-1992.12	Convertible Engine LJF	•		GWB1431	
	1990.07-1992.12	Convertible Engine LJF	•		GWB1432	
1.8 16V XR3i (77 kW)	1992.02-1992.12	Convertible Engine RDA	•		GHA425004	K
	1992.02-1992.12	Convertible Engine RDA	•		GWB1432	
	1992.02-1992.12	Convertible Engine RDA		○	GWB1333	
1.8 16V XR3i (96 kW)	1992.02-1992.12	Convertible Engine RQB	•		GHA425004	K
	1992.02-1992.12	Convertible Engine RQB	•		GWB1432	
	1992.02-1992.12	Convertible Engine RQB		○	GWB1333	
ESCORT V (GAL)						
1.3 (44 kW)	1990.07-1992.09	Hatchback Engine J4B/J6A	•		GHA425004	K
	1990.07-1992.09	Hatchback Engine J4B/J6A	•		GWB1431	
	1990.07-1992.09	Hatchback Engine J4B/J6A	•		GWB1432	
	1990.07-1992.09	Hatchback Engine J4B/J6A		○	GWB1333	
1.4 (52 kW)	1990.07-1992.09	Hatchback Engine F6F/F6G	•		GHA425004	K
	1990.07-1992.09	Hatchback Engine F6F/F6G	•		GWB1431	
	1990.07-1992.09	Hatchback Engine F6F/F6G	•		GWB1432	
	1990.07-1992.09	Hatchback Engine F6F/F6G		○	GWB1333	
1.6 (66 kW)	1990.07-1992.08	Hatchback Engine LUJ/LUK	•		GHA425004	K
	1990.07-1992.08	Hatchback Engine LUJ/LUK	•		GWB1431	
	1990.07-1992.08	Hatchback Engine LUJ/LUK	•		GWB1432	
	1990.07-1992.08	Hatchback Engine LUJ/LUK		○	GWB1333	
1.6 (77 kW)	1990.07-1992.12	Hatchback Engine LJF	•		GHA425004	K
	1990.07-1992.12	Hatchback Engine LJF	•		GWB1431	
	1990.07-1992.12	Hatchback Engine LJF	•		GWB1432	
	1990.07-1992.12	Hatchback Engine LJF		○	GWB1333	
1.8 16V XR3i (77 kW)	1992.02-1992.12	Hatchback Engine RDA	•		GHA425004	K
	1992.02-1992.12	Hatchback Engine RDA	•		GWB1432	
	1992.02-1992.12	Hatchback Engine RDA		○	GWB1333	



	 YEAR		F	R	G-AP Ref.	KIT
FORD						
ESCORT V (GAL)						
1.8 16V XR3i (96 kW)	1992.02-1992.12	Hatchback Engine RQB	•		GHA425004	K
	1992.02-1992.12	Hatchback Engine RQB	•		GWB1432	
	1992.02-1992.12	Hatchback Engine RQB		○	GWB1333	
1.8 D (44 kW)	1990.07-1992.12	Hatchback Engine RTE/RTF/RTH	•		GHA425004	K
	1990.07-1992.12	Hatchback Engine RTE/RTF/RTH	•		GWB1432	
	1990.07-1992.12	Hatchback Engine RTE/RTF/RTH		○	GWB1333	
2.0 RS (110 kW)	1991.05-1992.12	Hatchback Engine N7A	•		GHA425004	K
	1991.05-1992.12	Hatchback Engine N7A	•		GWB1431	
	1991.05-1992.12	Hatchback Engine N7A	•		GWB1432	
	1991.05-1992.12	Hatchback Engine N7A		○	GWB1333	
ESCORT V (GAL, AVL)						
1.3 (44 kW)	1991.09-1992.09	Estate Engine J4B/J6A	•		GHA425004	K
	1991.09-1992.09	Estate Engine J4B/J6A	•		GWB1431	
	1991.09-1992.09	Estate Engine J4B/J6A	•		GWB1432	
	1991.09-1992.09	Estate Engine J4B/J6A		○	GWB1333	
	1991.09-1992.09	Estate Engine J4B/J6A		○	GWB1433	
1.4 (52 kW)	1990.07-1992.09	Estate Engine F6F/F6G	•		GHA425004	K
	1990.07-1992.09	Estate Engine F6F/F6G	•		GWB1431	
	1990.07-1992.09	Estate Engine F6F/F6G	•		GWB1432	
	1990.07-1992.09	Estate Engine F6F/F6G		○	GWB1333	
	1990.07-1992.09	Estate Engine F6F/F6G		○	GWB1433	
1.6 (66 kW)	1990.07-1992.08	Estate Engine LUJ/LUK	•		GHA425004	K
	1990.07-1992.08	Estate Engine LUJ/LUK	•		GWB1431	
	1990.07-1992.08	Estate Engine LUJ/LUK	•		GWB1432	
	1990.07-1992.08	Estate Engine LUJ/LUK		○	GWB1333	
	1990.07-1992.08	Estate Engine LUJ/LUK		○	GWB1433	
1.6 (77 kW)	1990.07-1992.09	Estate Engine LJF	•		GHA425004	K
	1990.07-1992.09	Estate Engine LJF	•		GWB1431	
	1990.07-1992.09	Estate Engine LJF	•		GWB1432	
	1990.07-1992.09	Estate Engine LJF		○	GWB1333	
	1990.07-1992.09	Estate Engine LJF		○	GWB1433	
1.8 16V (77 kW)	1992.02-1992.12	Estate Engine RDA	•		GHA425004	K
	1992.02-1992.12	Estate Engine RDA	•		GWB1432	
	1992.02-1992.12	Estate Engine RDA		○	GWB1333	
	1992.02-1992.12	Estate Engine RDA		○	GWB1433	
1.8 D (44 kW)	1990.07-1992.12	Estate Engine RTE/RTF/RTH	•		GHA425004	K
	1990.07-1992.12	Estate Engine RTE/RTF/RTH	•		GWB1432	
	1990.07-1992.12	Estate Engine RTE/RTF/RTH		○	GWB1333	
	1990.07-1992.12	Estate Engine RTE/RTF/RTH		○	GWB1433	
1.8 TD (55 kW)	1991.05-1992.12	Estate	•		GWB1432	
	1991.05-1992.12	Estate		○	GWB1333	
	1991.05-1992.12	Estate		○	GWB1433	
ESCORT VI (ALL)						
1.4 (52 kW)	1992.12-1994.04	Convertible Engine F6F/F6G	•		GHA425004	K
	1992.12-1994.04	Convertible Engine F6F/F6G	•		GWB1432	
	1992.12-1994.04	Convertible Engine F6F/F6G		○	GWB1333	
1.4 i (55 kW)	1993.07-1995.01	Convertible Engine F4B	•		GHA425004	K
	1993.07-1995.01	Convertible Engine F4B	•		GWB1432	
	1993.07-1995.01	Convertible Engine F4B		○	GWB1333	
1.6 16V XR3i (66 kW)	1992.12-1995.01	Convertible Engine L1E	•		GHA425004	K
	1992.12-1995.01	Convertible Engine L1E	•		GWB1432	
	1992.12-1995.01	Convertible Engine L1E		○	GWB1333	
1.6 i 16V (65 kW)	1994.02-1995.01	Convertible Engine L1H	•		GHA425004	K
	1994.02-1995.01	Convertible Engine L1H	•		GWB1432	
	1994.02-1995.01	Convertible Engine L1H		○	GWB1333	
1.8 16V XR3i (77 kW)	1992.12-1995.01	Convertible Engine RDA	•		GHA425004	K
	1992.12-1995.01	Convertible Engine RDA	•		GWB1432	
	1992.12-1995.01	Convertible Engine RDA		○	GWB1333	
1.8 16V XR3i (96 kW)	1992.12-1995.01	Convertible Engine RQB	•		GHA425004	K
	1992.12-1995.01	Convertible Engine RQB	•		GWB1432	
	1992.12-1995.01	Convertible Engine RQB		○	GWB1333	
ESCORT VI (GAL)						
1.3 (44 kW)	1992.09-1995.01	Estate Engine J4B/J6A	•		GHA425004	K
	1992.09-1995.01	Estate Engine J4B/J6A	•		GWB1432	



	 YEAR		F	R	G-AP Ref.	KIT
FORD						
ESCORT VI (GAL)						
1.3 (44 kW)	1992.09-1995.01	Estate Engine J4B/J6A		o	GWB1333	
	1992.09-1995.01	Estate Engine J4B/J6A		o	GWB1433	
	1992.09-1995.01	Hatchback Engine J4B/J6A	•		GHA425004	K
	1992.09-1995.01	Hatchback Engine J4B/J6A	•		GWB1432	
	1992.09-1995.01	Hatchback Engine J4B/J6A		o	GWB1333	
	1993.08-1995.01	Saloon Engine J4B/J6A	•		GHA425004	K
	1993.08-1995.01	Saloon Engine J4B/J6A	•		GWB1432	
	1993.08-1995.01	Saloon Engine J4B/J6A		o	GWB1333	
	1.4 (52 kW)	1992.09-1995.01	Estate Engine F6F/F6G	•		GHA425004
1992.09-1995.01		Estate Engine F6F/F6G	•		GWB1432	
1992.09-1995.01		Estate Engine F6F/F6G		o	GWB1333	
1992.09-1995.01		Estate Engine F6F/F6G		o	GWB1433	
1992.09-1995.01		Hatchback Engine F6F/F6G	•		GHA425004	K
1992.09-1995.01		Hatchback Engine F6F/F6G	•		GWB1432	
1992.09-1995.01		Hatchback Engine F6F/F6G		o	GWB1333	
1993.08-1994.04		Saloon Engine F6F/F6G	•		GHA425004	K
1993.08-1994.04		Saloon Engine F6F/F6G	•		GWB1432	
1993.08-1994.04		Saloon Engine F6F/F6G		o	GWB1333	
1.4 (55 kW)		1993.08-1995.01	Saloon Engine F4B/FUH	•		GHA425004
	1993.08-1995.01	Saloon Engine F4B/FUH	•		GWB1432	
	1993.08-1995.01	Saloon Engine F4B/FUH		o	GWB1333	
	1994.01-1995.01	Estate Engine F4B/FUH	•		GHA425004	K
	1994.01-1995.01	Estate Engine F4B/FUH	•		GWB1432	
	1994.01-1995.01	Estate Engine F4B/FUH		o	GWB1333	
	1994.01-1995.01	Estate Engine F4B/FUH		o	GWB1433	
	1994.01-1995.01	Hatchback Engine F4B/FUH	•		GHA425004	K
	1994.01-1995.01	Hatchback Engine F4B/FUH	•		GWB1432	
	1994.01-1995.01	Hatchback Engine F4B/FUH		o	GWB1333	
1.6 i 16V (65 kW)	1994.01-1995.01	Estate Engine L1H	•		GHA425004	K
	1994.01-1995.01	Estate Engine L1H	•		GWB1432	
	1994.01-1995.01	Estate Engine L1H		o	GWB1333	
	1994.01-1995.01	Estate Engine L1H		o	GWB1433	
	1994.01-1995.01	Hatchback Engine L1H	•		GHA425004	K
	1994.01-1995.01	Hatchback Engine L1H	•		GWB1432	
	1994.01-1995.01	Hatchback Engine L1H		o	GWB1333	
	1994.01-1995.01	Saloon Engine L1H	•		GHA425004	K
	1994.01-1995.01	Saloon Engine L1H	•		GWB1432	
	1994.01-1995.01	Saloon Engine L1H		o	GWB1333	
	1.6 i 16V (66 kW)	1992.09-1995.01	Estate Engine L1E	•		GHA425004
1992.09-1995.01		Estate Engine L1E	•		GWB1432	
1992.09-1995.01		Estate Engine L1E		o	GWB1333	
1992.09-1995.01		Estate Engine L1E		o	GWB1433	
1992.09-1995.01		Hatchback Engine L1E	•		GHA425004	K
1992.09-1995.01		Hatchback Engine L1E	•		GWB1432	
1992.09-1995.01		Hatchback Engine L1E		o	GWB1333	
1993.08-1995.01		Saloon Engine L1E/L1K	•		GHA425004	K
1993.08-1995.01		Saloon Engine L1E/L1K	•		GWB1432	
1993.08-1995.01		Saloon Engine L1E/L1K		o	GWB1333	
1.8 16V XR3i (96 kW)	1992.09-1995.01	Hatchback Engine RQB	•		GHA425004	K
1.8 D (44 kW)	1992.09-1995.01	Estate Engine RTH	•		GHA425004	K
	1992.09-1995.01	Estate Engine RTH	•		GWB1432	
	1992.09-1995.01	Estate Engine RTH		o	GWB1333	
	1992.09-1995.01	Estate Engine RTH		o	GWB1433	
	1992.09-1995.01	Hatchback Engine RTE/RTF/RTH	•		GHA425004	K
	1992.09-1995.01	Hatchback Engine RTE/RTF/RTH	•		GWB1432	
	1992.09-1995.01	Hatchback Engine RTE/RTF/RTH		o	GWB1333	
	1993.08-1995.01	Saloon Engine RTE/RTF/RTH	•		GHA425004	K
	1993.08-1995.01	Saloon Engine RTE/RTF/RTH	•		GWB1432	
	1993.08-1995.01	Saloon Engine RTE/RTF/RTH		o	GWB1333	
1.8 i 16V (77 kW)	1992.09-1995.01	Hatchback Engine RDA	•		GHA425004	K
	1992.09-1995.01	Hatchback Engine RDA	•		GWB1432	
	1992.09-1995.01	Hatchback Engine RDA		o	GWB1333	
	1993.01-1995.01	Estate Engine RDA	•		GHA425004	K
	1993.01-1995.01	Estate Engine RDA	•		GWB1432	



	 YEAR		F	R	G-AP Ref.	KIT
FORD						
ESCORT VI (GAL)						
1.8 i 16V (77 kW)	1993.01-1995.01	Estate Engine RDA		o	GWB1333	
	1993.01-1995.01	Estate Engine RDA		o	GWB1433	
	1993.08-1995.01	Saloon Engine RDA	•		GHA425004	K
	1993.08-1995.01	Saloon Engine RDA	•		GWB1432	
	1993.08-1995.01	Saloon Engine RDA		o	GWB1333	
1.8 i 16V (96 kW)	1993.02-1995.01	Estate Engine RQB	•		GHA425004	K
	1993.02-1995.01	Estate Engine RQB	•		GWB1432	
	1993.02-1995.01	Estate Engine RQB		o	GWB1333	
	1993.02-1995.01	Estate Engine RQB		o	GWB1433	
1.8 TD (66 kW)	1993.02-1995.01	Estate Engine RFD/RFK	•		GHA425004	K
	1993.02-1995.01	Estate Engine RFD/RFK	•		GWB1432	
	1993.02-1995.01	Estate Engine RFD/RFK		o	GWB1333	
	1993.02-1995.01	Estate Engine RFD/RFK		o	GWB1433	
	1993.02-1995.01	Hatchback Engine RFD/RFK/RFS	•		GHA425004	K
	1993.02-1995.01	Hatchback Engine RFD/RFK/RFS	•		GWB1432	
	1993.02-1995.01	Hatchback Engine RFD/RFK/RFS		o	GWB1333	
	1993.08-1995.01	Saloon Engine RFD/RFK	•		GHA425004	K
	1993.08-1995.01	Saloon Engine RFD/RFK	•		GWB1432	
	1993.08-1995.01	Saloon Engine RFD/RFK		o	GWB1333	
1.8 XR3i 16V 4x4 (77 kW)	1993.08-1995.01	Hatchback Engine RDA	•		GWB1431	
1.8 XR3i 16V 4x4 (96 kW)	1993.08-1995.01	Hatchback Engine RQB	•		GWB1431	
2.0 RS (110 kW)	1992.09-1995.01	Hatchback Engine N7A	•		GHA425004	K
	1992.09-1995.01	Hatchback Engine N7A	•		GWB1432	
	1992.09-1995.01	Hatchback Engine N7A		o	GWB1333	
2.0 RS 4x4 (110 kW)	1993.08-1995.01	Hatchback Engine N7A	•		GWB1431	
2.0 RS Cosworth 4x4 (162 kW)	1992.09-1995.01	Hatchback Engine N5F		o	GWB0918	
	1992.09-1995.01	Hatchback Engine N5F		o	GWB0919	
ESCORT VII (ALL)						
1.4 (55 kW)	1995.02-1998.08	Convertible Engine F4B	•		GHA425004	K
	1995.02-1998.08	Convertible Engine F4B	•		GWB1432	
	1995.02-1998.08	Convertible Engine F4B		o	GWB3666	
1.6 16V XR3i (65 kW)	1995.02-1996.12	Convertible Engine L1H	•		GHA425004	K
	1995.02-1996.12	Convertible Engine L1H	•		GWB1432	
	1995.02-1996.12	Convertible Engine L1H		o	GWB3666	
1.6 16V XR3i (66 kW)	1995.02-1999.09	Convertible Engine L1E	•		GHA425004	K
	1995.02-1999.09	Convertible Engine L1E	•		GWB1432	
	1995.02-1999.09	Convertible Engine L1E		o	GWB3666	
1.8 16V XR3i (77 kW)	1995.02-1998.08	Convertible Engine RDA	•		GHA425004	K
	1995.02-1998.08	Convertible Engine RDA	•		GWB1432	
	1995.02-1998.08	Convertible Engine RDA		o	GWB3666	
1.8 16V XR3i (85 kW)	1995.10-1998.08	Convertible Engine RKC	•		GHA425004	K
	1995.10-1998.08	Convertible Engine RKC	•		GWB1432	
	1995.10-1998.08	Convertible Engine RKC		o	GWB3666	
1.8 16V XR3i (96 kW)	1995.02-2000.08	Convertible Engine RQB	•		GHA425004	K
	1995.02-2000.08	Convertible Engine RQB	•		GWB1432	
	1995.02-2000.08	Convertible Engine RQB		o	GWB3666	
1.8 TD (66 kW)	1995.09-1998.08	Convertible Engine RFD/RFK	•		GHA425004	K
	1995.09-1998.08	Convertible Engine RFD/RFK	•		GWB1432	
	1995.09-1998.08	Convertible Engine RFD/RFK		o	GWB3666	
1.8 Turbo D (51 kW)	1996.10-1999.08	Convertible Engine RVA	•		GHA425004	K
	1996.10-1999.08	Convertible Engine RVA	•		GWB1432	
	1996.10-1999.08	Convertible Engine RVA		o	GWB3666	
ESCORT VII (GAL, AAL, ABL)						
1.3 (44 kW)	1995.01-1998.10	Hatchback Engine J4B/J6A	•		GHA425004	K
	1995.01-1998.10	Hatchback Engine J4B/J6A	•		GWB1432	
	1995.01-1998.10	Hatchback Engine J4B/J6A		o	GWB3666	
1.4 (55 kW)	1995.01-1998.10	Hatchback Engine F4B	•		GHA425004	K
	1995.01-1998.10	Hatchback Engine F4B	•		GWB1432	
	1995.01-1998.10	Hatchback Engine F4B		o	GWB3666	
1.6 16V (66 kW)	1995.01-1998.10	Hatchback Engine L1E	•		GHA425004	K
	1995.01-1998.10	Hatchback Engine L1E	•		GWB1432	
	1995.01-1998.10	Hatchback Engine L1E		o	GWB3666	
1.6 16V 4x4 (66 kW)	1995.01-1998.10	Hatchback Engine L1E	•		GHA423002	
	1995.01-1998.10	Hatchback Engine L1E	•		GWB1432	



	 YEAR		F	R	G-AP Ref.	KIT
FORD						
ESCORT VII (GAL, AAL, ABL)						
1.6 16V 4x4 (66 kW)	1995.01-1998.10	Hatchback Engine L1E		o	GWB1431	
1.6 i 16V (65 kW)	1995.01-1995.08	Hatchback Engine L1H	•		GHA425004	K
	1995.01-1995.08	Hatchback Engine L1H	•		GWB1432	
	1995.01-1995.08	Hatchback Engine L1H		o	GWB3666	
1.8 16V (77 kW)	1995.01-1995.08	Hatchback Engine RDA	•		GHA425004	K
	1995.01-1995.08	Hatchback Engine RDA	•		GWB1432	
	1995.01-1995.08	Hatchback Engine RDA		o	GWB3666	
1.8 16V (85 kW)	1995.01-1998.10	Hatchback Engine RKC	•		GHA425004	K
	1995.01-1998.10	Hatchback Engine RKC	•		GWB1432	
	1995.01-1998.10	Hatchback Engine RKC		o	GWB3666	
1.8 D (44 kW)	1995.01-1996.12	Hatchback Engine RTE/RTF/RTH	•		GHA425004	K
	1995.01-1996.12	Hatchback Engine RTE/RTF/RTH	•		GWB1432	
	1995.01-1996.12	Hatchback Engine RTE/RTF/RTH		o	GWB3666	
1.8 TD (66 kW)	1995.01-1998.10	Hatchback Engine RFD/RFK	•		GHA425004	K
	1995.01-1998.10	Hatchback Engine RFD/RFK	•		GWB1432	
	1995.01-1998.10	Hatchback Engine RFD/RFK		o	GWB3666	
1.8 Turbo D (51 kW)	1995.12-1998.10	Hatchback Engine RVA	•		GHA425004	K
	1995.12-1998.10	Hatchback Engine RVA	•		GWB1432	
	1995.12-1998.10	Hatchback Engine RVA		o	GWB3666	
2.0 RS (110 kW)	1995.02-1998.02	Hatchback Engine N7A	•		GHA425004	K
	1995.02-1998.02	Hatchback Engine N7A	•		GWB1432	
	1995.02-1998.02	Hatchback Engine N7A		o	GWB3666	
2.0 RS 4x4 (110 kW)	1995.02-1998.10	Hatchback Engine N7A	•		GWB1432	
	1995.02-1998.10	Hatchback Engine N7A		o	GHA423002	
	1995.02-1998.10	Hatchback Engine N7A		o	GWB1431	
2.0 RS Cosworth 4x4 (162 kW)	1995.02-1998.10	Hatchback Engine N5F	•		GHA425004	K
	1995.02-1998.10	Hatchback Engine N5F		o	GWB0918	
	1995.02-1998.10	Hatchback Engine N5F		o	GWB0919	
ESCORT VII (GAL, AFL)						
1.3 (44 kW)	1995.01-1999.01	Estate Engine J4B/J6A	•		GHA425004	K
	1995.01-1999.01	Estate Engine J4B/J6A	•		GWB1432	
	1995.01-1999.01	Estate Engine J4B/J6A		o	GWB1333	
	1995.01-1999.01	Estate Engine J4B/J6A		o	GWB1433	
	1995.01-1999.01	Estate Engine J4B/J6A		o	GWB3666	
	1995.01-1999.02	Saloon Engine J4B/J6A	•		GHA425004	K
	1995.01-1999.02	Saloon Engine J4B/J6A	•		GWB1432	
	1995.01-1999.02	Saloon Engine J4B/J6A		o	GWB3666	
	1.4 (55 kW)	1995.01-1999.02	Estate Engine F4B/FUH	•		GHA425004
1995.01-1999.02		Estate Engine F4B/FUH	•		GWB1432	
1995.01-1999.02		Estate Engine F4B/FUH		o	GWB1333	
1995.01-1999.02		Estate Engine F4B/FUH		o	GWB1433	
1995.01-1999.02		Estate Engine F4B/FUH		o	GWB3666	
1995.01-1999.02		Saloon Engine F4B/FUH	•		GHA425004	K
1995.01-1999.02		Saloon Engine F4B/FUH	•		GWB1432	
1995.01-1999.02		Saloon Engine F4B/FUH		o	GWB3666	
1.6 16V (66 kW)	1995.01-1999.02	Estate Engine L1E	•		GHA425004	K
	1995.01-1999.02	Estate Engine L1E	•		GWB1432	
	1995.01-1999.02	Estate Engine L1E		o	GWB1333	
	1995.01-1999.02	Estate Engine L1E		o	GWB1433	
	1995.01-1999.02	Estate Engine L1E		o	GWB3666	
1.6 i 16V (65 kW)	1995.01-1995.08	Estate Engine L1H	•		GHA425004	K
	1995.01-1995.08	Estate Engine L1H	•		GWB1432	
	1995.01-1995.08	Estate Engine L1H		o	GWB1333	
	1995.01-1995.08	Estate Engine L1H		o	GWB1433	
	1995.01-1995.08	Estate Engine L1H		o	GWB3666	
	1995.01-1995.08	Saloon Engine L1H	•		GHA425004	K
	1995.01-1995.08	Saloon Engine L1H	•		GWB1432	
	1995.01-1995.08	Saloon Engine L1H		o	GWB3666	
1.6 i 16V (66 kW)	1995.01-1999.02	Saloon Engine L1E/L1K	•		GHA425004	K
	1995.01-1999.02	Saloon Engine L1E/L1K	•		GWB1432	
	1995.01-1999.02	Saloon Engine L1E/L1K		o	GWB3666	
1.8 16V (77 kW)	1995.01-1995.08	Estate Engine RDA	•		GHA425004	K
	1995.01-1995.08	Estate Engine RDA	•		GWB1432	
	1995.01-1995.08	Estate Engine RDA		o	GWB1333	



	 YEAR		F	R	G-AP Ref.	KIT
FORD						
ESCORT VII (GAL, AFL)						
1.8 16V (77 kW)	1995.01-1995.08	Estate Engine RDA		o	GWB1433	
	1995.01-1995.08	Estate Engine RDA		o	GWB3666	
	1995.01-1995.08	Saloon Engine RDA	•		GHA425004	K
	1995.01-1995.08	Saloon Engine RDA	•		GWB1432	
	1995.01-1995.08	Saloon Engine RDA		o	GWB3666	
1.8 16V (85 kW)	1995.01-1999.02	Estate Engine RKC	•		GHA425004	K
	1995.01-1999.02	Estate Engine RKC	•		GWB1432	
	1995.01-1999.02	Estate Engine RKC		o	GWB1333	
	1995.01-1999.02	Estate Engine RKC		o	GWB1433	
	1995.01-1999.02	Estate Engine RKC		o	GWB3666	
	1995.01-1999.02	Saloon Engine RKC	•		GHA425004	K
	1995.01-1999.02	Saloon Engine RKC	•		GWB1432	
	1995.01-1999.02	Saloon Engine RKC		o	GWB3666	
1.8 D (44 kW)	1995.01-1996.12	Saloon Engine RTE/RTF/RTH	•		GHA425004	K
	1995.01-1996.12	Saloon Engine RTE/RTF/RTH	•		GWB1432	
	1995.01-1996.12	Saloon Engine RTE/RTF/RTH		o	GWB3666	
	1995.01-1999.02	Estate Engine RTE/RTF/RTH	•		GHA425004	K
	1995.01-1999.02	Estate Engine RTE/RTF/RTH	•		GWB1432	
	1995.01-1999.02	Estate Engine RTE/RTF/RTH		o	GWB1333	
	1995.01-1999.02	Estate Engine RTE/RTF/RTH		o	GWB1433	
	1995.01-1999.02	Estate Engine RTE/RTF/RTH		o	GWB3666	
1.8 TD (66 kW)	1995.01-1999.02	Estate Engine RFD/RFK	•		GHA425004	K
	1995.01-1999.02	Estate Engine RFD/RFK	•		GWB1432	
	1995.01-1999.02	Estate Engine RFD/RFK		o	GWB1333	
	1995.01-1999.02	Estate Engine RFD/RFK		o	GWB1433	
	1995.01-1999.02	Estate Engine RFD/RFK		o	GWB3666	
	1995.01-1999.02	Saloon Engine RFD/RFK	•		GHA425004	K
	1995.01-1999.02	Saloon Engine RFD/RFK	•		GWB1432	
	1995.01-1999.02	Saloon Engine RFD/RFK		o	GWB3666	
1.8 Turbo D (51 kW)	1995.12-1999.02	Estate Engine RVA	•		GHA425004	K
	1995.12-1999.02	Estate Engine RVA	•		GWB1432	
	1995.12-1999.02	Estate Engine RVA		o	GWB1433	
	1995.12-1999.02	Estate Engine RVA		o	GWB3666	
	1995.12-1999.02	Saloon Engine RVA	•		GHA425004	K
	1995.12-1999.02	Saloon Engine RVA	•		GWB1432	
	1995.12-1999.02	Saloon Engine RVA		o	GWB3666	
EXCURSION						
-	2003-2005		•		GHA355005	K
EXPEDITION						
-	2003-2006			o	GHA333091	
EXPLORER						
-	2002-2010			o	GHA429001	K
	2006-2010		•		GHA327037	
EXPLORER SPORT TRAC						
-	2007-2010		•		GHA327037	
	2007-2010			o	GHA429001	K
F-150						
-	1997-2000		•		GHA333012	
	1997-2000		•		GHA333050	
	2000-		•		GHA333059	
	2000-		•		GHA333061	
	2000-2003		•		GHA333018	
	2005-2008		•		GHA400173	
	2005-2008		•		GHA400218	
	2008-		•		GHA400173	
	2008-		•		GHA400218	
F-150 HERITAGE						
-	2004-		•		GHA333018	
F-250						
-	1997-1999		•		GHA333018	
	1997-1999		•		GHA333059	
F-250 SUPER DUTY						
-	2003-2004		•		GHA355005	K



	 YEAR		F	R	G-AP Ref.	KIT
FORD						
F-250 SUPER DUTY						
-	2003-2004		•		GHA355005	K
FALCON (FG)						
-	2005.01-2008.05		•		GHA400159	
FALCON AU1, AU2,AU3, BA						
-					GHA237009	K
FIESTA						
1.25 (44 kW)	2012.10-	Saloon Engine STJB	•		GWB6653	
	2012.10-	Saloon Engine STJB		○	GHA400136	K
FIESTA III (GFJ)						
1.3 CAT (44 kW)	1991.05-1997.01	Hatchback Engine J6B	•		GHA423002	
	1991.05-1997.01	Hatchback Engine J6B	•		GHA425004	K
	1991.05-1997.01	Hatchback Engine J6B	•		GWB1431	
	1991.05-1997.01	Hatchback Engine J6B	•		GWB1432	
	1991.05-1997.01	Hatchback Engine J6B		○	GWB1333	
1.4 (55 kW)	1992.11-1996.12	Hatchback Engine FUF	•		GHA423002	
	1992.11-1996.12	Hatchback Engine FUF	•		GHA425004	K
1.6 i 16V (65 kW)	1994.01-1995.12	Hatchback Engine L1G	•		GHA423002	
	1994.01-1995.12	Hatchback Engine L1G	•		GHA425004	K
	1994.01-1995.12	Hatchback Engine L1G	•		GWB1432	
	1994.01-1995.12	Hatchback Engine L1G		○	GWB1333	
1.6 Turbo (96 kW)	1990.03-1992.10	Hatchback Engine LHA	•		GHA423002	
	1990.03-1992.10	Hatchback Engine LHA	•		GWB1431	
	1990.03-1992.10	Hatchback Engine LHA		○	GWB1333	
1.8 16V (77 kW)	1992.02-1995.12	Hatchback Engine RDB	•		GHA423002	
	1992.02-1995.12	Hatchback Engine RDB	•		GHA425004	K
	1992.02-1995.12	Hatchback Engine RDB	•		GWB1431	
	1992.02-1995.12	Hatchback Engine RDB	•		GWB1432	
	1992.02-1995.12	Hatchback Engine RDB		○	GWB1333	
1.8 TD (57 kW)	1993.03-1995.12	Hatchback Engine RFL	•		GWB1431	
	1993.03-1995.12	Hatchback Engine RFL	•		GWB1432	
	1993.03-1995.12	Hatchback Engine RFL		○	GWB1333	
1.8 XR2i 16V (96 kW)	1992.02-1995.12	Hatchback Engine RQC	•		GHA423002	
	1992.02-1995.12	Hatchback Engine RQC	•		GHA425004	K
	1992.02-1995.12	Hatchback Engine RQC	•		GWB1431	
	1992.02-1995.12	Hatchback Engine RQC	•		GWB1432	
	1992.02-1995.12	Hatchback Engine RQC		○	GWB1333	
FIESTA IV (JA_, JB_)						
1.0 i (38 kW)	1997.02-1999.09	Hatchback	•		GHA425004	K
	1997.02-1999.09	Hatchback	•		GWB1432	
	1997.02-1999.09	Hatchback		○	GWB3666	
1.0 i (48 kW)	1999.09-2002.01	Hatchback	•		GHA425004	K
	1999.09-2002.01	Hatchback	•		GWB1432	
	1999.09-2002.01	Hatchback		○	GWB3666	
1.1 (37 kW)	1995.09-1996.12	Hatchback	•		GHA425004	K
	1995.09-1996.12	Hatchback	•		GWB1432	
	1995.09-1996.12	Hatchback		○	GWB3666	
1.25 i 16V (55 kW)	1995.08-2002.01	Hatchback Engine DHA/DHB/DHC/DHD/DHE/DHF/DHG	•		GHA425004	K
	1995.08-2002.01	Hatchback Engine DHA/DHB/DHC/DHD/DHE/DHF/DHG	•		GWB1432	
	1995.08-2002.01	Hatchback Engine DHA/DHB/DHC/DHD/DHE/DHF/DHG		○	GWB3666	
1.3 i (37 kW)	1995.08-2002.01	Hatchback Engine JJA/JJC/JJE/JJJ/JJK/JJM	•		GHA425004	K
	1995.08-2002.01	Hatchback Engine JJA/JJC/JJE/JJJ/JJK/JJM	•		GWB1432	
	1995.08-2002.01	Hatchback Engine JJA/JJC/JJE/JJJ/JJK/JJM		○	GWB3666	
1.3 i (44 kW)	1995.08-2002.01	Hatchback Engine J4C/J4J/J4L/J4Q/J4R/J4T/JBC	•		GHA425004	K
	1995.08-2002.01	Hatchback Engine J4C/J4J/J4L/J4Q/J4R/J4T/JBC	•		GWB1432	
	1995.08-2002.01	Hatchback Engine J4C/J4J/J4L/J4Q/J4R/J4T/JBC		○	GWB3666	
1.4 i 16V (66 kW)	1996.04-2002.01	Hatchback Engine FHA/FHE	•		GHA425004	K
	1996.04-2002.01	Hatchback Engine FHA/FHE	•		GWB1432	
	1996.04-2002.01	Hatchback Engine FHA/FHE		○	GWB3666	
1.6 16V Sport (76 kW)	2000.02-2002.01	Hatchback Engine L1T/L1V	•		GHA425004	K
	2000.02-2002.01	Hatchback Engine L1T/L1V	•		GWB1432	
	2000.02-2002.01	Hatchback Engine L1T/L1V		○	GWB3666	
1.8 D (44 kW)	1995.08-2000.04	Hatchback Engine RTJ,RTK	•		GHA425004	K
	1995.08-2000.04	Hatchback Engine RTJ,RTK	•		GWB1432	



	 YEAR		F	R	G-AP Ref.	KIT
FORD						
FIESTA IV (JA_, JB_)						
1.8 D (44 kW)	1995.08-2000.04	Hatchback Engine RTJ,RTK		o	GWB3666	
1.8 Di (55 kW)	2000.04-2002.01	Hatchback Engine RTN/RTP/RTQ	•		GHA425004	K
	2000.04-2002.01	Hatchback Engine RTN/RTP/RTQ	•		GWB1432	
	2000.04-2002.01	Hatchback Engine RTN/RTP/RTQ		o	GWB3666	
FIESTA V (JH_, JD_)						
1.0 (49 kW)	2002.05-2008.03	Hatchback	•		GHA425004	K
	2002.05-2008.03	Hatchback	•		GWB3530	
	2002.05-2008.03	Hatchback	•		GWB3531	
	2002.05-2008.03	Hatchback		o	GWB3532	
	2002.05-2008.03	Hatchback		o	GWB6515	
1.25 16V (51 kW)	2003.02-2005.09	Hatchback Engine M7JA/M7JB	•		GHA425004	K
	2003.02-2005.09	Hatchback Engine M7JA/M7JB	•		GWB3530	
	2003.02-2005.09	Hatchback Engine M7JA/M7JB	•		GWB3531	
	2003.02-2005.09	Hatchback Engine M7JA/M7JB		o	GWB3532	
	2003.02-2005.09	Hatchback Engine M7JA/M7JB		o	GWB6515	
1.25 16V (55 kW)	2002.05-2008.03	Hatchback Engine FUJA/FUJB	•		GHA425004	K
	2002.05-2008.03	Hatchback Engine FUJA/FUJB	•		GWB3530	
	2002.05-2008.03	Hatchback Engine FUJA/FUJB	•		GWB3531	
	2002.05-2008.03	Hatchback Engine FUJA/FUJB		o	GWB3532	
	2002.05-2008.03	Hatchback Engine FUJA/FUJB		o	GWB6515	
1.3 (44 kW)	2001.11-2008.06	Hatchback Engine BAJA	•		GHA425004	K
	2001.11-2008.06	Hatchback Engine BAJA	•		GWB3530	
	2001.11-2008.06	Hatchback Engine BAJA	•		GWB3531	
	2001.11-2008.06	Hatchback Engine BAJA		o	GWB3532	
	2001.11-2008.06	Hatchback Engine BAJA		o	GWB6515	
1.3 (51 kW)	2001.11-2008.06	Hatchback Engine A9JA/A9JB	•		GHA425004	K
	2001.11-2008.06	Hatchback Engine A9JA/A9JB	•		GWB3530	
	2001.11-2008.06	Hatchback Engine A9JA/A9JB	•		GWB3531	
	2001.11-2008.06	Hatchback Engine A9JA/A9JB		o	GWB3532	
	2001.11-2008.06	Hatchback Engine A9JA/A9JB		o	GWB6515	
1.4 16V (59 kW)	2001.11-2008.06	Hatchback Engine FXJA/FXJB	•		GHA425004	K
	2001.11-2008.06	Hatchback Engine FXJA/FXJB	•		GWB3530	
	2001.11-2008.06	Hatchback Engine FXJA/FXJB	•		GWB3531	
	2001.11-2008.06	Hatchback Engine FXJA/FXJB		o	GWB3532	
	2001.11-2008.06	Hatchback Engine FXJA/FXJB		o	GWB6515	
1.4 TDCi (50 kW)	2001.11-2008.06	Hatchback Engine F6JA/F6JB	•		GHA425004	K
	2001.11-2008.06	Hatchback Engine F6JA/F6JB	•		GWB3530	
	2001.11-2008.06	Hatchback Engine F6JA/F6JB	•		GWB3531	
	2001.11-2008.06	Hatchback Engine F6JA/F6JB		o	GWB3532	
	2001.11-2008.06	Hatchback Engine F6JA/F6JB		o	GWB6515	
1.6 16V (74 kW)	2001.11-2008.06	Hatchback Engine FYJA/FYJB	•		GHA425004	K
	2001.11-2008.06	Hatchback Engine FYJA/FYJB	•		GWB3530	
	2001.11-2008.06	Hatchback Engine FYJA/FYJB	•		GWB3531	
	2001.11-2008.06	Hatchback Engine FYJA/FYJB		o	GWB3532	
	2001.11-2008.06	Hatchback Engine FYJA/FYJB		o	GWB6515	
1.6 TDCi (66 kW)	2004.11-2007.03	Hatchback Engine HHJA/HHJB	•		GHA425004	K
	2004.11-2007.03	Hatchback Engine HHJA/HHJB	•		GWB3530	
	2004.11-2007.03	Hatchback Engine HHJA/HHJB	•		GWB3531	
	2004.11-2007.03	Hatchback Engine HHJA/HHJB		o	GWB3532	
	2004.11-2007.03	Hatchback Engine HHJA/HHJB		o	GWB6515	
2.0 ST150 (110 kW)	2004.11-2007.03	Hatchback Engine N4JB	•		GHA425004	K
	2004.11-2007.03	Hatchback Engine N4JB	•		GWB3530	
	2004.11-2007.03	Hatchback Engine N4JB	•		GWB3531	
	2004.11-2007.03	Hatchback Engine N4JB		o	GWB3532	
	2004.11-2007.03	Hatchback Engine N4JB		o	GWB6515	
FIESTA V VAN						
1.6 TDCi (66 kW)	2007.04-2009.09	Box Engine HHJA/HHJB	•		GHA425004	K
FIESTA VAN						
1.25 (60 kW)	2009.01-	Box Engine SNJA/SNJB	•		GWB6653	
	2009.01-	Box Engine SNJA/SNJB		o	GHA400136	K
1.3 (51 kW)	2003.10-	Box Engine A9JA/A9JB	•		GHA425004	K
	2003.10-	Box Engine A9JA/A9JB	•		GWB3530	
	2003.10-	Box Engine A9JA/A9JB	•		GWB3531	
	2003.10-	Box Engine A9JA/A9JB		o	GWB3532	



	 YEAR		F	R	G-AP Ref.	KIT
FORD						
FIESTA VAN						
1.3 (51 kW)	2003.10-	Box Engine A9JA/A9JB		o	GWB6515	
1.4 TDCi (50 kW)	2003.10-	Box Engine F6JA/F6JB	•		GHA425004	K
	2003.10-	Box Engine F6JA/F6JB	•		GWB3530	
	2003.10-	Box Engine F6JA/F6JB	•		GWB3531	
	2003.10-	Box Engine F6JA/F6JB		o	GWB3532	
	2003.10-	Box Engine F6JA/F6JB		o	GWB6515	
	2009.01-	Box Engine F6JB	•		GWB6653	
	2009.01-	Box Engine F6JB		o	GHA400136	K
1.4 TDCi (51 kW)	2010.07-	Box Engine F6JD/KVJA	•		GWB6653	
	2010.07-	Box Engine F6JD/KVJA		o	GHA400136	K
1.6 TDCi (66 kW)	2009.01-	Box Engine HHJC/HHJD/HHJE	•		GWB6653	
	2009.01-	Box Engine HHJC/HHJD/HHJE		o	GHA400136	K
1.6 TDCi (70 kW)	2010.02-	Box Engine TZJA/TZJB	•		GWB6653	
	2010.02-	Box Engine TZJA/TZJB		o	GHA400136	K
FIESTA VI						
1.0 (48 kW)	2013.01-	Hatchback Engine XMJA/XMJB	•		GWB6653	
	2013.01-	Hatchback Engine XMJA/XMJB		o	GHA400136	K
1.0 (59 kW)	2012.10-	Hatchback Engine P4JA/P4JB	•		GWB6653	
	2012.10-	Hatchback Engine P4JA/P4JB		o	GHA400136	K
1.0 EcoBoost (74 kW)	2013.01-	Hatchback Engine SFJA/SFJB	•		GWB6653	
	2013.01-	Hatchback Engine SFJA/SFJB		o	GHA400136	K
1.0 EcoBoost (92 kW)	2012.09-	Hatchback Engine M1JE	•		GWB6653	
	2012.09-	Hatchback Engine M1JE		o	GHA400136	K
1.0 Sport (103 kW)	2014.05-	Hatchback Engine YYJA/YYJB	•		GWB6653	
	2014.05-	Hatchback Engine YYJA/YYJB		o	GHA400136	K
1.25 (44 kW)	2008.06-	Hatchback Engine STJA/STJB	•		GWB6653	
	2008.06-	Hatchback Engine STJA/STJB		o	GHA400136	K
1.25 (60 kW)	2008.06-	Hatchback Engine SNJA/SNJB	•		GWB6653	
	2008.06-	Hatchback Engine SNJA/SNJB		o	GHA400136	K
	2008.06-	Hatchback Engine SNJA/SNJB		o	GHA400136	K
1.4 (71 kW)	2008.06-	Hatchback Engine SPJA/SPJC	•		GWB6653	
	2008.06-	Hatchback Engine SPJA/SPJC		o	GHA400136	K
1.4 LPG (68 kW)	2009.01-	Hatchback Engine RTJA/RTJB	•		GWB6653	
	2009.01-	Hatchback Engine RTJA/RTJB		o	GHA400136	K
1.4 LPG (71 kW)	2009.01-	Hatchback Engine RTJA/RTJB	•		GWB6653	
	2009.01-	Hatchback Engine RTJA/RTJB		o	GHA400136	K
	2009.01-	Hatchback Engine RTJA/RTJB		o	GHA400136	K
1.4 TDCi (50 kW)	2009.01-	Hatchback Engine F6JB	•		GWB6653	
	2009.01-	Hatchback Engine F6JB		o	GHA400136	K
1.4 TDCi (51 kW)	2010.07-	Hatchback Engine F6JD/KVJA	•		GWB6653	
	2010.07-	Hatchback Engine F6JD/KVJA		o	GHA400136	K
1.5 TDCi (55 kW)	2012.09-	Hatchback Engine UGJC	•		GWB6653	
	2012.09-	Hatchback Engine UGJC		o	GHA400136	K
1.5 TDCi (70 kW)	2015.05-	Hatchback Engine XVJB/XVJC	•		GWB6653	
	2015.05-	Hatchback Engine XVJB/XVJC		o	GHA400136	K
1.6 (70 kW)	2008.06-	Hatchback	•		GWB6653	
	2008.06-	Hatchback		o	GHA400136	K
1.6 ST (134 kW)	2013.03-	Hatchback Engine JTJA	•		GWB6653	
	2013.03-	Hatchback Engine JTJA		o	GHA400136	K
1.6 TDCi (55 kW)	2008.06-	Hatchback Engine HHJF/UBJA	•		GWB6653	
	2008.06-	Hatchback Engine HHJF/UBJA		o	GHA400136	K
1.6 TDCi (66 kW)	2008.06-	Hatchback Engine HHJC/HHJD/HHJE	•		GWB6653	
	2008.06-	Hatchback Engine HHJC/HHJD/HHJE		o	GHA400136	K
1.6 TDCi (70 kW)	2010.02-	Hatchback Engine TZJA/TZJB/T3JA	•		GWB6653	
	2010.02-	Hatchback Engine TZJA/TZJB/T3JA		o	GHA400136	K
1.6 TI (77 kW)	2012.09-	Hatchback Engine IQJA	•		GWB6653	
	2012.09-	Hatchback Engine IQJA		o	GHA400136	K
1.6 TI (88 kW)	2008.06-	Hatchback Engine HXJA/HXJB	•		GWB6653	
	2008.06-	Hatchback Engine HXJA/HXJB		o	GHA400136	K
1.6 TI (99 kW)	2010.12-	Hatchback Engine U5JA	•		GWB6653	
	2010.12-	Hatchback Engine U5JA		o	GHA400136	K
FIESTA VI VAN						
1.0 EcoBoost (103 kW)	2014.05-	Box Engine YYJA/YYJB	•		GWB6653	
	2014.05-	Box Engine YYJA/YYJB		o	GHA400136	K
1.0 EcoBoost (48 kW)	2013.01-	Box Engine XMJA/XMJB	•		GWB6653	
	2013.01-	Box Engine XMJA/XMJB		o	GHA400136	K



	 YEAR		F	R	G-AP Ref.	KIT
FORD						
FIESTA VI VAN						
1.0 EcoBoost (74 kW)	2013.01- 2013.01-	Box Engine SFJA/SFJB/SFJC	•		GWB6653	
		Box Engine SFJA/SFJB/SFJC		○	GHA400136	K
1.0 EcoBoost (92 kW)	2012.09- 2012.09-	Box Engine M1JE	•		GWB6653	
		Box Engine M1JE		○	GHA400136	K
1.5 TDCi (55 kW)	2012.10- 2012.10-	Box Engine UGJC	•		GWB6653	
		Box Engine UGJC		○	GHA400136	K
1.5 TDCi (70 kW)	2015.05- 2015.05-	Box Engine XVJB/XVJC	•		GWB6653	
		Box Engine XVJB/XVJC		○	GHA400136	K
1.6 ST (134 kW)	2013.03- 2013.03-	Box Engine JTJA	•		GWB6653	
		Box Engine JTJA		○	GHA400136	K
FOCUS (DAW, DBW)						
1.4 16V (55 kW)	1998.10-2004.11 1998.10-2004.11 1998.10-2004.11 1998.10-2004.11 1998.10-2004.11 1998.10-2004.11	Hatchback Engine FXDA/FXDB/FXDC/FXDD Hatchback Engine FXDA/FXDB/FXDC/FXDD Hatchback Engine FXDA/FXDB/FXDC/FXDD Hatchback Engine FXDA/FXDB/FXDC/FXDD Hatchback Engine FXDA/FXDB/FXDC/FXDD Hatchback Engine FXDA/FXDB/FXDC/FXDD With ABS	• • • • • •	 ○	GHA425004 GWB3530 GWB3531 GWB3532 GWB6515 GHA229001	 K
1.6 16V (74 kW)	1998.10-2004.11 1998.10-2004.11 1998.10-2004.11 1998.10-2004.11 1998.10-2004.11 1998.10-2004.11	Hatchback Engine FYDA/FYDB/FYDC/FYDD/FYDH Hatchback Engine FYDA/FYDB/FYDC/FYDD/FYDH Hatchback Engine FYDA/FYDB/FYDC/FYDD/FYDH Hatchback Engine FYDA/FYDB/FYDC/FYDD/FYDH Hatchback Engine FYDA/FYDB/FYDC/FYDD/FYDH Hatchback Engine FYDA/FYDB/FYDC/FYDD/FYDH With ABS	• • • • • •	 ○	GHA425004 GWB3530 GWB3531 GWB3532 GWB6515 GHA229001	 K
1.6 16V Flexifuel (75 kW)	2002.01-2004.11 2002.01-2004.11 2002.01-2004.11 2002.01-2004.11 2002.01-2004.11	Hatchback Engine FYDA/FYDH Hatchback Engine FYDA/FYDH Hatchback Engine FYDA/FYDH Hatchback Engine FYDA/FYDH Hatchback Engine FYDA/FYDH	• • • • •	 ○	GHA425004 GWB3530 GWB3531 GWB3532 GWB6515	 K
1.8 16V (85 kW)	1998.10-2004.11 1998.10-2004.11 1998.10-2004.11 1998.10-2004.11 1998.10-2004.11 1998.10-2004.11	Hatchback Engine EYDB/EYDC/EYDD/EYDE/EYDF/EYDG/EYDI/EYDJ/EYDL Hatchback Engine EYDB/EYDC/EYDD/EYDE/EYDF/EYDG/EYDI/EYDJ/EYDL Hatchback Engine EYDB/EYDC/EYDD/EYDE/EYDF/EYDG/EYDI/EYDJ/EYDL Hatchback Engine EYDB/EYDC/EYDD/EYDE/EYDF/EYDG/EYDI/EYDJ/EYDL Hatchback Engine EYDB/EYDC/EYDD/EYDE/EYDF/EYDG/EYDI/EYDJ/EYDL Hatchback Engine EYDB/EYDC/EYDD/EYDE/EYDF/EYDG/EYDI/EYDJ/EYDL With ABS	• • • • • •	 ○	GHA425004 GWB3530 GWB3531 GWB3532 GWB6515 GHA229001	 K
1.8 Di/TDDi (55 kW)	1999.08-2004.11 1999.08-2004.11 1999.08-2004.11 1999.08-2004.11 1999.08-2004.11 1999.08-2004.11	Hatchback Engine BHDA/BHDB Hatchback Engine BHDA/BHDB Hatchback Engine BHDA/BHDB Hatchback Engine BHDA/BHDB Hatchback Engine BHDA/BHDB Hatchback Engine BHDA/BHDB With ABS	• • • • • •	 ○	GHA425004 GWB3530 GWB3531 GWB3532 GWB6515 GHA229001	 K
1.8 TDCi (74 kW)	2002.08-2004.11 2002.08-2004.11 2002.08-2004.11 2002.08-2004.11 2002.08-2004.11 2002.08-2004.11	Hatchback Engine FFDA Hatchback Engine FFDA Hatchback Engine FFDA Hatchback Engine FFDA Hatchback Engine FFDA Hatchback Engine FFDA With ABS	• • • • • •	 ○	GHA425004 GWB3530 GWB3531 GWB3532 GWB6515 GHA229001	 K
1.8 TDCi (85 kW)	2001.03-2004.11 2001.03-2004.11 2001.03-2004.11 2001.03-2004.11 2001.03-2004.11 2001.03-2004.11	Hatchback Engine F9DA/F9DB Hatchback Engine F9DA/F9DB Hatchback Engine F9DA/F9DB Hatchback Engine F9DA/F9DB Hatchback Engine F9DA/F9DB Hatchback Engine F9DA/F9DB With ABS	• • • • • •	 ○	GHA425004 GWB3530 GWB3531 GWB3532 GWB6515 GHA229001	 K
1.8 Turbo Di/TDDi (66 kW)	1998.10-2004.11 1998.10-2004.11 1998.10-2004.11 1998.10-2004.11 1998.10-2004.11 1998.10-2004.11	Hatchback Engine C9DA/C9DB/C9DC Hatchback Engine C9DA/C9DB/C9DC Hatchback Engine C9DA/C9DB/C9DC Hatchback Engine C9DA/C9DB/C9DC Hatchback Engine C9DA/C9DB/C9DC Hatchback Engine C9DA/C9DB/C9DC With ABS	• • • • • •	 ○	GHA425004 GWB3530 GWB3531 GWB3532 GWB6515 GHA229001	 K
2.0 16V (96 kW)	1998.10-2004.11 1998.10-2004.11 1998.10-2004.11 1998.10-2004.11 1998.10-2004.11	Hatchback Engine EDDB/EDDC/EDDD/EDDF Hatchback Engine EDDB/EDDC/EDDD/EDDF Hatchback Engine EDDB/EDDC/EDDD/EDDF Hatchback Engine EDDB/EDDC/EDDD/EDDF Hatchback Engine EDDB/EDDC/EDDD/EDDF With ABS	• • • • •	 ○	GWB3530 GWB3531 GWB3532 GWB6515 GHA229001	 K
2.0 RS (158 kW)	2002.10-2004.11	Hatchback Engine HMDA With ABS		○	GHA229001	



	 YEAR		F	R	G-AP Ref.	KIT
FORD						
FOCUS (DAW, DBW)						
2.0 ST170 (127 kW)	2002.03-2004.11	Hatchback Engine ALDA	•		GWB3530	
	2002.03-2004.11	Hatchback Engine ALDA	•		GWB3531	
	2002.03-2004.11	Hatchback Engine ALDA		o	GWB3532	
	2002.03-2004.11	Hatchback Engine ALDA		o	GWB6515	
	2002.03-2004.11	Hatchback Engine ALDA With ABS		o	GHA229001	
FOCUS (DFW)						
1.4 16V (55 kW)	1999.02-2004.11	Saloon Engine FXDA/FXDB/FXDC/FXDD	•		GHA425004	K
	1999.02-2004.11	Saloon Engine FXDA/FXDB/FXDC/FXDD	•		GWB3530	
	1999.02-2004.11	Saloon Engine FXDA/FXDB/FXDC/FXDD	•		GWB3531	
	1999.02-2004.11	Saloon Engine FXDA/FXDB/FXDC/FXDD		o	GWB3532	
	1999.02-2004.11	Saloon Engine FXDA/FXDB/FXDC/FXDD		o	GWB6515	
	1999.02-2004.11	Saloon Engine FXDA/FXDB/FXDC/FXDD With ABS		o	GHA229001	
1.6 16V (74 kW)	1999.02-2004.11	Saloon Engine FYDA/FYDB/FYDC/FYDD/FYDH	•		GHA425004	K
	1999.02-2004.11	Saloon Engine FYDA/FYDB/FYDC/FYDD/FYDH	•		GWB3530	
	1999.02-2004.11	Saloon Engine FYDA/FYDB/FYDC/FYDD/FYDH	•		GWB3531	
	1999.02-2004.11	Saloon Engine FYDA/FYDB/FYDC/FYDD/FYDH		o	GWB3532	
	1999.02-2004.11	Saloon Engine FYDA/FYDB/FYDC/FYDD/FYDH		o	GWB6515	
1.8 16V (85 kW)	1999.02-2004.11	Saloon Engine EYDB/EYDC/EYDD/EYDE/EYDF/EYDG/EYDI/EYDJ/EYDL	•		GHA425004	K
	1999.02-2004.11	Saloon Engine EYDB/EYDC/EYDD/EYDE/EYDF/EYDG/EYDI/EYDJ/EYDL	•		GWB3530	
	1999.02-2004.11	Saloon Engine EYDB/EYDC/EYDD/EYDE/EYDF/EYDG/EYDI/EYDJ/EYDL	•		GWB3531	
	1999.02-2004.11	Saloon Engine EYDB/EYDC/EYDD/EYDE/EYDF/EYDG/EYDI/EYDJ/EYDL		o	GWB3532	
	1999.02-2004.11	Saloon Engine EYDB/EYDC/EYDD/EYDE/EYDF/EYDG/EYDI/EYDJ/EYDL		o	GWB6515	
	1999.02-2004.11	Saloon Engine EYDB/EYDC/EYDD/EYDE/EYDF/EYDG/EYDI/EYDJ/EYDL With ABS		o	GHA229001	
1.8 TDCi (74 kW)	2002.08-2004.11	Saloon Engine FFDA	•		GHA425004	K
	2002.08-2004.11	Saloon Engine FFDA	•		GWB3530	
	2002.08-2004.11	Saloon Engine FFDA	•		GWB3531	
	2002.08-2004.11	Saloon Engine FFDA		o	GWB3532	
	2002.08-2004.11	Saloon Engine FFDA		o	GWB6515	
	2002.08-2004.11	Saloon Engine FFDA With ABS		o	GHA229001	
1.8 TDCi (85 kW)	2001.10-2005.04	Saloon Engine F9DA/F9DB	•		GHA425004	K
	2001.10-2005.04	Saloon Engine F9DA/F9DB	•		GWB3530	
	2001.10-2005.04	Saloon Engine F9DA/F9DB	•		GWB3531	
	2001.10-2005.04	Saloon Engine F9DA/F9DB		o	GWB3532	
	2001.10-2005.04	Saloon Engine F9DA/F9DB		o	GWB6515	
	2001.10-2005.04	Saloon Engine F9DA/F9DB With ABS		o	GHA229001	
1.8 Turbo Di/TDDi (55 kW)	2001.08-2005.03	Saloon Engine BHDA/BHDB	•		GHA425004	K
	2001.08-2005.03	Saloon Engine BHDA/BHDB	•		GWB3530	
	2001.08-2005.03	Saloon Engine BHDA/BHDB	•		GWB3531	
	2001.08-2005.03	Saloon Engine BHDA/BHDB		o	GWB3532	
	2001.08-2005.03	Saloon Engine BHDA/BHDB		o	GWB6515	
1.8 Turbo Di/TDDi (66 kW)	1999.02-2004.11	Saloon Engine C9DA/C9DB/C9DC	•		GHA425004	K
	1999.02-2004.11	Saloon Engine C9DA/C9DB/C9DC	•		GWB3530	
	1999.02-2004.11	Saloon Engine C9DA/C9DB/C9DC	•		GWB3531	
	1999.02-2004.11	Saloon Engine C9DA/C9DB/C9DC		o	GWB3532	
	1999.02-2004.11	Saloon Engine C9DA/C9DB/C9DC		o	GWB6515	
	1999.02-2004.11	Saloon Engine C9DA/C9DB/C9DC With ABS		o	GHA229001	
2.0 16V (96 kW)	1999.02-2004.11	Saloon Engine EDDB/EDDC/EDDD/EDDF	•		GWB3530	
	1999.02-2004.11	Saloon Engine EDDB/EDDC/EDDD/EDDF	•		GWB3531	
	1999.02-2004.11	Saloon Engine EDDB/EDDC/EDDD/EDDF		o	GWB3532	
	1999.02-2004.11	Saloon Engine EDDB/EDDC/EDDD/EDDF		o	GWB6515	
	1999.02-2004.11	Saloon Engine EDDB/EDDC/EDDD/EDDF With ABS		o	GHA229001	
FOCUS (DNW)						
1.4 16V (55 kW)	1999.02-2004.11	Estate Engine FXDA/FXDB/FXDC/FXDD	•		GHA425004	K
	1999.02-2004.11	Estate Engine FXDA/FXDB/FXDC/FXDD	•		GWB3530	
	1999.02-2004.11	Estate Engine FXDA/FXDB/FXDC/FXDD	•		GWB3531	
	1999.02-2004.11	Estate Engine FXDA/FXDB/FXDC/FXDD		o	GWB3532	
	1999.02-2004.11	Estate Engine FXDA/FXDB/FXDC/FXDD		o	GWB6515	
	1999.02-2004.11	Estate Engine FXDA/FXDB/FXDC/FXDD With ABS		o	GHA229001	
1.6 16V (74 kW)	1999.02-2004.11	Estate Engine FYDA/FYDB/FYDC/FYDD/FYDH	•		GHA425004	K
	1999.02-2004.11	Estate Engine FYDA/FYDB/FYDC/FYDD/FYDH	•		GWB3530	
	1999.02-2004.11	Estate Engine FYDA/FYDB/FYDC/FYDD/FYDH	•		GWB3531	
	1999.02-2004.11	Estate Engine FYDA/FYDB/FYDC/FYDD/FYDH		o	GWB3532	
	1999.02-2004.11	Estate Engine FYDA/FYDB/FYDC/FYDD/FYDH		o	GWB6515	



	 YEAR		F	R	G-AP Ref.	KIT
FORD						
FOCUS (DNW)						
1.6 16V (74 kW)	1999.02-2004.11	Estate Engine FYDA/FYDB/FYDC/FYDD/FYDH With ABS		o	GHA229001	
1.6 16V Flexifuel (75 kW)	2002.01-2004.11	Estate Engine FYDH	•		GHA425004	K
	2002.01-2004.11	Estate Engine FYDH	•		GWB3530	
	2002.01-2004.11	Estate Engine FYDH	•		GWB3531	
	2002.01-2004.11	Estate Engine FYDH		o	GWB3532	
	2002.01-2004.11	Estate Engine FYDH		o	GWB6515	
1.8 16V (85 kW)	1999.02-2004.11	Estate Engine EYDB/EYDC/EYDD/EYDE/EYDF/EYDG/EYDI/EYDJ/EYDL	•		GHA425004	K
	1999.02-2004.11	Estate Engine EYDB/EYDC/EYDD/EYDE/EYDF/EYDG/EYDI/EYDJ/EYDL	•		GWB3530	
	1999.02-2004.11	Estate Engine EYDB/EYDC/EYDD/EYDE/EYDF/EYDG/EYDI/EYDJ/EYDL	•		GWB3531	
	1999.02-2004.11	Estate Engine EYDB/EYDC/EYDD/EYDE/EYDF/EYDG/EYDI/EYDJ/EYDL		o	GWB3532	
	1999.02-2004.11	Estate Engine EYDB/EYDC/EYDD/EYDE/EYDF/EYDG/EYDI/EYDJ/EYDL		o	GWB6515	
	1999.02-2004.11	Estate Engine EYDB/EYDC/EYDD/EYDE/EYDF/EYDG/EYDI/EYDJ/EYDL With ABS		o	GHA229001	
1.8 Di/TDDi (55 kW)	1999.08-2004.11	Estate Engine BHDA/BHDB	•		GHA425004	K
	1999.08-2004.11	Estate Engine BHDA/BHDB	•		GWB3530	
	1999.08-2004.11	Estate Engine BHDA/BHDB	•		GWB3531	
	1999.08-2004.11	Estate Engine BHDA/BHDB		o	GWB3532	
	1999.08-2004.11	Estate Engine BHDA/BHDB		o	GWB6515	
	1999.08-2004.11	Estate Engine BHDA/BHDB With ABS		o	GHA229001	
1.8 TDCi (74 kW)	2002.08-2004.11	Estate Engine FFDA	•		GHA425004	K
	2002.08-2004.11	Estate Engine FFDA	•		GWB3530	
	2002.08-2004.11	Estate Engine FFDA	•		GWB3531	
	2002.08-2004.11	Estate Engine FFDA		o	GWB3532	
	2002.08-2004.11	Estate Engine FFDA		o	GWB6515	
	2002.08-2004.11	Estate Engine FFDA With ABS		o	GHA229001	
1.8 TDCi (85 kW)	2001.03-2004.11	Estate Engine F9DA/F9DB	•		GHA425004	K
	2001.03-2004.11	Estate Engine F9DA/F9DB	•		GWB3530	
	2001.03-2004.11	Estate Engine F9DA/F9DB	•		GWB3531	
	2001.03-2004.11	Estate Engine F9DA/F9DB		o	GWB3532	
	2001.03-2004.11	Estate Engine F9DA/F9DB		o	GWB6515	
	2001.03-2004.11	Estate Engine F9DA/F9DB With ABS		o	GHA229001	
1.8 Turbo Di/TDDi (66 kW)	1999.02-2004.11	Estate Engine C9DA/C9DB/C9DC	•		GHA425004	K
	1999.02-2004.11	Estate Engine C9DA/C9DB/C9DC	•		GWB3530	
	1999.02-2004.11	Estate Engine C9DA/C9DB/C9DC	•		GWB3531	
	1999.02-2004.11	Estate Engine C9DA/C9DB/C9DC		o	GWB3532	
	1999.02-2004.11	Estate Engine C9DA/C9DB/C9DC		o	GWB6515	
	1999.02-2004.11	Estate Engine C9DA/C9DB/C9DC With ABS		o	GHA229001	
2.0 16V (96 kW)	1999.02-2004.11	Estate Engine EDDB/EDDC/EDDD/EDDF	•		GWB3530	
	1999.02-2004.11	Estate Engine EDDB/EDDC/EDDD/EDDF	•		GWB3531	
	1999.02-2004.11	Estate Engine EDDB/EDDC/EDDD/EDDF		o	GWB3532	
	1999.02-2004.11	Estate Engine EDDB/EDDC/EDDD/EDDF		o	GWB6515	
	1999.02-2004.11	Estate Engine EDDB/EDDC/EDDD/EDDF With ABS		o	GHA229001	
2.0 ST170 (127 kW)	2002.08-2004.11	Estate Engine ALDA	•		GWB3530	
	2002.08-2004.11	Estate Engine ALDA	•		GWB3531	
	2002.08-2004.11	Estate Engine ALDA		o	GWB3532	
	2002.08-2004.11	Estate Engine ALDA		o	GWB6515	
	2002.08-2004.11	Estate Engine ALDA With ABS		o	GHA229001	
FOCUS C-MAX						
1.6 (74 kW)	2003.10-2007.02	MPV Engine HWDA/HWDB	•		GHA336003	K
	2003.10-2007.02	MPV Engine HWDA/HWDB With ABS		o	GHA400084	K
	2003.10-2007.02	MPV Engine HWDA/HWDB Without ABS		o	GHA400105	
1.6 TDCi (66 kW)	2005.02-2007.03	MPV Engine HHDA/HHDB	•		GHA336003	K
	2005.02-2007.03	MPV Engine HHDA/HHDB With ABS		o	GHA400084	K
	2005.02-2007.03	MPV Engine HHDA/HHDB Without ABS		o	GHA400105	
1.6 TDCi (80 kW)	2003.10-2007.02	MPV Engine G8DA/G8DB	•		GHA336003	K
	2003.10-2007.02	MPV Engine G8DA/G8DB With ABS		o	GHA400084	K
	2003.10-2007.02	MPV Engine G8DA/G8DB Without ABS		o	GHA400105	
1.6 TI (85 kW)	2005.01-2007.03	MPV Engine HXDA/SIDA	•		GHA336003	K
	2005.01-2007.03	MPV Engine HXDA/SIDA With ABS		o	GHA400084	K
	2005.01-2007.03	MPV Engine HXDA/SIDA Without ABS		o	GHA400105	
1.8 (88 kW)	2003.10-2007.02	MPV Engine CSDA/CSDB	•		GHA336003	K
	2003.10-2007.02	MPV Engine CSDA/CSDB With ABS		o	GHA400084	K
	2003.10-2007.02	MPV Engine CSDA/CSDB Without ABS		o	GHA400105	
1.8 (92 kW)	2004.04-2007.03	MPV Engine Q7DA/QQDA/QQDB	•		GHA336003	K
	2004.04-2007.03	MPV Engine Q7DA/QQDA/QQDB With ABS		o	GHA400084	K



	 YEAR		F	R	G-AP Ref.	KIT
FORD						
FOCUS C-MAX						
1.8 (92 kW)	2004.04-2007.03	MPV Engine Q7DA/QQDA/QQDB Without ABS		o	GHA400105	
1.8 FlexFuel (92 kW)	2006.03-2007.03	MPV Engine Q7DA	•		GHA336003	K
	2006.03-2007.03	MPV Engine Q7DA With ABS		o	GHA400084	K
1.8 TDCi (85 kW)	2006.03-2007.03	MPV Engine Q7DA Without ABS		o	GHA400105	
	2005.10-2007.03	MPV Engine KKDA	•		GHA336003	K
	2005.10-2007.03	MPV Engine KKDA With ABS		o	GHA400084	K
2.0 (107 kW)	2005.10-2007.03	MPV Engine KKDA Without ABS		o	GHA400105	
	2004.03-2007.02	MPV Engine AODA/AODB/SYDA	•		GHA336003	K
	2004.03-2007.02	MPV Engine AODA/AODB/SYDA With ABS		o	GHA400084	K
2.0 TDCi (100 kW)	2004.03-2007.02	MPV Engine AODA/AODB/SYDA Without ABS		o	GHA400105	
	2003.10-2007.02	MPV Engine G6DA/G6DB/G6DD/G6DG	•		GHA336003	K
	2003.10-2007.02	MPV Engine G6DA/G6DB/G6DD/G6DG With ABS		o	GHA400084	K
	2003.10-2007.02	MPV Engine G6DA/G6DB/G6DD/G6DG Without ABS		o	GHA400105	
FOCUS II						
1.6 (74 kW)	2006.10-	Convertible Engine HWDA/HWDB/SHDA/SHDB/SHDC	•		GHA336003	K
	2006.10-	Convertible Engine HWDA/HWDB/SHDA/SHDB/SHDC With ABS		o	GHA400084	K
	2006.10-	Convertible Engine HWDA/HWDB/SHDA/SHDB/SHDC Without ABS		o	GHA400105	
2.0 (107 kW)	2006.10-	Convertible Engine AODA/AODB	•		GHA336003	K
	2006.10-	Convertible Engine AODA/AODB With ABS		o	GHA400084	K
	2006.10-	Convertible Engine AODA/AODB Without ABS		o	GHA400105	
2.0 TDCi (100 kW)	2006.10-	Convertible Engine G6DA/G6DB/G6DD	•		GHA336003	K
	2006.10-	Convertible Engine G6DA/G6DB/G6DD With ABS		o	GHA400084	K
	2006.10-	Convertible Engine G6DA/G6DB/G6DD Without ABS		o	GHA400105	
FOCUS II (DA_)						
1.4 (59 kW)	2005.01-2010.06	Hatchback Engine ASDA/ASDB	•		GHA336003	K
	2005.01-2010.06	Hatchback Engine ASDA/ASDB With ABS		o	GHA400084	K
	2005.01-2010.06	Hatchback Engine ASDA/ASDB Without ABS		o	GHA400105	
	2005.04-	Saloon Engine ASDA/ASDB	•		GHA336003	K
	2005.04-	Saloon Engine ASDA/ASDB With ABS		o	GHA400084	K
1.6 (74 kW)	2005.04-	Saloon Engine ASDA/ASDB Without ABS		o	GHA400105	
	2005.01-	Hatchback Engine HWDA/HWDB/SHDA/SHDB/SHDC	•		GHA336003	K
	2005.01-	Hatchback Engine HWDA/HWDB/SHDA/SHDB/SHDC With ABS		o	GHA400084	K
	2005.01-	Hatchback Engine HWDA/HWDB/SHDA/SHDB/SHDC Without ABS		o	GHA400105	
	2005.04-2009.12	Saloon Engine HWDA/HWDB/SHDA/SHDB/SHDC	•		GHA336003	K
1.6 LPG (85 kW)	2005.04-2009.12	Saloon Engine HWDA/HWDB/SHDA/SHDB/SHDC With ABS		o	GHA400084	K
	2005.04-2009.12	Saloon Engine HWDA/HWDB/SHDA/SHDB/SHDC Without ABS		o	GHA400105	
	2009.10-	Hatchback Engine SIDA	•		GHA336003	K
1.6 TDCi (66 kW)	2009.10-	Hatchback Engine SIDA With ABS		o	GHA400084	K
	2009.10-	Hatchback Engine SIDA Without ABS		o	GHA400105	
	2005.04-	Saloon Engine HHDA/HHDB	•		GHA336003	K
	2005.04-	Saloon Engine HHDA/HHDB With ABS		o	GHA400084	K
	2005.04-	Saloon Engine HHDA/HHDB Without ABS		o	GHA400105	
1.6 TDCi (74 kW)	2005.05-	Hatchback Engine GPDA/GPDC/HHDA/HHDB	•		GHA336003	K
	2005.05-	Hatchback Engine GPDA/GPDC/HHDA/HHDB With ABS		o	GHA400084	K
	2005.05-	Hatchback Engine GPDA/GPDC/HHDA/HHDB Without ABS		o	GHA400105	
	2004.11-	Estate Engine MTDA/G8DC	•		GHA336003	K
	2004.11-	Estate Engine MTDA/G8DC With ABS		o	GHA400084	K
1.6 TDCi (80 kW)	2004.11-	Hatchback Engine MTDA/G8DC	•		GHA336003	K
	2004.11-	Hatchback Engine MTDA/G8DC With ABS		o	GHA400084	K
	2005.04-	Saloon Engine G8DC/MTDA	•		GHA336003	K
	2005.04-	Saloon Engine G8DC/MTDA With ABS		o	GHA400084	K
	2004.11-	Hatchback Engine G8DA/G8DB/G8DD/G8DE/G8DF	•		GHA336003	K
	2004.11-	Hatchback Engine G8DA/G8DB/G8DD/G8DE/G8DF With ABS		o	GHA400084	K
	2004.11-	Hatchback Engine G8DA/G8DB/G8DD/G8DE/G8DF Without ABS		o	GHA400105	
	2005.04-2009.12	Saloon Engine G8DA/G8DB/G8DD/G8DE/G8DF	•		GHA336003	K
	2005.04-2009.12	Saloon Engine G8DA/G8DB/G8DD/G8DE/G8DF With ABS		o	GHA400084	K
	2005.04-2009.12	Saloon Engine G8DA/G8DB/G8DD/G8DE/G8DF Without ABS		o	GHA400105	
1.6 TDCi (81 kW)	2005.05-2008.03	Estate Engine G8DA/G8DB/G8DD/G8DE/G8DF	•		GHA336003	K
	2005.05-2008.03	Estate Engine G8DA/G8DB/G8DD/G8DE/G8DF With ABS		o	GHA400084	K
	2005.05-2008.03	Estate Engine G8DA/G8DB/G8DD/G8DE/G8DF Without ABS		o	GHA400105	
	2007.12-	Estate Engine G8DA	•		GHA336003	K
	2007.12-	Estate Engine G8DA With ABS		o	GHA400084	K
1.6 TI (85 kW)	2005.01-2008.05	Estate Engine HXDA/HXDB	•		GHA336003	K
	2005.01-2008.05	Estate Engine HXDA/HXDB With ABS		o	GHA400084	K



	 YEAR		F	R	G-AP Ref.	KIT
FORD						
FOCUS II (DA_)						
1.6 TI (85 kW)	2005.01-2008.05	Estate Engine HXDA/HXDB Without ABS		o	GHA400105	
	2005.01-2008.05	Hatchback Engine HXDA/HXDB	•		GHA336003	K
	2005.01-2008.05	Hatchback Engine HXDA/HXDB With ABS		o	GHA400084	K
1.8 (92 kW)	2005.01-2008.05	Hatchback Engine HXDA/HXDB Without ABS		o	GHA400105	
	2006.03-	Hatchback Engine QQDB	•		GHA336003	K
	2006.03-	Hatchback Engine QQDB With ABS		o	GHA400084	K
	2006.03-	Hatchback Engine QQDB Without ABS		o	GHA400105	
	2006.03-	Saloon Engine QQDB	•		GHA336003	K
1.8 FlexFuel (92 kW)	2006.03-	Saloon Engine QQDB With ABS		o	GHA400084	K
	2006.03-	Saloon Engine QQDB Without ABS		o	GHA400105	
	2005.10-	Hatchback Engine Q7DA	•		GHA336003	K
	2005.10-	Hatchback Engine Q7DA With ABS		o	GHA400084	K
	2005.10-	Hatchback Engine Q7DA Without ABS		o	GHA400105	
	2006.06-	Saloon Engine Q7DA	•		GHA336003	K
1.8 FlexFuel (96 kW)	2006.06-	Saloon Engine Q7DA With ABS		o	GHA400084	K
	2006.06-	Saloon Engine Q7DA Without ABS		o	GHA400105	
	2005.12-	Saloon	•		GHA336003	K
1.8 FlexFuel (97 kW)	2005.12-	Saloon With ABS		o	GHA400084	K
	2005.12-	Estate	•		GHA336003	K
1.8 Flexifuel (96 kW)	2005.12-	Estate With ABS		o	GHA400084	K
	2005.12-2008.01	Hatchback Engine QQDD	•		GHA336003	K
1.8 TDCi (85 kW)	2005.12-2008.01	Hatchback Engine QQDD With ABS		o	GHA400084	K
	2005.10-2009.12	Saloon Engine KKDA/KKDB	•		GHA336003	K
	2005.10-2009.12	Saloon Engine KKDA/KKDB With ABS		o	GHA400084	K
2.0 (104 kW)	2005.10-2009.12	Saloon Engine KKDA/KKDB Without ABS		o	GHA400105	
	2005.10-2010.06	Hatchback Engine KKDA/KKDB	•		GHA336003	K
	2005.10-2010.06	Hatchback Engine KKDA/KKDB With ABS		o	GHA400084	K
	2005.10-2010.06	Hatchback Engine KKDA/KKDB Without ABS		o	GHA400105	
	2005.06-2008.09	Hatchback	•		GHA336003	K
2.0 (105 kW)	2005.06-2008.09	Hatchback With ABS		o	GHA400084	K
	2008.02-	Saloon	•		GHA336003	K
	2008.02-	Saloon With ABS		o	GHA400084	K
2.0 (107 kW)	2010.04-	Hatchback	•		GHA336003	K
	2010.04-	Hatchback With ABS		o	GHA400084	K
2.0 CNG (107 kW)	2005.01-	Hatchback Engine AODA/AODB	•		GHA336003	K
	2005.01-	Hatchback Engine AODA/AODB With ABS		o	GHA400084	K
	2005.01-	Hatchback Engine AODA/AODB Without ABS		o	GHA400105	
	2005.04-2009.12	Saloon Engine AODA/AODB	•		GHA336003	K
	2005.04-2009.12	Saloon Engine AODA/AODB With ABS		o	GHA400084	K
	2005.04-2009.12	Saloon Engine AODA/AODB Without ABS		o	GHA400105	
2.0 LPG (107 kW)	2009.04-	Hatchback Engine SYDA	•		GHA336003	K
	2009.04-	Hatchback Engine SYDA With ABS		o	GHA400084	K
	2009.04-	Hatchback Engine SYDA Without ABS		o	GHA400105	
2.0 TDCi (100 kW)	2008.06-	Estate Engine SYDA	•		GHA336003	K
	2008.06-	Estate Engine SYDA With ABS		o	GHA400084	K
	2008.06-	Estate Engine SYDA Without ABS		o	GHA400105	
	2008.06-	Hatchback Engine SYDA	•		GHA336003	K
	2008.06-	Hatchback Engine SYDA With ABS		o	GHA400084	K
	2008.06-	Hatchback Engine SYDA Without ABS		o	GHA400105	
2.0 TDCi (81 kW)	2005.04-2009.12	Saloon Engine G6DA/G6DB/G6DD	•		GHA336003	K
	2005.04-2009.12	Saloon Engine G6DA/G6DB/G6DD With ABS		o	GHA400084	K
	2005.04-2009.12	Saloon Engine G6DA/G6DB/G6DD Without ABS		o	GHA400105	
2.0 TDCi (98 kW)	2008.07-2009.12	Hatchback Engine IXDA	•		GHA336003	K
	2008.07-2009.12	Hatchback Engine IXDA With ABS		o	GHA400084	K
	2008.07-2009.12	Hatchback Engine IXDA Without ABS		o	GHA400105	
	2008.07-2009.12	Saloon Engine IXDA	•		GHA336003	K
	2008.07-2009.12	Saloon Engine IXDA With ABS		o	GHA400084	K
	2008.07-2009.12	Saloon Engine IXDA Without ABS		o	GHA400105	
2.5 RS (224 kW)	2004.11-	Hatchback Engine G6DF/G6DE	•		GHA336003	K
	2004.11-	Hatchback Engine G6DF/G6DE With ABS		o	GHA400084	K
2.5 RS 500 (257 kW)	2009.04-2011.05	Hatchback Engine JZDA	•		GHA340001	K
2.5 ST (166 kW)	2010.05-2011.05	Hatchback Engine JZDA	•		GHA340001	K
2.5 ST (166 kW)	2005.09-	Hatchback Engine HYDA	•		GHA336003	K
	2005.09-	Hatchback Engine HYDA With ABS		o	GHA400084	K



	 YEAR		F	R	G-AP Ref.	KIT
FORD						
FOCUS II (DA_)						
2.5 ST (166 kW)	2005.09-	Hatchback Engine HYDA Without ABS		o	GHA400105	
FOCUS II STATION WAGON (DA_)						
1.4 (59 kW)	2004.11-	Estate Engine ASDA/ASDB	•		GHA336003	K
	2004.11-	Estate Engine ASDA/ASDB With ABS		o	GHA400084	K
	2004.11-	Estate Engine ASDA/ASDB Without ABS		o	GHA400105	
1.6 (74 kW)	2005.01-	Estate Engine HWDA/HWDB/SHDA/SHDB/SHDC	•		GHA336003	K
	2005.01-	Estate Engine HWDA/HWDB/SHDA/SHDB/SHDC With ABS		o	GHA400084	K
	2005.01-	Estate Engine HWDA/HWDB/SHDA/SHDB/SHDC Without ABS		o	GHA400105	
1.6 LPG (85 kW)	2009.10-	Estate Engine SIDA	•		GHA336003	K
	2009.10-	Estate Engine SIDA With ABS		o	GHA400084	K
	2009.10-	Estate Engine SIDA Without ABS		o	GHA400105	
1.6 TDCi (66 kW)	2005.10-2010.06	Estate Engine GPDA/GPDC/HHDA/HHDB	•		GHA336003	K
	2005.10-2010.06	Estate Engine GPDA/GPDC/HHDA/HHDB With ABS		o	GHA400084	K
	2005.10-2010.06	Estate Engine GPDA/GPDC/HHDA/HHDB Without ABS		o	GHA400105	
1.6 TI (85 kW)	2005.04-2008.05	Saloon Engine HXDA/HXDB	•		GHA336003	K
	2005.04-2008.05	Saloon Engine HXDA/HXDB With ABS		o	GHA400084	K
	2005.04-2008.05	Saloon Engine HXDA/HXDB Without ABS		o	GHA400105	
1.8 (92 kW)	2006.03-	Estate Engine Q7DA/QQDB	•		GHA336003	K
	2006.03-	Estate Engine Q7DA/QQDB With ABS		o	GHA400084	K
	2006.03-	Estate Engine Q7DA/QQDB Without ABS		o	GHA400105	
1.8 FlexFuel (92 kW)	2005.10-2008.03	Estate Engine Q7DA	•		GHA336003	K
	2005.10-2008.03	Estate Engine Q7DA With ABS		o	GHA400084	K
	2005.10-2008.03	Estate Engine Q7DA Without ABS		o	GHA400105	
1.8 TDCi (85 kW)	2005.10-2010.06	Estate Engine KKDA/KKDB	•		GHA336003	K
	2005.10-2010.06	Estate Engine KKDA/KKDB With ABS		o	GHA400084	K
	2005.10-2010.06	Estate Engine KKDA/KKDB Without ABS		o	GHA400105	
2.0 (107 kW)	2005.01-	Estate Engine AODA/AODB	•		GHA336003	K
	2005.01-	Estate Engine AODA/AODB With ABS		o	GHA400084	K
	2005.01-	Estate Engine AODA/AODB Without ABS		o	GHA400105	
2.0 TDCi (100 kW)	2005.01-	Estate Engine G6DA/G6DB/G6DD	•		GHA336003	K
	2005.01-	Estate Engine G6DA/G6DB/G6DD With ABS		o	GHA400084	K
	2005.01-	Estate Engine G6DA/G6DB/G6DD Without ABS		o	GHA400105	
	2005.01-	Hatchback Engine G6DA/G6DB/G6DD	•		GHA336003	K
	2005.01-	Hatchback Engine G6DA/G6DB/G6DD With ABS		o	GHA400084	K
	2005.01-	Hatchback Engine G6DA/G6DB/G6DD Without ABS		o	GHA400105	
2.0 TDCi (81 kW)	2008.07-2009.12	Estate Engine IXDA	•		GHA336003	K
	2008.07-2009.12	Estate Engine IXDA With ABS		o	GHA400084	K
	2008.07-2009.12	Estate Engine IXDA Without ABS		o	GHA400105	
2.0 TDCi (98 kW)	2004.11-	Estate Engine G6DF/G6DE	•		GHA336003	K
	2004.11-	Estate Engine G6DF/G6DE With ABS		o	GHA400084	K
FUSION (JU_)						
1.25 (55 kW)	2004.08-	Estate Engine FUJA/FUJB	•		GHA425004	K
	2004.08-	Estate Engine FUJA/FUJB	•		GWB3530	
	2004.08-	Estate Engine FUJA/FUJB	•		GWB3531	
	2004.08-	Estate Engine FUJA/FUJB		o	GWB3532	
	2004.08-	Estate Engine FUJA/FUJB		o	GWB6515	
1.4 (59 kW)	2002.08-	Estate Engine FXJA/FXJB/FXJC	•		GHA425004	K
	2002.08-	Estate Engine FXJA/FXJB/FXJC	•		GWB3530	
	2002.08-	Estate Engine FXJA/FXJB/FXJC	•		GWB3531	
	2002.08-	Estate Engine FXJA/FXJB/FXJC		o	GWB3532	
	2002.08-	Estate Engine FXJA/FXJB/FXJC		o	GWB6515	
1.4 LPG (59 kW)	2010.01-	Estate Engine UTJA	•		GHA425004	K
1.4 TDCi (50 kW)	2002.08-	Estate Engine F6JA/F6JB	•		GHA425004	K
	2002.08-	Estate Engine F6JA/F6JB	•		GWB3530	
	2002.08-	Estate Engine F6JA/F6JB	•		GWB3531	
	2002.08-	Estate Engine F6JA/F6JB		o	GWB3532	
	2002.08-	Estate Engine F6JA/F6JB		o	GWB6515	
1.6 (74 kW)	2002.08-	Estate Engine FYJA/FYJB	•		GHA425004	K
	2002.08-	Estate Engine FYJA/FYJB	•		GWB3530	
	2002.08-	Estate Engine FYJA/FYJB	•		GWB3531	
	2002.08-	Estate Engine FYJA/FYJB		o	GWB3532	
	2002.08-	Estate Engine FYJA/FYJB		o	GWB6515	
1.6 TDCi (66 kW)	2004.11-2007.03	Estate Engine HHJA/HHJB	•		GHA425004	K
	2004.11-2007.03	Estate Engine HHJA/HHJB	•		GWB3530	



	 YEAR		F	R	G-AP Ref.	KIT
FORD						
FUSION (JU_)						
1.6 TDCi (66 kW)	2004.11-2007.03	Estate Engine HHJA/HHJB	•		GWB3531	
	2004.11-2007.03	Estate Engine HHJA/HHJB		○	GWB3532	
	2004.11-2007.03	Estate Engine HHJA/HHJB		○	GWB6515	
GALAXY						
1.6 EcoBoost (118 kW)	2011.02-	MPV Engine JTWA/JTWB	•		GHA340005	K
	2011.02-	MPV Engine JTWA/JTWB		○	GHA400197	K
1.6 TDCi (85 kW)	2011.02-	MPV Engine T1WA/T1WB	•		GHA340005	K
	2011.02-	MPV Engine T1WA/T1WB		○	GHA400197	K
1.8 TDCi (74 kW)	2006.05-	MPV Engine FFWA	•		GHA340005	K
	2006.05-	MPV Engine FFWA		○	GHA400197	K
1.8 TDCi (92 kW)	2006.05-	MPV Engine QYWA	•		GHA340005	K
	2006.05-	MPV Engine QYWA		○	GHA400197	K
2.0 (107 kW)	2006.05-	MPV Engine AOWA/AOWB	•		GHA340005	K
	2006.05-	MPV Engine AOWA/AOWB		○	GHA400197	K
2.0 EcoBoost (149 kW)	2010.03-	MPV Engine TNWA	•		GHA340005	K
	2010.03-	MPV Engine TNWA		○	GHA400197	K
2.0 FlexFuel (107 kW)	2006.05-	MPV Engine TBWA/TBWB	•		GHA340005	K
	2006.05-	MPV Engine TBWA/TBWB		○	GHA400197	K
2.0 TDCi (100 kW)	2006.05-	MPV Engine AZWC/UKWA	•		GHA340005	K
	2006.05-	MPV Engine AZWC/UKWA		○	GHA400197	K
2.0 TDCi (103 kW)	2006.05-	MPV Engine QXWA/QXWB/QXWC/UFWA	•		GHA340005	K
	2006.05-	MPV Engine QXWA/QXWB/QXWC/UFWA		○	GHA400197	K
2.0 TDCi (120 kW)	2010.03-	MPV Engine TXWA	•		GHA340005	K
	2010.03-	MPV Engine TXWA		○	GHA400197	K
2.0 TDCi (85 kW)	2007.11-	MPV Engine KLWA/TYWA	•		GHA340005	K
	2007.11-	MPV Engine KLWA/TYWA		○	GHA400197	K
2.0 TDCi (96 kW)	2007.05-2008.03	MPV Engine AZWA	•		GHA340005	K
	2007.05-2008.03	MPV Engine AZWA		○	GHA400197	K
2.2 TDCi (129 kW)	2008.03-	MPV Engine Q4BA/Q4WA	•		GHA340005	K
	2008.03-	MPV Engine Q4BA/Q4WA		○	GHA400197	K
2.2 TDCi (147 kW)	2010.07-	MPV Engine KNWA	•		GHA340005	K
	2010.07-	MPV Engine KNWA		○	GHA400197	K
2.3 (118 kW)	2007.08-2008.03	MPV Engine SEWA	•		GHA340005	K
	2007.08-2008.03	MPV Engine SEWA		○	GHA400197	K
GALAXY (WA6)						
2.0 EcoBoost (146 kW)	2010.07-2015.06	MPV Engine TNWB	•		GHA340005	K
	2010.07-2015.06	MPV Engine TNWB		○	GHA400197	K
GALAXY (WGR)						
1.9 TDi (110 kW)	2005.01-2006.03	MPV Engine BTB	•		GWB3449	
	2005.01-2006.03	MPV Engine BTB		○	GWB3450	
1.9 TDi (66 kW)	1995.03-2006.05	MPV Engine 1Z/AHU/ANU	•		GWB3449	
	1995.03-2006.05	MPV Engine 1Z/AHU/ANU		○	GWB3450	
1.9 TDi (81 kW)	1997.08-2000.04	MPV Engine AFN/AVG	•		GWB3449	
	1997.08-2000.04	MPV Engine AFN/AVG		○	GWB3450	
1.9 TDi (85 kW)	2000.04-2006.05	MPV Engine AUJ	•		GWB3449	
	2000.04-2006.05	MPV Engine AUJ		○	GWB3450	
1.9 TDi (96 kW)	2002.12-2006.03	MPV Engine ASZ	•		GWB3449	
	2002.12-2006.03	MPV Engine ASZ		○	GWB3450	
2.0 i (85 kW)	1995.11-2006.05	MPV Engine NSE/ZVSA	•		GWB3449	
	1995.11-2006.05	MPV Engine NSE/ZVSA		○	GWB3450	
2.3 16V (103 kW)	2001.09-2006.03	MPV Engine E5SB	•		GWB3449	
	2001.09-2006.03	MPV Engine E5SB		○	GWB3450	
2.3 16V (107 kW)	1997.01-2006.05	MPV Engine E5SA/Y5B	•		GWB3449	
	1997.01-2006.05	MPV Engine E5SA/Y5B		○	GWB3450	
2.8 i V6 (128 kW)	1995.11-2000.04	MPV Engine AAA/AMY	•		GWB3449	
	1995.11-2000.04	MPV Engine AAA/AMY		○	GWB3450	
2.8 i V6 4x4 (128 kW)	1996.04-2000.04	MPV Engine AAA/AMY	•		GWB3449	
2.8 V6 (150 kW)	2000.04-2006.05	MPV Engine AYL	•		GWB3449	
	2000.04-2006.05	MPV Engine AYL		○	GWB3450	
GRANADA III (GAE, GGE)						
2.0 i (85 kW)	1992.02-1994.09	Hatchback Engine NRA/NRI		○	GWB0918	
	1992.02-1994.09	Hatchback Engine NRA/NRI		○	GWB0919	
2.5 TD (85 kW)	1993.08-1994.09	Hatchback Engine SCB		○	GWB0918	
	1993.08-1994.09	Hatchback Engine SCB		○	GWB0919	



	 YEAR		F	R	G-AP Ref.	KIT
FORD						
GRANADA III (GAE, GGE)						
2.9 i 24V (143 kW)	1991.04-1994.09	Hatchback Engine BOA		o	GWB0918	
	1991.04-1994.09	Hatchback Engine BOA		o	GWB0919	
GRANADA III (GGE)						
1.9 (85 kW)	1992.11-1993.09	Saloon Engine NRA		o	GWB0918	
	1992.11-1993.09	Saloon Engine NRA		o	GWB0919	
2.0 i (85 kW)	1991.09-1994.09	Estate Engine N9F		o	GWB0918	
	1991.09-1994.09	Estate Engine N9F		o	GWB0919	
	1992.02-1994.09	Saloon Engine N9F		o	GWB0918	
	1992.02-1994.09	Saloon Engine N9F		o	GWB0919	
2.0 i (88 kW)	1991.09-1994.09	Estate Engine N9D		o	GWB0918	
	1991.09-1994.09	Estate Engine N9D		o	GWB0919	
2.4 i (92 kW)	1991.09-1994.09	Estate Engine ARD		o	GWB0918	
	1991.09-1994.09	Estate Engine ARD		o	GWB0919	
2.5 TD (68 kW)	1991.09-1993.07	Estate Engine SFA/SFB		o	GWB0918	
	1991.09-1993.07	Estate Engine SFA/SFB		o	GWB0919	
2.5 TD (85 kW)	1993.08-1994.09	Estate Engine SCB		o	GWB0918	
	1993.08-1994.09	Estate Engine SCB		o	GWB0919	
	1993.08-1994.09	Saloon Engine SCB		o	GWB0918	
	1993.08-1994.09	Saloon Engine SCB		o	GWB0919	
2.9 24V (143 kW)	1993.08-1994.09	Estate Engine BOA		o	GWB0918	
	1993.08-1994.09	Estate Engine BOA		o	GWB0919	
2.9 i (107 kW)	1991.09-1994.09	Estate Engine BRD/BRE/BRF		o	GWB0918	
	1991.09-1994.09	Estate Engine BRD/BRE/BRF		o	GWB0919	
2.9 i 24V (143 kW)	1991.04-1994.09	Saloon Engine BOA		o	GWB0918	
	1991.04-1994.09	Saloon Engine BOA		o	GWB0919	
KA						
1.2 (51 kW)	2008.10-	Hatchback Engine FP4	•		GHA422015	
	2008.10-	Hatchback Engine FP4	•		GWB3577	
	2008.10-	Hatchback Engine FP4 With ABS		o	GHA230046	K
1.3 TDCi (55 kW)	2008.10-	Hatchback Engine FD4	•		GHA425008	
	2008.10-	Hatchback Engine FD4	•		GWB3539	
	2008.10-	Hatchback Engine FD4	•		GWB6540	
	2008.10-	Hatchback Engine FD4 With ABS		o	GHA230046	K
KA (RB_)						
1.0 i (38 kW)	1997.07-1999.09	Hatchback	•		GHA425004	K
	1997.07-1999.09	Hatchback	•		GWB1432	
	1997.07-1999.09	Hatchback		o	GWB3666	
1.0 i (48 kW)	1999.09-2008.11	Hatchback	•		GHA425004	K
	1999.09-2008.11	Hatchback	•		GWB1432	
	1999.09-2008.11	Hatchback	•		GWB3678	
	1999.09-2008.11	Hatchback		o	GWB3666	
1.3 i (36 kW)	1998.06-2008.11	Hatchback Engine JJD/JJF/JJG/JJH/JJL	•		GHA425004	K
	1998.06-2008.11	Hatchback Engine JJD/JJF/JJG/JJH/JJL	•		GWB1432	
	1998.06-2008.11	Hatchback Engine JJD/JJF/JJG/JJH/JJL	•		GWB3678	
	1998.06-2008.11	Hatchback Engine JJD/JJF/JJG/JJH/JJL		o	GWB3666	
1.3 i (37 kW)	1996.09-2002.10	Hatchback Engine JJB	•		GHA425004	K
	1996.09-2002.10	Hatchback Engine JJB	•		GWB1432	
	1996.09-2002.10	Hatchback Engine JJB	•		GWB3678	
	1996.09-2002.10	Hatchback Engine JJB		o	GWB3666	
1.3 i (44 kW)	1996.09-2008.11	Hatchback Engine BAA/J4D/J4K/J4M/J4N/J4P/J4S	•		GHA425004	K
	1996.09-2008.11	Hatchback Engine BAA/J4D/J4K/J4M/J4N/J4P/J4S	•		GWB1432	
	1996.09-2008.11	Hatchback Engine BAA/J4D/J4K/J4M/J4N/J4P/J4S	•		GWB3678	
	1996.09-2008.11	Hatchback Engine BAA/J4D/J4K/J4M/J4N/J4P/J4S		o	GWB3666	
1.3 i (51 kW)	2002.08-2008.11	Hatchback Engine A9A/A9B	•		GHA425004	K
	2002.08-2008.11	Hatchback Engine A9A/A9B	•		GWB1432	
	2002.08-2008.11	Hatchback Engine A9A/A9B	•		GWB3678	
	2002.08-2008.11	Hatchback Engine A9A/A9B		o	GWB3666	
1.6 (68 kW)	2006.10-2007.12	Hatchback	•		GWB3678	
1.6 (70 kW)	2000.09-2008.11	Hatchback Engine CDB/CDC	•		GHA425004	K
	2000.09-2008.11	Hatchback Engine CDB/CDC	•		GWB1432	
	2000.09-2008.11	Hatchback Engine CDB/CDC	•		GWB3678	
1.6 i (70 kW)	2003.07-2008.11	Hatchback Engine CDB/CDC/CCA	•		GHA425004	K
	2003.07-2008.11	Hatchback Engine CDB/CDC/CCA	•		GWB3678	
	2003.07-2008.11	Hatchback Engine CDB/CDC/CCA		o	GWB3666	



	 YEAR		F	R	G-AP Ref.	KIT
FORD						
KA (RB_)						
1.6 i (71 kW)	2005.11-2008.09	Hatchback	•		GHA425004	K
	2005.11-2008.09	Hatchback	•		GWB3678	
KA VAN (RB)						
1.3 i (44 kW)	2002.05-2005.05	Box Engine BAA/J4D/J4K/J4M/J4N/J4P/J4S	•		GHA425004	K
	2002.05-2005.05	Box Engine BAA/J4D/J4K/J4M/J4N/J4P/J4S	•		GWB1432	
	2002.05-2005.05	Box Engine BAA/J4D/J4K/J4M/J4N/J4P/J4S	•		GWB3678	
	2002.05-2005.05	Box Engine BAA/J4D/J4K/J4M/J4N/J4P/J4S		○	GWB3666	
KUGA I						
2.0 TDCi (100 kW)	2008.03-	Closed Off-Road Vehicle Engine G6DG/UKDA	•		GWB6636	
2.0 TDCi (103 kW)	2010.03-	Closed Off-Road Vehicle Engine UFDA	•		GWB6636	
2.0 TDCi 4x4 (100 kW)	2008.03-	Closed Off-Road Vehicle Engine G6DG/UKDA	•		GWB6636	
	2008.03-	Closed Off-Road Vehicle Engine G6DG/UKDA		○	GHA336017	K
2.0 TDCi 4x4 (103 kW)	2010.03-	Closed Off-Road Vehicle Engine UFDA	•		GWB6636	
	2010.03-	Closed Off-Road Vehicle Engine UFDA		○	GHA336017	K
2.0 TDCi 4x4 (120 kW)	2010.03-	Closed Off-Road Vehicle Engine TXDA	•		GWB6636	
	2010.03-	Closed Off-Road Vehicle Engine TXDA		○	GHA336017	K
2.5 (147 kW)	2009.03-	Closed Off-Road Vehicle Engine HYDB	•		GWB6636	
2.5 4x4 (147 kW)	2009.03-	Closed Off-Road Vehicle Engine HYDB	•		GWB6636	
	2009.03-	Closed Off-Road Vehicle Engine HYDB		○	GHA336017	K
KUGA II (DM2)						
1.5 EcoBoost (110 kW)	2014.09-			○	GHA400337	K
1.6 EcoBoost (110 kW)	2014.02-			○	GHA400337	K
2.0 TDCi (103 kW)	2013.03-			○	GHA400337	K
2.0 TDCi (88 kW)	2014.09-			○	GHA400337	K
MAVERICK (UDS, UNS)						
2.4 i (85 kW)	1996.09-1998.04	Closed Off-Road Vehicle Engine KA-24	•		GWB3205	
2.4 i (87 kW)	1996.09-1998.04	Closed Off-Road Vehicle Engine KA-24	•		GWB3205	
2.4 i (91 kW)	1993.02-1996.08	Closed Off-Road Vehicle Engine KA24-E	•		GWB3205	
2.7 TD (74 kW)	1993.02-1996.08	Closed Off-Road Vehicle Engine TD27	•		GWB3205	
2.7 TD (92 kW)	1996.09-1998.04	Closed Off-Road Vehicle Engine TD27E	•		GWB3205	
MONDEO (BNP)						
1.6 i 16V (65 kW)	1994.07-1996.08	Estate Engine L1J	•		GWB1480	
1.6 i 16V (66 kW)	1993.04-1996.08	Estate Engine L1F	•		GWB1480	
1.8 i 16V (82 kW)	1994.07-1996.08	Estate Engine RKB	•		GWB1480	
1.8 i 16V (85 kW)	1993.04-1996.08	Estate Engine RKA	•		GWB1480	
1.8 i 16V 4x4 (85 kW)	1993.04-1996.08	Estate Engine RKA	•		GWB1480	
1.8 TD (65 kW)	1993.06-1996.08	Estate Engine RFM/RFN	•		GWB1480	
1.8 TD (66 kW)	1995.11-1996.08	Estate Engine RFM/RFN	•		GWB1480	
2.0 i 16V (100 kW)	1993.04-1996.08	Estate Engine NGA	•		GWB1480	
2.0 i 16V 4x4 (100 kW)	1993.04-1996.08	Estate Engine NGA	•		GWB1480	
2.0 i 16V 4x4 (97 kW)	1994.12-1996.08	Estate Engine NGA	•		GWB1480	
2.5 i 24V (125 kW)	1994.07-1996.08	Estate Engine SEA	•		GWB1480	
MONDEO (GBP)						
1.6 i 16V (65 kW)	1994.07-1996.08	Hatchback Engine L1J	•		GWB1480	
	1994.07-1996.08	Hatchback Engine L1J With ABS		○	GHA235005	K
	1994.07-1996.08	Hatchback Engine L1J Without ABS		○	GHA235009	K
	1994.07-1996.08	Saloon Engine L1J	•		GWB1480	
	1994.07-1996.08	Saloon Engine L1J With ABS		○	GHA235005	K
	1994.07-1996.08	Saloon Engine L1J Without ABS		○	GHA235009	K
1.6 i 16V (66 kW)	1993.02-1996.08	Hatchback Engine L1F	•		GWB1480	
	1993.02-1996.08	Hatchback Engine L1F With ABS		○	GHA235005	K
	1993.02-1996.08	Hatchback Engine L1F Without ABS		○	GHA235009	K
	1993.02-1996.08	Saloon Engine L1F	•		GWB1480	
	1993.02-1996.08	Saloon Engine L1F With ABS		○	GHA235005	K
	1993.02-1996.08	Saloon Engine L1F Without ABS		○	GHA235009	K
1.8 i 16V (82 kW)	1994.01-1996.08	Saloon Engine RKB	•		GWB1480	
	1994.01-1996.08	Saloon Engine RKB With ABS		○	GHA235005	K
	1994.01-1996.08	Saloon Engine RKB Without ABS		○	GHA235009	K
	1994.07-1996.08	Hatchback Engine RKB	•		GWB1480	
	1994.07-1996.08	Hatchback Engine RKB With ABS		○	GHA235005	K
	1994.07-1996.08	Hatchback Engine RKB Without ABS		○	GHA235009	K
1.8 i 16V (85 kW)	1993.02-1996.08	Hatchback Engine RKA	•		GWB1480	
	1993.02-1996.08	Hatchback Engine RKA With ABS		○	GHA235005	K
	1993.02-1996.08	Hatchback Engine RKA Without ABS		○	GHA235009	K



	 YEAR		F	R	G-AP Ref.	KIT
FORD						
MONDEO (GBP)						
1.8 i 16V (85 kW)	1993.02-1996.08	Saloon Engine RKA	•		GWB1480	
	1993.02-1996.08	Saloon Engine RKA With ABS		○	GHA235005	K
	1993.02-1996.08	Saloon Engine RKA Without ABS		○	GHA235009	K
1.8 i 16V 4x4 (85 kW)	1993.02-1996.08	Hatchback Engine RKA	•		GWB1480	
1.8 TD (65 kW)	1993.06-1996.08	Hatchback Engine RFM/RFN	•		GWB1480	
	1993.06-1996.08	Hatchback Engine RFM/RFN With ABS		○	GHA235005	K
	1993.06-1996.08	Hatchback Engine RFM/RFN Without ABS		○	GHA235009	K
	1993.06-1996.08	Saloon Engine RFM/RFN	•		GWB1480	
	1993.06-1996.08	Saloon Engine RFM/RFN With ABS		○	GHA235005	K
1.8 TD (66 kW)	1993.06-1996.08	Saloon Engine RFM/RFN Without ABS		○	GHA235009	K
	1995.10-1996.08	Hatchback Engine RFM/RFN	•		GWB1480	
	1995.10-1996.08	Hatchback Engine RFM/RFN With ABS		○	GHA235005	K
	1995.10-1996.08	Hatchback Engine RFM/RFN Without ABS		○	GHA235009	K
	1995.10-1996.08	Saloon Engine RFM/RFN	•		GWB1480	
2.0 i 16V (100 kW)	1995.10-1996.08	Saloon Engine RFM/RFN With ABS		○	GHA235005	K
	1995.10-1996.08	Saloon Engine RFM/RFN Without ABS		○	GHA235009	K
	1993.02-1996.08	Hatchback Engine NGA	•		GWB1480	
	1993.02-1996.08	Hatchback Engine NGA With ABS		○	GHA235005	K
	1993.02-1996.08	Hatchback Engine NGA Without ABS		○	GHA235009	K
2.0 i 16V (97 kW)	1993.02-1996.08	Saloon Engine NGA	•		GWB1480	
	1993.02-1996.08	Saloon Engine NGA With ABS		○	GHA235005	K
	1993.02-1996.08	Saloon Engine NGA Without ABS		○	GHA235009	K
	1994.12-1996.08	Hatchback Engine NGA	•		GWB1480	
	1994.12-1996.08	Hatchback Engine NGA With ABS		○	GHA235005	K
2.0 i 16V 4x4 (97 kW)	1994.12-1996.08	Hatchback Engine NGA Without ABS		○	GHA235009	K
	1994.12-1996.08	Hatchback Engine NGA	•		GWB1480	
	1994.12-1996.08	Saloon Engine NGA	•		GWB1480	
2.5 i 24V (125 kW)	1994.07-1996.08	Hatchback Engine SEA	•		GWB1480	
	1994.07-1996.08	Hatchback Engine SEA With ABS		○	GHA235005	K
	1994.07-1996.08	Hatchback Engine SEA Without ABS		○	GHA235009	K
	1994.07-1996.08	Saloon Engine SEA	•		GWB1480	
	1994.07-1996.08	Saloon Engine SEA With ABS		○	GHA235005	K
	1994.07-1996.08	Saloon Engine SEA Without ABS		○	GHA235009	K
MONDEO I (BNP)						
2.0 i 16V (97 kW)	1993.01-1996.08	Estate Engine NGA	•		GWB1480	
MONDEO I (GBP)						
1.8 4x4 (85 kW)	1993.02-1996.08	Saloon Engine RKA	•		GWB1480	
2.0 i 16V 4x4 (100 kW)	1993.02-1996.08	Saloon Engine NGA	•		GWB1480	
	1993.04-1996.08	Hatchback Engine NGA	•		GWB1480	
MONDEO II (BAP)						
1.6 i (66 kW)	1996.09-2000.11	Hatchback Engine L1J	•		GWB1480	
	1996.09-2000.11	Hatchback Engine L1J With ABS		○	GHA235005	K
	1996.09-2000.11	Hatchback Engine L1J Without ABS		○	GHA235009	K
1.6 i 16V (70 kW)	1998.05-2000.11	Hatchback Engine L1L/L1N/L1Q	•		GWB1480	
	1998.05-2000.11	Hatchback Engine L1L/L1N/L1Q With ABS		○	GHA235005	K
	1998.05-2000.11	Hatchback Engine L1L/L1N/L1Q Without ABS		○	GHA235009	K
1.8 i (85 kW)	1996.09-2000.11	Hatchback Engine RKB/RKF/RKH/RKJ/RKK	•		GWB1480	
	1996.09-2000.11	Hatchback Engine RKB/RKF/RKH/RKJ/RKK With ABS		○	GHA235005	K
	1996.09-2000.11	Hatchback Engine RKB/RKF/RKH/RKJ/RKK Without ABS		○	GHA235009	K
1.8 TD (66 kW)	1996.09-2000.11	Hatchback Engine RFN	•		GWB1480	
	1996.09-2000.11	Hatchback Engine RFN With ABS		○	GHA235005	K
	1996.09-2000.11	Hatchback Engine RFN Without ABS		○	GHA235009	K
2.0 i (96 kW)	1996.09-2000.11	Hatchback Engine NGA/NGB/NGC/NGD	•		GWB1480	
	1996.09-2000.11	Hatchback Engine NGA/NGB/NGC/NGD With ABS		○	GHA235005	K
	1996.09-2000.11	Hatchback Engine NGA/NGB/NGC/NGD Without ABS		○	GHA235009	K
2.5 24V (125 kW)	1996.09-2000.11	Hatchback Engine SEA	•		GWB1480	
	1996.09-2000.11	Hatchback Engine SEA With ABS		○	GHA235005	K
	1996.09-2000.11	Hatchback Engine SEA Without ABS		○	GHA235009	K
	2000.06-2000.11	Hatchback Engine SEB/SEC	•		GWB1480	
	2000.06-2000.11	Hatchback Engine SEB/SEC With ABS		○	GHA235005	K
	2000.06-2000.11	Hatchback Engine SEB/SEC Without ABS		○	GHA235009	K
2.5 ST (151 kW)	1999.05-2000.11	Hatchback Engine SGA	•		GWB1480	
	1999.05-2000.11	Hatchback Engine SGA With ABS		○	GHA235005	K
	1999.05-2000.11	Hatchback Engine SGA Without ABS		○	GHA235009	K



	 YEAR		F	R	G-AP Ref.	KIT
FORD						
MONDEO II (BFP)						
1.6 i (66 kW)	1996.09-2000.11	Saloon Engine L1J	•		GWB1480	
	1996.09-2000.11	Saloon Engine L1J With ABS		○	GHA235005	K
	1996.09-2000.11	Saloon Engine L1J Without ABS		○	GHA235009	K
1.6 i 16V (70 kW)	1998.05-2000.11	Saloon Engine L1L/L1N/L1Q	•		GWB1480	
	1998.05-2000.11	Saloon Engine L1L/L1N/L1Q With ABS		○	GHA235005	K
	1998.05-2000.11	Saloon Engine L1L/L1N/L1Q Without ABS		○	GHA235009	K
1.8 i (85 kW)	1996.09-2000.11	Saloon Engine RKB/RKF/RKH/RKJ/RKK	•		GWB1480	
	1996.09-2000.11	Saloon Engine RKB/RKF/RKH/RKJ/RKK With ABS		○	GHA235005	K
	1996.09-2000.11	Saloon Engine RKB/RKF/RKH/RKJ/RKK Without ABS		○	GHA235009	K
1.8 TD (66 kW)	1996.09-2000.11	Saloon Engine RFN	•		GWB1480	
	1996.09-2000.11	Saloon Engine RFN With ABS		○	GHA235005	K
	1996.09-2000.11	Saloon Engine RFN Without ABS		○	GHA235009	K
2.0 i (96 kW)	1996.09-2000.11	Saloon Engine NGA/NGB/NGC/NGD	•		GWB1480	
	1996.09-2000.11	Saloon Engine NGA/NGB/NGC/NGD With ABS		○	GHA235005	K
	1996.09-2000.11	Saloon Engine NGA/NGB/NGC/NGD Without ABS		○	GHA235009	K
2.5 24V (125 kW)	1996.09-2000.11	Saloon Engine SEA	•		GWB1480	
	1996.09-2000.11	Saloon Engine SEA With ABS		○	GHA235005	K
	1996.09-2000.11	Saloon Engine SEA Without ABS		○	GHA235009	K
	2000.06-2000.11	Saloon Engine SEB/SEC	•		GWB1480	
	2000.06-2000.11	Saloon Engine SEB/SEC With ABS		○	GHA235005	K
2.5 ST (151 kW)	1999.05-2000.11	Saloon Engine SGA	•		GWB1480	
	1999.05-2000.11	Saloon Engine SGA With ABS		○	GHA235005	K
	1999.05-2000.11	Saloon Engine SGA Without ABS		○	GHA235009	K
MONDEO II (BNP)						
1.6 i (66 kW)	1996.09-2000.11	Estate Engine L1J	•		GWB1480	
	1996.09-2000.11	Estate Engine L1J		○	GHA400191	
1.6 i 16V (70 kW)	1998.05-2000.11	Estate Engine L1L/L1N/L1Q	•		GWB1480	
	1998.05-2000.11	Estate Engine L1L/L1N/L1Q		○	GHA400191	
1.8 i (85 kW)	1996.09-2000.11	Estate Engine RKB/RKF/RKH/RKJ/RKK	•		GWB1480	
	1996.09-2000.11	Estate Engine RKB/RKF/RKH/RKJ/RKK		○	GHA400191	
1.8 TD (66 kW)	1996.09-2000.11	Estate Engine RFN	•		GWB1480	
	1996.09-2000.11	Estate Engine RFN		○	GHA400191	
2.0 i (96 kW)	1996.09-2000.11	Estate Engine NGA/NGB/NGC/NGD	•		GWB1480	
	1996.09-2000.11	Estate Engine NGA/NGB/NGC/NGD		○	GHA400191	
2.5 24V (125 kW)	1996.09-2000.11	Estate Engine SEA	•		GWB1480	
	1996.09-2000.11	Estate Engine SEA		○	GHA400191	
	1999.10-2000.11	Estate Engine SEB/SEC	•		GWB1480	
	1999.10-2000.11	Estate Engine SEB/SEC		○	GHA400191	
2.5 ST (151 kW)	1999.05-2000.11	Estate Engine SGA	•		GWB1480	
	1999.05-2000.11	Estate Engine SGA		○	GHA400191	
MONDEO III (B4Y)						
1.8 16V (81 kW)	2000.11-2007.08	Saloon Engine CGBA/CGBB	•		GWB3575	
	2000.11-2007.08	Saloon Engine CGBA/CGBB		○	GHA400081	K
1.8 16V (92 kW)	2000.11-2007.08	Saloon Engine CHBA/CHBB	•		GWB3575	
	2000.11-2007.08	Saloon Engine CHBA/CHBB		○	GHA400081	K
1.8 SCi (96 kW)	2003.06-2007.08	Saloon Engine CFBA	•		GWB3575	
	2003.06-2007.08	Saloon Engine CFBA		○	GHA400081	K
2.0 16V (107 kW)	2000.11-2007.08	Saloon Engine CJBA/CJBB	•		GWB3575	
	2000.11-2007.08	Saloon Engine CJBA/CJBB		○	GHA400081	K
2.0 16V Di/TDDi/TDCi (66 kW)	2000.11-2007.08	Saloon Engine D5BA/SDBA	•		GWB3575	
	2000.11-2007.08	Saloon Engine D5BA/SDBA	•		GWB3625	
	2000.11-2007.08	Saloon Engine D5BA/SDBA		○	GHA400081	K
2.0 16V TDDi/TDCi (85 kW)	2000.11-2007.08	Saloon Engine D6BA/HJBA/HJBB/HJBC	•		GWB3575	
	2000.11-2007.08	Saloon Engine D6BA/HJBA/HJBB/HJBC	•		GWB3625	
	2000.11-2007.08	Saloon Engine D6BA/HJBA/HJBB/HJBC		○	GHA400081	K
2.0 TDCi (96 kW)	2001.10-2007.08	Saloon Engine FMBA/N7BA	•		GWB3575	
	2001.10-2007.08	Saloon Engine FMBA/N7BA	•		GWB3625	
	2001.10-2007.08	Saloon Engine FMBA/N7BA		○	GHA400081	K
2.2 TDCi (114 kW)	2004.07-2007.08	Saloon Engine QJBA/QJBB	•		GWB3575	
	2004.07-2007.08	Saloon Engine QJBA/QJBB		○	GHA400081	K
2.5 V6 24V (125 kW)	2000.11-2007.08	Saloon Engine LCBD	•		GWB3575	
	2000.11-2007.08	Saloon Engine LCBD	•		GWB3625	
	2000.11-2007.08	Saloon Engine LCBD		○	GHA400081	K



	 YEAR		F	R	G-AP Ref.	KIT
FORD						
MONDEO III (B4Y)						
3.0 ST220 (166 kW)	2002.04-2007.08	Saloon Engine MEBA	•		GWB3575	
	2002.04-2007.08	Saloon Engine MEBA		◦	GHA400081	K
3.0 V6 24V (150 kW)	2005.05-2007.08	Saloon Engine REBA	•		GWB3575	
	2005.05-2007.08	Saloon Engine REBA		◦	GHA400081	K
MONDEO III (B5Y)						
1.8 16V (81 kW)	2000.11-2007.08	Hatchback Engine CGBA/CGBB	•		GWB3575	
	2000.11-2007.08	Hatchback Engine CGBA/CGBB		◦	GHA400081	K
1.8 16V (92 kW)	2000.11-2007.08	Hatchback Engine CHBA/CHBB	•		GWB3575	
	2000.11-2007.08	Hatchback Engine CHBA/CHBB		◦	GHA400081	K
1.8 SCi (96 kW)	2005.05-2007.08	Hatchback Engine CFBA	•		GWB3575	
	2005.05-2007.08	Hatchback Engine CFBA		◦	GHA400081	K
2.0 16V (107 kW)	2000.11-2007.08	Hatchback Engine CJBA/CJBB	•		GWB3575	
	2000.11-2007.08	Hatchback Engine CJBA/CJBB		◦	GHA400081	K
2.0 16V Di/TDDi/TDCi (66 kW)	2000.11-2007.08	Hatchback Engine D5BA/SDBA	•		GWB3575	
	2000.11-2007.08	Hatchback Engine D5BA/SDBA	•		GWB3625	
	2000.11-2007.08	Hatchback Engine D5BA/SDBA		◦	GHA400081	K
2.0 16V TDDi/TDCi (85 kW)	2000.11-2007.08	Hatchback Engine D6BA/HJBA/HJBB/HJBC	•		GWB3575	
	2000.11-2007.08	Hatchback Engine D6BA/HJBA/HJBB/HJBC	•		GWB3625	
	2000.11-2007.08	Hatchback Engine D6BA/HJBA/HJBB/HJBC		◦	GHA400081	K
2.0 TDCi (96 kW)	2001.10-2007.08	Hatchback Engine FMBA/N7BA	•		GWB3575	
	2001.10-2007.08	Hatchback Engine FMBA/N7BA	•		GWB3625	
	2001.10-2007.08	Hatchback Engine FMBA/N7BA		◦	GHA400081	K
2.2 TDCi (114 kW)	2005.08-2007.08	Hatchback Engine QJBA/QJBB	•		GWB3575	
	2005.08-2007.08	Hatchback Engine QJBA/QJBB		◦	GHA400081	K
2.5 V6 24V (125 kW)	2000.11-2007.08	Hatchback Engine LCB D	•		GWB3575	
	2000.11-2007.08	Hatchback Engine LCB D	•		GWB3625	
	2000.11-2007.08	Hatchback Engine LCB D		◦	GHA400081	K
3.0 ST220 (166 kW)	2002.04-2007.08	Hatchback Engine MEBA	•		GWB3575	
	2002.04-2007.08	Hatchback Engine MEBA		◦	GHA400081	K
3.0 V6 24V (150 kW)	2004.09-2007.08	Hatchback Engine REBA	•		GWB3575	
	2004.09-2007.08	Hatchback Engine REBA		◦	GHA400081	K
MONDEO III (BWY)						
1.8 16V (81 kW)	2000.11-2007.08	Estate Engine CGBA/CGBB	•		GWB3575	
	2000.11-2007.08	Estate Engine CGBA/CGBB		◦	GHA400081	K
1.8 16V (92 kW)	2000.11-2007.08	Estate Engine CHBA/CHBB	•		GWB3575	
	2000.11-2007.08	Estate Engine CHBA/CHBB		◦	GHA400081	K
1.8 SCi (96 kW)	2003.06-2007.08	Estate Engine CFBA	•		GWB3575	
	2003.06-2007.08	Estate Engine CFBA		◦	GHA400081	K
2.0 16V (107 kW)	2000.11-2007.08	Estate Engine CJBA/CJBB	•		GWB3575	
	2000.11-2007.08	Estate Engine CJBA/CJBB		◦	GHA400081	K
2.0 16V Di/TDDi/TDCi (66 kW)	2000.11-2007.08	Estate Engine D5BA/SDBA	•		GWB3575	
	2000.11-2007.08	Estate Engine D5BA/SDBA	•		GWB3625	
	2000.11-2007.08	Estate Engine D5BA/SDBA		◦	GHA400081	K
2.0 16V TDDi/TDCi (85 kW)	2000.11-2007.08	Estate Engine D6BA/HJBA/HJBB/HJBC	•		GWB3575	
	2000.11-2007.08	Estate Engine D6BA/HJBA/HJBB/HJBC	•		GWB3625	
	2000.11-2007.08	Estate Engine D6BA/HJBA/HJBB/HJBC		◦	GHA400081	K
2.0 TDCi (96 kW)	2001.10-2007.08	Estate Engine FMBA/N7BA	•		GWB3575	
	2001.10-2007.08	Estate Engine FMBA/N7BA	•		GWB3625	
	2001.10-2007.08	Estate Engine FMBA/N7BA		◦	GHA400081	K
2.2 TDCi (114 kW)	2004.07-2007.08	Estate Engine QJBA/QJBB	•		GWB3575	
	2004.07-2007.08	Estate Engine QJBA/QJBB		◦	GHA400081	K
2.5 V6 24V (125 kW)	2000.11-2007.08	Estate Engine LCB D	•		GWB3575	
	2000.11-2007.08	Estate Engine LCB D	•		GWB3625	
	2000.11-2007.08	Estate Engine LCB D		◦	GHA400081	K
3.0 ST220 (166 kW)	2002.04-2007.08	Estate Engine MEBA	•		GWB3575	
	2002.04-2007.08	Estate Engine MEBA		◦	GHA400081	K
3.0 V6 24V (150 kW)	2005.05-2007.08	Estate Engine REBA	•		GWB3575	
	2005.05-2007.08	Estate Engine REBA		◦	GHA400081	K
MONDEO IV						
1.6 EcoBoost (118 kW)	2011.02-	Hatchback Engine JTBB	•		GHA340001	K
1.6 TDCi (85 kW)	2011.02-	Hatchback Engine T1BB/T1BA/T1BC	•		GHA340001	K
1.6 Ti (81 kW)	2007.03-	Hatchback Engine RHBA	•		GHA340001	K
	2007.03-	Hatchback Engine RHBA		◦	GHA400207	K
	2007.03-	Saloon Engine RHBA	•		GHA340001	K



	 YEAR		F	R	G-AP Ref.	KIT
FORD MONDEO IV						
1.6 Ti (81 kW)	2007.03-	Saloon Engine RHBA		o	GHA400207	K
1.6 Ti (88 kW)	2010.07-	Hatchback Engine KGBA	•		GHA340001	K
1.6 Ti (92 kW)	2007.03-	Hatchback Engine PNBA	•		GHA340001	K
	2007.03-	Hatchback Engine PNBA		o	GHA400207	K
	2007.03-	Saloon Engine PNBA	•		GHA340001	K
	2007.03-	Saloon Engine PNBA		o	GHA400207	K
1.8 TDCi (74 kW)	2007.03-	Hatchback Engine FFBA	•		GHA340001	K
	2007.03-	Hatchback Engine FFBA		o	GHA400207	K
	2007.03-	Saloon Engine FFBA	•		GHA340001	K
	2007.03-	Saloon Engine FFBA		o	GHA400207	K
1.8 TDCi (92 kW)	2007.06-	Hatchback Engine KHBA/QYBA	•		GHA340001	K
	2007.06-	Hatchback Engine KHBA/QYBA		o	GHA400207	K
	2007.06-	Saloon Engine KHBA/QYBA	•		GHA340001	K
	2007.06-	Saloon Engine KHBA/QYBA		o	GHA400207	K
2.0 (107 kW)	2007.03-	Hatchback Engine AOBA/AOBC/TBBA	•		GHA340001	K
	2007.03-	Hatchback Engine AOBA/AOBC/TBBA		o	GHA400207	K
	2007.03-	Saloon Engine AOBA/AOBC/TBBA	•		GHA340001	K
	2007.03-	Saloon Engine AOBA/AOBC/TBBA		o	GHA400207	K
2.0 EcoBoost (176 kW)	2010.07-	Hatchback Engine TPBA	•		GHA340001	K
2.0 FlexFuel (107 kW)	2009.03-	Hatchback Engine TBBA/TBBB	•		GHA340001	K
	2009.03-	Saloon Engine TBBB/TBBA	•		GHA340001	K
2.0 LPG (107 kW)	2009.07-	Hatchback Engine TBBA	•		GHA340001	K
	2009.07-	Saloon Engine TBBA	•		GHA340001	K
2.0 SCTi (149 kW)	2010.03-	Hatchback Engine TNBA	•		GHA340001	K
2.0 TDCi (100 kW)	2007.03-	Hatchback Engine AZBC/UKBA	•		GHA340001	K
	2007.03-	Hatchback Engine AZBC/UKBA		o	GHA400207	K
2.0 TDCi (103 kW)	2007.03-	Hatchback Engine QXBB/UFBA/QXBA	•		GHA340001	K
	2007.03-	Hatchback Engine QXBB/UFBA/QXBA		o	GHA400207	K
	2007.03-	Saloon Engine QXBB/UFBA/QXBA	•		GHA340001	K
	2007.03-	Saloon Engine QXBB/UFBA/QXBA		o	GHA400207	K
2.0 TDCi (120 kW)	2010.03-	Hatchback Engine TXBA	•		GHA340001	K
	2010.03-	Saloon Engine TXBA	•		GHA340001	K
2.0 TDCi (85 kW)	2007.11-	Hatchback Engine KLBA/LPBA/TYBA	•		GHA340001	K
	2007.11-	Hatchback Engine KLBA/LPBA/TYBA		o	GHA400207	K
	2007.11-	Saloon Engine KLBA/LPBA/TYBA	•		GHA340001	K
	2007.11-	Saloon Engine KLBA/LPBA/TYBA		o	GHA400207	K
2.0 TDCi (96 kW)	2007.03-	Hatchback Engine AZBA	•		GHA340001	K
	2007.03-	Hatchback Engine AZBA		o	GHA400207	K
	2007.03-	Saloon Engine AZBA	•		GHA340001	K
	2007.03-	Saloon Engine AZBA		o	GHA400207	K
2.2 TDCi (129 kW)	2008.03-	Hatchback Engine Q4BA	•		GHA340001	K
	2008.03-	Hatchback Engine Q4BA		o	GHA400207	K
	2008.03-	Saloon Engine Q4BA	•		GHA340001	K
	2008.03-	Saloon Engine Q4BA		o	GHA400207	K
2.2 TDCi (147 kW)	2010.07-	Hatchback Engine KNBA	•		GHA340001	K
2.3 (118 kW)	2007.07-	Hatchback Engine SEBA	•		GHA340001	K
	2007.07-	Hatchback Engine SEBA		o	GHA400207	K
	2007.07-	Saloon Engine SEBA	•		GHA340001	K
	2007.07-	Saloon Engine SEBA		o	GHA400207	K
2.5 (162 kW)	2007.03-	Hatchback Engine HUBA	•		GHA340001	K
	2007.03-	Hatchback Engine HUBA		o	GHA400207	K
	2007.03-	Saloon Engine HUBA	•		GHA340001	K
	2007.03-	Saloon Engine HUBA		o	GHA400207	K
MONDEO IV (BA7)						
1.6 TDCi (85 kW)	2010.12-2014.09	Saloon Engine T1BA/T1BB/T1BC	•		GHA340001	K
MONDEO IV TURNIER						
1.6 EcoBoost (118 kW)	2011.02-	Estate Engine JTBA	•		GHA340001	K
1.6 TDCi (85 kW)	2011.02-	Estate Engine T1BB	•		GHA340001	K
1.6 Ti (81 kW)	2007.03-	Estate Engine RHBA	•		GHA340001	K
	2007.03-	Estate Engine RHBA		o	GHA400207	K
1.6 Ti (88 kW)	2010.07-	Estate Engine KGBA	•		GHA340001	K
1.6 Ti (92 kW)	2007.03-	Estate Engine PNBA	•		GHA340001	K
	2007.03-	Estate Engine PNBA		o	GHA400207	K
1.8 TDCi (74 kW)	2007.03-	Estate Engine FFBA	•		GHA340001	K



	 YEAR		F	R	G-AP Ref.	KIT
FORD						
MONDEO IV TURNIER						
1.8 TDCi (74 kW)	2007.03-	Estate Engine FFBA		o	GHA400207	K
1.8 TDCi (92 kW)	2007.06-	Estate Engine KHBA/QYBA	•		GHA340001	K
	2007.06-	Estate Engine KHBA/QYBA		o	GHA400207	K
2.0 (107 kW)	2007.03-	Estate Engine AOBA/AOBC/TBBA	•		GHA340001	K
	2007.03-	Estate Engine AOBA/AOBC/TBBA		o	GHA400207	K
2.0 EcoBoost (176 kW)	2010.07-	Estate Engine TPBA	•		GHA340001	K
2.0 FlexFuel (107 kW)	2009.03-	Estate Engine TBBA/TBBB	•		GHA340001	K
2.0 LPG (107 kW)	2009.07-	Estate Engine TBBA	•		GHA340001	K
2.0 SCTi (149 kW)	2010.03-	Estate Engine TNBA	•		GHA340001	K
2.0 TDCi (100 kW)	2007.03-	Estate Engine AZBC/UKBA	•		GHA340001	K
	2007.03-	Estate Engine AZBC/UKBA		o	GHA400207	K
2.0 TDCi (103 kW)	2007.03-	Estate Engine QXBB/QXBB/UFBA	•		GHA340001	K
	2007.03-	Estate Engine QXBB/QXBB/UFBA		o	GHA400207	K
2.0 TDCi (120 kW)	2010.03-	Estate Engine TXBA	•		GHA340001	K
2.0 TDCi (85 kW)	2007.11-	Estate Engine KLBA/LPBA/TYBA	•		GHA340001	K
	2007.11-	Estate Engine KLBA/LPBA/TYBA		o	GHA400207	K
2.0 TDCi (96 kW)	2007.03-	Estate Engine AZBA	•		GHA340001	K
	2007.03-	Estate Engine AZBA		o	GHA400207	K
2.2 TDCi (129 kW)	2008.03-	Estate Engine Q4BA	•		GHA340001	K
	2008.03-	Estate Engine Q4BA		o	GHA400207	K
2.2 TDCi (147 kW)	2010.07-	Estate Engine KNBA	•		GHA340001	K
2.3 (118 kW)	2007.07-	Estate Engine SEBA		o	GHA400207	K
2.5 (162 kW)	2007.03-	Estate Engine HUBA	•		GHA340001	K
	2007.03-	Estate Engine HUBA		o	GHA400207	K
ORION III (GAL)						
1.3 (44 kW)	1990.07-1993.12	Saloon Engine J4B/J6A	•		GHA425004	K
	1990.07-1993.12	Saloon Engine J4B/J6A	•		GWB1431	
	1990.07-1993.12	Saloon Engine J4B/J6A	•		GWB1432	
	1990.07-1993.12	Saloon Engine J4B/J6A		o	GWB1333	
1.4 (52 kW)	1990.07-1993.12	Saloon Engine F6F/F6G	•		GHA425004	K
	1990.07-1993.12	Saloon Engine F6F/F6G	•		GWB1431	
	1990.07-1993.12	Saloon Engine F6F/F6G	•		GWB1432	
	1990.07-1993.12	Saloon Engine F6F/F6G		o	GWB1333	
1.4 (54 kW)	1990.07-1993.12	Saloon Engine FUH	•		GHA425004	K
	1990.07-1993.12	Saloon Engine FUH	•		GWB1431	
	1990.07-1993.12	Saloon Engine FUH	•		GWB1432	
	1990.07-1993.12	Saloon Engine FUH		o	GWB1333	
1.6 (66 kW)	1990.07-1992.12	Saloon Engine LUJ/LUK	•		GHA425004	K
	1990.07-1992.12	Saloon Engine LUJ/LUK	•		GWB1431	
	1990.07-1992.12	Saloon Engine LUJ/LUK	•		GWB1432	
	1990.07-1992.12	Saloon Engine LUJ/LUK		o	GWB1333	
1.6 i (77 kW)	1990.07-1992.09	Saloon Engine LJF	•		GHA425004	K
	1990.07-1992.09	Saloon Engine LJF	•		GWB1431	
	1990.07-1992.09	Saloon Engine LJF	•		GWB1432	
	1990.07-1992.09	Saloon Engine LJF		o	GWB1333	
1.6 i 16V (66 kW)	1992.07-1993.12	Saloon Engine L1E/L1K	•		GHA425004	K
	1992.07-1993.12	Saloon Engine L1E/L1K	•		GWB1432	
	1992.07-1993.12	Saloon Engine L1E/L1K		o	GWB1333	
1.8 D (44 kW)	1990.11-1993.12	Saloon Engine RTE/RTF/RTH	•		GHA425004	K
	1990.11-1993.12	Saloon Engine RTE/RTF/RTH	•		GWB1432	
	1990.11-1993.12	Saloon Engine RTE/RTF/RTH		o	GWB1333	
1.8 i 16V (77 kW)	1992.02-1993.12	Saloon Engine RDA	•		GHA425004	K
	1992.02-1993.12	Saloon Engine RDA	•		GWB1432	
	1992.02-1993.12	Saloon Engine RDA		o	GWB1333	
1.8 i 16V (96 kW)	1992.01-1993.12	Saloon Engine RQB	•		GHA425004	K
	1992.01-1993.12	Saloon Engine RQB	•		GWB1432	
	1992.01-1993.12	Saloon Engine RQB		o	GWB1333	
1.8 TD (66 kW)	1992.03-1993.12	Saloon Engine RFD/RFK	•		GHA425004	K
	1992.03-1993.12	Saloon Engine RFD/RFK	•		GWB1432	
	1992.03-1993.12	Saloon Engine RFD/RFK		o	GWB1333	
PUMA (EC_)						
1.4 16V (66 kW)	1997.11-2000.10	Coupe Engine FHD/FHF	•		GHA425004	K
	1997.11-2000.10	Coupe Engine FHD/FHF	•		GWB1432	
	1997.11-2000.10	Coupe Engine FHD/FHF		o	GWB3666	



	 YEAR		F	R	G-AP Ref.	KIT
FORD						
PUMA (EC_)						
1.6 16V (76 kW)	2000.08-2002.06	Coupe Engine L1W	•		GHA425004	K
	2000.08-2002.06	Coupe Engine L1W	•		GWB1432	
	2000.08-2002.06	Coupe Engine L1W		o	GWB3666	
1.7 16V (92 kW)	1997.03-2002.06	Coupe Engine MHA/MHB	•		GHA425004	K
	1997.03-2002.06	Coupe Engine MHA/MHB	•		GWB1432	
	1997.03-2002.06	Coupe Engine MHA/MHB		o	GWB3666	
1.7 ST (118 kW)	1999.06-2002.06	Coupe	•		GHA425004	K
	1999.06-2002.06	Coupe	•		GWB1432	
	1999.06-2002.06	Coupe		o	GWB3666	
RANGER						
-	1998-2000		•		GHA342001	
	2000-2001	Without ABS	•		GHA327034	
	2000-2002	With ABS	•		GHA327017	
2.5 TDCi 4x4 (105 kW)	2006.05-	Saloon Engine WLAA		o	GWB3950	
2.5 TDDi (105 kW)	2006.05-	Pickup Engine WLAA		o	GWB3950	
3.0 TDCi (115 kW)	2006.05-	Pickup Engine WEAT		o	GWB3950	
3.0 TDCi 4x4 (115 kW)	2006.05-	Pickup Engine WEAT		o	GWB3950	
RANGER (TU_)						
2.5 D (57 kW)	1999.10-2002.04	Pickup Engine WL		o	GWB3950	
2.5 D 4x4 (57 kW)	1999.10-2002.04	Pickup Engine WL	•		GWB3949	
	1999.10-2002.04	Pickup Engine WL	•		GWB7534A	
	1999.10-2002.04	Pickup Engine WL		o	GWB3950	
2.5 TD (62 kW)	2002.04-2006.06	Pickup Engine eWL-T		o	GWB3950	
2.5 TD 4x4 (62 kW)	2002.04-2006.06	Pickup Engine WL-T	•		GWB3949	
	2002.04-2006.06	Pickup Engine WL-T	•		GWB7534A	
	2002.04-2006.06	Pickup Engine WL-T		o	GWB3950	
2.5 TD 4x4 (80 kW)	1999.10-2006.06	Pickup Engine WL-T	•		GWB3949	
	1999.10-2006.06	Pickup Engine WL-T	•		GWB7534A	
	1999.10-2006.06	Pickup Engine WL-T		o	GWB3950	
2.5 TDDi 4x4 (86 kW)	2002.04-2005.09	Pickup	•		GWB3949	
	2002.04-2005.09	Pickup	•		GWB7534A	
	2002.04-2005.09	Pickup		o	GWB3950	
SCORPIO I (GGE)						
2.5 D (51 kW)	1990.10-1992.08	Estate Engine STR		o	GWB0918	
	1990.10-1992.08	Estate Engine STR		o	GWB0919	
SCORPIO II (GFR, GGR)						
2.0 i (85 kW)	1994.10-1998.08	Estate Engine NSD		o	GWB3485	
	1994.10-1998.08	Saloon Engine NSD		o	GWB3485	
2.0 i 16V (100 kW)	1994.10-1998.08	Estate Engine N3A		o	GWB3485	
	1994.10-1998.08	Saloon Engine N3A		o	GWB3485	
2.3 i 16V (108 kW)	1996.06-1998.08	Estate Engine Y5A		o	GWB3485	
	1996.06-1998.08	Saloon Engine Y5A		o	GWB3485	
2.5 TD (85 kW)	1994.10-1998.08	Estate Engine SCC		o	GWB3485	
	1994.10-1998.08	Saloon Engine SCC		o	GWB3485	
2.5 TD (92 kW)	1996.09-1998.08	Estate Engine VM		o	GWB3485	
	1996.09-1998.08	Saloon Engine VM		o	GWB3485	
2.9 i (110 kW)	1995.02-1998.08	Estate Engine BRG		o	GWB3485	
	1995.02-1998.08	Saloon Engine BRG		o	GWB3485	
2.9 i 24V (152 kW)	1994.10-1998.08	Estate Engine BOB		o	GWB3485	
	1994.10-1998.08	Saloon Engine BOB		o	GWB3485	
SIERRA (BNG)						
2.0 4x4 (88 kW)	1990.02-1993.02	Estate Engine N9C		o	GWB0918	
	1990.02-1993.02	Estate Engine N9C		o	GWB0919	
2.0 i DOHC (85 kW)	1991.12-1993.02	Estate Engine N9E	•		GWB0740	
	1991.12-1993.02	Estate Engine N9E	•		GWB0741	
	1991.12-1993.02	Estate Engine N9E	•		GWB1473	
	1991.12-1993.02	Estate Engine N9E		o	GWB0897	
	1991.12-1993.02	Estate Engine N9E		o	GWB0898	
	1991.12-1993.02	Estate Engine N9E		o	GWB0918	
	1991.12-1993.02	Estate Engine N9E		o	GWB0919	
SIERRA (GBC, GBG)						
2.0 16V Cosworth 4x4 (162 kW)	1990.01-1993.02	Hatchback Engine N5D		o	GWB0918	
	1990.01-1993.02	Hatchback Engine N5D		o	GWB0919	
2.0 16V Cosworth 4x4 CAT (162 kW)	1990.01-1993.02	Hatchback Engine N5C		o	GWB0918	



	 YEAR		F	R	G-AP Ref.	KIT
FORD						
SIERRA (GBC, GBG)						
2.0 16V Cosworth 4x4 CAT (162 kW)	1990.01-1993.02	Hatchback Engine N5C		o	GWB0919	
2.0 4x4 (88 kW)	1991.10-1993.03	Hatchback Engine N9C		o	GWB0918	
	1991.10-1993.03	Hatchback Engine N9C		o	GWB0919	
2.0 i DOHC (85 kW)	1991.12-1993.02	Hatchback Engine N9E	•		GWB0740	
	1991.12-1993.02	Hatchback Engine N9E	•		GWB0741	
	1991.12-1993.02	Hatchback Engine N9E	•		GWB1473	
	1991.12-1993.02	Hatchback Engine N9E		o	GWB0897	
	1991.12-1993.02	Hatchback Engine N9E		o	GWB0898	
	1991.12-1993.02	Hatchback Engine N9E		o	GWB0918	
	1991.12-1993.02	Hatchback Engine N9E		o	GWB0919	
SIERRA (GBG, GB4)						
2.0 4x4 (88 kW)	1990.01-1993.02	Saloon Engine N9C		o	GWB0918	
	1990.01-1993.02	Saloon Engine N9C		o	GWB0919	
2.0 4x4 (92 kW)	1990.01-1993.02	Saloon Engine N9C		o	GWB0918	
	1990.01-1993.02	Saloon Engine N9C		o	GWB0919	
2.0 i (88 kW)	1990.01-1993.02	Saloon Engine N9C	•		GWB0740	
	1990.01-1993.02	Saloon Engine N9C	•		GWB0741	
	1990.01-1993.02	Saloon Engine N9C	•		GWB1473	
	1990.01-1993.02	Saloon Engine N9C		o	GWB0897	
	1990.01-1993.02	Saloon Engine N9C		o	GWB0898	
	1990.01-1993.02	Saloon Engine N9C		o	GWB0918	
	1990.01-1993.02	Saloon Engine N9C		o	GWB0919	
	1990.01-1993.02	Saloon Engine N9C		o	GWB0919	
2.0 i (92 kW)	1990.01-1993.02	Saloon Engine N9C	•		GWB0740	
	1990.01-1993.02	Saloon Engine N9C	•		GWB0741	
	1990.01-1993.02	Saloon Engine N9C	•		GWB1473	
	1990.01-1993.02	Saloon Engine N9C		o	GWB0897	
	1990.01-1993.02	Saloon Engine N9C		o	GWB0898	
	1990.01-1993.02	Saloon Engine N9C		o	GWB0918	
	1990.01-1993.02	Saloon Engine N9C		o	GWB0919	
	1990.01-1993.02	Saloon Engine N9C		o	GWB0919	
2.0 i DOHC (85 kW)	1991.12-1993.02	Saloon Engine N9E	•		GWB0740	
	1991.12-1993.02	Saloon Engine N9E	•		GWB0741	
	1991.12-1993.02	Saloon Engine N9E	•		GWB1473	
	1991.12-1993.02	Saloon Engine N9E		o	GWB0897	
	1991.12-1993.02	Saloon Engine N9E		o	GWB0898	
	1991.12-1993.02	Saloon Engine N9E		o	GWB0918	
	1991.12-1993.02	Saloon Engine N9E		o	GWB0919	
	1991.12-1993.02	Saloon Engine N9E		o	GWB0919	
S-MAX						
1.6 EcoBoost (118 kW)	2011.02-	MPV Engine JTWA/JTWB	•		GHA340005	K
	2011.02-	MPV Engine JTWA/JTWB		o	GHA400197	K
1.6 TDCi (85 kW)	2011.02-	MPV Engine T1WA/T1WB	•		GHA340005	K
	2011.02-	MPV Engine T1WA/T1WB		o	GHA400197	K
1.8 TDCi (74 kW)	2007.01-	MPV Engine FFWA	•		GHA340005	K
	2007.01-	MPV Engine FFWA		o	GHA400197	K
1.8 TDCi (92 kW)	2006.05-	MPV Engine QYWA	•		GHA340005	K
	2006.05-	MPV Engine QYWA		o	GHA400197	K
2.0 (107 kW)	2006.05-	MPV Engine AOWA/AOWB	•		GHA340005	K
	2006.05-	MPV Engine AOWA/AOWB		o	GHA400197	K
2.0 EcoBoost (149 kW)	2010.03-	MPV Engine TNWA	•		GHA340005	K
	2010.03-	MPV Engine TNWA		o	GHA400197	K
2.0 EcoBoost (176 kW)	2010.07-	MPV Engine TPWA	•		GHA340005	K
	2010.07-	MPV Engine TPWA		o	GHA400197	K
2.0 FlexFuel (107 kW)	2006.05-	MPV Engine TBWA/TBWB	•		GHA340005	K
	2006.05-	MPV Engine TBWA/TBWB		o	GHA400197	K
2.0 TDCi (100 kW)	2006.05-	MPV Engine AZWC/UKWA	•		GHA340005	K
	2006.05-	MPV Engine AZWC/UKWA		o	GHA400197	K
2.0 TDCi (103 kW)	2006.05-	MPV Engine QXWA/QXWB/QXWC/UFWA	•		GHA340005	K
	2006.05-	MPV Engine QXWA/QXWB/QXWC/UFWA		o	GHA400197	K
2.0 TDCi (120 kW)	2010.03-	MPV Engine TXWA	•		GHA340005	K
	2010.03-	MPV Engine TXWA		o	GHA400197	K
2.0 TDCi (85 kW)	2007.11-	MPV Engine KLWA/TYWA	•		GHA340005	K
	2007.11-	MPV Engine KLWA/TYWA		o	GHA400197	K
2.0 TDCi (96 kW)	2007.05-2008.03	MPV Engine AZWA	•		GHA340005	K
	2007.05-2008.03	MPV Engine AZWA		o	GHA400197	K
2.2 TDCi (129 kW)	2008.03-	MPV Engine Q4WA	•		GHA340005	K



	 YEAR		F	R	G-AP Ref.	KIT
FORD						
S-MAX						
2.2 TDCi (129 kW)	2008.03-	MPV Engine Q4WA		o	GHA400197	K
2.2 TDCi (147 kW)	2010.07-	MPV Engine KNWA	•		GHA340005	K
	2010.07-	MPV Engine KNWA		o	GHA400197	K
2.3 (118 kW)	2007.08-2008.03	MPV Engine SEWA	•		GHA340005	K
	2007.08-2008.03	MPV Engine SEWA		o	GHA400197	K
2.5 ST (162 kW)	2006.05-	MPV Engine HUWA	•		GHA340005	K
	2006.05-	MPV Engine HUWA		o	GHA400197	K
S-MAX (WA6)						
2.0 EcoBoost (146 kW)	2010.07-	MPV Engine TNWB	•		GHA340005	K
STREET KA						
1.6 (70 kW)	2003.03-2005.07	Convertible Engine CDRA/CDRB	•		GHA425004	K
	2003.03-2005.07	Convertible Engine CDRA/CDRB	•		GWB3678	
	2003.03-2005.07	Convertible Engine CDRA/CDRB		o	GWB3666	
TOURNEO CONNECT						
1.8 16V (85 kW)	2002.06-	MPV Engine EYPA/EYPC/EYPD	•		GWB6520	
	2002.06-	MPV Engine EYPA/EYPC/EYPD	•		GWB6731	
	2002.06-	MPV Engine EYPA/EYPC/EYPD		o	GHA237016	K
1.8 Di (55 kW)	2002.06-	MPV Engine BHPA/P7PA/P7PB/R2PA	•		GWB6520	
	2002.06-	MPV Engine BHPA/P7PA/P7PB/R2PA	•		GWB6731	
	2002.06-	MPV Engine BHPA/P7PA/P7PB/R2PA		o	GHA237016	K
1.8 TDCi (81 kW)	2006.08-	MPV Engine RWPA/RWPC/RWPD	•		GWB6520	
	2006.08-	MPV Engine RWPA/RWPC/RWPD	•		GWB6731	
	2006.08-	MPV Engine RWPA/RWPC/RWPD		o	GHA237016	K
1.8 Turbo Di (66 kW)	2002.06-	MPV Engine HCPA/HCPB/P9PA/P9PB/P9PC/P9PD/R3PA/RWPE/RWPF	•		GWB6520	
	2002.06-	MPV Engine HCPA/HCPB/P9PA/P9PB/P9PC/P9PD/R3PA/RWPE/RWPF	•		GWB6731	
	2002.06-	MPV Engine HCPA/HCPB/P9PA/P9PB/P9PC/P9PD/R3PA/RWPE/RWPF		o	GHA237016	K
Electric (58 kW)	2011.09-2013.12	MPV	•		GWB6731	
	2011.09-2013.12	MPV		o	GHA237016	K
TOURNEO COURIER Kombi						
1.0 EcoBoost (74 kW)	2014.02-		•		GWB6653	
	2014.02-			o	GHA400336	K
1.5 TDCi (55 kW)	2014.02-		•		GWB6653	
	2014.02-			o	GHA400336	K
TOURNEO COURIER KOMBI						
1.5 TDCi (70 kW)	2015.05-	Estate Engine XVCA/XVCB/XVCC	•		GWB6653	
TOURNEO COURIER Kombi						
1.6 TDCi (70 kW)	2014.02-		•		GWB6653	
	2014.02-			o	GHA400336	K
TRANSIT						
2.2 TDCi (100 kW)	2011.09-	Bus Engine USRA/USRB	•		GHA245008	K
	2011.09-	Bus Engine USRA/USRB	•		GHA249001	K
2.2 TDCi (103 kW)	2007.10-	Box Engine PGFA/PGFB/UHFA/UHFB/UHFB	•		GHA245008	K
	2007.10-	Box Engine PGFA/PGFB/UHFA/UHFB/UHFB	•		GHA249001	K
	2007.10-	Box Engine PGFA/PGFB/UHFA/UHFB/UHFB		o	GHA237010	K
	2007.10-	Box Engine PGFA/PGFB/UHFA/UHFB/UHFB		o	GHA245015	K
	2007.10-	Box Engine PGFA/PGFB/UHFA/UHFB/UHFB Without ABS		o	GHA237015	K
	2007.10-	Bus Engine PGFA/PGFB/UHFA/UHFB/UHFC	•		GHA245008	K
	2007.10-	Bus Engine PGFA/PGFB/UHFA/UHFB/UHFC	•		GHA249001	K
	2007.10-	Bus Engine PGFA/PGFB/UHFA/UHFB/UHFC		o	GHA237010	K
	2007.10-	Bus Engine PGFA/PGFB/UHFA/UHFB/UHFC		o	GHA245015	K
	2007.10-	Bus Engine PGFA/PGFB/UHFA/UHFB/UHFC Without ABS		o	GHA237015	K
	2007.10-	Platform/Chassis Engine PGFA/PGFB	•		GHA245008	K
	2007.10-	Platform/Chassis Engine PGFA/PGFB	•		GHA249001	K
	2007.10-	Platform/Chassis Engine PGFA/PGFB		o	GHA237010	K
	2007.10-	Platform/Chassis Engine PGFA/PGFB		o	GHA245015	K
	2007.10-	Platform/Chassis Engine PGFA/PGFB Without ABS		o	GHA237015	K
2.2 TDCi (114 kW)	2011.10-	Box Engine CVRB/CVRA/CVRC	•		GHA245008	K
	2011.10-	Box Engine CVRB/CVRA/CVRC	•		GHA249001	K
	2011.10-	Box Engine CVRB/CVRA/CVRC		o	GHA237010	K
	2011.10-	Box Engine CVRB/CVRA/CVRC		o	GHA245015	K
	2011.10-	Box Engine CVRB/CVRA/CVRC Without ABS		o	GHA237015	K
	2011.10-	Platform/Chassis Engine CVRA/CVRB/CVRC	•		GHA245008	K
	2011.10-	Platform/Chassis Engine CVRA/CVRB/CVRC	•		GHA249001	K
2.2 TDCi (63 kW)	2006.04-	Box Engine P8FA/P8FB	•		GHA245008	K



	 YEAR		F	R	G-AP Ref.	KIT	
FORD TRANSIT							
2.2 TDCi (63 kW)	2006.04-	Box Engine P8FA/P8FB	•		GHA249001	K	
	2006.04-	Box Engine P8FA/P8FB		◦	GHA237010	K	
	2006.04-	Box Engine P8FA/P8FB		◦	GHA245015	K	
	2006.04-	Box Engine P8FA/P8FB Without ABS		◦	GHA237015	K	
	2006.04-	Bus Engine P8FA/P8FB	•		GHA245008	K	
	2006.04-	Bus Engine P8FA/P8FB	•		GHA249001	K	
	2006.04-	Bus Engine P8FA/P8FB		◦	GHA237010	K	
	2006.04-	Bus Engine P8FA/P8FB		◦	GHA245015	K	
	2006.04-	Bus Engine P8FA/P8FB Without ABS		◦	GHA237015	K	
	2006.04-	Platform/Chassis Engine P8FA/P8FB	•		GHA245008	K	
	2006.04-	Platform/Chassis Engine P8FA/P8FB	•		GHA249001	K	
	2006.04-	Platform/Chassis Engine P8FA/P8FB		◦	GHA237010	K	
	2006.04-	Platform/Chassis Engine P8FA/P8FB		◦	GHA245015	K	
	2006.04-	Platform/Chassis Engine P8FA/P8FB Without ABS		◦	GHA237015	K	
	2.2 TDCi (74 kW)	2011.10-	Box Engine DRFE/DRFA/DRFB/DRFC/DRFD	•		GHA245008	K
		2011.10-	Box Engine DRFE/DRFA/DRFB/DRFC/DRFD	•		GHA249001	K
		2011.10-	Box Engine DRFE/DRFA/DRFB/DRFC/DRFD		◦	GHA237010	K
		2011.10-	Box Engine DRFE/DRFA/DRFB/DRFC/DRFD		◦	GHA245015	K
		2011.10-	Box Engine DRFE/DRFA/DRFB/DRFC/DRFD Without ABS		◦	GHA237015	K
		2011.10-	Box Engine DRRC/DRRB/DRRA	•		GHA245008	K
2011.10-		Box Engine DRRC/DRRB/DRRA	•		GHA249001	K	
2011.10-		Box Engine DRRC/DRRB/DRRA		◦	GHA237010	K	
2011.10-		Box Engine DRRC/DRRB/DRRA		◦	GHA245015	K	
2011.10-		Box Engine DRRC/DRRB/DRRA Without ABS		◦	GHA237015	K	
2011.10-		Bus Engine DRFA/DRFB/DRFC/DRFD/DRFE	•		GHA245008	K	
2011.10-		Bus Engine DRFA/DRFB/DRFC/DRFD/DRFE	•		GHA249001	K	
2011.10-		Bus Engine DRFA/DRFB/DRFC/DRFD/DRFE		◦	GHA237010	K	
2011.10-		Bus Engine DRFA/DRFB/DRFC/DRFD/DRFE		◦	GHA245015	K	
2011.10-		Bus Engine DRFA/DRFB/DRFC/DRFD/DRFE Without ABS		◦	GHA237015	K	
2011.10-		Bus Engine DRRA/DRRB/DRRC	•		GHA245008	K	
2011.10-		Bus Engine DRRA/DRRB/DRRC	•		GHA249001	K	
2011.10-		Platform/Chassis Engine DRFD/DRFA/DRFB/DRFC/DRFE	•		GHA245008	K	
2011.10-		Platform/Chassis Engine DRFD/DRFA/DRFB/DRFC/DRFE	•		GHA249001	K	
2011.10-		Platform/Chassis Engine DRFD/DRFA/DRFB/DRFC/DRFE		◦	GHA237010	K	
2011.10-		Platform/Chassis Engine DRFD/DRFA/DRFB/DRFC/DRFE		◦	GHA245015	K	
2011.10-		Platform/Chassis Engine DRFD/DRFA/DRFB/DRFC/DRFE Without ABS		◦	GHA237015	K	
2011.10-		Platform/Chassis Engine DRRC/DRRA/DRRB	•		GHA245008	K	
2011.10-		Platform/Chassis Engine DRRC/DRRA/DRRB	•		GHA249001	K	
2.2 TDCi (81 kW)		2006.04-	Box Engine QVFA	•		GHA245008	K
		2006.04-	Box Engine QVFA	•		GHA249001	K
		2006.04-	Box Engine QVFA		◦	GHA237010	K
		2006.04-	Box Engine QVFA		◦	GHA245015	K
	2006.04-	Box Engine QVFA Without ABS		◦	GHA237015	K	
	2006.04-	Bus Engine QVFA	•		GHA245008	K	
	2006.04-	Bus Engine QVFA	•		GHA249001	K	
	2006.04-	Bus Engine QVFA		◦	GHA237010	K	
	2006.04-	Bus Engine QVFA		◦	GHA245015	K	
	2006.04-	Bus Engine QVFA Without ABS		◦	GHA237015	K	
	2006.04-	Platform/Chassis Engine QVFA	•		GHA245008	K	
	2006.04-	Platform/Chassis Engine QVFA	•		GHA249001	K	
	2006.04-	Platform/Chassis Engine QVFA		◦	GHA237010	K	
	2006.04-	Platform/Chassis Engine QVFA		◦	GHA245015	K	
2006.04-	Platform/Chassis Engine QVFA Without ABS		◦	GHA237015	K		
2.2 TDCi (85 kW)	2008.10-	Box Engine SRFA/SRFB/SRFC/SRFD/SRFE	•		GHA245008	K	
	2008.10-	Box Engine SRFA/SRFB/SRFC/SRFD/SRFE	•		GHA249001	K	
	2008.10-	Box Engine SRFA/SRFB/SRFC/SRFD/SRFE		◦	GHA237010	K	
	2008.10-	Box Engine SRFA/SRFB/SRFC/SRFD/SRFE		◦	GHA245015	K	
	2008.10-	Box Engine SRFA/SRFB/SRFC/SRFD/SRFE Without ABS		◦	GHA237015	K	
	2008.10-	Bus Engine SRFA/SRFB/SRFC/SRFE/SRFD	•		GHA245008	K	
	2008.10-	Bus Engine SRFA/SRFB/SRFC/SRFE/SRFD	•		GHA249001	K	
	2008.10-	Bus Engine SRFA/SRFB/SRFC/SRFE/SRFD		◦	GHA237010	K	
	2008.10-	Bus Engine SRFA/SRFB/SRFC/SRFE/SRFD		◦	GHA245015	K	
	2008.10-	Bus Engine SRFA/SRFB/SRFC/SRFE/SRFD Without ABS		◦	GHA237015	K	
	2008.10-	Platform/Chassis Engine SRFA/SRFB/SRFC/SRFD/SRFE	•		GHA245008	K	
	2008.10-	Platform/Chassis Engine SRFA/SRFB/SRFC/SRFD/SRFE	•		GHA249001	K	



	 YEAR		F	R	G-AP Ref.	KIT
FORD TRANSIT						
2.2 TDCi (85 kW)	2008.10-	Platform/Chassis Engine SRFA/SRFB/SRFC/SRFD/SRFE		o	GHA237010	K
	2008.10-	Platform/Chassis Engine SRFA/SRFB/SRFC/SRFD/SRFE		o	GHA245015	K
	2008.10-	Platform/Chassis Engine SRFA/SRFB/SRFC/SRFD/SRFE Without ABS		o	GHA237015	K
2.2 TDCi (92 kW)	2011.10-	Box Engine CYFD/CYFA/CYFB/CYFC	•		GHA245008	K
	2011.10-	Box Engine CYFD/CYFA/CYFB/CYFC	•		GHA249001	K
	2011.10-	Box Engine CYFD/CYFA/CYFB/CYFC		o	GHA237010	K
	2011.10-	Box Engine CYFD/CYFA/CYFB/CYFC		o	GHA245015	K
	2011.10-	Box Engine CYFD/CYFA/CYFB/CYFC Without ABS		o	GHA237015	K
	2011.10-	Box Engine CYRA	•		GHA245008	K
	2011.10-	Box Engine CYRA	•		GHA249001	K
	2011.10-	Box Engine CYRA		o	GHA237010	K
	2011.10-	Box Engine CYRA		o	GHA245015	K
	2011.10-	Box Engine CYRA Without ABS		o	GHA237015	K
	2011.10-	Bus Engine CYFA/CYFB/CYFC/CYFD	•		GHA245008	K
	2011.10-	Bus Engine CYFA/CYFB/CYFC/CYFD	•		GHA249001	K
	2011.10-	Bus Engine CYFA/CYFB/CYFC/CYFD		o	GHA237010	K
	2011.10-	Bus Engine CYFA/CYFB/CYFC/CYFD		o	GHA245015	K
	2011.10-	Bus Engine CYFA/CYFB/CYFC/CYFD Without ABS		o	GHA237015	K
	2011.10-	Bus Engine CYRA	•		GHA245008	K
	2011.10-	Bus Engine CYRA	•		GHA249001	K
	2011.10-	Platform/Chassis Engine CYFD/CYFA/CYFB/CYFC	•		GHA245008	K
	2011.10-	Platform/Chassis Engine CYFD/CYFA/CYFB/CYFC	•		GHA249001	K
	2011.10-	Platform/Chassis Engine CYFD/CYFA/CYFB/CYFC		o	GHA237010	K
	2011.10-	Platform/Chassis Engine CYFD/CYFA/CYFB/CYFC		o	GHA245015	K
	2011.10-	Platform/Chassis Engine CYFD/CYFA/CYFB/CYFC Without ABS		o	GHA237015	K
	2011.10-	Platform/Chassis Engine CYRA	•		GHA245008	K
	2011.10-	Platform/Chassis Engine CYRA	•		GHA249001	K
2.2 TDCi (96 kW)	2006.04-	Box Engine QWFA	•		GHA245008	K
	2006.04-	Box Engine QWFA	•		GHA249001	K
	2006.04-	Box Engine QWFA		o	GHA237010	K
	2006.04-	Box Engine QWFA		o	GHA245015	K
	2006.04-	Box Engine QWFA Without ABS		o	GHA237015	K
	2006.04-	Bus Engine QWFA	•		GHA245008	K
	2006.04-	Bus Engine QWFA	•		GHA249001	K
	2006.04-	Bus Engine QWFA		o	GHA237010	K
	2006.04-	Bus Engine QWFA		o	GHA245015	K
	2006.04-	Bus Engine QWFA Without ABS		o	GHA237015	K
	2006.04-	Platform/Chassis Engine QWFA	•		GHA245008	K
	2006.04-	Platform/Chassis Engine QWFA	•		GHA249001	K
	2006.04-	Platform/Chassis Engine QWFA		o	GHA237010	K
	2006.04-	Platform/Chassis Engine QWFA		o	GHA245015	K
	2006.04-	Platform/Chassis Engine QWFA Without ABS		o	GHA237015	K
2.2 TDCi [RWD] (100 kW)	2011.10-2014.08	Box Engine USRA/USRB	•		GHA245008	K
	2011.10-2014.08	Box Engine USRA/USRB	•		GHA249001	K
	2011.10-2014.08	Box Engine USRA/USRB		o	GHA237010	K
	2011.10-2014.08	Box Engine USRA/USRB		o	GHA245015	K
	2011.10-2014.08	Box Engine USRA/USRB Without ABS		o	GHA237015	K
2.2 TDCi 4x4 (92 kW)	2011.10-	Box Engine CYRB/CYRC	•		GHA245008	K
	2011.10-	Box Engine CYRB/CYRC	•		GHA249001	K
	2011.10-	Box Engine CYRB/CYRC		o	GHA237010	K
	2011.10-	Box Engine CYRB/CYRC		o	GHA245015	K
	2011.10-	Box Engine CYRB/CYRC Without ABS		o	GHA237015	K
2.3 16V (107 kW)	2006.04-	Box Engine GZFA/GZFC	•		GHA245008	K
	2006.04-	Box Engine GZFA/GZFC	•		GHA249001	K
	2006.04-	Box Engine GZFA/GZFC		o	GHA237010	K
	2006.04-	Box Engine GZFA/GZFC		o	GHA245015	K
	2006.04-	Box Engine GZFA/GZFC Without ABS		o	GHA237015	K
	2006.04-	Platform/Chassis Engine GZFA/GZFC	•		GHA245008	K
	2006.04-	Platform/Chassis Engine GZFA/GZFC	•		GHA249001	K
	2006.04-	Platform/Chassis Engine GZFA/GZFC		o	GHA237010	K
	2006.04-	Platform/Chassis Engine GZFA/GZFC		o	GHA245015	K
	2006.04-	Platform/Chassis Engine GZFA/GZFC Without ABS		o	GHA237015	K
2.3 16V CNG [RWD] (100 kW)	2006.04-2014.08	Box Engine GZFA	•		GHA245008	K
	2006.04-2014.08	Box Engine GZFA	•		GHA249001	K
	2006.04-2014.08	Platform/Chassis Engine GZFA	•		GHA245008	K



	 YEAR		F	R	G-AP Ref.	KIT
FORD TRANSIT						
2.3 16V CNG [RWD] (100 kW)	2006.04-2014.08	Platform/Chassis Engine GZFA	•		GHA249001	K
2.3 16V LPG [RWD] (107 kW)	2006.04-2014.08	Box Engine GZFA	•		GHA245008	K
	2006.04-2014.08	Box Engine GZFA	•		GHA249001	K
	2006.04-2014.08	Platform/Chassis Engine GZFA	•		GHA245008	K
	2006.04-2014.08	Platform/Chassis Engine GZFA	•		GHA249001	K
	2006.04-2014.08	Platform/Chassis Engine GZFA	•		GHA249001	K
2.4 TDCi (103 kW)	2006.04-	Box Engine H9FD	•		GHA245008	K
	2006.04-	Box Engine H9FD	•		GHA249001	K
	2006.04-	Box Engine H9FD		o	GHA237010	K
	2006.04-	Box Engine H9FD		o	GHA245015	K
	2006.04-	Box Engine H9FD Without ABS		o	GHA237015	K
	2006.04-	Bus Engine H9FD	•		GHA245008	K
	2006.04-	Bus Engine H9FD	•		GHA249001	K
	2006.04-	Bus Engine H9FD		o	GHA237010	K
	2006.04-	Bus Engine H9FD		o	GHA245015	K
	2006.04-	Bus Engine H9FD Without ABS		o	GHA237015	K
	2006.04-	Platform/Chassis Engine H9FD	•		GHA245008	K
	2006.04-	Platform/Chassis Engine H9FD	•		GHA249001	K
	2006.04-	Platform/Chassis Engine H9FD		o	GHA237010	K
	2006.04-	Platform/Chassis Engine H9FD		o	GHA245015	K
	2006.04-	Platform/Chassis Engine H9FD Without ABS		o	GHA237015	K
2.4 TDCi (74 kW)	2006.04-	Box Engine PHFA/PHFC	•		GHA245008	K
	2006.04-	Box Engine PHFA/PHFC	•		GHA249001	K
	2006.04-	Box Engine PHFA/PHFC		o	GHA237010	K
	2006.04-	Box Engine PHFA/PHFC		o	GHA245015	K
	2006.04-	Box Engine PHFA/PHFC Without ABS		o	GHA237015	K
	2006.04-	Bus Engine PHFA/PHFC	•		GHA245008	K
	2006.04-	Bus Engine PHFA/PHFC	•		GHA249001	K
	2006.04-	Bus Engine PHFA/PHFC		o	GHA237010	K
	2006.04-	Bus Engine PHFA/PHFC		o	GHA245015	K
	2006.04-	Bus Engine PHFA/PHFC Without ABS		o	GHA237015	K
	2006.04-	Platform/Chassis Engine PHFA/PHFC	•		GHA245008	K
	2006.04-	Platform/Chassis Engine PHFA/PHFC	•		GHA249001	K
	2006.04-	Platform/Chassis Engine PHFA/PHFC		o	GHA237010	K
	2006.04-	Platform/Chassis Engine PHFA/PHFC		o	GHA245015	K
	2006.04-	Platform/Chassis Engine PHFA/PHFC Without ABS		o	GHA237015	K
2.4 TDCi (85 kW)	2006.04-	Box Engine JXFA/JXFC	•		GHA245008	K
	2006.04-	Box Engine JXFA/JXFC	•		GHA249001	K
	2006.04-	Box Engine JXFA/JXFC		o	GHA237010	K
	2006.04-	Box Engine JXFA/JXFC		o	GHA245015	K
	2006.04-	Box Engine JXFA/JXFC Without ABS		o	GHA237015	K
	2006.04-	Bus Engine JXFA/JXFC	•		GHA245008	K
	2006.04-	Bus Engine JXFA/JXFC	•		GHA249001	K
	2006.04-	Bus Engine JXFA/JXFC		o	GHA237010	K
	2006.04-	Bus Engine JXFA/JXFC		o	GHA245015	K
	2006.04-	Bus Engine JXFA/JXFC Without ABS		o	GHA237015	K
	2006.04-	Platform/Chassis Engine JXFA/JXFC	•		GHA245008	K
	2006.04-	Platform/Chassis Engine JXFA/JXFC	•		GHA249001	K
	2006.04-	Platform/Chassis Engine JXFA/JXFC		o	GHA237010	K
	2006.04-	Platform/Chassis Engine JXFA/JXFC		o	GHA245015	K
	2006.04-	Platform/Chassis Engine JXFA/JXFC Without ABS		o	GHA237015	K
3.2 TDCi (147 kW)	2007.09-	Box Engine SAFA/SAFB	•		GHA245008	K
	2007.09-	Box Engine SAFA/SAFB	•		GHA249001	K
	2007.09-	Box Engine SAFA/SAFB		o	GHA237010	K
	2007.09-	Box Engine SAFA/SAFB		o	GHA245015	K
	2007.09-	Box Engine SAFA/SAFB Without ABS		o	GHA237015	K
	2007.09-	Platform/Chassis Engine SAFA/SAFB	•		GHA245008	K
	2007.09-	Platform/Chassis Engine SAFA/SAFB	•		GHA249001	K
	2007.09-	Platform/Chassis Engine SAFA/SAFB		o	GHA237010	K
	2007.09-	Platform/Chassis Engine SAFA/SAFB		o	GHA245015	K
	2007.09-	Platform/Chassis Engine SAFA/SAFB Without ABS		o	GHA237015	K
	2008.02-	Bus Engine SAFA/SAFB	•		GHA245008	K
	2008.02-	Bus Engine SAFA/SAFB	•		GHA249001	K
	2008.02-	Bus Engine SAFA/SAFB		o	GHA237010	K
	2008.02-	Bus Engine SAFA/SAFB		o	GHA245015	K
	2008.02-	Bus Engine SAFA/SAFB Without ABS		o	GHA237015	K



	 YEAR		F	R	G-AP Ref.	KIT
FORD TRANSIT (E_ _)						
2.0 (66 kW)	1991.09-1994.06	Box Engine NBA	•		GWB1465	
	1991.09-1994.06	Box Engine NBA		o	GWB1466	
	1991.09-1994.06	Box Engine NBA		o	GWB1467	
	1991.09-1994.09	Bus Engine NBA	•		GWB1465	
	1991.09-1994.09	Bus Engine NBA		o	GWB1466	
	1991.09-1994.09	Bus Engine NBA		o	GWB1467	
2.0 (72 kW)	1991.09-1994.08	Platform/Chassis Engine NCA	•		GWB1465	
	1991.09-1994.08	Platform/Chassis Engine NCA		o	GWB1466	
	1991.09-1994.08	Platform/Chassis Engine NCA		o	GWB1467	
2.0 (84 kW)	1994.06-2000.03	Box Engine NSF/NSG	•		GWB1465	
	1994.06-2000.03	Box Engine NSF/NSG		o	GWB1466	
	1994.06-2000.03	Box Engine NSF/NSG		o	GWB1467	
	1994.08-2000.03	Platform/Chassis Engine NSF/NSG	•		GWB1465	
	1994.08-2000.03	Platform/Chassis Engine NSF/NSG		o	GWB1466	
	1994.08-2000.03	Platform/Chassis Engine NSF/NSG		o	GWB1467	
	1995.09-2000.03	Bus Engine NSF/NSG	•		GWB1465	
	1995.09-2000.03	Bus Engine NSF/NSG		o	GWB1466	
	1995.09-2000.03	Bus Engine NSF/NSG		o	GWB1467	
2.0 CNG (84 kW)	1994.06-2000.03	Bus Engine NSH	•		GWB1465	
	1994.06-2000.03	Bus Engine NSH		o	GWB1466	
	1994.06-2000.03	Bus Engine NSH		o	GWB1467	
2.0 i (72 kW)	1991.09-1994.06	Box Engine NCA	•		GWB1465	
	1991.09-1994.06	Box Engine NCA		o	GWB1466	
	1991.09-1994.06	Box Engine NCA		o	GWB1467	
	1991.09-1994.07	Bus Engine NCA	•		GWB1465	
	1991.09-1994.07	Bus Engine NCA		o	GWB1466	
	1991.09-1994.07	Bus Engine NCA		o	GWB1467	
2.5 Di (51 kW)	1991.05-1994.06	Box Engine 4BC/4CC/4FA	•		GWB1465	
	1991.05-1994.06	Box Engine 4BC/4CC/4FA		o	GWB1466	
	1991.05-1994.06	Box Engine 4BC/4CC/4FA		o	GWB1467	
	1991.08-1994.07	Bus Engine 4BC/4CC/4FA	•		GWB1465	
	1991.08-1994.07	Bus Engine 4BC/4CC/4FA		o	GWB1466	
	1991.08-1994.07	Bus Engine 4BC/4CC/4FA		o	GWB1467	
	1991.09-1994.08	Platform/Chassis Engine 4BC/4CC/4FA	•		GWB1465	
	1991.09-1994.08	Platform/Chassis Engine 4BC/4CC/4FA		o	GWB1466	
	1991.09-1994.08	Platform/Chassis Engine 4BC/4CC/4FA		o	GWB1467	
	1994.06-2000.03	Box Engine 4FA/4FB/4FC/4FD	•		GWB1465	
	1994.06-2000.03	Box Engine 4FA/4FB/4FC/4FD		o	GWB1466	
	1994.06-2000.03	Box Engine 4FA/4FB/4FC/4FD		o	GWB1467	
	1994.08-2000.03	Bus Engine 4FA/4FB/4FC/4FD	•		GWB1465	
	1994.08-2000.03	Bus Engine 4FA/4FB/4FC/4FD		o	GWB1466	
	1994.08-2000.03	Bus Engine 4FA/4FB/4FC/4FD		o	GWB1467	
	1994.08-2000.03	Platform/Chassis Engine 4FA/4FB/4FC/4FD	•		GWB1465	
	1994.08-2000.03	Platform/Chassis Engine 4FA/4FB/4FC/4FD		o	GWB1466	
	1994.08-2000.03	Platform/Chassis Engine 4FA/4FB/4FC/4FD		o	GWB1467	
2.5 Di (56 kW)	1994.06-2000.03	Box Engine 4HB/4HC	•		GWB1465	
	1994.06-2000.03	Box Engine 4HB/4HC		o	GWB1466	
	1994.06-2000.03	Box Engine 4HB/4HC		o	GWB1467	
	1994.07-2000.03	Bus Engine 4HB/4HC	•		GWB1465	
	1994.07-2000.03	Bus Engine 4HB/4HC		o	GWB1466	
	1994.07-2000.03	Bus Engine 4HB/4HC		o	GWB1467	
	1994.08-2000.03	Platform/Chassis Engine 4HB/4HC	•		GWB1465	
	1994.08-2000.03	Platform/Chassis Engine 4HB/4HC		o	GWB1466	
	1994.08-2000.03	Platform/Chassis Engine 4HB/4HC		o	GWB1467	
2.5 Di (59 kW)	1991.05-1994.06	Box Engine 4DA	•		GWB1465	
	1991.05-1994.06	Box Engine 4DA		o	GWB1466	
	1991.05-1994.06	Box Engine 4DA		o	GWB1467	
	1991.09-1994.07	Bus Engine 4DA	•		GWB1465	
	1991.09-1994.07	Bus Engine 4DA		o	GWB1466	
	1991.09-1994.07	Bus Engine 4DA		o	GWB1467	
	1991.09-1994.08	Platform/Chassis Engine 4DA	•		GWB1465	
	1991.09-1994.08	Platform/Chassis Engine 4DA		o	GWB1466	
2.5 Di (63 kW)	1992.10-1994.06	Box Engine 4GA	•		GWB1465	
	1992.10-1994.06	Box Engine 4GA		o	GWB1466	



	 YEAR		F	R	G-AP Ref.	KIT
FORD						
TRANSIT (E_ _)						
2.5 Di (63 kW)	1992.10-1994.06	Box Engine 4GA		o	GWB1467	
2.5 Di (85 kW)	1997.08-2000.03	Bus Engine 4ED	•		GWB1465	
	1997.08-2000.03	Bus Engine 4ED		o	GWB1466	
	1997.08-2000.03	Bus Engine 4ED		o	GWB1467	
	1999.05-2000.03	Platform/Chassis Engine 4ED	•		GWB1465	
	1999.05-2000.03	Platform/Chassis Engine 4ED		o	GWB1466	
	1999.05-2000.03	Platform/Chassis Engine 4ED		o	GWB1467	
	2.5 TD (55 kW)	1994.08-2000.06	Bus Engine 4HA/4HD	•		GWB1465
1994.08-2000.06		Bus Engine 4HA/4HD		o	GWB1466	
1994.08-2000.06		Bus Engine 4HA/4HD		o	GWB1467	
1998.10-2000.07		Platform/Chassis Engine 4HA/4HD	•		GWB1465	
1998.10-2000.07		Platform/Chassis Engine 4HA/4HD		o	GWB1466	
1998.10-2000.07		Platform/Chassis Engine 4HA/4HD		o	GWB1467	
2.5 TD (63 kW)	1992.10-1994.07	Bus Engine 4GA/4GB/4GC	•		GWB1465	
	1992.10-1994.07	Bus Engine 4GA/4GB/4GC		o	GWB1466	
	1992.10-1994.07	Bus Engine 4GA/4GB/4GC		o	GWB1467	
	1992.11-1994.08	Platform/Chassis Engine 4GA	•		GWB1465	
	1992.11-1994.08	Platform/Chassis Engine 4GA		o	GWB1466	
	1992.11-1994.08	Platform/Chassis Engine 4GA		o	GWB1467	
	1994.08-2000.03	Platform/Chassis Engine 4GA/4GB/4GC/4GD/4GE/4GF	•		GWB1465	
	1994.08-2000.03	Platform/Chassis Engine 4GA/4GB/4GC/4GD/4GE/4GF		o	GWB1466	
	1994.08-2000.03	Platform/Chassis Engine 4GA/4GB/4GC/4GD/4GE/4GF		o	GWB1467	
	1995.01-2000.03	Bus Engine 4GA/4GB/4GC/4GD/4GE/4GF	•		GWB1465	
	1995.01-2000.03	Bus Engine 4GA/4GB/4GC/4GD/4GE/4GF		o	GWB1466	
	1995.01-2000.03	Bus Engine 4GA/4GB/4GC/4GD/4GE/4GF		o	GWB1467	
	2.5 TD (74 kW)	1991.09-1994.07	Bus Engine 4EA	•		GWB1465
1991.09-1994.07		Bus Engine 4EA		o	GWB1466	
1991.09-1994.07		Bus Engine 4EA		o	GWB1467	
1991.09-1994.08		Platform/Chassis Engine 4EA	•		GWB1465	
1991.09-1994.08		Platform/Chassis Engine 4EA		o	GWB1466	
1991.09-1994.08		Platform/Chassis Engine 4EA		o	GWB1467	
1994.07-2000.03		Bus Engine 4EB/4EC	•		GWB1465	
1994.07-2000.03		Bus Engine 4EB/4EC		o	GWB1466	
1994.07-2000.03		Bus Engine 4EB/4EC		o	GWB1467	
1994.08-2000.03		Platform/Chassis Engine 4EB/4EC	•		GWB1465	
1994.08-2000.03		Platform/Chassis Engine 4EB/4EC		o	GWB1466	
1994.08-2000.03		Platform/Chassis Engine 4EB/4EC		o	GWB1467	
2.9 i (107 kW)		1991.01-1994.09	Bus Engine BRT	•		GWB1465
	1991.01-1994.09	Bus Engine BRT		o	GWB1466	
	1991.01-1994.09	Bus Engine BRT		o	GWB1467	
TRANSIT (FA_ _)						
2.4 TD (88 kW)	2000.08-2003.08	Box Engine F4FA	•		GHA245009	K
	2000.08-2003.08	Box Engine F4FA		o	GHA245016	K
	2000.08-2003.08	Box Engine F4FA With ABS		o	GHA237017	K
	2000.08-2003.08	Box Engine F4FA Without ABS		o	GHA237015	K
TRANSIT (FD_ _, FB_ _, FS_ _, FZ_ _, FC_ _)						
2.0 Di (55 kW)	2000.08-2006.05	Bus Engine D3FA	•		GHA245009	K
	2000.08-2006.05	Bus Engine D3FA		o	GHA245016	K
	2000.08-2006.05	Bus Engine D3FA With ABS		o	GHA237017	K
	2000.08-2006.05	Bus Engine D3FA Without ABS		o	GHA237015	K
2.0 Di (63 kW)	2000.08-2006.05	Bus Engine F3FA	•		GHA245009	K
	2000.08-2006.05	Bus Engine F3FA		o	GHA245016	K
	2000.08-2006.05	Bus Engine F3FA With ABS		o	GHA237017	K
	2000.08-2006.05	Bus Engine F3FA Without ABS		o	GHA237015	K
2.0 Di (74 kW)	2000.08-2006.05	Bus Engine ABFA	•		GHA245009	K
	2000.08-2006.05	Bus Engine ABFA		o	GHA245016	K
	2000.08-2006.05	Bus Engine ABFA With ABS		o	GHA237017	K
	2000.08-2006.05	Bus Engine ABFA Without ABS		o	GHA237015	K
2.0 TDCi (92 kW)	2002.08-2006.05	Bus Engine FIFA	•		GHA245009	K
	2002.08-2006.05	Bus Engine FIFA		o	GHA245016	K
	2002.08-2006.05	Bus Engine FIFA With ABS		o	GHA237017	K
	2002.08-2006.05	Bus Engine FIFA Without ABS		o	GHA237015	K
2.3 (107 kW)	2000.08-2006.03	Bus Engine E5FA	•		GHA245009	K
	2000.08-2006.03	Bus Engine E5FA		o	GHA245016	K



	 YEAR		F	R	G-AP Ref.	KIT
FORD						
TRANSIT (FD_, FB_, FS_, FZ_, FC_) 						
2.3 (107 kW)	2000.08-2006.03	Bus Engine E5FA With ABS		o	GHA237017	K
	2000.08-2006.03	Bus Engine E5FA Without ABS		o	GHA237015	K
2.3 16V (107 kW)	2000.08-2006.05	Bus Engine E5FA/E5FC	•		GHA245009	K
	2000.08-2006.05	Bus Engine E5FA/E5FC		o	GHA245016	K
	2000.08-2006.05	Bus Engine E5FA/E5FC With ABS		o	GHA237017	K
	2000.08-2006.05	Bus Engine E5FA/E5FC Without ABS		o	GHA237015	K
2.4 Di (55 kW)	2000.01-2006.05	Bus Engine F4FA	•		GHA245009	K
	2000.01-2006.05	Bus Engine F4FA		o	GHA245016	K
	2000.01-2006.05	Bus Engine F4FA With ABS		o	GHA237017	K
	2000.01-2006.05	Bus Engine F4FA Without ABS		o	GHA237015	K
2.4 Di (66 kW)	2000.01-2006.05	Bus Engine D2FA/D2FB/D2FE	•		GHA245009	K
	2000.01-2006.05	Bus Engine D2FA/D2FB/D2FE		o	GHA245016	K
	2000.01-2006.05	Bus Engine D2FA/D2FB/D2FE With ABS		o	GHA237017	K
	2000.01-2006.05	Bus Engine D2FA/D2FB/D2FE Without ABS		o	GHA237015	K
2.4 Di (88 kW)	2000.01-2006.05	Bus Engine D4FA	•		GHA245009	K
	2000.01-2006.05	Bus Engine D4FA		o	GHA245016	K
	2000.01-2006.05	Bus Engine D4FA With ABS		o	GHA237017	K
	2000.01-2006.05	Bus Engine D4FA Without ABS		o	GHA237015	K
2.4 TDCi (101 kW)	2004.03-2006.05	Bus Engine H9FA	•		GHA245009	K
	2004.03-2006.05	Bus Engine H9FA		o	GHA245016	K
	2004.03-2006.05	Bus Engine H9FA With ABS		o	GHA237017	K
	2004.03-2006.05	Bus Engine H9FA Without ABS		o	GHA237015	K
2.4 TDDi (66 kW)	2001.10-2006.03	Bus Engine D2FE	•		GHA245009	K
	2001.10-2006.03	Bus Engine D2FE		o	GHA245016	K
	2001.10-2006.03	Bus Engine D2FE With ABS		o	GHA237017	K
	2001.10-2006.03	Bus Engine D2FE Without ABS		o	GHA237015	K
2.4 TDE (85 kW)	2004.03-2006.05	Bus Engine FXFA	•		GHA245009	K
	2004.03-2006.05	Bus Engine FXFA		o	GHA245016	K
	2004.03-2006.05	Bus Engine FXFA With ABS		o	GHA237017	K
	2004.03-2006.05	Bus Engine FXFA Without ABS		o	GHA237015	K
2.4 TDE (92 kW)	2001.07-2006.05	Bus Engine DOFA	•		GHA245009	K
	2001.07-2006.05	Bus Engine DOFA		o	GHA245016	K
	2001.07-2006.05	Bus Engine DOFA With ABS		o	GHA237017	K
	2001.07-2006.05	Bus Engine DOFA Without ABS		o	GHA237015	K
TRANSIT (FM_, FN_) 						
2.0 Di (55 kW)	2000.08-2006.05	Platform/Chassis Engine D3FA	•		GHA245009	K
	2000.08-2006.05	Platform/Chassis Engine D3FA		o	GHA245016	K
	2000.08-2006.05	Platform/Chassis Engine D3FA With ABS		o	GHA237017	K
	2000.08-2006.05	Platform/Chassis Engine D3FA Without ABS		o	GHA237015	K
2.0 Di (63 kW)	2000.08-2006.05	Platform/Chassis Engine F3FA	•		GHA245009	K
	2000.08-2006.05	Platform/Chassis Engine F3FA		o	GHA245016	K
	2000.08-2006.05	Platform/Chassis Engine F3FA With ABS		o	GHA237017	K
	2000.08-2006.05	Platform/Chassis Engine F3FA Without ABS		o	GHA237015	K
2.0 Di (74 kW)	2000.08-2006.05	Platform/Chassis Engine ABFA	•		GHA245009	K
	2000.08-2006.05	Platform/Chassis Engine ABFA		o	GHA245016	K
	2000.08-2006.05	Platform/Chassis Engine ABFA With ABS		o	GHA237017	K
	2000.08-2006.05	Platform/Chassis Engine ABFA Without ABS		o	GHA237015	K
2.0 TDCi (92 kW)	2002.08-2006.05	Platform/Chassis Engine F1FA	•		GHA245009	K
	2002.08-2006.05	Platform/Chassis Engine F1FA		o	GHA245016	K
	2002.08-2006.05	Platform/Chassis Engine F1FA With ABS		o	GHA237017	K
	2002.08-2006.05	Platform/Chassis Engine F1FA Without ABS		o	GHA237015	K
2.3 16V (107 kW)	2001.04-2006.05	Platform/Chassis Engine E5FA/E5FC	•		GHA245009	K
	2001.04-2006.05	Platform/Chassis Engine E5FA/E5FC		o	GHA245016	K
	2001.04-2006.05	Platform/Chassis Engine E5FA/E5FC With ABS		o	GHA237017	K
	2001.04-2006.05	Platform/Chassis Engine E5FA/E5FC Without ABS		o	GHA237015	K
2.4 Di (55 kW)	2000.01-2006.05	Platform/Chassis Engine F4FA	•		GHA245009	K
	2000.01-2006.05	Platform/Chassis Engine F4FA		o	GHA245016	K
	2000.01-2006.05	Platform/Chassis Engine F4FA With ABS		o	GHA237017	K
	2000.01-2006.05	Platform/Chassis Engine F4FA Without ABS		o	GHA237015	K
2.4 Di (66 kW)	2000.01-2006.05	Platform/Chassis Engine D2FA/D2FB/D2FE	•		GHA245009	K
	2000.01-2006.05	Platform/Chassis Engine D2FA/D2FB/D2FE		o	GHA245016	K
	2000.01-2006.05	Platform/Chassis Engine D2FA/D2FB/D2FE With ABS		o	GHA237017	K
	2000.01-2006.05	Platform/Chassis Engine D2FA/D2FB/D2FE Without ABS		o	GHA237015	K
2.4 Di (88 kW)	2000.01-2006.05	Platform/Chassis Engine D4FA	•		GHA245009	K



	 YEAR		F	R	G-AP Ref.	KIT
FORD						
TRANSIT (FM_, FN_)						
2.4 Di (88 kW)	2000.01-2006.05	Platform/Chassis Engine D4FA		o	GHA245016	K
	2000.01-2006.05	Platform/Chassis Engine D4FA With ABS		o	GHA237017	K
	2000.01-2006.05	Platform/Chassis Engine D4FA Without ABS		o	GHA237015	K
2.4 TDCi (101 kW)	2004.03-2006.05	Platform/Chassis Engine H9FA	•		GHA245009	K
	2004.03-2006.05	Platform/Chassis Engine H9FA		o	GHA245016	K
	2004.03-2006.05	Platform/Chassis Engine H9FA With ABS		o	GHA237017	K
	2004.03-2006.05	Platform/Chassis Engine H9FA Without ABS		o	GHA237015	K
2.4 TDDi (88 kW)	2000.08-2003.08	Platform/Chassis Engine D4FA	•		GHA245009	K
	2000.08-2003.08	Platform/Chassis Engine D4FA		o	GHA245016	K
	2000.08-2003.08	Platform/Chassis Engine D4FA With ABS		o	GHA237017	K
	2000.08-2003.08	Platform/Chassis Engine D4FA Without ABS		o	GHA237015	K
2.4 TDE (85 kW)	2004.03-2006.05	Platform/Chassis Engine FXFA	•		GHA245009	K
	2004.03-2006.05	Platform/Chassis Engine FXFA		o	GHA245016	K
	2004.03-2006.05	Platform/Chassis Engine FXFA With ABS		o	GHA237017	K
	2004.03-2006.05	Platform/Chassis Engine FXFA Without ABS		o	GHA237015	K
2.4 TDE (92 kW)	2001.07-2006.05	Platform/Chassis Engine DOFA	•		GHA245009	K
	2001.07-2006.05	Platform/Chassis Engine DOFA		o	GHA245016	K
	2001.07-2006.05	Platform/Chassis Engine DOFA With ABS		o	GHA237017	K
	2001.07-2006.05	Platform/Chassis Engine DOFA Without ABS		o	GHA237015	K
TRANSIT CONNECT (P65_, P70_, P80_)						
1.8 16V (85 kW)	2002.06-	Box Engine EYPA/EYPC/EYPD	•		GWB6520	
	2002.06-	Box Engine EYPA/EYPC/EYPD	•		GWB6731	
	2002.06-	Box Engine EYPA/EYPC/EYPD		o	GHA237016	K
1.8 16V LPG (85 kW)	2002.06-	Box Engine EYPC	•		GWB6520	
	2002.06-	Box Engine EYPC	•		GWB6731	
	2002.06-	Box Engine EYPC		o	GHA237016	K
1.8 Di (55 kW)	2002.06-	Box Engine BHPA/P7PA/P7PB/R2PA	•		GWB6520	
	2002.06-	Box Engine BHPA/P7PA/P7PB/R2PA	•		GWB6731	
	2002.06-	Box Engine BHPA/P7PA/P7PB/R2PA		o	GHA237016	K
1.8 TDCi (66 kW)	2002.06-	Box Engine HCPA/HCPB/P9PA/P9PB/P9PC/P9PD/R3PA/RWPE/RWPF	•		GWB6520	
	2002.06-	Box Engine HCPA/HCPB/P9PA/P9PB/P9PC/P9PD/R3PA/RWPE/RWPF	•		GWB6731	
	2002.06-	Box Engine HCPA/HCPB/P9PA/P9PB/P9PC/P9PD/R3PA/RWPE/RWPF		o	GHA237016	K
1.8 TDCi (81 kW)	2006.08-	Box Engine RWPA/RWPC/RWPD	•		GWB6520	
	2006.08-	Box Engine RWPA/RWPC/RWPD	•		GWB6731	
	2006.08-	Box Engine RWPA/RWPC/RWPD		o	GHA237016	K
TRANSIT COURIER						
1.0 EcoBoost (74 kW)	2014.02-		•		GWB6653	
	2014.02-			o	GHA400336	K
1.5 TDCi (55 kW)	2014.02-		•		GWB6653	
	2014.02-			o	GHA400336	K
1.5 TDCi (70 kW)	2015.05-	Box Engine XVCA/XVCB/XVCC	•		GWB6653	
1.6 TDCi (70 kW)	2014.02-		•		GWB6653	
	2014.02-			o	GHA400336	K
TRANSIT COURIER Kombi						
1.0 EcoBoost (74 kW)	2014.02-		•		GWB6653	
	2014.02-			o	GHA400336	K
TRANSIT COURIER KOMBI						
1.5 TDCi (55 kW)	2014.02-	Estate Engine UGCA/UGCB/XUCC	•		GWB6653	
	2014.02-	Estate Engine UGCA/UGCB/XUCC		o	GHA400336	K
1.5 TDCi (70 kW)	2015.05-	Estate Engine XVCA/XVCB/XVCC	•		GWB6653	
1.6 TDCi (70 kW)	2014.02-	Estate Engine T3CA/T3CB/T3CC	•		GWB6653	
	2014.02-	Estate Engine T3CA/T3CB/T3CC		o	GHA400336	K
TRANSIT TOURNEO						
2.0 (84 kW)	1994.11-2000.12	Bus Engine NSH	•		GWB1465	
	1994.11-2000.12	Bus Engine NSH		o	GWB1466	
	1994.11-2000.12	Bus Engine NSH		o	GWB1467	
2.2 TDCi (103 kW)	2007.10-	Bus Engine PGFA/PGFB	•		GHA245008	K
	2007.10-	Bus Engine PGFA/PGFB	•		GHA249001	K
	2007.10-	Bus Engine PGFA/PGFB		o	GHA237010	K
	2007.10-	Bus Engine PGFA/PGFB		o	GHA245015	K
	2007.10-	Bus Engine PGFA/PGFB Without ABS		o	GHA237015	K
2.2 TDCi (81 kW)	2006.07-	Bus Engine QVFA	•		GHA245008	K
	2006.07-	Bus Engine QVFA	•		GHA249001	K
	2006.07-	Bus Engine QVFA		o	GHA237010	K



	 YEAR		F	R	G-AP Ref.	KIT
FORD						
TRANSIT TOURNEO						
2.2 TDCi (81 kW)	2006.07-	Bus Engine QVFA		o	GHA245015	K
	2006.07-	Bus Engine QVFA Without ABS		o	GHA237015	K
2.2 TDCi (85 kW)	2008.10-	Bus Engine SRFA/SRFB/SRFC/SRFE/SRFD	•		GHA245008	K
	2008.10-	Bus Engine SRFA/SRFB/SRFC/SRFE/SRFD	•		GHA249001	K
	2008.10-	Bus Engine SRFA/SRFB/SRFC/SRFE/SRFD		o	GHA237010	K
	2008.10-	Bus Engine SRFA/SRFB/SRFC/SRFE/SRFD		o	GHA245015	K
	2008.10-	Bus Engine SRFA/SRFB/SRFC/SRFE/SRFD Without ABS		o	GHA237015	K
2.2 TDCi (96 kW)	2006.07-	Bus Engine QWFA	•		GHA245008	K
	2006.07-	Bus Engine QWFA	•		GHA249001	K
	2006.07-	Bus Engine QWFA		o	GHA237010	K
	2006.07-	Bus Engine QWFA		o	GHA245015	K
	2006.07-	Bus Engine QWFA Without ABS		o	GHA237015	K
2.4 D (55 kW)	1994.08-2000.06	Bus Engine 4HA	•		GWB1465	
	1994.08-2000.06	Bus Engine 4HA		o	GWB1466	
	1994.08-2000.06	Bus Engine 4HA		o	GWB1467	
2.5 Di (51 kW)	1994.11-2000.12	Bus Engine 4FA/4FB/4FC/4FD	•		GWB1465	
	1994.11-2000.12	Bus Engine 4FA/4FB/4FC/4FD		o	GWB1466	
	1994.11-2000.12	Bus Engine 4FA/4FB/4FC/4FD		o	GWB1467	
2.5 Di (56 kW)	1994.11-2000.12	Bus Engine 4HA/4HB/4HC	•		GWB1465	
	1994.11-2000.12	Bus Engine 4HA/4HB/4HC		o	GWB1466	
	1994.11-2000.12	Bus Engine 4HA/4HB/4HC		o	GWB1467	
2.5 TD (63 kW)	1994.11-2000.12	Bus Engine 4GA/4GB/4GC	•		GWB1465	
	1994.11-2000.12	Bus Engine 4GA/4GB/4GC		o	GWB1466	
	1994.11-2000.12	Bus Engine 4GA/4GB/4GC		o	GWB1467	
2.5 TD (74 kW)	1998.04-2000.12	Bus Engine 4EB/4EC	•		GWB1465	
	1998.04-2000.12	Bus Engine 4EB/4EC		o	GWB1466	
	1998.04-2000.12	Bus Engine 4EB/4EC		o	GWB1467	
TRANSIT VAN (E_ _)						
2.5 Di (85 kW)	1999.05-2000.03	Box Engine 4ED	•		GWB1465	
	1999.05-2000.03	Box Engine 4ED		o	GWB1466	
	1999.05-2000.03	Box Engine 4ED		o	GWB1467	
2.5 TD (55 kW)	1998.10-2000.03	Box Engine 4HA/4HD	•		GWB1465	
	1998.10-2000.03	Box Engine 4HA/4HD		o	GWB1466	
	1998.10-2000.03	Box Engine 4HA/4HD		o	GWB1467	
2.5 TD (63 kW)	1994.06-2000.03	Box Engine 4GA/4GB/4GC/4GD/4GE/4GF	•		GWB1465	
	1994.06-2000.03	Box Engine 4GA/4GB/4GC/4GD/4GE/4GF		o	GWB1466	
	1994.06-2000.03	Box Engine 4GA/4GB/4GC/4GD/4GE/4GF		o	GWB1467	
2.5 TD (74 kW)	1991.05-1994.06	Box Engine 4EA	•		GWB1465	
	1991.05-1994.06	Box Engine 4EA		o	GWB1466	
	1991.05-1994.06	Box Engine 4EA		o	GWB1467	
2.5 TDi (74 kW)	1994.06-2000.03	Box Engine 4EB/4EC	•		GWB1465	
	1994.06-2000.03	Box Engine 4EB/4EC		o	GWB1466	
	1994.06-2000.03	Box Engine 4EB/4EC		o	GWB1467	
TRANSIT VAN (FA_ _)						
2.0 Di (55 kW)	2000.08-2006.05	Box Engine D3FA	•		GHA245009	K
	2000.08-2006.05	Box Engine D3FA		o	GHA245016	K
	2000.08-2006.05	Box Engine D3FA With ABS		o	GHA237017	K
	2000.08-2006.05	Box Engine D3FA Without ABS		o	GHA237015	K
2.0 Di (63 kW)	2000.08-2006.05	Box Engine F3FA	•		GHA245009	K
	2000.08-2006.05	Box Engine F3FA		o	GHA245016	K
	2000.08-2006.05	Box Engine F3FA With ABS		o	GHA237017	K
	2000.08-2006.05	Box Engine F3FA Without ABS		o	GHA237015	K
2.0 Di (74 kW)	2000.08-2006.05	Box Engine ABFA	•		GHA245009	K
	2000.08-2006.05	Box Engine ABFA		o	GHA245016	K
	2000.08-2006.05	Box Engine ABFA With ABS		o	GHA237017	K
	2000.08-2006.05	Box Engine ABFA Without ABS		o	GHA237015	K
2.0 TDCi (92 kW)	2002.08-2006.05	Box Engine F1FA	•		GHA245009	K
	2002.08-2006.05	Box Engine F1FA		o	GHA245016	K
	2002.08-2006.05	Box Engine F1FA With ABS		o	GHA237017	K
	2002.08-2006.05	Box Engine F1FA Without ABS		o	GHA237015	K
2.3 (105 kW)	2001.03-2006.03	Box Engine E5FC	•		GHA245009	K
	2001.03-2006.03	Box Engine E5FC		o	GHA245016	K
	2001.03-2006.03	Box Engine E5FC With ABS		o	GHA237017	K
	2001.03-2006.03	Box Engine E5FC Without ABS		o	GHA237015	K



	 YEAR		F	R	G-AP Ref.	KIT
FORD						
TRANSIT VAN (FA_)						
2.3 (107 kW)	2001.03-2006.03	Box Engine E5FA	•		GHA245009	K
	2001.03-2006.03	Box Engine E5FA		◦	GHA245016	K
	2001.03-2006.03	Box Engine E5FA With ABS		◦	GHA237017	K
	2001.03-2006.03	Box Engine E5FA Without ABS		◦	GHA237015	K
2.3 16V (107 kW)	2001.04-2006.05	Box Engine E5FA/E5FC	•		GHA245009	K
	2001.04-2006.05	Box Engine E5FA/E5FC		◦	GHA245016	K
	2001.04-2006.05	Box Engine E5FA/E5FC With ABS		◦	GHA237017	K
	2001.04-2006.05	Box Engine E5FA/E5FC Without ABS		◦	GHA237015	K
2.4 Di (55 kW)	2000.01-2006.05	Box Engine F4FA	•		GHA245009	K
	2000.01-2006.05	Box Engine F4FA		◦	GHA245016	K
	2000.01-2006.05	Box Engine F4FA With ABS		◦	GHA237017	K
	2000.01-2006.05	Box Engine F4FA Without ABS		◦	GHA237015	K
2.4 Di (66 kW)	2000.01-2006.05	Box Engine D2FA/D2FB/D2FE	•		GHA245009	K
	2000.01-2006.05	Box Engine D2FA/D2FB/D2FE		◦	GHA245016	K
	2000.01-2006.05	Box Engine D2FA/D2FB/D2FE With ABS		◦	GHA237017	K
	2000.01-2006.05	Box Engine D2FA/D2FB/D2FE Without ABS		◦	GHA237015	K
2.4 Di (88 kW)	2000.01-2006.05	Box Engine D4FA	•		GHA245009	K
	2000.01-2006.05	Box Engine D4FA		◦	GHA245016	K
	2000.01-2006.05	Box Engine D4FA With ABS		◦	GHA237017	K
	2000.01-2006.05	Box Engine D4FA Without ABS		◦	GHA237015	K
2.4 TDCi (101 kW)	2004.03-2006.05	Box Engine H9FA	•		GHA245009	K
	2004.03-2006.05	Box Engine H9FA		◦	GHA245016	K
	2004.03-2006.05	Box Engine H9FA With ABS		◦	GHA237017	K
	2004.03-2006.05	Box Engine H9FA Without ABS		◦	GHA237015	K
2.4 TDDi (88 kW)	2000.08-2003.08	Box Engine D4FA	•		GHA245009	K
	2000.08-2003.08	Box Engine D4FA		◦	GHA245016	K
	2000.08-2003.08	Box Engine D4FA With ABS		◦	GHA237017	K
	2000.08-2003.08	Box Engine D4FA Without ABS		◦	GHA237015	K
2.4 TDE (85 kW)	2004.03-2006.05	Box Engine FXFA	•		GHA245009	K
	2004.03-2006.05	Box Engine FXFA		◦	GHA245016	K
	2004.03-2006.05	Box Engine FXFA With ABS		◦	GHA237017	K
	2004.03-2006.05	Box Engine FXFA Without ABS		◦	GHA237015	K
2.4 TDE (92 kW)	2001.07-2006.05	Box Engine DOFA	•		GHA245009	K
	2001.07-2006.05	Box Engine DOFA		◦	GHA245016	K
	2001.07-2006.05	Box Engine DOFA With ABS		◦	GHA237017	K
	2001.07-2006.05	Box Engine DOFA Without ABS		◦	GHA237015	K
FORD USA						
EXPLORER (U2)						
4.0 (150 kW)	1999.10-2001.12	Closed Off-Road Vehicle Engine 99X	•		GHA327011	
4.0 (152 kW)	1996.09-2001.12	Closed Off-Road Vehicle	•		GHA327011	
4.0 V6 4WD (115 kW)	1995.03-2001.12	Closed Off-Road Vehicle	•		GHA327011	
4.0 V6 4WD (150 kW)	1998.10-2001.12	Closed Off-Road Vehicle	•		GHA327011	
4.0 V6 4WD (152 kW)	1996.10-2001.12	Closed Off-Road Vehicle	•		GHA327011	
5.0 4WD (157 kW)	1996.01-2001.12	Closed Off-Road Vehicle	•		GHA327011	
EXPLORER (UN46)						
4.0 V6 4WD (121 kW)	1993.01-1994.12	Closed Off-Road Vehicle	•		GHA327011	
MUSTANG						
4.0 V6 (157 kW)	2004.12-2010.12	Coupe	•		GHA237020	
4.6 V8 (224 kW)	2004.12-	Coupe	•		GHA237020	
5.4 V8 (355 kW)	2006.01-	Coupe	•		GHA237020	
MUSTANG (C)						
3.8 (108 kW)	1993.09-1999.05	Convertible	•		GHA234502	
	1994.01-1999.05	Coupe	•		GHA234502	
3.8 (112 kW)	1993.09-	Convertible	•		GHA234502	
	1993.09-	Coupe	•		GHA234502	
4.6 (160 kW)	1995.11-1999.05	Convertible	•		GHA234502	
	1995.11-1999.05	Coupe	•		GHA234502	
4.6 (165 kW)	1995.11-1999.05	Coupe Engine 99W	•		GHA234502	
4.6 (225 kW)	1995.11-1999.05	Convertible	•		GHA234502	
	1995.11-1999.05	Coupe	•		GHA234502	
4.9 (160 kW)	1993.09-	Convertible	•		GHA234502	
	1993.09-	Coupe	•		GHA234502	



	 YEAR		F	R	G-AP Ref.	KIT
FORD USA						
TAURUS (P5_)						
3.0 (108 kW)	1995.09-	Saloon	•		GHA326009	
3.0 (95 kW)	1998.11-	Saloon	•		GHA326009	
3.0 24V (149 kW)	1996.09-	Saloon	•		GHA326009	
3.0 V6 (115 kW)	1999.03-	Saloon	•		GHA326009	
TAURUS WAGON (P5_)						
3.0 (108 kW)	1996.09-1999.12	Estate	•		GHA326009	
3.0 (95 kW)	1998.11-1999.12	Estate	•		GHA326009	
3.0 24V (149 kW)	1995.06-1999.12	Estate	•		GHA326009	
3.0 V6 (115 kW)	1999.03-1999.12	Estate	•		GHA326009	
WINDSTAR (A3)						
3.0 V6 (108 kW)	1999.02-	MPV	•		GHA326006	
GEO						
PRIZM						
-	1993-1997		•		GHA426023	K
GM/DAEWOO						
LEGANZA 5BOLT TYPE						
-	2002-			o	GHA230124	
GMC						
SIERRA 3500						
-	2001-2007		•		GHA333068	
HAFEI						
LOBO / LUBAO						
1.3 (58 kW)	2003.06-	Hatchback Engine DA471QL			GWB1412	
HOLDEN						
COMMODORE (VE)						
-	2006.08-		•		GHA400152	
COMMODORE (VR-VS)						
-	1993.07-1997.09	Left With ABS	•		GHA400047	
	1993.07-1997.09	Right With ABS	•		GHA400048	
	1993.07-1997.09	Without ABS	•		GHA400043	
	1993.07-1997.09	Without ABS	•		GHA400043	
	1993.07-1997.09		•		GHA400045	
	1993.07-1997.09		•		GHA400046	
COMMODORE (VT) SERIES II, VX VY VU						
-	1999.04-2006.07	Left With ABS	•		GHA400042	
	1999.04-2006.07	Right With ABS	•		GHA400040	
	1999.04-2006.07	Without ABS	•		GHA400041	
	1999.04-2006.07	Without ABS	•		GHA400041	
COMMODORE (VT) SERIES I						
-	1997.09-1999.04	Left With ABS	•		GHA400038	
	1997.09-1999.04	Right With ABS	•		GHA400039	
	1997.09-1999.04	Without ABS	•		GHA400044	
	1997.09-1999.04	Without ABS	•		GHA400044	
HONDA						
ACCORD						
-	1994-	With ABS			GHA230017	K
	1997-1995	With ABS			GHA230017	K
	1998-2002	Without ABS		o	GHA230072	
ACCORD IV (CB)						
1.8 (77 kW)	1990.01-1991.12	Saloon	•		GHA243001	K
	1990.01-1991.12	Saloon Without ABS		o	GHA230003	K
2.0 16V (66 kW)	1990.01-1993.03	Saloon Engine F20A6	•		GHA243001	K
	1990.01-1993.03	Saloon Engine F20A6 Without ABS		o	GHA230003	K
2.0 16V (81 kW)	1990.01-1993.03	Saloon Engine F20A2/F20A3	•		GHA243001	K
	1990.01-1993.03	Saloon Engine F20A2/F20A3		o	GHA230029	K
	1990.01-1993.03	Saloon Engine F20A2/F20A3 Without ABS		o	GHA230003	K
2.0 i 16V (98 kW)	1990.01-1993.03	Saloon Engine F20A4/F20A8	•		GHA243001	K
	1990.01-1993.03	Saloon Engine F20A4/F20A8		o	GHA230029	K
	1990.01-1993.03	Saloon Engine F20A4/F20A8 Without ABS		o	GHA230003	K



	 YEAR		F	R	G-AP Ref.	KIT
HONDA						
ACCORD IV (CB)						
2.0 i 16V (98 kW)	1993.03-1993.12	Estate Engine F20Z3	•		GHA243001	K
	1993.03-1993.12	Estate Engine F20Z3 Without ABS		◦	GHA230003	K
2.2 (103 kW)	1991.10-1993.1	Saloon Engine F22A6	•		GHA243001	K
	1991.10-1993.1	Saloon Engine F22A6 Without ABS		◦	GHA230003	K
2.2 i 16V (108 kW)	1991.01-1993.12	Estate Engine F22A8	•		GHA243001	K
2.2 i 16V (110 kW)	1990.01-1993.03	Saloon Engine F22A3	•		GHA243001	K
	1990.01-1993.03	Saloon Engine F22A3		◦	GHA230029	K
	1990.01-1993.03	Saloon Engine F22A3 Without ABS		◦	GHA230003	K
2.2 i 16V Automatik (108 kW)	1991.01-1993.12	Estate Engine F22A7	•		GHA243001	K
	1990.01-1993.03	Saloon Engine F22A3	•		GHA243001	K
	1990.01-1993.03	Saloon Engine F22A3		◦	GHA230029	K
	1990.01-1993.03	Saloon Engine F22A3 Without ABS		◦	GHA230003	K
ACCORD IV (CC1)						
2.0 i 16V (98 kW)	1992.01-1993.09	Coupe Engine F20A7	•		GHA243001	K
	1992.01-1993.09	Coupe Engine F20A7		◦	GHA230029	K
ACCORD V (CC7, CD)						
2.0 i (85 kW)	1993.03-1996.01	Saloon Engine F20Z2	•		GHA243001	K
	1993.03-1996.01	Saloon Engine F20Z2	•		GHA428001	
	1993.03-1996.01	Saloon Engine F20Z2 Without ABS		◦	GHA230003	K
2.0 i S (96 kW)	1993.03-1996.01	Saloon Engine F20Z1	•		GHA243001	K
	1993.03-1996.01	Saloon Engine F20Z1	•		GHA428001	
	1993.03-1996.01	Saloon Engine F20Z1 Without ABS		◦	GHA230003	K
2.3 i SR (116 kW)	1993.03-1996.01	Saloon Engine H23A3	•		GHA243001	K
	1993.03-1996.01	Saloon Engine H23A3	•		GHA428001	
	1993.03-1996.01	Saloon Engine H23A3 Without ABS		◦	GHA230003	K
ACCORD V (CD7, CD9)						
2.0 (100 kW)	1993.09-1997.12	Coupe Engine F20B3	•		GHA243001	K
	1993.09-1997.12	Coupe Engine F20B3	•		GHA428001	
	1993.09-1997.12	Coupe Engine F20B3 With ABS		◦	GHA234002	
2.2 i ES (110 kW)	1993.09-1998.02	Coupe Engine F22B5	•		GHA243001	K
	1993.09-1998.02	Coupe Engine F22B5 With ABS		◦	GHA234002	
	1993.09-1998.02	Coupe Engine F22B5 Without ABS		◦	GHA230003	K
ACCORD V (CE)						
2.0 i LS 16V (100 kW)	1993.09-1998.02	Estate Engine F20B3	•		GHA243001	K
	1993.09-1998.02	Estate Engine F20B3	•		GHA428001	
	1993.09-1998.02	Estate Engine F20B3 With ABS		◦	GHA234002	
	1993.09-1998.02	Estate Engine F20B3 Without ABS		◦	GHA234001	
2.2 i ES (110 kW)	1993.09-1998.02	Estate Engine F22B5	•		GHA243001	K
	1993.09-1998.02	Estate Engine F22B5 With ABS		◦	GHA234002	
	1993.09-1998.02	Estate Engine F22B5 Without ABS		◦	GHA234001	
ACCORD VI (CE, CF)						
1.9 i (85 kW)	1996.02-1998.10	Saloon Engine F18A3	•		GHA243001	K
2.0 i LS (96 kW)	1996.02-1998.10	Saloon Engine F20Z1	•		GHA243001	K
	1996.02-1998.10	Saloon Engine F20Z1 Without ABS		◦	GHA230003	K
2.0 TDi (77 kW)	1996.04-1998.10	Saloon Engine 20T2N	•		GHA243001	K
	1996.04-1998.10	Saloon Engine 20T2N Without ABS		◦	GHA230003	K
2.2 i VTEC (110 kW)	1996.02-1998.10	Saloon Engine F22Z2	•		GHA243001	K
ACCORD VI (CG, CK)						
3.0 Vtec (147 kW)	1997.03-2003.12	Saloon Engine J30A1	•		GWB3951	
	1997.03-2003.12	Saloon Engine J30A1		◦	GHA230024	K
ACCORD VII (CG)						
2.0 i 16V (108 kW)	1998.02-2003.06	Coupe Engine F20B5/F20B7	•		GWB3951	
	1998.02-2003.06	Coupe Engine F20B5/F20B7 With ABS		◦	GHA230030	K
2.3 VTi (113 kW)	1998.02-2002.10	Coupe Engine F23A3	•		GWB3951	
	1998.02-2002.10	Coupe Engine F23A3 With ABS		◦	GHA230030	K
3.0 V6 24V (147 kW)	1998.02-2003.06	Coupe Engine J30A1	•		GWB3951	
	1998.02-2003.06	Coupe Engine J30A1		◦	GHA230024	K
ACCORD VII (CG, CK)						
1.6 i (85 kW)	1998.10-2002.12	Saloon Engine D16B6	•		GWB3951	
	1998.10-2002.12	Saloon Engine D16B6		◦	GHA230112	K
1.6 LS (79 kW)	1998.10-2002.12	Saloon Engine D16B7	•		GWB3951	
	1998.10-2002.12	Saloon Engine D16B7		◦	GHA230112	K
1.8 i (100 kW)	1998.10-2002.12	Saloon Engine F18B2	•		GWB3951	



	 YEAR		F	R	G-AP Ref.	KIT
HONDA						
ACCORD VII (CG, CK)						
1.8 i (100 kW)	1998.10-2002.12	Saloon Engine F18B2		o	GHA230112	K
2.0 i (108 kW)	1998.10-2001.01	Saloon Engine F20B6	•		GWB3951	
	1998.10-2001.01	Saloon Engine F20B6		o	GHA230112	K
	1998.10-2001.01	Saloon Engine F20B6 With ABS		o	GHA230030	K
2.2 Type-R (156 kW)	1999.02-2002.12	Saloon Engine H22A7	•		GWB3951	
	1999.02-2002.12	Saloon Engine H22A7		o	GHA230093	K
	1999.02-2002.12	Saloon Engine H22A7		o	GHA230112	K
2.3 (113 kW)	2001.01-2003.06	Saloon Engine F23A1/F23Z5	•		GWB3951	
	2001.01-2003.06	Saloon Engine F23A1/F23Z5		o	GHA230093	K
	2001.01-2003.06	Saloon Engine F23A1/F23Z5		o	GHA230112	K
	2001.01-2003.06	Saloon Engine F23A1/F23Z5 With ABS		o	GHA230030	K
ACCORD VII (CH)						
1.8 i (100 kW)	1999.12-2002.12	Hatchback Engine F18B2	•		GWB3951	
	1999.12-2002.12	Hatchback Engine F18B2		o	GHA230093	K
	1999.12-2002.12	Hatchback Engine F18B2		o	GHA230112	K
2.0 (108 kW)	1999.12-2002.12	Hatchback	•		GWB3951	
	1999.12-2002.12	Hatchback		o	GHA230093	K
	1999.12-2002.12	Hatchback		o	GHA230112	K
2.0 TDi (77 kW)	1999.12-2000.10	Hatchback Engine 20T2N	•		GWB3951	
	1999.12-2000.10	Hatchback Engine 20T2N		o	GHA230112	K
2.3 (113 kW)	2000.11-2002.12	Hatchback Engine F23Z5	•		GWB3951	
	2000.11-2002.12	Hatchback Engine F23Z5		o	GHA230093	K
	2000.11-2002.12	Hatchback Engine F23Z5		o	GHA230112	K
ACCORD VII (CL)						
2.0 (114 kW)	2003.02-	Saloon Engine K20A6	•		GWB3961	
	2003.02-	Saloon Engine K20A6	•		GWB3961	
	2003.02-	Saloon Engine K20A6		o	GHA230022	
	2003.02-	Saloon Engine K20A6		o	GHA400068	
	2003.02-	Saloon Engine K20A6		o	GHA400068	
2.0 R (160 kW)	2003.06-2008.12	Saloon		o	GHA423016	
2.2 i-CTDi (103 kW)	2003.09-2007.09	Saloon Engine N22A1	•		GWB3961	
	2003.09-2007.09	Saloon Engine N22A1		o	GHA230022	
	2003.09-2007.09	Saloon Engine N22A1		o	GHA400068	
2.4 (113 kW)	2006.09-2008.05	Saloon Engine K24A8	•		GWB3961	
2.4 (140 kW)	2003.02-	Saloon Engine K24A/K24A3	•		GWB3961	
	2003.02-	Saloon Engine K24A/K24A3		o	GHA230022	
	2003.02-	Saloon Engine K24A/K24A3		o	GHA400068	
	2003.02-	Saloon Engine K24A/K24A3		o	GHA423016	
ACCORD VII (CM)						
2.4 Vtec E (118 kW)	2002.09-2005.12	Saloon Engine K24A2/K24A4	•		GWB3961	
ACCORD VII (CP)						
3.5 V6 (202 kW)	2007.09-2012.09	Saloon Engine J35Z2		o	GHA400101	
ACCORD VII TOURER (CM)						
2.0 (114 kW)	2003.04-	Estate Engine K20A6	•		GWB3961	
	2003.04-	Estate Engine K20A6		o	GHA230022	
	2003.04-	Estate Engine K20A6		o	GHA234005	K
2.2 i-CTDi (103 kW)	2003.09-2007.09	Estate Engine N22A1	•		GWB3961	
	2003.09-2007.09	Estate Engine N22A1		o	GHA230022	
	2003.09-2007.09	Estate Engine N22A1		o	GHA234005	K
2.4 (140 kW)	2003.04-	Estate Engine K24A	•		GWB3961	
	2003.04-	Estate Engine K24A		o	GHA230022	
	2003.04-	Estate Engine K24A		o	GHA234005	K
ACCORD VIII						
2.0 i (110 kW)	2008.07-	Estate Engine R20A4		o	GHA400101	
2.0 i (115 kW)	2008.07-	Estate Engine R20A3		o	GHA400101	
2.2 i-DTEC (110 kW)	2008.07-	Estate Engine N22B1		o	GHA400101	
	2008.07-	Estate Engine N22B1		o	GHA400275	
2.2 i-DTEC (132 kW)	2008.07-	Estate Engine N22B2		o	GHA400101	
	2008.07-	Estate Engine N22B2		o	GHA400275	
2.4 i (148 kW)	2008.07-	Estate Engine K24Z3		o	GHA400101	
	2008.07-	Estate Engine K24Z3		o	GHA400275	
ACCORD VIII (CU)						
2.0 i (110 kW)	2008.07-	Saloon		o	GHA400101	
2.0 i (115 kW)	2008.07-	Saloon Engine R20A3		o	GHA400101	



	 YEAR		F	R	G-AP Ref.	KIT
HONDA						
ACCORD VIII (CU)						
2.2 i-DTEC (110 kW)	2008.07-	Saloon Engine N22B1		o	GHA400101	
	2008.07-	Saloon Engine N22B1		o	GHA400275	
2.2 i-DTEC (132 kW)	2008.07-	Saloon Engine N22B2		o	GHA400101	
	2008.07-	Saloon Engine N22B2		o	GHA400275	
2.4 i (148 kW)	2008.07-	Saloon Engine K24Z3		o	GHA400101	
	2008.07-	Saloon Engine K24Z3		o	GHA400275	
AVANCIER						
2.3 4x4 (110 kW)	1999.09-2003.09	Estate Engine F23A		o	GHA423016	
3.0 4x4 (158 kW)	1999.09-2003.09	Estate Engine J30A		o	GHA423016	
CITY						
-	2004.01-	Without ABS		o	GHA228050	
CITY (GM)						
1.4 i-V TEC (73 kW)	2008.09-	Saloon Engine L13Z1	•		GHA426048	K
	2008.09-	Saloon Engine L13Z1	•		GWB7490	
	2008.09-	Saloon Engine L13Z1		o	GHA230068	K
1.5 (88 kW)	2009.02-	Saloon Engine L15A7	•		GHA426048	K
	2009.02-	Saloon Engine L15A7	•		GWB7490	
	2009.02-	Saloon Engine L15A7		o	GHA230068	K
CIVIC IV (EG)						
1.3 16V (55 kW)	1991.10-1995.11	Hatchback Engine D13B2	•		GWB3245	
	1991.10-1995.11	Hatchback Engine D13B2 Without ABS		o	GHA228030	K
1.5 i 16V (66 kW)	1991.10-1995.11	Hatchback Engine D15B2/D15Z2	•		GWB3245	
	1991.10-1995.11	Hatchback Engine D15B2/D15Z2 Without ABS		o	GHA228030	K
1.5 i 16V (69 kW)	1991.10-1995.11	Hatchback Engine D15B2/D15Z1	•		GWB3245	
	1991.10-1995.11	Hatchback Engine D15B2/D15Z1 Without ABS		o	GHA228030	K
1.6 16V VTEC (92 kW)	1991.10-1995.11	Hatchback Engine D16Z6	•		GWB3245	
	1991.10-1995.11	Hatchback Engine D16Z6 With ABS		o	GHA230015	K
1.6 VTi 16V (118 kW)	1991.10-1995.11	Hatchback Engine B16A2	•		GWB3246	
	1991.10-1995.11	Hatchback Engine B16A2 With ABS		o	GHA230015	K
CIVIC IV (EG, EH)						
1.5 i 16V (69 kW)	1991.10-1995.11	Saloon Engine D15B2/D15Z1	•		GWB3245	
	1991.10-1995.11	Saloon Engine D15B2/D15Z1 Without ABS		o	GHA228030	K
1.6 16V VTEC (92 kW)	1991.10-1995.11	Saloon Engine D16Z6/D16Z7	•		GWB3245	
	1991.10-1995.11	Saloon Engine D16Z6/D16Z7 With ABS		o	GHA230015	K
	1991.10-1995.11	Saloon Engine D16Z6/D16Z7 Without ABS		o	GHA228030	K
1.6 VTi (118 kW)	1991.10-1995.11	Saloon Engine B16A2	•		GWB3246	
	1991.10-1995.11	Saloon Engine B16A2 With ABS		o	GHA230015	K
CIVIC IV (MA, MB)						
1.4 i (55 kW)	1995.09-2001.02	Hatchback Engine D14A5/D14A7/D14Z3	•		GWB3246	
	1995.09-2001.02	Hatchback Engine D14A5/D14A7/D14Z3 With ABS		o	GHA230015	K
1.4 i (66 kW)	1994.09-2001.02	Hatchback Engine D14A2	•		GWB3246	
	1994.09-2001.02	Hatchback Engine D14A2 With ABS		o	GHA230015	K
1.5 16V (84 kW)	1997.01-2001.02	Hatchback Engine D15Z8	•		GWB3246	
	1997.01-2001.02	Hatchback Engine D15Z8 With ABS		o	GHA230015	K
1.5 i VTEC-E (66 kW)	1994.09-1997.01	Hatchback Engine D15Z3	•		GWB3246	
	1994.09-1997.01	Hatchback Engine D15Z3 With ABS		o	GHA230015	K
1.6 16V (85 kW)	1997.01-2001.02	Hatchback Engine D16B2	•		GWB3246	
	1997.01-2001.02	Hatchback Engine D16B2 With ABS		o	GHA230015	K
1.6 i (83 kW)	1994.09-1997.01	Hatchback Engine D16Y3	•		GWB3246	
	1994.09-1997.01	Hatchback Engine D16Y3 With ABS		o	GHA230015	K
1.6 i VTEC (93 kW)	1994.09-1997.01	Hatchback Engine D16Y2	•		GWB3246	
	1994.09-1997.01	Hatchback Engine D16Y2 With ABS		o	GHA230015	K
CIVIC IX (FB, FG)						
1.8 (104 kW)	2012.02-	Saloon Engine R18Z1/R18Z4	•		GWB7469	
CIVIC IX (FK)						
1.4 i-VTEC (73 kW)	2012.02-	Hatchback Engine L13Z4	•		GWB7469	
	2012.02-	Hatchback Engine L13Z4		o	GHA230091	K
1.6 i-DTEC (88 kW)	2013.02-	Hatchback Engine N16A1	•		GHA426028	K
1.8 i-VTEC (104 kW)	2012.02-	Hatchback Engine R18Z4	•		GHA426028	K
	2012.02-	Hatchback Engine R18Z4	•		GWB7469	
	2012.02-	Hatchback Engine R18Z4		o	GHA230091	K
2.2 i-DTEC (110 kW)	2012.02-	Hatchback Engine N22B4	•		GWB3961	
	2012.02-	Hatchback Engine N22B4		o	GHA230091	K



	 YEAR		F	R	G-AP Ref.	KIT
HONDA						
CIVIC IX TOURER (FK)						
1.8 i-VTEC (104 kW)	2014.01-	Estate Engine R18Z4	•		GHA426028	K
CIVIC V (EG, EH)						
1.5 (61 kW)	1992.01-1992.12	Saloon Engine D15B2	•		GWB3245	
	1992.01-1992.12	Saloon Engine D15B2 Without ABS		○	GHA228030	K
1.6 4x4 (92 kW)	1992.01-1995.10	Saloon Engine D16Z7		○	GHA225008	
1.6 EX (88 kW)	1993.08-1995.1	Saloon Engine D16A7	•		GWB3246	
	1993.08-1995.1	Saloon Engine D16A7 With ABS		○	GHA230015	K
	1993.08-1995.1	Saloon Engine D16A7 Without ABS		○	GHA228030	K
CIVIC V (EJ, EK)						
1.4 i (55 kW)	1995.11-2001.02	Hatchback Engine D14A3/D14Z1	•		GWB3245	
	1995.11-2001.02	Hatchback Engine D14A3/D14Z1	•		GWB3246	
	1995.11-2001.02	Hatchback Engine D14A3/D14Z1 With ABS		○	GHA228032	K
	1995.11-2001.02	Hatchback Engine D14A3/D14Z1 With ABS		○	GHA228032	K
	1995.11-2001.02	Hatchback Engine D14A3/D14Z1 Without ABS		○	GHA228030	K
1.4 i (66 kW)	1995.11-2001.02	Saloon Engine D14A4/D14Z2/D14Z4	•		GWB3245	
	1995.11-2001.02	Saloon Engine D14A4/D14Z2/D14Z4	•		GWB3246	
	1995.11-2001.02	Saloon Engine D14A4/D14Z2/D14Z4 With ABS		○	GHA228032	K
	1995.11-2001.02	Saloon Engine D14A4/D14Z2/D14Z4 With ABS		○	GHA228032	K
	1995.11-2001.02	Saloon Engine D14A4/D14Z2/D14Z4 Without ABS		○	GHA228030	K
1.4 i S (66 kW)	1995.11-2001.02	Hatchback Engine D14A4/D14Z2	•		GWB3245	
	1995.11-2001.02	Hatchback Engine D14A4/D14Z2	•		GWB3246	
	1995.11-2001.02	Hatchback Engine D14A4/D14Z2 With ABS		○	GHA228032	K
	1995.11-2001.02	Hatchback Engine D14A4/D14Z2 With ABS		○	GHA228032	K
	1995.11-2001.02	Hatchback Engine D14A4/D14Z2 Without ABS		○	GHA228030	K
1.5 i (84 kW)	1995.11-2001.02	Hatchback Engine D15Z6	•		GWB3246	
	1995.11-2001.02	Hatchback Engine D15Z6 With ABS		○	GHA228032	K
	1995.11-2001.02	Hatchback Engine D15Z6 With ABS		○	GHA228032	K
	1995.11-2001.02	Hatchback Engine D15Z6 With ABS		○	GHA230015	K
	1995.11-2001.02	Hatchback Engine D15Z6 Without ABS		○	GHA228030	K
	1995.11-2001.02	Saloon Engine D15Z6	•		GWB3246	
	1995.11-2001.02	Saloon Engine D15Z6 With ABS		○	GHA228032	K
	1995.11-2001.02	Saloon Engine D15Z6 With ABS		○	GHA228032	K
	1995.11-2001.02	Saloon Engine D15Z6 With ABS		○	GHA230015	K
	1995.11-2001.02	Saloon Engine D15Z6 Without ABS		○	GHA228030	K
1.6 i (84 kW)	1995.11-2001.02	Hatchback Engine D16Y5	•		GWB3246	
	1995.11-2001.02	Hatchback Engine D16Y5 With ABS		○	GHA228032	K
	1995.11-2001.02	Hatchback Engine D16Y5 With ABS		○	GHA228032	K
	1995.11-2001.02	Hatchback Engine D16Y5 With ABS		○	GHA230015	K
	1995.11-2001.02	Hatchback Engine D16Y5 Without ABS		○	GHA228030	K
1.6 i VTEC (92 kW)	1995.11-2001.02	Saloon Engine D16Y6/D16Y8	•		GWB3246	
	1995.11-2001.02	Saloon Engine D16Y6/D16Y8 With ABS		○	GHA228032	K
	1995.11-2001.02	Saloon Engine D16Y6/D16Y8 With ABS		○	GHA228032	K
	1995.11-2001.02	Saloon Engine D16Y6/D16Y8 With ABS		○	GHA230015	K
	1995.11-2001.02	Saloon Engine D16Y6/D16Y8 Without ABS		○	GHA228030	K
1.6 VTi (118 kW)	1995.11-2001.02	Hatchback Engine B16A2	•		GWB3246	
	1995.11-2001.02	Hatchback Engine B16A2 With ABS		○	GHA230015	K
	1995.11-2001.02	Saloon Engine B16A2	•		GWB3246	
	1995.11-2001.02	Saloon Engine B16A2 With ABS		○	GHA230015	K
CIVIC V (MB, MC)						
1.6 16V (85 kW)	1998.04-2001.02	Estate Engine D16B2	•		GWB3246	
	1998.04-2001.02	Estate Engine D16B2 With ABS		○	GHA230015	K
1.8 16V (124 kW)	1998.04-2001.02	Estate Engine B18C4	•		GWB3246	
	1998.04-2001.02	Estate Engine B18C4		○	GHA230023	K
2.0 i D (77 kW)	1998.04-2001.02	Estate Engine 20T2N	•		GWB3246	
CIVIC VI (EJ, EK)						
1.4 (55 kW)	1995.11-1998.10	Saloon Engine D14A4	•		GWB3245	
	1995.11-1998.10	Saloon Engine D14A4	•		GWB3246	
	1995.11-1998.10	Saloon Engine D14A4 With ABS		○	GHA228032	K
	1995.11-1998.10	Saloon Engine D14A4 With ABS		○	GHA228032	K
	1995.11-1998.10	Saloon Engine D14A4 Without ABS		○	GHA228030	K
CIVIC VI (EJ, EM1)						
1.6 (77 kW)	1996.05-1999.04	Coupe Engine D16Y7	•		GWB3245	
	1996.05-1999.04	Coupe Engine D16Y7	•		GWB3246	
	1996.05-1999.04	Coupe Engine D16Y7 With ABS		○	GHA228032	K



	 YEAR		F	R	G-AP Ref.	KIT
HONDA						
CIVIC VI (EJ, EM1)						
1.6 (77 kW)	1996.05-1999.04	Coupe Engine D16Y7 With ABS		o	GHA228032	K
	1996.05-1999.04	Coupe Engine D16Y7 With ABS		o	GHA230015	K
	1996.05-1999.04	Coupe Engine D16Y7 Without ABS		o	GHA228030	K
1.6 i (77 kW)	1996.03-2000.03	Coupe Engine D16Y7	•		GWB3245	
	1996.03-2000.03	Coupe Engine D16Y7	•		GWB3246	
	1996.03-2000.03	Coupe Engine D16Y7 With ABS		o	GHA228032	K
	1996.03-2000.03	Coupe Engine D16Y7 With ABS		o	GHA228032	K
	1996.03-2000.03	Coupe Engine D16Y7 With ABS		o	GHA230015	K
	1996.03-2000.03	Coupe Engine D16Y7 Without ABS		o	GHA228030	K
1.6 i VTEC (118 kW)	1999.04-2000.12	Coupe Engine B16A2	•		GWB3246	
	1999.04-2000.12	Coupe Engine B16A2 With ABS		o	GHA230015	K
1.6 i VTEC (92 kW)	1996.03-2000.03	Coupe Engine D16Y8	•		GWB3246	
	1996.03-2000.03	Coupe Engine D16Y8 With ABS		o	GHA228032	K
	1996.03-2000.03	Coupe Engine D16Y8 With ABS		o	GHA228032	K
	1996.03-2000.03	Coupe Engine D16Y8 With ABS		o	GHA230015	K
	1996.03-2000.03	Coupe Engine D16Y8 Without ABS		o	GHA228030	K
CIVIC VII (EM2)						
1.6 i (81 kW)	2001.02-2005.12	Coupe Engine D16V1	•		GWB3246	
	2001.02-2005.12	Coupe Engine D16V1 With ABS		o	GHA230065	K
	2001.02-2005.12	Coupe Engine D16V1 With ABS		o	GHA230065	K
1.7 i (88 kW)	2001.05-2005.12	Coupe Engine D17A8	•		GWB3246	
	2001.05-2005.12	Coupe Engine D17A8 With ABS		o	GHA230065	K
	2001.05-2005.12	Coupe Engine D17A8 With ABS		o	GHA230065	K
1.7 i VTEC (92 kW)	2001.05-2005.12	Coupe Engine D17A5/D17A9	•		GWB3246	
	2001.05-2005.12	Coupe Engine D17A5/D17A9 With ABS		o	GHA230065	K
	2001.05-2005.12	Coupe Engine D17A5/D17A9 With ABS		o	GHA230065	K
CIVIC VII (ES)						
1.4 (66 kW)	2000.12-2005.09	Saloon Engine D14Z5	•		GWB3246	
	2000.12-2005.09	Saloon Engine D14Z5 Without ABS		o	GHA230049	K
1.6 (81 kW)	2001.02-2005.09	Saloon Engine D16V1	•		GWB3246	
	2001.02-2005.09	Saloon Engine D16V1 With ABS		o	GHA230065	K
	2001.02-2005.09	Saloon Engine D16V1 With ABS		o	GHA230065	K
	2001.02-2005.09	Saloon Engine D16V1 Without ABS		o	GHA230049	K
	2001.02-2005.09	Saloon Engine D16V1 Without ABS		o	GHA230049	K
1.7 (85 kW)	2001.02-2005.09	Saloon Engine D17A6	•		GWB3246	
	2001.02-2005.09	Saloon Engine D17A6 With ABS		o	GHA230065	K
	2001.02-2005.09	Saloon Engine D17A6 With ABS		o	GHA230065	K
	2001.02-2005.09	Saloon Engine D17A6 Without ABS		o	GHA230078	K
	2001.02-2005.09	Saloon Engine D17A6 Without ABS		o	GHA230078	K
CIVIC VII (EU, EP, EV)						
1.4 i (55 kW)	2001.02-2005.09	Hatchback Engine D14Z6	•		GWB3246	
	2001.02-2005.09	Hatchback Engine D14Z6 With ABS		o	GHA230065	K
	2001.02-2005.09	Hatchback Engine D14Z6 With ABS		o	GHA230065	K
	2001.02-2005.09	Hatchback Engine D14Z6 Without ABS		o	GHA230049	K
1.4 iS (66 kW)	2001.02-2005.09	Hatchback Engine D14Z5/D14Z6	•		GWB3246	
	2001.02-2005.09	Hatchback Engine D14Z5/D14Z6 With ABS		o	GHA230065	K
	2001.02-2005.09	Hatchback Engine D14Z5/D14Z6 With ABS		o	GHA230065	K
	2001.02-2005.09	Hatchback Engine D14Z5/D14Z6 Without ABS		o	GHA230049	K
1.6 i (81 kW)	2001.02-2005.09	Hatchback Engine D16V1	•		GWB3246	
	2001.02-2005.09	Hatchback Engine D16V1 With ABS		o	GHA230065	K
	2001.02-2005.09	Hatchback Engine D16V1 With ABS		o	GHA230065	K
1.7 (92 kW)	2000.01-2005.08	Hatchback Engine D17A6	•		GWB3246	
	2000.01-2005.08	Hatchback Engine D17A6 With ABS		o	GHA230065	K
	2000.01-2005.08	Hatchback Engine D17A6 With ABS		o	GHA230065	K
	2000.01-2005.08	Hatchback Engine D17A6 Without ABS		o	GHA230078	K
	2000.01-2005.08	Hatchback Engine D17A6 Without ABS		o	GHA230078	K
1.7 CTDi (74 kW)	2002.01-2005.09	Hatchback Engine 4EE-2	•		GWB3246	
	2002.01-2005.09	Hatchback Engine 4EE-2 With ABS		o	GHA230065	K
	2002.01-2005.09	Hatchback Engine 4EE-2 With ABS		o	GHA230065	K
2.0 i Sport (118 kW)	2001.09-2005.09	Hatchback Engine K20A3	•		GWB3951	
	2001.09-2005.09	Hatchback Engine K20A3		o	GHA230067	K
2.0 Type-R (147 kW)	2001.09-2005.09	Hatchback Engine K20A2	•		GWB3951	
	2001.09-2005.09	Hatchback Engine K20A2		o	GHA230067	K
CIVIC VIII (FD, FA)						
1.3 HybriD (70 kW)	2006.01-	Saloon Engine LDA2	•		GHA426028	K



	 YEAR		F	R	G-AP Ref.	KIT
HONDA						
CIVIC VIII (FD, FA)						
1.3 HybriD (70 kW)	2006.01-	Saloon Engine LDA2	•		GWB7469	
	2006.01-	Saloon Engine LDA2		◦	GHA400083	
1.3 HybriD (85 kW)	2010.01-2012.02	Saloon Engine LDA2	•		GHA426028	K
	2010.01-2012.02	Saloon Engine LDA2	•		GWB7469	
	2010.01-2012.02	Saloon Engine LDA2		◦	GHA400083	
1.6 (92 kW)	2012.01-	Saloon Engine R16B1	•		GWB7469	
1.8 (103 kW)	2005.09-2008.01	Saloon Engine R18A1	•		GHA426028	K
	2005.09-2008.01	Saloon Engine R18A1	•		GWB7469	
	2005.09-2008.01	Saloon Engine R18A1		◦	GHA400083	
2.0 i-VTEC Type R (165 kW)	2007.08-2010.09	Saloon	•		GHA426028	K
	2007.08-2010.09	Saloon	•		GHA430007	
CIVIC VIII (FN, FK)						
1.4 (61 kW)	2005.09-2007.02	Hatchback Engine L13A7	•		GHA426028	K
	2005.09-2007.02	Hatchback Engine L13A7	•		GWB7469	
	2005.09-2007.02	Hatchback Engine L13A7		◦	GHA230091	K
1.4 (73 kW)	2008.10-	Hatchback Engine L13Z1	•		GHA426028	K
	2008.10-	Hatchback Engine L13Z1	•		GWB7469	
	2008.10-	Hatchback Engine L13Z1		◦	GHA230091	K
1.8 (103 kW)	2005.09-2008.01	Hatchback Engine R18A2	•		GHA426028	K
	2005.09-2008.01	Hatchback Engine R18A2	•		GWB7469	
	2005.09-2008.01	Hatchback Engine R18A2		◦	GHA230091	K
2.0 Type-R (148 kW)	2006.09-	Hatchback Engine K20Z4	•		GWB3961	
	2006.09-	Hatchback Engine K20Z4		◦	GHA230091	K
2.2 CTDi (103 kW)	2005.09-2007.01	Hatchback Engine N22A2	•		GHA426028	K
	2005.09-2007.01	Hatchback Engine N22A2	•		GWB6830	
	2005.09-2007.01	Hatchback Engine N22A2		◦	GHA230091	K
CIVICK IV (EJ)						
1.5 i LSi (74 kW)	1993.08-1995.11	Coupe Engine D15B7	•		GWB3245	
	1993.08-1995.11	Coupe Engine D15B7	•		GWB3246	
	1993.08-1995.11	Coupe Engine D15B7 With ABS		◦	GHA230015	K
	1993.08-1995.11	Coupe Engine D15B7 Without ABS		◦	GHA228030	K
1.6 i VTEC (118 kW)	1994.01-1995.11	Coupe Engine B16A2	•		GWB3245	
	1994.01-1995.11	Coupe Engine B16A2	•		GWB3246	
	1994.01-1995.11	Coupe Engine B16A2 Without ABS		◦	GHA228030	K
1.6 i VTEC (92 kW)	1994.01-1996.03	Coupe Engine D16Y6/D16Z9	•		GWB3245	
	1994.01-1996.03	Coupe Engine D16Y6/D16Z9	•		GWB3246	
	1994.01-1996.03	Coupe Engine D16Y6/D16Z9 Without ABS		◦	GHA228030	K
CROSSROAD						
1.8 i-VTEC (103 kW)	2007.02-2010.08	Closed Off-Road Vehicle Engine R18A2	•		GHA426028	K
CR-V						
-	2011-1997				GHA239001	
	2011-1997				GHA239002	
	2011-1997				GHA239004	
CR-V I (RD)						
2.0 (98 kW)	1999.04-2002.02	Closed Off-Road Vehicle Engine B20Z1	•		GWB3951	
	1999.04-2002.02	Closed Off-Road Vehicle Engine B20Z1		◦	GHA239003	
	1999.04-2002.02	Closed Off-Road Vehicle Engine B20Z1		◦	GHA243003	K
	1999.04-2002.02	Closed Off-Road Vehicle Engine B20Z1		◦	GHA243004	K
2.0 16V (108 kW)	1999.01-2002.02	Closed Off-Road Vehicle Engine B20Z1	•		GWB3951	
	1999.01-2002.02	Closed Off-Road Vehicle Engine B20Z1		◦	GHA239003	
	1999.01-2002.02	Closed Off-Road Vehicle Engine B20Z1		◦	GHA243003	K
	1999.01-2002.02	Closed Off-Road Vehicle Engine B20Z1		◦	GHA243004	K
2.0 16V (94 kW)	1995.10-1999.01	Closed Off-Road Vehicle Engine B20B	•		GWB3951	
	1995.10-1999.01	Closed Off-Road Vehicle Engine B20B		◦	GHA239003	
	1995.10-1999.01	Closed Off-Road Vehicle Engine B20B		◦	GHA243003	K
	1995.10-1999.01	Closed Off-Road Vehicle Engine B20B		◦	GHA243004	K
CR-V II (RD_)						
2.0 (110 kW)	2002.07-2006.09	Closed Off-Road Vehicle Engine K20A4	•		GWB3951	
	2002.07-2006.09	Closed Off-Road Vehicle Engine K20A4	•		GWB6830	
	2002.07-2006.09	Closed Off-Road Vehicle Engine K20A4		◦	GHA423016	
	2002.07-2006.09	Closed Off-Road Vehicle Engine K20A4		◦	GWB3245	
	2002.07-2006.09	Closed Off-Road Vehicle Engine K20A4		◦	GWB6825	
	2002.07-2006.09	Closed Off-Road Vehicle Engine K20A4		◦	GWB7490	
2.2 CTDi (103 kW)	2005.02-2006.09	Closed Off-Road Vehicle Engine N22A2	•		GWB6830	



	 YEAR		F	R	G-AP Ref.	KIT
HONDA						
CR-V II (RD_)						
2.2 CTDi (103 kW)	2005.02-2006.09	Closed Off-Road Vehicle Engine N22A2		o	GHA423016	
	2005.02-2006.09	Closed Off-Road Vehicle Engine N22A2		o	GWB6825	
2.4 Vtec 4WD (118 kW)	2001.09-2006.09	Closed Off-Road Vehicle Engine K24A1	•		GWB3951	
	2001.09-2006.09	Closed Off-Road Vehicle Engine K24A1	•		GWB6830	
	2001.09-2006.09	Closed Off-Road Vehicle Engine K24A1		o	GHA423016	
	2001.09-2006.09	Closed Off-Road Vehicle Engine K24A1		o	GWB3245	
	2001.09-2006.09	Closed Off-Road Vehicle Engine K24A1		o	GWB6825	
	2001.09-2006.09	Closed Off-Road Vehicle Engine K24A1		o	GWB7490	
CR-V III (RE)						
2.0 i 4WD (110 kW)	2007.01-	Closed Off-Road Vehicle Engine R20A2	•		GHA430007	
	2007.01-	Closed Off-Road Vehicle Engine R20A2	•		GWB7440	
	2007.01-	Closed Off-Road Vehicle Engine R20A2		o	GHA326052	
	2007.01-	Closed Off-Road Vehicle Engine R20A2		o	GHA328002	K
2.2 i-CTDi 4WD (103 kW)	2007.01-	Closed Off-Road Vehicle Engine N22A2	•		GHA430007	
	2007.01-	Closed Off-Road Vehicle Engine N22A2	•		GWB7440	
	2007.01-	Closed Off-Road Vehicle Engine N22A2		o	GHA326052	
	2007.01-	Closed Off-Road Vehicle Engine N22A2		o	GHA328002	K
2.2 i-DTEC 4WD (110 kW)	2007.01-	Closed Off-Road Vehicle Engine N22B3	•		GHA430007	
	2007.01-	Closed Off-Road Vehicle Engine N22B3	•		GWB7440	
	2007.01-	Closed Off-Road Vehicle Engine N22B3		o	GHA326052	
	2007.01-	Closed Off-Road Vehicle Engine N22B3		o	GHA328002	K
2.4 (125 kW)	2007.04-	Closed Off-Road Vehicle Engine K24A1	•		GWB7440	
	2007.04-	Closed Off-Road Vehicle Engine K24A1		o	GHA328002	K
2.4 4WD (124 kW)	2006.09-	Closed Off-Road Vehicle Engine K24A/K24Z1	•		GHA430007	
	2006.09-	Closed Off-Road Vehicle Engine K24A/K24Z1	•		GWB7440	
	2006.09-	Closed Off-Road Vehicle Engine K24A/K24Z1		o	GHA328002	K
2.4 i VTEC 4WD (122 kW)	2009.09-	Closed Off-Road Vehicle Engine K24Z1/K24Z4	•		GHA430007	
	2009.09-	Closed Off-Road Vehicle Engine K24Z1/K24Z4	•		GWB7440	
	2009.09-	Closed Off-Road Vehicle Engine K24Z1/K24Z4		o	GHA326052	
	2009.09-	Closed Off-Road Vehicle Engine K24Z1/K24Z4		o	GHA328002	K
2.4 i-VTEC 4WD (118 kW)	2006.10-	Closed Off-Road Vehicle Engine K24Z1	•		GHA430007	
	2006.10-	Closed Off-Road Vehicle Engine K24Z1	•		GWB7440	
	2006.10-	Closed Off-Road Vehicle Engine K24Z1		o	GHA328002	K
2.4 i-Vtec 4WD (125 kW)	2007.04-	Closed Off-Road Vehicle Engine K24Z1	•		GHA430007	
	2007.04-	Closed Off-Road Vehicle Engine K24Z1	•		GWB7440	
	2007.04-	Closed Off-Road Vehicle Engine K24Z1		o	GHA328002	K
CR-V IV (RE)						
1.6 i-DTEC (88 kW)	2013.10-	Closed Off-Road Vehicle Engine N16A1	•		GWB7440	
2.0 (114 kW)	2012.10-	Closed Off-Road Vehicle Engine R20A9	•		GWB7440	
2.0 AWD (114 kW)	2012.10-	Closed Off-Road Vehicle Engine R20A9	•		GWB7440	
2.2 i-DTEC AWD (110 kW)	2012.10-	Closed Off-Road Vehicle Engine N22B4	•		GHA430007	
	2012.10-	Closed Off-Road Vehicle Engine N22B4	•		GWB7440	
2.4 (138 kW)	2012.01-	Closed Off-Road Vehicle Engine K24Z7	•		GWB7440	
	2012.01-	Closed Off-Road Vehicle Engine K24Z7		o	GHA328002	K
2.4 AWD (132 kW)	2012.01-	Closed Off-Road Vehicle Engine K24Z6	•		GWB7440	
	2012.01-	Closed Off-Road Vehicle Engine K24Z6		o	GHA328002	K
CRX III (EH, EG)						
1.6 ESi (92 kW)	1992.03-1998.12	Targa Engine D16Y8/D16Z6	•		GWB3246	
	1992.03-1998.12	Targa Engine D16Y8/D16Z6 With ABS		o	GHA230015	K
	1992.03-1998.12	Targa Engine D16Y8/D16Z6 Without ABS		o	GHA228030	K
1.6 i VTi (118 kW)	1992.03-1998.12	Targa Engine B16A2	•		GWB3246	
	1992.03-1998.12	Targa Engine B16A2 With ABS		o	GHA230015	K
CR-Z (ZF1)						
1.5 Hybrid (84 kW)	2010.06-			o	GHA230134	K
ELEMENT						
2.4 Vtec (118 kW)	2002.07-2011.12		•		GHA243009	
	2002.07-2011.12			o	GHA243008	
2.4 Vtec 4x4 (118 kW)	2002.07-2011.12		•		GHA243009	
	2002.07-2011.12			o	GHA243008	
ELYSION						
2.4 i-VTEC (118 kW)	2004.5-	MPV Engine K24A1		o	GHA326052	
	2004.5-	MPV Engine K24A1		o	GHA423016	
3.5 i-VTEC (221 kW)	2004.05-	MPV	•		GHA430007	



	 YEAR		F	R	G-AP Ref.	KIT
HONDA						
FR-V (BE)						
1.7 (92 kW)	2004.08-	Hatchback Engine D17A2	•		GWB6830	
	2004.08-	Hatchback Engine D17A2		◦	GHA230135	
1.8 (103 kW)	2007.01-	Hatchback Engine R18A1	•		GWB6830	
	2007.01-	Hatchback Engine R18A1		◦	GHA230135	
2.0 (110 kW)	2005.02-	Hatchback Engine K20A9	•		GWB6830	
	2005.02-	Hatchback Engine K20A9		◦	GHA230135	
2.2 i CTDi (103 kW)	2005.06-2007.09	Hatchback Engine N22A1	•		GWB3961	
	2005.06-2007.09	Hatchback Engine N22A1		◦	GHA230135	
HR-V (GH)						
1.6 16V (77 kW)	1999.03-	Closed Off-Road Vehicle Engine D16W1	•		GWB3246	
1.6 16V 4WD (77 kW)	1999.03-	Closed Off-Road Vehicle Engine D16W1	•		GWB3246	
1.6 16V 4WD (91 kW)	1999.10-	Closed Off-Road Vehicle Engine D16W5	•		GWB3246	
INSIGHT (ZE)						
1.0 Hybrid (56 kW)	2000.04-2006.12		•		GHA237021	
	2000.04-2006.12			◦	GHA223001	
INSIGHT (ZE_)						
1.3 HybrID (65 kW)	2009.04-	Hatchback Engine LDA3	•		GHA426048	K
	2009.04-	Hatchback Engine LDA3	•		GWB7490	
	2009.04-	Hatchback Engine LDA3		◦	GHA230068	K
1.3 HybrID (73 kW)	2009.04-	Hatchback Engine LDA3	•		GHA426048	K
	2009.04-	Hatchback Engine LDA3	•		GWB7490	
	2009.04-	Hatchback Engine LDA3		◦	GHA230068	K
JAZZ II (GD)						
1.2 (57 kW)	2002.03-2008.07	Hatchback Engine L12A1	•		GWB6825	
	2002.03-2008.07	Hatchback Engine L12A1 With ABS		◦	GHA228019	K
	2002.03-2008.07	Hatchback Engine L12A1 With ABS		◦	GHA228029	K
	2002.03-2008.07	Hatchback Engine L12A1 Without ABS		◦	GHA228038	K
1.4 (61 kW)	2002.03-2008.07	Hatchback Engine L13A1	•		GWB6825	
	2002.03-2008.07	Hatchback Engine L13A1 With ABS		◦	GHA228019	K
	2002.03-2008.07	Hatchback Engine L13A1 With ABS		◦	GHA228029	K
1.5 (81 kW)	2002.04-2008.07	Hatchback Engine L15A	•		GWB3245	
	2002.04-2008.07	Hatchback Engine L15A	•		GWB6825	
	2002.04-2008.07	Hatchback Engine L15A With ABS		◦	GHA228019	K
JAZZ III (GE)						
1.2 (66 kW)	2008.07-	Hatchback Engine L12B1	•		GWB7490	
	2008.07-	Hatchback Engine L12B1		◦	GHA230068	K
	2008.07-	Hatchback Engine L12B1		◦	GHA230069	
1.3 HybrID (65 kW)	2011.04-	Hatchback Engine LDA3	•		GWB7490	
	2011.04-	Hatchback Engine LDA3		◦	GHA230068	K
	2011.04-	Hatchback Engine LDA3		◦	GHA230069	
1.4 (74 kW)	2008.11-	Hatchback Engine L13Z1	•		GHA426048	K
	2008.11-	Hatchback Engine L13Z1	•		GWB7490	
	2008.11-	Hatchback Engine L13Z1		◦	GHA230068	K
1.4 i (73 kW)	2008.07-	Hatchback Engine L13Z1	•		GHA426048	K
	2008.07-	Hatchback Engine L13Z1	•		GWB7490	
	2008.07-	Hatchback Engine L13Z1		◦	GHA230068	K
	2008.07-	Hatchback Engine L13Z1		◦	GHA230069	
1.5 FlexFuel (88 kW)	2008.07-	Hatchback Engine L15A3	•		GWB7490	
	2008.07-	Hatchback Engine L15A3		◦	GHA230068	K
1.5 i (88 kW)	2008.07-	Hatchback Engine L15A3/L15A7	•		GHA426048	K
	2008.07-	Hatchback Engine L15A3/L15A7	•		GWB7490	
	2008.07-	Hatchback Engine L15A3/L15A7		◦	GHA230068	K
LEGEND III (KA9)						
3.5 i 24V (151 kW)	1996.02-	Saloon Engine C35A2		◦	GHA234004	K
LEGEND IV (KB_)						
3.5 V6 4WD (217 kW)	2006.07-2008.03	Saloon Engine C35A8	•		GHA330048	K
LOGO (GA3)						
1.3 (48 kW)	1999.03-2002.03	Hatchback Engine D13B7	•		GWB3245	
	1999.03-2002.03	Hatchback Engine D13B7 Without ABS		◦	GHA228030	K
MOBILIO						
1.5 i-VTEC (88 kW)	2013.09-	MPV	•		GHA426048	K
	2013.09-	MPV		◦	GHA230068	K



	 YEAR		F	R	G-AP Ref.	KIT
HONDA						
ODYSSEY III (LHD)						
-	2005-2010			o	GHA400216	
ODYSSEY III (RHD) RB1 / RB2						
-	2003-2008			o	GHA400116	
ODYSSEY IV (RHD) RB3 / RB4						
-	2008-			o	GHA400116	
PILOT						
3.5 (186 kW)	2008.09-	Closed Off-Road Vehicle Engine J35Z4	•		GHA330038	
	2008.09-	Closed Off-Road Vehicle Engine J35Z4		o	GHA328013	
3.5 4WD (183 kW)	2011.01-	Closed Off-Road Vehicle Engine J35Z4	•		GHA330038	
	2011.01-	Closed Off-Road Vehicle Engine J35Z4		o	GHA328013	
3.5 4WD (186 kW)	2008.09-	Closed Off-Road Vehicle Engine J35Z4	•		GHA330038	
	2008.09-	Closed Off-Road Vehicle Engine J35Z4		o	GHA328013	
PRELUDE IV (BB)						
2.0 i 16V (98 kW)	1992.02-1996.09	Coupe Engine F20A4		o	GHA230095	
2.2 i 16V VTEC (136 kW)	1993.02-1996.09	Coupe Engine H22A2		o	GHA230095	
2.3 i 16V (118 kW)	1992.02-1996.09	Coupe Engine H23A2		o	GHA230095	
PRELUDE V (BB)						
2.0 16V (98 kW)	1996.10-2000.10	Coupe Engine F20A4	•		GWB3951	
	1996.10-2000.10	Coupe Engine F20A4		o	GHA230023	K
2.2 16V (136 kW)	1996.10-2000.10	Coupe Engine H22A5/H22A2	•		GWB3951	
	1996.10-2000.10	Coupe Engine H22A5/H22A2		o	GHA230020	K
2.2 16V (147 kW)	1996.10-2000.10	Coupe Engine H22A5	•		GWB3951	
	1996.10-2000.10	Coupe Engine H22A5		o	GHA230020	K
S2000 (AP)						
2.0 (177 kW)	1999.06-	Convertible Engine F20CVTEC	•		GWB7587	
	1999.06-	Convertible Engine F20CVTEC		o	GWB3951	
2.0 Vtec (170 kW)	1999.03-2003.1	Convertible Engine F20C1	•		GWB7587	
	1999.03-2003.1	Convertible Engine F20C1		o	GWB3951	
2.0 Vtec (184 kW)	2003.10-	Convertible Engine F20C3	•		GWB7587	
	2003.10-	Convertible Engine F20C3		o	GWB3951	
SHUTTLE (RA)						
2.2 16V (110 kW)	1994.10-1998.02	MPV Engine F22B8	•		GHA245003	
	1994.10-1998.02	MPV Engine F22B8		o	GHA234004	K
2.3 16V (110 kW)	1997.10-2004.06	MPV Engine F23A7	•		GHA245003	
	1997.10-2004.06	MPV Engine F23A7		o	GHA234004	K
	1997.10-2004.06	MPV Engine F23A7		o	GHA234007	
3.0 (154 kW)	1997.10-2004.06	MPV Engine J30A		o	GHA234007	
STEPWGN (DBA-RK_)						
2.0 i-VTEC (110 kW)	2009.10-	MPV Engine R20A1	•		GHA430007	
STREAM (RN)						
1.7 16V (92 kW)	2001.05-	MPV Engine D17A2	•		GWB3951	
	2001.05-	MPV Engine D17A2		o	GHA230067	K
2.0 16V (115 kW)	2001.05-	MPV Engine K20A1	•		GWB3951	
	2001.05-	MPV Engine K20A1		o	GHA230067	K
HUMMER						
HUMMER H2 SUT						
6 (237 kW)	2004.09-	Pickup Engine LQ4	•		GHA333041	
	2004.09-	Pickup Engine LQ4	•		GHA333095	
HUMMER H3						
3.5 (162 kW)	2005.04-	Closed Off-Road Vehicle Engine L52	•		GHA333104	
3.7 4WD (180 kW)	2006.09-	Closed Off-Road Vehicle Engine LLR	•		GHA333104	
5.3 V8 AWD (224 kW)	2008.10-	Closed Off-Road Vehicle Engine LH8	•		GHA333104	
HYUNDAI						
ACCENT (LC)						
1.3 (55 kW)	2000.01-2005.11	Saloon Engine G4EA	•		GHA425002	
	2000.01-2005.11	Saloon Engine G4EA	•		GWB3907	
	2000.01-2005.11	Saloon Engine G4EA With ABS		o	GHA228034	K
	2000.01-2005.11	Saloon Engine G4EA Without ABS		o	GHA228022	K
1.3 (63 kW)	2000.01-2005.11	Saloon Engine G4EA	•		GHA425002	
	2000.01-2005.11	Saloon Engine G4EA	•		GWB3907	
	2000.01-2005.11	Saloon Engine G4EA With ABS		o	GHA228034	K



	 YEAR		F	R	G-AP Ref.	KIT
HYUNDAI						
ACCENT (LC)						
1.3 (63 kW)	2000.01-2005.11	Saloon Engine G4EA Without ABS		o	GHA228022	K
1.5 (66 kW)	2000.01-2005.11	Saloon Engine G4EB	•		GHA425002	
	2000.01-2005.11	Saloon Engine G4EB	•		GWB3907	
	2000.01-2005.11	Saloon Engine G4EB With ABS		o	GHA228034	K
	2000.01-2005.11	Saloon Engine G4EB Without ABS		o	GHA228022	K
1.5 CRDi (60 kW)	2002.01-2005.11	Saloon Engine D3EA	•		GHA425002	
	2002.01-2005.11	Saloon Engine D3EA	•		GWB3907	
	2002.01-2005.11	Saloon Engine D3EA With ABS		o	GHA228034	K
	2002.01-2005.11	Saloon Engine D3EA Without ABS		o	GHA228022	K
1.6 (77 kW)	2003.02-2006.08	Saloon Engine G4ED-G	•		GHA425002	
	2003.02-2006.08	Saloon Engine G4ED-G	•		GWB3907	
	2003.02-2006.08	Saloon Engine G4ED-G With ABS		o	GHA228034	K
	2003.02-2006.08	Saloon Engine G4ED-G Without ABS		o	GHA228022	K
ACCENT (MC)						
1.4 GL (71 kW)	2005.11-2010.11	Saloon Engine G4EE	•		GHA425002	
	2005.11-2010.11	Saloon Engine G4EE	•		GHA425036	
	2005.11-2010.11	Saloon Engine G4EE	•		GWB3907	
	2005.11-2010.11	Saloon Engine G4EE		o	GHA400158	K
	2005.11-2010.11	Saloon Engine G4EE With ABS		o	GHA400130	K
	2005.11-2010.11	Saloon Engine G4EE Without ABS		o	GHA400100	
1.5 CRDi GLS (81 kW)	2005.11-2010.11	Saloon Engine D4FA	•		GHA425002	
	2005.11-2010.11	Saloon Engine D4FA	•		GWB3907	
	2005.11-2010.11	Saloon Engine D4FA		o	GHA400158	K
	2005.11-2010.11	Saloon Engine D4FA With ABS		o	GHA400130	K
	2005.11-2010.11	Saloon Engine D4FA Without ABS		o	GHA400100	
1.6 GLS (82 kW)	2005.11-2010.11	Saloon Engine G4ED	•		GHA425002	
	2005.11-2010.11	Saloon Engine G4ED	•		GHA425036	
	2005.11-2010.11	Saloon Engine G4ED	•		GWB3907	
	2005.11-2010.11	Saloon Engine G4ED		o	GHA400158	K
	2005.11-2010.11	Saloon Engine G4ED With ABS		o	GHA400130	K
	2005.11-2010.11	Saloon Engine G4ED Without ABS		o	GHA400100	
ACCENT (X-3)						
1.3 (40 kW)	1995.09-1998.05	Hatchback	•		GWB1366	
	1995.09-1998.05	Hatchback With ABS		o	GHA228035	K
	1995.09-1998.05	Hatchback Without ABS		o	GHA228017	K
	1995.09-1998.05	Hatchback Without ABS		o	GHA228018	K
	1995.09-1998.05	Hatchback Without ABS		o	GHA228018	K
1.3 (44 kW)	1994.10-2000.01	Saloon Engine G4EH	•		GHA425002	
	1994.10-2000.01	Saloon Engine G4EH	•		GWB1366	
	1994.10-2000.01	Saloon Engine G4EH With ABS		o	GHA228035	K
	1994.10-2000.01	Saloon Engine G4EH Without ABS		o	GHA228017	K
	1994.10-2000.01	Saloon Engine G4EH Without ABS		o	GHA228018	K
	1994.10-2000.01	Saloon Engine G4EH Without ABS		o	GHA228018	K
1.3 (55 kW)	1994.10-2000.01	Saloon Engine G4EH	•		GHA425001	
	1994.10-2000.01	Saloon Engine G4EH	•		GHA425002	
	1994.10-2000.01	Saloon Engine G4EH	•		GWB1366	
	1994.10-2000.01	Saloon Engine G4EH With ABS		o	GHA228035	K
	1994.10-2000.01	Saloon Engine G4EH Without ABS		o	GHA228017	K
	1994.10-2000.01	Saloon Engine G4EH Without ABS		o	GHA228018	K
	1994.10-2000.01	Saloon Engine G4EH Without ABS		o	GHA228018	K
	1994.10-2000.01	Saloon Engine G4EH Without ABS		o	GHA228018	K
1.3 i 12V (62 kW)	1994.10-2000.01	Saloon Engine G4EH	•		GHA425001	
	1994.10-2000.01	Saloon Engine G4EH	•		GHA425002	
	1994.10-2000.01	Saloon Engine G4EH	•		GWB1366	
	1994.10-2000.01	Saloon Engine G4EH With ABS		o	GHA228031	K
	1994.10-2000.01	Saloon Engine G4EH With ABS		o	GHA228035	K
	1994.10-2000.01	Saloon Engine G4EH Without ABS		o	GHA228017	K
	1994.10-2000.01	Saloon Engine G4EH Without ABS		o	GHA228018	K
	1994.10-2000.01	Saloon Engine G4EH Without ABS		o	GHA228018	K
	1994.10-2000.01	Saloon Engine G4EH Without ABS		o	GHA228018	K
	1994.10-2000.01	Saloon Engine G4EH Without ABS		o	GHA228018	K
1.5 (63 kW)	1994.10-1999.07	Saloon Engine G4EK	•		GHA425002	
	1994.10-1999.07	Saloon Engine G4EK	•		GWB1366	
	1994.10-1999.07	Saloon Engine G4EK With ABS		o	GHA228035	K
	1994.10-1999.07	Saloon Engine G4EK Without ABS		o	GHA228017	K
	1994.10-1999.07	Saloon Engine G4EK Without ABS		o	GHA228018	K
	1994.10-1999.07	Saloon Engine G4EK Without ABS		o	GHA228018	K



	 YEAR		F	R	G-AP Ref.	KIT
HYUNDAI						
ACCENT (X-3)						
1.5 i 12V (65 kW)	1994.10-2000.01	Saloon Engine G4EK	•		GHA425001	
	1994.10-2000.01	Saloon Engine G4EK	•		GHA425002	
	1994.10-2000.01	Saloon Engine G4EK	•		GWB1366	
	1994.10-2000.01	Saloon Engine G4EK With ABS		o	GHA228031	K
	1994.10-2000.01	Saloon Engine G4EK With ABS		o	GHA228035	K
	1994.10-2000.01	Saloon Engine G4EK Without ABS		o	GHA228017	K
	1994.10-2000.01	Saloon Engine G4EK Without ABS		o	GHA228018	K
	1994.10-2000.01	Saloon Engine G4EK Without ABS		o	GHA228018	K
1.5 i 16V (73 kW)	1995.10-2000.01	Saloon Engine G4ER	•		GHA425001	
	1995.10-2000.01	Saloon Engine G4ER	•		GHA425002	
	1995.10-2000.01	Saloon Engine G4ER	•		GWB1366	
	1995.10-2000.01	Saloon Engine G4ER With ABS		o	GHA228031	K
	1995.10-2000.01	Saloon Engine G4ER With ABS		o	GHA228035	K
	1995.10-2000.01	Saloon Engine G4ER Without ABS		o	GHA228017	K
	1995.10-2000.01	Saloon Engine G4ER Without ABS		o	GHA228018	K
	1995.10-2000.01	Saloon Engine G4ER Without ABS		o	GHA228018	K
ACCENT I (X-3)						
1.3 (44 kW)	1994.10-2000.01	Hatchback Engine G4EH	•		GHA425001	
	1994.10-2000.01	Hatchback Engine G4EH	•		GHA425002	
	1994.10-2000.01	Hatchback Engine G4EH	•		GWB1366	
	1994.10-2000.01	Hatchback Engine G4EH With ABS		o	GHA228035	K
	1994.10-2000.01	Hatchback Engine G4EH Without ABS		o	GHA228017	K
	1994.10-2000.01	Hatchback Engine G4EH Without ABS		o	GHA228018	K
	1994.10-2000.01	Hatchback Engine G4EH Without ABS		o	GHA228018	K
1.3 (55 kW)	1994.10-2000.01	Hatchback Engine G4EH	•		GHA425001	
	1994.10-2000.01	Hatchback Engine G4EH	•		GHA425002	
	1994.10-2000.01	Hatchback Engine G4EH	•		GWB1366	
	1994.10-2000.01	Hatchback Engine G4EH With ABS		o	GHA228035	K
	1994.10-2000.01	Hatchback Engine G4EH Without ABS		o	GHA228017	K
	1994.10-2000.01	Hatchback Engine G4EH Without ABS		o	GHA228018	K
	1994.10-2000.01	Hatchback Engine G4EH Without ABS		o	GHA228018	K
1.3 i 12V (62 kW)	1994.10-2000.01	Hatchback Engine G4EH	•		GHA425001	
	1994.10-2000.01	Hatchback Engine G4EH	•		GHA425002	
	1994.10-2000.01	Hatchback Engine G4EH	•		GWB1366	
	1994.10-2000.01	Hatchback Engine G4EH With ABS		o	GHA228031	K
	1994.10-2000.01	Hatchback Engine G4EH With ABS		o	GHA228035	K
	1994.10-2000.01	Hatchback Engine G4EH Without ABS		o	GHA228017	K
	1994.10-2000.01	Hatchback Engine G4EH Without ABS		o	GHA228018	K
	1994.10-2000.01	Hatchback Engine G4EH Without ABS		o	GHA228018	K
	1994.10-2000.01	Hatchback Engine G4EH Without ABS		o	GHA228018	K
	1994.10-2000.01	Hatchback Engine G4EH Without ABS		o	GHA228018	K
1.5 16V (76 kW)	1994.10-2000.01	Hatchback Engine G4FK	•		GHA425002	
1.5 i 12V (65 kW)	1994.10-2000.01	Hatchback Engine G4EK	•		GHA425001	
	1994.10-2000.01	Hatchback Engine G4EK	•		GHA425002	
	1994.10-2000.01	Hatchback Engine G4EK	•		GWB1366	
	1994.10-2000.01	Hatchback Engine G4EK With ABS		o	GHA228031	K
	1994.10-2000.01	Hatchback Engine G4EK With ABS		o	GHA228035	K
	1994.10-2000.01	Hatchback Engine G4EK Without ABS		o	GHA228017	K
	1994.10-2000.01	Hatchback Engine G4EK Without ABS		o	GHA228018	K
	1994.10-2000.01	Hatchback Engine G4EK Without ABS		o	GHA228018	K
	1994.10-2000.01	Hatchback Engine G4EK Without ABS		o	GHA228018	K
	1994.10-2000.01	Hatchback Engine G4EK Without ABS		o	GHA228018	K
1.5 i 16V (73 kW)	1995.12-2000.01	Hatchback Engine G4ER	•		GHA425001	
	1995.12-2000.01	Hatchback Engine G4ER	•		GHA425002	
	1995.12-2000.01	Hatchback Engine G4ER	•		GWB1366	
	1995.12-2000.01	Hatchback Engine G4ER With ABS		o	GHA228031	K
	1995.12-2000.01	Hatchback Engine G4ER With ABS		o	GHA228035	K
	1995.12-2000.01	Hatchback Engine G4ER Without ABS		o	GHA228017	K
	1995.12-2000.01	Hatchback Engine G4ER Without ABS		o	GHA228018	K
	1995.12-2000.01	Hatchback Engine G4ER Without ABS		o	GHA228018	K
ACCENT II (LC)						
1.3 (55 kW)	2000.01-2005.11	Hatchback Engine G4EA	•		GHA425002	
	2000.01-2005.11	Hatchback Engine G4EA	•		GWB3907	
	2000.01-2005.11	Hatchback Engine G4EA With ABS		o	GHA228034	K
	2000.01-2005.11	Hatchback Engine G4EA Without ABS		o	GHA228022	K
	2000.01-2005.11	Hatchback Engine G4EA	•		GHA425002	
1.3 (61 kW)	2000.01-2005.11	Hatchback Engine G4EA	•		GWB3907	
	2000.01-2005.11	Hatchback Engine G4EA	•		GWB3907	
	2000.01-2005.11	Hatchback Engine G4EA With ABS		o	GHA228034	K



	 YEAR		F	R	G-AP Ref.	KIT
HYUNDAI						
ACCENT II (LC)						
1.3 (61 kW)	2000.01-2005.11	Hatchback Engine G4EA Without ABS		o	GHA228022	K
1.3 (62 kW)	2003.02-2006.02	Hatchback Engine G4EH	•		GHA425002	
	2003.02-2006.02	Hatchback Engine G4EH	•		GWB3907	
	2003.02-2006.02	Hatchback Engine G4EH With ABS		o	GHA228034	K
	2003.02-2006.02	Hatchback Engine G4EH Without ABS		o	GHA228022	K
1.3 (63 kW)	2000.01-2005.11	Hatchback Engine G4EA	•		GHA425002	
	2000.01-2005.11	Hatchback Engine G4EA	•		GWB3907	
	2000.01-2005.11	Hatchback Engine G4EA With ABS		o	GHA228034	K
	2000.01-2005.11	Hatchback Engine G4EA Without ABS		o	GHA228022	K
1.5 (65 kW)	1999.09-2002.10	Hatchback Engine G4EK	•		GHA425002	
1.5 (66 kW)	2000.01-2005.11	Hatchback Engine G4EB	•		GHA425002	
	2000.01-2005.11	Hatchback Engine G4EB	•		GWB3907	
	2000.01-2005.11	Hatchback Engine G4EB With ABS		o	GHA228034	K
	2000.01-2005.11	Hatchback Engine G4EB Without ABS		o	GHA228022	K
1.5 (75 kW)	1999.09-2002.1	Saloon Engine G4FK	•		GHA425002	
	1999.09-2002.1	Saloon Engine G4FK	•		GWB3907	
	1999.09-2002.1	Saloon Engine G4FK With ABS		o	GHA228034	K
	1999.09-2002.1	Saloon Engine G4FK Without ABS		o	GHA228022	K
	2000.09-2005.11	Hatchback Engine G4EC-G	•		GHA425002	
	2000.09-2005.11	Hatchback Engine G4EC-G	•		GWB3907	
	2000.09-2005.11	Hatchback Engine G4EC-G With ABS		o	GHA228034	K
1.5 CRDi (60 kW)	2000.09-2005.11	Hatchback Engine G4EC-G Without ABS		o	GHA228022	K
	2002.04-2005.11	Hatchback Engine D3-EA	•		GHA425002	
	2002.04-2005.11	Hatchback Engine D3-EA	•		GWB3907	
	2002.04-2005.11	Hatchback Engine D3-EA With ABS		o	GHA228034	K
1.6 (77 kW)	2002.04-2005.11	Hatchback Engine D3-EA Without ABS		o	GHA228022	K
	2002.12-2005.11	Hatchback Engine G4ED-G	•		GHA425002	
	2002.12-2005.11	Hatchback Engine G4ED-G	•		GWB3907	
	2002.12-2005.11	Hatchback Engine G4ED-G With ABS		o	GHA228034	K
1.6 (77 kW)	2002.12-2005.11	Hatchback Engine G4ED-G Without ABS		o	GHA228022	K
ACCENT III (MC)						
1.4 GL (71 kW)	2005.11-2010.11	Hatchback Engine G4EE	•		GHA425002	
	2005.11-2010.11	Hatchback Engine G4EE	•		GHA425036	
	2005.11-2010.11	Hatchback Engine G4EE	•		GWB3907	
	2005.11-2010.11	Hatchback Engine G4EE		o	GHA400158	K
	2005.11-2010.11	Hatchback Engine G4EE With ABS		o	GHA400130	K
	2005.11-2010.11	Hatchback Engine G4EE Without ABS		o	GHA400100	
1.5 CRDi GLS (81 kW)	2005.11-2010.11	Hatchback Engine D4FA	•		GHA425002	
	2005.11-2010.11	Hatchback Engine D4FA	•		GWB3907	
	2005.11-2010.11	Hatchback Engine D4FA		o	GHA400158	K
	2005.11-2010.11	Hatchback Engine D4FA With ABS		o	GHA400130	K
	2005.11-2010.11	Hatchback Engine D4FA Without ABS		o	GHA400100	
1.6 GLS (82 kW)	2005.11-2010.11	Hatchback Engine G4ED	•		GHA425002	
	2005.11-2010.11	Hatchback Engine G4ED	•		GHA425036	
	2005.11-2010.11	Hatchback Engine G4ED	•		GWB3907	
	2005.11-2010.11	Hatchback Engine G4ED		o	GHA400158	K
	2005.11-2010.11	Hatchback Engine G4ED With ABS		o	GHA400130	K
	2005.11-2010.11	Hatchback Engine G4ED Without ABS		o	GHA400100	
ACCENT IV (RB)						
1.4 (74 kW)	2010.11-	Saloon Engine G4LC	•		GHA425002	
	2010.11-	Saloon Engine G4LC	•		GHA425036	
1.4 (79 kW)	2010.11-	Hatchback Engine G4FA	•		GHA425002	
	2010.11-	Hatchback Engine G4FA	•		GHA425036	
1.4 (80 kW)	2010.11-	Saloon Engine G4FA	•		GHA425002	
	2010.11-	Saloon Engine G4FA	•		GHA425036	
1.4 CRDi (66 kW)	2010.11-	Saloon Engine D4FC	•		GHA425036	
1.6 (90 kW)	2010.11-	Saloon Engine G4FC	•		GHA425002	
	2010.11-	Saloon Engine G4FC	•		GHA425036	
1.6 (91 kW)	2010.11-	Hatchback Engine G4FC	•		GHA425002	
	2010.11-	Hatchback Engine G4FC	•		GHA425036	
	2010.11-	Saloon Engine G4FC	•		GHA425002	
	2010.11-	Saloon Engine G4FC	•		GHA425036	
1.6 CCVT-I (92 kW)	2010.11-	Saloon Engine G4FC	•		GHA425002	
	2010.11-	Saloon Engine G4FC	•		GHA425036	



	 YEAR		F	R	G-AP Ref.	KIT
HYUNDAI						
ACCENT IV (RB)						
1.6 CRDi (100 kW)	2011.04-	Saloon Engine D4FB	•		GHA425036	
1.6 CRDi (94 kW)	2011.10-	Saloon Engine D4FB	•		GHA425036	
1.6 GDi (103 kW)	2011.09-	Saloon Engine G4FD	•		GHA425002	
	2011.09-	Saloon Engine G4FD	•		GHA425036	
AMICA (MX)						
1.0 i (40 kW)	1999.08-	Hatchback Engine G4HC	•		GHA425002	
	1999.08-	Hatchback Engine G4HC	•		GWB1366	
	1999.08-	Hatchback Engine G4HC	•		GWB3907	
	1999.08-	Hatchback Engine G4HC		o	GHA228049	K
	1999.08-	Hatchback Engine G4HC		o	GHA228067	K
1.0 i (43 kW)	2001.03-	Hatchback Engine G4HC-E	•		GHA425002	
	2001.03-	Hatchback Engine G4HC-E	•		GWB3907	
	2001.03-	Hatchback Engine G4HC-E		o	GHA228049	K
	2001.03-	Hatchback Engine G4HC-E		o	GHA228067	K
AMICA / ATOZ (MX)						
1.0 i (40 kW)	1998.02-2002.03	Hatchback Engine G4HC	•		GHA425002	
	1998.02-2002.03	Hatchback Engine G4HC	•		GWB1366	
	1998.02-2002.03	Hatchback Engine G4HC	•		GWB3907	
	1998.02-2002.03	Hatchback Engine G4HC		o	GHA228049	K
	1998.02-2002.03	Hatchback Engine G4HC		o	GHA228067	K
1.0 i (43 kW)	2001.03-	Hatchback Engine G4HC-E	•		GHA425002	
	2001.03-	Hatchback Engine G4HC-E	•		GWB3907	
	2001.03-	Hatchback Engine G4HC-E		o	GHA228049	K
	2001.03-	Hatchback Engine G4HC-E		o	GHA228067	K
1.1 (43 kW)	2003.08-2005.05	Hatchback Engine G4HD	•		GHA425002	
1.1 (46 kW)	2004.03-	Hatchback Engine G4HC	•		GHA425002	
	2004.03-	Hatchback Engine G4HC	•		GWB3907	
	2004.03-	Hatchback Engine G4HC		o	GHA228049	K
	2004.03-	Hatchback Engine G4HC		o	GHA228067	K
ATOS (MX)						
0.8 (38 kW)	1999.04-2003.07	Hatchback Engine G3HJ	•		GWB3907	
1.0 i (41 kW)	1998.02-2002.03	Hatchback Engine G4HC	•		GHA425002	
1.1 (45 kW)	2006.03-	Hatchback Engine G4HG	•		GHA425002	
ATOS PRIME (MX)						
1.1 (43 kW)	2003.06-	Hatchback Engine G4HD	•		GHA425002	
	2003.06-	Hatchback Engine G4HD	•		GWB3907	
	2003.06-	Hatchback Engine G4HD		o	GHA228049	K
	2003.06-	Hatchback Engine G4HD		o	GHA228067	K
1.1 (46 kW)	2005.09-	Hatchback Engine G4HG	•		GHA425002	
	2005.09-	Hatchback Engine G4HG	•		GWB3907	
	2005.09-	Hatchback Engine G4HG		o	GHA228049	K
	2005.09-	Hatchback Engine G4HG		o	GHA228067	K
COUPE (RD)						
1.6 16V (85 kW)	1998.03-2002.04	Coupe Engine G4GR	•		GHA425044	
	1998.03-2002.04	Coupe Engine G4GR	•		GWB3907	
	1998.03-2002.04	Coupe Engine G4GR	•		GWB6812	
	1998.03-2002.04	Coupe Engine G4GR With ABS		o	GHA228028	K
	1998.03-2002.04	Coupe Engine G4GR With ABS		o	GHA228068	K
	1998.03-2002.04	Coupe Engine G4GR Without ABS		o	GHA228014	
	1998.03-2002.04	Coupe Engine G4GR Without ABS		o	GHA228018	K
	1998.03-2002.04	Coupe Engine G4GR Without ABS		o	GHA228018	K
ELANTRA (HD)						
1.6 CRDi (85 kW)	2005.11-2011.12	Saloon Engine D4FB	•		GHA427010	
1.6 CVVT (90 kW)	2006.06-2011.06	Saloon Engine G4FC	•		GHA425027	
	2006.06-2011.06	Saloon Engine G4FC	•		GHA427010	
	2006.06-2011.06	Saloon Engine G4FC	•		GWB6923	
	2006.06-2011.06	Saloon Engine G4FC With ABS		o	GHA400131	
	2006.06-2011.06	Saloon Engine G4FC Without ABS		o	GHA400262	
	2.0 CVVT (103 kW)	2006.06-2010.05	Saloon Engine G4GC	•		GHA425027
2.0 CVVT (105 kW)	2006.06-2010.05	Saloon Engine G4GC	•		GHA427010	
	2006.06-2011.06	Saloon Engine G4GC	•		GHA425027	
	2006.06-2011.06	Saloon Engine G4GC	•		GHA427010	
	2006.06-2011.06	Saloon Engine G4GC With ABS	•	o	GWB6923	



	 YEAR		F	R	G-AP Ref.	KIT
HYUNDAI						
ELANTRA (HD)						
2.0 CVVT (105 kW)	2006.06-2011.06	Saloon Engine G4GC Without ABS		o	GHA400262	
ELANTRA (MD, UD)						
1.6 (94 kW)	2011.06-	Saloon Engine G4FG	•		GHA427010	
	2011.06-	Saloon Engine G4FG	•		GWB6923	
1.6 (97 kW)	2011.06-	Saloon Engine G4FG	•		GHA427010	
	2011.06-	Saloon Engine G4FG	•		GWB6923	
1.6 CRDi (94 kW)	2011.02-	Saloon Engine D4FB	•		GHA427010	
	2011.02-	Saloon Engine D4FB	•		GWB6923	
	2011.02-	Saloon Engine D4FB With ABS		o	GHA400257	
1.8 (110 kW)	2010.09-	Saloon Engine G4NB-B	•		GWB6923	
ELANTRA (XD)						
1.6 (66 kW)	2000.06-2006.07	Hatchback Engine G4GR	•		GHA425027	
	2000.06-2006.07	Hatchback Engine G4GR	•		GHA427010	
	2000.06-2006.07	Hatchback Engine G4GR	•		GWB6812	
	2000.06-2006.07	Hatchback Engine G4GR		o	GHA232044	
	2000.06-2006.07	Hatchback Engine G4GR		o	GHA232047	
	2000.06-2006.07	Hatchback Engine G4GR With ABS		o	GHA232002	K
	2000.06-2006.07	Hatchback Engine G4GR With ABS		o	GHA232002	K
	2000.06-2006.07	Hatchback Engine G4GR With ABS		o	GHA232008	K
	2000.06-2006.07	Hatchback Engine G4GR Without ABS		o	GHA232025	
	2000.06-2006.07	Hatchback Engine G4GR Without ABS		o	GHA232043	
	2000.06-2006.07	Saloon Engine 23718	•		GHA425027	
	2000.06-2006.07	Saloon Engine 23718	•		GHA427010	
	2000.06-2006.07	Saloon Engine 23718	•		GWB6812	
	2000.06-2006.07	Saloon Engine 23718		o	GHA232044	
	2000.06-2006.07	Saloon Engine 23718		o	GHA232047	
	2000.06-2006.07	Saloon Engine 23718 With ABS		o	GHA232002	K
	2000.06-2006.07	Saloon Engine 23718 With ABS		o	GHA232002	K
	2000.06-2006.07	Saloon Engine 23718 With ABS		o	GHA232008	K
	2000.06-2006.07	Saloon Engine 23718 Without ABS		o	GHA232025	
	2000.06-2006.07	Saloon Engine 23718 Without ABS		o	GHA232043	
1.6 (77 kW)	2001.01-2004.08	Hatchback Engine G4ED-G	•		GHA425027	
	2001.01-2004.08	Hatchback Engine G4ED-G	•		GHA427010	
	2001.01-2004.08	Hatchback Engine G4ED-G	•		GWB6812	
	2001.01-2004.08	Hatchback Engine G4ED-G With ABS		o	GHA232002	K
	2001.01-2004.08	Hatchback Engine G4ED-G With ABS		o	GHA232002	K
	2001.01-2004.08	Hatchback Engine G4ED-G Without ABS		o	GHA232025	
	2001.01-2004.08	Saloon Engine G4ED-G	•		GHA425027	
	2001.01-2004.08	Saloon Engine G4ED-G	•		GHA427010	
	2001.01-2004.08	Saloon Engine G4ED-G	•		GWB6812	
	2001.01-2004.08	Saloon Engine G4ED-G With ABS		o	GHA232002	K
	2001.01-2004.08	Saloon Engine G4ED-G With ABS		o	GHA232002	K
	2001.01-2004.08	Saloon Engine G4ED-G Without ABS		o	GHA232025	
1.6 (79 kW)	2000.06-2006.07	Hatchback Engine G4ED-G	•		GHA425027	
	2000.06-2006.07	Hatchback Engine G4ED-G	•		GHA427010	
	2000.06-2006.07	Hatchback Engine G4ED-G	•		GWB6812	
	2000.06-2006.07	Hatchback Engine G4ED-G		o	GHA232044	
	2000.06-2006.07	Hatchback Engine G4ED-G		o	GHA232047	
	2000.06-2006.07	Hatchback Engine G4ED-G With ABS		o	GHA232002	K
	2000.06-2006.07	Hatchback Engine G4ED-G With ABS		o	GHA232002	K
	2000.06-2006.07	Hatchback Engine G4ED-G With ABS		o	GHA232008	K
	2000.06-2006.07	Hatchback Engine G4ED-G Without ABS		o	GHA232025	
	2000.06-2006.07	Hatchback Engine G4ED-G Without ABS		o	GHA232043	
	2000.06-2006.07	Saloon Engine G4ED-G	•		GHA425027	
	2000.06-2006.07	Saloon Engine G4ED-G	•		GHA427010	
	2000.06-2006.07	Saloon Engine G4ED-G	•		GWB6812	
	2000.06-2006.07	Saloon Engine G4ED-G		o	GHA232044	
	2000.06-2006.07	Saloon Engine G4ED-G		o	GHA232047	
	2000.06-2006.07	Saloon Engine G4ED-G With ABS		o	GHA232002	K
	2000.06-2006.07	Saloon Engine G4ED-G With ABS		o	GHA232002	K
	2000.06-2006.07	Saloon Engine G4ED-G With ABS		o	GHA232008	K
	2000.06-2006.07	Saloon Engine G4ED-G Without ABS		o	GHA232025	
	2000.06-2006.07	Saloon Engine G4ED-G Without ABS		o	GHA232043	
1.6 (82 kW)	2003.09-2006.07	Hatchback Engine G4GA	•		GHA425027	



	 YEAR		F	R	G-AP Ref.	KIT
HYUNDAI						
ELANTRA (XD)						
1.6 (82 kW)	2003.09-2006.07	Hatchback Engine G4GA	•		GHA427010	
	2003.09-2006.07	Hatchback Engine G4GA	•		GWB6812	
	2003.09-2006.07	Hatchback Engine G4GA With ABS		o	GHA232002	K
	2003.09-2006.07	Hatchback Engine G4GA With ABS		o	GHA232002	K
	2003.09-2006.07	Hatchback Engine G4GA Without ABS		o	GHA232025	
1.8 (79 kW)	2000.06-2003.07	Saloon	•		GHA425027	
	2000.06-2003.07	Saloon	•		GWB6812	
	2000.06-2003.07	Saloon		o	GHA232044	
	2000.06-2003.07	Saloon		o	GHA232047	
	2000.06-2003.07	Saloon With ABS		o	GHA232002	K
	2000.06-2003.07	Saloon With ABS		o	GHA232002	K
	2000.06-2003.07	Saloon With ABS		o	GHA232008	K
	2000.06-2003.07	Saloon Without ABS		o	GHA232025	
1.8 (97 kW)	2000.06-2006.07	Hatchback Engine G4BB	•		GHA425027	
	2000.06-2006.07	Hatchback Engine G4BB	•		GHA427006	
	2000.06-2006.07	Hatchback Engine G4BB	•		GWB6812	
	2000.06-2006.07	Hatchback Engine G4BB		o	GHA232044	
	2000.06-2006.07	Hatchback Engine G4BB		o	GHA232047	
	2000.06-2006.07	Hatchback Engine G4BB With ABS		o	GHA232002	K
	2000.06-2006.07	Hatchback Engine G4BB With ABS		o	GHA232002	K
	2000.06-2006.07	Hatchback Engine G4BB With ABS		o	GHA232008	K
	2000.06-2006.07	Hatchback Engine G4BB Without ABS		o	GHA232025	
	2000.06-2006.07	Hatchback Engine G4BB Without ABS		o	GHA232043	
	2000.06-2006.07	Saloon Engine G4BB	•		GHA425027	
	2000.06-2006.07	Saloon Engine G4BB	•		GHA427006	
	2000.06-2006.07	Saloon Engine G4BB	•		GWB6812	
	2000.06-2006.07	Saloon Engine G4BB		o	GHA232044	
	2000.06-2006.07	Saloon Engine G4BB		o	GHA232047	
	2000.06-2006.07	Saloon Engine G4BB With ABS		o	GHA232002	K
	2000.06-2006.07	Saloon Engine G4BB With ABS		o	GHA232002	K
	2000.06-2006.07	Saloon Engine G4BB With ABS		o	GHA232008	K
	2000.06-2006.07	Saloon Engine G4BB Without ABS		o	GHA232025	
	1.8 (98 kW)	2002.11-2006.07	Hatchback Engine G4GB	•		GHA425027
2002.11-2006.07		Hatchback Engine G4GB	•		GHA427006	
2002.11-2006.07		Hatchback Engine G4GB	•		GWB6812	
2002.11-2006.07		Hatchback Engine G4GB With ABS		o	GHA232002	K
2002.11-2006.07		Hatchback Engine G4GB With ABS		o	GHA232002	K
2002.11-2006.07		Hatchback Engine G4GB Without ABS		o	GHA232025	
2.0 (102 kW)	2000.06-2006.07	Hatchback Engine G4GC-G	•		GHA425027	
	2000.06-2006.07	Hatchback Engine G4GC-G	•		GHA427010	
	2000.06-2006.07	Hatchback Engine G4GC-G	•		GWB6812	
	2000.06-2006.07	Hatchback Engine G4GC-G		o	GHA232044	
	2000.06-2006.07	Hatchback Engine G4GC-G		o	GHA232047	
	2000.06-2006.07	Hatchback Engine G4GC-G With ABS		o	GHA232002	K
	2000.06-2006.07	Hatchback Engine G4GC-G With ABS		o	GHA232002	K
	2000.06-2006.07	Hatchback Engine G4GC-G With ABS		o	GHA232008	K
	2000.06-2006.07	Hatchback Engine G4GC-G Without ABS		o	GHA232025	
	2000.06-2006.07	Hatchback Engine G4GC-G Without ABS		o	GHA232042	
	2000.06-2006.07	Hatchback Engine G4GC-G Without ABS		o	GHA232043	
	2000.06-2006.07	Saloon Engine G4GC-G	•		GHA425027	
	2000.06-2006.07	Saloon Engine G4GC-G	•		GHA427010	
	2000.06-2006.07	Saloon Engine G4GC-G	•		GWB6812	
	2000.06-2006.07	Saloon Engine G4GC-G		o	GHA232044	
	2000.06-2006.07	Saloon Engine G4GC-G		o	GHA232047	
	2000.06-2006.07	Saloon Engine G4GC-G With ABS		o	GHA232002	K
	2000.06-2006.07	Saloon Engine G4GC-G With ABS		o	GHA232002	K
	2000.06-2006.07	Saloon Engine G4GC-G With ABS		o	GHA232008	K
	2.0 (104 kW)	2000.06-2006.07	Hatchback Engine G4GC	•		GHA425027
2000.06-2006.07		Hatchback Engine G4GC	•		GHA427010	
2000.06-2006.07		Hatchback Engine G4GC	•		GWB6812	



	 YEAR		F	R	G-AP Ref.	KIT
HYUNDAI						
ELANTRA (XD)						
2.0 (104 kW)	2000.06-2006.07	Hatchback Engine G4GC		o	GHA232044	
	2000.06-2006.07	Hatchback Engine G4GC		o	GHA232047	
	2000.06-2006.07	Hatchback Engine G4GC With ABS		o	GHA232002	K
	2000.06-2006.07	Hatchback Engine G4GC With ABS		o	GHA232002	K
	2000.06-2006.07	Hatchback Engine G4GC With ABS		o	GHA232008	K
	2000.06-2006.07	Hatchback Engine G4GC Without ABS		o	GHA232025	
	2000.06-2006.07	Hatchback Engine G4GC Without ABS		o	GHA232042	
	2000.06-2006.07	Hatchback Engine G4GC Without ABS		o	GHA232043	
	2000.06-2006.07	Saloon Engine G4GC	•		GHA425027	
	2000.06-2006.07	Saloon Engine G4GC	•		GHA427010	
	2000.06-2006.07	Saloon Engine G4GC	•		GWB6812	
	2000.06-2006.07	Saloon Engine G4GC		o	GHA232044	
	2000.06-2006.07	Saloon Engine G4GC		o	GHA232047	
	2000.06-2006.07	Saloon Engine G4GC With ABS		o	GHA232002	K
	2000.06-2006.07	Saloon Engine G4GC With ABS		o	GHA232002	K
	2000.06-2006.07	Saloon Engine G4GC With ABS		o	GHA232008	K
	2000.06-2006.07	Saloon Engine G4GC Without ABS		o	GHA232025	
	2000.06-2006.07	Saloon Engine G4GC Without ABS		o	GHA232042	
	2000.06-2006.07	Saloon Engine G4GC Without ABS		o	GHA232043	
2.0 (105 kW)	2003.10-2006.07	Hatchback Engine G4GC	•		GHA425027	
	2003.10-2006.07	Hatchback Engine G4GC	•		GHA427010	
	2003.10-2006.07	Hatchback Engine G4GC	•		GWB6812	
	2003.10-2006.07	Hatchback Engine G4GC With ABS		o	GHA232002	K
	2003.10-2006.07	Hatchback Engine G4GC With ABS		o	GHA232002	K
	2003.10-2006.07	Hatchback Engine G4GC Without ABS		o	GHA232025	
	2003.10-2006.07	Saloon Engine G4GC	•		GHA425027	
	2003.10-2006.07	Saloon Engine G4GC	•		GHA427010	
	2003.10-2006.07	Saloon Engine G4GC	•		GWB6812	
	2003.10-2006.07	Saloon Engine G4GC With ABS		o	GHA232002	K
	2003.10-2006.07	Saloon Engine G4GC With ABS		o	GHA232002	K
	2003.10-2006.07	Saloon Engine G4GC Without ABS		o	GHA232025	
2.0 CRDi (83 kW)	2001.04-2006.07	Hatchback Engine D4EA	•		GHA425027	
	2001.04-2006.07	Hatchback Engine D4EA	•		GHA427002	
	2001.04-2006.07	Hatchback Engine D4EA	•		GHA427006	
	2001.04-2006.07	Hatchback Engine D4EA	•		GWB3909	
	2001.04-2006.07	Hatchback Engine D4EA		o	GHA232044	
	2001.04-2006.07	Hatchback Engine D4EA		o	GHA232047	
	2001.04-2006.07	Hatchback Engine D4EA With ABS		o	GHA232002	K
	2001.04-2006.07	Hatchback Engine D4EA With ABS		o	GHA232002	K
	2001.04-2006.07	Hatchback Engine D4EA With ABS		o	GHA232008	K
	2001.04-2006.07	Hatchback Engine D4EA Without ABS		o	GHA232015	K
	2001.04-2006.07	Hatchback Engine D4EA Without ABS		o	GHA232043	
	2001.04-2006.07	Saloon Engine D4EA	•		GHA425027	
	2001.04-2006.07	Saloon Engine D4EA	•		GHA427002	
	2001.04-2006.07	Saloon Engine D4EA	•		GHA427006	
	2001.04-2006.07	Saloon Engine D4EA	•		GWB3909	
	2001.04-2006.07	Saloon Engine D4EA		o	GHA232044	
	2001.04-2006.07	Saloon Engine D4EA		o	GHA232047	
	2001.04-2006.07	Saloon Engine D4EA With ABS		o	GHA232002	K
	2001.04-2006.07	Saloon Engine D4EA With ABS		o	GHA232002	K
	2001.04-2006.07	Saloon Engine D4EA With ABS		o	GHA232008	K
	2001.04-2006.07	Saloon Engine D4EA Without ABS		o	GHA232015	K
	2001.04-2006.07	Saloon Engine D4EA Without ABS		o	GHA232043	
EQUUS						
-				o	GHA238002	
EQUUS NEW						
-	2009-		•		GHA400256	
GALLOPER I						
2.5 TD (62 kW)	1991.08-1998.07	Closed Off-Road Vehicle Engine 4D56T	•		GWB1915	
2.5 TD intercooler (70 kW)	1991.08-1998.07	Closed Off-Road Vehicle Engine 4D56T	•		GWB1915	
3.0 V6 (104 kW)	1991.08-1998.07	Closed Off-Road Vehicle Engine 6G72	•		GWB1915	
GENESIS						
-	2009-		•		GHA400256	



	 YEAR		F	R	G-AP Ref.	KIT
HYUNDAI						
GETZ (TB)						
1.1 (46 kW)	2002.09-2005.09	Hatchback Engine G4HD	•		GHA425002	
	2002.09-2005.09	Hatchback Engine G4HD	•		GWB3907	
	2002.09-2005.09	Hatchback Engine G4HD		○	GHA400158	K
	2002.09-2005.09	Hatchback Engine G4HD With ABS		○	GHA400130	K
	2002.09-2005.09	Hatchback Engine G4HD Without ABS		○	GHA400100	
1.1 (49 kW)	2005.10-2008.02	Hatchback Engine G4HD	•		GHA425002	
	2005.10-2008.02	Hatchback Engine G4HD	•		GWB3907	
	2005.10-2008.02	Hatchback Engine G4HD		○	GHA400158	K
	2005.10-2008.02	Hatchback Engine G4HD With ABS		○	GHA400130	K
	2005.10-2008.02	Hatchback Engine G4HD Without ABS		○	GHA400100	
1.3 (61 kW)	2004.09-2009.06	Hatchback Engine G4EA	•		GHA425002	
1.3 (63 kW)	2003.09-2005.09	Hatchback Engine G4EA	•		GHA425002	
	2003.09-2005.09	Hatchback Engine G4EA	•		GWB3907	
	2003.09-2005.09	Hatchback Engine G4EA		○	GHA400158	K
	2003.09-2005.09	Hatchback Engine G4EA With ABS		○	GHA400130	K
1.3 i (60 kW)	2002.09-2004.03	Hatchback Engine G4EA	•		GHA425002	
	2002.09-2004.03	Hatchback Engine G4EA	•		GWB3907	
	2002.09-2004.03	Hatchback Engine G4EA		○	GHA400158	K
	2002.09-2004.03	Hatchback Engine G4EA With ABS		○	GHA400130	K
	2002.09-2004.03	Hatchback Engine G4EA Without ABS		○	GHA400100	
1.4 i (71 kW)	2005.08-2009.06	Hatchback Engine G4EE	•		GHA425002	
	2005.08-2009.06	Hatchback Engine G4EE	•		GWB3907	
	2005.08-2009.06	Hatchback Engine G4EE		○	GHA400158	K
	2005.08-2009.06	Hatchback Engine G4EE With ABS		○	GHA400130	K
	2005.08-2009.06	Hatchback Engine G4EE Without ABS		○	GHA400100	
1.5 CRDi (60 kW)	2003.03-2005.09	Hatchback Engine D3-EA	•		GHA425002	
	2003.03-2005.09	Hatchback Engine D3-EA	•		GWB3907	
	2003.03-2005.09	Hatchback Engine D3-EA		○	GHA400158	K
	2003.03-2005.09	Hatchback Engine D3-EA With ABS		○	GHA400130	K
	2003.03-2005.09	Hatchback Engine D3-EA Without ABS		○	GHA400100	
1.5 CRDi (65 kW)	2005.08-2009.06	Hatchback Engine D4FA	•		GHA425002	
	2005.08-2009.06	Hatchback Engine D4FA	•		GWB3907	
	2005.08-2009.06	Hatchback Engine D4FA		○	GHA400158	K
	2005.08-2009.06	Hatchback Engine D4FA With ABS		○	GHA400130	K
	2005.08-2009.06	Hatchback Engine D4FA Without ABS		○	GHA400100	
1.5 CRDi GLS (81 kW)	2005.08-2009.06	Hatchback Engine D4FA	•		GHA425002	
	2005.08-2009.06	Hatchback Engine D4FA	•		GWB3907	
	2005.08-2009.06	Hatchback Engine D4FA		○	GHA400158	K
	2005.08-2009.06	Hatchback Engine D4FA With ABS		○	GHA400130	K
	2005.08-2009.06	Hatchback Engine D4FA Without ABS		○	GHA400100	
1.6 (77 kW)	2002.09-2005.09	Hatchback Engine G4ED-G	•		GHA425002	
	2002.09-2005.09	Hatchback Engine G4ED-G	•		GWB3907	
	2002.09-2005.09	Hatchback Engine G4ED-G		○	GHA400158	K
	2002.09-2005.09	Hatchback Engine G4ED-G With ABS		○	GHA400130	K
	2002.09-2005.09	Hatchback Engine G4ED-G Without ABS		○	GHA400100	
1.6 (78 kW)	2005.08-2009.06	Hatchback Engine G4ED-G	•		GHA425002	
	2005.08-2009.06	Hatchback Engine G4ED-G	•		GWB3907	
	2005.08-2009.06	Hatchback Engine G4ED-G		○	GHA400158	K
	2005.08-2009.06	Hatchback Engine G4ED-G With ABS		○	GHA400130	K
	2005.08-2009.06	Hatchback Engine G4ED-G Without ABS		○	GHA400100	
GRAND SANTA FÉ						
2.2 CRDi All-wheel Drive (145 kW)	2013.06-	Closed Off-Road Vehicle Engine D4HB	•		GHA330009	
GRANDEUR (HG)						
2.4 (132 kW)	2011.07-	Saloon Engine G4KE	•		GWB6891	
	2011.07-	Saloon Engine G4KE		○	GHA400258	
2.4 16V (148 kW)	2011.01-	Saloon Engine G4KJ	•		GWB6891	
	2011.01-	Saloon Engine G4KJ		○	GHA400258	
3.0 (184 kW)	2011.07-	Saloon Engine G6DG	•		GWB6891	
	2011.07-	Saloon Engine G6DG		○	GHA400258	
GRANDEUR (TG)						
2.2 CRDi (110 kW)	2006.06-	Saloon Engine D4EB	•		GWB6938	
2.2 CRDi (114 kW)	2006.06-	Saloon Engine D4EB	•		GWB6938	
2.4 (121 kW)	2006.09-	Saloon Engine G4KC	•		GHA427021	
2.7 (141 kW)	2006.05-	Saloon Engine G6BA	•		GHA427021	



	 YEAR		F	R	G-AP Ref.	KIT
HYUNDAI						
GRANDEUR (TG)						
2.7 (141 kW)	2006.05-	Saloon Engine G6BA	•		GWB6938	
3.3 (173 kW)	2006.10-	Saloon Engine G6DB	•		GWB6938	
GRANDEUR NEW						
-		With ABS		○	GHA233013	
		Without ABS		○	GHA233014	
GRANDEUR TG(AZERA)						
-	2005-2007			○	GHA400264	
GRANDEUR XG						
-	2002-2005			○	GHA400263	
H-1						
2.4 (82 kW)	2000.03-2004.04	Box Engine G4CS	•		GWB1369	
2.5 CRDi (103 kW)	2003.08-2004.04	Box Engine D4CB	•		GWB1369	
2.5 CRDi (81 kW)	2001.07-2004.04	Box Engine D4CB	•		GWB1369	
2.5 D (73 kW)	2000.06-2005.1	Platform/Chassis Engine D4BH	•		GWB1369	
2.5 TD (59 kW)	2000.03-2000.09	Box Engine D4BF	•		GWB1369	
2.5 TD (73 kW)	2000.03-2004.04	Box Engine D4BH	•		GWB1369	
2.5 TD (74 kW)	2001.10-2004.04	Box Engine D4BH	•		GWB1369	
H-1 / STAREX						
2.4 (107 kW)	2001.11-2004.04	MPV Engine G4JS	•		GWB1369	
2.4 (82 kW)	1997.06-2004.04	MPV Engine G4CS	•		GWB1369	
2.5 CRDi (103 kW)	2002.12-2004.04	MPV Engine D4CB	•		GWB1369	
2.5 CRDi (120 kW)	2002.12-2004.04	MPV	•		GWB1369	
2.5 CRDi (81 kW)	2006.06-2007.12	MPV Engine D4CB	•		GWB1369	
2.5 CRDi (85 kW)	1997.06-2004.04	MPV Engine D4CB	•		GWB1369	
2.5 D (57 kW)	1997.10-2004.04	Bus Engine D4BF	•		GWB1369	
2.5 D (62 kW)	1997.10-2004.04	MPV Engine D4BF	•		GWB1369	
2.5 Tci (73 kW)	1997.10-2007.12	MPV Engine D4BH	•		GWB1369	
2.5 Tci (74 kW)	2004.05-2007.12	MPV Engine D4BH	•		GWB1369	
2.5 TD (59 kW)	1997.06-2004.04	MPV Engine D4BF	•		GWB1369	
2.6 TDiC (63 kW)	1997.10-2004.04	MPV Engine D4BB	•		GWB1369	
H-1 CARGO (TQ)						
2.5 CRDi (100 kW)	2009.08-	Box Engine D4CB-X With ABS	•		GHA245011	
	2009.08-	Box Engine D4CB-X Without ABS	•		GHA245019	
2.5 CRDi (120 kW)	2008.02-	Box Engine D4CB-L With ABS	•		GHA245011	
	2008.02-	Box Engine D4CB-L Without ABS	•		GHA245019	
2.5 CRDi (125 kW)	2008.02-	Box Engine D4CB With ABS	•		GHA245011	
	2008.02-	Box Engine D4CB Without ABS	•		GHA245019	
2.5 CRDi (81 kW)	2008.02-	Box Engine D4CB With ABS	•		GHA245011	
	2008.02-	Box Engine D4CB Without ABS	•		GHA245019	
2.5 CRDi (85 kW)	2011.08-	Box Engine D4CB With ABS	•		GHA245011	
	2011.08-	Box Engine D4CB Without ABS	•		GHA245019	
H-1 TRAVEL (TQ)						
2.4 i (129 kW)	2008.02-	Bus Engine G4KC With ABS	•		GHA245011	
	2008.02-	Bus Engine G4KC Without ABS	•		GHA245019	
2.5 CRDi (100 kW)	2008.07-	Bus Engine D4CB With ABS	•		GHA245011	
	2008.07-	Bus Engine D4CB Without ABS	•		GHA245019	
2.5 CRDi (120 kW)	2008.05-	Bus Engine D4CB With ABS	•		GHA245011	
	2008.05-	Bus Engine D4CB Without ABS	•		GHA245019	
2.5 CRDi (125 kW)	2008.05-	Bus Engine D4CB With ABS	•		GHA245011	
	2008.05-	Bus Engine D4CB Without ABS	•		GHA245019	
2.5 CRDi (85 kW)	2011.08-	Bus Engine D4CB With ABS	•		GHA245011	
	2011.08-	Bus Engine D4CB Without ABS	•		GHA245019	
H100						
2.4 (82 kW)	1997.10-2004.12	Box Engine G4CS	•		GWB1369	
2.5 D (55 kW)	1993.07-1994.12	Box Engine D4BA/D4BX	•		GWB1369	
2.5 D (57 kW)	1994.12-2000.03	Box Engine D4BA	•		GWB1369	
H100 (P)						
2.4 (84 kW)	1997.01-2000.03	Bus Engine G4CS	•		GWB1369	
2.4 (90 kW)	1993.07-2000.03	Bus Engine G4CS	•		GWB1369	
2.5 D (55 kW)	1993.07-1994.12	Bus Engine D4BA/D4BX	•		GWB1369	
2.5 D (57 kW)	1994.12-2000.03	Bus Engine D4BA	•		GWB1369	
2.5 TD (59 kW)	1993.07-2000.03	Bus Engine D4BF	•		GWB1369	



	 YEAR		F	R	G-AP Ref.	KIT
HYUNDAI						
i10 (PA)						
1.0 (51 kW)	2011.01-	Hatchback Engine G3LA	•		GWB6931	
	2011.01-	Hatchback Engine G3LA With ABS		◦	GHA400130	K
1.1 (48 kW)	2007.12-	Hatchback Engine G4HG	•		GHA424019	
	2007.12-	Hatchback Engine G4HG	•		GWB6931	
	2007.12-	Hatchback Engine G4HG With ABS		◦	GHA400130	K
1.1 (49 kW)	2008.01-	Hatchback Engine G4HG	•		GHA424019	
	2008.01-	Hatchback Engine G4HG	•		GWB6931	
	2008.01-	Hatchback Engine G4HG With ABS		◦	GHA400130	K
1.1 (51 kW)	2011.04-	Hatchback Engine G4HG	•		GWB6931	
	2011.04-	Hatchback Engine G4HG With ABS		◦	GHA400130	K
1.1 CRDi (55 kW)	2008.01-	Hatchback Engine D3FA	•		GHA424019	
	2008.01-	Hatchback Engine D3FA	•		GWB6931	
	2008.01-	Hatchback Engine D3FA With ABS		◦	GHA400130	K
1.2 (57 kW)	2008.11-	Hatchback Engine G4LA	•		GHA425036	
	2008.11-	Hatchback Engine G4LA	•		GWB6931	
	2008.11-	Hatchback Engine G4LA With ABS		◦	GHA400130	K
1.2 (63 kW)	2011.04-	Hatchback Engine G4LA	•		GHA425036	
	2011.04-	Hatchback Engine G4LA	•		GWB6931	
	2011.04-	Hatchback Engine G4LA With ABS		◦	GHA400130	K
i20						
1.4 (74 kW)	2015.05-	Coupe Engine G4LC	•		GHA425036	
1.4 CRDi (66 kW)	2015.05-	Coupe Engine D4FC	•		GHA425036	
i20 (GB)						
1.2 (55 kW)	2014.11-	Hatchback Engine G4LA	•		GHA425036	
1.2 (62 kW)	2014.11-	Hatchback Engine G4LA	•		GHA425036	
1.4 (74 kW)	2014.11-	Hatchback Engine G4LC	•		GHA425036	
1.4 CRDi (66 kW)	2014.11-	Hatchback Engine D4FC	•		GHA425036	
i20 (PB, PBT)						
1.1 CRDi (55 kW)	2012.03-	Hatchback Engine D3FA	•		GHA425036	
	2012.03-	Hatchback Engine D3FA	•		GWB7545	
	2012.03-	Hatchback Engine D3FA With ABS		◦	GHA400130	K
1.2 (57 kW)	2008.09-	Hatchback Engine G4LA	•		GHA425036	
	2008.09-	Hatchback Engine G4LA	•		GWB7545	
	2008.09-	Hatchback Engine G4LA With ABS		◦	GHA400130	K
1.2 (63 kW)	2012.03-	Hatchback Engine G4LA	•		GHA425036	
	2012.03-	Hatchback Engine G4LA	•		GWB7545	
	2012.03-	Hatchback Engine G4LA With ABS		◦	GHA400130	K
1.4 (74 kW)	2008.09-	Hatchback Engine G4FA	•		GHA425036	
	2008.09-	Hatchback Engine G4FA	•		GWB7545	
	2008.09-	Hatchback Engine G4FA With ABS		◦	GHA400130	K
1.4 CRDi (55 kW)	2009.08-	Hatchback Engine D4FC	•		GHA425036	
	2009.08-	Hatchback Engine D4FC	•		GWB7545	
	2009.08-	Hatchback Engine D4FC With ABS		◦	GHA400130	K
1.4 CRDi (66 kW)	2008.08-	Hatchback Engine D4FC	•		GHA425036	
	2008.08-	Hatchback Engine D4FC	•		GWB7545	
	2008.08-	Hatchback Engine D4FC With ABS		◦	GHA400130	K
1.6 (93 kW)	2008.09-	Hatchback Engine G4FC	•		GHA425036	
	2008.09-	Hatchback Engine G4FC	•		GWB7545	
	2008.09-	Hatchback Engine G4FC With ABS		◦	GHA400130	K
1.6 CRDi (85 kW)	2008.09-	Hatchback Engine D4FB	•		GHA425036	
	2008.09-	Hatchback Engine D4FB	•		GWB7545	
	2008.09-	Hatchback Engine D4FB With ABS		◦	GHA400130	K
1.6 CRDi (94 kW)	2009.01-	Hatchback Engine D4FB	•		GHA425036	
	2009.01-	Hatchback Engine D4FB	•		GWB7545	
	2009.01-	Hatchback Engine D4FB With ABS		◦	GHA400130	K
i30 (FD)						
1.4 (77 kW)	2007.10-2011.11	Hatchback Engine G4FA	•		GHA427010	
	2007.10-2011.11	Hatchback Engine G4FA	•		GWB6923	
	2007.10-2011.11	Hatchback Engine G4FA With ABS		◦	GHA400131	
1.4 (80 kW)	2007.10-2011.11	Hatchback Engine D4FA	•		GHA427010	
	2007.10-2011.11	Hatchback Engine D4FA	•		GWB6923	
	2007.10-2011.11	Hatchback Engine D4FA With ABS		◦	GHA400131	
1.6 (85 kW)	2007.10-2011.11	Hatchback Engine G4FC	•		GHA427010	
	2007.10-2011.11	Hatchback Engine G4FC	•		GWB6923	



	 YEAR		F	R	G-AP Ref.	KIT
HYUNDAI						
i30 (FD)						
1.6 (85 kW)	2007.10-2011.11	Hatchback Engine G4FC With ABS		o	GHA400131	
1.6 (90 kW)	2007.10-2011.11	Hatchback Engine G4FC	•		GHA427010	
	2007.10-2011.11	Hatchback Engine G4FC	•		GWB6923	
	2007.10-2011.11	Hatchback Engine G4FC With ABS		o	GHA400131	
1.6 (93 kW)	2008.02-2011.11	Hatchback Engine G4FC	•		GHA427010	
	2008.02-2011.11	Hatchback Engine G4FC	•		GWB6923	
	2008.02-2011.11	Hatchback Engine G4FC With ABS		o	GHA400131	
1.6 CRDi (66 kW)	2007.10-2011.11	Hatchback Engine D4FB	•		GHA427010	
	2007.10-2011.11	Hatchback Engine D4FB	•		GWB6923	
	2007.10-2011.11	Hatchback Engine D4FB With ABS		o	GHA400131	
1.6 CRDi (85 kW)	2007.10-2011.11	Hatchback Engine D4FB	•		GHA427010	
	2007.10-2011.11	Hatchback Engine D4FB	•		GWB6923	
	2007.10-2011.11	Hatchback Engine D4FB With ABS		o	GHA400131	
1.6 CRDi (94 kW)	2010.01-2011.11	Hatchback Engine D4FB	•		GHA427010	
	2010.01-2011.11	Hatchback Engine D4FB	•		GWB6923	
	2010.01-2011.11	Hatchback Engine D4FB With ABS		o	GHA400131	
2.0 (105 kW)	2007.10-2011.11	Hatchback Engine G4GC-G	•		GHA427010	
	2007.10-2011.11	Hatchback Engine G4GC-G	•		GWB6923	
	2007.10-2011.11	Hatchback Engine G4GC-G With ABS		o	GHA400131	
2.0 CRDi (100 kW)	2007.10-2011.11	Hatchback Engine D4EA	•		GHA427010	
	2007.10-2011.11	Hatchback Engine D4EA	•		GWB6923	
	2007.10-2011.11	Hatchback Engine D4EA With ABS		o	GHA400131	
2.0 CRDi (103 kW)	2007.10-2011.11	Hatchback Engine D4EA	•		GHA427010	
	2007.10-2011.11	Hatchback Engine D4EA	•		GWB6923	
	2007.10-2011.11	Hatchback Engine D4EA With ABS		o	GHA400131	
i30 (GD)						
1.4 (73 kW)	2011.11-	Hatchback Engine G4FA	•		GHA427010	
	2011.11-	Hatchback Engine G4FA With ABS		o	GHA400131	
1.4 CRDi (66 kW)	2011.11-	Hatchback Engine D4FC With ABS		o	GHA400131	
1.6 (88 kW)	2012.01-	Hatchback Engine G4FC	•		GHA427010	
	2012.01-	Hatchback Engine G4FC With ABS		o	GHA400131	
i30 (GD)						
1.6 CRDi (100 kW)	2011.11-	Hatchback Engine D4FB	•		GHA427010	
i30 (GD)						
1.6 CRDi (81 kW)	2012.06-	Hatchback Engine D4FB	•		GHA427010	
	2012.06-	Hatchback Engine D4FB With ABS		o	GHA400131	
1.6 CRDi (94 kW)	2011.11-	Hatchback Engine D4FB	•		GHA427010	
	2011.11-	Hatchback Engine D4FB With ABS		o	GHA400131	
1.6 GDi (95 kW)	2011.11-	Hatchback Engine G4FG	•		GHA427010	
	2011.11-	Hatchback Engine G4FG With ABS		o	GHA400131	
1.6 GDi (99 kW)	2011.11-	Hatchback Engine G4FD	•		GHA427010	
	2011.11-	Hatchback Engine G4FD With ABS		o	GHA400131	
i30 CW (FD)						
1.4 (77 kW)	2007.10-2012.06	Estate Engine G4FA	•		GHA427010	
	2007.10-2012.06	Estate Engine G4FA	•		GWB6923	
	2007.10-2012.06	Estate Engine G4FA With ABS		o	GHA400131	
1.4 (80 kW)	2009.11-2012.06	Estate Engine G4FA	•		GHA427010	
	2009.11-2012.06	Estate Engine G4FA	•		GWB6923	
	2009.11-2012.06	Estate Engine G4FA With ABS		o	GHA400131	
1.6 (85 kW)	2008.02-2012.06	Estate Engine G4FC	•		GHA427010	
	2008.02-2012.06	Estate Engine G4FC	•		GWB6923	
	2008.02-2012.06	Estate Engine G4FC With ABS		o	GHA400131	
1.6 (90 kW)	2008.02-2012.06	Estate Engine G4FC	•		GHA427010	
	2008.02-2012.06	Estate Engine G4FC	•		GWB6923	
	2008.02-2012.06	Estate Engine G4FC With ABS		o	GHA400131	
1.6 (93 kW)	2008.02-2012.06	Estate Engine G4FC	•		GHA427010	
	2008.02-2012.06	Estate Engine G4FC	•		GWB6923	
	2008.02-2012.06	Estate Engine G4FC With ABS		o	GHA400131	
1.6 CRDi (66 kW)	2008.02-2012.06	Estate Engine D4FB	•		GHA427010	
	2008.02-2012.06	Estate Engine D4FB	•		GWB6923	
	2008.02-2012.06	Estate Engine D4FB With ABS		o	GHA400131	
1.6 CRDi (85 kW)	2008.02-2012.06	Estate Engine D4FB	•		GHA427010	
	2008.02-2012.06	Estate Engine D4FB	•		GWB6923	
	2008.02-2012.06	Estate Engine D4FB With ABS		o	GHA400131	



	 YEAR		F	R	G-AP Ref.	KIT
HYUNDAI						
i30 CW (FD)						
1.6 CRDi (94 kW)	2010.01-2012.06	Estate Engine D4FB	•		GHA427010	
	2010.01-2012.06	Estate Engine D4FB	•		GWB6923	
	2010.01-2012.06	Estate Engine D4FB With ABS		○	GHA400131	
2.0 (105 kW)	2008.02-2012.06	Estate Engine G4GC-G	•		GHA427010	
	2008.02-2012.06	Estate Engine G4GC-G	•		GWB6923	
	2008.02-2012.06	Estate Engine G4GC-G With ABS		○	GHA400131	
2.0 CRDi (100 kW)	2008.10-2012.06	Estate Engine D4EA	•		GHA427010	
	2008.10-2012.06	Estate Engine D4EA	•		GWB6923	
	2008.10-2012.06	Estate Engine D4EA With ABS		○	GHA400131	
2.0 CRDi (103 kW)	2008.02-2012.06	Estate Engine D4EA	•		GHA427010	
	2008.02-2012.06	Estate Engine D4EA	•		GWB6923	
	2008.02-2012.06	Estate Engine D4EA With ABS		○	GHA400131	
i30 CW (GD)						
1.4 (73 kW)	2012.06-	Estate Engine G4FA With ABS		○	GHA400131	
1.4 CRDi (66 kW)	2012.06-	Estate Engine D4FC With ABS		○	GHA400131	
1.6 (88 kW)	2012.06-	Estate Engine G4FG With ABS		○	GHA400131	
1.6 (95 kW)	2012.06-	Estate Engine G4FG With ABS		○	GHA400131	
1.6 CRDi (81 kW)	2012.06-	Estate Engine D4FB With ABS		○	GHA400131	
1.6 CRDi (94 kW)	2012.06-	Estate Engine D4FB-5P With ABS		○	GHA400131	
1.6 GDi (99 kW)	2012.06-	Estate Engine G4FD With ABS		○	GHA400131	
i40 (VF)						
	2012.03-	Saloon Engine G4FD	•		GHA427021	
	2012.03-	Saloon Engine G4FD	•		GWB6891	
	2012.03-	Saloon Engine G4FD		○	GHA400258	
1.7 CRDi (100 kW)	2012.03-	Saloon Engine D4FD	•		GHA427021	
	2012.03-	Saloon Engine D4FD	•		GWB6891	
	2012.03-	Saloon Engine D4FD		○	GHA400258	
i40 (VF)						
1.7 CRDi (104 kW)	2015.01-	Saloon Engine D4FD	•		GHA427021	
i40 (VF)						
1.7 CRDi (85 kW)	2012.03-	Saloon Engine D4FD	•		GHA427021	
	2012.03-	Saloon Engine D4FD	•		GWB6891	
	2012.03-	Saloon Engine D4FD		○	GHA400258	
i40 (VF)						
2.0 GDi (121 kW)	2012.03-	Saloon Engine G4NA	•		GHA427021	
i40 (VF)						
2.0 GDi (131 kW)	2012.03-	Saloon Engine G4NC	•		GHA427021	
	2012.03-	Saloon Engine G4NC	•		GWB6891	
	2012.03-	Saloon Engine G4NC		○	GHA400258	
i40 CW (VF)						
1.6 GDi (99 kW)	2011.07-	Estate Engine G4FD	•		GHA427021	
	2011.07-	Estate Engine G4FD	•		GWB6891	
	2011.07-	Estate Engine G4FD		○	GHA400258	
1.7 CRDi (100 kW)	2011.07-	Estate Engine D4FD	•		GHA427021	
	2011.07-	Estate Engine D4FD	•		GWB6891	
	2011.07-	Estate Engine D4FD		○	GHA400258	
i40 CW (VF)						
1.7 CRDi (104 kW)	2015.01-	Estate Engine D4FD	•		GHA427021	
i40 CW (VF)						
1.7 CRDi (85 kW)	2011.07-	Estate Engine D4FD	•		GHA427021	
	2011.07-	Estate Engine D4FD	•		GWB6891	
	2011.07-	Estate Engine D4FD		○	GHA400258	
i40 CW (VF)						
2.0 GDi (121 kW)	2012.03-	Estate Engine G4NA	•		GHA427021	
i40 CW (VF)						
2.0 GDi (130 kW)	2011.07-	Estate Engine G4NC	•		GHA427021	
	2011.07-	Estate Engine G4NC	•		GWB6891	
	2011.07-	Estate Engine G4NC		○	GHA400258	
ix20 (JC)						
1.4 (66 kW)	2010.11-	Hatchback Engine G4FA	•		GWB6923	
	2010.11-	Hatchback Engine G4FA		○	GHA400260	
1.4 CRDi (57 kW)	2011.06-	Hatchback Engine D4FC-M	•		GWB6923	
	2011.06-	Hatchback Engine D4FC-M		○	GHA400260	



	 YEAR		F	R	G-AP Ref.	KIT
HYUNDAI						
ix20 (JC)						
1.4 CRDi (66 kW)	2010.11-	Hatchback Engine D4FC	•		GWB6923	
	2010.11-	Hatchback Engine D4FC		◦	GHA400260	
1.6 (92 kW)	2010.11-	Hatchback Engine G4FC	•		GWB6923	
	2010.11-	Hatchback Engine G4FC		◦	GHA400260	
1.6 CRDi (85 kW)	2011.06-	Hatchback Engine D4FB	•		GWB6923	
	2011.06-	Hatchback Engine D4FB		◦	GHA400260	
1.6 CRDi (94 kW)	2011.06-	Hatchback Engine D4FB	•		GWB6923	
	2011.06-	Hatchback Engine D4FB		◦	GHA400260	
ix35 (LM, EL, ELH)						
1.6 (99 kW)	2010.11-	Closed Off-Road Vehicle Engine G4FD	•		GHA427021	
	2010.11-	Closed Off-Road Vehicle Engine G4FD	•		GWB6891	
	2010.11-	Closed Off-Road Vehicle Engine G4FD		◦	GHA400258	
1.7 CRDi (85 kW)	2010.11-	Closed Off-Road Vehicle Engine D4FD	•		GWB6891	
	2010.11-	Closed Off-Road Vehicle Engine D4FD		◦	GHA400258	
2.0 (120 kW)	2010.01-	Closed Off-Road Vehicle Engine G4KD	•		GHA427021	
	2010.01-	Closed Off-Road Vehicle Engine G4KD	•		GWB6891	
	2010.01-	Closed Off-Road Vehicle Engine G4KD		◦	GHA400258	
2.0 4WD (120 kW)	2010.01-	Closed Off-Road Vehicle Engine G4KD	•		GHA427021	
	2010.01-	Closed Off-Road Vehicle Engine G4KD	•		GWB6891	
	2010.01-	Closed Off-Road Vehicle Engine G4KD		◦	GHA427004	
2.0 CRDi (100 kW)	2010.01-	Closed Off-Road Vehicle Engine D4HA	•		GHA427021	
	2010.01-	Closed Off-Road Vehicle Engine D4HA	•		GWB6891	
	2010.01-	Closed Off-Road Vehicle Engine D4HA		◦	GHA400258	
IX35 (LM, EL, ELH)						
2.0 CRDi (130 kW)	2012.01-	Closed Off-Road Vehicle Engine D4HA	•		GHA427021	
	2012.01-	Closed Off-Road Vehicle Engine D4HA	•		GWB6891	
	2012.01-	Closed Off-Road Vehicle Engine D4HA		◦	GHA400258	
ix35 (LM, EL, ELH)						
2.0 CRDi (135 kW)	2012.01-	Closed Off-Road Vehicle Engine D4HA	•		GHA427021	
	2012.01-	Closed Off-Road Vehicle Engine D4HA	•		GWB6891	
	2012.01-	Closed Off-Road Vehicle Engine D4HA		◦	GHA400258	
2.0 CRDi 4WD (100 kW)	2010.01-	Closed Off-Road Vehicle Engine D4HA	•		GHA427021	
	2010.01-	Closed Off-Road Vehicle Engine D4HA	•		GWB6891	
	2010.01-	Closed Off-Road Vehicle Engine D4HA		◦	GHA427004	
2.0 CRDi 4WD (135 kW)	2010.01-	Closed Off-Road Vehicle Engine D4HA	•		GHA427021	
	2010.01-	Closed Off-Road Vehicle Engine D4HA	•		GWB6891	
	2010.01-	Closed Off-Road Vehicle Engine D4HA		◦	GHA427004	
IX35 (LM, EL, ELH)						
2.0 CVVT (110 kW)	2009.08-	Closed Off-Road Vehicle Engine G4KD	•		GHA427021	
2.0 GDi (122 kW)	2013.08-	Closed Off-Road Vehicle Engine G4NC	•		GHA427021	
	2013.08-	Closed Off-Road Vehicle Engine G4NC	•		GWB6891	
	2013.08-	Closed Off-Road Vehicle Engine G4NC		◦	GHA400258	
2.0 GDi 4WD (122 kW)	2013.08-	Closed Off-Road Vehicle Engine G4NC	•		GHA427021	
	2013.08-	Closed Off-Road Vehicle Engine G4NC	•		GWB6891	
	2013.08-	Closed Off-Road Vehicle Engine G4NC		◦	GHA427004	
2.4 DCVVT-i 4WD (128 kW)	2010.07-2013.12	Closed Off-Road Vehicle Engine G4KE	•		GHA427021	
	2010.07-2013.12	Closed Off-Road Vehicle Engine G4KE		◦	GHA427004	
2.4 GDi 4WD (136 kW)	2013.01-	Closed Off-Road Vehicle Engine G4KJ	•		GHA427021	
	2013.01-	Closed Off-Road Vehicle Engine G4KJ		◦	GHA427004	
FCEV (53 kW)	2012.10-	Closed Off-Road Vehicle	•		GHA427021	
Fuel Cell (53 kW)	2014.09-	Closed Off-Road Vehicle	•		GHA427021	
ix55						
3.0 V6 CRDi 4WD (176 kW)	2008.09-	Closed Off-Road Vehicle Engine D6EA	•		GHA330009	
3.0 V6 CRDi 4WD (184 kW)	2011.09-	Closed Off-Road Vehicle Engine D6EB	•		GHA330009	
IX55						
3.8 V6 (194 kW)	2011.01-	Closed Off-Road Vehicle Engine G6DA	•		GHA330009	
ix55						
3.8 V6 4WD (194 kW)	2011.01-	Closed Off-Road Vehicle	•		GHA330009	
LANTRA (GK)						
1.6 16V (77 kW)	2006.11-2009.08	Coupe Engine G4ED-G	•		GWB6812	
	2006.11-2009.08	Coupe Engine G4ED-G With ABS		◦	GHA232024	K
	2006.11-2009.08	Coupe Engine G4ED-G With ABS		◦	GHA232037	K
	2006.11-2009.08	Coupe Engine G4ED-G Without ABS		◦	GHA232040	K



	 YEAR		F	R	G-AP Ref.	KIT
HYUNDAI						
LANTRA (GK)						
1.6 16V (77 kW)	2006.11-2009.08	Coupe Engine G4ED-G Without ABS		o	GHA232042	
1.6 16V (79 kW)	2002.03-2009.08	Coupe Engine G4ED-G	•		GWB6812	
	2002.03-2009.08	Coupe Engine G4ED-G With ABS		o	GHA232024	K
	2002.03-2009.08	Coupe Engine G4ED-G With ABS		o	GHA232037	K
	2002.03-2009.08	Coupe Engine G4ED-G Without ABS		o	GHA232040	K
	2002.03-2009.08	Coupe Engine G4ED-G Without ABS		o	GHA232042	
2.0 (100 kW)	2001.08-2009.08	Coupe Engine G4GC-G	•		GWB6812	
	2001.08-2009.08	Coupe Engine G4GC-G With ABS		o	GHA232024	K
	2001.08-2009.08	Coupe Engine G4GC-G With ABS		o	GHA232037	K
	2001.08-2009.08	Coupe Engine G4GC-G Without ABS		o	GHA232040	K
2.0 (102 kW)	2002.03-2009.08	Coupe Engine G4GC-G	•		GWB6812	
	2002.03-2009.08	Coupe Engine G4GC-G With ABS		o	GHA232037	K
	2002.03-2009.08	Coupe Engine G4GC-G Without ABS		o	GHA232040	K
	2002.03-2009.08	Coupe Engine G4GC-G Without ABS		o	GHA232042	
2.0 GLS (105 kW)	2005.01-2007.03	Coupe Engine G4GC-G	•		GWB6812	
	2005.01-2007.03	Coupe Engine G4GC-G With ABS		o	GHA232024	K
	2005.01-2007.03	Coupe Engine G4GC-G With ABS		o	GHA232037	K
	2005.01-2007.03	Coupe Engine G4GC-G Without ABS		o	GHA232040	K
2.7 V6 (121 kW)	2007.01-2009.08	Coupe Engine G6BA-G	•		GWB3909	
	2007.01-2009.08	Coupe Engine G6BA-G With ABS		o	GHA232037	K
2.7 V6 (123 kW)	2002.03-2009.08	Coupe Engine G6BA-G	•		GWB3909	
	2002.03-2009.08	Coupe Engine G6BA-G With ABS		o	GHA232024	K
	2002.03-2009.08	Coupe Engine G6BA-G With ABS		o	GHA232037	K
	2002.03-2009.08	Coupe Engine G6BA-G Without ABS		o	GHA232040	K
	2002.03-2009.08	Coupe Engine G6BA-G Without ABS		o	GHA232042	
LANTRA (J-1)						
1.5 i.e. (63 kW)	1990.10-1995.11	Saloon Engine G15B/G4DJ	•		GWB1366	
1.6 i.e. 16V (78 kW)	1990.10-1995.11	Saloon Engine G4CR	•		GWB1366	
1.6 i.e. 16V (84 kW)	1990.10-1995.11	Saloon Engine G4CR	•		GWB1366	
1.8 i.e. 16V (93 kW)	1990.10-1995.11	Saloon Engine G4CN	•		GWB1366	
LANTRA (RD)						
1.6 i 16V (84 kW)	1996.12-2002.04	Coupe Engine 4G61	•		GWB3907	
	1996.12-2002.04	Coupe Engine 4G61	•		GWB6812	
	1996.12-2002.04	Coupe Engine 4G61 With ABS		o	GHA228028	K
	1996.12-2002.04	Coupe Engine 4G61 With ABS		o	GHA228068	K
	1996.12-2002.04	Coupe Engine 4G61 Without ABS		o	GHA228014	
	1996.12-2002.04	Coupe Engine 4G61 Without ABS		o	GHA228018	K
	1996.12-2002.04	Coupe Engine 4G61 Without ABS		o	GHA228018	K
2.0 (101 kW)	1999.08-2002.01	Coupe Engine G4DF	•		GHA425044	
	1999.08-2002.01	Coupe Engine G4DF	•		GWB3907	
	1999.08-2002.01	Coupe Engine G4DF	•		GWB6812	
	1999.08-2002.01	Coupe Engine G4DF With ABS		o	GHA228068	K
2.0 16V (102 kW)	1996.08-2002.04	Coupe Engine G4GF	•		GHA425044	
	1996.08-2002.04	Coupe Engine G4GF	•		GWB3907	
	1996.08-2002.04	Coupe Engine G4GF	•		GWB6812	
	1996.08-2002.04	Coupe Engine G4GF With ABS		o	GHA228028	K
	1996.08-2002.04	Coupe Engine G4GF With ABS		o	GHA228068	K
	1996.08-2002.04	Coupe Engine G4GF Without ABS		o	GHA228014	
	1996.08-2002.04	Coupe Engine G4GF Without ABS		o	GHA228018	K
	1996.08-2002.04	Coupe Engine G4GF Without ABS		o	GHA228018	K
2.0 16V (99 kW)	2001.03-2002.04	Coupe Engine G4DF	•		GWB3907	
	2001.03-2002.04	Coupe Engine G4DF	•		GWB6812	
	2001.03-2002.04	Coupe Engine G4DF With ABS		o	GHA228068	K
	2001.03-2002.04	Coupe Engine G4DF Without ABS		o	GHA232042	
LANTRA II (J-2)						
1.5 12V (65 kW)	1996.12-2000.09	Saloon Engine G4EK	•		GHA425044	
	1996.12-2000.09	Saloon Engine G4EK	•		GHA425045	
	1996.12-2000.09	Saloon Engine G4EK	•		GWB3907	
	1996.12-2000.09	Saloon Engine G4EK With ABS		o	GHA228028	K
	1996.12-2000.09	Saloon Engine G4EK With ABS		o	GHA228068	K
	1996.12-2000.09	Saloon Engine G4EK Without ABS		o	GHA228014	
	1996.12-2000.09	Saloon Engine G4EK Without ABS		o	GHA228018	K
	1996.12-2000.09	Saloon Engine G4EK Without ABS		o	GHA228018	K
	1997.04-2000.10	Estate Engine G4EK	•		GHA425044	



	 YEAR		F	R	G-AP Ref.	KIT
HYUNDAI						
LANTRA II (J-2)						
1.5 12V (65 kW)	1997.04-2000.10	Estate Engine G4EK	•		GHA425045	
	1997.04-2000.10	Estate Engine G4EK	•		GWB3907	
	1997.04-2000.10	Estate Engine G4EK With ABS		o	GHA228028	K
	1997.04-2000.10	Estate Engine G4EK With ABS		o	GHA228068	K
	1997.04-2000.10	Estate Engine G4EK Without ABS		o	GHA228014	
	1997.04-2000.10	Estate Engine G4EK Without ABS		o	GHA228018	K
	1997.04-2000.10	Estate Engine G4EK Without ABS		o	GHA228018	K
1.6 16V (84 kW)	1995.11-2000.09	Saloon Engine 4G61	•		GHA425044	
	1995.11-2000.09	Saloon Engine 4G61	•		GHA425045	
	1995.11-2000.09	Saloon Engine 4G61	•		GWB3907	
	1995.11-2000.09	Saloon Engine 4G61 With ABS		o	GHA228028	K
	1995.11-2000.09	Saloon Engine 4G61 With ABS		o	GHA228068	K
	1995.11-2000.09	Saloon Engine 4G61 Without ABS		o	GHA228014	
	1995.11-2000.09	Saloon Engine 4G61 Without ABS		o	GHA228018	K
	1995.11-2000.09	Saloon Engine 4G61 Without ABS		o	GHA228018	K
	1996.02-2000.10	Estate Engine 4G61	•		GHA425045	
	1996.02-2000.10	Estate Engine 4G61	•		GWB3907	
	1996.02-2000.10	Estate Engine 4G61 With ABS		o	GHA228028	K
	1996.02-2000.10	Estate Engine 4G61 With ABS		o	GHA228068	K
	1996.02-2000.10	Estate Engine 4G61 Without ABS		o	GHA228014	
	1996.02-2000.10	Estate Engine 4G61 Without ABS		o	GHA228018	K
	1.6 i (66 kW)	1995.11-2000.09	Saloon Engine G4GR	•		GHA425044
1995.11-2000.09		Saloon Engine G4GR	•		GHA425045	
1995.11-2000.09		Saloon Engine G4GR	•		GWB3907	
1995.11-2000.09		Saloon Engine G4GR With ABS		o	GHA228028	K
1995.11-2000.09		Saloon Engine G4GR With ABS		o	GHA228068	K
1995.11-2000.09		Saloon Engine G4GR Without ABS		o	GHA228018	K
1995.11-2000.09		Saloon Engine G4GR Without ABS		o	GHA228018	K
1996.02-2000.10		Estate Engine G4GR	•		GHA425044	
1996.02-2000.10		Estate Engine G4GR	•		GHA425045	
1996.02-2000.10		Estate Engine G4GR	•		GWB3907	
1996.02-2000.10		Estate Engine G4GR With ABS		o	GHA228028	K
1996.02-2000.10		Estate Engine G4GR With ABS		o	GHA228068	K
1996.02-2000.10		Estate Engine G4GR Without ABS		o	GHA228018	K
1.8 16V (94 kW)	1995.11-2000.09	Saloon Engine G4GM	•		GHA425044	
	1995.11-2000.09	Saloon Engine G4GM	•		GHA425045	
	1995.11-2000.09	Saloon Engine G4GM	•		GWB3907	
	1995.11-2000.09	Saloon Engine G4GM With ABS		o	GHA228028	K
	1995.11-2000.09	Saloon Engine G4GM With ABS		o	GHA228068	K
	1995.11-2000.09	Saloon Engine G4GM Without ABS		o	GHA228014	
	1995.11-2000.09	Saloon Engine G4GM Without ABS		o	GHA228018	K
	1995.11-2000.09	Saloon Engine G4GM Without ABS		o	GHA228018	K
	1996.02-2000.10	Estate Engine G4GM	•		GHA425044	
	1996.02-2000.10	Estate Engine G4GM	•		GHA425045	
	1996.02-2000.10	Estate Engine G4GM	•		GWB3907	
	1996.02-2000.10	Estate Engine G4GM With ABS		o	GHA228028	K
	1996.02-2000.10	Estate Engine G4GM With ABS		o	GHA228068	K
1.9 D (50 kW)	1998.03-2000.09	Saloon Engine DJY	•		GHA425044	
	1998.03-2000.09	Saloon Engine DJY	•		GHA425045	
	1998.03-2000.09	Saloon Engine DJY	•		GWB3907	
	1998.03-2000.09	Saloon Engine DJY With ABS		o	GHA228028	K
	1998.03-2000.09	Saloon Engine DJY With ABS		o	GHA228068	K
	1998.03-2000.09	Saloon Engine DJY Without ABS		o	GHA228014	
	1998.03-2000.09	Saloon Engine DJY Without ABS		o	GHA228018	K
	1998.03-2000.09	Saloon Engine DJY Without ABS		o	GHA228018	K
	1998.03-2000.10	Estate Engine DJY	•		GHA425044	
	1998.03-2000.10	Estate Engine DJY	•		GHA425045	
	1998.03-2000.10	Estate Engine DJY	•		GWB3907	
	1998.03-2000.10	Estate Engine DJY With ABS		o	GHA228028	K
	1998.03-2000.10	Estate Engine DJY With ABS		o	GHA228068	K



	 YEAR		F	R	G-AP Ref.	KIT
HYUNDAI						
LANTRA II (J-2)						
1.9 D (50 kW)	1998.03-2000.10	Estate Engine DJY Without ABS		o	GHA228014	
	1998.03-2000.10	Estate Engine DJY Without ABS		o	GHA228018	K
	1998.03-2000.10	Estate Engine DJY Without ABS		o	GHA228018	K
2.0 (100 kW)	1997.04-2000.05	Saloon Engine G4JP	•		GHA425044	
	1997.04-2000.05	Saloon Engine G4JP	•		GWB3907	
	1997.04-2000.05	Saloon Engine G4JP With ABS		o	GHA228028	K
	1997.04-2000.05	Saloon Engine G4JP With ABS		o	GHA228068	K
	1997.04-2000.05	Saloon Engine G4JP Without ABS		o	GHA228018	K
	1997.04-2000.05	Saloon Engine G4JP Without ABS		o	GHA228018	K
2.0 16V (102 kW)	1996.08-2000.09	Saloon Engine G4GF	•		GHA425044	
	1996.08-2000.09	Saloon Engine G4GF	•		GHA425045	
	1996.08-2000.09	Saloon Engine G4GF	•		GWB3907	
	1996.08-2000.09	Saloon Engine G4GF With ABS		o	GHA228028	K
	1996.08-2000.09	Saloon Engine G4GF With ABS		o	GHA228068	K
	1996.08-2000.09	Saloon Engine G4GF Without ABS		o	GHA228014	
	1996.08-2000.09	Saloon Engine G4GF Without ABS		o	GHA228018	K
	1996.08-2000.09	Saloon Engine G4GF Without ABS		o	GHA228018	K
	1996.12-2000.10	Estate Engine G4GF	•		GHA425044	
	1996.12-2000.10	Estate Engine G4GF	•		GHA425045	
	1996.12-2000.10	Estate Engine G4GF	•		GWB3907	
	1996.12-2000.10	Estate Engine G4GF With ABS		o	GHA228028	K
	1996.12-2000.10	Estate Engine G4GF With ABS		o	GHA228068	K
	1996.12-2000.10	Estate Engine G4GF Without ABS		o	GHA228014	
	1996.12-2000.10	Estate Engine G4GF Without ABS		o	GHA228018	K
	1996.12-2000.10	Estate Engine G4GF Without ABS		o	GHA228018	K
LANTRA II WAGON (J-2)						
2.0 (100 kW)	1997.04-2000.05	Estate Engine G4JP	•		GWB3907	
	1997.04-2000.05	Estate Engine G4JP With ABS		o	GHA228028	K
	1997.04-2000.05	Estate Engine G4JP With ABS		o	GHA228068	K
	1997.04-2000.05	Estate Engine G4JP Without ABS		o	GHA228018	K
	1997.04-2000.05	Estate Engine G4JP Without ABS		o	GHA228018	K
MATRIX (FC)						
1.5 CRDi (60 kW)	2001.10-2010.08	MPV Engine D3EA	•		GHA425027	
	2001.10-2010.08	MPV Engine D3EA	•		GWB6812	
	2001.10-2010.08	MPV Engine D3EA With ABS		o	GHA232008	K
	2001.10-2010.08	MPV Engine D3EA Without ABS		o	GHA232043	
1.5 CRDi (75 kW)	2004.11-2007.03	MPV Engine D4FA	•		GHA425027	
	2004.11-2007.03	MPV Engine D4FA	•		GWB6812	
	2004.11-2007.03	MPV Engine D4FA With ABS		o	GHA232008	K
	2004.11-2007.03	MPV Engine D4FA Without ABS		o	GHA232043	
1.5 CRDi VGT (81 kW)	2005.08-2010.08	MPV Engine D4FA	•		GHA425027	
1.6 (66 kW)	2002.01-2005.12	MPV Engine G4ED-L	•		GHA425027	
	2002.01-2005.12	MPV Engine G4ED-L	•		GWB6812	
	2002.01-2005.12	MPV Engine G4ED-L With ABS		o	GHA232008	K
	2002.01-2005.12	MPV Engine G4ED-L Without ABS		o	GHA232043	
1.6 (76 kW)	2001.06-2010.08	MPV Engine G4ED-G	•		GHA425027	
	2001.06-2010.08	MPV Engine G4ED-G	•		GWB6812	
	2001.06-2010.08	MPV Engine G4ED-G With ABS		o	GHA232008	K
	2001.06-2010.08	MPV Engine G4ED-G Without ABS		o	GHA232043	
1.8 (90 kW)	2001.06-2010.08	MPV Engine G4GB-G	•		GHA425027	
	2001.06-2010.08	MPV Engine G4GB-G	•		GWB6812	
	2001.06-2010.08	MPV Engine G4GB-G With ABS		o	GHA232008	K
	2001.06-2010.08	MPV Engine G4GB-G Without ABS		o	GHA232043	
PONY / EXCEL (X-2)						
1.3 (48 kW)	1992.12-1994.09	Saloon Engine G4DG	•		GHA425001	
	1992.12-1994.09	Saloon Engine G4DG	•		GWB1366	
1.3 (49 kW)	1990.01-1995.01	Saloon Engine G4DG	•		GHA425001	
	1990.01-1995.01	Saloon Engine G4DG	•		GWB1366	
1.5 (53 kW)	1990.01-1995.01	Saloon Engine G15B/G4DJ	•		GHA425001	
	1990.01-1995.01	Saloon Engine G15B/G4DJ	•		GWB1366	
1.5 i (61 kW)	1990.01-1995.01	Saloon Engine G15B/G4DJ	•		GHA425001	
	1990.01-1995.01	Saloon Engine G15B/G4DJ	•		GWB1366	
1.5 i (62 kW)	1990.01-1995.01	Saloon Engine G15B/G4DJ	•		GHA425001	
	1990.01-1995.01	Saloon Engine G15B/G4DJ	•		GWB1366	



	 YEAR		F	R	G-AP Ref.	KIT
HYUNDAI						
S (SLC)						
	1990.02-1996.05	Coupe Engine G15B/G4DJ	•		GHA425001	
	1990.02-1996.05	Coupe Engine G15B/G4DJ	•		GWB1366	
1.5 i (65 kW)	1992.04-1996.05	Coupe Engine G4EK	•		GHA425001	
	1992.04-1996.05	Coupe Engine G4EK	•		GWB1366	
1.5 i Turbo (85 kW)	1991.04-1996.05	Coupe Engine G4EK-TC	•		GHA425001	
	1991.04-1996.05	Coupe Engine G4EK-TC	•		GWB1366	
SANTA FE I (SM)						
2.0 (99 kW)	2001.08-2006.03	Closed Off-Road Vehicle Engine G4BP	•		GWB6891	
	2001.08-2006.03	Closed Off-Road Vehicle Engine G4BP		o	GHA235023	K
	2001.08-2006.03	Closed Off-Road Vehicle Engine G4BP		o	GWB6956	
	2001.08-2006.03	Closed Off-Road Vehicle Engine G4BP Without ABS		o	GHA235015	K
2.0 CRDi (107 kW)	2003.11-2006.02	Closed Off-Road Vehicle Engine D4EA	•		GWB6891	
	2003.11-2006.02	Closed Off-Road Vehicle Engine D4EA		o	GWB6956	
2.0 CRDi (83 kW)	2001.08-2006.03	Closed Off-Road Vehicle Engine D4EA	•		GWB6891	
	2001.08-2006.03	Closed Off-Road Vehicle Engine D4EA		o	GHA235023	K
	2001.08-2006.03	Closed Off-Road Vehicle Engine D4EA Without ABS		o	GHA235015	K
2.0 CRDi 4x4 (83 kW)	2001.04-2006.03	Closed Off-Road Vehicle Engine D4EA	•		GWB6891	
	2001.04-2006.03	Closed Off-Road Vehicle Engine D4EA		o	GWB6956	
2.0 CRDi 4x4 (92 kW)	2003.08-2006.03	Closed Off-Road Vehicle Engine D4EA	•		GWB6891	
	2003.08-2006.03	Closed Off-Road Vehicle Engine D4EA		o	GWB6956	
2.4 16V (100 kW)	2001.02-2006.03	Closed Off-Road Vehicle Engine G4JS-G	•		GWB6891	
	2001.02-2006.03	Closed Off-Road Vehicle Engine G4JS-G		o	GHA235023	K
	2001.02-2006.03	Closed Off-Road Vehicle Engine G4JS-G Without ABS		o	GHA235015	K
2.4 16V (107 kW)	2001.02-2006.03	Closed Off-Road Vehicle Engine G4JS-G	•		GWB6891	
	2001.02-2006.03	Closed Off-Road Vehicle Engine G4JS-G		o	GHA235023	K
	2001.02-2006.03	Closed Off-Road Vehicle Engine G4JS-G Without ABS		o	GHA235015	K
2.4 16V 4x4 (100 kW)	2001.02-2006.03	Closed Off-Road Vehicle Engine G4JS-G	•		GWB6891	
	2001.02-2006.03	Closed Off-Road Vehicle Engine G4JS-G		o	GWB6956	
2.4 16V 4x4 (107 kW)	2001.02-2006.03	Closed Off-Road Vehicle Engine G4JS-G	•		GWB6891	
	2001.02-2006.03	Closed Off-Road Vehicle Engine G4JS-G		o	GWB6956	
2.7 4x4 (132 kW)	2000.11-2006.03	Closed Off-Road Vehicle Engine G6EA	•		GHA330009	
	2000.11-2006.03	Closed Off-Road Vehicle Engine G6EA	•		GWB6891	
	2000.11-2006.03	Closed Off-Road Vehicle Engine G6EA		o	GWB6956	
2.7 V6 4x4 (127 kW)	2001.02-2006.03	Closed Off-Road Vehicle Engine G6BA-G	•		GHA330009	
	2001.02-2006.03	Closed Off-Road Vehicle Engine G6BA-G	•		GWB6891	
	2001.02-2006.03	Closed Off-Road Vehicle Engine G6BA-G		o	GWB6956	
SANTA FE II (CM)						
2.0 CRDi (110 kW)	2010.12-	Closed Off-Road Vehicle Engine D4HA	•		GHA330009	
	2010.12-	Closed Off-Road Vehicle Engine D4HA		o	GHA400190	
2.0 CRDi 4x4 (110 kW)	2010.12-	Closed Off-Road Vehicle Engine D4HA	•		GHA330009	
2.2 CRDi (102 kW)	2006.03-	Closed Off-Road Vehicle Engine D4EB	•		GHA330009	
	2006.03-	Closed Off-Road Vehicle Engine D4EB		o	GHA400190	
2.2 CRDi (114 kW)	2006.03-	Closed Off-Road Vehicle Engine D4EB	•		GHA330009	
	2006.03-	Closed Off-Road Vehicle Engine D4EB		o	GHA400190	
2.2 CRDi (145 kW)	2009.01-	Closed Off-Road Vehicle Engine D4HB	•		GHA330009	
	2009.01-	Closed Off-Road Vehicle Engine D4HB		o	GHA400190	
2.2 CRDi 4x4 (102 kW)	2006.03-	Closed Off-Road Vehicle Engine D4EB	•		GHA330009	
2.2 CRDi 4x4 (114 kW)	2006.08-	Closed Off-Road Vehicle Engine D4EB	•		GHA330009	
2.2 CRDi 4x4 (145 kW)	2009.01-	Closed Off-Road Vehicle Engine D4HB	•		GHA330009	
2.2 CRDi GLS (110 kW)	2006.03-	Closed Off-Road Vehicle Engine D4EB	•		GHA330009	
	2006.03-	Closed Off-Road Vehicle Engine D4EB		o	GHA400190	
2.2 CRDi GLS 4x4 (110 kW)	2006.03-	Closed Off-Road Vehicle Engine D4EB	•		GHA330009	
2.4 (128 kW)	2010.11-	Closed Off-Road Vehicle Engine G4KE	•		GHA330009	
	2010.11-	Closed Off-Road Vehicle Engine G4KE		o	GHA400190	
2.4 4x4 (128 kW)	2010.07-	Closed Off-Road Vehicle Engine G4KE	•		GHA330009	
2.7 (125 kW)	2006.03-	Closed Off-Road Vehicle Engine G6BA	•		GHA330009	
	2006.03-	Closed Off-Road Vehicle Engine G6BA		o	GHA400190	
2.7 4x4 (125 kW)	2006.03-	Closed Off-Road Vehicle Engine G6BA	•		GHA330009	
2.7 V6 GLS (139 kW)	2006.03-	Closed Off-Road Vehicle Engine G6EA	•		GHA330009	
	2006.03-	Closed Off-Road Vehicle Engine G6EA		o	GHA400190	
2.7 V6 GLS 4x4 (139 kW)	2006.03-	Closed Off-Road Vehicle Engine G6EA	•		GHA330009	
SANTA FE III (DM)						
2.0 CRDi (110 kW)	2012.09-	Closed Off-Road Vehicle Engine D4HA	•		GHA330009	
	2012.09-	Closed Off-Road Vehicle Engine D4HA		o	GHA400190	



	 YEAR		F	R	G-AP Ref.	KIT
HYUNDAI						
SANTA FE III (DM)						
2.0 CRDi 4WD (110 kW)	2012.09-	Closed Off-Road Vehicle Engine D4HA	•		GHA330009	
2.2 CRDi (145 kW)	2012.09-	Closed Off-Road Vehicle Engine D4HB	•		GHA330009	
	2012.09-	Closed Off-Road Vehicle Engine D4HB		○	GHA400190	
2.2 CRDi 4WD (145 kW)	2012.09-	Closed Off-Road Vehicle Engine D4HB	•		GHA330009	
2.4 (141 kW)	2012.09-	Closed Off-Road Vehicle Engine G4KJ	•		GHA330009	
	2012.09-	Closed Off-Road Vehicle Engine G4KJ		○	GHA400190	
2.4 4WD (141 kW)	2012.09-	Closed Off-Road Vehicle Engine G4KJ	•		GHA330009	
SANTAMO						
2.0 16V (102 kW)	1999.05-	MPV With ABS		○	GHA233012	
	1999.05-	MPV Without ABS		○	GHA233011	
2.0 16V 4x4 (102 kW)	1999.05-	MPV Engine G4CP Without ABS		○	GHA233011	
SONATA						
-	2006-2009		•	○	GHA427020	
SONATA (Y-2)						
2.0 i (80 kW)	1991.01-1993.10	Saloon Engine G4CP-U	•		GWB1973	
	1991.01-1993.10	Saloon Engine G4CP-U With ABS		○	GHA234003	K
	1991.01-1993.10	Saloon Engine G4CP-U Without ABS		○	GHA234008	K
2.0 i 16V (96 kW)	1991.01-1993.10	Saloon Engine G4CP-D	•		GWB1973	
	1991.01-1993.10	Saloon Engine G4CP-D With ABS		○	GHA234003	K
	1991.01-1993.10	Saloon Engine G4CP-D Without ABS		○	GHA234008	K
3.0 i V6 (107 kW)	1991.01-1993.10	Saloon Engine G6AT With ABS		○	GHA234003	K
	1991.01-1993.10	Saloon Engine G6AT Without ABS		○	GHA234008	K
SONATA II (Y-3)						
1.8 i (72 kW)	1993.05-1998.06	Saloon Engine G4CM	•		GWB3906	
	1993.05-1998.06	Saloon Engine G4CM With ABS		○	GHA234003	K
	1993.05-1998.06	Saloon Engine G4CM Without ABS		○	GHA234008	K
2.0 i (70 kW)	1996.08-1998.06	Saloon	•		GHA427006	
	1996.08-1998.06	Saloon	•		GWB3906	
	1996.08-1998.06	Saloon With ABS		○	GHA234003	K
	1996.08-1998.06	Saloon Without ABS		○	GHA234008	K
2.0 i (77 kW)	1994.06-1996.08	Saloon Engine G4CP	•		GWB3906	
	1994.06-1996.08	Saloon Engine G4CP With ABS		○	GHA234003	K
	1994.06-1996.08	Saloon Engine G4CP Without ABS		○	GHA234008	K
2.0 i 16V (102 kW)	1993.05-1998.06	Saloon Engine G4CP-D	•		GHA427006	
	1993.05-1998.06	Saloon Engine G4CP-D	•		GWB3906	
	1993.05-1998.06	Saloon Engine G4CP-D With ABS		○	GHA234003	K
	1993.05-1998.06	Saloon Engine G4CP-D Without ABS		○	GHA234008	K
2.0 i 16V (92 kW)	1996.06-1998.06	Saloon Engine G4CP-DM	•		GHA427006	
	1996.06-1998.06	Saloon Engine G4CP-DM	•		GWB3906	
	1996.06-1998.06	Saloon Engine G4CP-DM With ABS		○	GHA234003	K
	1996.06-1998.06	Saloon Engine G4CP-DM Without ABS		○	GHA234008	K
3.0 i V6 (107 kW)	1993.05-1998.06	Saloon Engine G6AT	•		GWB3906	
	1993.05-1998.06	Saloon Engine G6AT With ABS		○	GHA234003	K
	1993.05-1998.06	Saloon Engine G6AT Without ABS		○	GHA234008	K
SONATA III (EF)						
2.0 16V (100 kW)	1998.06-2001.10	Saloon Engine G4JP-G	•		GHA427006	
	1998.06-2001.10	Saloon Engine G4JP-G	•		GWB3909	
	1998.06-2001.10	Saloon Engine G4JP-G With ABS		○	GHA400004	
	1998.06-2001.10	Saloon Engine G4JP-G Without ABS		○	GHA400037	
2.0 16V (96 kW)	2001.10-2004.11	Saloon Engine G4JP-EG	•		GHA427006	
	2001.10-2004.11	Saloon Engine G4JP-EG	•		GHA427022	
	2001.10-2004.11	Saloon Engine G4JP-EG	•		GWB3909	
	2001.10-2004.11	Saloon Engine G4JP-EG	•		GWB6891	
	2001.10-2004.11	Saloon Engine G4JP-EG With ABS		○	GHA400004	
	2001.10-2004.11	Saloon Engine G4JP-EG Without ABS		○	GHA400037	
2.4 16V (105 kW)	1998.03-2001.10	Saloon Engine G4BS	•		GHA427006	
	1998.03-2001.10	Saloon Engine G4BS	•		GWB3909	
	1998.03-2001.10	Saloon Engine G4BS With ABS		○	GHA400004	
	1998.03-2001.10	Saloon Engine G4BS Without ABS		○	GHA400037	
2.5 V6 24V (118 kW)	1998.06-2001.10	Saloon Engine G6BV-G	•		GHA427006	
	1998.06-2001.10	Saloon Engine G6BV-G	•		GWB3909	
	1998.06-2001.10	Saloon Engine G6BV-G With ABS		○	GHA400004	
	1998.06-2001.10	Saloon Engine G6BV-G Without ABS		○	GHA400037	
2.7 i V6 (132 kW)	2001.10-2005.05	Saloon Engine G6BA-Y	•		GHA427006	



	 YEAR		F	R	G-AP Ref.	KIT
HYUNDAI						
SONATA III (EF)						
2.7 i V6 (132 kW)	2001.10-2005.05	Saloon Engine G6BA-Y	•		GHA427022	
2.7 V6 (127 kW)	2001.10-2004.11	Saloon Engine G6BA-G	•		GHA427006	
	2001.10-2004.11	Saloon Engine G6BA-G	•		GHA427022	
2.7 V6 (129 kW)	2002.11-2004.11	Saloon Engine G6BA	•		GHA427022	
SONATA III (Y-3)						
1.8 GLS (63 kW)	1996.07-1998.05	Saloon Engine G4DM	•		GWB3906	
	1996.07-1998.05	Saloon Engine G4DM With ABS		o	GHA234003	K
	1996.07-1998.05	Saloon Engine G4DM Without ABS		o	GHA234008	K
SONATA IV (EF)						
2.0 (100 kW)	2001.04-2004.11	Saloon Engine G4JP	•		GHA427006	
2.0 16V (106 kW)	2001.10-2004.11	Saloon Engine G4CP	•		GHA427006	
	2001.10-2004.11	Saloon Engine G4CP	•		GHA427022	
	2001.10-2004.11	Saloon Engine G4CP	•		GWB3909	
	2001.10-2004.11	Saloon Engine G4CP	•		GWB6891	
	2001.10-2004.11	Saloon Engine G4CP With ABS		o	GHA400004	
	2001.10-2004.11	Saloon Engine G4CP Without ABS		o	GHA400037	
SONATA V (NF)						
2.0 CRDi (100 kW)	2006.02-	Saloon Engine D4EA	•		GHA427022	
	2006.02-	Saloon Engine D4EA	•		GWB6891	
	2006.02-	Saloon Engine D4EA		o	GHA400108	
	2006.02-	Saloon Engine D4EA		o	GHA400157	
	2006.02-	Saloon Engine D4EA		o	GHA400265	
2.0 CRDi (103 kW)	2006.07-	Saloon Engine D4EA	•		GHA427022	
	2006.07-	Saloon Engine D4EA	•		GWB6891	
	2006.07-	Saloon Engine D4EA		o	GHA400108	
	2006.07-	Saloon Engine D4EA		o	GHA400157	
2.0 CRDi (110 kW)	2009.03-	Saloon	•		GHA427022	
	2009.03-	Saloon	•		GWB6891	
	2009.03-	Saloon		o	GHA400108	
2.0 GLSi (119 kW)	2008.07-2010.12	Saloon Engine G4KD	•		GHA427021	
2.0 VVT-i GLS (106 kW)	2006.07-2007.12	Saloon Engine G4KA	•		GHA427021	
	2006.07-2007.12	Saloon Engine G4KA	•		GHA427022	
	2006.07-2007.12	Saloon Engine G4KA	•		GWB6891	
	2006.07-2007.12	Saloon Engine G4KA		o	GHA400108	
	2006.07-2007.12	Saloon Engine G4KA		o	GHA400157	
	2006.07-2007.12	Saloon Engine G4KA		o	GHA400265	
2.0 VVT-i GLS (121 kW)	2008.01-	Saloon Engine G4KD	•		GHA427021	
	2008.01-	Saloon Engine G4KD	•		GHA427022	
	2008.01-	Saloon Engine G4KD	•		GWB6891	
	2008.01-	Saloon Engine G4KD		o	GHA400108	
2.4 (119 kW)	2005.05-2006.08	Saloon Engine G4KC	•		GHA427021	
	2005.05-2006.08	Saloon Engine G4KC	•		GHA427022	
	2005.05-2006.08	Saloon Engine G4KC	•		GWB6891	
	2005.05-2006.08	Saloon Engine G4KC		o	GHA400108	
	2005.05-2006.08	Saloon Engine G4KC		o	GHA400157	
	2005.05-2006.08	Saloon Engine G4KC		o	GHA400265	
2.4 (125 kW)	2008.06-2009.12	Saloon Engine G4KC	•		GHA427021	
2.4 (127 kW)	2008.06-2010.12	Saloon Engine G4KE	•		GHA427021	
	2008.06-2010.12	Saloon Engine G4KE	•		GWB6891	
	2008.06-2010.12	Saloon Engine G4KE		o	GHA400108	
2.4 (132 kW)	2007.11-2010.12	Saloon Engine G4KC	•		GHA427021	
3.3 (171 kW)	2006.07-	Saloon Engine G6DB	•		GHA427022	
	2006.07-	Saloon Engine G6DB	•		GWB6891	
	2006.07-	Saloon Engine G6DB		o	GHA400108	
	2006.07-	Saloon Engine G6DB		o	GHA400157	
	2006.07-	Saloon Engine G6DB		o	GHA400265	
3.3 (173 kW)	2005.06-	Saloon Engine G6DB	•		GHA427022	
	2005.06-	Saloon Engine G6DB	•		GWB6891	
	2005.06-	Saloon Engine G6DB		o	GHA400108	
	2005.06-	Saloon Engine G6DB		o	GHA400157	
	2005.06-	Saloon Engine G6DB		o	GHA400265	
3.3 (184 kW)	2008.01-	Saloon Engine G6DB	•		GHA427022	
	2008.01-	Saloon Engine G6DB	•		GWB6891	



	 YEAR		F	R	G-AP Ref.	KIT
HYUNDAI						
SONATA V (NF)						
3.3 (184 kW)	2008.01-	Saloon Engine G6DB		o	GHA400108	
SONATA VI (YF)						
2.0 (110 kW)	2009.01-	Saloon Engine G4KD	•		GHA427021	
	2009.01-	Saloon Engine G4KD	•		GHA427022	
	2009.01-	Saloon Engine G4KD	•		GWB6891	
	2009.01-	Saloon Engine G4KD		o	GHA400258	
2.0 (115 kW)	2010.09-	Saloon Engine G4NA	•		GHA427021	
2.0 i (121 kW)	2011.01-	Saloon Engine G4KD	•		GHA427021	
	2011.01-	Saloon Engine G4KD	•		GHA427022	
	2011.01-	Saloon Engine G4KD	•		GWB6891	
	2011.01-	Saloon Engine G4KD		o	GHA400258	
2.4 (128 kW)	2009.01-	Saloon Engine G4KC	•		GHA427021	
	2009.01-	Saloon Engine G4KC	•		GHA427022	
	2009.01-	Saloon Engine G4KC	•		GWB6891	
	2009.01-	Saloon Engine G4KC		o	GHA400258	
2.4 (131 kW)	2009.01-	Saloon Engine G4KC	•		GHA427021	
	2009.01-	Saloon Engine G4KC	•		GWB6891	
	2009.01-	Saloon Engine G4KC		o	GHA400258	
SONATA VII (LF)						
2.4 (138 kW)	2014.09-	Saloon Engine G4KJ	•		GHA427021	
TERRACAN (HP)						
2.5 TD (74 kW)	2001.12-2006.12	Closed Off-Road Vehicle Engine D4BH	•		GWB1915	
2.9 CRDi (110 kW)	2001.11-2003.07	Closed Off-Road Vehicle Engine J3	•		GWB1915	
2.9 CRDi 4WD (110 kW)	2001.12-2006.12	Closed Off-Road Vehicle Engine J3	•		GWB1915	
2.9 CRDi 4WD (120 kW)	2003.06-2004.11	Closed Off-Road Vehicle Engine J3	•		GWB1915	
3.5 i V6 4WD (143 kW)	2001.12-2006.12	Closed Off-Road Vehicle Engine G6CU	•		GWB1915	
3.5 i V6 4WD (147 kW)	2001.12-2006.12	Closed Off-Road Vehicle Engine G6CU	•		GWB1915	
TRAJET (FO)						
2.0 (100 kW)	2000.03-2008.07	MPV Engine G4JP-G	•		GHA427005	
	2000.03-2008.07	MPV Engine G4JP-G	•		GWB6891	
	2000.03-2008.07	MPV Engine G4JP-G	•		GWB6938	
	2000.03-2008.07	MPV Engine G4JP-G With ABS		o	GHA235012	K
	2000.03-2008.07	MPV Engine G4JP-G Without ABS		o	GHA235015	K
2.0 (103 kW)	2004.07-2007.01	MPV Engine G4GC-G	•		GHA427005	
	2004.07-2007.01	MPV Engine G4GC-G	•		GWB6938	
	2004.07-2007.01	MPV Engine G4GC-G With ABS		o	GHA235012	K
	2004.07-2007.01	MPV Engine G4GC-G Without ABS		o	GHA235015	K
2.0 (104 kW)	2003.11-2008.07	MPV Engine G4GC	•		GHA427005	
	2003.11-2008.07	MPV Engine G4GC	•		GWB6938	
	2003.11-2008.07	MPV Engine G4GC With ABS		o	GHA235012	K
	2003.11-2008.07	MPV Engine G4GC Without ABS		o	GHA235015	K
2.0 CRDi (83 kW)	2001.04-2008.07	MPV Engine D4EA	•		GHA427005	
	2001.04-2008.07	MPV Engine D4EA	•		GWB6938	
	2001.04-2008.07	MPV Engine D4EA With ABS		o	GHA235012	K
	2001.04-2008.07	MPV Engine D4EA Without ABS		o	GHA235015	K
2.7 V6 (127 kW)	2000.09-2008.07	MPV Engine G6BA-G	•		GHA427005	
	2000.09-2008.07	MPV Engine G6BA-G	•		GWB6891	
	2000.09-2008.07	MPV Engine G6BA-G	•		GWB6938	
	2000.09-2008.07	MPV Engine G6BA-G With ABS		o	GHA235012	K
	2000.09-2008.07	MPV Engine G6BA-G Without ABS		o	GHA235015	K
TUCSON						
-	2004-2009	Without ABS		o	GHA233008	
	2004-2009	Without ABS		o	GHA233008	
	2013-		•	o	GHA430002	
TUCSON (JM)						
2.0 (104 kW)	2004.08-2006.02	Closed Off-Road Vehicle Engine G4GC	•		GHA427005	
	2004.08-2006.02	Closed Off-Road Vehicle Engine G4GC	•		GHA427021	
	2004.08-2006.02	Closed Off-Road Vehicle Engine G4GC	•		GWB6891	
	2004.08-2006.02	Closed Off-Road Vehicle Engine G4GC With ABS		o	GHA233005	K
	2004.08-2006.02	Closed Off-Road Vehicle Engine G4GC With ABS		o	GHA233005	K
	2006.03-2010.03	Closed Off-Road Vehicle Engine G4GC	•		GHA427005	
	2006.03-2010.03	Closed Off-Road Vehicle Engine G4GC	•		GHA427021	
	2006.03-2010.03	Closed Off-Road Vehicle Engine G4GC	•		GWB6891	
	2006.03-2010.03	Closed Off-Road Vehicle Engine G4GC		o	GHA427004	



	 YEAR		F	R	G-AP Ref.	KIT
HYUNDAI						
TUCSON (JM)						
2.0 (104 kW)	2006.03-2010.03	Closed Off-Road Vehicle Engine G4GC		o	GWB6956	
2.0 (105 kW)	2010.01-2010.03	Closed Off-Road Vehicle Engine G4GC	•		GHA427005	
	2010.01-2010.03	Closed Off-Road Vehicle Engine G4GC	•		GHA427021	
2.0 CRDi (100 kW)	2006.01-2010.03	Closed Off-Road Vehicle Engine D4EA	•		GHA427005	
	2006.01-2010.03	Closed Off-Road Vehicle Engine D4EA	•		GHA427005	
	2006.01-2010.03	Closed Off-Road Vehicle Engine D4EA	•		GWB6891	
	2006.01-2010.03	Closed Off-Road Vehicle Engine D4EA	•		GWB6891	
	2006.01-2010.03	Closed Off-Road Vehicle Engine D4EA		o	GHA427004	
	2006.01-2010.03	Closed Off-Road Vehicle Engine D4EA		o	GWB6956	
	2006.01-2010.03	Closed Off-Road Vehicle Engine D4EA With ABS		o	GHA233005	K
2.0 CRDi (103 kW)	2006.01-2010.03	Closed Off-Road Vehicle Engine D4EA With ABS		o	GHA233005	K
	2006.03-2007.12	Closed Off-Road Vehicle Engine D4EA-F/D4EA-V	•		GHA427005	
	2006.03-2007.12	Closed Off-Road Vehicle Engine D4EA-F/D4EA-V	•		GWB6891	
	2006.03-2007.12	Closed Off-Road Vehicle Engine D4EA-F/D4EA-V		o	GHA427004	
	2006.03-2007.12	Closed Off-Road Vehicle Engine D4EA-F/D4EA-V		o	GWB6956	
	2006.04-2010.03	Closed Off-Road Vehicle Engine D4EA-V	•		GHA427005	
	2006.04-2010.03	Closed Off-Road Vehicle Engine D4EA-V	•		GWB6891	
2.0 CRDi (110 kW)	2006.04-2010.03	Closed Off-Road Vehicle Engine D4EA-V With ABS		o	GHA233005	K
	2006.04-2010.03	Closed Off-Road Vehicle Engine D4EA-V With ABS		o	GHA233005	K
	2009.01-2010.03	Closed Off-Road Vehicle Engine D4EA	•		GHA427005	
	2009.01-2010.03	Closed Off-Road Vehicle Engine D4EA	•		GHA427005	
	2009.01-2010.03	Closed Off-Road Vehicle Engine D4EA	•		GWB6891	
2.0 CRDi (83 kW)	2009.01-2010.03	Closed Off-Road Vehicle Engine D4EA	•		GWB6891	
	2009.01-2010.03	Closed Off-Road Vehicle Engine D4EA	•		GWB6891	
	2009.01-2010.03	Closed Off-Road Vehicle Engine D4EA		o	GHA427004	
	2009.01-2010.03	Closed Off-Road Vehicle Engine D4EA		o	GWB6956	
	2009.01-2010.03	Closed Off-Road Vehicle Engine D4EA With ABS		o	GHA233005	K
	2009.01-2010.03	Closed Off-Road Vehicle Engine D4EA With ABS		o	GHA233005	K
	2.0 CRDi (88 kW)	2004.08-2006.03	Closed Off-Road Vehicle Engine D4EA	•		GHA427005
2004.08-2006.03		Closed Off-Road Vehicle Engine D4EA	•		GWB6891	
2004.08-2006.03		Closed Off-Road Vehicle Engine D4EA With ABS		o	GHA233005	K
2004.08-2006.03		Closed Off-Road Vehicle Engine D4EA With ABS		o	GHA233005	K
2004.08-2010.03		Closed Off-Road Vehicle Engine D4EA	•		GHA427005	
2004.08-2010.03		Closed Off-Road Vehicle Engine D4EA	•		GWB6891	
2004.08-2010.03		Closed Off-Road Vehicle Engine D4EA		o	GHA427004	
2004.08-2010.03		Closed Off-Road Vehicle Engine D4EA		o	GWB6956	
2.0 CRDi (88 kW)		2007.01-2010.03	Closed Off-Road Vehicle Engine D4EA	•		GHA427005
	2007.01-2010.03	Closed Off-Road Vehicle Engine D4EA	•		GHA427005	
	2007.01-2010.03	Closed Off-Road Vehicle Engine D4EA	•		GWB6891	
	2007.01-2010.03	Closed Off-Road Vehicle Engine D4EA	•		GWB6891	
	2007.01-2010.03	Closed Off-Road Vehicle Engine D4EA		o	GHA427004	
	2007.01-2010.03	Closed Off-Road Vehicle Engine D4EA		o	GWB6956	
	2007.01-2010.03	Closed Off-Road Vehicle Engine D4EA With ABS		o	GHA233005	K
	2007.01-2010.03	Closed Off-Road Vehicle Engine D4EA With ABS		o	GHA233005	K
	2.7 (129 kW)	2004.08-2010.03	Closed Off-Road Vehicle Engine G6BA-G	•		GHA427005
2004.08-2010.03		Closed Off-Road Vehicle Engine G6BA-G	•		GWB6891	
2004.08-2010.03		Closed Off-Road Vehicle Engine G6BA-G		o	GHA427004	
2004.08-2010.03		Closed Off-Road Vehicle Engine G6BA-G		o	GWB6956	
TUCSON (TLE)						
1.6 GDi (97 kW)	2015.06-	Closed Off-Road Vehicle Engine G4FD	•		GHA427021	
1.6 T-GDi (130 kW)	2015.06-	Closed Off-Road Vehicle Engine G4FJ	•		GHA427021	
1.7 CRDi (85 kW)	2015.06-	Closed Off-Road Vehicle Engine D4FD	•		GHA427021	
2.0 CRDi (100 kW)	2015.06-	Closed Off-Road Vehicle Engine D4HA	•		GHA427021	
2.0 CRDi All-wheel Drive (100 kW)	2015.06-	Closed Off-Road Vehicle Engine D4HA		o	GHA427004	
2.0 CRDi All-wheel Drive (136 kW)	2015.06-	Closed Off-Road Vehicle Engine D4HA		o	GHA427004	
VELOSTER (FS)						
1.6 (94 kW)	2011.06-	Coupe Engine G4FG	•		GWB6923	
1.6 GDi (103 kW)	2011.03-	Coupe Engine G4FD	•		GWB6923	
	2011.03-	Coupe Engine G4FD With ABS		o	GHA400257	
1.6 MPI (97 kW)	2011.04-	Coupe Engine G4FG	•		GWB6923	
	2011.04-	Coupe Engine G4FG With ABS		o	GHA400257	
1.6 T-GDi (137 kW)	2012.10-	Coupe Engine G4FJ	•		GWB6923	
	2012.10-	Coupe Engine G4FJ With ABS		o	GHA400257	
XG (XG)						
250 (120 kW)	1998.12-2005.12	Saloon Engine G6AV	•		GHA427021	



	 YEAR		F	R	G-AP Ref.	KIT
HYUNDAI						
XG (XG)						
250 (120 kW)	1998.12-2005.12	Saloon Engine G6AV	•		GWB3909	
	1998.12-2005.12	Saloon Engine G6AV	•		GWB6891	
	1998.12-2005.12	Saloon Engine G6AV		○	GHA400231	
3.0 (138 kW)	1998.12-2005.12	Saloon Engine G6CT-G	•		GHA427021	
	1998.12-2005.12	Saloon Engine G6CT-G	•		GWB3909	
	1998.12-2005.12	Saloon Engine G6CT-G	•		GWB6891	
	1998.12-2005.12	Saloon Engine G6CT-G		○	GHA400231	
3.5 (145 kW)	2002.10-2005.12	Saloon Engine G6CU	•		GHA427021	
	2002.10-2005.12	Saloon Engine G6CU	•		GWB6891	
	2002.10-2005.12	Saloon Engine G6CU		○	GHA400231	
300 (145 kW)	1999.09-2003.09	Saloon Engine G6CT	•		GHA427021	
XG350						
-	2003-2005		•	○	GHA427020	
INFINITI						
FX						
3.5 (206 kW)	2003.01-2008.12	Closed Off-Road Vehicle Engine VQ35DE	•		GHA327035	
	2003.01-2008.12	Closed Off-Road Vehicle Engine VQ35DE		○	GHA250010	
	2003.01-2008.12	Closed Off-Road Vehicle Engine VQ35DE		○	GHA429006	
3.7 AWD (235 kW)	2008.10-	Closed Off-Road Vehicle Engine VQ37VHR	•		GHA327035	
	2008.10-	Closed Off-Road Vehicle Engine VQ37VHR		○	GHA332011	
35 (206 kW)	2003.02-2008.12	Closed Off-Road Vehicle Engine VQ35DE		○	GHA250010	
	2003.02-2008.12	Closed Off-Road Vehicle Engine VQ35DE		○	GHA429006	
4.5 (232 kW)	2003.01-2008.12	Closed Off-Road Vehicle Engine VK45DE	•		GHA327035	
	2003.01-2008.12	Closed Off-Road Vehicle Engine VK45DE		○	GHA250010	
45 (232 kW)	2003.02-2008.12	Closed Off-Road Vehicle Engine VK45DE		○	GHA250010	
5.0 AWD (287 kW)	2008.10-	Closed Off-Road Vehicle Engine VK50VE	•		GHA327035	
	2008.10-	Closed Off-Road Vehicle Engine VK50VE		○	GHA332011	
50 AWD (309 kW)	2013.06-	Closed Off-Road Vehicle Engine VK50VE	•		GHA327035	
G						
25 (163 kW)	2011.01-	Saloon Engine VQ25HR	•		GHA400203	
35 (191 kW)	2002.10-	Saloon Engine VQ35DE		○	GHA429003	
37 (235 kW)	2008.10-	Saloon Engine VQ37VHR	•		GHA400203	
	2008.10-	Saloon Engine VQ37VHR		○	GHA332011	
	2010.09-	Convertible Engine VQ37VHR	•		GHA400203	
	2010.09-	Convertible Engine VQ37VHR		○	GHA332011	
	2010.09-	Coupe Engine VQ37VHR	•		GHA400203	
37 (243 kW)	2007.09-	Coupe Engine VQ37VHR	•		GHA400203	
	2008.10-	Saloon Engine VQ37VHR	•		GHA400203	
37 X (235 kW)	2008.10-	Saloon Engine VQ37VHR	•		GHA327035	
	2008.10-	Saloon Engine VQ37VHR		○	GHA332011	
I30						
3.0 (142 kW)	1997.01-	Saloon Engine VQ30DE	•		GHA429002	K
M (Y51)						
30D (175 kW)	2010.03-	Saloon Engine V9X	•		GHA400203	
35h (225 kW)	2011.04-	Saloon Engine VQ35HR	•		GHA400203	
37 (235 kW)	2010.03-	Saloon Engine VQ37VHR	•		GHA400203	
M35						
3.5 h (268 kW)	2010.01-	Saloon Engine VQ35HR	•		GHA400203	
M35 / 45 (Y50)						
-	2004-			○	GHA329025	
M37						
3.7 (243 kW)	2010.01-	Saloon Engine VQ37VHR	•		GHA400203	
Q50						
50 Hybrid AWD (268 kW)	2013.04-	Saloon Engine VQ35VHR	•		GHA327035	
Q70 (Y51)						
3.0 (175 kW)	2013.03-	Saloon Engine V9X	•		GHA400203	
3.5 Hybrid (225 kW)	2013.03-	Saloon Engine VQ35HR	•		GHA400203	
3.7 (235 kW)	2013.03-	Saloon Engine VQ37VHR	•		GHA400203	
QX50						
30D AWD (175 kW)	2013.08-	Closed Off-Road Vehicle Engine V9X	•		GHA327035	
37 AWD (235 kW)	2013.08-	Closed Off-Road Vehicle Engine VQ37VHR	•		GHA327035	



	 YEAR		F	R	G-AP Ref.	KIT
INFINITI						
QX70						
30D AWD (175 kW)	2013.08-	Closed Off-Road Vehicle Engine V9X	•		GHA327035	
50 AWD (287 kW)	2013.08-	Closed Off-Road Vehicle Engine VK50VE	•		GHA327035	
ISUZU						
ASCENDER						
4.2 4WD (217 kW)	2003.03-	Closed Off-Road Vehicle Engine LL8	•		GHA327027	
5.3 4WD (224 kW)	2003.03-	Closed Off-Road Vehicle Engine LH6	•		GHA327027	
IVECO						
DAILY CITYS						
3.0 (107 kW)	2014.06-	Bus Engine F1CFL411E	•		GWB3551	
	2014.06-	Bus Engine F1CFL411E	•		GWB3552	
3.0 (125 kW)	2014.06-	Bus Engine F1CFL411E	•		GWB3551	
	2014.06-	Bus Engine F1CFL411E	•		GWB3552	
DAILY II						
30-10 (76 kW)	1997.01-1999.05	Box Body / Estate Engine 8140.23.		o	GWB1393	
	1998.01-1999.05	Platform/Chassis Engine 8140.23.		o	GWB1393	
30-10 C (76 kW)	1997.01-1999.05	Box Body / Estate Engine 8140.23.		o	GWB1393	
	1997.01-1999.05	Box Body / Estate Engine 8140.23.		o	GWB1393	
30-8 (55 kW)	1992.01-1998.08	Platform/Chassis Engine 8140.07.2700		o	GWB1393	
	1992.01-1998.08	Platform/Chassis Engine 8140.07.2700		o	GWB1393	
30-8 (60 kW)	1992.01-1998.08	Platform/Chassis Engine 8140.67F.		o	GWB1393	
	1992.01-1998.08	Platform/Chassis Engine 8140.67F.		o	GWB1393	
	1992.01-1998.08	Platform/Chassis Engine 8140.67F./8140.67F.3710/8140.67F.3711/8140.67F.3713/8140.67F.3721		o	GWB1393	
30-8 (62 kW)	1998.09-1999.05	Box Body / Estate Engine 8140.63.		o	GWB1393	
	1998.09-1999.05	Platform/Chassis Engine 8140.63.		o	GWB1393	
	1998.09-1999.05	Platform/Chassis Engine 8140.63.		o	GWB1393	
30-8 V (62 kW)	1998.09-1999.05	Box Body / Estate Engine 8140.63.		o	GWB1393	
35-10 (68 kW)	1996.09-1998.08	Box Body / Estate Engine 8140.97.2781		o	GWB1393	
35-10 (76 kW)	1996.01-1999.05	Box Body / Estate Engine 8140.23.		o	GWB1393	
	1996.01-1999.05	Box Body / Estate Engine 8140.23.		o	GWB3552	
	1996.01-1999.05	Platform/Chassis Engine 8140.23.	•		GWB3551	
	1996.01-1999.05	Platform/Chassis Engine 8140.23.		o	GWB1393	
	1996.01-1999.05	Platform/Chassis Engine 8140.23.		o	GWB3552	
35-10 K (76 kW)	1997.01-1999.05	Dumptruck Engine 8140.23.	•		GWB3551	
	1997.01-1999.05	Dumptruck Engine 8140.23.		o	GWB1393	
	1997.01-1999.05	Dumptruck Engine 8140.23.		o	GWB3552	
35-12 (85 kW)	1990.01-1996.04	Box Body / Estate Engine 8140.47.2700		o	GWB1393	
	1990.01-1996.04	Platform/Chassis Engine 8140.47.2700		o	GWB1393	
35-12 (90 kW)	1996.05-1999.05	Platform/Chassis Engine 8140.43.	•		GWB3551	
	1996.05-1999.05	Platform/Chassis Engine 8140.43.		o	GWB1393	
	1996.05-1999.05	Platform/Chassis Engine 8140.43.		o	GWB3552	
35-12 K (90 kW)	1996.09-1998.08	Dumptruck Engine 8140.43.	•		GWB3551	
	1996.09-1998.08	Dumptruck Engine 8140.43.		o	GWB1393	
	1996.09-1998.08	Dumptruck Engine 8140.43.		o	GWB3552	
35-8 (55 kW)	1991.01-1998.08	Box Body / Estate Engine 8140.07.2700/8140.07.2712		o	GWB1393	
	1991.01-1998.08	Box Body / Estate Engine 8140.07.2700/8140.07.2712		o	GWB1393	
35-8 (60 kW)	1991.01-1998.08	Box Body / Estate Engine 8140.67F./8140.67F.3701/8140.67F.3710/8140.67F.3711/8140.67F.3713/8140.67F.3721		o	GWB1393	
35-8 (62 kW)	1998.09-1999.05	Box Body / Estate Engine 8140.63.		o	GWB1393	
	1998.09-1999.05	Platform/Chassis Engine 8140.63.	•		GWB3551	
	1998.09-1999.05	Platform/Chassis Engine 8140.63.		o	GWB1393	
	1998.09-1999.05	Platform/Chassis Engine 8140.63.		o	GWB3552	
35-8 K (62 kW)	1998.09-1999.05	Dumptruck Engine 8140.63.	•		GWB3551	
	1998.09-1999.05	Dumptruck Engine 8140.63.		o	GWB1393	
	1998.09-1999.05	Dumptruck Engine 8140.63.		o	GWB3552	
40-10 V (76 kW)	1990.01-1996.04	Box Body / Estate Engine 8140.27.2720		o	GWB1393	
40-10 W 4x4 (76 kW)	1997.01-1999.05	Platform/Chassis Engine 8140.23.	•		GWB3551	
	1997.01-1999.05	Platform/Chassis Engine 8140.23.		o	GWB3552	
45-10 (76 kW)	1992.01-1996.04	Dumptruck Engine 8140.27.2720		o	GWB1393	
49-10 (76 kW)	1996.05-1999.05	Platform/Chassis Engine 8140.23.	•		GWB3551	
	1996.05-1999.05	Platform/Chassis Engine 8140.23.		o	GWB3552	
49-10 K (76 kW)	1996.05-1999.05	Dumptruck Engine 8140.23.	•		GWB3551	
	1996.05-1999.05	Dumptruck Engine 8140.23.		o	GWB3552	
49-12 (90 kW)	1996.05-1999.05	Platform/Chassis Engine 8140.43.	•		GWB3551	
	1996.05-1999.05	Platform/Chassis Engine 8140.43.		o	GWB3552	



	 YEAR		F	R	G-AP Ref.	KIT
IVECO						
DAILY II						
49-12 K (90 kW)	1996.05-1999.05	Dumptruck Engine 8140.43.	•		GWB3551	
	1996.05-1999.05	Dumptruck Engine 8140.43.		○	GWB3552	
49-12 V (90 kW)	1996.05-1999.05	Box Body / Estate Engine 8140.43.	•		GWB3551	
	1996.05-1999.05	Box Body / Estate Engine 8140.43.		○	GWB3552	
59-12 2.5 (85 kW)	1991.05-1996.04	Platform/Chassis Engine 8140.47.2700/8140.47.2711	•		GHA245017	
59-12 2.5 K (85 kW)	1991.05-1996.04	Dumptruck Engine 8140.47.2711/8140.47.2700	•		GHA245017	
59-12 2.5 V (85 kW)	1991.05-1996.04	Box Body / Estate Engine 8140.47.2711/8140.47.2700	•		GHA245017	
59-12 2.8 (90 kW)	1996.05-1999.05	Platform/Chassis Engine 8140.43.	•		GHA245017	
59-12 2.8 K (90 kW)	1996.05-1999.05	Dumptruck Engine 8140.43.	•		GHA245017	
59-12 2.8 V (90 kW)	1996.05-1999.05	Box Body / Estate Engine 8140.43.	•		GHA245017	
A 40-10 (76 kW)	1991.01-1996.12	Bus Engine 8140.27.2720		○	GWB1393	
	1996.09-1999.05	Bus Engine 8140.23.	•		GWB3551	
	1996.09-1999.05	Bus Engine 8140.23.		○	GWB3552	
A 40-12 (90 kW)	1996.05-1999.05	Bus Engine 8140.43.	•		GWB3551	
	1996.05-1999.05	Bus Engine 8140.43.		○	GWB3552	
A 45-10 (76 kW)	1996.05-1999.05	Bus Engine 8140.23.	•		GWB3551	
	1996.05-1999.05	Bus Engine 8140.23.		○	GWB3552	
A 45-12 (90 kW)	1996.05-1999.05	Bus Engine 8140.43.	•		GWB3551	
	1996.05-1999.05	Bus Engine 8140.43.		○	GWB3552	
DAILY III						
29 L 10 (70 kW)	2002.09-	Platform/Chassis Engine F1AE0481A		○	GWB3664	
29 L 10 V (70 kW)	2002.09-	Box Body / Estate Engine F1AE0481A		○	GWB3664	
29 L 11 (78 kW)	1999.05-	Platform/Chassis Engine 8140.43B/8140.43C		○	GWB3664	
29 L 11 V (78 kW)	1999.05-	Box Body / Estate Engine 8140.43C		○	GWB3664	
29 L 12 (85 kW)	2002.09-	Platform/Chassis Engine F1AE0481B		○	GWB3664	
29 L 12 V (85 kW)	2002.09-	Box Body / Estate Engine F1AE0481B		○	GWB3664	
29 L 13 (92 kW)	2001.05-	Box Body / Estate Engine 8140.43S		○	GWB3664	
	2001.11-	Platform/Chassis Engine 8140.43S		○	GWB3664	
29 L 14 (100 kW)	2005.01-2006.04	Box Body / Estate Engine F1AE0481M		○	GWB3664	
	2005.11-	Platform/Chassis Engine F1AE0481M		○	GWB3664	
29 L 9 (62 kW)	1999.05-	Platform/Chassis Engine 8140.63.		○	GWB3664	
29 L 9 (66 kW)	2001.11-2006.04	Platform/Chassis Engine 8140.43R		○	GWB3664	
29 L 9 V (62 kW)	1999.05-	Box Body / Estate Engine 8140.63.		○	GWB3664	
29 L 9 V (66 kW)	2001.11-2006.04	Box Body / Estate Engine 8140.43R		○	GWB3664	
35 C 10 V , 35 S 10 V (70 kW)	2002.09-	Platform/Chassis Engine F1AE0481A	•		GWB3551	
	2002.09-	Platform/Chassis Engine F1AE0481A		○	GWB3552	
	2002.09-	Platform/Chassis Engine F1AE0481A		○	GWB3664	
35 C 12 , 35 S 12 (85 kW)	2002.09-	Platform/Chassis Engine F1AE0481B	•		GWB3551	
	2002.09-	Platform/Chassis Engine F1AE0481B		○	GWB3552	
	2002.09-	Platform/Chassis Engine F1AE0481B		○	GWB3664	
35 C 12 V, 35 S 12 V (85 kW)	2002.09-	Box Body / Estate Engine F1AE0481B	•		GWB3551	
	2002.09-	Box Body / Estate Engine F1AE0481B		○	GWB3552	
	2002.09-	Box Body / Estate Engine F1AE0481B		○	GWB3664	
35 C 14 (100 kW)	2004.09-2006.04	Box Body / Estate Engine F1CE0481A	•		GWB3551	
	2004.09-2006.04	Box Body / Estate Engine F1CE0481A		○	GWB3552	
	2004.09-2006.04	Platform/Chassis Engine F1CE0481A	•		GWB3551	
	2004.09-2006.04	Platform/Chassis Engine F1CE0481A		○	GWB3552	
35 C 14, 35 S 14 (100 kW)	2005.01-2006.04	Box Body / Estate Engine F1AE0481M	•		GWB3551	
	2005.01-2006.04	Box Body / Estate Engine F1AE0481M		○	GWB3552	
	2005.01-2006.04	Box Body / Estate Engine F1AE0481M		○	GWB3664	
	2005.01-2006.04	Platform/Chassis Engine F1AE0481M	•		GWB3551	
	2005.01-2006.04	Platform/Chassis Engine F1AE0481M		○	GWB3552	
	2005.01-2006.04	Platform/Chassis Engine F1AE0481M		○	GWB3664	
35 C 15 (107 kW)	2001.11-	Platform/Chassis Engine 8140.43N	•		GWB3551	
	2001.11-	Platform/Chassis Engine 8140.43N		○	GWB3552	
35 C 17, 35 S 17 (122 kW)	2005.01-2006.04	Box Body / Estate Engine F1CE0481B	•		GWB3551	
	2005.01-2006.04	Box Body / Estate Engine F1CE0481B		○	GWB3552	
	2005.01-2006.04	Box Body / Estate Engine F1CE0481B		○	GWB3664	
	2005.01-2006.04	Platform/Chassis Engine F1CE0481B	•		GWB3551	
	2005.01-2006.04	Platform/Chassis Engine F1CE0481B		○	GWB3552	
	2005.01-2006.04	Platform/Chassis Engine F1CE0481B		○	GWB3664	
35 C 9, 35 S 9 (66 kW)	2001.11-2006.04	Platform/Chassis Engine 8140.43R	•		GWB3551	
	2001.11-2006.04	Platform/Chassis Engine 8140.43R		○	GWB3552	
	2001.11-2006.04	Platform/Chassis Engine 8140.43R		○	GWB3664	



	 YEAR		F	R	G-AP Ref.	KIT
IVECO						
DAILY III						
35 S 10 (70 kW)	2002.09-	Box Body / Estate Engine F1AE0481A		o	GWB3664	
35 S 11 V,35 C 11 V (78 kW)	1999.05-	Box Body / Estate Engine 8140.43C	•		GWB3551	
	1999.05-	Box Body / Estate Engine 8140.43C		o	GWB3552	
35 S 11,35 C 11 (78 kW)	1999.05-	Box Body / Estate Engine 8140.43C		o	GWB3664	
	1999.05-	Platform/Chassis Engine 8140.43C	•		GWB3551	
	1999.05-	Platform/Chassis Engine 8140.43C		o	GWB3552	
35 S 13 V,35 C 13 V (92 kW)	1999.05-	Platform/Chassis Engine 8140.43C		o	GWB3664	
	1999.05-	Box Body / Estate Engine 8140.43S	•		GWB3551	
	1999.05-	Box Body / Estate Engine 8140.43S		o	GWB3552	
35 S 13,35 C 13 (92 kW)	1999.05-	Box Body / Estate Engine 8140.43S		o	GWB3664	
	1999.05-	Platform/Chassis Engine 8140.43S	•		GWB3551	
	1999.05-	Platform/Chassis Engine 8140.43S		o	GWB3552	
35 S 15 V, 35 C 15 V (107 kW)	1999.05-	Platform/Chassis Engine 8140.43S		o	GWB3664	
	2002.11-	Box Body / Estate Engine 8140.43N	•		GWB3551	
	2002.11-	Box Body / Estate Engine 8140.43N		o	GWB3552	
35 S 9 V (66 kW)	2002.11-	Box Body / Estate Engine 8140.43N		o	GWB3664	
35 S 9 V,35 C 9 V (62 kW)	2001.11-2006.04	Box Body / Estate Engine 8140.43R		o	GWB3664	
	1999.05-	Box Body / Estate Engine 8140.63.	•		GWB3551	
	1999.05-	Box Body / Estate Engine 8140.63.		o	GWB3552	
35 S 9,35 C 9 (62 kW)	1999.05-	Box Body / Estate Engine 8140.63.		o	GWB3664	
	1999.05-	Platform/Chassis Engine 8140.63.	•		GWB3551	
	1999.05-	Platform/Chassis Engine 8140.63.		o	GWB3552	
40 C 13 (92 kW)	1999.05-	Platform/Chassis Engine 8140.63.		o	GWB3664	
	1999.05-2006.04	Box Body / Estate Engine 8140.43S	•		GWB3551	
	1999.05-2006.04	Box Body / Estate Engine 8140.43S		o	GWB3552	
	1999.05-2006.04	Platform/Chassis Engine 8140.43S	•		GWB3551	
40 C 14 (100 kW)	1999.05-2006.04	Platform/Chassis Engine 8140.43S		o	GWB3552	
	2004.09-2006.04	Box Body / Estate Engine F1CE0481A	•		GWB3551	
	2004.09-2006.04	Box Body / Estate Engine F1CE0481A		o	GWB3552	
	2004.09-2006.04	Platform/Chassis Engine F1CE0481A	•		GWB3551	
	2004.09-2006.04	Platform/Chassis Engine F1CE0481A		o	GWB3552	
	2005.01-2006.04	Box Body / Estate Engine F1AE0481M	•		GWB3551	
	2005.01-2006.04	Box Body / Estate Engine F1AE0481M		o	GWB3552	
40 C 15 (107 kW)	2005.01-2006.04	Platform/Chassis Engine F1AE0481M	•		GWB3551	
	2005.01-2006.04	Platform/Chassis Engine F1AE0481M		o	GWB3552	
	2001.11-2006.04	Box Body / Estate Engine 8140.43N	•		GWB3551	
	2001.11-2006.04	Box Body / Estate Engine 8140.43N		o	GWB3552	
	2001.11-2006.04	Platform/Chassis Engine 8140.43N	•		GWB3551	
40 C 17, 40 S 17 (122 kW)	2001.11-2006.04	Platform/Chassis Engine 8140.43N		o	GWB3552	
	2005.01-2006.04	Box Body / Estate Engine F1CE0481B	•		GWB3551	
	2005.01-2006.04	Box Body / Estate Engine F1CE0481B		o	GWB3552	
	2005.01-2006.04	Box Body / Estate Engine F1CE0481B		o	GWB3664	
	2005.01-2006.04	Platform/Chassis Engine F1CE0481B	•		GWB3551	
	2005.01-2006.04	Platform/Chassis Engine F1CE0481B		o	GWB3552	
50 C 11 (78 kW)	2005.01-2006.04	Platform/Chassis Engine F1CE0481B		o	GWB3664	
	1999.05-	Box Body / Estate Engine 8140.43C	•		GWB3551	
	1999.05-	Box Body / Estate Engine 8140.43C		o	GWB3552	
	1999.05-	Platform/Chassis Engine 8140.43C	•		GWB3551	
50 C 13 (92 kW)	1999.05-	Platform/Chassis Engine 8140.43C		o	GWB3552	
	1999.05-	Box Body / Estate Engine 8140.43S	•		GWB3551	
	1999.05-	Box Body / Estate Engine 8140.43S		o	GWB3552	
	1999.05-	Platform/Chassis Engine 8140.43S	•		GWB3551	
50 C 14 (100 kW)	1999.05-	Platform/Chassis Engine 8140.43S		o	GWB3552	
	2004.09-2006.04	Box Body / Estate Engine F1CE0481A	•		GWB3551	
	2004.09-2006.04	Box Body / Estate Engine F1CE0481A		o	GWB3552	
	2004.09-2006.04	Platform/Chassis Engine F1CE0481A	•		GWB3551	
	2004.09-2006.04	Platform/Chassis Engine F1CE0481A		o	GWB3552	
50 C 15 (107 kW)	2001.01-	Platform/Chassis Engine 8140.43N	•		GWB3551	
	2001.01-	Platform/Chassis Engine 8140.43N		o	GWB3552	
	2001.01-2006.04	Box Body / Estate Engine 8140.43N	•		GWB3551	
	2001.01-2006.04	Box Body / Estate Engine 8140.43N		o	GWB3552	
50 C 17 (122 kW)	2004.09-2006.04	Platform/Chassis Engine 8140.43N	•		GWB3551	
	2004.09-2006.04	Box Body / Estate Engine F1CE0481B	•		GWB3551	
	2004.09-2006.04	Box Body / Estate Engine F1CE0481B		o	GWB3552	
	2004.09-2006.04	Platform/Chassis Engine F1CE0481B	•		GWB3551	
	2004.09-2006.04	Platform/Chassis Engine F1CE0481B		o	GWB3552	



	 YEAR		F	R	G-AP Ref.	KIT
IVECO						
DAILY IV						
29 L 10 V (70 kW)	2006.05-	Box Body / Estate Engine F1AE0481FA	•		GWB3551	
29 L 12 V, 29 L 12 V/P (85 kW)	2006.05-	Box Body / Estate Engine F1AE0481GA	•		GWB3551	
35C10, 35S10 (70 kW)	2006.05-	Box Body / Estate Engine F1AE0481FA	•		GWB3551	
	2006.05-	Platform/Chassis Engine F1AE0481FA	•		GWB3551	
	2006.05-	Platform/Chassis Engine F1AE0481FA		o	GWB3552	
35C12 (85 kW)	2006.05-	Dumptruck Engine F1AE0481GA	•		GWB3551	
	2006.05-	Dumptruck Engine F1AE0481GA		o	GWB3552	
35C12 V, 35C12 V/P, 35S12 V, 35S12 V/P (85 kW)	2006.05-	Box Body / Estate Engine F1AE0481GA	•		GWB3551	
35C12, 35S12 (85 kW)	2006.05-	Platform/Chassis Engine F1AE0481GA	•		GWB3551	
35C14 G, 35C14 G/P, 35S14 G, 35S14 G/P, 35C14 GD, 35S14 GD (100 kW)	2007.07-	Platform/Chassis Engine F1CE0441A	•		GWB3551	
35C14 GV, 35C14 GV/P, 35S14 GV, 35S14 GV/P (100 kW)	2007.07-	Box Body / Estate Engine F1CE0441A	•		GWB3551	
35C14 K, 35C14 DK, 35S14 K, 35S14 DK (103 kW)	2007.07-	Dumptruck Engine F1CE3481LC	•		GWB3551	
35C14 V, 35C14 V/P, 35S14 V, 35S14 V/P (103 kW)	2007.07-	Box Body / Estate Engine F1CE3481LC	•		GWB3551	
35C14, 35C14 /P, 35S14, 35S14 /P, 35S14 D, 35S14 D/P (103 kW)	2007.07-	Platform/Chassis Engine F1CE3481LC	•		GWB3551	
35C14, 35S14, 35S14 /P (100 kW)	2006.05-	Platform/Chassis Engine F1AE0481HA	•		GWB3551	
35C15 (107 kW)	2006.05-	Dumptruck Engine F1CE0481FA	•		GWB3551	
	2006.05-	Dumptruck Engine F1CE0481FA		o	GWB3552	
	2006.05-	Platform/Chassis Engine F1CE0481FA	•		GWB3551	
	2006.05-	Platform/Chassis Engine F1CE0481FA		o	GWB3552	
35C15 V, 35C15 V/P (107 kW)	2006.05-	Box Body / Estate Engine F1CE0481FA	•		GWB3551	
	2006.05-	Box Body / Estate Engine F1CE0481FA		o	GWB3552	
35C18 (130 kW)	2006.05-	Dumptruck Engine F1CE0481HA	•		GWB3551	
	2006.05-	Dumptruck Engine F1CE0481HA		o	GWB3552	
35C18 V, 35C18 V/P, 35S18 V, 35S18 V/P (130 kW)	2006.05-	Box Body / Estate Engine F1CE0481HA	•		GWB3551	
35C18, 35S18 (130 kW)	2006.05-	Platform/Chassis Engine F1CE0481HA	•		GWB3551	
35S14 C, 35S14 C/P, 35S14 V, 35S14 V/P, 35C14 V, 35C14 V/P (100 kW)	2006.05-	Box Body / Estate Engine F1AE0481HA	•		GWB3551	
35S14 G (100 kW)	2009.07-	Bus Engine F1CE0441A	•		GWB3551	
35S14, 35S14 /P (100 kW)	2006.05-	Bus Engine F1AE0481HA	•		GWB3551	
40C10 (70 kW)	2006.05-	Platform/Chassis Engine F1AE0481FA	•		GWB3551	
40C10 V (70 kW)	2006.05-	Box Body / Estate Engine F1AE0481FA	•		GWB3551	
	2006.05-	Box Body / Estate Engine F1AE0481FA		o	GWB3552	
40C11 V (78 kW)	2007.07-2011.08	Box Body/Estate Engine F1AE0481FA	•		GWB3551	
	2007.07-2011.08	Box Body/Estate Engine F1AE0481FA		o	GWB3552	
40C12 (85 kW)	2006.05-	Platform/Chassis Engine F1AE0481GA	•		GWB3551	
	2006.05-	Platform/Chassis Engine F1AE0481GA		o	GWB3552	
40C12 V, 40C14 V/P (85 kW)	2006.05-	Box Body / Estate Engine F1AE0481GA	•		GWB3551	
	2006.05-	Box Body / Estate Engine F1AE0481GA		o	GWB3552	
40C13 V, 40C13 V/P (93 kW)	2007.07-2011.08	Box Body/Estate Engine F1AE0481GA	•		GWB3551	
	2007.07-2011.08	Box Body/Estate Engine F1AE0481GA		o	GWB3552	
40C14 G, 40C14 G/P (100 kW)	2007.07-	Platform/Chassis Engine F1CE0441A	•		GWB3551	
40C14 GV, 40C14 GV/P (100 kW)	2007.07-	Box Body / Estate Engine F1CE0441A	•		GWB3551	
40C14 K, 40C14 DK (103 kW)	2007.07-	Dumptruck Engine F1CE3481LC	•		GWB3551	
40C14 V, 40C14 V/P (103 kW)	2007.07-	Box Body / Estate Engine F1CE3481LC	•		GWB3551	
40C14, 40C14 /P (103 kW)	2007.07-	Platform/Chassis Engine F1CE3481LC	•		GWB3551	
40C15 (107 kW)	2006.05-	Platform/Chassis Engine F1CE0481FA	•		GWB3551	
	2006.05-	Platform/Chassis Engine F1CE0481FA		o	GWB3552	
40C15 V, 40C15 V/P (107 kW)	2006.05-	Box Body / Estate Engine F1CE0481FA	•		GWB3551	
	2006.05-	Box Body / Estate Engine F1CE0481FA		o	GWB3552	
40C17 V, 40C17 V/P (125 kW)	2007.07-2011.08	Box Body/Estate Engine F1CE0481HA	•		GWB3551	
	2007.07-2011.08	Box Body/Estate Engine F1CE0481HA		o	GWB3552	
40C18 (130 kW)	2006.05-	Platform/Chassis Engine F1CE0481HA	•		GWB3551	
	2006.05-	Platform/Chassis Engine F1CE0481HA		o	GWB3552	
40C18 V, 40C18 V/P (130 kW)	2006.05-	Box Body / Estate Engine F1CE0481HA	•		GWB3551	
	2006.05-	Box Body / Estate Engine F1CE0481HA		o	GWB3552	
45C14, 45C14 /P (103 kW)	2007.07-2011.08	Platform/Chassis Engine F1CE3481LC	•		GWB3551	
	2007.07-2011.08	Platform/Chassis Engine F1CE3481LC		o	GWB3552	
45C15 (107 kW)	2006.05-2011.08	Platform/Chassis Engine F1CE0481FA	•		GWB3551	
	2006.05-2011.08	Platform/Chassis Engine F1CE0481FA		o	GWB3552	
45C15 V (107 kW)	2006.05-2011.08	Box Body/Estate Engine F1CE0481FA	•		GWB3551	
	2006.05-2011.08	Box Body/Estate Engine F1CE0481FA		o	GWB3552	
45C17 V, 45C17 V/P (125 kW)	2007.07-2011.08	Box Body/Estate Engine F1CE0481HA	•		GWB3551	
	2007.07-2011.08	Box Body/Estate Engine F1CE0481HA		o	GWB3552	
45C17, 45C17 /P (125 kW)	2007.07-2011.08	Platform/Chassis Engine F1CE0481HA	•		GWB3551	
	2007.07-2011.08	Platform/Chassis Engine F1CE0481HA		o	GWB3552	
45C18 (130 kW)	2006.05-2011.08	Box Body/Estate Engine F1CE0481HA	•		GWB3551	



	 YEAR		F	R	G-AP Ref.	KIT
IVECO						
DAILY IV						
45C18 (130 kW)	2006.05-2011.08	Box Body/Estate Engine F1CE0481HA		o	GWB3552	
45C18, 45C18 /P, 45C18 D, 45C18 D/P (130 kW)	2006.05-2011.08	Platform/Chassis Engine F1CE0481HA	•		GWB3551	
	2006.05-2011.08	Platform/Chassis Engine F1CE0481HA		o	GWB3552	
50C14 G, 50C14 G/P, 50C14 GD, 50C14 GD/P (100 kW)	2007.07-	Platform/Chassis Engine F1CE0441A	•		GWB3551	
	2007.07-	Platform/Chassis Engine F1CE0441A		o	GWB3552	
50C14 GV, 50C14 GV/P (100 kW)	2007.07-	Box Body / Estate Engine F1CE0441A	•		GWB3551	
	2007.07-	Box Body / Estate Engine F1CE0441A		o	GWB3552	
50C14 K, 50C14 DK (103 kW)	2007.07-	Dumptruck Engine F1CE3481LC	•		GWB3551	
	2007.07-	Dumptruck Engine F1CE3481LC		o	GWB3552	
50C14 V, 50C14 V/P (103 kW)	2007.07-	Box Body / Estate Engine F1CE3481LC	•		GWB3551	
	2007.07-	Box Body / Estate Engine F1CE3481LC		o	GWB3552	
50C14, 50C14 /P (103 kW)	2007.07-	Platform/Chassis Engine F1CE3481LC	•		GWB3551	
	2007.07-	Platform/Chassis Engine F1CE3481LC		o	GWB3552	
50C15 (107 kW)	2006.05-	Dumptruck Engine F1CE0481FA	•		GWB3551	
	2006.05-	Dumptruck Engine F1CE0481FA		o	GWB3552	
	2006.05-	Platform/Chassis Engine F1CE0481FA	•		GWB3551	
	2006.05-	Platform/Chassis Engine F1CE0481FA		o	GWB3552	
50C15 V, 50C15 V/P (107 kW)	2006.05-	Box Body / Estate Engine F1CE0481FA	•		GWB3551	
	2006.05-	Box Body / Estate Engine F1CE0481FA		o	GWB3552	
50C17 V, 50C17 V/P (125 kW)	2007.07-2011.08	Box Body/Estate Engine F1CE0481HA	•		GWB3551	
	2007.07-2011.08	Box Body/Estate Engine F1CE0481HA		o	GWB3552	
50C17, 50C17 /P (125 kW)	2007.07-2011.08	Platform/Chassis Engine F1CE0481HA	•		GWB3551	
	2007.07-2011.08	Platform/Chassis Engine F1CE0481HA		o	GWB3552	
50C18 (130 kW)	2006.05-	Dumptruck Engine F1CE0481HA	•		GWB3551	
	2006.05-	Dumptruck Engine F1CE0481HA		o	GWB3552	
	2006.05-	Platform/Chassis Engine F1CE0481HA	•		GWB3551	
	2006.05-	Platform/Chassis Engine F1CE0481HA		o	GWB3552	
50C18 V, 50C18 V/P (130 kW)	2006.05-	Box Body / Estate Engine F1CE0481HA	•		GWB3551	
	2006.05-	Box Body / Estate Engine F1CE0481HA		o	GWB3552	
DAILY IV DUMPTRUCK						
35C10 K (70 kW)	2006.05-2011.08	Dumptruck Engine F1AE0481FA	•		GWB3551	
	2006.05-2011.08	Dumptruck Engine F1AE0481FA		o	GWB3552	
40C17 K, 40C17 DK (125 kW)	2007.07-2011.08	Dumptruck Engine F1CE0481HA	•		GWB3551	
	2007.07-2011.08	Dumptruck Engine F1CE0481HA		o	GWB3552	
50C17 K, 50C17 DK (125 kW)	2007.07-2011.08	Dumptruck Engine F1CE0481HA	•		GWB3551	
	2007.07-2011.08	Dumptruck Engine F1CE0481HA		o	GWB3552	
DAILY LINE						
3.0 (107 kW)	2014.06-	Bus Engine F1CFL411E	•		GWB3551	
	2014.06-	Bus Engine F1CFL411E		o	GWB3552	
3.0 (125 kW)	2014.06-	Bus Engine F1CFL411F	•		GWB3551	
	2014.06-	Bus Engine F1CFL411F		o	GWB3552	
3.0 CNG (100 kW)	2014.06-	Bus Engine F1CFA401A	•		GWB3551	
	2014.06-	Bus Engine F1CFA401A		o	GWB3552	
DAILY TOURYS						
3.0 (125 kW)	2014.06-	Bus Engine F1CFL411F	•		GWB3551	
	2014.06-	Bus Engine F1CFL411F		o	GWB3552	
DAILY VI						
3.0 Natural Power 35S14, 35C14, 40C14, 50C14, 65C14, 70C14 (100 kW)	2014.03-	Box Body/Estate Engine F1CFA404A/F1CFA401B	•		GWB3551	
	2014.03-	Box Body/Estate Engine F1CFA404A/F1CFA401B		o	GWB3552	
33S11, 35S11, 35C11 (78 kW)	2014.03-	Box Body/Estate Engine F1AE3481A/F1AFL411A	•		GWB3551	
	2014.03-	Box Body/Estate Engine F1AE3481A/F1AFL411A		o	GWB3552	
	2014.03-	Platform/Chassis Engine F1AE3481A/F1AFL411A	•		GWB3551	
	2014.03-	Platform/Chassis Engine F1AE3481A/F1AFL411A		o	GWB3552	
33S13, 35S13, 35C13 (93 kW)	2014.03-	Box Body/Estate Engine F1AFL411B	•		GWB3551	
	2014.03-	Box Body/Estate Engine F1AFL411B		o	GWB3552	
	2014.03-	Platform/Chassis Engine F1AE3481B/F1AFL411B	•		GWB3551	
	2014.03-	Platform/Chassis Engine F1AE3481B/F1AFL411B		o	GWB3552	
33S15, 35S15, 35C15 (107 kW)	2014.03-	Box Body/Estate Engine F1AE3481C/F1AFL411C	•		GWB3551	
	2014.03-	Box Body/Estate Engine F1AE3481C/F1AFL411C		o	GWB3552	
	2014.03-	Platform/Chassis Engine F1AE3481C/F1AFL411C	•		GWB3551	
	2014.03-	Platform/Chassis Engine F1AE3481C/F1AFL411C		o	GWB3552	
35S15, 35C15, 40C15, 50C15, 65C15, 70C15 (107 kW)	2014.03-	Box Body/Estate Engine F1CE3481J/F1CFL411E/F1CFL411J	•		GWB3551	
	2014.03-	Box Body/Estate Engine F1CE3481J/F1CFL411E/F1CFL411J		o	GWB3552	
	2014.03-	Platform/Chassis Engine F1CE3481J/F1CFL411E/F1CFL411J	•		GWB3551	



	 YEAR		F	R	G-AP Ref.	KIT
IVECO						
DAILY VI						
35S15, 35C15, 40C15, 50C15, 65C15, 70C15 (107 kW)	2014.03-	Platform/Chassis Engine F1CE3481J/F1CFL411E/F1CFL411J	•		GWB3552	
35S17 W, 35S17 WD (125 kW)	2007.07-2011.08	Platform/Chassis Engine F1CE0481HA		○	GWB3552	
35S17, 35C17, 40C17, 50C17, 65C17, 70C17 (125 kW)	2014.03-	Box Body/Estate Engine F1CE3481K/F1CFL411F/F1CFL411H	•		GWB3551	
	2014.03-	Box Body/Estate Engine F1CE3481K/F1CFL411F/F1CFL411H	•		GWB3552	
	2014.03-	Platform/Chassis Engine F1CE3481K/F1CFL411F/F1CFL411H	•		GWB3551	
	2014.03-	Platform/Chassis Engine F1CE3481K/F1CFL411F/F1CFL411H	•		GWB3552	
35S21, 35C21, 40C21, 50C21, 65C21, 70C21 (150 kW)	2014.03-	Box Body/Estate Engine F1CE3481D/F1CFL411G	•		GWB3551	
	2014.03-	Box Body/Estate Engine F1CE3481D/F1CFL411G	•		GWB3552	
	2014.03-	Platform/Chassis Engine F1CE3481D/F1CFL411G	•		GWB3551	
	2014.03-	Platform/Chassis Engine F1CE3481D/F1CFL411G	•		GWB3552	
55S17 W, 55S17 WD (125 kW)	2007.07-2011.08	Platform/Chassis Engine F1CE0481HA		○	GWB3552	
Natural Power 35S14, 35C14, 40C14, 50C14, 65C14, 70C14 (100 kW)	2014.03-	Platform/Chassis Engine F1CFA401A	•		GWB3551	
	2014.03-	Platform/Chassis Engine F1CFA401A	•		GWB3552	
JAGUAR						
S-TYPE (CCX)						
2.5 V6 (147 kW)	2002.04-2007.10	Saloon		○	GHA400076	
	2002.04-2007.10	Saloon		○	GWB3688	
2.7 D (152 kW)	2004.06-2007.10	Saloon Engine AJD		○	GHA400076	
	2004.06-2007.10	Saloon Engine AJD		○	GWB3688	
3.0 V6 (175 kW)	1999.01-2007.10	Saloon Engine AJ-V6		○	GWB3688	
4.0 V8 (203 kW)	1999.01-2002.04	Saloon Engine AJ-V8		○	GHA400076	
	1999.01-2002.04	Saloon Engine AJ-V8		○	GWB3688	
4.2 V8 (219 kW)	2002.04-2007.10	Saloon		○	GHA400076	
	2002.04-2007.10	Saloon		○	GWB3688	
R 4,2 V8 (291 kW)	2002.04-2007.10	Saloon Engine AJ8FT		○	GHA400076	
	2002.04-2007.10	Saloon Engine AJ8FT		○	GWB3688	
XF (_J05_, CC9)						
2.0 (177 kW)	2012.06-2015.04	Saloon Engine 204PT		○	GHA400076	
2.2 D (120 kW)	2011.04-2015.04	Saloon Engine 224DT		○	GHA400076	
2.2 D (140 kW)	2011.05-2015.04	Saloon Engine 224DT		○	GHA400076	
2.2 D (147 kW)	2012.03-2015.04	Saloon Engine 224DT		○	GHA400076	
3.0 (250 kW)	2012.03-2015.04	Saloon Engine AJ 126		○	GHA400076	
3.0 AWD (250 kW)	2012.10-2015.04	Saloon Engine AJ 126		○	GHA400076	
3.0 D (155 kW)	2009.03-2015.04	Saloon Engine AJV6D		○	GHA400076	
4.2 Kompressor (306 kW)	2008.03-2015.04	Saloon Engine SV8TS		○	GHA400076	
XJ (X350, X358)						
2,7 D (152 kW)	2005.10-2009.03	Saloon Engine AJD		○	GHA400076	
3.0 (175 kW)	2003.05-2009.03	Saloon Engine AJ-V6	•		GHA400181	
	2003.05-2009.03	Saloon Engine AJ-V6		○	GWB3688	
3.0 (179 kW)	2004.04-2007.01	Saloon Engine AJ-V6		○	GHA400076	
3.5 (190 kW)	2003.05-2009.03	Saloon	•		GHA400181	
	2003.05-2009.03	Saloon		○	GHA400076	
	2003.05-2009.03	Saloon		○	GWB3688	
4.2 (219 kW)	2003.05-2009.03	Saloon Engine AJ-V8	•		GHA400181	
	2003.05-2009.03	Saloon Engine AJ-V8		○	GHA400076	
	2003.05-2009.03	Saloon Engine AJ-V8		○	GWB3688	
R 4,2 (291 kW)	2003.05-2009.03	Saloon Engine AJ8FT		○	GHA400076	
	2003.05-2009.03	Saloon Engine AJ8FT		○	GWB3688	
XK (_J43_)						
4.2 XKR (306 kW)	2006.03-2014.07	Convertible Engine SV8TS		○	GHA400076	
XK (QQ6_, _J43_)						
4.2 XKR (291 kW)	2006.03-2014.07	Coupe Engine AJ8FT		○	GHA400076	
4.2 XKR (306 kW)	2006.03-2014.07	Coupe Engine SV8TS		○	GHA400076	
XK 8 (QDV)						
R 4,2 (291 kW)	2002.08-2005.07	Convertible Engine AJ8FT		○	GHA400076	
XK 8 (QEV)						
	2002.08-2005.07	Coupe Engine AJ8FT		○	GHA400076	
X-TYPE						
2.0 D (96 kW)	2004.02-2009.12	Estate Engine FMBA/FMBB/R4-X404	•		GWB3575	
	2004.02-2009.12	Estate Engine FMBA/FMBB/R4-X404		○	GHA326038	K
	2004.02-2009.12	Estate Engine FMBA/FMBB/R4-X404		○	GHA400081	K
2.0 V6 (115 kW)	2003.11-2009.03	Estate	•		GWB3575	
	2003.11-2009.03	Estate		○	GHA326038	K



	 YEAR		F	R	G-AP Ref.	KIT
JAGUAR						
X-TYPE						
2.0 V6 (115 kW)	2003.11-2009.03	Estate		o	GHA400081	K
2.2 D (107 kW)	2007.01-2009.12	Estate Engine LJ46G	•		GWB3575	
	2007.01-2009.12	Estate Engine LJ46G		o	GHA326038	K
	2007.01-2009.12	Estate Engine LJ46G		o	GHA400081	K
2.2 D (110 kW)	2005.10-2009.12	Estate Engine LJ46G	•		GWB3575	
	2005.10-2009.12	Estate Engine LJ46G		o	GHA326038	K
	2005.10-2009.12	Estate Engine LJ46G		o	GHA400081	K
2.2 D (114 kW)	2005.10-2009.12	Estate Engine LJ46G	•		GWB3575	
	2005.10-2009.12	Estate Engine LJ46G		o	GHA326038	K
	2005.10-2009.12	Estate Engine LJ46G		o	GHA400081	K
2.5 (144 kW)	2004.02-2009.12	Estate	•		GWB3575	
	2004.02-2009.12	Estate		o	GHA326038	K
	2004.02-2009.12	Estate		o	GHA400081	K
3.0 (169 kW)	2004.02-2009.12	Estate Engine AJ-V6	•		GWB3575	
	2004.02-2009.12	Estate Engine AJ-V6		o	GHA326038	K
	2004.02-2009.12	Estate Engine AJ-V6		o	GHA400081	K
X-TYPE (CF1)						
2.0 D (96 kW)	2003.07-2009.11	Saloon Engine FMBA/FMBB/R4-X404	•		GWB3575	
	2003.07-2009.11	Saloon Engine FMBA/FMBB/R4-X404		o	GHA326038	K
	2003.07-2009.11	Saloon Engine FMBA/FMBB/R4-X404		o	GHA400081	K
2.0 V6 (115 kW)	2002.03-2005.10	Saloon	•		GWB3575	
	2002.03-2005.10	Saloon		o	GHA326038	K
	2002.03-2005.10	Saloon		o	GHA400081	K
2.2 D (107 kW)	2007.01-2009.11	Saloon Engine LJ46G	•		GWB3575	
	2007.01-2009.11	Saloon Engine LJ46G		o	GHA326038	K
	2007.01-2009.11	Saloon Engine LJ46G		o	GHA400081	K
2.2 D (110 kW)	2005.10-2009.11	Saloon Engine LJ46G	•		GWB3575	
	2005.10-2009.11	Saloon Engine LJ46G		o	GHA326038	K
	2005.10-2009.11	Saloon Engine LJ46G		o	GHA400081	K
2.2 D (114 kW)	2005.10-2009.11	Saloon Engine LJ46G	•		GWB3575	
	2005.10-2009.11	Saloon Engine LJ46G		o	GHA326038	K
	2005.10-2009.11	Saloon Engine LJ46G		o	GHA400081	K
2.5 V6 (144 kW)	2001.06-2009.11	Saloon	•		GWB3575	
	2001.06-2009.11	Saloon		o	GHA326038	K
	2001.06-2009.11	Saloon		o	GHA400081	K
3.0 V6 (169 kW)	2001.06-2007.11	Saloon Engine AJ-V6	•		GWB3575	
	2001.06-2007.11	Saloon Engine AJ-V6		o	GHA326038	K
	2001.06-2007.11	Saloon Engine AJ-V6		o	GHA400081	K
JEEP						
CHEROKEE (KJ)						
2.4 4x4 (108 kW)	2001.09-2008.01	Closed Off-Road Vehicle Engine ED1	•		GHA327051	
	2001.09-2008.01	Closed Off-Road Vehicle Engine ED1 Left With ABS	•		GHA327028	
	2001.09-2008.01	Closed Off-Road Vehicle Engine ED1 Right With ABS	•		GHA327043	K
	2001.09-2008.01	Closed Off-Road Vehicle Engine ED1 With ABS	•		GHA327028	
	2001.09-2008.01	Closed Off-Road Vehicle Engine ED1 With ABS	•		GHA327043	K
2.4 LareDo (108 kW)	2001.10-2004.09	Closed Off-Road Vehicle Engine ED1	•		GHA327051	
	2001.10-2004.09	Closed Off-Road Vehicle Engine ED1 Left With ABS	•		GHA327028	
	2001.10-2004.09	Closed Off-Road Vehicle Engine ED1 Right With ABS	•		GHA327043	K
	2001.10-2004.09	Closed Off-Road Vehicle Engine ED1 With ABS	•		GHA327028	
	2001.10-2004.09	Closed Off-Road Vehicle Engine ED1 With ABS	•		GHA327043	K
2.5 CRD 4x4 (105 kW)	2001.09-2008.01	Closed Off-Road Vehicle Engine R425DOHC	•		GHA327051	
	2001.09-2008.01	Closed Off-Road Vehicle Engine R425DOHC Left With ABS	•		GHA327028	
	2001.09-2008.01	Closed Off-Road Vehicle Engine R425DOHC Right With ABS	•		GHA327043	K
	2001.09-2008.01	Closed Off-Road Vehicle Engine R425DOHC With ABS	•		GHA327028	
	2001.09-2008.01	Closed Off-Road Vehicle Engine R425DOHC With ABS	•		GHA327043	K
2.8 CRD 4x4 (110 kW)	2002.09-2004.12	Closed Off-Road Vehicle Engine ENR	•		GHA327051	
	2002.09-2004.12	Closed Off-Road Vehicle Engine ENR Left With ABS	•		GHA327028	
	2002.09-2004.12	Closed Off-Road Vehicle Engine ENR Right With ABS	•		GHA327043	K
	2002.09-2004.12	Closed Off-Road Vehicle Engine ENR With ABS	•		GHA327028	
	2002.09-2004.12	Closed Off-Road Vehicle Engine ENR With ABS	•		GHA327043	K
2.8 CRD 4x4 (120 kW)	2005.01-2006.03	Closed Off-Road Vehicle Engine ENR	•		GHA327051	
	2005.01-2006.03	Closed Off-Road Vehicle Engine ENR Left With ABS	•		GHA327028	
	2005.01-2006.03	Closed Off-Road Vehicle Engine ENR Right With ABS	•		GHA327043	K
	2005.01-2006.03	Closed Off-Road Vehicle Engine ENR With ABS	•		GHA327028	



	 YEAR		F	R	G-AP Ref.	KIT
JEEP						
CHEROKEE (KJ)						
2.8 CRD 4x4 (120 kW)	2005.01-2006.03	Closed Off-Road Vehicle Engine ENR With ABS	•		GHA327043	K
3.7 4x4 (150 kW)	2004.01-2007.12	Closed Off-Road Vehicle Engine EKG	•		GHA327051	
	2004.01-2007.12	Closed Off-Road Vehicle Engine EKG Left With ABS	•		GHA327028	
	2004.01-2007.12	Closed Off-Road Vehicle Engine EKG Right With ABS	•		GHA327043	K
	2004.01-2007.12	Closed Off-Road Vehicle Engine EKG With ABS	•		GHA327028	
	2004.01-2007.12	Closed Off-Road Vehicle Engine EKG With ABS	•		GHA327043	K
	2004.01-2007.12	Closed Off-Road Vehicle Engine EKG With ABS	•		GHA327043	K
3.7 4x4 (155 kW)	2001.09-2008.01	Closed Off-Road Vehicle Engine EKG	•		GHA327051	
	2001.09-2008.01	Closed Off-Road Vehicle Engine EKG Left With ABS	•		GHA327028	
	2001.09-2008.01	Closed Off-Road Vehicle Engine EKG Right With ABS	•		GHA327043	K
	2001.09-2008.01	Closed Off-Road Vehicle Engine EKG With ABS	•		GHA327028	
	2001.09-2008.01	Closed Off-Road Vehicle Engine EKG With ABS	•		GHA327043	K
3.7 LareDo (150 kW)	2001.10-2004.09	Closed Off-Road Vehicle Engine EKG	•		GHA327051	
	2001.10-2004.09	Closed Off-Road Vehicle Engine EKG Left With ABS	•		GHA327028	
	2001.10-2004.09	Closed Off-Road Vehicle Engine EKG Right With ABS	•		GHA327043	K
	2001.10-2004.09	Closed Off-Road Vehicle Engine EKG With ABS	•		GHA327028	
	2001.10-2004.09	Closed Off-Road Vehicle Engine EKG With ABS	•		GHA327043	K
CHEROKEE (KK)						
2.8 CRD 4x4 (130 kW)	2008.05-	Closed Off-Road Vehicle Engine ENS	•		GHA332006	
2.8 CRDi 4x4 (147 kW)	2010.01-	Closed Off-Road Vehicle Engine ENS	•		GHA332006	
3.7 V6 4x4 (151 kW)	2008.01-	Closed Off-Road Vehicle Engine EKG	•		GHA332006	
CHEROKEE (XJ)						
2.5 (89 kW)	1990.10-1996.09	Closed Off-Road Vehicle Engine EPE	•		GHA327010	K
	1995.10-2001.09	Closed Off-Road Vehicle Engine EPE	•		GHA327013	
2.5 i 4x4 (90 kW)	1991.12-2001.09	Closed Off-Road Vehicle Engine EPE/HX	•		GHA327010	K
	1991.12-2001.09	Closed Off-Road Vehicle Engine EPE/HX	•		GHA327013	
2.5 SE (87 kW)	1996.10-1999.09	Closed Off-Road Vehicle Engine EPE	•		GHA327013	
2.5 TDi 4x4 (85 kW)	1996.10-2001.09	Closed Off-Road Vehicle Engine ENC	•		GHA327013	
4.0 i (127 kW)	1998.07-2001.09	Closed Off-Road Vehicle	•		GHA327010	K
	1998.07-2001.09	Closed Off-Road Vehicle	•		GHA327013	
4.0 i (135 kW)	1991.12-2001.09	Closed Off-Road Vehicle Engine MX	•		GHA327013	
	1999.02-2001.09	Closed Off-Road Vehicle Engine MX	•		GHA327013	
4.0 i 4x4 (131 kW)	1995.01-2001.09	Closed Off-Road Vehicle Engine ERH	•		GHA327010	K
	1995.01-2001.09	Closed Off-Road Vehicle Engine ERH	•		GHA327013	
COMMANDER (XK)						
3.0 CRD 4x4 (160 kW)	2006.02-2007.12	Closed Off-Road Vehicle Engine EXL	•		GHA329004	K
	2006.02-2007.12	Closed Off-Road Vehicle Engine EXL		o	GHA329007	
3.7 V6 4x4 (157 kW)	2005.09-2010.12	Closed Off-Road Vehicle Engine EKG		o	GHA329007	
4.7 V8 4x4 (170 kW)	2005.09-2010.12	Closed Off-Road Vehicle Engine EVA		o	GHA329007	
5.7 V8 4x4 (240 kW)	2006.02-2006.10	Closed Off-Road Vehicle Engine EZB		o	GHA329007	
COMPASS (MK49)						
2.0 CRD 4x4 (103 kW)	2006.09-			o	GHA325018	K
	2006.09-			o	GHA325029	
2.2 CRD 4x4 (120 kW)	2010.12-	Closed Off-Road Vehicle Engine OM 651.925		o	GHA325018	K
2.4 4x4 (125 kW)	2007.04-	Closed Off-Road Vehicle Engine ED3		o	GHA325018	K
	2007.04-	Closed Off-Road Vehicle Engine ED3		o	GHA325029	
GRAND CHEROKEE (ZJ)						
2.5 TD 4x4 (85 kW)	1995.10-1999.04	Closed Off-Road Vehicle Engine M51/M52	•		GHA327010	K
4.0 i 4x4 (130 kW)	1995.10-1999.04	Closed Off-Road Vehicle Engine S01	•		GHA327010	K
5.2 4x4 (156 kW)	1995.10-1999.04	Closed Off-Road Vehicle Engine Y01	•		GHA327010	K
5.2 i 4x4 (155 kW)	1992.01-1999.04	Closed Off-Road Vehicle Engine ELF	•		GHA327010	K
5.2 i 4x4 (158 kW)	1992.09-1999.04	Closed Off-Road Vehicle Engine Y	•		GHA327010	K
5.9 i 4x4 (177 kW)	1997.08-1999.04	Closed Off-Road Vehicle	•		GHA327010	K
GRAND CHEROKEE II (WJ, WG)						
3.1 TD 4x4 (103 kW)	1999.04-2001.12	Closed Off-Road Vehicle Engine EXA	•		GHA327015	K
4.0 4x4 (140 kW)	1999.04-2005.09	Closed Off-Road Vehicle Engine ERH	•		GHA327015	K
4.7 V8 4x4 (162 kW)	1999.04-2000.08	Closed Off-Road Vehicle Engine EVA	•		GHA327015	K
GRAND CHEROKEE III (WH, WK)						
3.0 CRD 4x4 (155 kW)	2006.05-2010.12	Closed Off-Road Vehicle Engine EXL		o	GHA329007	
3.0 CRD 4x4 (160 kW)	2005.06-2010.12	Closed Off-Road Vehicle Engine EXL	•		GHA329004	K
	2005.06-2010.12	Closed Off-Road Vehicle Engine EXL		o	GHA329007	
3.7 V6 4x4 (148 kW)	2008.01-2010.12	Closed Off-Road Vehicle Engine EKG		o	GHA329007	
3.7 V6 4x4 (157 kW)	2005.06-2010.12	Closed Off-Road Vehicle Engine EKG		o	GHA329007	
4.7 V8 4x4 (170 kW)	2005.06-2010.12	Closed Off-Road Vehicle Engine EVA	•		GHA329004	K
	2005.06-2010.12	Closed Off-Road Vehicle Engine EVA		o	GHA329007	



	 YEAR		F	R	G-AP Ref.	KIT
JEEP						
GRAND CHEROKEE III (WH, WK)						
4.7 V8 4x4 (223 kW)	2007.09-2010.02	Closed Off-Road Vehicle		o	GHA329007	
5.7 V8 4x4 (240 kW)	2005.06-2010.12	Closed Off-Road Vehicle Engine EZB	•		GHA329004	K
	2005.06-2010.12	Closed Off-Road Vehicle Engine EZB		o	GHA329007	
5.7 V8 4x4 (259 kW)	2009.01-2010.12	Closed Off-Road Vehicle Engine EZD/EZH		o	GHA329007	
6.1 SRT8 4x4 (313 kW)	2006.07-2010.12	Closed Off-Road Vehicle Engine ESF	•		GHA329004	K
	2006.07-2010.12	Closed Off-Road Vehicle Engine ESF		o	GHA329007	
PATRIOT (MK74)						
2.0 CRD 4x4 (103 kW)	2007.02-	Closed Off-Road Vehicle Engine ECD/ECE		o	GHA325018	K
	2007.02-	Closed Off-Road Vehicle Engine ECD/ECE		o	GHA325029	
2.2 CRD 4x4 (100 kW)	2011.01-	Closed Off-Road Vehicle Engine ENE		o	GHA325018	K
2.2 CRD 4x4 (120 kW)	2011.01-	Closed Off-Road Vehicle Engine ENE		o	GHA325018	K
2.4 (125 kW)	2009.06-	Closed Off-Road Vehicle Engine ED3	•		GWB7408	
	2009.06-	Closed Off-Road Vehicle Engine ED3		o	GHA325018	K
2.4 4x4 (125 kW)	2008.01-	Closed Off-Road Vehicle Engine ED3	•		GWB7408	
	2008.01-	Closed Off-Road Vehicle Engine ED3		o	GHA325018	K
	2008.01-	Closed Off-Road Vehicle Engine ED3		o	GHA325029	
2.4 Eco + 4x4 (125 kW)	2008.07-		•		GWB7408	
	2008.07-			o	GHA325018	K
WRANGLER (YJ, SJ_)						
2.5 (89 kW)	1991.12-1996.08	Closed Off-Road Vehicle Engine EPE	•		GHA327010	K
4.0 (131 kW)	1991.12-1996.08	Closed Off-Road Vehicle Engine ERH	•		GHA327010	K
WRANGLER II (TJ)						
2.4 (105 kW)	2002.11-2007.04	Open Off-Road Vehicle Engine ED1	•		GHA327010	K
2.5 (87 kW)	1996.08-2007.04	Open Off-Road Vehicle Engine P00	•		GHA327010	K
4.0 (124 kW)	1998.06-2007.04	Open Off-Road Vehicle	•		GHA327010	K
4.0 Rubicon (128 kW)	1997.04-2007.12	Open Off-Road Vehicle	•		GHA327010	K
WRANGLER III (JK)						
2.8 CRD (130 kW)	2007.04-	Closed Off-Road Vehicle Engine ENS	•		GHA332008	K
2.8 CRD (147 kW)	2010.11-	Closed Off-Road Vehicle Engine ENS	•		GHA332008	K
3.8 (146 kW)	2007.04-	Closed Off-Road Vehicle Engine EGT	•		GHA332008	K
KIA						
AVELLA						
1.3 (55 kW)	1995.11-2001.12	Hatchback Engine B3	•		GWB0949	
	1995.11-2001.12	Saloon Engine B3	•		GWB0949	
1.5 (55 kW)	1997.02-2001.12	Hatchback	•		GWB0949	
	1997.02-2001.12	Saloon	•		GWB0949	
CADENZA						
3.5 CVVT (213 kW)	2010.01-	Saloon Engine G6DC	•		GWB6891	
	2010.01-	Saloon Engine G6DC		o	GHA400258	
CARENS I (FC)						
1.8 i (81 kW)	2000.11-2002.07	MPV Engine T8	•		GWB1948	
	2000.11-2002.07	MPV Engine T8 With ABS		o	GHA233007	K
	2000.11-2002.07	MPV Engine T8 Without ABS		o	GHA233016	
CARENS II (FJ)						
1.6 (77 kW)	2002.07-	MPV Engine GA6D	•		GWB1948	
	2002.07-	MPV Engine GA6D With ABS		o	GHA233007	K
	2002.07-	MPV Engine GA6D Without ABS		o	GHA233016	
1.8 (93 kW)	2002.07-	MPV	•		GWB1948	
	2002.07-	MPV With ABS		o	GHA233007	K
	2002.07-	MPV Without ABS		o	GHA233016	
2.0 CRDi (103 kW)	2006.09-	MPV Engine D4EA	•		GWB1948	
	2006.09-	MPV Engine D4EA		o	GHA400340	
	2006.09-	MPV Engine D4EA With ABS		o	GHA233007	K
2.0 CRDi (83 kW)	2002.07-	MPV Engine D4EA	•		GWB1948	
	2002.07-	MPV Engine D4EA With ABS		o	GHA233007	K
	2002.07-	MPV Engine D4EA Without ABS		o	GHA233016	
2.0 CVVT (102 kW)	2005.04-2006.09	MPV Engine G4GC	•		GWB1948	
	2005.04-2006.09	MPV Engine G4GC With ABS		o	GHA233007	K
	2005.04-2006.09	MPV Engine G4GC Without ABS		o	GHA233016	
CARENS III (UN)						
1.6 CRDi (85 kW)	2010.10-	MPV Engine D4FB	•		GHA427021	
	2010.10-	MPV Engine D4FB	•		GWB6891	
	2010.10-	MPV Engine D4FB		o	GHA400258	



	 YEAR		F	R	G-AP Ref.	KIT
KIA						
CARENS III (UN)						
1.6 CRDi (94 kW)	2010.10-	MPV Engine D4FB	•		GHA427021	
	2010.10-	MPV Engine D4FB	•		GWB6891	
	2010.10-	MPV Engine D4FB		○	GHA400258	
1.6 CVVT (93 kW)	2010.10-	MPV Engine G4FC	•		GHA427021	
	2010.10-	MPV Engine G4FC	•		GWB6891	
	2010.10-	MPV Engine G4FC		○	GHA400258	
1.6 CVVT (97 kW)	2009.08-	MPV Engine G4FC	•		GHA427021	
	2009.08-	MPV Engine G4FC	•		GWB6891	
	2009.08-	MPV Engine G4FC		○	GHA400258	
2.0 CRDi (100 kW)	2009.08-	MPV Engine D4EA	•		GHA427021	
	2009.08-	MPV Engine D4EA	•		GWB6891	
	2009.08-	MPV Engine D4EA		○	GHA400258	
	2009.08-	MPV Engine D4EA		○	GHA400340	
2.0 CRDi (103 kW)	2006.09-	MPV Engine D4EA	•		GHA427021	
	2006.09-	MPV Engine D4EA	•		GWB6891	
	2006.09-	MPV Engine D4EA		○	GHA400258	
	2006.09-	MPV Engine D4EA		○	GHA400340	
2.0 CRDi (85 kW)	2007.05-	MPV Engine D4EA	•		GHA427021	
	2007.05-	MPV Engine D4EA	•		GWB6891	
	2007.05-	MPV Engine D4EA		○	GHA400258	
	2007.05-	MPV Engine D4EA		○	GHA400340	
2.0 CVVT (106 kW)	2006.09-	MPV Engine G4KA	•		GHA427021	
	2006.09-	MPV Engine G4KA	•		GWB6891	
	2006.09-	MPV Engine G4KA		○	GHA400258	
	2006.09-	MPV Engine G4KA		○	GHA400340	
CARENS IV						
1.6 GDi (99 kW)	2013.03-	MPV Engine G4FD	•		GHA427021	
	2013.03-	MPV Engine G4FD	•		GWB6891	
1.7 CRDi (100 kW)	2013.03-	MPV Engine D4FD-L	•		GHA427021	
	2013.03-	MPV Engine D4FD-L	•		GWB6891	
1.7 CRDi (85 kW)	2013.03-	MPV Engine D4FD-L	•		GHA427021	
	2013.03-	MPV Engine D4FD-L	•		GWB6891	
2.0 GDi (122 kW)	2013.03-	MPV Engine G4NC	•		GHA427021	
	2013.03-	MPV Engine G4NC	•		GWB6891	
2.0 GDi (130 kW)	2013.03-	MPV Engine G4NC	•		GHA427021	
	2013.03-	MPV Engine G4NC	•		GWB6891	
CARNIVAL / GRAND CARNIVAL III (VQ)						
2.9 CRDi LX (141 kW)	2006.09-	MPV Engine J3	•		GHA331007	A
	2006.09-	MPV Engine J3		○	GHA245013	
CARNIVAL I (UP)						
2.5 V6 (121 kW)	1999.08-2001.10	MPV Engine KRV6	•		GHA428011	K
	1999.08-2001.10	MPV Engine KRV6		○	GWB3936	
2.9 TD (93 kW)	1999.08-2001.10	MPV Engine J3	•		GHA428011	K
	1999.08-2001.10	MPV Engine J3		○	GWB3936	
CEE'D						
1.4 CRDi (66 kW)	2012.09-	Estate Engine D4FC With ABS		○	GHA400131	
1.4 CVVT (73 kW)	2012.09-	Estate Engine G4FA With ABS		○	GHA400131	
1.6 CRDi (94 kW)	2012.09-	Estate Engine D4FB With ABS		○	GHA400131	
1.6 GDi (99 kW)	2012.09-	Estate Engine G4FD With ABS		○	GHA400131	
CEE'D SPORTSWAGON (JD)						
1.6 CRDi 110 (81 kW)	2013.03-	Estate Engine D4FB With ABS		○	GHA400131	
CEE'D						
1.4 CRDi (66 kW)	2012.05-	Hatchback Engine D4FC With ABS		○	GHA400131	
1.4 CVVT (66 kW)	2012.05-	Hatchback Engine G4FA-L	•		GHA427010	
	2012.05-	Hatchback Engine G4FA-L With ABS		○	GHA400131	
1.4 CVVT (73 kW)	2012.05-	Hatchback Engine G4FA	•		GHA427010	
	2012.05-	Hatchback Engine G4FA With ABS		○	GHA400131	
1.6 CRDi (66 kW)	2012.05-	Hatchback Engine D4FB-L	•		GHA427010	
	2012.05-	Hatchback Engine D4FB-L With ABS		○	GHA400131	
1.6 CRDi (81 kW)	2012.05-	Hatchback Engine D4FB	•		GHA427010	
	2012.05-	Hatchback Engine D4FB With ABS		○	GHA400131	
1.6 CRDi (85 kW)	2012.05-	Hatchback Engine D4FB	•		GHA427010	
	2012.05-	Hatchback Engine D4FB With ABS		○	GHA400131	
1.6 CRDi (94 kW)	2012.05-	Hatchback Engine D4FB	•		GHA427010	



	 YEAR		F	R	G-AP Ref.	KIT
KIA						
CEE'D						
1.6 CRDi (94 kW)	2012.05-	Hatchback Engine D4FB With ABS		o	GHA400131	
1.6 CVVT (92 kW)	2012.05-	Hatchback Engine G4FC	•		GHA427010	
	2012.05-	Hatchback Engine G4FC With ABS		o	GHA400131	
1.6 GDi (99 kW)	2012.05-	Hatchback Engine G4FD	•		GHA427010	
	2012.05-	Hatchback Engine G4FD With ABS		o	GHA400131	
CEE'D (ED)						
1.4 (77 kW)	2006.12-	Hatchback Engine G4FA	•		GHA427010	
	2006.12-	Hatchback Engine G4FA	•		GWB6923	
	2006.12-	Hatchback Engine G4FA With ABS		o	GHA400131	
	2010.10-	Estate Engine G4FA	•		GHA427010	
	2010.10-	Estate Engine G4FA	•		GWB6923	
	2010.10-	Estate Engine G4FA With ABS		o	GHA400131	
1.4 (80 kW)	2007.01-	Hatchback Engine G4FA	•		GHA427010	
	2007.01-	Hatchback Engine G4FA	•		GWB6923	
	2007.01-	Hatchback Engine G4FA With ABS		o	GHA400131	
	2007.09-	Estate Engine G4FA	•		GHA427010	
	2007.09-	Estate Engine G4FA	•		GWB6923	
	2007.09-	Estate Engine G4FA With ABS		o	GHA400131	
1.4 CVVT (66 kW)	2010.06-	Hatchback Engine G4FA-L	•		GHA427010	
	2010.06-	Hatchback Engine G4FA-L	•		GWB6923	
	2010.06-	Hatchback Engine G4FA-L With ABS		o	GHA400131	
	2010.10-	Estate Engine G4FA-L	•		GHA427010	
	2010.10-	Estate Engine G4FA-L	•		GWB6923	
	2010.10-	Estate Engine G4FA-L With ABS		o	GHA400131	
1.6 (85 kW)	2007.09-	Estate Engine G4FC	•		GHA427010	
	2007.09-	Estate Engine G4FC	•		GWB6923	
	2007.09-	Estate Engine G4FC With ABS		o	GHA400131	
	2007.09-	Hatchback Engine G4FC	•		GHA427010	
	2007.09-	Hatchback Engine G4FC	•		GWB6923	
	2007.09-	Hatchback Engine G4FC With ABS		o	GHA400131	
1.6 (90 kW)	2007.01-	Hatchback Engine G4FC	•		GHA427010	
	2007.01-	Hatchback Engine G4FC	•		GWB6923	
	2007.01-	Hatchback Engine G4FC With ABS		o	GHA400131	
	2007.09-	Estate Engine G4FC	•		GHA427010	
	2007.09-	Estate Engine G4FC	•		GWB6923	
	2007.09-	Estate Engine G4FC With ABS		o	GHA400131	
1.6 (93 kW)	2007.09-	Estate Engine G4FC	•		GHA427010	
	2007.09-	Estate Engine G4FC	•		GWB6923	
	2007.09-	Estate Engine G4FC With ABS		o	GHA400131	
	2008.02-	Hatchback Engine G4FC	•		GHA427010	
	2008.02-	Hatchback Engine G4FC	•		GWB6923	
	2008.02-	Hatchback Engine G4FC With ABS		o	GHA400131	
1.6 CRDi (66 kW)	2007.01-	Hatchback Engine D4FB-L	•		GHA427010	
	2007.01-	Hatchback Engine D4FB-L	•		GWB6923	
	2007.01-	Hatchback Engine D4FB-L With ABS		o	GHA400131	
	2007.09-	Estate Engine D4FB-L	•		GHA427010	
	2007.09-	Estate Engine D4FB-L	•		GWB6923	
	2007.09-	Estate Engine D4FB-L With ABS		o	GHA400131	
1.6 CRDi (85 kW)	2007.01-	Hatchback Engine D4FB	•		GHA427010	
	2007.01-	Hatchback Engine D4FB	•		GWB6923	
	2007.01-	Hatchback Engine D4FB With ABS		o	GHA400131	
	2007.09-	Estate Engine D4FB	•		GHA427010	
	2007.09-	Estate Engine D4FB	•		GWB6923	
	2007.09-	Estate Engine D4FB With ABS		o	GHA400131	
1.6 CRDi (94 kW)	2010.10-	Estate Engine D4FB	•		GHA427010	
	2010.10-	Estate Engine D4FB	•		GWB6923	
	2010.10-	Estate Engine D4FB With ABS		o	GHA400131	
	2010.10-	Hatchback Engine D4FB	•		GHA427010	
	2010.10-	Hatchback Engine D4FB	•		GWB6923	
	2010.10-	Hatchback Engine D4FB With ABS		o	GHA400131	
1.6 CVVT (92 kW)	2009.06-	Estate Engine G4FC	•		GHA427010	
	2009.06-	Estate Engine G4FC	•		GWB6923	
	2009.06-	Estate Engine G4FC With ABS		o	GHA400131	
	2010.10-	Hatchback Engine G4FC	•		GHA427010	



	 YEAR		F	R	G-AP Ref.	KIT
KIA						
CEE'D (ED)						
1.6 CVVT (92 kW)	2010.10-	Hatchback Engine G4FC	•		GWB6923	
	2010.10-	Hatchback Engine G4FC With ABS		◦	GHA400131	
2.0 (105 kW)	2006.12-	Hatchback Engine G4GC	•		GHA427010	
	2006.12-	Hatchback Engine G4GC	•		GWB6923	
	2006.12-	Hatchback Engine G4GC With ABS		◦	GHA400131	
	2007.09-	Estate Engine G4GC	•		GHA427010	
	2007.09-	Estate Engine G4GC	•		GWB6923	
	2007.09-	Estate Engine G4GC With ABS		◦	GHA400131	
2.0 CRDi (100 kW)	2007.06-	Hatchback Engine D4EA	•		GHA427010	
	2007.06-	Hatchback Engine D4EA	•		GWB6923	
	2007.06-	Hatchback Engine D4EA With ABS		◦	GHA400131	
2.0 CRDi (103 kW)	2008.04-	Estate Engine D4EA-F	•		GHA427010	
	2008.04-	Estate Engine D4EA-F	•		GWB6923	
	2008.04-	Estate Engine D4EA-F With ABS		◦	GHA400131	
	2008.04-	Hatchback Engine D4EA-F	•		GHA427010	
	2008.04-	Hatchback Engine D4EA-F	•		GWB6923	
	2008.04-	Hatchback Engine D4EA-F With ABS		◦	GHA400131	
CEE'D (JD)						
1.6 GT (150 kW)	2013.06-	Hatchback Engine G4FJ With ABS		◦	GHA400131	
CERATO (LD)						
1.5 CRDi (75 kW)	2005.04-2007.05	Hatchback Engine D4FA	•		GHA425047	
	2005.04-2007.05	Hatchback Engine D4FA	•		GWB3909	
	2005.04-2007.05	Hatchback Engine D4FA With ABS		◦	GHA232002	K
	2005.04-2007.05	Hatchback Engine D4FA With ABS		◦	GHA232002	K
	2005.04-2007.05	Saloon Engine D4FA	•		GHA425047	
	2005.04-2007.05	Saloon Engine D4FA	•		GWB3909	
	2005.04-2007.05	Saloon Engine D4FA With ABS		◦	GHA232002	K
	2005.04-2007.05	Saloon Engine D4FA With ABS		◦	GHA232002	K
1.6 (77 kW)	2004.08-2007.05	Hatchback Engine G4ED	•		GHA425027	
	2004.08-2007.05	Hatchback Engine G4ED	•		GHA427010	
	2004.08-2007.05	Hatchback Engine G4ED	•		GWB6812	
	2004.08-2007.05	Hatchback Engine G4ED With ABS		◦	GHA232002	K
	2004.08-2007.05	Hatchback Engine G4ED With ABS		◦	GHA232002	K
	2004.08-2007.05	Saloon Engine G4ED	•		GHA425027	
	2004.08-2007.05	Saloon Engine G4ED	•		GHA427010	
	2004.08-2007.05	Saloon Engine G4ED	•		GWB6812	
	2004.08-2007.05	Saloon Engine G4ED With ABS		◦	GHA232002	K
	2004.08-2007.05	Saloon Engine G4ED With ABS		◦	GHA232002	K
1.6 (90 kW)	2006.05-	Saloon Engine G4FC	•		GHA425027	
	2006.05-	Saloon Engine G4FC	•		GHA427010	
	2006.05-	Saloon Engine G4FC	•		GWB6812	
	2006.05-	Saloon Engine G4FC With ABS		◦	GHA232002	K
	2006.05-	Saloon Engine G4FC With ABS		◦	GHA232002	K
1.6 CRDi (85 kW)	2005.06-	Hatchback Engine D4FB	•		GHA425047	
	2005.06-	Hatchback Engine D4FB	•		GWB3909	
	2005.06-	Hatchback Engine D4FB With ABS		◦	GHA232002	K
	2005.06-	Hatchback Engine D4FB With ABS		◦	GHA232002	K
	2005.06-	Saloon Engine D4FB	•		GHA425047	
	2005.06-	Saloon Engine D4FB	•		GWB3909	
	2005.06-	Saloon Engine D4FB With ABS		◦	GHA232002	K
	2005.06-	Saloon Engine D4FB With ABS		◦	GHA232002	K
2.0 (105 kW)	2005.01-2005.11	Hatchback Engine G4GC	•		GHA425027	
	2005.01-2005.11	Hatchback Engine G4GC	•		GHA427010	
	2005.01-2005.11	Hatchback Engine G4GC	•		GWB6812	
	2005.01-2005.11	Hatchback Engine G4GC With ABS		◦	GHA232002	K
	2005.01-2005.11	Hatchback Engine G4GC With ABS		◦	GHA232002	K
	2005.12-2007.05	Saloon Engine G4GC	•		GHA425027	
	2005.12-2007.05	Saloon Engine G4GC	•		GHA427010	
	2005.12-2007.05	Saloon Engine G4GC	•		GWB6812	
	2005.12-2007.05	Saloon Engine G4GC With ABS		◦	GHA232002	K
	2005.12-2007.05	Saloon Engine G4GC With ABS		◦	GHA232002	K
2.0 CRDi (83 kW)	2004.04-	Hatchback Engine D4EA	•		GHA425047	
	2004.04-	Hatchback Engine D4EA	•		GWB3909	
	2004.04-	Hatchback Engine D4EA With ABS		◦	GHA232002	K



	 YEAR		F	R	G-AP Ref.	KIT
KIA						
CERATO (LD)						
2.0 CRDi (83 kW)	2004.04-	Hatchback Engine D4EA With ABS		o	GHA232002	K
	2004.04-	Saloon Engine D4EA	•		GHA425047	
	2004.04-	Saloon Engine D4EA	•		GWB3909	
	2004.04-	Saloon Engine D4EA With ABS		o	GHA232002	K
	2004.04-	Saloon Engine D4EA With ABS		o	GHA232002	K
CERATO II (TD)						
1.6 (93 kW)	2010.01-	Saloon Engine G4FC	•		GHA427010	
	2010.01-	Saloon Engine G4FC	•		GWB6923	
	2010.01-	Saloon Engine G4FC		o	GHA400208	
CLARUS (GC)						
1.8 i 16V (85 kW)	1998.05-	Estate Engine T8	•		GWB1948	
	1998.05-	Estate Engine T8 With ABS		o	GHA233007	K
	1998.05-	Estate Engine T8 Without ABS		o	GHA233016	
2.0 i 16V (98 kW)	1998.05-	Estate Engine FE	•		GWB1948	
	1998.05-	Estate Engine FE With ABS		o	GHA233007	K
	1998.05-	Estate Engine FE Without ABS		o	GHA233016	
CLARUS (K9A)						
1.8 i 16V (85 kW)	1996.07-	Saloon Engine T8	•		GWB1948	
	1996.07-	Saloon Engine T8 With ABS		o	GHA233007	K
	1996.07-	Saloon Engine T8 Without ABS		o	GHA233016	
2.0 i 16V (98 kW)	1996.07-	Saloon Engine FE	•		GWB1948	
	1996.07-	Saloon Engine FE With ABS		o	GHA233007	K
	1996.07-	Saloon Engine FE Without ABS		o	GHA233016	
JOICE						
2.0 (102 kW)	2000.02-	MPV Engine G4CP With ABS		o	GHA233012	
	2000.02-	MPV Engine G4CP Without ABS		o	GHA233011	
2.0 (88 kW)	2001.09-	MPV Engine G4CP With ABS		o	GHA233012	
	2001.09-	MPV Engine G4CP Without ABS		o	GHA233011	
K3						
1.6 MPI (96 kW)	2013.06-	Saloon Engine G4FC	•		GWB6923	
2.0 MPI (110 kW)	2013.06-	Saloon Engine G4KD	•		GWB6923	
K3 (TD)						
1.6 CVVT (91 kW)	2009.10-	Coupe Engine G4FC	•		GHA427010	
	2009.10-	Coupe Engine G4FC	•		GWB6923	
	2009.10-	Coupe Engine G4FC		o	GHA400208	
2.0 (115 kW)	2009.01-	Coupe Engine G4KD	•		GHA427010	
	2009.01-	Coupe Engine G4KD	•		GWB6923	
	2009.01-	Coupe Engine G4KD		o	GHA400208	
K3 II (TD)						
1.6 (90 kW)	2010.01-	Saloon Engine G4FC	•		GHA427010	
	2010.01-	Saloon Engine G4FC	•		GWB6923	
	2010.01-	Saloon Engine G4FC		o	GHA400208	
1.6 CVVT (91 kW)	2009.02-	Saloon Engine G4FC	•		GHA427010	
	2009.02-	Saloon Engine G4FC	•		GWB6923	
	2009.02-	Saloon Engine G4FC		o	GHA400208	
2.0 (115 kW)	2009.01-	Saloon Engine G4KD	•		GHA427010	
	2009.01-	Saloon Engine G4KD	•		GWB6923	
	2009.01-	Saloon Engine G4KD		o	GHA400208	
2.0 (116 kW)	2010.07-	Saloon Engine G4KD	•		GHA427010	
	2010.07-	Saloon Engine G4KD	•		GWB6923	
	2010.07-	Saloon Engine G4KD		o	GHA400208	
K5						
2.0 (204 kW)	2010.09-	Saloon	•		GHA427021	
	2010.09-	Saloon	•		GWB6891	
	2010.09-	Saloon		o	GHA400258	
2.0 CVVL (121 kW)	2012.03-	Saloon Engine G4KD	•		GHA427021	
	2012.03-	Saloon Engine G4KD	•		GWB6891	
	2012.03-	Saloon Engine G4KD		o	GHA400258	
2.0 CVVT Hybrid (140 kW)	2012.12-	Saloon	•		GHA427021	
	2012.12-	Saloon	•		GWB6891	
	2012.12-	Saloon		o	GHA400258	
2.0 Hybrid (110 kW)	2012.03-	Saloon Engine G4NE	•		GHA427021	
	2012.03-	Saloon Engine G4NE	•		GWB6891	



	 YEAR		F	R	G-AP Ref.	KIT
KIA						
K5						
2.0 HybriD (110 kW)	2012.03-	Saloon Engine G4NE		o	GHA400258	
2.4 (132 kW)	2012.03-	Saloon Engine G4KJ	•		GHA427021	
	2012.03-	Saloon Engine G4KJ	•		GWB6891	
2.4 (149 kW)	2012.03-	Saloon Engine G4KJ		o	GHA400258	
	2010.09-	Saloon Engine G4KJ	•		GHA427021	
	2010.09-	Saloon Engine G4KJ	•		GWB6891	
	2010.09-	Saloon Engine G4KJ		o	GHA400258	
MAGENTIS (GD)						
2.0 (100 kW)	2001.05-	Saloon Engine G4JP	•		GHA427006	
	2001.05-	Saloon Engine G4JP	•		GHA427021	
	2001.05-	Saloon Engine G4JP	•		GHA427022	
	2001.05-	Saloon Engine G4JP	•		GWB3909	
	2001.05-	Saloon Engine G4JP	•		GWB6891	
	2001.05-	Saloon Engine G4JP With ABS		o	GHA400004	
	2001.05-	Saloon Engine G4JP Without ABS		o	GHA400037	
2.5 V6 (124 kW)	2001.05-	Saloon Engine G6BV	•		GHA427006	
	2001.05-	Saloon Engine G6BV	•		GHA427022	
	2001.05-	Saloon Engine G6BV	•		GWB3909	
	2001.05-	Saloon Engine G6BV	•		GWB6891	
	2001.05-	Saloon Engine G6BV With ABS		o	GHA400004	
	2001.05-	Saloon Engine G6BV Without ABS		o	GHA400037	
2.7 V6 (132 kW)	2004.04-	Saloon Engine G6BA	•		GHA427021	
MAGENTIS (MG)						
2.0 (106 kW)	2006.06-	Saloon Engine G4KA	•		GHA427021	
	2006.06-	Saloon Engine G4KA	•		GWB6891	
	2006.06-	Saloon Engine G4KA		o	GHA400108	
	2006.06-	Saloon Engine G4KA		o	GHA400157	
	2006.06-	Saloon Engine G4KA		o	GHA400265	
2.0 (121 kW)	2009.07-	Saloon Engine G4KD	•		GHA427021	
	2009.07-	Saloon Engine G4KD	•		GWB6891	
	2009.07-	Saloon Engine G4KD		o	GHA400108	
2.0 CRDi (100 kW)	2005.11-2008.12	Saloon Engine D4EA	•		GHA427021	
	2005.11-2008.12	Saloon Engine D4EA	•		GWB6891	
	2005.11-2008.12	Saloon Engine D4EA		o	GHA400108	
2.0 CRDi (103 kW)	2006.06-	Saloon Engine D4EA	•		GHA427021	
	2006.06-	Saloon Engine D4EA	•		GWB6891	
	2006.06-	Saloon Engine D4EA		o	GHA400108	
	2006.06-	Saloon Engine D4EA		o	GHA400157	
	2006.06-	Saloon Engine D4EA		o	GHA400265	
2.0 CRDi (110 kW)	2006.04-	Saloon Engine D4EA	•		GHA427021	
	2006.04-	Saloon Engine D4EA	•		GWB6891	
	2006.04-	Saloon Engine D4EA		o	GHA400108	
2.7 (138 kW)	2006.06-	Saloon Engine G6EA	•		GHA427021	
	2006.06-	Saloon Engine G6EA	•		GWB6891	
	2006.06-	Saloon Engine G6EA		o	GHA400108	
	2006.06-	Saloon Engine G6EA		o	GHA400157	
	2006.06-	Saloon Engine G6EA		o	GHA400265	
2.7 V6 (142 kW)	2009.07-	Saloon Engine G6EA	•		GHA427021	
	2009.07-	Saloon Engine G6EA	•		GWB6891	
	2009.07-	Saloon Engine G6EA		o	GHA400108	
MENTOR (FA)						
1.5 i (59 kW)	1996.02-1997.10	Hatchback Engine B5	•		GWB1950	
	1996.02-1997.10	Hatchback Engine B5 With ABS		o	GHA230066	K
	1996.02-1997.10	Hatchback Engine B5 Without ABS		o	GHA230035	K
	1996.02-1997.10	Hatchback Engine B5 Without ABS		o	GHA230035	K
	1996.02-1997.10	Saloon Engine B5	•		GWB1950	
	1996.02-1997.10	Saloon Engine B5 With ABS		o	GHA230066	K
	1996.02-1997.10	Saloon Engine B5 Without ABS		o	GHA230035	K
	1996.02-1997.10	Saloon Engine B5 Without ABS		o	GHA230035	K
1.6 i (59 kW)	1993.09-1997.10	Saloon Engine B6	•		GWB1950	
	1993.09-1997.10	Saloon Engine B6 With ABS		o	GHA230066	K
	1993.09-1997.10	Saloon Engine B6 Without ABS		o	GHA230035	K
	1993.09-1997.10	Saloon Engine B6 Without ABS		o	GHA230035	K
	1995.01-1997.10	Hatchback Engine B6	•		GWB1950	



	 YEAR		F	R	G-AP Ref.	KIT
KIA						
MENTOR (FA)						
1.6 i (59 kW)	1995.01-1997.10	Hatchback Engine B6 With ABS		o	GHA230066	K
	1995.01-1997.10	Hatchback Engine B6 Without ABS		o	GHA230035	K
	1995.01-1997.10	Hatchback Engine B6 Without ABS		o	GHA230035	K
1.8 i 16V (82 kW)	1995.01-1997.10	Hatchback Engine OK24N/OK26Y	•		GWB1950	
	1995.01-1997.10	Hatchback Engine OK24N/OK26Y With ABS		o	GHA230066	K
	1995.01-1997.10	Hatchback Engine OK24N/OK26Y Without ABS		o	GHA230035	K
	1995.01-1997.10	Hatchback Engine OK24N/OK26Y Without ABS		o	GHA230035	K
	1995.01-1997.10	Saloon Engine OK24N/OK26Y	•		GWB1950	
	1995.01-1997.10	Saloon Engine OK24N/OK26Y With ABS		o	GHA230066	K
	1995.01-1997.10	Saloon Engine OK24N/OK26Y Without ABS		o	GHA230035	K
	1995.01-1997.10	Saloon Engine OK24N/OK26Y Without ABS		o	GHA230035	K
OPIRUS (GH)						
3.5 (149 kW)	2003.09-	Saloon Engine G6CU	•		GWB6938	
	2003.09-	Saloon Engine G6CU		o	GHA400230	
3.8 V6 (196 kW)	2006.10-	Saloon Engine G6DA	•		GWB6938	
OPTIMA						
-	2006-2008		•	o	GHA427020	
1.7 CRDi (100 kW)	2012.03-	Saloon Engine D4FD-L	•		GHA427021	
	2012.03-	Saloon Engine D4FD-L	•		GWB6891	
	2012.03-	Saloon Engine D4FD-L		o	GHA400258	
2.0 (125 kW)	2012.03-	Saloon Engine G4KD	•		GHA427021	
	2012.03-	Saloon Engine G4KD	•		GWB6891	
	2012.03-	Saloon Engine G4KD		o	GHA400258	
PICANTO (BA)						
1.0 (45 kW)	2004.05-2008.02	Hatchback Engine G4HE	•		GWB6931	
	2004.05-2008.02	Hatchback Engine G4HE		o	GHA400158	K
	2004.05-2008.02	Hatchback Engine G4HE With ABS		o	GHA400130	K
	2004.05-2008.02	Hatchback Engine G4HE Without ABS		o	GHA400100	
1.0 (46 kW)	2009.11-	Hatchback Engine G4HE	•		GWB6931	
	2009.11-	Hatchback Engine G4HE		o	GHA400158	K
	2009.11-	Hatchback Engine G4HE With ABS		o	GHA400130	K
1.1 (48 kW)	2004.05-2008.02	Hatchback Engine G4HG	•		GWB6931	
	2004.05-2008.02	Hatchback Engine G4HG		o	GHA400158	K
	2004.05-2008.02	Hatchback Engine G4HG With ABS		o	GHA400130	K
	2004.05-2008.02	Hatchback Engine G4HG Without ABS		o	GHA400100	
1.1 CRDi (55 kW)	2005.11-	Hatchback Engine D3FA	•		GWB6931	
	2005.11-	Hatchback Engine D3FA		o	GHA400158	K
	2005.11-	Hatchback Engine D3FA With ABS		o	GHA400130	K
	2005.11-	Hatchback Engine D3FA Without ABS		o	GHA400100	
PICANTO (TA)						
1.0 (49 kW)	2015.04-	Hatchback Engine G3LA		o	GHA400232	
	2015.04-	Hatchback Engine G3LA		o	GHA400274	
1.0 (51 kW)	2011.05-	Hatchback Engine G3LA		o	GHA400232	
	2011.05-	Hatchback Engine G3LA		o	GHA400274	
1.0 BiFuel (60 kW)	2011.05-	Hatchback Engine B3LA		o	GHA400232	
	2011.05-	Hatchback Engine B3LA		o	GHA400274	
1.0 LPG (49 kW)	2013.08-	Hatchback Engine B3LA		o	GHA400232	
	2013.08-	Hatchback Engine B3LA		o	GHA400274	
1.2 (63 kW)	2011.09-	Hatchback Engine G4LA		o	GHA400232	
	2011.09-	Hatchback Engine G4LA		o	GHA400274	
PRIDE						
1.3 (47 kW)	1999.08-	Estate	•		GWB1928	
PRIDE (DA)						
1.3 16V (44 kW)	1990.01-	Hatchback Engine B3	•		GWB1928	
1.3 16V (47 kW)	1996.10-	Hatchback Engine B3	•		GWB1928	
1.3 16V (53 kW)	1990.01-	Hatchback Engine B3	•		GWB1928	
1.3 i (51 kW)	1990.01-	Hatchback	•		GWB1928	
PRO CEE'D (JD)						
1.6 CRDi 110 (81 kW)	2013.03-	Hatchback Engine D4FB With ABS		o	GHA400131	
1.6 GT (150 kW)	2013.06-	Hatchback Engine G4FJ With ABS		o	GHA400131	
PRO CEED						
1.4 CRDi (66 kW)	2013.03-	Hatchback Engine D4FC With ABS		o	GHA400131	
1.4 CVVT (73 kW)	2013.03-	Hatchback With ABS		o	GHA400131	



	 YEAR		F	R	G-AP Ref.	KIT
KIA						
PRO CEED						
1.6 CRDi (94 kW)	2013.03-	Hatchback Engine D4FB With ABS		o	GHA400131	
1.6 GDi (99 kW)	2013.03-	Hatchback Engine G4FD With ABS		o	GHA400131	
PRO CEED (ED)						
1.4 (77 kW)	2008.02-	Hatchback Engine G4FA	•		GHA427010	
	2008.02-	Hatchback Engine G4FA	•		GWB6923	
	2008.02-	Hatchback Engine G4FA With ABS		o	GHA400131	
1.4 (80 kW)	2008.02-	Hatchback Engine G4FA	•		GHA427010	
	2008.02-	Hatchback Engine G4FA	•		GWB6923	
	2008.02-	Hatchback Engine G4FA With ABS		o	GHA400131	
1.4 CVVT (66 kW)	2010.06-	Hatchback Engine G4FA-L	•		GHA427010	
	2010.06-	Hatchback Engine G4FA-L	•		GWB6923	
	2010.06-	Hatchback Engine G4FA-L With ABS		o	GHA400131	
1.6 (90 kW)	2008.02-	Hatchback Engine G4FC	•		GHA427010	
	2008.02-	Hatchback Engine G4FC	•		GWB6923	
	2008.02-	Hatchback Engine G4FC With ABS		o	GHA400131	
1.6 (93 kW)	2008.02-	Hatchback Engine G4FC	•		GHA427010	
	2008.02-	Hatchback Engine G4FC	•		GWB6923	
	2008.02-	Hatchback Engine G4FC With ABS		o	GHA400131	
1.6 CRDi (66 kW)	2008.02-	Hatchback Engine D4FB-L	•		GHA427010	
	2008.02-	Hatchback Engine D4FB-L	•		GWB6923	
	2008.02-	Hatchback Engine D4FB-L With ABS		o	GHA400131	
1.6 CRDi (85 kW)	2008.02-	Hatchback Engine D4FB	•		GHA427010	
	2008.02-	Hatchback Engine D4FB	•		GWB6923	
	2008.02-	Hatchback Engine D4FB With ABS		o	GHA400131	
1.6 CRDi (94 kW)	2010.10-	Hatchback Engine D4FB	•		GHA427010	
	2010.10-	Hatchback Engine D4FB	•		GWB6923	
	2010.10-	Hatchback Engine D4FB With ABS		o	GHA400131	
1.6 CVVT (92 kW)	2010.10-	Hatchback Engine G4FC	•		GHA427010	
	2010.10-	Hatchback Engine G4FC	•		GWB6923	
	2010.10-	Hatchback Engine G4FC With ABS		o	GHA400131	
2.0 (105 kW)	2008.02-	Hatchback Engine G4GC	•		GHA427010	
	2008.02-	Hatchback Engine G4GC	•		GWB6923	
	2008.02-	Hatchback Engine G4GC With ABS		o	GHA400131	
2.0 CRDi (103 kW)	2008.02-	Hatchback Engine D4EA-F	•		GHA427010	
	2008.02-	Hatchback Engine D4EA-F	•		GWB6923	
	2008.02-	Hatchback Engine D4EA-F With ABS		o	GHA400131	
RIO (DC)						
1.3 (55 kW)	2000.08-2005.02	Estate Engine A3E	•		GHA424015	
	2000.08-2005.02	Estate Engine A3E	•		GWB1928	
	2000.08-2005.02	Estate Engine A3E		o	GWB0904	
1.3 (60 kW)	2000.08-2005.02	Estate Engine A3E	•		GHA424015	
	2000.08-2005.02	Estate Engine A3E	•		GWB1928	
	2000.08-2005.02	Estate Engine A3E		o	GWB0904	
1.5 16V (71 kW)	2002.09-2005.02	Estate Engine A5D	•		GHA424015	
	2002.09-2005.02	Estate Engine A5D	•		GWB1928	
	2002.09-2005.02	Estate Engine A5D		o	GWB0904	
1.5 16V (72 kW)	2000.08-2005.02	Estate Engine A5D	•		GHA424015	
	2000.08-2005.02	Estate Engine A5D	•		GWB1928	
	2000.08-2005.02	Estate Engine A5D		o	GWB0904	
RIO (DC_)						
1.3 (55 kW)	2000.09-2005.02	Saloon	•		GHA424015	
	2000.09-2005.02	Saloon	•		GWB1928	
	2000.09-2005.02	Saloon		o	GWB0904	
1.3 (60 kW)	2002.08-2005.02	Saloon Engine A3E	•		GHA424015	
	2002.08-2005.02	Saloon Engine A3E	•		GWB1928	
	2002.08-2005.02	Saloon Engine A3E		o	GWB0904	
1.5 (70 kW)	2002.09-2005.02	Saloon Engine A5D	•		GHA424015	
1.5 16V (71 kW)	2002.09-2005.02	Saloon Engine A5D	•		GHA424015	
	2002.09-2005.02	Saloon Engine A5D	•		GWB1928	
	2002.09-2005.02	Saloon Engine A5D		o	GWB0904	
1.5 16V (72 kW)	2000.09-2005.02	Saloon Engine A5D	•		GHA424015	
	2000.09-2005.02	Saloon Engine A5D	•		GWB1928	
	2000.09-2005.02	Saloon Engine A5D		o	GWB0904	



	 YEAR		F	R	G-AP Ref.	KIT
KIA						
RIO II (JB)						
1.4 16V (71 kW)	2005.03-	Saloon Engine G4EE	•		GHA425002	
	2005.03-	Saloon Engine G4EE	•		GHA425036	
	2005.03-	Saloon Engine G4EE	•		GWB3907	
	2005.03-	Saloon Engine G4EE		○	GHA400158	K
	2005.03-	Saloon Engine G4EE With ABS		○	GHA400130	K
	2005.03-	Saloon Engine G4EE Without ABS		○	GHA400100	
	2005.09-2007.01	Hatchback Engine G4EE	•		GHA425002	
	2005.09-2007.01	Hatchback Engine G4EE	•		GHA425036	
	2005.09-2007.01	Hatchback Engine G4EE	•		GWB3907	
	2005.09-2007.01	Hatchback Engine G4EE		○	GHA400158	K
	2005.09-2007.01	Hatchback Engine G4EE With ABS		○	GHA400130	K
	2005.09-2007.01	Hatchback Engine G4EE Without ABS		○	GHA400100	
1.5 CRDi (65 kW)	2008.06-	Hatchback Engine D4FA	•		GHA425002	
	2008.06-	Hatchback Engine D4FA	•		GWB3907	
	2008.06-	Hatchback Engine D4FA		○	GHA400158	K
	2008.06-	Hatchback Engine D4FA With ABS		○	GHA400130	K
	2008.06-	Saloon Engine D4FA	•		GHA425002	
1.5 CRDi (81 kW)	2005.09-2008.02	Hatchback Engine D4FA	•		GHA425002	
	2005.09-2008.02	Hatchback Engine D4FA	•		GWB3907	
	2005.09-2008.02	Hatchback Engine D4FA		○	GHA400158	K
	2005.09-2008.02	Hatchback Engine D4FA With ABS		○	GHA400130	K
	2005.09-2008.02	Hatchback Engine D4FA Without ABS		○	GHA400100	
	2005.09-2008.02	Saloon Engine D4FA	•		GHA425002	
	2005.09-2008.02	Saloon Engine D4FA	•		GWB3907	
	2005.09-2008.02	Saloon Engine D4FA		○	GHA400158	K
	2005.09-2008.02	Saloon Engine D4FA With ABS		○	GHA400130	K
2005.09-2008.02	Saloon Engine D4FA Without ABS		○	GHA400100		
1.6 16V (82 kW)	2005.03-	Saloon Engine G4ED	•		GHA424015	
	2005.03-	Saloon Engine G4ED	•		GHA425002	
	2005.03-	Saloon Engine G4ED	•		GHA425036	
	2005.03-	Saloon Engine G4ED	•		GWB3907	
	2005.03-	Saloon Engine G4ED		○	GHA400158	K
	2005.03-	Saloon Engine G4ED With ABS		○	GHA400130	K
	2005.03-	Saloon Engine G4ED Without ABS		○	GHA400100	
1.6 CVVT (82 kW)	2005.03-	Hatchback Engine G4ED	•		GHA424015	
	2005.03-	Hatchback Engine G4ED	•		GHA425002	
	2005.03-	Hatchback Engine G4ED	•		GHA425036	
	2005.03-	Hatchback Engine G4ED	•		GWB3907	
	2005.03-	Hatchback Engine G4ED		○	GHA400158	K
	2005.03-	Hatchback Engine G4ED With ABS		○	GHA400130	K
	2005.03-	Hatchback Engine G4ED Without ABS		○	GHA400100	
RIO III (UB)						
1.1 CRDi (55 kW)	2011.09-	Hatchback Engine D3FA	•		GHA425036	
1.2 CVVT (62 kW)	2014.11-	Hatchback Engine G4LA	•		GHA425036	
	2014.11-	Saloon	•		GHA425036	
1.25 CVVT (63 kW)	2011.09-	Hatchback Engine G4LA	•		GHA425036	
	2011.10-	Saloon Engine G4LA	•		GHA425036	
1.25 CVVT (65 kW)	2011.09-	Hatchback Engine G4LA	•		GHA425036	
1.4 CRDi (66 kW)	2011.09-	Hatchback Engine D4FC	•		GHA425036	
1.4 CVVT (79 kW)	2011.09-	Hatchback Engine G4FA	•		GHA425002	
	2011.09-	Hatchback Engine G4FA	•		GHA425036	
1.4 CVVT (80 kW)	2011.09-	Hatchback Engine G4FA	•		GHA425002	
	2011.09-	Hatchback Engine G4FA	•		GHA425036	
	2011.10-	Saloon Engine G4FA	•		GHA425036	
1.6 CVVT (90 kW)	2012.06-	Hatchback Engine G4FC	•		GHA425036	
	2012.06-	Saloon Engine G4FC	•		GHA425036	
RONDO						
-	2007-2010		•	○	GHA427020	
SEDONA II (GQ)						
2.5 V6 (110 kW)	2001.10-	MPV Engine K5	•		GHA428011	K
	2001.10-	MPV Engine K5		○	GWB3936	
2.9 CRDi (106 kW)	2001.10-	MPV Engine J3	•		GHA428011	K
	2001.10-	MPV Engine J3		○	GWB3936	
2.9 TD (93 kW)	1999.01-	MPV Engine J3		○	GWB3936	



	 YEAR		F	R	G-AP Ref.	KIT
KIA						
SEDONA II (GQ)						
3.5 (143 kW)	2002.07-	MPV Engine G6CU	•		GHA428011	K
SEDONA II (VQ)						
2.2 CRDi (110 kW)	2010.01-	MPV Engine D4HB	•		GHA331007	A
	2010.01-	MPV Engine D4HB		○	GHA245013	
2.2 CRDi (143 kW)	2010.01-	MPV Engine D4HB	•		GHA331007	A
	2010.01-	MPV Engine D4HB		○	GHA245013	
2.7 V6 (139 kW)	2006.06-	MPV Engine G6EA	•		GHA331007	A
	2006.06-	MPV Engine G6EA		○	GHA245013	
2.9 CRDi (136 kW)	2006.06-	MPV Engine J3	•		GHA331007	A
	2006.06-	MPV Engine J3		○	GHA245013	
SHUMA (FB)						
1.5 (59 kW)	1996.03-1998.12	Saloon Engine OK280	•		GWB1950	
	1996.03-1998.12	Saloon Engine OK280 With ABS		○	GHA230066	K
	1996.03-1998.12	Saloon Engine OK280 Without ABS		○	GHA230035	K
	1996.03-1998.12	Saloon Engine OK280 Without ABS		○	GHA230035	K
1.5 i 16V (65 kW)	1997.10-2001.03	Hatchback	•		GWB1950	
	1997.10-2001.03	Hatchback With ABS		○	GHA230066	K
	1997.10-2001.03	Hatchback Without ABS		○	GHA230035	K
	1997.10-2001.03	Hatchback Without ABS		○	GHA230035	K
	1997.10-2001.10	Saloon	•		GWB1950	
	1997.10-2001.10	Saloon With ABS		○	GHA230066	K
	1997.10-2001.10	Saloon Without ABS		○	GHA230035	K
	1997.10-2001.10	Saloon Without ABS		○	GHA230035	K
1.6 (75 kW)	2001.01-2001.12	Hatchback Engine GA6D	•		GHA428016	
	2001.01-2001.12	Hatchback Engine GA6D	•		GWB1948	
	2001.01-2001.12	Hatchback Engine GA6D With ABS		○	GHA230066	K
	2001.01-2001.12	Hatchback Engine GA6D Without ABS		○	GHA230035	K
	2001.01-2001.12	Hatchback Engine GA6D Without ABS		○	GHA230035	K
1.8 i 16V (81 kW)	1997.10-2001.03	Hatchback Engine T8	•		GHA428016	
	1997.10-2001.03	Hatchback Engine T8	•		GWB1948	
	1997.10-2001.03	Hatchback Engine T8	•		GWB1950	
	1997.10-2001.03	Hatchback Engine T8 With ABS		○	GHA230066	K
	1997.10-2001.03	Hatchback Engine T8 Without ABS		○	GHA230035	K
	1997.10-2001.03	Hatchback Engine T8 Without ABS		○	GHA230035	K
SHUMA II (FB)						
1.6 (75 kW)	2001.05-2004.05	Saloon Engine GA6D	•		GHA428016	
	2001.05-2004.05	Saloon Engine GA6D	•		GWB1948	
	2001.05-2004.05	Saloon Engine GA6D With ABS		○	GHA230066	K
	2001.05-2004.05	Saloon Engine GA6D Without ABS		○	GHA230035	K
	2001.05-2004.05	Saloon Engine GA6D Without ABS		○	GHA230035	K
	2001.05-2004.08	Hatchback Engine GA6D	•		GHA428016	
	2001.05-2004.08	Hatchback Engine GA6D	•		GWB1948	
	2001.05-2004.08	Hatchback Engine GA6D With ABS		○	GHA230066	K
	2001.05-2004.08	Hatchback Engine GA6D Without ABS		○	GHA230035	K
	2001.05-2004.08	Hatchback Engine GA6D Without ABS		○	GHA230035	K
1.8 (81 kW)	2001.05-2004.06	Hatchback Engine T8	•		GHA428016	
	2001.05-2004.06	Hatchback Engine T8	•		GWB1948	
	2001.05-2004.06	Hatchback Engine T8 With ABS		○	GHA230066	K
	2001.05-2004.06	Hatchback Engine T8 Without ABS		○	GHA230035	K
	2001.05-2004.06	Hatchback Engine T8 Without ABS		○	GHA230035	K
1.8 (84 kW)	2002.03-2004.05	Hatchback Engine T8	•		GHA428016	
	2002.03-2004.05	Hatchback Engine T8	•		GWB1948	
	2002.03-2004.05	Hatchback Engine T8 With ABS		○	GHA230066	K
	2002.03-2004.05	Hatchback Engine T8 Without ABS		○	GHA230035	K
	2002.03-2004.05	Hatchback Engine T8 Without ABS		○	GHA230035	K
SORENTO I (JC)						
2.4 (102 kW)	2002.08-	Closed Off-Road Vehicle Engine G4JS	•		GWB6944	
2.5 CRDi (103 kW)	2002.08-	Closed Off-Road Vehicle Engine D4CB	•		GWB6944	
2.5 CRDi (120 kW)	2006.05-	Closed Off-Road Vehicle Engine D4CB	•		GWB6944	
2.5 CRDi (125 kW)	2006.08-2007.05	Closed Off-Road Vehicle Engine D4CB	•		GWB6944	
3.3 V6 (177 kW)	2006.12-	Closed Off-Road Vehicle	•		GWB6944	
3.3 V6 4WD (182 kW)	2007.11-	Closed Off-Road Vehicle Engine G6DB	•		GWB6944	
3.5 V6 (143 kW)	2002.08-	Closed Off-Road Vehicle Engine G6CU	•		GWB6944	



	 YEAR		F	R	G-AP Ref.	KIT
KIA						
SORENTO II (XM)						
2.0 CRDi (110 kW)	2010.11-	Closed Off-Road Vehicle Engine D4HA	•		GHA330009	
	2010.11-	Closed Off-Road Vehicle Engine D4HA		◦	GHA400190	
2.0 CRDi 4WD (110 kW)	2010.11-	Closed Off-Road Vehicle Engine D4HA	•		GHA330009	
2.2 CRDi (145 kW)	2009.11-	Closed Off-Road Vehicle Engine D4HB	•		GHA330009	
	2009.11-	Closed Off-Road Vehicle Engine D4HB		◦	GHA400190	
2.2 CRDi 4WD (145 kW)	2009.11-	Closed Off-Road Vehicle Engine D4HB	•		GHA330009	
2.4 CVVT (128 kW)	2009.11-	Closed Off-Road Vehicle Engine G4KE	•		GHA330009	
	2009.11-	Closed Off-Road Vehicle Engine G4KE		◦	GHA400190	
2.4 CVVT (141 kW)	2012.10-	Closed Off-Road Vehicle Engine G4KJ	•		GHA330009	
	2012.10-	Closed Off-Road Vehicle Engine G4KJ		◦	GHA400190	
2.4 CVVT 4WD (128 kW)	2009.11-	Closed Off-Road Vehicle Engine G4KE	•		GHA330009	
2.4 CVVT 4WD (141 kW)	2012.10-	Closed Off-Road Vehicle Engine G4KJ	•		GHA330009	
2.4 GDi (141 kW)	2012.10-	Closed Off-Road Vehicle	•		GHA330009	
	2012.10-	Closed Off-Road Vehicle		◦	GHA400190	
2.4 GDi 4WD (141 kW)	2012.10-	Closed Off-Road Vehicle	•		GHA330009	
3.5 (204 kW)	2013.05-	Closed Off-Road Vehicle Engine G6DC	•		GHA330009	
	2013.05-	Closed Off-Road Vehicle Engine G6DC		◦	GHA400190	
SOUL						
-	2008-			◦	GHA400261	
SOUL (AM)						
1.6 CRDi (85 kW)	2009.02-	Hatchback Engine D4FB	•		GWB6923	
	2009.02-	Hatchback Engine D4FB		◦	GHA400260	
1.6 CRDi (94 kW)	2009.02-	Hatchback Engine D4FB	•		GWB6923	
	2009.02-	Hatchback Engine D4FB		◦	GHA400260	
1.6 CVVT (77 kW)	2009.02-	Hatchback	•		GWB6923	
	2009.02-	Hatchback		◦	GHA400260	
1.6 CVVT (93 kW)	2009.02-	Hatchback Engine G4FC	•		GWB6923	
	2009.02-	Hatchback Engine G4FC		◦	GHA400260	
1.6 CVVT (95 kW)	2012.03-	Hatchback Engine G4FC	•		GWB6923	
	2012.03-	Hatchback Engine G4FC		◦	GHA400260	
1.6 GDi (103 kW)	2011.06-	Hatchback Engine G4FD	•		GWB6923	
	2011.06-	Hatchback Engine G4FD		◦	GHA400260	
SOUL II (PS)						
1.6 CRDi 128 (94 kW)	2014.02-	Hatchback Engine D4FB	•		GWB6923	
1.6 GDi (97 kW)	2014.02-	Hatchback Engine G4FD	•		GWB6923	
SPORTAGE						
-			•	◦	GHA430002	
SPORTAGE (JE_)						
2.0 16V 4WD (104 kW)	2005.01-2007.01	Closed Off-Road Vehicle Engine G4GC	•		GHA427005	
	2005.01-2007.01	Closed Off-Road Vehicle Engine G4GC	•		GHA427021	
	2005.01-2007.01	Closed Off-Road Vehicle Engine G4GC	•		GWB6891	
	2005.01-2007.01	Closed Off-Road Vehicle Engine G4GC		◦	GHA427004	
	2005.01-2007.01	Closed Off-Road Vehicle Engine G4GC		◦	GWB6956	
2.0 CRDi (100 kW)	2006.01-	Closed Off-Road Vehicle Engine D4EA	•		GHA427005	
	2006.01-	Closed Off-Road Vehicle Engine D4EA	•		GHA427021	
	2006.01-	Closed Off-Road Vehicle Engine D4EA	•		GWB6891	
	2006.01-	Closed Off-Road Vehicle Engine D4EA With ABS		◦	GHA233005	K
	2006.01-	Closed Off-Road Vehicle Engine D4EA With ABS		◦	GHA233005	K
2.0 CRDi (103 kW)	2006.01-	Closed Off-Road Vehicle Engine D4EA-V	•		GHA427005	
	2006.01-	Closed Off-Road Vehicle Engine D4EA-V	•		GHA427021	
	2006.01-	Closed Off-Road Vehicle Engine D4EA-V	•		GWB6891	
	2006.01-	Closed Off-Road Vehicle Engine D4EA-V With ABS		◦	GHA233005	K
	2006.01-	Closed Off-Road Vehicle Engine D4EA-V With ABS		◦	GHA233005	K
2.0 CRDi (110 kW)	2008.09-	Closed Off-Road Vehicle Engine D4EA	•		GHA427005	
	2008.09-	Closed Off-Road Vehicle Engine D4EA	•		GHA427021	
	2008.09-	Closed Off-Road Vehicle Engine D4EA	•		GWB6891	
	2008.09-	Closed Off-Road Vehicle Engine D4EA With ABS		◦	GHA233005	K
	2008.09-	Closed Off-Road Vehicle Engine D4EA With ABS		◦	GHA233005	K
2.0 CRDi (83 kW)	2005.02-	Closed Off-Road Vehicle Engine D4EA	•		GHA427005	
	2005.02-	Closed Off-Road Vehicle Engine D4EA	•		GHA427021	
	2005.02-	Closed Off-Road Vehicle Engine D4EA	•		GWB6891	
	2005.02-	Closed Off-Road Vehicle Engine D4EA With ABS		◦	GHA233005	K
	2005.02-	Closed Off-Road Vehicle Engine D4EA With ABS		◦	GHA233005	K



	 YEAR		F	R	G-AP Ref.	KIT
KIA						
SPORTAGE (JE_)						
2.0 CRDi 4WD (100 kW)	2006.01-	Closed Off-Road Vehicle Engine D4EA	•		GHA427005	
	2006.01-	Closed Off-Road Vehicle Engine D4EA	•		GHA427021	
	2006.01-	Closed Off-Road Vehicle Engine D4EA	•		GWB6891	
	2006.01-	Closed Off-Road Vehicle Engine D4EA		○	GHA427004	
	2006.01-	Closed Off-Road Vehicle Engine D4EA		○	GWB6956	
2.0 CRDi 4WD (103 kW)	2006.01-	Closed Off-Road Vehicle Engine D4EA-F/D4EA-V	•		GHA427005	
	2006.01-	Closed Off-Road Vehicle Engine D4EA-F/D4EA-V	•		GHA427021	
	2006.01-	Closed Off-Road Vehicle Engine D4EA-F/D4EA-V	•		GWB6891	
	2006.01-	Closed Off-Road Vehicle Engine D4EA-F/D4EA-V		○	GHA427004	
	2006.01-	Closed Off-Road Vehicle Engine D4EA-F/D4EA-V		○	GWB6956	
2.0 CRDi 4WD (110 kW)	2008.09-	Closed Off-Road Vehicle Engine D4EA	•		GHA427005	
	2008.09-	Closed Off-Road Vehicle Engine D4EA	•		GHA427021	
	2008.09-	Closed Off-Road Vehicle Engine D4EA	•		GWB6891	
	2008.09-	Closed Off-Road Vehicle Engine D4EA		○	GHA427004	
	2008.09-	Closed Off-Road Vehicle Engine D4EA		○	GWB6956	
2.0 CRDi 4WD (83 kW)	2005.02-2005.12	Closed Off-Road Vehicle Engine D4EA	•		GHA427005	
	2005.02-2005.12	Closed Off-Road Vehicle Engine D4EA	•		GHA427021	
	2005.02-2005.12	Closed Off-Road Vehicle Engine D4EA	•		GWB6891	
	2005.02-2005.12	Closed Off-Road Vehicle Engine D4EA		○	GHA427004	
	2005.02-2005.12	Closed Off-Road Vehicle Engine D4EA		○	GWB6956	
2.0 i 16V (104 kW)	2008.04-	Closed Off-Road Vehicle Engine G4GC	•		GHA427005	
	2008.04-	Closed Off-Road Vehicle Engine G4GC	•		GHA427021	
	2008.04-	Closed Off-Road Vehicle Engine G4GC	•		GWB6891	
	2008.04-	Closed Off-Road Vehicle Engine G4GC With ABS		○	GHA233005	K
	2008.04-	Closed Off-Road Vehicle Engine G4GC With ABS		○	GHA233005	K
2.7 V6 4WD (129 kW)	2005.01-2007.01	Closed Off-Road Vehicle Engine G6BA	•		GHA427005	
	2005.01-2007.01	Closed Off-Road Vehicle Engine G6BA	•		GWB6891	
	2005.01-2007.01	Closed Off-Road Vehicle Engine G6BA		○	GHA427004	
	2005.01-2007.01	Closed Off-Road Vehicle Engine G6BA		○	GWB6956	
	2005.01-2007.01	Closed Off-Road Vehicle Engine G6BA With ABS		○	GHA233005	K
	2005.01-2007.01	Closed Off-Road Vehicle Engine G6BA With ABS		○	GHA233005	K
SPORTAGE (K00)						
2.0 i 16V 4WD (95 kW)	1998.11-2004.08	Closed Off-Road Vehicle		○	GHA427004	
SPORTAGE (SL)						
1.6 GDi (99 kW)	2011.02-	Closed Off-Road Vehicle Engine G4FD	•		GHA427021	
	2011.02-	Closed Off-Road Vehicle Engine G4FD	•		GWB6891	
	2011.02-	Closed Off-Road Vehicle Engine G4FD		○	GHA400258	
1.7 CRDi (85 kW)	2010.12-	Closed Off-Road Vehicle Engine D4FD-L	•		GHA427021	
	2010.12-	Closed Off-Road Vehicle Engine D4FD-L	•		GWB6891	
	2010.12-	Closed Off-Road Vehicle Engine D4FD-L		○	GHA400258	
2.0 CRDi (100 kW)	2010.07-	Closed Off-Road Vehicle Engine D4HA	•		GHA427021	
	2010.07-	Closed Off-Road Vehicle Engine D4HA	•		GWB6891	
	2010.07-	Closed Off-Road Vehicle Engine D4HA		○	GHA400258	
2.0 CRDi (135 kW)	2010.08-	Closed Off-Road Vehicle Engine D4HA	•		GHA427021	
	2010.08-	Closed Off-Road Vehicle Engine D4HA	•		GWB6891	
	2010.08-	Closed Off-Road Vehicle Engine D4HA		○	GHA400258	
2.0 CRDi AWD (100 kW)	2010.07-	Closed Off-Road Vehicle Engine D4HA	•		GHA427021	
	2010.07-	Closed Off-Road Vehicle Engine D4HA	•		GWB6891	
	2010.07-	Closed Off-Road Vehicle Engine D4HA		○	GHA427004	
2.0 CRDi AWD (135 kW)	2010.08-	Closed Off-Road Vehicle Engine D4HA	•		GHA427021	
	2010.08-	Closed Off-Road Vehicle Engine D4HA	•		GWB6891	
	2010.08-	Closed Off-Road Vehicle Engine D4HA		○	GHA427004	
2.0 CVVT (120 kW)	2010.07-	Closed Off-Road Vehicle Engine G4KD	•		GHA427021	
	2010.07-	Closed Off-Road Vehicle Engine G4KD	•		GWB6891	
	2010.07-	Closed Off-Road Vehicle Engine G4KD		○	GHA400258	
2.0 CVVT (122 kW)	2010.07-	Closed Off-Road Vehicle Engine G4KD	•		GHA427021	
	2010.07-	Closed Off-Road Vehicle Engine G4KD	•		GWB6891	
	2010.07-	Closed Off-Road Vehicle Engine G4KD		○	GHA400258	
2.0 CVVT AWD (120 kW)	2010.07-	Closed Off-Road Vehicle Engine G4KD	•		GHA427021	
	2010.07-	Closed Off-Road Vehicle Engine G4KD	•		GWB6891	
	2010.07-	Closed Off-Road Vehicle Engine G4KD		○	GHA427004	
2.0 CVVT AWD (122 kW)	2010.07-	Closed Off-Road Vehicle Engine G4NC	•		GHA427021	
	2010.07-	Closed Off-Road Vehicle Engine G4NC	•		GWB6891	
	2010.07-	Closed Off-Road Vehicle Engine G4NC		○	GHA427004	



	 YEAR		F	R	G-AP Ref.	KIT
KIA						
SPORTAGE (SL)						
2.0 GDi (122 kW)	2014.02-	Closed Off-Road Vehicle Engine G4NC	•		GHA427021	
	2014.02-	Closed Off-Road Vehicle Engine G4NC		○	GHA400258	
2.0 GDi AWD (122 kW)	2014.02-	Closed Off-Road Vehicle Engine G4NC	•		GHA427021	
	2014.02-	Closed Off-Road Vehicle Engine G4NC		○	GHA427004	
SPORTAGE NEW						
-	2004-2010	Without ABS		○	GHA233008	
	2004-2010	Without ABS		○	GHA233008	
VENGA (YN)						
1.4 CRDi (55 kW)	2010.02-	Hatchback Engine D4FC	•		GWB6923	
	2010.02-	Hatchback Engine D4FC		○	GHA400260	
1.4 CRDi (57 kW)	2010.02-	Hatchback Engine D4FC	•		GWB6923	
	2010.02-	Hatchback Engine D4FC		○	GHA400260	
1.4 CRDi (66 kW)	2010.02-	Hatchback Engine D4FC	•		GWB6923	
	2010.02-	Hatchback Engine D4FC		○	GHA400260	
1.4 CVVT (66 kW)	2010.02-	Hatchback Engine G4FA-L	•		GWB6923	
	2010.02-	Hatchback Engine G4FA-L		○	GHA400260	
1.6 CRDi (85 kW)	2010.02-	Hatchback Engine D4FB	•		GWB6923	
	2010.02-	Hatchback Engine D4FB		○	GHA400260	
1.6 CRDi (94 kW)	2010.02-	Hatchback Engine D4FB	•		GWB6923	
	2010.02-	Hatchback Engine D4FB		○	GHA400260	
1.6 CVVT (92 kW)	2010.02-	Hatchback Engine G4FC	•		GWB6923	
	2010.02-	Hatchback Engine G4FC		○	GHA400260	
LADA						
NIVA (2121)						
1.7 i (59 kW)	1996.06-	Closed Off-Road Vehicle Engine BA321214	•		GHA422010	
	1996.06-	Closed Off-Road Vehicle Engine BA321214	•		GWB1324	
1.7 i 4x4 (60 kW)	2000.10-	Closed Off-Road Vehicle	•		GHA422010	
	2000.10-	Closed Off-Road Vehicle	•		GWB1324	
1.7 i 4x4 (61 kW)	2010.09-	Closed Off-Road Vehicle	•		GWB1324	
1.9 Diesel (47 kW)	1993.01-	Closed Off-Road Vehicle Engine XUD9A	•		GHA422010	
	1993.01-	Closed Off-Road Vehicle Engine XUD9A	•		GWB1324	
1.9 Diesel (55 kW)	1999.01-	Closed Off-Road Vehicle Engine XUD9SD	•		GWB1324	
SAMARA (2108, 2109)						
1.1 (43 kW)	1996.02-	Hatchback Engine BA321081(KAT)	•		GHA422029	
	1996.02-	Hatchback Engine BA321081(KAT)	•		GWB1306	
1.3 (45 kW)	1991.09-	Hatchback Engine BA32108(KAT)	•		GHA422029	
	1991.09-	Hatchback Engine BA32108(KAT)	•		GWB1306	
1.3 (50 kW)	1996.02-	Hatchback Engine BA321115	•		GHA422029	
	1996.02-	Hatchback Engine BA321115	•		GWB1306	
1.5 (50 kW)	1991.09-	Hatchback Engine BA321083(KAT)	•		GHA422029	
	1991.09-	Hatchback Engine BA321083(KAT)	•		GWB1306	
1.5 (52 kW)	1995.02-	Hatchback Engine BA32111	•		GHA422029	
	1995.02-	Hatchback Engine BA32111	•		GWB1306	
SAMARA FORMA (21099)						
1.1 (39 kW)	1991.07-	Saloon Engine BA321081(KAT)	•		GWB1306	
1.3 (45 kW)	1991.07-	Saloon Engine BA32108	•		GWB1306	
1.3 (46 kW)	1990.05-	Saloon Engine BA32108	•		GWB1306	
1.3 (50 kW)	1996.02-	Saloon Engine BA321115	•		GWB1306	
1.5 (50 kW)	1991.07-	Saloon Engine BA321083(KAT)	•		GWB1306	
1.5 (52 kW)	1994.11-	Saloon Engine BA32111	•		GWB1306	
1.5 (53 kW)	1991.09-	Saloon Engine BA321083	•		GWB1306	
1.5 (57 kW)	2000.01-	Saloon Engine VAZ-2111	•		GWB1306	
1.5 (59 kW)	2003.08-	Saloon Engine VAZ-2111	•		GWB1306	
LANCIA						
DEDRA (835)						
1.6 (66 kW)	1994.10-1999.07	Estate Engine 159B9.000	•		GHA422015	
	1994.10-1999.07	Estate Engine 159B9.000	•		GWB1438	
	1994.10-1999.07	Estate Engine 159B9.000		○	GHA230028	K
	1994.10-1999.07	Estate Engine 159B9.000		○	GHA425008	
	1994.10-1999.07	Estate Engine 159B9.000 Without ABS		○	GHA230044	K
1.6 16V (76 kW)	1996.01-1999.07	Estate Engine 182A4.000	•		GHA422015	
	1996.01-1999.07	Estate Engine 182A4.000	•		GWB1439	



	 YEAR		F	R	G-AP Ref.	KIT
LANCIA						
DEDRA (835)						
1.6 16V (76 kW)	1996.01-1999.07	Estate Engine 182A4.000		o	GHA230028	K
	1996.01-1999.07	Estate Engine 182A4.000		o	GHA425008	
	1996.01-1999.07	Estate Engine 182A4.000 Without ABS		o	GHA230044	K
	1996.01-1999.07	Saloon Engine 182A4.000	•		GHA422015	
	1996.01-1999.07	Saloon Engine 182A4.000	•		GWB1439	
	1996.01-1999.07	Saloon Engine 182A4.000		o	GHA230028	K
	1996.01-1999.07	Saloon Engine 182A4.000		o	GHA425008	
	1996.01-1999.07	Saloon Engine 182A4.000 Without ABS		o	GHA230044	K
1.6 i.e. (55 kW)	1993.04-1999.07	Saloon Engine 835C1.000	•		GHA422015	
	1993.04-1999.07	Saloon Engine 835C1.000	•		GWB1438	
	1993.04-1999.07	Saloon Engine 835C1.000		o	GHA230028	K
	1993.04-1999.07	Saloon Engine 835C1.000		o	GHA425008	
	1993.04-1999.07	Saloon Engine 835C1.000 Without ABS		o	GHA230044	K
1.6 LE (66 kW)	1994.07-1999.07	Saloon Engine 159B9.000	•		GHA422015	
	1994.07-1999.07	Saloon Engine 159B9.000	•		GWB1438	
	1994.07-1999.07	Saloon Engine 159B9.000		o	GHA230028	K
	1994.07-1999.07	Saloon Engine 159B9.000		o	GHA425008	
	1994.07-1999.07	Saloon Engine 159B9.000 Without ABS		o	GHA230044	K
1.8 16V LE (83 kW)	1996.03-1999.07	Estate Engine 182A2.000	•		GWB1439	
	1996.03-1999.07	Estate Engine 182A2.000		o	GHA230028	K
	1996.03-1999.07	Estate Engine 182A2.000		o	GHA425008	
	1996.03-1999.07	Estate Engine 182A2.000 Without ABS		o	GHA230044	K
	1996.03-1999.07	Saloon Engine 182A2.000	•		GWB1439	
	1996.03-1999.07	Saloon Engine 182A2.000		o	GHA230028	K
	1996.03-1999.07	Saloon Engine 182A2.000		o	GHA425008	
	1996.03-1999.07	Saloon Engine 182A2.000 Without ABS		o	GHA230044	K
1.8 GT 16V (96 kW)	1996.03-1999.07	Estate Engine 183A1.000	•		GWB1439	
	1996.03-1999.07	Estate Engine 183A1.000		o	GHA230028	K
	1996.03-1999.07	Estate Engine 183A1.000		o	GHA425008	
	1996.03-1999.07	Estate Engine 183A1.000 Without ABS		o	GHA230044	K
	1996.03-1999.07	Saloon Engine 183A1.000	•		GWB1439	
	1996.03-1999.07	Saloon Engine 183A1.000		o	GHA230028	K
	1996.03-1999.07	Saloon Engine 183A1.000		o	GHA425008	
	1996.03-1999.07	Saloon Engine 183A1.000 Without ABS		o	GHA230044	K
1.8 i.e. (66 kW)	1993.08-1999.07	Saloon Engine 835C5.000	•	o	GWB5549	
	1993.08-1999.07	Saloon Engine 835C5.000	•		GWB1439	
	1993.08-1999.07	Saloon Engine 835C5.000		o	GHA230028	K
	1993.08-1999.07	Saloon Engine 835C5.000		o	GHA425008	
	1993.08-1999.07	Saloon Engine 835C5.000 Without ABS		o	GHA230044	K
	1994.07-1999.07	Estate Engine 836A5.000	•		GWB1439	
1.8 i.e. (74 kW)	1994.07-1999.07	Estate Engine 836A5.000		o	GHA230028	K
	1994.07-1999.07	Estate Engine 836A5.000		o	GHA425008	
	1994.07-1999.07	Estate Engine 836A5.000 Without ABS		o	GHA230044	K
	1994.07-1999.07	Saloon Engine 836A5.000	•	o	GWB5549	
	1994.07-1999.07	Saloon Engine 836A5.000	•		GWB1439	
	1994.07-1999.07	Saloon Engine 836A5.000		o	GHA230028	K
	1994.07-1999.07	Saloon Engine 836A5.000		o	GHA425008	
	1994.07-1999.07	Saloon Engine 836A5.000 Without ABS		o	GHA230044	K
	1994.07-1999.07	Estate Engine 160D1.000/835A4.000	•	o	GWB5549	
	1994.07-1999.07	Estate Engine 160D1.000/835A4.000	•		GWB1439	
1.9 TDS (66 kW)	1994.07-1999.07	Estate Engine 160D1.000/835A4.000		o	GHA230028	K
	1994.07-1999.07	Estate Engine 160D1.000/835A4.000		o	GHA425008	
	1994.07-1999.07	Estate Engine 160D1.000/835A4.000 Without ABS		o	GHA230044	K
	1994.07-1999.07	Estate Engine 836A3.000	•	o	GWB5549	
	1994.07-1999.07	Estate Engine 836A3.000	•		GWB1439	
2.0 16V (102 kW)	1994.07-1999.07	Estate Engine 836A3.000		o	GHA230028	K
	1994.07-1999.07	Estate Engine 836A3.000		o	GHA425008	
	1994.07-1999.07	Estate Engine 836A3.000 Without ABS		o	GHA230044	K
	1994.07-1999.07	Saloon Engine 836A3.000	•		GWB1439	
	1994.07-1999.07	Saloon Engine 836A3.000		o	GHA230028	K
	1994.07-1999.07	Saloon Engine 836A3.000		o	GHA425008	
	1994.07-1999.07	Saloon Engine 836A3.000 Without ABS		o	GHA230044	K
	1990.11-1994.07	Saloon Engine 835A7.046	•		GWB1439	
	1990.11-1994.07	Saloon Engine 835A7.046		o	GHA425008	



	 YEAR		F	R	G-AP Ref.	KIT
LANCIA						
DEDRA (835)						
2.0 i.e. Turbo (119 kW)	1991.04-1999.07	Saloon Engine 835A8.046	•		GWB1439	
	1991.04-1999.07	Saloon Engine 835A8.046		○	GHA230028	K
	1991.04-1999.07	Saloon Engine 835A8.046		○	GHA425008	
	1991.04-1999.07	Saloon Engine 835A8.046 Without ABS		○	GHA230044	K
2.0 i.e. Turbo Integrale (121 kW)	1990.05-1994.07	Saloon Engine 835A7.000	•		GWB1439	
	1990.05-1994.07	Saloon Engine 835A7.000		○	GHA425008	
2.0 Integrale (102 kW)	1994.07-1999.07	Estate Engine 836A3.000	•		GWB1439	
	1994.07-1999.07	Estate Engine 836A3.000		○	GHA425008	
2.0 Turbo (130 kW)	1990.11-1994.06	Saloon Engine 835A8.000	•		GWB1439	
	1990.11-1994.06	Saloon Engine 835A8.000		○	GHA230028	K
	1990.11-1994.06	Saloon Engine 835A8.000		○	GHA425008	
	1990.11-1994.06	Saloon Engine 835A8.000 Without ABS		○	GHA230044	K
DELTA II (836)						
1.4 i.e. (51 kW)	1994.10-1999.08	Hatchback Engine 160A1.046/836A4.000	•	○	GWB5549	
	1994.10-1999.08	Hatchback Engine 160A1.046/836A4.000	•		GHA422015	
	1994.10-1999.08	Hatchback Engine 160A1.046/836A4.000	•		GWB3414	
	1994.10-1999.08	Hatchback Engine 160A1.046/836A4.000		○	GHA230028	K
	1994.10-1999.08	Hatchback Engine 160A1.046/836A4.000 Without ABS		○	GHA230044	K
1.6 i.e. (55 kW)	1993.06-1999.08	Hatchback Engine 835C1.000	•		GHA422015	
	1993.06-1999.08	Hatchback Engine 835C1.000	•		GWB3414	
	1993.06-1999.08	Hatchback Engine 835C1.000		○	GHA230028	K
	1993.06-1999.08	Hatchback Engine 835C1.000 Without ABS		○	GHA230044	K
1.6 i.e. (66 kW)	1996.03-1999.08	Hatchback Engine 182A6.000	•		GHA422015	
	1996.03-1999.08	Hatchback Engine 182A6.000	•		GWB3414	
	1996.03-1999.08	Hatchback Engine 182A6.000		○	GHA230028	K
	1996.03-1999.08	Hatchback Engine 182A6.000 Without ABS		○	GHA230044	K
1.6 i.e. 16V (76 kW)	1996.01-1999.08	Hatchback Engine 182A4.000	•		GHA422015	
	1996.01-1999.08	Hatchback Engine 182A4.000	•		GWB3414	
	1996.01-1999.08	Hatchback Engine 182A4.000		○	GHA230028	K
	1996.01-1999.08	Hatchback Engine 182A4.000 Without ABS		○	GHA230044	K
	1996.01-1999.08	Hatchback Engine 182A4.000 Without ABS		○	GHA230028	K
1.8 (66 kW)	1996.02-1999.09	Hatchback Engine 182 A2.000	•		GWB1439	
	1996.02-1999.09	Hatchback Engine 182 A2.000		○	GHA230028	K
	1996.02-1999.09	Hatchback Engine 182 A2.000 Without ABS		○	GHA230044	K
1.8 i.e. (66 kW)	1994.07-1999.08	Hatchback Engine 835C4.000/836A6.000/836C4.000	•	○	GWB5549	
	1994.07-1999.08	Hatchback Engine 835C4.000/836A6.000/836C4.000	•		GHA425008	
	1994.07-1999.08	Hatchback Engine 835C4.000/836A6.000/836C4.000	•		GWB1439	
	1994.07-1999.08	Hatchback Engine 835C4.000/836A6.000/836C4.000		○	GHA230028	K
	1994.07-1999.08	Hatchback Engine 835C4.000/836A6.000/836C4.000 Without ABS		○	GHA230044	K
1.8 i.e. (76 kW)	1993.06-1999.08	Hatchback Engine 835C2.000	•		GHA425008	
	1993.06-1999.08	Hatchback Engine 835C2.000	•		GWB1439	
	1993.06-1999.08	Hatchback Engine 835C2.000		○	GHA230028	K
	1993.06-1999.08	Hatchback Engine 835C2.000 Without ABS		○	GHA230044	K
1.8 i.e. 16V (83 kW)	1996.03-1999.08	Hatchback Engine 182A2.000	•		GHA425008	
	1996.03-1999.08	Hatchback Engine 182A2.000	•		GWB1439	
	1996.03-1999.08	Hatchback Engine 182A2.000		○	GHA230028	K
	1996.03-1999.08	Hatchback Engine 182A2.000 Without ABS		○	GHA230044	K
1.8 i.e. 16V GT (96 kW)	1996.03-1999.08	Hatchback Engine 183A1.000	•		GHA425008	
	1996.03-1999.08	Hatchback Engine 183A1.000	•		GWB1439	
	1996.03-1999.08	Hatchback Engine 183A1.000		○	GHA230028	K
	1996.03-1999.08	Hatchback Engine 183A1.000 Without ABS		○	GHA230044	K
1.9 TD (66 kW)	1994.10-1999.08	Hatchback Engine 160D1.000/835A4.000	•		GHA425008	
	1994.10-1999.08	Hatchback Engine 160D1.000/835A4.000	•		GWB1439	
	1994.10-1999.08	Hatchback Engine 160D1.000/835A4.000		○	GHA230028	K
	1994.10-1999.08	Hatchback Engine 160D1.000/835A4.000 Without ABS		○	GHA230044	K
2.0 16V (102 kW)	1993.06-1999.08	Hatchback Engine 836A3.000	•		GHA425008	
	1993.06-1999.08	Hatchback Engine 836A3.000	•		GWB1439	
	1993.06-1999.08	Hatchback Engine 836A3.000		○	GHA230028	K
	1993.06-1999.08	Hatchback Engine 836A3.000 Without ABS		○	GHA230044	K
2.0 16V Turbo (137 kW)	1993.06-1999.08	Hatchback Engine 836A2.000	•		GHA425008	
	1993.06-1999.08	Hatchback Engine 836A2.000	•		GWB1488	
	1993.06-1999.08	Hatchback Engine 836A2.000		○	GHA230028	K
	1993.06-1999.08	Hatchback Engine 836A2.000 Without ABS		○	GHA230044	K
2.0 16V Turbo (142 kW)	1996.07-1999.08	Hatchback Engine 175A4.000	•		GHA425008	
	1996.07-1999.08	Hatchback Engine 175A4.000	•		GWB1488	



	 YEAR		F	R	G-AP Ref.	KIT
LANCIA						
DELTA II (836)						
2.0 16V Turbo (142 kW)	1996.07-1999.08	Hatchback Engine 175A4.000		o	GHA230028	K
	1996.07-1999.08	Hatchback Engine 175A4.000 Without ABS		o	GHA230044	K
DELTA III (844)						
1.4 (110 kW)	2008.09-	Hatchback Engine 198A1.000	•		GWB3598	
	2008.09-	Hatchback Engine 198A1.000 With ABS		o	GHA230046	K
1.4 (88 kW)	2008.09-	Hatchback Engine 198A4.000	•		GWB3598	
	2008.09-	Hatchback Engine 198A4.000 With ABS		o	GHA230046	K
1.4 16V (103 kW)	2010.07-	Hatchback Engine 198A7.000	•		GWB3598	
	2010.07-	Hatchback Engine 198A7.000 With ABS		o	GHA230046	K
1.4 Bifuel (88 kW)	2011.07-	Hatchback Engine 198A4.000	•		GWB3598	
	2011.07-	Hatchback Engine 198A4.000 With ABS		o	GHA230046	K
1.6 D Multijet (77 kW)	2011.04-	Hatchback Engine 944A3.000	•		GWB3598	
	2011.04-	Hatchback Engine 944A3.000 With ABS		o	GHA230046	K
1.6 D Multijet (85 kW)	2008.08-	Hatchback Engine 955A4.000	•		GWB3598	
	2008.08-	Hatchback Engine 955A4.000 With ABS		o	GHA230046	K
1.6 D Multijet (88 kW)	2008.09-	Hatchback Engine 198A2.000	•		GWB3598	
	2008.09-	Hatchback Engine 198A2.000 With ABS		o	GHA230046	K
1.8 (147 kW)	2009.01-	Hatchback Engine 939B1.000	•		GWB3599	
	2009.01-	Hatchback Engine 939B1.000 With ABS		o	GHA230046	K
1.9 D Multijet (140 kW)	2009.01-	Hatchback Engine 844A1.000	•		GWB3599	
	2009.01-	Hatchback Engine 844A1.000 With ABS		o	GHA230046	K
2.0 D Multijet (120 kW)	2008.09-	Hatchback Engine 844A2.000	•		GWB3599	
	2008.09-	Hatchback Engine 844A2.000 With ABS		o	GHA230046	K
2.0 D Multijet (121 kW)	2008.09-	Hatchback Engine 198A5.000/198A8.000	•		GWB3599	
	2008.09-	Hatchback Engine 198A5.000/198A8.000 With ABS		o	GHA230046	K
FLAVIA (JS)						
2.4 (125 kW)	2012.03-2014.12	Convertible Engine EDG	•		GHA332001	K
KAPPA (838)						
2.0 16V Turbo (151 kW)	1996.11-2001.03	Coupe Engine 838A4.000	•		GWB1488	
	1996.11-2001.03	Coupe Engine 838A4.000		o	GHA235020	K
	1996.11-2001.03	Coupe Engine 838A4.000		o	GHA235022	K
2.0 20V (114 kW)	1996.07-2001.03	Coupe Engine 838A6.000	•		GWB1488	
	1996.07-2001.03	Coupe Engine 838A6.000		o	GHA235020	K
	1996.07-2001.03	Coupe Engine 838A6.000		o	GHA235022	K
2.0 20V Turbo (162 kW)	1998.06-2001.03	Coupe Engine 175A3.000		o	GHA235020	K
	1998.06-2001.03	Coupe Engine 175A3.000		o	GHA235022	K
2.4 20V (129 kW)	1996.11-2001.03	Coupe Engine 838A2.000	•		GWB1488	
	1996.11-2001.03	Coupe Engine 838A2.000		o	GHA235020	K
	1996.11-2001.03	Coupe Engine 838A2.000		o	GHA235022	K
3.0 24V (150 kW)	1996.11-2001.03	Coupe Engine 838B.000	•		GWB1488	
	1996.11-2001.03	Coupe Engine 838B.000		o	GHA235020	K
	1996.11-2001.03	Coupe Engine 838B.000		o	GHA235022	K
KAPPA (838A)						
2.0 16V Turbo (151 kW)	1995.02-2001.10	Saloon Engine 838A4.000	•		GWB1488	
	1995.02-2001.10	Saloon Engine 838A4.000		o	GHA235020	K
	1995.02-2001.10	Saloon Engine 838A4.000		o	GHA235022	K
2.0 20V (107 kW)	1994.10-2001.10	Saloon Engine 838A1.000	•		GWB1488	
	1994.10-2001.10	Saloon Engine 838A1.000		o	GHA235020	K
	1994.10-2001.10	Saloon Engine 838A1.000		o	GHA235022	K
2.0 20V (114 kW)	1996.07-2001.10	Saloon Engine 838A6.000	•		GWB1488	
	1996.07-2001.10	Saloon Engine 838A6.000		o	GHA235020	K
	1996.07-2001.10	Saloon Engine 838A6.000		o	GHA235022	K
2.0 20V Turbo (162 kW)	1998.06-2001.10	Saloon Engine 175A3.000		o	GHA235020	K
	1998.06-2001.10	Saloon Engine 175A3.000		o	GHA235022	K
2.4 20V (129 kW)	1994.08-2001.10	Saloon Engine 838A2.000	•	o	GWB5549	
	1994.08-2001.10	Saloon Engine 838A2.000	•		GWB1488	
	1994.08-2001.10	Saloon Engine 838A2.000		o	GHA235020	K
	1994.08-2001.10	Saloon Engine 838A2.000		o	GHA235022	K
2.4 JTD (100 kW)	1998.06-2001.10	Saloon Engine 838A8.000		o	GHA235020	K
2.4 T.DS (91 kW)	1994.08-2001.10	Saloon Engine 838A3.000/838A7.000	•	o	GWB5549	
	1994.08-2001.10	Saloon Engine 838A3.000/838A7.000	•		GWB1488	
	1994.08-2001.10	Saloon Engine 838A3.000/838A7.000		o	GHA235022	K
3.0 24V (150 kW)	1994.08-2001.10	Saloon Engine 838B.000	•	o	GWB5549	



	 YEAR		F	R	G-AP Ref.	KIT
LANCIA						
KAPPA (838A)						
3.0 24V (150 kW)	1994.08-2001.10	Saloon Engine 838B.000	•		GWB1488	
	1994.08-2001.10	Saloon Engine 838B.000		○	GHA235020	K
	1994.08-2001.10	Saloon Engine 838B.000		○	GHA235022	K
KAPPA (838B)						
2.0 16V Turbo (151 kW)	1996.07-2001.10	Estate Engine 838A4.000	•		GWB1488	
	1996.07-2001.10	Estate Engine 838A4.000		○	GHA235020	K
	1996.07-2001.10	Estate Engine 838A4.000		○	GHA235022	K
2.0 20V (114 kW)	1996.07-2001.10	Estate Engine 838A6.000	•		GWB1488	
	1996.07-2001.10	Estate Engine 838A6.000		○	GHA235020	K
	1996.07-2001.10	Estate Engine 838A6.000		○	GHA235022	K
2.0 20V Turbo (162 kW)	1998.06-2001.10	Estate Engine 175A3.000		○	GHA235020	K
	1998.06-2001.10	Estate Engine 175A3.000		○	GHA235022	K
2.4 20V (129 kW)	1996.07-2001.10	Estate Engine 838A2.000	•		GWB1488	
	1996.07-2001.10	Estate Engine 838A2.000		○	GHA235020	K
	1996.07-2001.10	Estate Engine 838A2.000		○	GHA235022	K
2.4 JTD (100 kW)	1998.06-2001.10	Estate Engine 838A8.000		○	GHA235020	K
2.4 T.DS (91 kW)	1996.07-2001.10	Estate Engine 838A3.000/838A7.000	•		GWB1488	
	1996.07-2001.10	Estate Engine 838A3.000/838A7.000		○	GHA235022	K
3.0 24V (150 kW)	1996.07-2001.10	Estate Engine 838B.000	•		GWB1488	
	1996.07-2001.10	Estate Engine 838B.000		○	GHA235020	K
	1996.07-2001.10	Estate Engine 838B.000		○	GHA235022	K
LYBRA (839AX)						
1.6 (76 kW)	2000.10-2005.10	Saloon Engine 182B6.000	•		GHA425008	
	2000.10-2005.10	Saloon Engine 182B6.000	•		GWB3539	
	2000.10-2005.10	Saloon Engine 182B6.000	•		GWB6540	
	2000.10-2005.10	Saloon Engine 182B6.000 With ABS		○	GHA230046	K
1.6 16V (76 kW)	1999.07-2005.10	Saloon Engine 182A4.000	•		GHA425008	
	1999.07-2005.10	Saloon Engine 182A4.000	•		GWB3539	
	1999.07-2005.10	Saloon Engine 182A4.000	•		GWB6540	
	1999.07-2005.10	Saloon Engine 182A4.000 With ABS		○	GHA230046	K
1.8 16V (96 kW)	1999.07-2005.10	Saloon Engine 839A4.000/839A7.000/839A9.000	•		GHA425008	
	1999.07-2005.10	Saloon Engine 839A4.000/839A7.000/839A9.000	•		GWB3539	
	1999.07-2005.10	Saloon Engine 839A4.000/839A7.000/839A9.000	•		GWB6540	
	1999.07-2005.10	Saloon Engine 839A4.000/839A7.000/839A9.000 With ABS		○	GHA230046	K
1.9 JTD (77 kW)	1999.07-2000.09	Saloon Engine AR32302 With ABS		○	GHA230046	K
1.9 JTD (81 kW)	2000.09-2001.05	Saloon Engine AR37101 With ABS		○	GHA230046	K
1.9 JTD (85 kW)	2001.05-2005.10	Saloon Engine 937A2.000 With ABS		○	GHA230046	K
2.0 20V (110 kW)	2000.09-2005.10	Saloon Engine 185A8.000 With ABS		○	GHA230046	K
2.0 20V (113 kW)	1999.07-2000.09	Saloon Engine 182B7.000 With ABS		○	GHA230046	K
2.4 JTD (103 kW)	2000.09-2002.05	Saloon Engine 839A6.000 With ABS		○	GHA230046	K
2.4 JTD (110 kW)	2002.05-2005.10	Saloon Engine 841C.000 With ABS		○	GHA230046	K
2.4 JTD (99 kW)	1999.07-2001.02	Saloon Engine 839A5.000/AR32501 With ABS		○	GHA230046	K
LYBRA (839BX)						
1.6 16V (76 kW)	1999.07-2005.10	Estate Engine 182A4.000	•		GHA425008	
	1999.07-2005.10	Estate Engine 182A4.000	•		GWB3539	
	1999.07-2005.10	Estate Engine 182A4.000	•		GWB6540	
	1999.07-2005.10	Estate Engine 182A4.000 With ABS		○	GHA230046	K
1.8 16V (96 kW)	1999.07-2005.10	Estate Engine 839A4.000/839A7.000	•		GHA425008	
	1999.07-2005.10	Estate Engine 839A4.000/839A7.000	•		GWB3539	
	1999.07-2005.10	Estate Engine 839A4.000/839A7.000	•		GWB6540	
	1999.07-2005.10	Estate Engine 839A4.000/839A7.000 With ABS		○	GHA230046	K
1.9 JTD (77 kW)	1999.07-2000.09	Estate Engine AR32302 With ABS		○	GHA230046	K
1.9 JTD (81 kW)	2000.09-2001.05	Estate Engine AR37101 With ABS		○	GHA230046	K
1.9 JTD (85 kW)	2001.05-2005.10	Estate Engine 937A2.000 With ABS		○	GHA230046	K
2.0 20V (110 kW)	2000.09-2005.10	Estate Engine 185A8.000 With ABS		○	GHA230046	K
2.0 20V (113 kW)	1999.07-2000.09	Estate Engine 182B7.000 With ABS		○	GHA230046	K
2.4 JTD (103 kW)	2000.09-2005.10	Estate Engine 839A6.000 With ABS		○	GHA230046	K
2.4 JTD (110 kW)	2002.05-2005.10	Estate Engine 841C.000 With ABS		○	GHA230046	K
2.4 JTD (99 kW)	1999.10-2000.09	Estate Engine 839A5.000/AR32501 With ABS		○	GHA230046	K
LYBRA SW (839BX)						
1.6 (76 kW)	2000.10-2005.10	Estate Engine 182B6.000	•		GHA425008	
	2000.10-2005.10	Estate Engine 182B6.000	•		GWB3539	
	2000.10-2005.10	Estate Engine 182B6.000	•		GWB6540	



	 YEAR		F	R	G-AP Ref.	KIT
LANCIA						
LYBRA SW (839BX)						
1.6 (76 kW)	2000.10-2005.10	Estate Engine 182B6.000 With ABS		o	GHA230046	K
MUSA (350)						
1.3 D Multijet (51 kW)	2004.10-	MPV Engine 188A9.000	•		GHA425008	
	2004.10-	MPV Engine 188A9.000	•		GWB3539	
	2004.10-	MPV Engine 188A9.000	•		GWB6540	
	2004.10-	MPV Engine 188A9.000 With ABS		o	GHA230046	K
1.3 D Multijet (66 kW)	2006.09-	MPV Engine 199A3.000	•		GHA425008	
	2006.09-	MPV Engine 199A3.000	•		GWB3539	
	2006.09-	MPV Engine 199A3.000	•		GWB6540	
	2006.09-	MPV Engine 199A3.000 With ABS		o	GHA230046	K
1.3 D Multijet (70 kW)	2009.03-	MPV Engine 199B1.000	•		GHA425008	
	2009.03-	MPV Engine 199B1.000	•		GWB3539	
	2009.03-	MPV Engine 199B1.000	•		GWB6540	
	2009.03-	MPV Engine 199B1.000 With ABS		o	GHA230046	K
1.4 (57 kW)	2005.09-	MPV Engine 350A1.000	•		GHA422015	
	2005.09-	MPV Engine 350A1.000	•		GWB3538	
	2005.09-	MPV Engine 350A1.000 With ABS		o	GHA230046	K
1.4 (66 kW)	2007.10-	MPV Engine 192B2.000	•		GHA422015	
	2007.10-	MPV Engine 192B2.000	•		GWB3538	
	2007.10-	MPV Engine 192B2.000 With ABS		o	GHA230046	K
1.4 (70 kW)	2004.10-	MPV Engine 843A1.000	•		GHA422015	
	2004.10-	MPV Engine 843A1.000	•		GWB3538	
	2004.10-	MPV Engine 843A1.000 With ABS		o	GHA230046	K
1.4 LPG (57 kW)	2010.11-	MPV Engine 350A1.000	•		GHA422015	
	2010.11-	MPV Engine 350A1.000	•		GWB3538	
	2010.11-	MPV Engine 350A1.000 With ABS		o	GHA230046	K
1.6 D Multijet (85 kW)	2008.07-	MPV Engine 350A2.000/350A3.000	•		GHA425008	
	2008.07-	MPV Engine 350A2.000/350A3.000	•		GWB3539	
	2008.07-	MPV Engine 350A2.000/350A3.000	•		GWB6540	
	2008.07-	MPV Engine 350A2.000/350A3.000 With ABS		o	GHA230046	K
1.6 D Multijet (88 kW)	2008.07-	MPV Engine 350A2.000	•		GHA425008	
	2008.07-	MPV Engine 350A2.000	•		GWB3539	
	2008.07-	MPV Engine 350A2.000	•		GWB6540	
	2008.07-	MPV Engine 350A2.000 With ABS		o	GHA230046	K
1.9 D Multijet (74 kW)	2004.10-	MPV Engine 188B2.000	•		GHA425008	
	2004.10-	MPV Engine 188B2.000	•		GWB3539	
	2004.10-	MPV Engine 188B2.000	•		GWB6540	
	2004.10-	MPV Engine 188B2.000 With ABS		o	GHA230046	K
PHEDRA (179)						
2.0 (100 kW)	2002.09-2010.11	MPV Engine RFN(EW10J4)	•		GWB3633	
	2002.09-2010.11	MPV Engine RFN(EW10J4)	•		GWB3649	
	2002.09-2010.11	MPV Engine RFN(EW10J4)		o	GHA230121	K
2.0 D Multijet (100 kW)	2006.07-2010.11	MPV Engine RHR	•		GWB3633	
	2006.07-2010.11	MPV Engine RHR	•		GWB3649	
	2006.07-2010.11	MPV Engine RHR		o	GHA230121	K
2.0 JTD (79 kW)	2003.07-2010.11	MPV Engine RHM(DW10ATED4)	•		GWB3633	
	2003.07-2010.11	MPV Engine RHM(DW10ATED4)	•		GWB3649	
	2003.07-2010.11	MPV Engine RHM(DW10ATED4)		o	GHA230121	K
2.0 JTD (80 kW)	2002.09-2010.11	MPV Engine RHW(DW10ATED4)	•		GWB3633	
	2002.09-2010.11	MPV Engine RHW(DW10ATED4)	•		GWB3649	
	2002.09-2010.11	MPV Engine RHW(DW10ATED4)		o	GHA230121	K
2.0 JTD (88 kW)	2006.06-2010.11	MPV Engine RHK	•		GWB3633	
	2006.06-2010.11	MPV Engine RHK	•		GWB3649	
	2006.06-2010.11	MPV Engine RHK		o	GHA230121	K
2.2 D Multijet (125 kW)	2008.03-2010.11	MPV Engine 4HS/4HT	•		GWB3649	
	2008.03-2010.11	MPV Engine 4HS/4HT		o	GHA230121	K
2.2 JTD (94 kW)	2002.09-2010.11	MPV Engine 4HW(DW12ATED4)	•		GWB3633	
	2002.09-2010.11	MPV Engine 4HW(DW12ATED4)	•		GWB3649	
	2002.09-2010.11	MPV Engine 4HW(DW12ATED4)		o	GHA230121	K
3.0 V6 (150 kW)	2002.09-2010.11	MPV Engine ES9J4S	•		GWB3649	
	2002.09-2010.11	MPV Engine ES9J4S		o	GHA230121	K
THEMA (834)						
2.0 16V (112 kW)	1992.05-1994.07	Estate Engine 834F1.000	•		GHA425008	
	1992.05-1994.07	Estate Engine 834F1.000	•		GWB1488	



	 YEAR		F	R	G-AP Ref.	KIT
LANCIA						
THEMA (834)						
2.0 16V (112 kW)	1992.05-1994.07	Estate Engine 834F1.000		o	GHA235014	K
	1992.08-1993.12	Saloon Engine 834F1.000	•		GHA425008	
	1992.08-1993.12	Saloon Engine 834F1.000	•		GWB1488	
	1992.08-1993.12	Saloon Engine 834F1.000		o	GHA235014	K
2.0 16V Turbo (148 kW)	1992.10-1994.07	Saloon Engine 834F2.000	•		GHA425008	
	1992.10-1994.07	Saloon Engine 834F2.000	•		GWB1488	
	1992.10-1994.07	Saloon Engine 834F2.000		o	GHA235014	K
2.0 Turbo 16V (148 kW)	1992.11-1994.07	Estate Engine 834F2.000	•		GHA425008	
	1992.11-1994.07	Estate Engine 834F2.000	•		GWB1488	
	1992.11-1994.07	Estate Engine 834F2.000		o	GHA235014	K
	1992.05-1994.07	Saloon Engine 8144.97Y	•	o	GHA425008	K
2.5 Turbo DS (85 kW)	1992.05-1994.07	Saloon Engine 8144.97Y		o	GHA235014	K
	1992.09-1994.07	Estate Engine 8144.97Y	•		GHA425008	
	1992.09-1994.07	Estate Engine 8144.97Y		o	GHA235014	K
	1992.09-1994.07	Estate Engine 8144.97Y		o	GHA235014	K
3.0 V6 (126 kW)	1992.08-1994.07	Saloon Engine 834F.000	•		GWB1488	
	1992.09-1994.07	Estate Engine 834F.000	•		GWB1488	
THEMA (LX)						
3.0 D (140 kW)	2011.09-	Saloon Engine EXF		o	GHA332020	
3.0 D (176 kW)	2011.09-	Saloon Engine EXF		o	GHA332020	
3.6 (210 kW)	2011.09-	Saloon Engine ERB		o	GHA332020	
3.6 4WD (210 kW)	2011.09-	Saloon Engine ERB		o	GHA332020	
THEMIS (841AX)						
2.0 Turbo (136 kW)	2002.07-2009.07	Saloon Engine 841E.000	•		GHA242009	K
2.4 (125 kW)	2002.07-2009.07	Saloon Engine 841D.000	•		GHA242009	K
2.4 D Multijet (136 kW)	2006.04-2009.07	Saloon Engine 841P.000	•		GHA242009	K
2.4 JTD (110 kW)	2002.07-2009.07	Saloon Engine 841C.000	•		GHA242009	K
2.4 JTD (120 kW)	2003.09-2009.07	Saloon Engine 841 M.000 841 N.000	•		GHA242009	K
2.4 JTD (129 kW)	2003.05-2009.07	Saloon Engine 841G.000	•		GHA242009	K
3.0 V6 (158 kW)	2002.07-2009.07	Saloon Engine 841A.000	•		GHA242009	K
3.2 V6 (169 kW)	2003.05-2009.07	Saloon Engine 841L.000	•		GHA242009	K
VOYAGER (RT)						
2.8 CRD (120 kW)	2011.09-	MPV Engine ENS	•		GHA332002	
2.8 CRD (130 kW)	2013.08-	MPV Engine ENS	•		GHA332002	
2.8 CRD (131 kW)	2012.07-	MPV Engine ENS	•		GHA332002	
3.6 V6 VVT (208 kW)	2011.09-	MPV Engine ERB	•		GHA332002	
Y (840A)						
1.1 (40 kW)	1995.11-2003.09	Hatchback Engine 176B2.000	•		GHA422015	
	1995.11-2003.09	Hatchback Engine 176B2.000	•		GWB3414	
	1995.11-2003.09	Hatchback Engine 176B2.000	•		GWB3538	
	1995.11-2003.09	Hatchback Engine 176B2.000		o	GHA230090	K
	1995.11-2003.09	Hatchback Engine 176B2.000 With ABS		o	GHA230046	K
	1995.11-2003.09	Hatchback Engine 176B2.000 Without ABS		o	GHA230044	K
1.2 (44 kW)	1996.03-2003.09	Hatchback Engine 188A4.000/840A3.000	•		GHA422015	
	1996.03-2003.09	Hatchback Engine 188A4.000/840A3.000	•		GWB3414	
	1996.03-2003.09	Hatchback Engine 188A4.000/840A3.000	•		GWB3538	
	1996.03-2003.09	Hatchback Engine 188A4.000/840A3.000		o	GHA230090	K
	1996.03-2003.09	Hatchback Engine 188A4.000/840A3.000 With ABS		o	GHA230046	K
	1996.03-2003.09	Hatchback Engine 188A4.000/840A3.000 Without ABS		o	GHA230044	K
1.2 16V (59 kW)	2000.10-2003.09	Hatchback Engine 188A5.000	•		GHA422015	
	2000.10-2003.09	Hatchback Engine 188A5.000	•		GWB3414	
	2000.10-2003.09	Hatchback Engine 188A5.000	•		GWB3538	
	2000.10-2003.09	Hatchback Engine 188A5.000 With ABS		o	GHA230046	K
	2000.10-2003.09	Hatchback Engine 188A5.000 Without ABS		o	GHA230044	K
	1997.04-2003.09	Hatchback Engine 176B9.000	•		GHA422015	
1.2 16V (63 kW)	1997.04-2003.09	Hatchback Engine 176B9.000	•		GWB3414	
	1997.04-2003.09	Hatchback Engine 176B9.000	•		GWB3538	
	1997.04-2003.09	Hatchback Engine 176B9.000		o	GHA230090	K
	1997.04-2003.09	Hatchback Engine 176B9.000 With ABS		o	GHA230046	K
	1997.04-2003.09	Hatchback Engine 176B9.000 Without ABS		o	GHA230044	K
	1996.03-2003.09	Hatchback Engine 840A4.000	•		GHA422015	
1.4 12V (55 kW)	1996.03-2003.09	Hatchback Engine 840A4.000	•		GWB3414	
	1996.03-2003.09	Hatchback Engine 840A4.000	•		GWB3538	
	1996.03-2003.09	Hatchback Engine 840A4.000		o	GHA230090	K
	1996.03-2003.09	Hatchback Engine 840A4.000		o	GHA230090	K



	 YEAR		F	R	G-AP Ref.	KIT
LANCIA						
Y (840A)						
1.4 12V (55 kW)	1996.03-2003.09	Hatchback Engine 840A4.000 With ABS		o	GHA230046	K
	1996.03-2003.09	Hatchback Engine 840A4.000 Without ABS		o	GHA230044	K
1.4 12V (59 kW)	1996.10-2003.09	Hatchback Engine 840A2.000	•		GHA422015	
	1996.10-2003.09	Hatchback Engine 840A2.000	•		GWB3414	
	1996.10-2003.09	Hatchback Engine 840A2.000	•		GWB3538	
	1996.10-2003.09	Hatchback Engine 840A2.000		o	GHA230090	K
	1996.10-2003.09	Hatchback Engine 840A2.000 With ABS		o	GHA230046	K
	1996.10-2003.09	Hatchback Engine 840A2.000 Without ABS		o	GHA230044	K
Y10 (156)						
1.1 Avenue (40 kW)	1995.01-1995.12	Hatchback Engine 176B2.000	•		GHA320001	K
	1995.01-1995.12	Hatchback Engine 176B2.000	•		GHA320001	K
	1995.01-1995.12	Hatchback Engine 176B2.000		o	GHA230002	S
1.1 i.e. Fire (37 kW)	1992.09-1995.12	Hatchback Engine 156C.046	•		GHA320001	K
YPSILON (843)						
1.2 (44 kW)	2003.10-2011.12	Hatchback Engine 188A4.000	•		GHA422015	
	2003.10-2011.12	Hatchback Engine 188A4.000	•		GWB3538	
	2003.10-2011.12	Hatchback Engine 188A4.000 With ABS		o	GHA230046	K
1.2 (51 kW)	2010.08-2011.12	Hatchback Engine 169A4.000	•		GWB3538	
	2010.08-2011.12	Hatchback Engine 169A4.000 With ABS		o	GHA230046	K
1.2 (59 kW)	2003.10-2011.12	Hatchback Engine 188A5.000	•		GHA422015	
	2003.10-2011.12	Hatchback Engine 188A5.000	•		GWB3538	
	2003.10-2011.12	Hatchback Engine 188A5.000 With ABS		o	GHA230046	K
	2003.10-2011.12	Hatchback Engine 188A5.000 With ABS		o	GHA230046	K
1.3 D Multijet (55 kW)	2006.09-2011.12	Hatchback Engine 199A2.000	•		GHA425008	
	2006.09-2011.12	Hatchback Engine 199A2.000	•		GWB3539	
	2006.09-2011.12	Hatchback Engine 199A2.000	•		GWB6540	
	2006.09-2011.12	Hatchback Engine 199A2.000 With ABS		o	GHA230046	K
1.3 D Multijet (66 kW)	2006.09-2011.12	Hatchback Engine 199A3.000	•		GHA425008	
	2006.09-2011.12	Hatchback Engine 199A3.000	•		GWB3539	
	2006.09-2011.12	Hatchback Engine 199A3.000	•		GWB6540	
	2006.09-2011.12	Hatchback Engine 199A3.000 With ABS		o	GHA230046	K
1.3 D Multijet (77 kW)	2007.05-2011.12	Hatchback Engine 199A3.000	•		GHA425008	
	2007.05-2011.12	Hatchback Engine 199A3.000	•		GWB3539	
	2007.05-2011.12	Hatchback Engine 199A3.000	•		GWB6540	
	2007.05-2011.12	Hatchback Engine 199A3.000 With ABS		o	GHA230046	K
1.3 JTD (51 kW)	2003.10-2011.12	Hatchback Engine 188A9.000	•		GHA425008	
	2003.10-2011.12	Hatchback Engine 188A9.000	•		GWB3539	
	2003.10-2011.12	Hatchback Engine 188A9.000	•		GWB6540	
	2003.10-2011.12	Hatchback Engine 188A9.000 With ABS		o	GHA230046	K
1.4 (57 kW)	2006.02-2011.12	Hatchback Engine 350A1.000	•		GHA422015	
	2006.02-2011.12	Hatchback Engine 350A1.000	•		GWB3538	
	2006.02-2011.12	Hatchback Engine 350A1.000 With ABS		o	GHA230046	K
1.4 16V (70 kW)	2003.10-2011.12	Hatchback Engine 843A1.000	•		GHA422015	
	2003.10-2011.12	Hatchback Engine 843A1.000	•		GWB3538	
	2003.10-2011.12	Hatchback Engine 843A1.000 With ABS		o	GHA230046	K
1.4 LPG (57 kW)	2010.11-2011.12	Hatchback Engine 350A1.000	•		GHA422015	
	2010.11-2011.12	Hatchback Engine 350A1.000	•		GWB3538	
	2010.11-2011.12	Hatchback Engine 350A1.000 With ABS		o	GHA230046	K
YPSILON (846)						
0.9 Twinair (63 kW)	2011.05-	Hatchback Engine 312A2.000	•		GWB3539	
	2011.05-	Hatchback Engine 312A2.000	•		GWB6540	
	2011.05-	Hatchback Engine 312A2.000 With ABS		o	GHA230046	K
1.2 (51 kW)	2011.05-	Hatchback Engine 169A4.000	•		GWB3577	
	2011.05-	Hatchback Engine 169A4.000 With ABS		o	GHA230046	K
1.2 Bifuel (49 kW)	2011.05-	Hatchback Engine 169A4.000	•		GWB3577	
	2011.05-	Hatchback Engine 169A4.000 With ABS		o	GHA230046	K
1.3 Multijet (70 kW)	2011.05-	Hatchback Engine 199B1.000	•		GWB3539	
	2011.05-	Hatchback Engine 199B1.000	•		GWB6540	
	2011.05-	Hatchback Engine 199B1.000 With ABS		o	GHA230046	K
ZETA (220)						
2.0 16V (100 kW)	2000.07-2002.09	MPV Engine RFN	•		GWB3423	
	2000.07-2002.09	MPV Engine RFN		o	GHA230111	K
2.0 16V (97 kW)	1998.05-2000.07	MPV Engine RFV	•		GWB3423	
	1998.05-2000.07	MPV Engine RFV		o	GHA230111	K



	 YEAR		F	R	G-AP Ref.	KIT
LANCIA						
ZETA (220)						
2.0 JTD (80 kW)	1999.09-2002.09	MPV Engine RHW	•		GWB3423	
	1999.09-2002.09	MPV Engine RHW		◦	GHA230111	K
2.0 Turbo (108 kW)	1995.05-2002.09	MPV Engine RGX	•		GWB3423	
	1995.05-2002.09	MPV Engine RGX		◦	GHA230111	K
2.1 TD (80 kW)	1996.05-1999.09	MPV Engine P8C	•		GWB3423	
	1996.05-1999.09	MPV Engine P8C		◦	GHA230111	K
LAND ROVER						
LR3						
-	2005-2009		•		GHA329002	K
LR4						
-	2010-2013		•		GHA329002	K
RANGE ROVER SPORT						
-	2006-2013		•		GHA329002	K
DEFENDER (LD_)						
2.2 TD4 4x4 (90 kW)	2011.08-	Pickup	•		GWB3420	
	2011.08-	Platform/Chassis	•		GWB3420	
2.4 TD4 4x4 (90 kW)	2007.05-	Pickup Engine 244DT	•		GWB3420	
2.5 TD5 4x4 (90 kW)	1998.06-	Pickup Engine 10P	•		GWB3420	
2.8 4x4 (140 kW)	1998.11-2003.09	Pickup Engine M52 B28	•		GWB3420	
4.0 4x4 (134 kW)	1998.04-2000.09	Pickup Engine 37 L	•		GWB3420	
DEFENDER CABRIO (LD)						
2.2 TD4 4x4 (90 kW)	2011.08-	Open Off-Road Vehicle	•		GWB3420	
2.4 TD4 4x4 (90 kW)	2007.05-	Open Off-Road Vehicle Engine 244DT	•		GWB3420	
2.5 90 TDi 4x4 (83 kW)	1990.09-	Open Off-Road Vehicle Engine 11L/16L/23L	•		GWB3420	
	1990.09-	Open Off-Road Vehicle Engine 11L/16L/23L		◦	GWB3421	
2.5 D 4x4 (51 kW)	1990.09-2001.09	Open Off-Road Vehicle Engine 12J	•		GWB3420	
	1990.09-2001.09	Open Off-Road Vehicle Engine 12J		◦	GWB3421	
2.5 TD5 4x4 (90 kW)	1998.06-	Open Off-Road Vehicle Engine 10P/14P/15P	•		GWB3420	
3.5 4x4 (100 kW)	1990.09-1998.12	Open Off-Road Vehicle	•		GWB3420	
	1990.09-1998.12	Open Off-Road Vehicle		◦	GWB3421	
3.9 4x4 (134 kW)	1998.04-2000.09	Open Off-Road Vehicle Engine 37 L	•		GWB3420	
DEFENDER STATION WAGON (LD)						
2.2 TD4 4x4 (90 kW)	2011.08-	Closed Off-Road Vehicle	•		GWB3420	
2.4 TD4 4x4 (90 kW)	2007.05-	Closed Off-Road Vehicle Engine 244DT	•		GWB3420	
2.5 4x4 (61 kW)	1990.09-1994.12	Closed Off-Road Vehicle Engine 17H	•		GWB3420	
	1990.09-1994.12	Closed Off-Road Vehicle Engine 17H		◦	GWB3421	
2.5 90,110 TDi 4x4 (83 kW)	1990.09-1998.12	Closed Off-Road Vehicle Engine 11L/16L/23L	•		GWB3420	
	1990.09-1998.12	Closed Off-Road Vehicle Engine 11L/16L/23L		◦	GWB3421	
2.5 D 4x4 (51 kW)	1990.09-2001.09	Closed Off-Road Vehicle Engine 12J	•		GWB3420	
	1990.09-2001.09	Closed Off-Road Vehicle Engine 12J		◦	GWB3421	
2.5 TD5 4x4 (90 kW)	1998.06-	Closed Off-Road Vehicle Engine 10P/15P	•		GWB3420	
3.5 4x4 (100 kW)	1990.09-1998.12	Closed Off-Road Vehicle Engine 22D	•		GWB3420	
	1990.09-1998.12	Closed Off-Road Vehicle Engine 22D		◦	GWB3421	
3.5 4x4 (86 kW)	1990.09-1993.08	Closed Off-Road Vehicle Engine 11D	•		GWB3420	
	1990.09-1993.08	Closed Off-Road Vehicle Engine 11D		◦	GWB3421	
3.9 4x4 (134 kW)	1998.04-2000.09	Closed Off-Road Vehicle Engine 37 L	•		GWB3420	
3.9 V8 4x4 (136 kW)	1998.11-	Closed Off-Road Vehicle Engine 37L	•		GWB3420	
DISCOVERY (LJ, LG)						
2.0 16V 4x4 (99 kW)	1993.09-1998.10	Closed Off-Road Vehicle	•		GWB3420	
2.5 D 4x4 (90 kW)	1994.07-1998.10	Closed Off-Road Vehicle Engine 22L/19L	•		GWB3420	
3.9 V8 4x4 (134 kW)	1993.09-1998.10	Closed Off-Road Vehicle Engine 35D/36D	•		GWB3420	
DISCOVERY II (LJ, LT)						
2.5 TD5 4x4 (102 kW)	1999.01-2004.06	Closed Off-Road Vehicle Engine 10P	•		GHA245022	K
	1999.01-2004.06	Closed Off-Road Vehicle Engine 10P	•		GHA324009	
	1999.01-2004.06	Closed Off-Road Vehicle Engine 10P		◦	GHA324008	
4.0 V8 4x4 (136 kW)	1998.11-2004.06	Closed Off-Road Vehicle Engine 56D	•		GHA245022	K
	1998.11-2004.06	Closed Off-Road Vehicle Engine 56D	•		GHA324009	
	1998.11-2004.06	Closed Off-Road Vehicle Engine 56D		◦	GHA324008	
DISCOVERY III (TAA)						
2.7 TD 4x4 (140 kW)	2004.07-2009.09	Closed Off-Road Vehicle Engine 276DT	•		GHA329018	K
4.0 4x4 (160 kW)	2005.02-2009.09	Closed Off-Road Vehicle	•		GHA329018	K
4.0 4x4 (161 kW)	2005.02-2009.09	Closed Off-Road Vehicle	•		GHA329018	K



	 YEAR		F	R	G-AP Ref.	KIT
LAND ROVER						
DISCOVERY III (TAA)						
4.0 V6 4x4 (160 kW)	2004.10-2009.09	Closed Off-Road Vehicle Engine 406PN	•		GHA329018	K
4.4 4x4 (220 kW)	2004.07-2009.09	Closed Off-Road Vehicle Engine 448PN	•		GHA329018	K
DISCOVERY IV (LA)						
2.7 TD 4x4 (140 kW)	2009.09-	Closed Off-Road Vehicle Engine 276DT	•		GHA329018	K
3.0 4x4 (250 kW)	2013.08-	Closed Off-Road Vehicle Engine 306PS/30HD0D	•		GHA329018	K
3.0 SD V6 4x4 (188 kW)	2009.11-	Closed Off-Road Vehicle Engine 30DDTX	•		GHA329018	K
3.0 TD 4x4 (155 kW)	2010.05-	Closed Off-Road Vehicle Engine 30DDTX/306DT	•		GHA329018	K
3.0 TD 4x4 (180 kW)	2009.09-	Closed Off-Road Vehicle Engine 306DT	•		GHA329018	K
3.0 TD 4x4 (183 kW)	2012.07-	Closed Off-Road Vehicle Engine 306DT	•		GHA329018	K
3.0 TD 4x4 (200 kW)	2009.09-	Closed Off-Road Vehicle Engine 30DDTX	•		GHA329018	K
4.0 4x4 (160 kW)	2009.09-	Closed Off-Road Vehicle	•		GHA329018	K
5.0 V8 4x4 (276 kW)	2009.09-	Closed Off-Road Vehicle Engine 508PN	•		GHA329018	K
FREELANDER (LN)						
1.8 16V 4x4 (86 kW)	2000.11-2006.10	Closed Off-Road Vehicle Engine 18K4F	•		GWB3527	
	2000.11-2006.10	Closed Off-Road Vehicle Engine 18K4F	•		GWB3603	
1.8 i 16V 4x4 (88 kW)	1998.02-2000.11	Closed Off-Road Vehicle Engine 18K4F	•		GWB3527	
2.0 Di 4x4 (72 kW)	1998.02-2000.11	Closed Off-Road Vehicle Engine 20T2N	•		GWB3527	
2.0 TD4 4x4 (80 kW)	2001.03-2006.10	Closed Off-Road Vehicle Engine M47/204D3	•		GWB3603	
2.0 TD4 4x4 (82 kW)	2000.11-2006.10	Closed Off-Road Vehicle Engine 204D3/M47	•		GWB3527	
	2000.11-2006.10	Closed Off-Road Vehicle Engine 204D3/M47	•		GWB3603	
2.5 V6 4x4 (130 kW)	2000.11-2006.10	Closed Off-Road Vehicle Engine 25K4F	•		GWB3527	
	2000.11-2006.10	Closed Off-Road Vehicle Engine 25K4F	•		GWB3603	
	2000.11-2006.10	Closed Off-Road Vehicle Engine 25K4F		o	GHA428026	
FREELANDER 2 (FA_)						
2.0 Si4 4x4 (177 kW)	2011.10-2014.10	Closed Off-Road Vehicle Engine 204PT	•		GHA340005	K
2.2 ED4 (110 kW)	2010.08-	Closed Off-Road Vehicle Engine 224DT/DW12BTED4	•		GHA340005	K
	2010.08-	Closed Off-Road Vehicle Engine 224DT/DW12BTED4		o	GWB3603	
2.2 SD4 4x4 (140 kW)	2010.08-	Closed Off-Road Vehicle Engine 224DT	•		GHA340005	K
	2010.08-	Closed Off-Road Vehicle Engine 224DT		o	GWB3603	
2.2 TD4 4x4 (110 kW)	2006.10-	Closed Off-Road Vehicle Engine 224DT/DW12BTED4	•		GHA340005	K
	2006.10-	Closed Off-Road Vehicle Engine 224DT/DW12BTED4		o	GWB3603	
2.2 TD4 4x4 (112 kW)	2007.01-	Closed Off-Road Vehicle Engine 224DT	•		GHA340005	K
	2007.01-	Closed Off-Road Vehicle Engine 224DT		o	GWB3603	
2.2 TD4 4x4 (115 kW)	2006.10-	Closed Off-Road Vehicle Engine 224DT	•		GHA340005	K
	2006.10-	Closed Off-Road Vehicle Engine 224DT		o	GWB3603	
2.2 TD4 4x4 (118 kW)	2006.10-	Closed Off-Road Vehicle Engine 224DT	•		GHA340005	K
	2006.10-	Closed Off-Road Vehicle Engine 224DT		o	GWB3603	
3.2 4x4 (171 kW)	2006.10-	Closed Off-Road Vehicle Engine B6324S	•		GHA340005	K
	2006.10-	Closed Off-Road Vehicle Engine B6324S		o	GWB3603	
FREELANDER SOFT TOP						
1.8 i 16V 4x4 (88 kW)	1998.02-2006.10	Open Off-Road Vehicle Engine 18K4F	•		GWB3527	
	1998.02-2006.10	Open Off-Road Vehicle Engine 18K4F	•		GWB3603	
2.0 Di 4x4 (72 kW)	1998.02-2006.10	Open Off-Road Vehicle Engine 20T2N	•		GWB3527	
	1998.02-2006.10	Open Off-Road Vehicle Engine 20T2N	•		GWB3603	
RANGE ROVER (AE, AN, HAA, HAB, HAM, HBM, RE, RN)						
2.5 TDi 4x4 (83 kW)	1991.09-1994.04	Closed Off-Road Vehicle Engine 14L	•		GHA324005	
	1991.09-1994.04	Closed Off-Road Vehicle Engine 14L	•		GHA324006	
	1991.09-1994.04	Closed Off-Road Vehicle Engine 14L	•		GWB3420	
	1991.09-1994.04	Closed Off-Road Vehicle Engine 14L	•		GWB3421	
4.3 Vogue LSE 4x4 (149 kW)	1992.09-1994.07	Closed Off-Road Vehicle Engine 40D	•		GWB3420	
	1992.09-1994.07	Closed Off-Road Vehicle Engine 40D	•		GWB3421	
RANGE ROVER II (LP)						
3.9 4x4 (140 kW)	1994.07-2002.03	Closed Off-Road Vehicle Engine 42D		o	GHA324007	
4.6 4x4 (160 kW)	1998.06-2002.03	Closed Off-Road Vehicle Engine 60D	•		GHA324005	
	1998.06-2002.03	Closed Off-Road Vehicle Engine 60D	•		GHA324006	
	1998.06-2002.03	Closed Off-Road Vehicle Engine 60D		o	GHA324007	
4.6 4x4 (165 kW)	1994.07-2002.03	Closed Off-Road Vehicle Engine 46D	•		GHA324005	
	1994.07-2002.03	Closed Off-Road Vehicle Engine 46D	•		GHA324006	
	1994.07-2002.03	Closed Off-Road Vehicle Engine 46D		o	GHA324007	
RANGE ROVER SPORT (LS)						
2.7 TDVM 4x4 (140 kW)	2005.02-	Closed Off-Road Vehicle Engine 276DT	•		GHA329018	K
3.0 TD 4x4 (180 kW)	2009.09-	Closed Off-Road Vehicle Engine 30DDTX	•		GHA329018	K
3.0 TD 4x4 (188 kW)	2011.06-	Closed Off-Road Vehicle Engine 30DDTX	•		GHA329018	K



	 YEAR		F	R	G-AP Ref.	KIT
LAND ROVER						
RANGE ROVER SPORT (LS)						
3.0 TD V6 4x4 (155 kW)	2010.05-	Closed Off-Road Vehicle Engine 30DDTX	•		GHA329018	K
3.6 TD 8 4x4 (200 kW)	2006.04-	Closed Off-Road Vehicle Engine 368DT	•		GHA329018	K
4.2 4x4 (287 kW)	2005.02-	Closed Off-Road Vehicle Engine 428PS	•		GHA329018	K
4.4 4x4 (220 kW)	2005.02-	Closed Off-Road Vehicle Engine 448PN	•		GHA329018	K
	2005.02-	Closed Off-Road Vehicle Engine 448PN		○	GHA431005	
5.0 V8 4x4 (276 kW)	2009.07-	Closed Off-Road Vehicle Engine 508PN	•		GHA329018	K
	2009.07-	Closed Off-Road Vehicle Engine 508PN		○	GHA431005	
5.0 V8 4x4 (372 kW)	2009.04-	Closed Off-Road Vehicle Engine 508PS	•		GHA329018	K
5.0 V8 4x4 (375 kW)	2009.09-	Closed Off-Road Vehicle Engine 508PS	•		GHA329018	K
	2009.09-	Closed Off-Road Vehicle Engine 508PS		○	GHA431005	
RANGE ROVER SPORT (LW)						
3.0 4x4 (250 kW)	2013.04-	Closed Off-Road Vehicle Engine 30HD0D		○	GHA431005	
5.0 4x4 (375 kW)	2013.04-	Closed Off-Road Vehicle Engine 508PS		○	GHA431005	
LEXUS						
CT (ZWA1_)						
200h (73kW)	2010.12-		•		GHA326039	
	2010.12-			○	GHA400351	
ES (AVV6_, GSV6_, ASV6_)						
250 (135 kW)	2012.06-	Saloon Engine 2AR-FE	•		GHA426026	
	2012.06-	Saloon Engine 2AR-FE	•		GWB3946	
300h (118 kW)	2012.06-	Saloon Engine 2AR-FXE	•		GHA430005	K
	2012.06-	Saloon Engine 2AR-FXE	•		GWB3946	
350 (204 kW)	2012.06-	Saloon Engine 2GR-FE	•		GHA430005	K
	2012.06-	Saloon Engine 2GR-FE	•		GWB3946	
ES (GSV4_, ACV4_)						
3.5 (204 kW)	2006.05-2012.06	Saloon Engine 2GR-FE	•		GHA430005	K
ES (MCV_, VZV_)						
3.0 (140 kW)	1996.10-2001.07	Saloon Engine 1MZ-FE	•		GHA430001	K
3.0 (157 kW)	2001.08-2006.10	Saloon Engine 1MZ-FE	•		GHA430001	K
	2001.08-2006.10	Saloon Engine 1MZ-FE	•		GHA430005	K
3.3 (168 kW)	2003.06-2006.1	Saloon Engine 3MZ-FE	•		GHA430005	K
GS (GRL1_, GWL1_)						
250 (154 kW)	2012.01-		•		GHA400282	
	2012.01-			○	GHA330046	
300h (133 kW)	2013.10-	Saloon Engine 2AR-FSE	•		GHA400282	
350 AWD (234 kW)	2012.01-	Saloon Engine 2GR-FSE	•		GHA330044	
	2012.01-	Saloon Engine 2GR-FSE	•		GHA330045	
450h (215 kW)	2012.01-		•		GHA400282	
	2012.01-			○	GHA330046	
GS (GRS19_, UZS19_, GWS19_)						
300 (170 kW)	2005.04-2011.11	Saloon Engine 3GR-FE	•		GHA400210	
	2005.04-2011.11	Saloon Engine 3GR-FE	•		GHA400237	
	2005.04-2011.11	Saloon Engine 3GR-FE		○	GHA330029	
300 (183 kW)	2005.04-2011.11	Saloon Engine 3GR-FSE	•		GHA400210	
	2005.04-2011.11	Saloon Engine 3GR-FSE	•		GHA400237	
	2005.04-2011.11	Saloon Engine 3GR-FSE		○	GHA330029	
350 AWD (226 kW)	2008.04-2011.11	Saloon Engine 2GR-FSE	•		GHA330044	
	2008.04-2011.11	Saloon Engine 2GR-FSE	•		GHA330045	
	2008.04-2011.11	Saloon Engine 2GR-FSE		○	GHA330029	
430 (208 kW)	2005.04-2011.11	Saloon Engine 3UZ-FE	•		GHA400210	
	2005.04-2011.11	Saloon Engine 3UZ-FE	•		GHA400237	
	2005.04-2011.11	Saloon Engine 3UZ-FE		○	GHA330029	
450h (218 kW)	2006.03-2007.12	Saloon Engine 2GR-FSE	•		GHA400210	
	2006.03-2007.12	Saloon Engine 2GR-FSE	•		GHA400237	
	2006.03-2007.12	Saloon Engine 2GR-FSE		○	GHA330029	
450h (254 kW)	2006.02-2011.11	Saloon Engine 2GR-FSE	•		GHA400210	
	2006.02-2011.11	Saloon Engine 2GR-FSE	•		GHA400237	
	2006.02-2011.11	Saloon Engine 2GR-FSE		○	GHA330029	
460 (255 kW)	2008.05-2011.11	Saloon Engine 1UR-FSE	•		GHA400210	
	2008.05-2011.11	Saloon Engine 1UR-FSE	•		GHA400237	
	2008.05-2011.11	Saloon Engine 1UR-FSE		○	GHA330029	



	 YEAR		F	R	G-AP Ref.	KIT
LEXUS						
GX (URJ15_)						
460 (218 kW)	2009.11-	Closed Off-Road Vehicle Engine 1UR-FE	•		GHA430008	
	2009.11-	Closed Off-Road Vehicle Engine 1UR-FE		◦	GHA244003	K
	2009.11-	Closed Off-Road Vehicle Engine 1UR-FE With ABS	•		GHA254003	K
	2009.11-	Closed Off-Road Vehicle Engine 1UR-FE With ABS		◦	GHA244004	K
460 (225 kW)	2010.01-	Closed Off-Road Vehicle Engine 1UR-FE	•		GHA430008	
	2010.01-	Closed Off-Road Vehicle Engine 1UR-FE		◦	GHA244003	K
	2010.01-	Closed Off-Road Vehicle Engine 1UR-FE With ABS	•		GHA254003	K
	2010.01-	Closed Off-Road Vehicle Engine 1UR-FE With ABS		◦	GHA244004	K
IS C (GSE2_)						
250 (153 kW)	2009.04-	Convertible Engine 4GR-FSE	•		GHA400210	
	2009.04-	Convertible Engine 4GR-FSE	•		GHA400237	
	2009.04-	Convertible Engine 4GR-FSE		◦	GHA330029	
IS I (JCE1_, GXE1_)						
200 (114 kW)	1999.04-2005.07	Saloon Engine 1G-FE	•		GHA499084	
300 (157 kW)	2001.09-2005.07	Saloon Engine 2JZ-GE	•		GHA499084	
IS II (GSE2_, ALE2_, USE2_)						
200 D (110 kW)	2010.07-	Saloon Engine 2AD-FTV	•		GHA400210	
	2010.07-	Saloon Engine 2AD-FTV	•		GHA400237	
	2010.07-	Saloon Engine 2AD-FTV		◦	GHA330029	
220 D (130 kW)	2006.01-	Saloon Engine 2AD-FHV	•		GHA400210	
	2006.01-	Saloon Engine 2AD-FHV	•		GHA400237	
	2006.01-	Saloon Engine 2AD-FHV		◦	GHA330029	
250 (152 kW)	2010.09-	Saloon Engine 4GR-FSE	•		GHA400210	
	2010.09-	Saloon Engine 4GR-FSE	•		GHA400237	
	2010.09-	Saloon Engine 4GR-FSE		◦	GHA330029	
250 (153 kW)	2005.10-	Saloon Engine 4GR-FSE	•		GHA400210	
	2005.10-	Saloon Engine 4GR-FSE	•		GHA400237	
	2005.10-	Saloon Engine 4GR-FSE		◦	GHA330029	
250 (158 kW)	2010.11-	Saloon Engine 4GR-FSE	•		GHA400210	
	2010.11-	Saloon Engine 4GR-FSE	•		GHA400237	
	2010.11-	Saloon Engine 4GR-FSE		◦	GHA330029	
250 AWD (153 kW)	2005.10-	Saloon Engine 4GR-FSE	•		GHA330044	
	2005.10-	Saloon Engine 4GR-FSE	•		GHA330045	
250 AWD (158 kW)	2010.11-	Saloon Engine 4GR-FSE	•		GHA330044	
	2010.11-	Saloon Engine 4GR-FSE	•		GHA330045	
350 (228 kW)	2005.10-	Saloon Engine 2GR-FSE	•		GHA400210	
	2005.10-	Saloon Engine 2GR-FSE	•		GHA400237	
	2005.10-	Saloon Engine 2GR-FSE		◦	GHA330029	
350 (234 kW)	2010.09-	Saloon Engine 2GR-FSE	•		GHA400210	
	2010.09-	Saloon Engine 2GR-FSE	•		GHA400237	
	2010.09-	Saloon Engine 2GR-FSE		◦	GHA330029	
350 AWD (228 kW)	2005.10-	Saloon Engine 2GR-FSE	•		GHA330044	
	2005.10-	Saloon Engine 2GR-FSE	•		GHA330045	
5.0 IS F (311 kW)	2008.01-	Saloon Engine 2UR-GSE	•		GHA333027	
	2008.01-	Saloon Engine 2UR-GSE		◦	GHA330029	
IS III (GSE3_, AVE3_)						
250 (153 kW)	2013.04-			◦	GHA330046	
300h (133 kW)	2013.04-			◦	GHA330046	
LS (UCF30)						
430 (95 kW)	2000.10-2006.08		•		GHA400292	
	2000.10-2006.08			◦	GHA330020	K
	2000.10-2006.08			◦	GHA330037	
430 (208 kW)	2000.10-2006.08	Saloon Engine 3UZ-FE	•		GHA400292	
LX (URJ201)						
570 (270 kW)	2007.11-	Closed Off-Road Vehicle Engine 3UR-FE	•		GHA258001	
	2007.11-	Closed Off-Road Vehicle Engine 3UR-FE	•		GHA436007	
	2007.11-	Closed Off-Road Vehicle Engine 3UR-FE		◦	GHA249003	
	2007.11-	Closed Off-Road Vehicle Engine 3UR-FE		◦	GHA249004	
570 (282 kW)	2007.11-	Closed Off-Road Vehicle Engine 3UR-FE	•		GHA258001	
	2007.11-	Closed Off-Road Vehicle Engine 3UR-FE	•		GHA436007	
	2007.11-	Closed Off-Road Vehicle Engine 3UR-FE		◦	GHA249003	
	2007.11-	Closed Off-Road Vehicle Engine 3UR-FE		◦	GHA249004	
570 (286 kW)	2009.09-	Closed Off-Road Vehicle Engine 3UR-FE	•		GHA258001	



	 YEAR		F	R	G-AP Ref.	KIT
LEXUS						
LX (URJ201)						
570 (286 kW)	2009.09-	Closed Off-Road Vehicle Engine 3UR-FE	•		GHA436007	
	2009.09-	Closed Off-Road Vehicle Engine 3UR-FE		○	GHA249003	
	2009.09-	Closed Off-Road Vehicle Engine 3UR-FE		○	GHA249004	
NX (ZGZ1_, AGZ1_, AYZ1_)						
200t (175 kW)	2014.07-	Hatchback Engine 8AR-FTS		○	GHA400238	
200t AWD (175 kW)	2014.07-	Hatchback Engine 8AR-FTS		○	GHA326030	K
300h (114 kW)	2014.07-	Hatchback Engine 2AR-FXE		○	GHA400238	
300h AWD (114 kW)	2014.07-	Hatchback Engine 2AR-FXE		○	GHA326030	K
RX (GGL1_, GYL1_, AGL1_)						
270 (138 kW)	2008.12-2015.1	Closed Off-Road Vehicle Engine 1AR-FE	•		GHA430005	K
	2008.12-2015.1	Closed Off-Road Vehicle Engine 1AR-FE		○	GHA400360	
350 AWD (206 kW)	2008.12-2015.1	Closed Off-Road Vehicle Engine 2GR-FE	•		GHA430005	K
	2008.12-2015.1	Closed Off-Road Vehicle Engine 2GR-FE		○	GHA326032	K
450h (220 kW)	2008.12-2015.1	Closed Off-Road Vehicle Engine 2GR-FE/2G-FXE	•		GHA430005	K
	2008.12-2015.1	Closed Off-Road Vehicle Engine 2GR-FE/2G-FXE		○	GHA400360	
RX (GYL1_, GGL15, AGL10)						
350 AWD (204 kW)	2008.12-	Closed Off-Road Vehicle Engine 2GR-FE	•		GHA430005	K
	2008.12-	Closed Off-Road Vehicle Engine 2GR-FE		○	GHA326032	K
350h AWD (220 kW)	2012.04-	Closed Off-Road Vehicle Engine 2GR-FXE	•		GHA430005	K
	2012.04-	Closed Off-Road Vehicle Engine 2GR-FXE		○	GHA326032	K
450h (183 kW)	2008.12-	Closed Off-Road Vehicle Engine 2GR-FXE	•		GHA430005	K
	2008.12-	Closed Off-Road Vehicle Engine 2GR-FXE		○	GHA400360	
450h AWD (183 kW)	2008.12-	Closed Off-Road Vehicle Engine 2GR-FXE	•		GHA430005	K
	2008.12-	Closed Off-Road Vehicle Engine 2GR-FXE		○	GHA326032	K
RX (MCU15)						
300 AWD (164 kW)	2000.07-2003.05	Closed Off-Road Vehicle Engine 1MZ-FE	•		GHA426015	K
	2000.07-2003.05	Closed Off-Road Vehicle Engine 1MZ-FE	•		GWB3945	
	2000.07-2003.05	Closed Off-Road Vehicle Engine 1MZ-FE		○	GHA426052	
300 (148 kW)	2000.07-2003.03	Closed Off-Road Vehicle Engine 1MZ-FE	•		GHA430001	K
	2000.07-2003.03	Closed Off-Road Vehicle Engine 1MZ-FE	•		GWB3945	
300 AWD (148 kW)	2000.10-2003.05	Closed Off-Road Vehicle Engine 1MZ-FE	•		GHA426015	K
	2000.10-2003.05	Closed Off-Road Vehicle Engine 1MZ-FE	•		GWB3945	
	2000.10-2003.05	Closed Off-Road Vehicle Engine 1MZ-FE		○	GHA426052	
RX (MHU3_, GSU3_, MCU3_)						
3.3 AWD (171 kW)	2003.04-2008.12	Closed Off-Road Vehicle Engine 3MZ-FE	•		GHA430005	K
	2003.04-2008.12	Closed Off-Road Vehicle Engine 3MZ-FE	•		GWB3946	
	2003.04-2008.12	Closed Off-Road Vehicle Engine 3MZ-FE		○	GHA326036	
300 (150 kW)	2003.05-2008.12	Closed Off-Road Vehicle Engine 1MZ-FE	•		GHA426026	
	2003.05-2008.12	Closed Off-Road Vehicle Engine 1MZ-FE	•		GWB3946	
	2003.05-2008.12	Closed Off-Road Vehicle Engine 1MZ-FE		○	GHA326036	
330 (171 kW)	2003.04-2006.01	Closed Off-Road Vehicle Engine 3MZ-FE	•		GHA430005	K
	2003.04-2006.01	Closed Off-Road Vehicle Engine 3MZ-FE	•		GWB3946	
350 (203 kW)	2006.01-2008.12	Closed Off-Road Vehicle Engine 2GR-FE	•		GHA430005	K
	2006.01-2008.12	Closed Off-Road Vehicle Engine 2GR-FE	•		GWB3946	
350 AWD (203 kW)	2006.04-2006.09	Closed Off-Road Vehicle Engine 2GR-FE	•		GHA430005	K
	2006.04-2006.09	Closed Off-Road Vehicle Engine 2GR-FE	•		GWB3946	
	2006.04-2006.09	Closed Off-Road Vehicle Engine 2GR-FE		○	GHA326036	
400h (155 kW)	2005.05-2006.09	Closed Off-Road Vehicle Engine 3MZ-FE	•		GHA430005	K
	2005.05-2006.09	Closed Off-Road Vehicle Engine 3MZ-FE	•		GWB3946	
400h AWD (155 kW)	2007.04-2008.12	Closed Off-Road Vehicle Engine 3MZ-FE	•		GHA430005	K
	2007.04-2008.12	Closed Off-Road Vehicle Engine 3MZ-FE	•		GWB3946	
	2007.04-2008.12	Closed Off-Road Vehicle Engine 3MZ-FE		○	GHA326036	
LINCOLN						
AVIATOR						
-	2003-2005			○	GHA429001	K
MARK LT						
-	2006-2008		•		GHA400173	
NAVIGATOR						
-	2003-2006			○	GHA333091	
5.4 All-wheel Drive (224 kW)	1997.05-2002.12	Closed Off-Road Vehicle	•		GHA333019	
TOWN CAR						
-	2002-1997	With ABS	•		GHA237006	



	 YEAR		F	R	G-AP Ref.	KIT
MAZDA						
121 II (DB)						
1.1 (40 kW)	1990.11-1993.1	Saloon Engine B1	•		GWB1928	
	1990.11-1993.1	Saloon Engine B1		○	GHA228046	K
	1990.11-1993.1	Saloon Engine B1		○	GHA228072	
1.3 16V (39 kW)	1990.11-1996.03	Saloon Engine B3	•		GWB1928	
	1990.11-1996.03	Saloon Engine B3		○	GHA228046	K
	1990.11-1996.03	Saloon Engine B3		○	GHA228072	
1.3 i 16V (53 kW)	1990.11-1996.03	Saloon Engine B3	•		GWB1928	
	1990.11-1996.03	Saloon Engine B3		○	GHA228046	K
	1990.11-1996.03	Saloon Engine B3		○	GHA228072	
121 III (JASM, JBSM)						
1.25 (55 kW)	1996.03-2003.04	Hatchback Engine DHF/DHG		○	GWB1333	
1.3 (37 kW)	1996.03-2003.04	Hatchback Engine JJK/JJM	•		GWB1928	
	1996.03-2003.04	Hatchback Engine JJK/JJM		○	GHA228046	K
	1996.03-2003.04	Hatchback Engine JJK/JJM		○	GWB1333	
1.3 (44 kW)	1996.03-2003.04	Hatchback Engine J4R/J4T	•		GWB1928	
	1996.03-2003.04	Hatchback Engine J4R/J4T		○	GHA228046	K
	1996.03-2003.04	Hatchback Engine J4R/J4T		○	GWB1333	
1.8 D (44 kW)	1996.03-2003.04	Hatchback Engine RTJ/RTK		○	GWB1333	
2 (DE)						
1.3 (55 kW)	2007.10-	Hatchback Engine ZJ-VE	•		GWB6653	
	2007.10-	Hatchback Engine ZJ-VE		○	GHA400110	
1.3 (63 kW)	2007.10-	Hatchback Engine ZJ-VE	•		GWB6653	
	2007.10-	Hatchback Engine ZJ-VE		○	GHA400110	
1.3 MZR (62 kW)	2010.01-	Hatchback Engine ZJ-VE	•		GWB6653	
	2010.01-	Hatchback Engine ZJ-VE		○	GHA400110	
1.4 MZR CD (50 kW)	2008.01-	Hatchback	•		GWB6653	
	2008.01-	Hatchback		○	GHA400110	
1.5 (76 kW)	2007.10-	Hatchback Engine ZY-DE/ZY-VE	•		GWB6653	
	2007.10-	Hatchback Engine ZY-DE/ZY-VE		○	GHA400110	
1.5 MZR (75 kW)	2011.06-	Hatchback	•		GWB6653	
	2011.06-	Hatchback		○	GHA400110	
1.6 MZ-CD (66 kW)	2008.10-	Hatchback	•		GWB6653	
	2008.10-	Hatchback		○	GHA400110	
1.6 MZ-CD (70 kW)	2011.06-2015.06	Hatchback Engine Y655/Y661	•		GWB6653	
	2011.06-2015.06	Hatchback Engine Y655/Y661		○	GHA400110	
2 (DY)						
1.2 (55 kW)	2003.02-	Hatchback Engine FUJA	•		GWB3530	
	2003.02-	Hatchback Engine FUJA	•		GWB3531	
	2003.02-	Hatchback Engine FUJA	•		GWB6856	
	2003.02-	Hatchback Engine FUJA		○	GWB3532	
1.25 (55 kW)	2003.04-	Hatchback Engine FUJA	•		GWB3530	
	2003.04-	Hatchback Engine FUJA	•		GWB3531	
	2003.04-	Hatchback Engine FUJA	•		GWB6856	
	2003.04-	Hatchback Engine FUJA		○	GWB3532	
1.4 (59 kW)	2003.02-	Hatchback Engine FXJA	•		GWB3530	
	2003.02-	Hatchback Engine FXJA	•		GWB3531	
	2003.02-	Hatchback Engine FXJA	•		GWB6856	
	2003.02-	Hatchback Engine FXJA		○	GWB3532	
	2003.04-	Hatchback Engine FXJA	•		GWB3530	
	2003.04-	Hatchback Engine FXJA	•		GWB3531	
	2003.04-	Hatchback Engine FXJA	•		GWB6856	
	2003.04-	Hatchback Engine FXJA		○	GWB3532	
1.4 CD (50 kW)	2003.04-	Hatchback Engine F6JA/F6JB	•		GWB3530	
	2003.04-	Hatchback Engine F6JA/F6JB	•		GWB3531	
	2003.04-	Hatchback Engine F6JA/F6JB	•		GWB6856	
	2003.04-	Hatchback Engine F6JA/F6JB		○	GWB3532	
1.6 (74 kW)	2003.02-	Hatchback Engine FYJA	•		GWB3530	
	2003.02-	Hatchback Engine FYJA	•		GWB3531	
	2003.02-	Hatchback Engine FYJA	•		GWB6856	
	2003.02-	Hatchback Engine FYJA		○	GWB3532	
	2003.04-	Hatchback Engine FYJA	•		GWB3530	
	2003.04-	Hatchback Engine FYJA	•		GWB3531	
	2003.04-	Hatchback Engine FYJA	•		GWB6856	
	2003.04-	Hatchback Engine FYJA		○	GWB3532	



	 YEAR		F	R	G-AP Ref.	KIT
MAZDA						
3 (BK)						
1.4 (59 kW)	2004.02-2009.06	Hatchback Engine FXJA	•		GWB6972	
	2004.02-2009.06	Hatchback Engine FXJA With ABS	•		GHA336008	
	2004.02-2009.06	Hatchback Engine FXJA With ABS		○	GHA400106	
1.4 (62 kW)	2004.01-2008.04	Hatchback Engine ZJ-VE	•		GWB6972	
	2004.01-2008.04	Hatchback Engine ZJ-VE With ABS	•		GHA336008	
	2004.01-2008.04	Hatchback Engine ZJ-VE With ABS		○	GHA400106	
1.6 (77 kW)	2004.01-2008.04	Hatchback Engine B6ZE	•		GWB6972	
	2004.01-2008.04	Hatchback Engine B6ZE	•		GWB7446	
	2004.01-2008.04	Hatchback Engine B6ZE With ABS	•		GHA336008	
	2004.01-2008.04	Hatchback Engine B6ZE With ABS		○	GHA400106	
	2004.01-2008.04	Hatchback Engine B6ZE Without ABS		○	GHA400107	
	2004.01-2008.04	Saloon Engine Z6	•		GWB6972	
	2004.01-2008.04	Saloon Engine Z6	•		GWB7446	
	2004.01-2008.04	Saloon Engine Z6 With ABS	•		GHA336008	
	2004.01-2008.04	Saloon Engine Z6 With ABS		○	GHA400106	
	2004.01-2008.04	Saloon Engine Z6 Without ABS		○	GHA400107	
1.6 Di Turbo (80 kW)	2004.01-2008.04	Hatchback Engine Y601	•		GWB6972	
	2004.01-2008.04	Hatchback Engine Y601 With ABS	•		GHA336008	
	2004.01-2008.04	Hatchback Engine Y601 With ABS		○	GHA400106	
	2004.01-2008.04	Saloon Engine Y601	•		GWB6972	
	2004.01-2008.04	Saloon Engine Y601 With ABS	•		GHA336008	
2.0 (104 kW)	2004.04-2006.06	Saloon Engine LF17	•		GWB6972	
	2004.04-2006.06	Saloon Engine LF17 With ABS	•		GHA336008	
	2004.04-2006.06	Saloon Engine LF17 With ABS		○	GHA400106	
2.0 (110 kW)	2004.01-2008.03	Hatchback Engine LF17	•		GWB6972	
	2004.01-2008.03	Hatchback Engine LF17 With ABS	•		GHA336008	
	2004.01-2008.03	Hatchback Engine LF17 With ABS		○	GHA400106	
	2004.01-2008.03	Saloon Engine LF17	•		GWB6972	
	2004.01-2008.03	Saloon Engine LF17 With ABS	•		GHA336008	
2.0 MZR CD (105 kW)	2006.12-	Saloon Engine RF7J	•		GWB6972	
	2006.12-	Saloon Engine RF7J With ABS		○	GHA400106	
	2006.12-2009.06	Hatchback Engine RF7J	•		GWB6972	
	2006.12-2009.06	Hatchback Engine RF7J With ABS		○	GHA400106	
	2.3 (118 kW)	2004.03-2009.03	Saloon Engine L3-VE	•		GWB6972
2004.03-2009.03		Saloon Engine L3-VE With ABS	•		GHA336008	
2004.03-2009.03		Saloon Engine L3-VE With ABS		○	GHA400106	
2.3 DiSi Turbo MPS (184 kW)	2006.11-2008.04	Hatchback	•		GWB6972	
	2006.11-2008.04	Hatchback With ABS		○	GHA400106	
2.3 MPS (191 kW)	2006.12-2009.06	Hatchback Engine L3N9	•		GWB6972	
	2006.12-2009.06	Hatchback Engine L3N9 With ABS		○	GHA400106	
2.3 MZR (115 kW)	2004.03-2009.03	Hatchback Engine L3-VE	•		GWB6972	
	2004.03-2009.03	Hatchback Engine L3-VE With ABS	•		GHA336008	
	2004.03-2009.03	Hatchback Engine L3-VE With ABS		○	GHA400106	
3 (BL)						
1.6 MZR (77 kW)	2009.06-	Hatchback Engine Z6	•		GWB7536	
	2009.06-	Hatchback Engine Z6	•		GWB7537	
	2009.06-	Hatchback Engine Z6 With ABS		○	GHA400106	
	2009.06-	Saloon Engine Z6	•		GWB7536	
	2009.06-	Saloon Engine Z6	•		GWB7537	
1.6 MZR CD (80 kW)	2009.06-	Saloon Engine Z6 With ABS		○	GHA400106	
	2009.06-	Hatchback Engine Y601	•		GWB7536	
	2009.06-	Hatchback Engine Y601	•		GWB7537	
	2009.06-	Hatchback Engine Y601 With ABS		○	GHA400106	
	2009.06-	Saloon	•		GWB7536	
1.6 MZR CD (85 kW)	2009.06-	Saloon	•		GWB7537	
	2009.06-	Saloon With ABS		○	GHA400106	
	2010.11-	Hatchback	•		GWB7536	
	2010.11-	Hatchback	•		GWB7537	
	2010.11-	Hatchback With ABS		○	GHA400106	
	2010.11-	Saloon	•		GWB7536	
	2010.11-	Saloon	•		GWB7537	
2010.11-	Saloon With ABS		○	GHA400106		



	 YEAR		F	R	G-AP Ref.	KIT
MAZDA						
3 (BL)						
2.0 MZR (110 kW)	2009.06-	Hatchback Engine LF17/LF-DE	•		GWB7536	
	2009.06-	Hatchback Engine LF17/LF-DE	•		GWB7537	
	2009.06-	Hatchback Engine LF17/LF-DE With ABS		○	GHA400106	
	2009.06-	Saloon Engine LF17/LF-DE	•		GWB7536	
	2009.06-	Saloon Engine LF17/LF-DE	•		GWB7537	
	2009.06-	Saloon Engine LF17/LF-DE With ABS		○	GHA400106	
2.0 MZR DiSi (111 kW)	2009.06-	Hatchback Engine LF5H/LF5W	•		GWB7536	
	2009.06-	Hatchback Engine LF5H/LF5W	•		GWB7537	
	2009.06-	Hatchback Engine LF5H/LF5W With ABS		○	GHA400106	
	2009.06-	Saloon Engine LF5H/LF5W	•		GWB7536	
	2009.06-	Saloon Engine LF5H/LF5W With ABS		○	GHA400106	
2.2 MZR CD (110 kW)	2009.06-	Hatchback Engine R2AA	•		GWB7536	
	2009.06-	Hatchback Engine R2AA	•		GWB7537	
	2009.06-	Hatchback Engine R2AA With ABS		○	GHA400106	
	2009.06-	Saloon Engine R2AA	•		GWB7536	
	2009.06-	Saloon Engine R2AA	•		GWB7537	
2.2 MZR CD (136 kW)	2009.06-	Saloon Engine R2AA With ABS		○	GHA400106	
	2009.06-	Hatchback Engine R2AA	•		GWB7536	
	2009.06-	Hatchback Engine R2AA	•		GWB7537	
	2009.06-	Hatchback Engine R2AA With ABS		○	GHA400106	
	2009.06-	Saloon Engine R2AA	•		GWB7536	
2.3 MPS Turbo (191 kW)	2009.06-	Saloon Engine R2AA	•		GWB7537	
	2009.06-	Saloon Engine R2AA With ABS		○	GHA400106	
	2009.06-	Hatchback Engine L3KG	•		GWB7536	
	2009.06-	Hatchback Engine L3KG	•		GWB7537	
2009.06-	Hatchback Engine L3KG With ABS		○	GHA400106		
3 (BM)						
1.5 (88 kW)	2013.10-	Saloon Engine P5Y1 Without ABS		○	GHA400281	
2.0 (121 kW)	2013.09-	Hatchback Engine PEY7 Without ABS		○	GHA400281	
	2014.11-	Saloon Engine PEX2 Without ABS		○	GHA400281	
2.0 (88 kW)	2013.09-	Hatchback Engine PEY7 Without ABS		○	GHA400281	
2.2 D (110 kW)	2013.09-	Hatchback Engine SHY1 Without ABS		○	GHA400281	
	2013.09-	Saloon Engine SHY1 Without ABS		○	GHA400281	
323 C IV (BG)						
1.6 16V (65 kW)	1991.03-1994.10	Hatchback Engine B6	•		GWB1950	
	1991.03-1994.10	Hatchback Engine B6		○	GHA230050	K
	1991.03-1994.10	Hatchback Engine B6 With ABS 4 hole		○	GHA230037	K
	1991.03-1994.10	Hatchback Engine B6 With ABS 4 hole		○	GHA230037	K
	1991.03-1994.10	Hatchback Engine B6 Without ABS 4 hole		○	GHA230036	
1.8 16V 4WD (76 kW)	1991.11-1993.12	Hatchback Engine BP	•		GWB1948	
1.8 16V Turbo 4WD (120 kW)	1990.09-1992.12	Hatchback Engine BP	•		GWB1948	
1.8 16V Turbo 4WD (136 kW)	1993.01-1994.07	Hatchback Engine BP	•		GWB1948	
323 C V (BA)						
1.3 16V (54 kW)	1994.08-1998.09	Hatchback Engine B3	•		GWB1950	
	1994.08-1998.09	Hatchback Engine B3		○	GHA230050	K
	1994.08-1998.09	Hatchback Engine B3		○	GHA230122	K
	1994.08-1998.09	Hatchback Engine B3		○	GHA230125	K
	1994.08-1998.09	Hatchback Engine B3 With ABS 4 hole		○	GHA230037	K
	1994.08-1998.09	Hatchback Engine B3 With ABS 4 hole		○	GHA230037	K
	1994.08-1998.09	Hatchback Engine B3 Without ABS 4 hole		○	GHA230036	
1.5 16V (65 kW)	1994.08-1998.09	Hatchback Engine Z5-DE	•		GWB1950	
	1994.08-1998.09	Hatchback Engine Z5-DE		○	GHA230050	K
	1994.08-1998.09	Hatchback Engine Z5-DE		○	GHA230122	K
	1994.08-1998.09	Hatchback Engine Z5-DE		○	GHA230125	K
	1994.08-1998.09	Hatchback Engine Z5-DE With ABS 4 hole		○	GHA230037	K
	1994.08-1998.09	Hatchback Engine Z5-DE With ABS 4 hole		○	GHA230037	K
1.8 16V (84 kW)	1994.08-1998.09	Hatchback Engine Z5-DE Without ABS 4 hole		○	GHA230036	
	1994.08-1998.09	Hatchback Engine BP-ZE	•		GWB1950	
	1994.08-1998.09	Hatchback Engine BP-ZE		○	GHA230050	K
	1994.08-1998.09	Hatchback Engine BP-ZE		○	GHA230122	K
	1994.08-1998.09	Hatchback Engine BP-ZE		○	GHA230125	K
	1994.08-1998.09	Hatchback Engine BP-ZE With ABS 4 hole		○	GHA230037	K
1994.08-1998.09	Hatchback Engine BP-ZE With ABS 4 hole		○	GHA230037	K	



	 YEAR		F	R	G-AP Ref.	KIT
MAZDA						
323 C V (BA)						
1.8 16V (84 kW)	1994.08-1998.09	Hatchback Engine BP-ZE Without ABS 4 hole		o	GHA230036	
323 F IV (BG)						
1.6 16V (65 kW)	1991.03-1994.10	Hatchback Engine B6	•		GWB1950	
	1991.03-1994.10	Hatchback Engine B6		o	GHA230050	K
	1991.03-1994.10	Hatchback Engine B6 With ABS 4 hole		o	GHA230037	K
	1991.03-1994.10	Hatchback Engine B6 With ABS 4 hole		o	GHA230037	K
	1991.03-1994.10	Hatchback Engine B6 Without ABS 4 hole		o	GHA230036	
1.8 4WD (76 kW)	1991.01-1994.04	Hatchback Engine BPC	•		GWB1950	
323 F V (BA)						
1.5 16V (65 kW)	1994.07-1998.09	Coupe Engine Z5-DE	•		GWB1950	
	1994.07-1998.09	Coupe Engine Z5-DE		o	GHA230050	K
	1994.07-1998.09	Coupe Engine Z5-DE		o	GHA230122	K
	1994.07-1998.09	Coupe Engine Z5-DE		o	GHA230125	K
	1994.07-1998.09	Coupe Engine Z5-DE With ABS 4 hole		o	GHA230037	K
	1994.07-1998.09	Coupe Engine Z5-DE With ABS 4 hole		o	GHA230037	K
	1994.07-1998.09	Coupe Engine Z5-DE Without ABS 4 hole		o	GHA230036	
1.8 16V (84 kW)	1994.08-1998.09	Coupe Engine BP-ZE	•		GWB1950	
	1994.08-1998.09	Coupe Engine BP-ZE		o	GHA230050	K
	1994.08-1998.09	Coupe Engine BP-ZE		o	GHA230122	K
	1994.08-1998.09	Coupe Engine BP-ZE		o	GHA230125	K
	1994.08-1998.09	Coupe Engine BP-ZE With ABS 4 hole		o	GHA230037	K
	1994.08-1998.09	Coupe Engine BP-ZE With ABS 4 hole		o	GHA230037	K
	1994.08-1998.09	Coupe Engine BP-ZE Without ABS 4 hole		o	GHA230036	
2.0 24V (106 kW)	1994.08-1998.09	Coupe Engine KF	•		GWB1950	
	1994.08-1998.09	Coupe Engine KF		o	GHA230050	K
	1994.08-1998.09	Coupe Engine KF		o	GHA230122	K
	1994.08-1998.09	Coupe Engine KF		o	GHA230125	K
	1994.08-1998.09	Coupe Engine KF With ABS 4 hole		o	GHA230037	K
	1994.08-1998.09	Coupe Engine KF With ABS 4 hole		o	GHA230037	K
	1994.08-1998.09	Coupe Engine KF Without ABS 4 hole		o	GHA230036	
323 F/P VI (BJ)						
1.4 (53 kW)	2001.01-2004.05	Hatchback Engine B3(16V)	•		GWB1950	
	2001.01-2004.05	Hatchback Engine B3(16V)		o	GHA230050	K
	2001.01-2004.05	Hatchback Engine B3(16V) With ABS		o	GHA236002	K
	2001.01-2004.05	Hatchback Engine B3(16V) With ABS 4 hole		o	GHA230037	K
	2001.01-2004.05	Hatchback Engine B3(16V) With ABS 4 hole		o	GHA230037	K
	2001.01-2004.05	Hatchback Engine B3(16V) Without ABS 4 hole		o	GHA230036	
1.4 16V (54 kW)	1998.09-2001.01	Hatchback Engine B3ME	•		GWB1950	
	1998.09-2001.01	Hatchback Engine B3ME		o	GHA230050	K
	1998.09-2001.01	Hatchback Engine B3ME With ABS		o	GHA236002	K
	1998.09-2001.01	Hatchback Engine B3ME With ABS 4 hole		o	GHA230037	K
	1998.09-2001.01	Hatchback Engine B3ME With ABS 4 hole		o	GHA230037	K
	1998.09-2001.01	Hatchback Engine B3ME Without ABS 4 hole		o	GHA230036	
1.5 16V (65 kW)	1998.09-2001.01	Hatchback Engine ZL05/ZL06	•		GWB1950	
	1998.09-2001.01	Hatchback Engine ZL05/ZL06		o	GHA230050	K
	1998.09-2001.01	Hatchback Engine ZL05/ZL06 With ABS 4 hole		o	GHA230037	K
	1998.09-2001.01	Hatchback Engine ZL05/ZL06 With ABS 4 hole		o	GHA230037	K
	1998.09-2001.01	Hatchback Engine ZL05/ZL06 Without ABS 4 hole		o	GHA230036	
1.6 (70 kW)	2001.01-2004.05	Hatchback Engine ZM	•		GWB1950	
	2001.01-2004.05	Hatchback Engine ZM		o	GHA230050	K
	2001.01-2004.05	Hatchback Engine ZM With ABS		o	GHA236002	K
	2001.01-2004.05	Hatchback Engine ZM With ABS 4 hole		o	GHA230037	K
	2001.01-2004.05	Hatchback Engine ZM With ABS 4 hole		o	GHA230037	K
	2001.01-2004.05	Hatchback Engine ZM Without ABS 4 hole		o	GHA230036	
1.6 (72 kW)	2001.01-2004.05	Hatchback Engine ZM	•		GWB1950	
	2001.01-2004.05	Hatchback Engine ZM		o	GHA230050	K
	2001.01-2004.05	Hatchback Engine ZM With ABS		o	GHA236002	K
	2001.01-2004.05	Hatchback Engine ZM With ABS 4 hole		o	GHA230037	K
	2001.01-2004.05	Hatchback Engine ZM With ABS 4 hole		o	GHA230037	K
	2001.01-2004.05	Hatchback Engine ZM Without ABS 4 hole		o	GHA230036	
1.9 16V (84 kW)	1998.09-2001.01	Hatchback Engine FP	•		GWB1950	
	1998.09-2001.01	Hatchback Engine FP		o	GHA230050	K
	1998.09-2001.01	Hatchback Engine FP With ABS		o	GHA236002	K
	1998.09-2001.01	Hatchback Engine FP With ABS 4 hole		o	GHA230037	K



	 YEAR		F	R	G-AP Ref.	KIT
MAZDA						
323 F/P VI (BJ)						
1.9 16V (84 kW)	1998.09-2001.01	Hatchback Engine FP With ABS 4 hole		o	GHA230037	K
	1998.09-2001.01	Hatchback Engine FP Without ABS 4 hole		o	GHA230036	
2.0 (96 kW)	2001.01-2004.05	Hatchback Engine FS7E/FS7G	•		GWB1950	
	2001.01-2004.05	Hatchback Engine FS7E/FS7G		o	GHA230050	K
	2001.01-2004.05	Hatchback Engine FS7E/FS7G With ABS		o	GHA236002	K
	2001.01-2004.05	Hatchback Engine FS7E/FS7G With ABS 4 hole		o	GHA230037	K
	2001.01-2004.05	Hatchback Engine FS7E/FS7G With ABS 4 hole		o	GHA230037	K
	2001.01-2004.05	Hatchback Engine FS7E/FS7G Without ABS 4 hole		o	GHA230036	
2.0 D (52 kW)	1998.09-2004.05	Hatchback Engine RF1G	•		GWB1950	
	1998.09-2004.05	Hatchback Engine RF1G		o	GHA230050	K
	1998.09-2004.05	Hatchback Engine RF1G With ABS 4 hole		o	GHA230037	K
	1998.09-2004.05	Hatchback Engine RF1G With ABS 4 hole		o	GHA230037	K
	1998.09-2004.05	Hatchback Engine RF1G Without ABS 4 hole		o	GHA230036	
2.0 TD (66 kW)	1998.09-2001.01	Hatchback	•		GWB1950	
	1998.09-2001.01	Hatchback		o	GHA230050	K
	1998.09-2001.01	Hatchback With ABS 4 hole		o	GHA230037	K
	1998.09-2001.01	Hatchback With ABS 4 hole		o	GHA230037	K
	1998.09-2001.01	Hatchback Without ABS 4 hole		o	GHA230036	
2.0 TD (74 kW)	2001.01-2004.05	Hatchback Engine RF4F	•		GWB1950	
	2001.01-2004.05	Hatchback Engine RF4F		o	GHA230050	K
	2001.01-2004.05	Hatchback Engine RF4F With ABS		o	GHA236002	K
	2001.01-2004.05	Hatchback Engine RF4F With ABS 4 hole		o	GHA230037	K
	2001.01-2004.05	Hatchback Engine RF4F With ABS 4 hole		o	GHA230037	K
	2001.01-2004.05	Hatchback Engine RF4F Without ABS 4 hole		o	GHA230036	
323 III (BW)						
1.6 4x4 (63 kW)	1990.05-1993.03	Estate Engine B65M/B6E	•		GWB1383	
323 P V (BA)						
1.3 16V (54 kW)	1996.10-	Hatchback Engine B3		o	GHA230122	K
	1996.10-	Hatchback Engine B3		o	GHA230125	K
1.5 16V (65 kW)	1996.10-	Hatchback Engine Z5-DE		o	GHA230122	K
	1996.10-	Hatchback Engine Z5-DE		o	GHA230125	K
2.0 D (52 kW)	1996.10-	Hatchback Engine RF1G	•		GWB1950	
	1996.10-	Hatchback Engine RF1G		o	GHA230050	K
	1996.10-	Hatchback Engine RF1G		o	GHA230122	K
	1996.10-	Hatchback Engine RF1G		o	GHA230125	K
	1996.10-	Hatchback Engine RF1G With ABS 4 hole		o	GHA230037	K
	1996.10-	Hatchback Engine RF1G With ABS 4 hole		o	GHA230037	K
	1996.10-	Hatchback Engine RF1G Without ABS 4 hole		o	GHA230036	
323 S IV (BG)						
1.3 16V (54 kW)	1991.04-1994.07	Saloon Engine B3	•		GWB1950	
	1991.04-1994.07	Saloon Engine B3		o	GHA230050	K
	1991.04-1994.07	Saloon Engine B3 With ABS 4 hole		o	GHA230037	K
	1991.04-1994.07	Saloon Engine B3 With ABS 4 hole		o	GHA230037	K
	1991.04-1994.07	Saloon Engine B3 Without ABS 4 hole		o	GHA230036	
1.8 16V 4WD (76 kW)	1991.09-1994.07	Saloon Engine BP52	•		GWB1948	
1.8 16V Turbo 4WD (120 kW)	1991.01-1994.07	Saloon Engine BP	•		GWB1948	
323 S V (BA)						
1.3 16V (54 kW)	1994.08-1998.09	Saloon Engine B3	•		GWB1950	
	1994.08-1998.09	Saloon Engine B3		o	GHA230050	K
	1994.08-1998.09	Saloon Engine B3		o	GHA230122	K
	1994.08-1998.09	Saloon Engine B3		o	GHA230125	K
	1994.08-1998.09	Saloon Engine B3 With ABS 4 hole		o	GHA230037	K
	1994.08-1998.09	Saloon Engine B3 With ABS 4 hole		o	GHA230037	K
	1994.08-1998.09	Saloon Engine B3 Without ABS 4 hole		o	GHA230032	K
	1994.08-1998.09	Saloon Engine B3 Without ABS 4 hole		o	GHA230036	
1.5 16V (65 kW)	1994.08-1998.09	Saloon Engine Z5-DE	•		GWB1950	
	1994.08-1998.09	Saloon Engine Z5-DE		o	GHA230050	K
	1994.08-1998.09	Saloon Engine Z5-DE		o	GHA230122	K
	1994.08-1998.09	Saloon Engine Z5-DE		o	GHA230125	K
	1994.08-1998.09	Saloon Engine Z5-DE With ABS 4 hole		o	GHA230037	K
	1994.08-1998.09	Saloon Engine Z5-DE With ABS 4 hole		o	GHA230037	K
	1994.08-1998.09	Saloon Engine Z5-DE Without ABS 4 hole		o	GHA230032	K
	1994.08-1998.09	Saloon Engine Z5-DE Without ABS 4 hole		o	GHA230036	



	 YEAR		F	R	G-AP Ref.	KIT
MAZDA						
323 S V (BA)						
1.6 TD (60 kW)	1994.05-1998.09	Saloon Engine 4EE1-T	•		GWB1950	
	1994.05-1998.09	Saloon Engine 4EE1-T		○	GHA230050	K
	1994.05-1998.09	Saloon Engine 4EE1-T With ABS 4 hole		○	GHA230037	K
	1994.05-1998.09	Saloon Engine 4EE1-T With ABS 4 hole		○	GHA230037	K
	1994.05-1998.09	Saloon Engine 4EE1-T Without ABS 4 hole		○	GHA230032	K
	1994.05-1998.09	Saloon Engine 4EE1-T Without ABS 4 hole		○	GHA230036	
1.8 16V (84 kW)	1994.08-1998.09	Saloon Engine BP-ZE	•		GWB1950	
	1994.08-1998.09	Saloon Engine BP-ZE		○	GHA230050	K
	1994.08-1998.09	Saloon Engine BP-ZE		○	GHA230122	K
	1994.08-1998.09	Saloon Engine BP-ZE		○	GHA230125	K
	1994.08-1998.09	Saloon Engine BP-ZE With ABS 4 hole		○	GHA230037	K
	1994.08-1998.09	Saloon Engine BP-ZE With ABS 4 hole		○	GHA230037	K
	1994.08-1998.09	Saloon Engine BP-ZE Without ABS 4 hole		○	GHA230032	K
	1994.08-1998.09	Saloon Engine BP-ZE Without ABS 4 hole		○	GHA230036	
2.0 D (52 kW)	1996.10-1998.09	Saloon Engine RF1G	•		GWB1950	
	1996.10-1998.09	Saloon Engine RF1G		○	GHA230050	K
	1996.10-1998.09	Saloon Engine RF1G		○	GHA230122	K
	1996.10-1998.09	Saloon Engine RF1G		○	GHA230125	K
	1996.10-1998.09	Saloon Engine RF1G With ABS 4 hole		○	GHA230037	K
	1996.10-1998.09	Saloon Engine RF1G With ABS 4 hole		○	GHA230037	K
	1996.10-1998.09	Saloon Engine RF1G Without ABS 4 hole		○	GHA230032	K
	1996.10-1998.09	Saloon Engine RF1G Without ABS 4 hole		○	GHA230036	
323 S VI (BJ)						
1.4 (53 kW)	2001.01-2004.05	Saloon Engine B3(16V)	•		GWB1950	
	2001.01-2004.05	Saloon Engine B3(16V)		○	GHA230050	K
	2001.01-2004.05	Saloon Engine B3(16V) With ABS		○	GHA236002	K
	2001.01-2004.05	Saloon Engine B3(16V) With ABS 4 hole		○	GHA230037	K
	2001.01-2004.05	Saloon Engine B3(16V) With ABS 4 hole		○	GHA230037	K
	2001.01-2004.05	Saloon Engine B3(16V) Without ABS 4 hole		○	GHA230032	K
	2001.01-2004.05	Saloon Engine B3(16V) Without ABS 4 hole		○	GHA230036	
1.4 16V (54 kW)	1998.09-2001.01	Saloon Engine B3ME	•		GWB1950	
	1998.09-2001.01	Saloon Engine B3ME		○	GHA230050	K
	1998.09-2001.01	Saloon Engine B3ME With ABS		○	GHA236002	K
	1998.09-2001.01	Saloon Engine B3ME With ABS 4 hole		○	GHA230037	K
	1998.09-2001.01	Saloon Engine B3ME With ABS 4 hole		○	GHA230037	K
	1998.09-2001.01	Saloon Engine B3ME Without ABS 4 hole		○	GHA230036	
1.5 16V (65 kW)	1998.09-2001.01	Saloon Engine ZL05/ZL06	•		GWB1950	
	1998.09-2001.01	Saloon Engine ZL05/ZL06		○	GHA230050	K
	1998.09-2001.01	Saloon Engine ZL05/ZL06 With ABS 4 hole		○	GHA230037	K
	1998.09-2001.01	Saloon Engine ZL05/ZL06 With ABS 4 hole		○	GHA230037	K
	1998.09-2001.01	Saloon Engine ZL05/ZL06 Without ABS 4 hole		○	GHA230032	K
	1998.09-2001.01	Saloon Engine ZL05/ZL06 Without ABS 4 hole		○	GHA230036	
1.6 (70 kW)	2001.01-2004.05	Saloon Engine ZM	•		GWB1950	
	2001.01-2004.05	Saloon Engine ZM		○	GHA230050	K
	2001.01-2004.05	Saloon Engine ZM With ABS		○	GHA236002	K
	2001.01-2004.05	Saloon Engine ZM With ABS 4 hole		○	GHA230037	K
	2001.01-2004.05	Saloon Engine ZM With ABS 4 hole		○	GHA230037	K
	2001.01-2004.05	Saloon Engine ZM Without ABS 4 hole		○	GHA230036	
1.6 (72 kW)	2001.01-2004.05	Saloon Engine ZM	•		GWB1950	
	2001.01-2004.05	Saloon Engine ZM		○	GHA230050	K
	2001.01-2004.05	Saloon Engine ZM With ABS		○	GHA236002	K
	2001.01-2004.05	Saloon Engine ZM With ABS 4 hole		○	GHA230037	K
	2001.01-2004.05	Saloon Engine ZM With ABS 4 hole		○	GHA230037	K
	2001.01-2004.05	Saloon Engine ZM Without ABS 4 hole		○	GHA230032	K
	2001.01-2004.05	Saloon Engine ZM Without ABS 4 hole		○	GHA230036	
	1.8 Protege (92 kW)	1998.05-2004.05	Saloon Engine BP (DOHC)	•		GWB1950
1998.05-2004.05	Saloon Engine BP (DOHC)		○	GHA230050	K	
1998.05-2004.05	Saloon Engine BP (DOHC) With ABS		○	GHA236002	K	
1998.05-2004.05	Saloon Engine BP (DOHC) Without ABS 4 hole		○	GHA230036		
1.9 16V (84 kW)	1998.09-2004.05	Saloon Engine FP	•		GWB1950	
	1998.09-2004.05	Saloon Engine FP		○	GHA230050	K
	1998.09-2004.05	Saloon Engine FP With ABS		○	GHA236002	K
	1998.09-2004.05	Saloon Engine FP Without ABS 4 hole		○	GHA230032	K
	1998.09-2004.05	Saloon Engine FP Without ABS 4 hole		○	GHA230036	



	 YEAR		F	R	G-AP Ref.	KIT
MAZDA						
323 S VI (BJ)						
2.0 (96 kW)	2001.01-2004.05	Saloon Engine FS7E/FS7G	•		GWB1950	
	2001.01-2004.05	Saloon Engine FS7E/FS7G		○	GHA230050	K
	2001.01-2004.05	Saloon Engine FS7E/FS7G With ABS		○	GHA236002	K
	2001.01-2004.05	Saloon Engine FS7E/FS7G With ABS 4 hole		○	GHA230037	K
	2001.01-2004.05	Saloon Engine FS7E/FS7G With ABS 4 hole		○	GHA230037	K
	2001.01-2004.05	Saloon Engine FS7E/FS7G Without ABS 4 hole		○	GHA230032	K
	2001.01-2004.05	Saloon Engine FS7E/FS7G Without ABS 4 hole		○	GHA230036	
2.0 (98 kW)	2000.02-2004.05	Saloon Engine FS	•		GWB1950	
	2000.02-2004.05	Saloon Engine FS		○	GHA230050	K
	2000.02-2004.05	Saloon Engine FS With ABS		○	GHA236002	K
	2000.02-2004.05	Saloon Engine FS Without ABS 4 hole		○	GHA230036	
2.0 D (52 kW)	1998.09-2004.05	Saloon Engine RF1G	•		GWB1950	
	1998.09-2004.05	Saloon Engine RF1G		○	GHA230050	K
	1998.09-2004.05	Saloon Engine RF1G With ABS 4 hole		○	GHA230037	K
	1998.09-2004.05	Saloon Engine RF1G With ABS 4 hole		○	GHA230037	K
	1998.09-2004.05	Saloon Engine RF1G Without ABS 4 hole		○	GHA230032	K
	1998.09-2004.05	Saloon Engine RF1G Without ABS 4 hole		○	GHA230036	
2.0 TD (66 kW)	1998.09-2004.05	Saloon Engine RF3F	•		GWB1950	
	1998.09-2004.05	Saloon Engine RF3F		○	GHA230050	K
	1998.09-2004.05	Saloon Engine RF3F With ABS 4 hole		○	GHA230037	K
	1998.09-2004.05	Saloon Engine RF3F With ABS 4 hole		○	GHA230037	K
	1998.09-2004.05	Saloon Engine RF3F Without ABS 4 hole		○	GHA230032	K
	1998.09-2004.05	Saloon Engine RF3F Without ABS 4 hole		○	GHA230036	
5 (CR19)						
1.8 (85 kW)	2005.06-2008.02	MPV Engine L823	•		GWB6972	
	2005.06-2008.02	MPV Engine L823	•		GWB7536	
	2005.06-2008.02	MPV Engine L823	•		GWB7537	
	2005.06-2008.02	MPV Engine L823 With ABS		○	GHA400106	
2.0 (107 kW)	2005.06-2008.02	MPV Engine LFF7	•		GWB6972	
	2005.06-2008.02	MPV Engine LFF7	•		GWB7536	
	2005.06-2008.02	MPV Engine LFF7	•		GWB7537	
	2005.06-2008.02	MPV Engine LFF7 With ABS		○	GHA400106	
2.0 CD (105 kW)	2005.06-2008.02	MPV Engine RF7J	•		GWB6972	
	2005.06-2008.02	MPV Engine RF7J	•		GWB7536	
	2005.06-2008.02	MPV Engine RF7J	•		GWB7537	
	2005.06-2008.02	MPV Engine RF7J With ABS		○	GHA400106	
2.0 CD (81 kW)	2005.06-2008.02	MPV	•		GWB6972	
	2005.06-2008.02	MPV	•		GWB7536	
	2005.06-2008.02	MPV	•		GWB7537	
	2005.06-2008.02	MPV With ABS		○	GHA400106	
5 (CW)						
1.6 CD (85 kW)	2010.09-	MPV	•		GWB7536	
	2010.09-	MPV	•		GWB7537	
	2010.09-	MPV With ABS		○	GHA400106	
1.8 MZR (85 kW)	2012.01-	MPV	•		GWB7536	
	2012.01-	MPV	•		GWB7537	
	2012.01-	MPV With ABS		○	GHA400106	
2.0 (106 kW)	2011.01-	MPV	•		GWB7536	
	2011.01-	MPV	•		GWB7537	
	2011.01-	MPV With ABS		○	GHA400106	
2.0 (110 kW)	2010.09-	MPV Engine LF5H	•		GWB7536	
	2010.09-	MPV Engine LF5H	•		GWB7537	
	2010.09-	MPV Engine LF5H With ABS		○	GHA400106	
6 (GG)						
1.8 (88 kW)	2002.08-2007.08	Hatchback Engine L813	•		GWB7446	
	2002.08-2007.08	Hatchback Engine L813 With ABS		○	GHA236002	K
	2002.08-2007.08	Saloon Engine L813	•		GWB7446	
	2002.08-2007.08	Saloon Engine L813 With ABS		○	GHA236002	K
2.0 (104 kW)	2002.06-2007.08	Saloon Engine LF17/LF18	•		GWB7446	
	2002.06-2007.08	Saloon Engine LF17/LF18 With ABS		○	GHA236002	K
	2002.08-2007.08	Hatchback Engine LF17/LF18	•		GWB7446	
	2002.08-2007.08	Hatchback Engine LF17/LF18 With ABS		○	GHA236002	K
2.0 (108 kW)	2005.06-2008.02	Hatchback Engine LFF7	•		GWB7446	
	2005.06-2008.02	Hatchback Engine LFF7 With ABS		○	GHA236002	K



	 YEAR		F	R	G-AP Ref.	KIT
MAZDA						
6 (GG)						
2.0 (108 kW)	2005.06-2008.02	Saloon Engine LFF7	•		GWB7446	
	2005.06-2008.02	Saloon Engine LFF7 With ABS		◦	GHA236002	K
2.0 Di (100 kW)	2002.06-2007.08	Saloon Engine RF5C	•		GWB6849	
	2002.06-2007.08	Saloon Engine RF5C	•		GWB7446	
	2002.06-2007.08	Saloon Engine RF5C With ABS		◦	GHA236002	K
	2002.08-2007.08	Hatchback Engine RF5C	•		GWB6849	
	2002.08-2007.08	Hatchback Engine RF5C	•		GWB7446	
	2002.08-2007.08	Hatchback Engine RF5C With ABS		◦	GHA236002	K
2.0 Di (105 kW)	2005.06-2008.02	Hatchback Engine RF7J	•		GWB6849	
	2005.06-2008.02	Hatchback Engine RF7J With ABS		◦	GHA236002	K
	2005.06-2008.02	Saloon Engine RF7J	•		GWB6849	
	2005.06-2008.02	Saloon Engine RF7J With ABS		◦	GHA236002	K
2.0 Di (89 kW)	2002.08-2007.08	Hatchback Engine RF5C	•		GWB6849	
	2002.08-2007.08	Hatchback Engine RF5C	•		GWB7446	
	2002.08-2007.08	Hatchback Engine RF5C With ABS		◦	GHA236002	K
	2002.08-2007.08	Saloon Engine RF5C	•		GWB6849	
	2002.08-2007.08	Saloon Engine RF5C	•		GWB7446	
	2002.08-2007.08	Saloon Engine RF5C With ABS		◦	GHA236002	K
2.3 (122 kW)	2002.06-2007.08	Saloon Engine L3C1	•		GWB7446	
	2002.06-2007.08	Saloon Engine L3C1 With ABS		◦	GHA236002	K
	2002.08-2007.08	Hatchback Engine L3C1	•		GWB7446	
	2002.08-2007.08	Hatchback Engine L3C1 With ABS		◦	GHA236002	K
2.3 MPS Turbo (191 kW)	2006.01-2008.02	Saloon Engine L3KG	•		GWB6849	
	2006.01-2008.02	Saloon Engine L3KG		◦	GWB7446	
6 (GH)						
1.8 MZR (88 kW)	2007.08-	Hatchback Engine L813	•		GWB7536	
	2007.08-	Hatchback Engine L813	•		GWB7537	
	2007.08-	Saloon Engine L813	•		GWB7536	
	2007.08-	Saloon Engine L813	•		GWB7537	
	2008.02-	Estate Engine L813	•		GWB7536	
	2008.02-	Estate Engine L813	•		GWB7537	
2.0 MZR (108 kW)	2007.08-	Hatchback Engine LF17	•		GWB7536	
	2007.08-	Hatchback Engine LF17	•		GWB7537	
	2007.08-	Saloon Engine LF17	•		GWB7536	
	2007.08-	Saloon Engine LF17	•		GWB7537	
	2008.02-	Estate Engine LF17	•		GWB7536	
	2008.02-	Estate Engine LF17	•		GWB7537	
2.0 MZR (114 kW)	2010.01-	Estate Engine LF-DE	•		GWB7536	
	2010.01-	Estate Engine LF-DE	•		GWB7537	
	2010.01-	Hatchback Engine LF-DE	•		GWB7536	
	2010.01-	Hatchback Engine LF-DE	•		GWB7537	
	2010.01-	Saloon Engine LF-DE	•		GWB7536	
	2010.01-	Saloon Engine LF-DE	•		GWB7537	
2.0 MZR CD (103 kW)	2007.08-	Hatchback Engine RF7J	•		GWB7538	
	2007.08-	Saloon Engine RF7J	•		GWB7538	
	2008.02-	Estate Engine RF7J	•		GWB7538	
2.2 D (132 kW)	2010.01-	Saloon Engine R2AA	•		GWB7538	
2.2 D (95 kW)	2010.01-	Estate Engine R2BF	•		GWB7538	
	2010.01-	Hatchback	•		GWB7538	
	2010.01-	Saloon	•		GWB7538	
2.2 MZR CD (120 kW)	2009.01-	Estate Engine R2AA	•		GWB7538	
	2009.01-	Hatchback Engine R2AA	•		GWB7538	
	2009.01-	Saloon Engine R2AA	•		GWB7538	
2.2 MZR CD (132 kW)	2010.01-	Estate Engine R2AA	•		GWB7538	
	2010.01-	Hatchback Engine R2AA	•		GWB7538	
2.2 MZR CD (136 kW)	2009.01-	Estate Engine R2AA	•		GWB7538	
	2009.01-	Hatchback Engine R2AA	•		GWB7538	
	2009.01-	Saloon Engine R2AA	•		GWB7538	
2.2 MZR CD (92 kW)	2009.01-	Estate	•		GWB7538	
	2009.01-	Hatchback	•		GWB7538	
	2009.01-	Saloon	•		GWB7538	
2.5 MZR (125 kW)	2007.08-	Hatchback Engine L5-VE	•		GWB7536	
	2007.08-	Hatchback Engine L5-VE	•		GWB7537	
	2007.08-	Saloon Engine L5-VE	•		GWB7536	



	 YEAR		F	R	G-AP Ref.	KIT
MAZDA						
6 (GH)						
2.5 MZR (125 kW)	2007.08- 2008.02- 2008.02-	Saloon Engine L5-VE Estate Engine L5-VE Estate Engine L5-VE	• • •		GWB7537 GWB7536 GWB7537	
6 (GJ, GH)						
2.0 (107 kW)	2013.01- 2013.01-	Estate Engine PEY7 Estate Engine PEY7 Without ABS	• •		GHA331008 GHA400281	
2.0 (121 kW)	2013.01- 2013.01-	Estate Engine PEY7 Estate Engine PEY7 Without ABS	• •	○	GHA331008 GHA400281	
2.2 D (110 kW)	2012.12-	Estate Engine SHY1 Without ABS		○	GHA400281	
2.2 D (129 kW)	2012.12- 2012.12-	Estate Engine SHY1 Estate Engine SHY1 Without ABS	• •	○	GHA331008 GHA400281	
2.5 (141 kW)	2012.12-	Estate Engine PYY1 Without ABS		○	GHA400281	
6 GG						
-	2002-2008		•		GHA428005	K
6 GH						
-	2008-2013 2008-2013		• •	○	GHA428005 GHA400140	K
6 MPS GG						
-	2005-2007		•		GHA428005	K
6 STATION WAGON (GY)						
1.8 (88 kW)	2002.08-2007.08 2002.08-2007.08	Estate Engine L813 Estate Engine L813 With ABS	• •	○	GWB7446 GHA236002	K
2.0 (104 kW)	2002.08-2007.08 2002.08-2007.08	Estate Engine LF17/LF18 Estate Engine LF17/LF18 With ABS	• •	○	GWB7446 GHA236002	K
2.0 (108 kW)	2005.06-2008.02 2005.06-2008.02	Estate Engine LFF7 Estate Engine LFF7 With ABS	• •	○	GWB7446 GHA236002	K
2.0 Di (100 kW)	2002.08-2007.08 2002.08-2007.08	Estate Engine RF5C Estate Engine RF5C	• •		GWB6849 GWB7446	
2.0 Di (105 kW)	2002.08-2007.08 2002.08-2007.08	Estate Engine RF5C With ABS Estate Engine RF7J	• •	○	GHA236002 GWB6849	K
2.0 Di (89 kW)	2005.06-2008.02 2005.06-2008.02	Estate Engine RF7J With ABS Estate Engine RF5C	• •	○	GHA236002 GWB6849	K
2.0 Di (105 kW)	2002.08-2007.08 2002.08-2007.08	Estate Engine RF5C Estate Engine RF5C	• •		GWB6849 GWB7446	
2.0 Di (89 kW)	2002.08-2007.08 2002.08-2007.08	Estate Engine RF5C Estate Engine RF5C With ABS	• •	○	GWB6849 GHA236002	K
2.3 (122 kW)	2002.08-2007.08 2002.08-2007.08	Estate Engine L3C1 Estate Engine L3C1 With ABS	• •	○	GWB7446 GHA236002	K
2.3 AWD (119 kW)	2002.11-2005.05	Estate Engine L3C1	•		GWB7446	
6 WAGON GH						
-	2008-2013 2008-2013		• •	○	GHA428005 GHA400140	K
6 WAGON GY						
-	2002-2008		•		GHA428005	K
626 III (GV)						
2.0 D (60 kW)	1994.11-1997.09	Estate Engine RFG5 With ABS		○	GHA233002	F
2.0 D Comprex (55 kW)	1993.05-1996.11	Estate Engine RF-CX With ABS		○	GHA233002	F
2.0 i 16V (110 kW)	1994.11-1997.09	Estate With ABS		○	GHA233002	F
2.2 12V 4WD (85 kW)	1991.05-1992.11	Estate Engine F2/F2L1		○	GWB1948	
626 IV (GE)						
1.8 (66 kW)	1994.08-1997.04 1994.08-1997.04 1994.08-1997.04	Hatchback Hatchback With ABS Hatchback Without ABS	• • •	○	GWB1948 GHA233002 GHA233009	F K
1.8 (77 kW)	1991.08-1997.04 1991.08-1997.04 1991.08-1997.04	Hatchback Engine FP Hatchback Engine FP With ABS Hatchback Engine FP Without ABS	• • •	○	GWB1948 GHA233002 GHA233009	F K
1.8 i (66 kW)	1994.08-1997.04 1994.08-1997.04 1994.08-1997.04	Saloon Saloon With ABS Saloon Without ABS	• • •	○	GWB1948 GHA233002 GHA233009	F K
1.8 i (77 kW)	1992.01-1997.04 1992.01-1997.04 1992.01-1997.04	Saloon Engine FP Saloon Engine FP With ABS Saloon Engine FP Without ABS	• • •	○	GWB1948 GHA233002 GHA233009	F K
2.0 D GLX Comprex (55 kW)	1992.10-1997.04 1992.10-1997.04 1992.10-1997.04	Saloon Engine RFOHC Saloon Engine RFOHC With ABS Saloon Engine RFOHC Without ABS	• • •	○	GWB1948 GHA233002 GHA233009	F K



	 YEAR		F	R	G-AP Ref.	KIT
MAZDA						
626 IV (GE)						
2.0 D GLX Complex (55 kW)	1993.01-1997.04	Hatchback Engine RFOHC	•		GWB1948	
	1993.01-1997.04	Hatchback Engine RFOHC With ABS		○	GHA233002	F
	1993.01-1997.04	Hatchback Engine RFOHC Without ABS		○	GHA233009	K
2.0 i (85 kW)	1991.08-1997.04	Hatchback Engine FS	•		GWB1948	
	1991.08-1997.04	Hatchback Engine FS With ABS		○	GHA233002	F
	1991.08-1997.04	Hatchback Engine FS Without ABS		○	GHA233009	K
	1992.01-1997.04	Saloon Engine FS	•		GWB1948	
	1992.01-1997.04	Saloon Engine FS With ABS		○	GHA233002	F
	1992.01-1997.04	Saloon Engine FS Without ABS		○	GHA233009	K
2.0 i 4WD (85 kW)	1992.04-1997.04	Hatchback Engine FS	•		GWB1948	
	1992.04-1997.04	Saloon Engine FS	•		GWB1948	
2.5 24V (120 kW)	1994.08-1997.04	Hatchback Engine KL	•		GWB1948	
	1994.08-1997.04	Hatchback Engine KL With ABS		○	GHA233002	F
2.5 24V (121 kW)	1992.01-1997.04	Hatchback Engine KL	•		GWB1948	
	1992.01-1997.04	Hatchback Engine KL With ABS		○	GHA233002	F
	1992.01-1997.04	Hatchback Engine KL Without ABS		○	GHA233009	K
	1992.01-1997.04	Saloon Engine KL-ZE With ABS		○	GHA233002	F
626 V (GF)						
1.8 (66 kW)	1997.05-1999.12	Hatchback Engine FPY3	•		GWB1948	
	1997.05-1999.12	Hatchback Engine FPY3 Without ABS		○	GHA233009	K
	1997.05-1999.12	Saloon Engine FPY3	•		GWB1948	
	1997.05-1999.12	Saloon Engine FPY3 Without ABS		○	GHA233009	K
1.8 (74 kW)	1999.12-2002.10	Hatchback Engine FP	•		GWB1948	
	1999.12-2002.10	Hatchback Engine FP Without ABS		○	GHA233009	K
	1999.12-2002.10	Saloon Engine FP9A Without ABS		○	GHA233009	K
2.0 (100 kW)	1998.04-2002.10	Saloon Engine FS2C	•		GWB1948	
	1998.04-2002.10	Saloon Engine FS2C Without ABS		○	GHA233009	K
2.0 (85 kW)	1997.05-2002.10	Hatchback Engine FS	•		GWB1948	
	1997.05-2002.10	Hatchback Engine FS Without ABS		○	GHA233009	K
	1997.05-2002.10	Saloon Engine FS	•		GWB1948	
	1997.05-2002.10	Saloon Engine FS Without ABS		○	GHA233009	K
2.0 Di TD (66 kW)	1998.04-2002.10	Saloon Engine RF3F	•		GWB1948	
	1998.04-2002.10	Saloon Engine RF3F Without ABS		○	GHA233009	K
2.0 DiTD (66 kW)	1998.04-2002.10	Hatchback Engine RF3F	•		GWB1948	
	1998.04-2002.10	Hatchback Engine RF3F Without ABS		○	GHA233009	K
2.0 H.P. (100 kW)	1998.02-2002.10	Hatchback Engine FS2C	•		GWB1948	
	1998.02-2002.10	Hatchback Engine FS2C Without ABS		○	GHA233009	K
2.0 TD (81 kW)	2000.10-2002.10	Hatchback	•		GWB1948	
	2000.10-2002.10	Hatchback Without ABS		○	GHA233009	K
	2000.10-2002.10	Saloon	•		GWB1948	
	2000.10-2002.10	Saloon Without ABS		○	GHA233009	K
2.0 Turbo Di (74 kW)	1998.04-2002.10	Hatchback	•		GWB1948	
	1998.04-2002.10	Hatchback Without ABS		○	GHA233009	K
	1998.04-2002.10	Saloon	•		GWB1948	
	1998.04-2002.10	Saloon Without ABS		○	GHA233009	K
626 V (GW)						
1.8 (66 kW)	1998.02-2000.01	Estate Engine FPY3	•		GWB1948	
	1998.02-2000.01	Estate Engine FPY3 With ABS		○	GHA236002	K
	1998.02-2000.01	Estate Engine FPY3 Without ABS		○	GHA236003	
1.8 (74 kW)	2000.01-2002.10	Estate Engine FP9A	•		GWB1948	
	2000.01-2002.10	Estate Engine FP9A With ABS		○	GHA236002	K
	2000.01-2002.10	Estate Engine FP9A Without ABS		○	GHA236003	
2.0 (85 kW)	1998.02-2002.10	Estate Engine FS	•		GWB1948	
	1998.02-2002.10	Estate Engine FS With ABS		○	GHA236002	K
	1998.02-2002.10	Estate Engine FS Without ABS		○	GHA236003	
2.0 DiTD (66 kW)	1999.09-2002.10	Estate Engine RF3F	•		GWB1948	
	1999.09-2002.10	Estate Engine RF3F With ABS		○	GHA236002	K
	1999.09-2002.10	Estate Engine RF3F Without ABS		○	GHA236003	
2.0 H.P. (100 kW)	1998.02-2002.10	Estate Engine FS2C	•		GWB1948	
	1998.02-2002.10	Estate Engine FS2C With ABS		○	GHA236002	K
	1998.02-2002.10	Estate Engine FS2C Without ABS		○	GHA236003	
2.0 TD (81 kW)	2000.10-2002.10	Estate	•		GWB1948	
	2000.10-2002.10	Estate With ABS		○	GHA236002	K
	2000.10-2002.10	Estate Without ABS		○	GHA236003	



	 YEAR		F	R	G-AP Ref.	KIT
MAZDA						
626 V (GW)						
2.0 Turbo Di (74 kW)	1998.04-2002.10	Estate Engine RF4F	•		GWB1948	
	1998.04-2002.10	Estate Engine RF4F With ABS		○	GHA236002	K
	1998.04-2002.10	Estate Engine RF4F Without ABS		○	GHA236003	
ATENZA (GJ, GH)						
2.0 (107 kW)	2013.01-	Saloon Engine PEY7	•		GHA331008	
	2013.01-	Saloon Engine PEY7 Without ABS		○	GHA400281	
2.0 (121 kW)	2013.01-	Saloon Engine PEY7	•		GHA331008	
	2013.01-	Saloon Engine PEY7 Without ABS		○	GHA400281	
2.2 D (110 kW)	2013.01-	Saloon Engine SHY1	•		GHA331008	
	2013.01-	Saloon Engine SHY1 Without ABS		○	GHA400281	
2.2 D (129 kW)	2012.12-	Saloon Engine SHY1	•		GHA331008	
	2012.12-	Saloon Engine SHY1 Without ABS		○	GHA400281	
2.5 (141 kW)	2013.01-	Saloon Engine PYY1	•		GHA331008	
	2013.01-	Saloon Engine PYY1 Without ABS		○	GHA400281	
ATENZA GG						
-	2002-2007		•		GHA428005	K
B3000						
-	1998-2000		•		GHA342001	
	2000-	Without ABS	•		GHA327034	
	2001-2002	With ABS	•		GHA327017	
B4000						
-	1998-2000		•		GHA342001	
	2000-	Without ABS	•		GHA327034	
	2000-2002	With ABS	•		GHA327017	
B-SERIE (UF)						
2.5 D 4WD (57 kW)	1998.09-1999.06	Pickup	•		GWB3949	
2.5 D 4WD (63 kW)	1996.02-1999.06	Pickup	•		GWB3949	
2.6 12V 4WD (90 kW)	1990.01-1999.06	Pickup Engine G6MPV	•		GWB3949	
B-SERIE (UN)						
2.2 4WD (60 kW)	1999.02-	Pickup Engine R5A2	•		GWB3949	
	1999.02-	Pickup Engine R5A2		○	GWB3950	
2.2 8V 4WD (68 kW)	1999.06-	Pickup Engine JL22	•		GWB3949	
	1999.06-	Pickup Engine JL22		○	GWB3950	
2.5 D (57 kW)	1999.06-	Pickup Engine MD25NA		○	GWB3950	
2.5 D (62 kW)	2002.12-	Pickup Engine WLE7		○	GWB3950	
2.5 D 4WD (57 kW)	1999.06-	Pickup Engine MD25NA	•		GWB3949	
	1999.06-	Pickup Engine MD25NA		○	GWB3950	
2.5 D 4WD (61 kW)	1999.11-2001.12	Pickup Engine WLE7	•		GWB3949	
	1999.11-2001.12	Pickup Engine WLE7		○	GWB3950	
2.5 D 4WD (62 kW)	2002.12-	Pickup Engine WLE7		○	GWB3950	
2.5 D 4WD (65 kW)	1999.11-2002.07	Pickup Engine WLE9	•		GWB3949	
	1999.11-2002.07	Pickup Engine WLE9		○	GWB3950	
2.5 TD 4WD (80 kW)	1999.06-2006.07	Pickup Engine MD25TI	•		GWB3949	
	1999.06-2006.07	Pickup Engine MD25TI		○	GWB3950	
2.6 12V 4WD (90 kW)	1999.06-	Pickup Engine JK26	•		GWB3949	
	1999.06-	Pickup Engine JK26		○	GWB3950	
BT-50 (CD, UN)						
2.5 MZR CD 4x4 (105 kW)	2006.12-	Pickup Engine WLAA	•		GHA327033	
	2006.12-	Pickup Engine WLAA	•		GWB7534A	
	2006.12-	Pickup Engine WLAA		○	GWB3950	
3.0 CDVi (115 kW)	2006.12-	Pickup Engine WEAT		○	GWB3950	
3.0 CDVi 4x4 (115 kW)	2006.12-	Pickup Engine WEAT	•		GHA327033	
	2006.12-	Pickup Engine WEAT	•		GWB7534A	
	2006.12-	Pickup Engine WEAT		○	GWB3950	
	2006.12-	Platform/Chassis Engine WEAT	•		GHA327033	
CX-5 (KE, GH)						
2.0 (121 kW)	2011.11-	Closed Off-Road Vehicle Engine PEY6/PEY7	•		GHA331008	
	2011.11-	Closed Off-Road Vehicle Engine PEY6/PEY7 Without ABS		○	GHA400281	
2.0 AWD (118 kW)	2011.11-	Closed Off-Road Vehicle Engine PEY6/PEY7	•		GHA331008	
	2011.11-	Closed Off-Road Vehicle Engine PEY6/PEY7 With ABS		○	GHA328011	K
2.2 D (110 kW)	2012.04-	Closed Off-Road Vehicle Engine SHY1	•		GHA331008	
	2012.04-	Closed Off-Road Vehicle Engine SHY1 Without ABS		○	GHA400281	
2.2 D AWD (110 kW)	2012.04-	Closed Off-Road Vehicle Engine SHY1	•		GHA331008	



	 YEAR		F	R	G-AP Ref.	KIT
MAZDA						
CX-5 (KE, GH)						
2.2 D AWD (110 kW)	2012.04-	Closed Off-Road Vehicle Engine SHY1 With ABS		o	GHA328011	K
2.2 D AWD (129 kW)	2012.04-	Closed Off-Road Vehicle Engine SHY1	•		GHA331008	
	2012.04-	Closed Off-Road Vehicle Engine SHY1 With ABS		o	GHA328011	K
CX-7 (ER)						
2.2 MZR CD (127 kW)	2009.09-	Closed Off-Road Vehicle Engine R2AA	•		GWB6849	
2.2 MZR-CD AWD (120 kW)	2012.01-	Closed Off-Road Vehicle Engine R2AA	•		GWB6849	
	2012.01-	Closed Off-Road Vehicle Engine R2AA		o	GHA328012	
2.3 DiSi (182 kW)	2012.01-	Closed Off-Road Vehicle Engine L3Y7	•		GWB6849	
	2012.01-	Closed Off-Road Vehicle Engine L3Y7		o	GHA328012	
2.3 MZR DiSi Turbo (190 kW)	2007.10-	Closed Off-Road Vehicle Engine L3-VDT	•		GWB6849	
	2007.10-	Closed Off-Road Vehicle Engine L3-VDT		o	GHA328012	
2.3 MZR DiSi Turbo (191 kW)	2009.09-	Closed Off-Road Vehicle Engine L3-VDT	•		GWB6849	
	2009.09-	Closed Off-Road Vehicle Engine L3-VDT		o	GHA328012	
2.3 MZR DiSi Turbo AWD (175 kW)	2006.11-	Closed Off-Road Vehicle Engine L3-VDT	•		GWB6849	
	2006.11-	Closed Off-Road Vehicle Engine L3-VDT		o	GHA328012	
2.5 MZR (120 kW)	2009.09-	Closed Off-Road Vehicle Engine L5-VE	•		GWB6849	
CX-7 ER						
-	2006-2012		•		GHA431002	
	2006-2012			o	GHA400140	
CX-9 (TB)						
3.5 (193 kW)	2007.01-	Closed Off-Road Vehicle Engine CYC4		o	GHA328014	
	2007.01-	Closed Off-Road Vehicle Engine CYC4		o	GHA400359	
3.5 AWD (193 kW)	2007.01-	Closed Off-Road Vehicle Engine CYC4		o	GHA328014	
3.7 (204 kW)	2007.01-	Closed Off-Road Vehicle	•		GWB6849	
	2007.01-	Closed Off-Road Vehicle		o	GHA328014	
	2007.01-	Closed Off-Road Vehicle		o	GHA400359	
3.7 AWD (204 kW)	2007.01-	Closed Off-Road Vehicle Engine CA	•		GWB6849	
	2007.01-	Closed Off-Road Vehicle Engine CA		o	GHA328014	
DEMIO (DW)						
1.3 16V (46 kW)	1998.08-	Estate Engine B3ME	•		GWB1928	
	1998.08-	Estate Engine B3ME		o	GHA228046	K
	1998.08-	Estate Engine B3ME		o	GHA228072	
1.3 i 16V (53 kW)	1998.08-2000.04	Estate Engine B3	•		GWB1928	
	1998.08-2000.04	Estate Engine B3		o	GHA228046	K
	1998.08-2000.04	Estate Engine B3		o	GHA228072	
1.5 16V (55 kW)	2000.04-2003.07	Estate Engine B5E	•		GWB1928	
	2000.04-2003.07	Estate Engine B5E		o	GHA228046	K
E-SERIE (SR2)						
E2000 4WD (71 kW)	1997.04-1999.08	Box Engine FEY9	•		GWB3949	
MPV II (LW)						
2.0 (88 kW)	1999.10-2003.04	MPV Engine FS	•		GWB1948	
	1999.10-2003.04	MPV Engine FS With ABS		o	GHA236002	K
2.0 (90 kW)	1999.09-2000.08	MPV Engine FS-DS	•		GWB1948	
	1999.09-2000.08	MPV Engine FS-DS With ABS		o	GHA236002	K
2.0 Di (100 kW)	2002.07-2006.02	MPV Engine RF5C	•		GWB7446	
	2002.07-2006.02	MPV Engine RF5C With ABS		o	GHA236002	K
2.3 (104 kW)	2002.07-2006.02	MPV Engine L3	•		GWB7446	
	2002.07-2006.02	MPV Engine L3 With ABS		o	GHA236002	K
3.0 i V6 (147 kW)	2002.03-2006.02	MPV Engine AJ	•		GWB7446	
	2002.03-2006.02	MPV Engine AJ With ABS		o	GHA236002	K
MPV LY						
-	2006-		•		GHA431002	
MX-3 (EC)						
1.6 i (65 kW)	1991.07-	Coupe Engine B69	•		GWB1950	
	1991.07-	Coupe Engine B69		o	GHA230050	K
	1991.07-	Coupe Engine B69 With ABS 4 hole		o	GHA230037	K
	1991.07-	Coupe Engine B69 With ABS 4 hole		o	GHA230037	K
	1991.07-	Coupe Engine B69 Without ABS 4 hole		o	GHA230032	K
	1991.07-	Coupe Engine B69 Without ABS 4 hole		o	GHA230036	
1.6 i (79 kW)	1994.01-	Coupe Engine B6D	•		GWB1950	
	1994.01-	Coupe Engine B6D		o	GHA230050	K
	1994.01-	Coupe Engine B6D With ABS 4 hole		o	GHA230037	K
	1994.01-	Coupe Engine B6D With ABS 4 hole		o	GHA230037	K



	 YEAR		F	R	G-AP Ref.	KIT
MAZDA						
MX-3 (EC)						
1.6 i (79 kW)	1994.01- 1994.01-	Coupe Engine B6D Without ABS 4 hole Coupe Engine B6D Without ABS 4 hole		o	GHA230032 GHA230036	K
1.8 i V6 (95 kW)	1994.01- 1994.01- 1994.01- 1994.01- 1994.01- 1994.01-	Coupe Engine K838 Coupe Engine K838 Coupe Engine K838 With ABS 4 hole Coupe Engine K838 With ABS 4 hole Coupe Engine K838 Without ABS 4 hole Coupe Engine K838 Without ABS 4 hole	•	o	GWB1950 GHA230050 GHA230037 GHA230037 GHA230032 GHA230036	K
1.8 i V6 (98 kW)	1992.01-1994.01 1992.01-1994.01 1992.01-1994.01 1992.01-1994.01 1992.01-1994.01 1992.01-1994.01	Coupe Engine K819 Coupe Engine K819 Coupe Engine K819 With ABS 4 hole Coupe Engine K819 With ABS 4 hole Coupe Engine K819 Without ABS 4 hole Coupe Engine K819 Without ABS 4 hole	•	o	GWB1950 GHA230050 GHA230037 GHA230037 GHA230032 GHA230036	K
MX-5 (NA)						
1.6 (66 kW)	1995.01-1998.04 1995.01-1998.04	Convertible Convertible	•		GHA228046 GHA228056	K
1.6 (85 kW)	1990.05-1994.01 1990.05-1994.01 1990.05-1994.01	Convertible Engine B64F Convertible Engine B64F Convertible Engine B64F	•	o	GHA228046 GHA228056 GWB1950	K
1.8 (96 kW)	1994.02-1998.04 1994.02-1998.04	Convertible Engine BPF1 Convertible Engine BPF1	•		GHA228046 GHA228056	K
MX-5 I (NA)						
	1993.09-1997.12	Convertible Engine BPF1	•		GHA228046	K
MX-5 II (NB)						
1.6 16V (81 kW)	1998.05-2005.10 1998.05-2005.10 1998.05-2005.10	Convertible Engine B6D Convertible Engine B6D Convertible Engine B6D	•	o	GHA228046 GHA228056 GWB1950	K
1.8 (103 kW)	1998.01-2002.07 1998.01-2002.07	Convertible Engine BPD Convertible Engine BPD	•	o	GHA228046 GWB1950	K
1.8 (107 kW)	2002.08-2005.1 2002.08-2005.1	Convertible Engine BP6J Convertible Engine BP6J	•	o	GHA228046 GWB1950	K
1.8 16V (102 kW)	2000.11-2005.10 2000.11-2005.10 2000.11-2005.10	Convertible Engine BPD Convertible Engine BPD Convertible Engine BPD	•	o	GHA228046 GHA228056 GWB1950	K
1.8 16V (103 kW)	1998.05-2005.10 1998.05-2005.10 1998.05-2005.10	Convertible Engine BP-ZE Convertible Engine BP-ZE Convertible Engine BP-ZE	•	o	GHA228046 GHA228056 GWB1950	K
1.8 16V (107 kW)	2000.11-2005.10 2000.11-2005.10 2000.11-2005.10	Convertible Engine BPD Convertible Engine BPD Convertible Engine BPD	•	o	GHA228046 GHA228056 GWB1950	K
MX-5 III (NC)						
1.8 (93 kW)	2005.03- 2005.03-	Convertible Engine L828/L8-DE Convertible Engine L828/L8-DE	•	o	GHA400151 GWB7446	
2.0 (118 kW)	2005.08-2008.02 2005.08-2008.02	Convertible Engine LF62/LF-DE Convertible Engine LF62/LF-DE	•	o	GHA400151 GWB7446	
MX-6 (GE)						
2.0 (85 kW)	1992.02-1997.02 1992.02-1997.02 1992.02-1997.02	Coupe Engine FS Coupe Engine FS With ABS Coupe Engine FS Without ABS	•	o	GWB1948 GHA233002 GHA233009	F
2.5 24V (121 kW)	1992.02-1997.02 1992.02-1997.02 1992.02-1997.02	Coupe Engine KL Coupe Engine KL With ABS Coupe Engine KL Without ABS	•	o	GWB1948 GHA233002 GHA233009	F
2.5 i 24V (120 kW)	1994.08-1997.02 1994.08-1997.02 1994.08-1997.02	Coupe Engine KL Coupe Engine KL With ABS Coupe Engine KL Without ABS	•	o	GWB1948 GHA233002 GHA233009	F
PREMACY (CP)						
1.9 (74 kW)	1999.07-2005.03 1999.07-2005.03 1999.07-2005.03	MPV Engine FP MPV Engine FP With ABS MPV Engine FP Without ABS 4 hole	•	o	GWB1950 GHA236002 GHA230032	K
1.9 (84 kW)	1999.07-2005.03 1999.07-2005.03 1999.07-2005.03	MPV Engine FP MPV Engine FP With ABS MPV Engine FP Without ABS 4 hole	•	o	GWB1950 GHA236002 GHA230032	K



	 YEAR		F	R	G-AP Ref.	KIT
MAZDA						
PREMACY (CP)						
2.0 (96 kW)	2001.11-2005.03	MPV Engine FS7E/FS7G	•		GWB1950	
	2001.11-2005.03	MPV Engine FS7E/FS7G With ABS		○	GHA236002	K
	2001.11-2005.03	MPV Engine FS7E/FS7G Without ABS 4 hole		○	GHA230032	K
2.0 TD (66 kW)	1999.10-	MPV Engine RF3F	•		GWB1950	
	1999.10-	MPV Engine RF3F With ABS		○	GHA236002	K
	1999.10-	MPV Engine RF3F Without ABS 4 hole		○	GHA230032	K
2.0 TD (74 kW)	2000.07-2005.03	MPV Engine RF4F	•		GWB1950	
	2000.07-2005.03	MPV Engine RF4F With ABS		○	GHA236002	K
	2000.07-2005.03	MPV Engine RF4F Without ABS 4 hole		○	GHA230032	K
RX 8 (SE17)						
2.6 Wankel (141 kW)	2003.10-2012.06	Coupe Engine 13B-MSP	•		GHA400155	
2.6 Wankel (170 kW)	2003.10-2012.06	Coupe Engine 13B-MSP	•		GHA400155	
	2003.10-2012.06	Coupe Engine 13B-MSP	•		GHA400156	
XEDOS 6 (CA)						
1.6 16V (79 kW)	1994.06-1999.10	Saloon Engine B6(DOHC)	•		GWB1948	
	1994.06-1999.10	Saloon Engine B6(DOHC) With ABS		○	GHA233002	F
	1994.06-1999.10	Saloon Engine B6(DOHC) Without ABS		○	GHA233009	K
1.6 16V (83 kW)	1992.08-1994.05	Saloon Engine B69	•		GWB1948	
	1992.08-1994.05	Saloon Engine B69 With ABS		○	GHA233002	F
	1992.08-1994.05	Saloon Engine B69 Without ABS		○	GHA233009	K
2.0 V6 (103 kW)	1994.06-1999.10	Saloon Engine KF1	•		GWB1948	
	1994.06-1999.10	Saloon Engine KF1 With ABS		○	GHA233002	F
	1994.06-1999.10	Saloon Engine KF1 Without ABS		○	GHA233009	K
2.0 V6 (106 kW)	1992.01-1994.05	Saloon Engine KF1	•		GWB1948	
	1992.01-1994.05	Saloon Engine KF1 With ABS		○	GHA233002	F
	1992.01-1994.05	Saloon Engine KF1 Without ABS		○	GHA233009	K
XEDOS 9 (TA)						
2.0 24V (105 kW)	1993.08-2000.01	Saloon Engine KF	•		GWB1948	
	1993.08-2000.01	Saloon Engine KF With ABS		○	GHA233002	F
2.3 24V (155 kW)	1995.02-2000.01	Saloon Engine KJ-ZEM	•		GWB1948	
	1995.02-2000.01	Saloon Engine KJ-ZEM With ABS		○	GHA233002	F
2.5 24V (123 kW)	1993.07-2000.07	Saloon Engine KL	•		GWB1948	
	1993.07-2000.07	Saloon Engine KL With ABS		○	GHA233002	F
2.5 V6 (120 kW)	1994.01-1998.09	Saloon Engine KL With ABS		○	GHA233002	F
	1994.01-1998.09	Saloon Engine KL With ABS		○	GHA236002	K
MERCEDES BENZ						
100 (631)						
2.4 D (41 kW)	1990.12-1994.12	Bus Engine OM616	•		GWB3404	
	1990.12-1994.12	Bus Engine OM616		○	GWB3405	
2.4 D (55 kW)	1990.12-1996.02	Box Engine OM616.963	•		GWB3404	
	1990.12-1996.02	Box Engine OM616.963		○	GWB3405	
	1990.12-1996.02	Bus Engine OM616/OM616.963	•		GWB3404	
	1990.12-1996.02	Bus Engine OM616/OM616.963		○	GWB3405	
	1990.12-1996.02	Platform/Chassis Engine OM616.963	•		GWB3404	
	1990.12-1996.02	Platform/Chassis Engine OM616.963		○	GWB3405	
190 (W201)						
E 1.8 (80 kW)	1990.04-1993.08	Saloon Engine M102.910	•		GWB0756	
	1990.04-1993.08	Saloon Engine M102.910		○	GWB0757	
A-CLASS (W168)						
A 140 (60 kW)	1997.07-2004.08	Hatchback Engine M166.940	•		GHA424010	
	1997.07-2004.08	Hatchback Engine M166.940	•		GWB3520	
	1997.07-2004.08	Hatchback Engine M166.940		○	GWB3521	
	1997.07-2004.08	Hatchback Engine M166.940		○	GWB6508	
	2001.01-2004.08	Hatchback Engine M166.960	•		GHA424010	
	2001.01-2004.08	Hatchback Engine M166.960	•		GWB3520	
	2001.01-2004.08	Hatchback Engine M166.960		○	GWB3521	
	2001.01-2004.08	Hatchback Engine M166.960		○	GWB6508	
	A 160 (75 kW)	1997.07-2004.08	Hatchback Engine M166.960	•		GHA424010
1997.07-2004.08		Hatchback Engine M166.960	•		GWB3520	
1997.07-2004.08		Hatchback Engine M166.960		○	GHA499047	
1997.07-2004.08		Hatchback Engine M166.960		○	GWB3521	
1997.07-2004.08		Hatchback Engine M166.960		○	GWB6508	



	 YEAR		F	R	G-AP Ref.	KIT
MERCEDES BENZ						
A-CLASS (W168)						
A 160 CDi (44 kW)	1998.07-2001.02	Hatchback Engine OM668.941	•		GHA424010	
	1998.07-2001.02	Hatchback Engine OM668.941	•		GWB3520	
	1998.07-2001.02	Hatchback Engine OM668.941		○	GWB3521	
A 160 CDi (55 kW)	2001.02-2004.08	Hatchback Engine OM668.940	•		GHA424010	
	2001.02-2004.08	Hatchback Engine OM668.940	•		GWB3520	
	2001.02-2004.08	Hatchback Engine OM668.940		○	GWB3521	
	2001.02-2004.08	Hatchback Engine OM668.940		○	GWB6508	
A 170 CDi (66 kW)	1998.07-2001.02	Hatchback Engine OM668.940	•		GHA424010	
	1998.07-2001.02	Hatchback Engine OM668.940	•		GWB3520	
	1998.07-2001.02	Hatchback Engine OM668.940		○	GWB3521	
A 170 CDi (70 kW)	2001.02-2004.08	Hatchback Engine OM668.942	•		GHA424010	
	2001.02-2004.08	Hatchback Engine OM668.942	•		GWB3520	
	2001.02-2004.08	Hatchback Engine OM668.942		○	GWB3521	
	2001.02-2004.08	Hatchback Engine OM668.942		○	GWB6508	
A 190 (92 kW)	1999.03-2004.08	Hatchback Engine M166.990	•		GHA424010	
	1999.03-2004.08	Hatchback Engine M166.990	•		GWB3520	
	1999.03-2004.08	Hatchback Engine M166.990		○	GWB3521	
	1999.03-2004.08	Hatchback Engine M166.990		○	GWB6508	
A 210 (103 kW)	2002.03-2004.08	Hatchback Engine M166.995	•		GHA424010	
	2002.03-2004.08	Hatchback Engine M166.995	•		GWB3520	
	2002.03-2004.08	Hatchback Engine M166.995		○	GWB6508	
A-CLASS (W169)						
A 150 (70 kW)	2004.12-2007.03	Hatchback Engine M266.920	•		GWB6509	
	2004.12-2007.03	Hatchback Engine M266.920		○	GHA400240	K
A 160 (70 kW)	2009.04-2012.06	Hatchback Engine M266.920	•		GWB6509	
	2009.04-2012.06	Hatchback Engine M266.920		○	GHA400240	K
A 160 CDi (60 kW)	2004.12-2007.03	Hatchback Engine OM640.942	•		GWB6509	
	2004.12-2007.03	Hatchback Engine OM640.942		○	GHA400240	K
A 170 (85 kW)	2004.12-2007.03	Hatchback Engine M266.940	•		GWB6509	
	2004.12-2007.03	Hatchback Engine M266.940		○	GHA400240	K
A 180 (85 kW)	2009.04-2012.06	Hatchback Engine M266.940	•		GWB6509	
	2009.04-2012.06	Hatchback Engine M266.940		○	GHA400240	K
A 180 CDi (80 kW)	2004.12-2007.03	Hatchback Engine OM640.940	•		GWB6509	
	2004.12-2007.03	Hatchback Engine OM640.940		○	GHA400240	K
A 200 (100 kW)	2004.12-2007.03	Hatchback Engine M266.960	•		GWB6509	
	2004.12-2007.03	Hatchback Engine M266.960		○	GHA400240	K
A 200 CDi (100 kW)	2004.09-2012.06	Hatchback Engine OM640.941	•		GWB6509	
	2004.09-2012.06	Hatchback Engine OM640.941		○	GHA400240	K
A 200 CDi (103 kW)	2004.12-2012.06	Hatchback Engine OM640.941	•		GWB6509	
	2004.12-2012.06	Hatchback Engine OM640.941		○	GHA400240	K
A 200 TURBO (142 kW)	2005.10-2012.06	Hatchback Engine M266.980	•		GWB6509	
	2005.10-2012.06	Hatchback Engine M266.980		○	GHA400240	K
E-CELL (50 kW)	2010.12-2012.06	Hatchback Engine EM780.992	•		GWB6509	
	2010.12-2012.06	Hatchback Engine EM780.992		○	GHA400240	K
B-CLASS (W245)						
B 150 (70 kW)	2005.07-2011.11	Hatchback Engine M266.920	•		GWB6509	
	2005.07-2011.11	Hatchback Engine M266.920		○	GHA400240	K
B 160 (70 kW)	2009.04-2011.11	Hatchback Engine M266.920	•		GWB6509	
	2009.04-2011.11	Hatchback Engine M266.920		○	GHA400240	K
B 170 (85 kW)	2005.07-2011.11	Hatchback Engine M266.940	•		GWB6509	
	2005.07-2011.11	Hatchback Engine M266.940		○	GHA400240	K
B 170 NGT (85 kW)	2008.04-2011.11	Hatchback Engine M266.960	•		GWB6509	
	2008.04-2011.11	Hatchback Engine M266.960		○	GHA400240	K
B 180 (85 kW)	2009.04-2011.11	Hatchback Engine M266.940	•		GWB6509	
	2009.04-2011.11	Hatchback Engine M266.940		○	GHA400240	K
B 180 CDi (80 kW)	2005.07-2011.11	Hatchback Engine OM640.940	•		GWB6509	
	2005.07-2011.11	Hatchback Engine OM640.940		○	GHA400240	K
B 180 NGT (85 kW)	2008.04-2011.11	Hatchback Engine M266.960	•		GWB6509	
	2008.04-2011.11	Hatchback Engine M266.960		○	GHA400240	K
B 200 (100 kW)	2005.07-2011.11	Hatchback Engine M266.960	•		GWB6509	
	2005.07-2011.11	Hatchback Engine M266.960		○	GHA400240	K
B 200 CDi (100 kW)	2005.03-2011.11	Hatchback Engine OM640.941	•		GWB6509	
	2005.03-2011.11	Hatchback Engine OM640.941		○	GHA400240	K
B 200 CDi (103 kW)	2005.07-2011.11	Hatchback Engine OM640.941	•		GWB6509	



	 YEAR		F	R	G-AP Ref.	KIT
MERCEDES BENZ						
B-CLASS (W245)						
B 200 CDi (103 kW)	2005.07-2011.11	Hatchback Engine OM640.941		o	GHA400240	K
B 200 TURBO (142 kW)	2005.07-2011.11	Hatchback Engine M266.980	•		GWB6509	
	2005.07-2011.11	Hatchback Engine M266.980		o	GHA400240	K
CABRIOLET (A124)						
300 CE-24 (170 kW)	1992.04-1993.06	Convertible Engine M 104.980	•		GWB1498	
	1992.04-1993.06	Convertible Engine M 104.980		o	GWB0757	
300 CE-24 (162 kW)	1992.04-1993.06	Convertible Engine M104.980	•		GWB1498	
	1992.04-1993.06	Convertible Engine M104.980		o	GWB0757	
C-CLASS (C204)						
C 180 (115 kW)	2011.06-	Coupe Engine M271.820	•		GHA499042	
	2011.06-	Coupe Engine M271.820	•		GWB6530	
	2011.06-	Coupe Engine M271.820		o	GHA249005	K
	2013.01-	Coupe Engine M274.910	•		GWB6530	
	2013.01-	Coupe Engine M274.910		o	GHA249005	K
C 200 CGi (135 kW)	2011.06-	Coupe Engine M271.820	•		GWB6530	
	2011.06-	Coupe Engine M271.820		o	GHA249005	K
C 220 CDi (120 kW)	2011.06-	Coupe Engine OM 651.911	•		GHA499042	
C 220 CDi (125 kW)	2011.06-	Coupe Engine OM651.911	•		GHA499042	
	2011.06-	Coupe Engine OM651.911	•		GWB6530	
	2011.06-	Coupe Engine OM651.911		o	GHA249005	K
C 250 (150 kW)	2011.06-	Coupe Engine M271.860	•		GHA499042	
	2011.06-	Coupe Engine M271.860	•		GWB6530	
	2011.06-	Coupe Engine M271.860		o	GHA249005	K
C 250 CDi (150 kW)	2011.06-	Coupe Engine OM651.911	•		GHA499042	
	2011.06-	Coupe Engine OM651.911	•		GWB6530	
	2011.06-	Coupe Engine OM651.911		o	GHA249005	K
C 350 (225 kW)	2011.06-	Coupe Engine M276.957	•		GHA499042	
	2011.06-	Coupe Engine M276.957	•		GWB6530	
	2011.06-	Coupe Engine M276.957		o	GHA249005	K
C 63 AMG (373 kW)	2012.11-	Coupe Engine M 156.985		o	GHA249005	K
C 63 AMG (336 kW)	2011.06-	Coupe Engine M156.985		o	GHA249005	K
C 63 AMG (358 kW)	2012.01-	Coupe Engine M156.985		o	GHA249005	K
C 63 AMG (380 kW)	2012.01-	Coupe Engine M156.985		o	GHA249005	K
C-CLASS (CL203)						
C 160 Kompressor (90 kW)	2005.04-2008.03	Coupe Engine M271.921	•		GWB6530	
	2005.04-2008.03	Coupe Engine M271.921		o	GHA425048	
	2005.04-2008.03	Coupe Engine M271.921		o	GWB0757	
C 180 (95 kW)	2001.03-2002.05	Coupe Engine M111.951	•		GWB6530	
	2001.03-2002.05	Coupe Engine M111.951		o	GHA425048	
	2001.03-2002.05	Coupe Engine M111.951		o	GWB0757	
C 180 Kompressor (105 kW)	2002.05-2008.05	Coupe Engine M271.946	•		GWB6530	
	2002.05-2008.05	Coupe Engine M271.946		o	GHA425048	
	2002.05-2008.05	Coupe Engine M271.946		o	GWB0757	
C 200 CDi (90 kW)	2003.03-2008.05	Coupe Engine OM646.962	•		GWB6530	
	2003.03-2008.05	Coupe Engine OM646.962		o	GHA425048	
	2003.03-2008.05	Coupe Engine OM646.962		o	GWB0757	
C 200 CGi Kompressor (125 kW)	2003.03-2008.05	Coupe Engine M271.942	•		GWB6530	
	2003.03-2008.05	Coupe Engine M271.942		o	GHA425048	
	2003.03-2008.05	Coupe Engine M271.942		o	GWB0757	
C 200 Kompressor (120 kW)	2001.03-2002.05	Coupe Engine M111.955	•		GWB6530	
	2001.03-2002.05	Coupe Engine M111.955		o	GHA425048	
	2001.03-2002.05	Coupe Engine M111.955		o	GWB0757	
	2002.05-2008.05	Coupe Engine M271.940	•		GWB6530	
	2002.05-2008.05	Coupe Engine M271.940		o	GHA425048	
	2002.05-2008.05	Coupe Engine M271.940		o	GWB0757	
C 220 (120 kW)	2002.05-2008.05	Coupe Engine M271.940	•		GWB6530	
	2002.05-2008.05	Coupe Engine M271.940		o	GWB0757	
C 220 CDi (100 kW)	2001.03-2004.01	Coupe Engine OM 611.962	•		GWB6530	
	2001.03-2004.01	Coupe Engine OM 611.962		o	GHA425048	
	2001.03-2004.01	Coupe Engine OM 611.962		o	GWB0757	
C 220 CDi (105 kW)	2001.03-2008.05	Coupe Engine OM611.962	•		GWB6530	
	2001.03-2008.05	Coupe Engine OM611.962		o	GHA425048	
	2001.03-2008.05	Coupe Engine OM611.962		o	GWB0757	
C 220 CDi (110 kW)	2004.02-2008.05	Coupe Engine OM646.963	•		GWB6530	



	 YEAR		F	R	G-AP Ref.	KIT
MERCEDES BENZ						
C-CLASS (CL203)						
C 220 CDi (110 kW)	2004.02-2008.05	Coupe Engine OM646.963		o	GHA425048	
	2004.02-2008.05	Coupe Engine OM646.963		o	GWB0757	
C 230 (150 kW)	2005.06-2008.05	Coupe Engine M272.920	•		GWB6530	
	2005.06-2008.05	Coupe Engine M272.920		o	GHA425048	
	2005.06-2008.05	Coupe Engine M272.920		o	GWB0757	
C 230 Kompressor (141 kW)	2002.05-2008.05	Coupe Engine M271.948	•		GWB6530	
	2002.05-2008.05	Coupe Engine M271.948		o	GHA425048	
	2002.05-2008.05	Coupe Engine M271.948		o	GWB0757	
C 230 Kompressor (145 kW)	2001.03-2002.05	Coupe Engine M111.981	•		GWB6530	
	2001.03-2002.05	Coupe Engine M111.981		o	GHA425048	
	2001.03-2002.05	Coupe Engine M111.981		o	GWB0757	
C 30 CDi AMG (170 kW)	2002.09-2008.05	Coupe Engine OM612.990	•		GWB6530	
	2002.09-2008.05	Coupe Engine OM612.990		o	GHA425048	
	2002.09-2008.05	Coupe Engine OM612.990		o	GWB0757	
C 32 AMG Kompressor (260 kW)	2002.05-2008.05	Coupe Engine M112.961	•		GWB6530	
	2002.05-2008.05	Coupe Engine M112.961		o	GWB0757	
C 320 (160 kW)	2002.09-2008.05	Coupe Engine M112.946	•		GWB6530	
	2002.09-2008.05	Coupe Engine M112.946		o	GHA425048	
	2002.09-2008.05	Coupe Engine M112.946		o	GWB0757	
C 350 (200 kW)	2005.06-2008.05	Coupe Engine M272.960	•		GWB6530	
	2005.06-2008.05	Coupe Engine M272.960		o	GHA425048	
	2005.06-2008.05	Coupe Engine M272.960		o	GWB0757	
C-CLASS (S202)						
C 180 T (90 kW)	1996.06-2000.09	Estate Engine M111.920/M111.921	•		GHA235024	K
	1996.06-2000.09	Estate Engine M111.920/M111.921	•		GWB1498	
	1996.06-2000.09	Estate Engine M111.920/M111.921		o	GHA425048	
	1996.06-2000.09	Estate Engine M111.920/M111.921		o	GWB0757	
C 180 T (95 kW)	2000.09-2001.03	Estate Engine M111.952	•		GHA235024	K
	2000.09-2001.03	Estate Engine M111.952	•		GWB1498	
	2000.09-2001.03	Estate Engine M111.952		o	GHA425048	
	2000.09-2001.03	Estate Engine M111.952		o	GWB0757	
C 200 T (100 kW)	1996.06-2001.03	Estate Engine M111.941/M111.945	•		GHA235024	K
	1996.06-2001.03	Estate Engine M111.941/M111.945	•		GWB1498	
	1996.06-2001.03	Estate Engine M111.941/M111.945		o	GHA425048	
	1996.06-2001.03	Estate Engine M111.941/M111.945		o	GWB0757	
C 200 T CDi (75 kW)	1998.03-2001.03	Estate Engine OM611.960	•		GHA235024	K
	1998.03-2001.03	Estate Engine OM611.960	•		GWB1498	
	1998.03-2001.03	Estate Engine OM611.960		o	GHA425048	
	1998.03-2001.03	Estate Engine OM611.960		o	GWB0757	
C 200 T D (65 kW)	1996.10-2001.03	Estate Engine OM604.915	•		GHA235024	K
	1996.10-2001.03	Estate Engine OM604.915	•		GWB1498	
	1996.10-2001.03	Estate Engine OM604.915		o	GHA425048	
	1996.10-2001.03	Estate Engine OM604.915		o	GWB0757	
C 200 T Kompressor (120 kW)	2000.09-2001.03	Estate Engine M111.956	•		GHA235024	K
	2000.09-2001.03	Estate Engine M111.956	•		GWB1498	
	2000.09-2001.03	Estate Engine M111.956		o	GHA425048	
	2000.09-2001.03	Estate Engine M111.956		o	GWB0757	
C 200 T Kompressor (141 kW)	1996.11-2001.03	Estate Engine M111.944	•		GHA235024	K
	1996.11-2001.03	Estate Engine M111.944	•		GWB1498	
	1996.11-2001.03	Estate Engine M111.944		o	GHA425048	
	1996.11-2001.03	Estate Engine M111.944		o	GWB0757	
C 220 T CDi (92 kW)	1997.09-2001.03	Estate Engine OM611.960	•		GHA235024	K
	1997.09-2001.03	Estate Engine OM611.960	•		GWB1498	
	1997.09-2001.03	Estate Engine OM611.960		o	GHA425048	
	1997.09-2001.03	Estate Engine OM611.960		o	GWB0757	
C 220 T D (55 kW)	1996.06-2001.03	Estate Engine OM604.910	•		GWB1498	
	1996.06-2001.03	Estate Engine OM604.910		o	GHA425048	
	1996.06-2001.03	Estate Engine OM604.910		o	GWB0757	
C 220 T D (70 kW)	1996.06-1998.09	Estate Engine OM604.910	•		GHA235024	K
	1996.06-1998.09	Estate Engine OM604.910	•		GWB1498	
	1996.06-1998.09	Estate Engine OM604.910		o	GHA425048	
	1996.06-1998.09	Estate Engine OM604.910		o	GWB0757	
C 230 T (110 kW)	1996.06-1998.06	Estate Engine M111.974	•		GHA235024	K
	1996.06-1998.06	Estate Engine M111.974	•		GWB1498	



	 YEAR		F	R	G-AP Ref.	KIT
MERCEDES BENZ						
C-CLASS (S202)						
C 230 T (110 kW)	1996.06-1998.06	Estate Engine M111.974		o	GHA425048	
	1996.06-1998.06	Estate Engine M111.974		o	GWB0757	
C 230 T Kompressor (142 kW)	1997.06-2000.09	Estate Engine M111.975	•		GHA235024	K
	1997.06-2000.09	Estate Engine M111.975	•		GWB1498	
	1997.06-2000.09	Estate Engine M111.975		o	GHA425048	
	1997.06-2000.09	Estate Engine M111.975		o	GWB0757	
C 240 T (125 kW)	1997.06-2000.09	Estate Engine M112.910	•		GHA235024	K
	1997.06-2000.09	Estate Engine M112.910	•		GWB1498	
	1997.06-2000.09	Estate Engine M112.910		o	GHA425048	
	1997.06-2000.09	Estate Engine M112.910		o	GWB0757	
	2000.09-2001.03	Estate Engine M112.915	•		GHA235024	K
	2000.09-2001.03	Estate Engine M112.915	•		GWB1498	
	2000.09-2001.03	Estate Engine M112.915		o	GHA425048	
	2000.09-2001.03	Estate Engine M112.915		o	GWB0757	
C 250 T Turbo-D (110 kW)	1996.06-2001.03	Estate Engine OM605.960	•		GHA235024	K
	1996.06-2001.03	Estate Engine OM605.960	•		GWB1498	
	1996.06-2001.03	Estate Engine OM605.960		o	GHA425048	
	1996.06-2001.03	Estate Engine OM605.960		o	GWB0757	
C 280 T (145 kW)	1997.06-2001.03	Estate Engine M112.920	•		GHA235024	K
	1997.06-2001.03	Estate Engine M112.920	•		GWB1498	
	1997.06-2001.03	Estate Engine M112.920		o	GHA425048	
	1997.06-2001.03	Estate Engine M112.920		o	GWB0757	
C 43 AMG (225 kW)	1997.08-2001.03	Estate Engine M113.944	•		GHA235024	K
	1997.08-2001.03	Estate Engine M113.944	•		GWB1498	
	1997.08-2001.03	Estate Engine M113.944		o	GHA425048	
	1997.08-2001.03	Estate Engine M113.944		o	GWB0757	
C-CLASS (W202)						
C 180 (89 kW)	1994.11-2000.05	Saloon Engine M111.921	•		GWB1498	
	1994.11-2000.05	Saloon Engine M111.921		o	GHA425048	
	1994.11-2000.05	Saloon Engine M111.921		o	GWB0757	
C 180 (90 kW)	1993.03-2000.05	Saloon Engine M111.920/M111.921	•		GHA235024	K
	1993.03-2000.05	Saloon Engine M111.920/M111.921	•		GWB1498	
	1993.03-2000.05	Saloon Engine M111.920/M111.921		o	GHA425048	
	1993.03-2000.05	Saloon Engine M111.920/M111.921		o	GWB0757	
C 200 (100 kW)	1994.01-2000.05	Saloon Engine M111.941/M111.945	•		GHA235024	K
	1994.01-2000.05	Saloon Engine M111.941/M111.945	•		GWB1498	
	1994.01-2000.05	Saloon Engine M111.941/M111.945		o	GHA425048	
	1994.01-2000.05	Saloon Engine M111.941/M111.945		o	GWB0757	
C 200 CDi (75 kW)	1998.03-2000.05	Saloon Engine OM611.960	•		GHA235024	K
	1998.03-2000.05	Saloon Engine OM611.960	•		GWB1498	
	1998.03-2000.05	Saloon Engine OM611.960		o	GHA425048	
	1998.03-2000.05	Saloon Engine OM611.960		o	GWB0757	
C 200 D (55 kW)	1993.03-2000.05	Saloon Engine OM601.913	•		GHA235024	K
	1993.03-2000.05	Saloon Engine OM601.913	•		GWB1498	
	1993.03-2000.05	Saloon Engine OM601.913		o	GHA425048	
	1993.03-2000.05	Saloon Engine OM601.913		o	GWB0757	
C 200 D (65 kW)	1996.10-2000.05	Saloon Engine OM604.915	•		GHA235024	K
	1996.10-2000.05	Saloon Engine OM604.915	•		GWB1498	
	1996.10-2000.05	Saloon Engine OM604.915		o	GHA425048	
	1996.10-2000.05	Saloon Engine OM604.915		o	GWB0757	
C 200 Kompressor (132 kW)	1995.10-2000.05	Saloon Engine M111.944	•		GWB1498	
	1995.10-2000.05	Saloon Engine M111.944		o	GHA425048	
	1995.10-2000.05	Saloon Engine M111.944		o	GWB0757	
C 200 Kompressor (141 kW)	1996.11-2000.05	Saloon Engine M111.944	•		GHA235024	K
	1996.11-2000.05	Saloon Engine M111.944	•		GWB1498	
	1996.11-2000.05	Saloon Engine M111.944		o	GHA425048	
	1996.11-2000.05	Saloon Engine M111.944		o	GWB0757	
C 220 (110 kW)	1993.03-2000.05	Saloon Engine M111.961	•		GHA235024	K
	1993.03-2000.05	Saloon Engine M111.961	•		GWB1498	
	1993.03-2000.05	Saloon Engine M111.961		o	GHA425048	
	1993.03-2000.05	Saloon Engine M111.961		o	GWB0757	
C 220 CDi (92 kW)	1997.09-2000.05	Saloon Engine OM611.960	•		GHA235024	K
	1997.09-2000.05	Saloon Engine OM611.960	•		GWB1498	
	1997.09-2000.05	Saloon Engine OM611.960		o	GHA425048	



	 YEAR		F	R	G-AP Ref.	KIT
MERCEDES BENZ						
C-CLASS (W202)						
C 220 CDi (92 kW)	1997.09-2000.05	Saloon Engine OM611.960		o	GWB0757	
C 220 D (55 kW)	1996.07-2000.05	Saloon Engine OM604.910	•		GWB1498	
	1996.07-2000.05	Saloon Engine OM604.910		o	GHA425048	
C 220 D (70 kW)	1996.07-2000.05	Saloon Engine OM604.910		o	GWB0757	
	1993.08-2000.05	Saloon Engine OM604.910	•		GHA235024	K
	1993.08-2000.05	Saloon Engine OM604.910	•		GWB1498	
	1993.08-2000.05	Saloon Engine OM604.910		o	GHA425048	
C 230 (110 kW)	1993.08-2000.05	Saloon Engine OM604.910		o	GWB0757	
	1996.06-1997.06	Saloon Engine M111.974	•		GHA235024	K
	1996.06-1997.06	Saloon Engine M111.974	•		GWB1498	
	1996.06-1997.06	Saloon Engine M111.974		o	GHA425048	
C 230 Kompressor (142 kW)	1996.06-1997.06	Saloon Engine M111.974		o	GWB0757	
	1995.10-2000.05	Saloon Engine M111.975	•		GHA235024	K
	1995.10-2000.05	Saloon Engine M111.975	•		GWB1498	
	1995.10-2000.05	Saloon Engine M111.975		o	GHA425048	
C 240 (125 kW)	1995.10-2000.05	Saloon Engine M111.975		o	GWB0757	
	1997.06-2000.05	Saloon Engine M112.910	•		GHA235024	K
	1997.06-2000.05	Saloon Engine M112.910	•		GWB1498	
	1997.06-2000.05	Saloon Engine M112.910		o	GHA425048	
C 250 D (83 kW)	1997.06-2000.05	Saloon Engine M112.910		o	GWB0757	
	1993.05-2000.05	Saloon Engine OM605.910	•		GHA235024	K
	1993.05-2000.05	Saloon Engine OM605.910	•		GWB1498	
	1993.05-2000.05	Saloon Engine OM605.910		o	GHA425048	
C 250 Turbo-D (110 kW)	1993.05-2000.05	Saloon Engine OM605.910		o	GWB0757	
	1995.10-2000.05	Saloon Engine OM605.960	•		GHA235024	K
	1995.10-2000.05	Saloon Engine OM605.960	•		GWB1498	
	1995.10-2000.05	Saloon Engine OM605.960		o	GHA425048	
C 280 (142 kW)	1995.10-2000.05	Saloon Engine OM605.960		o	GWB0757	
	1993.05-2000.05	Saloon Engine M104.941	•		GHA235024	K
	1993.05-2000.05	Saloon Engine M104.941	•		GWB1498	
	1993.05-2000.05	Saloon Engine M104.941		o	GHA425048	
C 280 (145 kW)	1993.05-2000.05	Saloon Engine M104.941		o	GWB0757	
	1997.06-2000.05	Saloon Engine M112.920	•		GHA235024	K
	1997.06-2000.05	Saloon Engine M112.920	•		GWB1498	
	1997.06-2000.05	Saloon Engine M112.920		o	GHA425048	
C 36 AMG (206 kW)	1997.06-2000.05	Saloon Engine M112.920		o	GWB0757	
	1994.05-2000.05	Saloon Engine M104.941	•		GHA235024	K
	1994.05-2000.05	Saloon Engine M104.941	•		GWB1498	
	1994.05-2000.05	Saloon Engine M104.941		o	GHA425048	
C 43 AMG (225 kW)	1994.05-2000.05	Saloon Engine M104.941		o	GWB0757	
	1997.08-2000.05	Saloon Engine M113.944	•		GHA235024	K
	1997.08-2000.05	Saloon Engine M113.944	•		GWB1498	
	1997.08-2000.05	Saloon Engine M113.944		o	GWB0757	
C-CLASS (W203)						
C 180 (95 kW)	2000.10-2002.05	Saloon Engine M111.951	•		GWB6530	
	2000.10-2002.05	Saloon Engine M111.951		o	GHA425048	
	2000.10-2002.05	Saloon Engine M111.951		o	GWB0757	
C 180 Kompressor (105 kW)	2002.05-2007.02	Saloon Engine M271.946	•		GWB6530	
	2002.05-2007.02	Saloon Engine M271.946		o	GHA425048	
	2002.05-2007.02	Saloon Engine M271.946		o	GWB0757	
C 200 CDi (75 kW)	2001.02-2007.02	Saloon Engine OM646.962	•		GWB6530	
	2001.02-2007.02	Saloon Engine OM646.962		o	GHA425048	
	2001.02-2007.02	Saloon Engine OM646.962		o	GWB0757	
C 200 CDi (85 kW)	2000.09-2007.02	Saloon Engine OM611.962	•		GWB6530	
	2000.09-2007.02	Saloon Engine OM611.962		o	GHA425048	
	2000.09-2007.02	Saloon Engine OM611.962		o	GWB0757	
C 200 CDi (90 kW)	2003.04-2007.02	Saloon Engine OM646.962	•		GWB6530	
	2003.04-2007.02	Saloon Engine OM646.962		o	GHA425048	
	2003.04-2007.02	Saloon Engine OM646.962		o	GWB0757	
C 200 CGi Kompressor (125 kW)	2003.07-2007.02	Saloon Engine M271.942	•		GWB6530	
	2003.07-2007.02	Saloon Engine M271.942		o	GHA425048	
	2003.07-2007.02	Saloon Engine M271.942		o	GWB0757	
C 200 Kompressor (120 kW)	2000.05-2002.06	Saloon Engine M111.955	•		GWB6530	
	2000.05-2002.06	Saloon Engine M111.955		o	GHA425048	



	 YEAR		F	R	G-AP Ref.	KIT
MERCEDES BENZ						
C-CLASS (W203)						
C 200 Kompressor (120 kW)	2000.05-2002.06	Saloon Engine M111.955		o	GWB0757	
	2002.05-2007.02	Saloon Engine M271.940	•		GWB6530	
	2002.05-2007.02	Saloon Engine M271.940		o	GHA425048	
	2002.05-2007.02	Saloon Engine M271.940		o	GWB0757	
C 220 CDi (100 kW)	2000.05-2007.02	Saloon Engine OM611.962	•		GWB6530	
	2000.05-2007.02	Saloon Engine OM611.962		o	GHA425048	
	2000.05-2007.02	Saloon Engine OM611.962		o	GWB0757	
C 220 CDi (105 kW)	2000.05-2007.02	Saloon Engine OM611.962	•		GWB6530	
	2000.05-2007.02	Saloon Engine OM611.962		o	GHA425048	
	2000.05-2007.02	Saloon Engine OM611.962		o	GWB0757	
C 220 CDi (110 kW)	2004.02-2008.04	Saloon Engine OM646.963	•		GWB6530	
	2004.02-2008.04	Saloon Engine OM646.963		o	GHA425048	
	2004.02-2008.04	Saloon Engine OM646.963		o	GWB0757	
C 230 (150 kW)	2005.06-2008.03	Saloon Engine M272.920	•		GWB6530	
	2005.06-2008.03	Saloon Engine M272.920		o	GHA425048	
	2005.06-2008.03	Saloon Engine M272.920		o	GWB0757	
C 230 Kompressor (141 kW)	2004.02-2005.05	Saloon Engine M271.948	•		GWB6530	
	2004.02-2005.05	Saloon Engine M271.948		o	GHA425048	
	2004.02-2005.05	Saloon Engine M271.948		o	GWB0757	
C 240 (125 kW)	2000.05-2007.02	Saloon Engine M112.912	•		GWB6530	
	2000.05-2007.02	Saloon Engine M112.912		o	GHA425048	
	2000.05-2007.02	Saloon Engine M112.912		o	GWB0757	
C 240 4-matic (125 kW)	2002.07-2007.02	Saloon Engine M112.916	•		GWB6647	
	2002.07-2007.02	Saloon Engine M112.916		o	GHA425048	
	2002.07-2007.02	Saloon Engine M112.916		o	GWB0757	
C 270 CDi (125 kW)	2000.12-2007.02	Saloon Engine OM612.962	•		GWB6530	
	2000.12-2007.02	Saloon Engine OM612.962		o	GHA425048	
	2000.12-2007.02	Saloon Engine OM612.962		o	GWB0757	
C 280 (170 kW)	2005.06-2008.03	Saloon Engine M272.940	•		GWB6530	
	2005.06-2008.03	Saloon Engine M272.940		o	GHA425048	
	2005.06-2008.03	Saloon Engine M272.940		o	GWB0757	
C 280 4-matic (170 kW)	2005.01-2007.02	Saloon Engine M272.941	•		GWB6647	
	2005.01-2007.02	Saloon Engine M272.941		o	GHA425048	
	2005.01-2007.02	Saloon Engine M272.941		o	GWB0757	
C 30 CDi AMG (170 kW)	2003.01-2007.02	Saloon Engine OM612.990	•		GWB6530	
	2003.01-2007.02	Saloon Engine OM612.990		o	GHA425048	
	2003.01-2007.02	Saloon Engine OM612.990		o	GWB0757	
C 32 AMG Kompressor (260 kW)	2001.02-2007.02	Saloon Engine M112.961	•		GWB6530	
	2001.02-2007.02	Saloon Engine M112.961		o	GHA425048	
	2001.02-2007.02	Saloon Engine M112.961		o	GWB0757	
C 320 (160 kW)	2000.05-2007.02	Saloon Engine M112.946	•		GWB6530	
	2000.05-2007.02	Saloon Engine M112.946		o	GHA425048	
	2000.05-2007.02	Saloon Engine M112.946		o	GWB0757	
C 320 4-matic (160 kW)	2002.07-2007.02	Saloon Engine M112.953	•		GWB6647	
	2002.07-2007.02	Saloon Engine M112.953		o	GHA425048	
	2002.07-2007.02	Saloon Engine M112.953		o	GWB0757	
C 320 CDi (165 kW)	2005.06-2008.04	Saloon Engine OM642.910	•		GWB6530	
	2005.06-2008.04	Saloon Engine OM642.910		o	GHA425048	
	2005.06-2008.04	Saloon Engine OM642.910		o	GWB0757	
C 350 (200 kW)	2005.06-2008.04	Saloon Engine M272.960	•		GWB6530	
	2005.06-2008.04	Saloon Engine M272.960		o	GHA425048	
	2005.06-2008.04	Saloon Engine M272.960		o	GWB0757	
C 350 4-matic (200 kW)	2005.01-2007.02	Saloon Engine M272.970/M272.960	•		GWB6647	
	2005.01-2007.02	Saloon Engine M272.970/M272.960		o	GHA425048	
	2005.01-2007.02	Saloon Engine M272.970/M272.960		o	GWB0757	
C 55 AMG (270 kW)	2004.02-2008.03	Saloon Engine M113.988	•		GWB6530	
	2004.02-2008.03	Saloon Engine M113.988		o	GHA425048	
	2004.02-2008.03	Saloon Engine M113.988		o	GWB0757	
C-CLASS (W204)						
C 180 CDi (88 kW)	2011.01-	Saloon Engine OM651.913	•		GHA499042	
	2011.01-	Saloon Engine OM651.913	•		GWB6530	
	2011.01-	Saloon Engine OM651.913		o	GHA249005	K
C 180 CGi (115 kW)	2008.01-2014.01	Saloon Engine M 274.910	•		GWB6530	
	2008.01-2014.01	Saloon Engine M 274.910		o	GHA249005	K



	 YEAR		F	R	G-AP Ref.	KIT
MERCEDES BENZ						
C-CLASS (W204)						
C 180 CGI (115 kW)	2007.01-	Saloon Engine M271.820	•		GHA499042	
	2007.01-	Saloon Engine M271.820	•		GWB6530	
	2007.01-	Saloon Engine M271.820		o	GHA249005	K
C 180 Kompressor (115 kW)	2007.04-2008.03	Saloon Engine M271.952	•		GHA499042	
	2007.04-2008.03	Saloon Engine M271.952	•		GWB6530	
	2007.04-2008.03	Saloon Engine M271.952		o	GHA249005	K
	2008.01-	Saloon Engine M271.910	•		GHA499042	
	2008.01-	Saloon Engine M271.910	•		GWB6530	
	2008.01-	Saloon Engine M271.910		o	GHA249005	K
C 200 (137 kW)	2011.05-	Saloon Engine M271.820	•		GHA499042	
	2011.05-	Saloon Engine M271.820	•		GWB6530	
	2011.05-	Saloon Engine M271.820		o	GHA249005	K
C 200 CDI (100 kW)	2007.01-	Saloon Engine OM646.811/OM646.812	•		GHA499042	
	2007.01-	Saloon Engine OM646.811/OM646.812	•		GWB6530	
	2007.01-	Saloon Engine OM646.811/OM646.812		o	GHA249005	K
	2011.01-	Saloon Engine OM651.913	•		GHA499042	
	2011.01-	Saloon Engine OM651.913	•		GWB6530	
	2011.01-	Saloon Engine OM651.913		o	GHA249005	K
C 200 CGI (135 kW)	2007.01-	Saloon Engine M271.820	•		GHA499042	
	2007.01-	Saloon Engine M271.820	•		GWB6530	
	2007.01-	Saloon Engine M271.820		o	GHA249005	K
C 200 Kompressor (135 kW)	2007.04-2008.03	Saloon Engine M271.950	•		GHA499042	
	2007.04-2008.03	Saloon Engine M271.950	•		GWB6530	
	2007.04-2008.03	Saloon Engine M271.950		o	GHA249005	K
C 220 CDI (120 kW)	2007.01-	Saloon Engine OM651.911	•		GHA499042	
	2007.01-	Saloon Engine OM651.911	•		GWB6530	
	2007.01-	Saloon Engine OM651.911		o	GHA249005	K
	2007.01-2008.11	Saloon Engine OM 646.811	•		GWB6530	
	2007.01-2008.11	Saloon Engine OM 646.811		o	GHA249005	K
	2007.01-2008.11	Saloon Engine OM646.811	•		GHA499042	
C 220 CDI (125 kW)	2007.04-2008.03	Saloon Engine OM646.811	•		GWB6530	
	2007.04-2008.03	Saloon Engine OM646.811		o	GHA249005	K
	2008.12-	Saloon Engine OM651.911	•		GHA499042	
	2008.12-	Saloon Engine OM651.911	•		GWB6530	
	2008.12-	Saloon Engine OM651.911		o	GHA249005	K
	2013.02-2014.01	Saloon Engine OM 651.912		o	GHA249005	K
C 230 (150 kW)	2007.04-2008.03	Saloon Engine M272.921	•		GHA499042	
	2007.04-2008.03	Saloon Engine M272.921	•		GWB6530	
	2007.04-2008.03	Saloon Engine M272.921		o	GHA249005	K
C 230 4-matic (150 kW)	2007.07-	Saloon Engine M272.911		o	GHA249005	K
C 250 CDI (150 kW)	2008.08-	Saloon Engine OM651.911	•		GHA499042	
	2008.08-	Saloon Engine OM651.911	•		GWB6530	
	2008.08-	Saloon Engine OM651.911		o	GHA249005	K
C 250 CDI 4-matic (150 kW)	2011.01-	Saloon Engine OM651.912		o	GHA249005	K
C 250 CGI (150 kW)	2009.07-	Saloon Engine M271.860	•		GHA499042	
	2009.07-	Saloon Engine M271.860	•		GWB6530	
	2009.07-	Saloon Engine M271.860		o	GHA249005	K
	2007.04-2008.03	Saloon Engine M272.947	•		GHA499042	
C 280 (170 kW)	2007.04-2008.03	Saloon Engine M272.947	•		GWB6530	
	2007.04-2008.03	Saloon Engine M272.947		o	GHA249005	K
	2007.04-2008.03	Saloon Engine M272.947		o	GHA249005	K
C 280 4-matic (170 kW)	2007.07-	Saloon Engine M272.948		o	GHA249005	K
C 300 (170 kW)	2009.07-	Saloon Engine M272.947	•		GHA499042	
	2009.07-	Saloon Engine M272.947	•		GWB6530	
	2009.07-	Saloon Engine M272.947		o	GHA249005	K
C 300 (185 kW)	2011.02-	Saloon Engine M276.957	•		GHA499042	
	2011.02-	Saloon Engine M276.957	•		GWB6530	
	2011.02-	Saloon Engine M276.957		o	GHA249005	K
C 300 4-matic (170 kW)	2007.07-	Saloon Engine M272.948		o	GHA249005	K
C 300 4-matic (185 kW)	2011.02-	Saloon Engine M276.957		o	GHA249005	K
C 300 CDI 4-matic (170 kW)	2011.01-	Saloon Engine OM642.832		o	GHA249005	K
C 320 CDI (165 kW)	2007.04-2008.03	Saloon Engine OM642.960	•		GHA499042	
	2007.04-2008.03	Saloon Engine OM642.960	•		GWB6530	
	2007.04-2008.03	Saloon Engine OM642.960		o	GHA249005	K
C 320 CDI 4-matic (165 kW)	2007.07-	Saloon Engine OM642.961		o	GHA249005	K



	 YEAR		F	R	G-AP Ref.	KIT
MERCEDES BENZ						
C-CLASS (W204)						
C 350 (200 kW)	2007.04-2008.03	Saloon Engine M272.961	•		GHA499042	
	2007.04-2008.03	Saloon Engine M272.961	•		GWB6530	
	2007.04-2008.03	Saloon Engine M272.961		o	GHA249005	K
C 350 (225 kW)	2011.01-	Saloon Engine M276.957	•		GHA499042	
	2011.01-	Saloon Engine M276.957	•		GWB6530	
	2011.01-	Saloon Engine M276.957		o	GHA249005	K
C 350 4-matic (200 kW)	2007.07-	Saloon Engine M272.971		o	GHA249005	K
C 350 4-matic (225 kW)	2011.01-	Saloon Engine M276.957		o	GHA249005	K
C 350 CDI (165 kW)	2009.07-	Saloon Engine OM642.960	•		GHA499042	
	2009.07-	Saloon Engine OM642.960	•		GWB6530	
	2009.07-	Saloon Engine OM642.960		o	GHA249005	K
C 350 CDI (170 kW)	2009.10-	Saloon Engine OM642.830	•		GHA499042	
	2009.10-	Saloon Engine OM642.830	•		GWB6530	
	2009.10-	Saloon Engine OM642.830		o	GHA249005	K
C 350 CDI (195 kW)	2011.06-	Saloon Engine OM642.834	•		GHA499042	
	2011.06-	Saloon Engine OM642.834	•		GWB6530	
	2011.06-	Saloon Engine OM642.834		o	GHA249005	K
C 350 CDI 4-matic (165 kW)	2009.07-	Saloon Engine OM642.961		o	GHA249005	K
C 350 CDI 4-matic (170 kW)	2009.10-	Saloon Engine OM642.832		o	GHA249005	K
C 350 CGI (215 kW)	2008.09-	Saloon Engine M272.982	•		GHA499042	
	2008.09-	Saloon Engine M272.982	•		GWB6530	
	2008.09-	Saloon Engine M272.982		o	GHA249005	K
C 63 AMG (336 kW)	2008.02-	Saloon Engine M156.985		o	GHA249005	K
C 63 AMG (358 kW)	2008.02-	Saloon Engine M156.985		o	GHA249005	K
C 63 AMG (373 kW)	2008.02-2014.01	Saloon Engine M 156.985		o	GHA249005	K
C 63 AMG (382 kW)	2010.07-2014.01	Saloon		o	GHA249005	K
C-CLASS T-MODEL (S203)						
C 180 (95 kW)	2001.03-2002.05	Estate Engine M111.951	•		GWB6530	
	2001.03-2002.05	Estate Engine M111.951		o	GHA425048	
	2001.03-2002.05	Estate Engine M111.951		o	GWB0757	
C 180 Kompressor (105 kW)	2002.05-2007.08	Estate Engine M271.946	•		GWB6530	
	2002.05-2007.08	Estate Engine M271.946		o	GHA425048	
	2002.05-2007.08	Estate Engine M271.946		o	GWB0757	
C 200 CDI (75 kW)	2001.03-2007.08	Estate Engine OM646.962	•		GWB6530	
	2001.03-2007.08	Estate Engine OM646.962		o	GHA425048	
	2001.03-2007.08	Estate Engine OM646.962		o	GWB0757	
C 200 CDI (85 kW)	2001.03-2007.08	Estate Engine OM611.962	•		GWB6530	
	2001.03-2007.08	Estate Engine OM611.962		o	GHA425048	
	2001.03-2007.08	Estate Engine OM611.962		o	GWB0757	
C 200 CDI (90 kW)	2003.06-2008.03	Estate Engine OM646.962	•		GWB6530	
	2003.06-2008.03	Estate Engine OM646.962		o	GHA425048	
	2003.06-2008.03	Estate Engine OM646.962		o	GWB0757	
C 200 CGI Kompressor (125 kW)	2003.07-2007.08	Estate Engine M271.942	•		GWB6530	
	2003.07-2007.08	Estate Engine M271.942		o	GHA425048	
	2003.07-2007.08	Estate Engine M271.942		o	GWB0757	
C 200 Kompressor (120 kW)	2001.03-2002.05	Estate Engine M111.955	•		GWB6530	
	2001.03-2002.05	Estate Engine M111.955		o	GHA425048	
	2001.03-2002.05	Estate Engine M111.955		o	GWB0757	
	2002.05-2007.08	Estate Engine M271.940	•		GWB6530	
	2002.05-2007.08	Estate Engine M271.940		o	GHA425048	
	2002.05-2007.08	Estate Engine M271.940		o	GWB0757	
C 220 CDI (100 kW)	2006.08-2007.08	Estate Engine OM646.963	•		GWB6530	
	2006.08-2007.08	Estate Engine OM646.963		o	GWB0757	
C 220 CDI (105 kW)	2001.03-2007.08	Estate Engine OM611.962	•		GWB6530	
	2001.03-2007.08	Estate Engine OM611.962		o	GHA425048	
	2001.03-2007.08	Estate Engine OM611.962		o	GWB0757	
C 220 CDI (110 kW)	2004.02-2008.03	Estate Engine OM646.963	•		GWB6530	
	2004.02-2008.03	Estate Engine OM646.963		o	GHA425048	
	2004.02-2008.03	Estate Engine OM646.963		o	GWB0757	
C 230 (150 kW)	2005.06-2008.03	Estate Engine M272.920	•		GWB6530	
	2005.06-2008.03	Estate Engine M272.920		o	GHA425048	
	2005.06-2008.03	Estate Engine M272.920		o	GWB0757	
C 230 Kompressor (141 kW)	2004.02-2007.08	Estate Engine M271.948	•		GWB6530	
	2004.02-2007.08	Estate Engine M271.948		o	GHA425048	



	 YEAR		F	R	G-AP Ref.	KIT
MERCEDES BENZ						
C-CLASS T-MODEL (S203)						
C 230 Kompressor (141 kW)	2004.02-2007.08	Estate Engine M271.948		o	GWB0757	
C 240 (125 kW)	2001.03-2007.08	Estate Engine M112.912	•		GWB6530	
	2001.03-2007.08	Estate Engine M112.912		o	GHA425048	
	2001.03-2007.08	Estate Engine M112.912		o	GWB0757	
C 240 4-matic (125 kW)	2002.07-2007.08	Estate Engine M112.916	•		GWB6647	
	2002.07-2007.08	Estate Engine M112.916		o	GHA425048	
	2002.07-2007.08	Estate Engine M112.916		o	GWB0757	
C 270 CDi (125 kW)	2001.03-2007.08	Estate Engine OM612.962	•		GWB6530	
	2001.03-2007.08	Estate Engine OM612.962		o	GHA425048	
	2001.03-2007.08	Estate Engine OM612.962		o	GWB0757	
C 280 (170 kW)	2005.06-2008.03	Estate Engine M272.940	•		GWB6530	
	2005.06-2008.03	Estate Engine M272.940		o	GHA425048	
	2005.06-2008.03	Estate Engine M272.940		o	GWB0757	
C 280 4-matic (170 kW)	2005.01-2007.08	Estate Engine M272.941	•		GWB6647	
	2005.01-2007.08	Estate Engine M272.941		o	GHA425048	
	2005.01-2007.08	Estate Engine M272.941		o	GWB0757	
C 30 CDi AMG (170 kW)	2003.01-2007.08	Estate Engine OM612.990	•		GWB6530	
	2003.01-2007.08	Estate Engine OM612.990		o	GHA425048	
	2003.01-2007.08	Estate Engine OM612.990		o	GWB0757	
C 32 AMG Kompressor (260 kW)	2001.03-2007.08	Estate Engine M112.961	•		GWB6530	
	2001.03-2007.08	Estate Engine M112.961		o	GHA425048	
	2001.03-2007.08	Estate Engine M112.961		o	GWB0757	
C 320 (160 kW)	2001.03-2007.08	Estate Engine M112.946	•		GWB6530	
	2001.03-2007.08	Estate Engine M112.946		o	GHA425048	
	2001.03-2007.08	Estate Engine M112.946		o	GWB0757	
C 320 4-matic (160 kW)	2002.07-2007.08	Estate Engine M112.953	•		GWB6647	
	2002.07-2007.08	Estate Engine M112.953		o	GHA425048	
	2002.07-2007.08	Estate Engine M112.953		o	GWB0757	
C 320 CDi (165 kW)	2005.06-2008.03	Estate Engine OM642.910	•		GWB6530	
	2005.06-2008.03	Estate Engine OM642.910		o	GHA425048	
	2005.06-2008.03	Estate Engine OM642.910		o	GWB0757	
C 350 (200 kW)	2005.06-2008.03	Estate Engine M272.960	•		GWB6530	
	2005.06-2008.03	Estate Engine M272.960		o	GHA425048	
	2005.06-2008.03	Estate Engine M272.960		o	GWB0757	
C 350 4-matic (200 kW)	2005.01-2007.08	Estate Engine M272.970	•		GWB6647	
	2005.01-2007.08	Estate Engine M272.970		o	GHA425048	
	2005.01-2007.08	Estate Engine M272.970		o	GWB0757	
C 55 AMG (270 kW)	2004.02-2008.03	Estate Engine M113.988	•		GWB6530	
	2004.02-2008.03	Estate Engine M113.988		o	GHA425048	
	2004.02-2008.03	Estate Engine M113.988		o	GWB0757	
C-CLASS T-MODEL (S204)						
C 180 CDi (88 kW)	2011.01-	Estate Engine OM651.913	•		GHA499042	
	2011.01-	Estate Engine OM651.913	•		GWB6530	
	2011.01-	Estate Engine OM651.913		o	GHA249005	K
C 180 CGi (115 kW)	2009.11-	Estate Engine M271.820	•		GHA499042	
	2009.11-	Estate Engine M271.820	•		GWB6530	
	2009.11-	Estate Engine M271.820		o	GHA249005	K
C 180 Kompressor (115 kW)	2007.12-	Estate Engine M271.952	•		GHA499042	
	2007.12-	Estate Engine M271.952	•		GWB6530	
	2007.12-	Estate Engine M271.952		o	GHA249005	K
	2008.01-	Estate Engine M271.910	•		GHA499042	
	2008.01-	Estate Engine M271.910	•		GWB6530	
	2008.01-	Estate Engine M271.910		o	GHA249005	K
C 200 CDi (100 kW)	2007.12-	Estate Engine OM646.811	•		GHA499042	
	2007.12-	Estate Engine OM646.811	•		GWB6530	
	2007.12-	Estate Engine OM646.811		o	GHA249005	K
	2010.08-	Estate Engine OM651.913	•		GHA499042	
	2010.08-	Estate Engine OM651.913	•		GWB6530	
	2010.08-	Estate Engine OM651.913		o	GHA249005	K
C 200 CGi (135 kW)	2007.08-	Estate Engine M271.820/M271.860	•		GHA499042	
	2007.08-	Estate Engine M271.820/M271.860	•		GWB6530	
	2007.08-	Estate Engine M271.820/M271.860		o	GHA249005	K
C 200 Kompressor (135 kW)	2007.12-	Estate Engine M271.950	•		GHA499042	
	2007.12-	Estate Engine M271.950	•		GWB6530	



	 YEAR		F	R	G-AP Ref.	KIT
MERCEDES BENZ						
C-CLASS T-MODEL (S204)						
C 200 Kompressor (135 kW)	2007.12-	Estate Engine M271.950		o	GHA249005	K
C 220 CDi (120 kW)	2007.08-2008.11	Estate Engine OM 646.811	•		GHA499042	
	2007.08-2008.11	Estate Engine OM 646.811	•		GWB6530	
	2007.08-2008.11	Estate Engine OM 646.811		o	GHA249005	K
	2008.12-2014.08	Estate	•		GHA499042	
C 220 CDi (125 kW)	2007.08-	Estate Engine OM646.811	•		GHA499042	
	2007.08-	Estate Engine OM646.811	•		GWB6530	
	2007.08-	Estate Engine OM646.811		o	GHA249005	K
	2008.12-	Estate Engine OM651.911	•		GHA499042	
	2008.12-	Estate Engine OM651.911	•		GWB6530	
C 230 (150 kW)	2008.12-	Estate Engine OM651.911		o	GHA249005	K
	2007.12-	Estate Engine M272.921	•		GHA499042	
	2007.12-	Estate Engine M272.921	•		GWB6530	
C 250 CDi (150 kW)	2007.12-	Estate Engine M272.921		o	GHA249005	K
	2009.01-	Estate Engine OM651.911	•		GHA499042	
	2009.01-	Estate Engine OM651.911	•		GWB6530	
C 250 CDi 4-matic (150 kW)	2009.01-	Estate Engine OM651.911		o	GHA249005	K
	2010.04-	Estate Engine OM651.912		o	GHA249005	K
C 250 CGI (150 kW)	2009.07-	Estate Engine M271.860	•		GHA499042	
	2009.07-	Estate Engine M271.860	•		GWB6530	
	2009.07-	Estate Engine M271.860		o	GHA249005	K
C 280 (170 kW)	2007.12-	Estate Engine M272.947	•		GHA499042	
	2007.12-	Estate Engine M272.947	•		GWB6530	
	2007.12-	Estate Engine M272.947		o	GHA249005	K
C 300 (170 kW)	2007.08-2014.08	Estate Engine M 272.947	•		GHA499042	
	2007.08-2014.08	Estate Engine M 272.947	•		GWB6530	
	2007.08-2014.08	Estate Engine M 272.947		o	GHA249005	K
C 320 CDi (165 kW)	2007.12-	Estate Engine OM642.960	•		GHA499042	
	2007.12-	Estate Engine OM642.960	•		GWB6530	
	2007.12-	Estate Engine OM642.960		o	GHA249005	K
C 320 CDi 4-matic (165 kW)	2007.08-	Estate Engine OM642.961		o	GHA249005	K
C 350 (200 kW)	2007.12-	Estate Engine M272.961	•		GHA499042	
	2007.12-	Estate Engine M272.961	•		GWB6530	
	2007.12-	Estate Engine M272.961		o	GHA249005	K
C 350 CDi (165 kW)	2007.08-2014.08	Estate Engine OM 642.830	•		GWB6530	
	2007.08-2014.08	Estate Engine OM 642.830		o	GHA249005	K
C 350 CDi (170 kW)	2009.10-	Estate Engine OM642.830	•		GHA499042	
	2009.10-	Estate Engine OM642.830	•		GWB6530	
	2009.10-	Estate Engine OM642.830		o	GHA249005	K
C 350 CDi (195 kW)	2011.06-	Estate Engine OM642.834	•		GHA499042	
	2011.06-	Estate Engine OM642.834	•		GWB6530	
	2011.06-	Estate Engine OM642.834		o	GHA249005	K
C 350 CDi 4-matic (170 kW)	2009.10-	Estate Engine OM642.832		o	GHA249005	K
C 350 CGI (225 kW)	2011.06-	Estate Engine M276.957	•		GHA499042	
	2011.06-	Estate Engine M276.957	•		GWB6530	
	2011.06-	Estate Engine M276.957		o	GHA249005	K
C 63 AMG (336 kW)	2008.02-	Estate Engine M156.985		o	GHA249005	K
C 63 AMG (358 kW)	2012.01-	Estate Engine M156.985		o	GHA249005	K
CITAN (415)						
108 CDi (55 kW)	2012.11-	Box Engine OM 607.951		o	GHA230144	K
109 CDi (66 kW)	2012.11-	Box Engine OM 607.951		o	GHA230144	K
111 CDi (81 kW)	2013.06-	Box Engine OM 607.951		o	GHA230144	K
112 (84 kW)	2013.06-	Box Engine M 200.711		o	GHA230144	K
CITAN COMBI (415)						
108 CDi (55 kW)	2012.11-	Estate Engine OM 607.951		o	GHA230144	K
109 CDi (66 kW)	2012.11-	Estate Engine OM 607.951		o	GHA230144	K
111 CDi (81 kW)	2013.06-	Estate Engine OM 607.951		o	GHA230144	K
112 (84 kW)	2013.06-	Estate Engine M 200.711		o	GHA230144	K
CITAN MIXTO (415)						
109 CDi (66 kW)	2012.11-	Box Body/Estate Engine OM 607.951		o	GHA230144	K
111 CDi (81 kW)	2013.06-	Box Body/Estate Engine OM 607.951		o	GHA230144	K
CLC-CLASS (CL203)						
CLC 160 (95 kW)	2009.02-2011.06	Coupe Engine M271.911	•		GWB6530	



	 YEAR		F	R	G-AP Ref.	KIT
MERCEDES BENZ						
CLC-CLASS (CL203)						
CLC 160 (95 kW)	2009.02-2011.06	Coupe Engine M271.911		o	GHA425048	
	2009.02-2011.06	Coupe Engine M271.911		o	GWB0757	
CLC 180 Kompressor (105 kW)	2008.06-2011.06	Coupe Engine M271.946	•		GWB6530	
	2008.06-2011.06	Coupe Engine M271.946		o	GHA425048	
	2008.06-2011.06	Coupe Engine M271.946		o	GWB0757	
CLC 200 CDI (90 kW)	2008.06-2011.06	Coupe Engine OM646.962	•		GWB6530	
	2008.06-2011.06	Coupe Engine OM646.962		o	GHA425048	
	2008.06-2011.06	Coupe Engine OM646.962		o	GWB0757	
CLC 200 Kompressor (135 kW)	2008.06-2011.06	Coupe Engine M271.955	•		GWB6530	
	2008.06-2011.06	Coupe Engine M271.955		o	GHA425048	
	2008.06-2011.06	Coupe Engine M271.955		o	GWB0757	
CLC 220 CDI (110 kW)	2008.06-2011.06	Coupe Engine OM646.963	•		GWB6530	
	2008.06-2011.06	Coupe Engine OM646.963		o	GHA425048	
	2008.06-2011.06	Coupe Engine OM646.963		o	GWB0757	
CLC 230 (150 kW)	2008.06-2011.06	Coupe Engine M272.920	•		GWB6530	
	2008.06-2011.06	Coupe Engine M272.920		o	GHA425048	
	2008.06-2011.06	Coupe Engine M272.920		o	GWB0757	
CLC 350 (200 kW)	2008.05-2011.06	Coupe Engine M272.960	•		GWB6530	
	2008.05-2011.06	Coupe Engine M272.960		o	GHA425048	
	2008.05-2011.06	Coupe Engine M272.960		o	GWB0757	
CLK (A208)						
200 (100 kW)	1998.03-2002.03	Convertible Engine M111.941/M111.945	•		GHA235024	K
	1998.03-2002.03	Convertible Engine M111.941/M111.945	•		GWB1498	
	1998.03-2002.03	Convertible Engine M111.941/M111.945		o	GHA425048	
	1998.03-2002.03	Convertible Engine M111.941/M111.945		o	GWB0757	
200 Kompressor (120 kW)	2000.06-2002.03	Convertible Engine M111.956	•		GHA235024	K
	2000.06-2002.03	Convertible Engine M111.956	•		GWB1498	
	2000.06-2002.03	Convertible Engine M111.956		o	GHA425048	
	2000.06-2002.03	Convertible Engine M111.956		o	GWB0757	
200 Kompressor (141 kW)	1998.03-2000.06	Convertible Engine M111.944	•		GHA235024	K
	1998.03-2000.06	Convertible Engine M111.944	•		GWB1498	
	1998.03-2000.06	Convertible Engine M111.944		o	GHA425048	
	1998.03-2000.06	Convertible Engine M111.944		o	GWB0757	
230 Kompressor (142 kW)	1998.03-2000.06	Convertible Engine M111.973/M111.975	•		GHA235024	K
	1998.03-2000.06	Convertible Engine M111.973/M111.975	•		GWB1498	
	1998.03-2000.06	Convertible Engine M111.973/M111.975		o	GHA425048	
	1998.03-2000.06	Convertible Engine M111.973/M111.975		o	GWB0757	
230 Kompressor (145 kW)	2000.06-2002.03	Convertible Engine M111.982	•		GHA235024	K
	2000.06-2002.03	Convertible Engine M111.982	•		GWB1498	
	2000.06-2002.03	Convertible Engine M111.982		o	GHA425048	
	2000.06-2002.03	Convertible Engine M111.982		o	GWB0757	
320 (160 kW)	1998.03-2002.03	Convertible Engine M112.940	•		GHA235024	K
	1998.03-2002.03	Convertible Engine M112.940	•		GWB1498	
	1998.03-2002.03	Convertible Engine M112.940		o	GHA425048	
	1998.03-2002.03	Convertible Engine M112.940		o	GWB0757	
430 (205 kW)	1998.09-2002.03	Convertible Engine M113.943	•		GHA235024	K
	1998.09-2002.03	Convertible Engine M113.943	•		GWB1498	
	1998.09-2002.03	Convertible Engine M113.943		o	GHA425048	
	1998.09-2002.03	Convertible Engine M113.943		o	GWB0757	
55 AMG (255 kW)	2000.01-2002.03	Convertible Engine M113.981/M113.984	•		GWB1498	
	2000.01-2002.03	Convertible Engine M113.981/M113.984		o	GWB0757	
CLK (A209)						
CLK 200 CGI (125 kW)	2003.07-2010.03	Convertible Engine M271.942	•		GWB6530	
	2003.07-2010.03	Convertible Engine M271.942		o	GWB0757	
CLK 200 Kompressor (120 kW)	2003.05-2005.05	Convertible Engine M271.940	•		GWB6530	
	2003.05-2005.05	Convertible Engine M271.940		o	GHA425048	
	2003.05-2005.05	Convertible Engine M271.940		o	GWB0757	
CLK 200 Kompressor (135 kW)	2006.11-2010.03	Convertible Engine M271.955	•		GWB6530	
	2006.11-2010.03	Convertible Engine M271.955		o	GHA425048	
	2006.11-2010.03	Convertible Engine M271.955		o	GWB0757	
CLK 240 (125 kW)	2003.05-2005.05	Convertible Engine M112.912	•		GWB6530	
	2003.05-2005.05	Convertible Engine M112.912		o	GHA425048	
	2003.05-2005.05	Convertible Engine M112.912		o	GWB0757	
CLK 280 (170 kW)	2005.06-2010.03	Convertible Engine M272.940	•		GWB6530	



	 YEAR		F	R	G-AP Ref.	KIT
MERCEDES BENZ						
CLK (A209)						
CLK 280 (170 kW)	2005.06-2010.03	Convertible Engine M272.940		o	GHA425048	
	2005.06-2010.03	Convertible Engine M272.940		o	GWB0757	
CLK 320 (160 kW)	2003.05-2005.05	Convertible Engine M112.955	•		GWB6530	
	2003.05-2005.05	Convertible Engine M112.955		o	GHA425048	
	2003.05-2005.05	Convertible Engine M112.955		o	GWB0757	
CLK 320 CDI (165 kW)	2005.03-2010.03	Convertible Engine OM642.910	•		GWB6530	
	2005.03-2010.03	Convertible Engine OM642.910		o	GHA425048	
	2005.03-2010.03	Convertible Engine OM642.910		o	GWB0757	
CLK 350 (200 kW)	2005.06-2010.03	Convertible Engine M272.960	•		GWB6530	
	2005.06-2010.03	Convertible Engine M272.960		o	GHA425048	
	2005.06-2010.03	Convertible Engine M272.960		o	GWB0757	
CLK 500 (225 kW)	2003.05-2005.05	Convertible Engine M113.968	•		GWB6530	
	2003.05-2005.05	Convertible Engine M113.968		o	GHA425048	
	2003.05-2005.05	Convertible Engine M113.968		o	GWB0757	
CLK 500 (285 kW)	2006.09-2010.03	Convertible Engine M273.967	•		GWB6530	
	2006.09-2010.03	Convertible Engine M273.967		o	GHA425048	
	2006.09-2010.03	Convertible Engine M273.967		o	GWB0757	
CLK 55 AMG (270 kW)	2003.05-2006.11	Convertible Engine M113.987	•		GWB6530	
	2003.05-2006.11	Convertible Engine M113.987		o	GHA425048	
	2003.05-2006.11	Convertible Engine M113.987		o	GWB0757	
CLK 63 AMG (354 kW)	2006.09-2010.03	Convertible Engine M156.982	•		GWB6530	
	2006.09-2010.03	Convertible Engine M156.982		o	GWB0757	
CLK (C208)						
200 (100 kW)	1997.06-2002.06	Coupe Engine M111.945	•		GHA235024	K
	1997.06-2002.06	Coupe Engine M111.945	•		GWB1498	
	1997.06-2002.06	Coupe Engine M111.945		o	GHA425048	
	1997.06-2002.06	Coupe Engine M111.945		o	GWB0757	
200 Kompressor (120 kW)	2000.06-2002.06	Coupe Engine M111.956	•		GHA235024	K
	2000.06-2002.06	Coupe Engine M111.956	•		GWB1498	
	2000.06-2002.06	Coupe Engine M111.956		o	GHA425048	
	2000.06-2002.06	Coupe Engine M111.956		o	GWB0757	
200 Kompressor (141 kW)	1997.06-2000.06	Coupe Engine M111.944	•		GHA235024	K
	1997.06-2000.06	Coupe Engine M111.944	•		GWB1498	
	1997.06-2000.06	Coupe Engine M111.944		o	GHA425048	
	1997.06-2000.06	Coupe Engine M111.944		o	GWB0757	
230 Kompressor (142 kW)	1997.06-2000.06	Coupe Engine M111.973/M111.975	•		GHA235024	K
	1997.06-2000.06	Coupe Engine M111.973/M111.975	•		GWB1498	
	1997.06-2000.06	Coupe Engine M111.973/M111.975		o	GHA425048	
	1997.06-2000.06	Coupe Engine M111.973/M111.975		o	GWB0757	
230 Kompressor (145 kW)	2000.06-2002.06	Coupe Engine M111.982	•		GHA235024	K
	2000.06-2002.06	Coupe Engine M111.982	•		GWB1498	
	2000.06-2002.06	Coupe Engine M111.982		o	GHA425048	
	2000.06-2002.06	Coupe Engine M111.982		o	GWB0757	
320 (160 kW)	1997.06-2002.06	Coupe Engine M112.940	•		GHA235024	K
	1997.06-2002.06	Coupe Engine M112.940	•		GWB1498	
	1997.06-2002.06	Coupe Engine M112.940		o	GHA425048	
	1997.06-2002.06	Coupe Engine M112.940		o	GWB0757	
430 (205 kW)	1998.07-2002.06	Coupe Engine M113.943	•		GHA235024	K
	1998.07-2002.06	Coupe Engine M113.943	•		GWB1498	
	1998.07-2002.06	Coupe Engine M113.943		o	GHA425048	
	1998.07-2002.06	Coupe Engine M113.943		o	GWB0757	
55 AMG (255 kW)	1999.08-2002.06	Coupe Engine M113.981/M113.984	•		GHA235024	K
	1999.08-2002.06	Coupe Engine M113.981/M113.984	•		GWB1498	
	1999.08-2002.06	Coupe Engine M113.981/M113.984		o	GWB0757	
CLK (C209)						
200 CGI (125 kW)	2003.07-2009.05	Coupe Engine M271.942	•		GWB6530	
	2003.07-2009.05	Coupe Engine M271.942		o	GHA425048	
	2003.07-2009.05	Coupe Engine M271.942		o	GWB0757	
200 Kompressor (120 kW)	2002.09-2009.05	Coupe Engine M271.940	•		GWB6530	
	2002.09-2009.05	Coupe Engine M271.940		o	GHA425048	
	2002.09-2009.05	Coupe Engine M271.940		o	GWB0757	
200 Kompressor (135 kW)	2006.11-2009.05	Coupe Engine M271.955	•		GWB6530	
	2006.11-2009.05	Coupe Engine M271.955		o	GHA425048	
	2006.11-2009.05	Coupe Engine M271.955		o	GWB0757	



	 YEAR		F	R	G-AP Ref.	KIT
MERCEDES BENZ						
CLK (C209)						
220 CDI (100 kW)	2005.01-2009.05	Coupe Engine OM646.966	•		GWB6530	
	2005.01-2009.05	Coupe Engine OM646.966		○	GWB0757	
220 CDI (110 kW)	2005.06-2009.05	Coupe Engine OM646.966	•		GWB6530	
	2005.06-2009.05	Coupe Engine OM646.966		○	GHA425048	
	2005.06-2009.05	Coupe Engine OM646.966		○	GWB0757	
240 (120 kW)	2002.06-2009.05	Coupe Engine M 112.912	•		GWB6530	
	2002.06-2009.05	Coupe Engine M 112.912		○	GHA425048	
	2002.06-2009.05	Coupe Engine M 112.912		○	GWB0757	
240 (125 kW)	2002.06-2009.05	Coupe Engine M112.912	•		GWB6530	
	2002.06-2009.05	Coupe Engine M112.912		○	GHA425048	
	2002.06-2009.05	Coupe Engine M112.912		○	GWB0757	
270 CDI (120 kW)	2003.02-2005.06	Coupe Engine OM 612.967	•		GWB6530	
	2003.02-2005.06	Coupe Engine OM 612.967		○	GHA425048	
	2003.02-2005.06	Coupe Engine OM 612.967		○	GWB0757	
270 CDI (125 kW)	2002.10-2009.05	Coupe Engine OM612.962/OM612.967	•		GWB6530	
	2002.10-2009.05	Coupe Engine OM612.962/OM612.967		○	GHA425048	
	2002.10-2009.05	Coupe Engine OM612.962/OM612.967		○	GWB0757	
280 (170 kW)	2005.06-2009.05	Coupe Engine M272.940	•		GWB6530	
	2005.06-2009.05	Coupe Engine M272.940		○	GHA425048	
	2005.06-2009.05	Coupe Engine M272.940		○	GWB0757	
320 (160 kW)	2002.06-2009.05	Coupe Engine M112.955	•		GWB6530	
	2002.06-2009.05	Coupe Engine M112.955		○	GHA425048	
	2002.06-2009.05	Coupe Engine M112.955		○	GWB0757	
320 CDI (165 kW)	2005.06-2009.05	Coupe Engine OM642.910	•		GWB6530	
	2005.06-2009.05	Coupe Engine OM642.910		○	GHA425048	
	2005.06-2009.05	Coupe Engine OM642.910		○	GWB0757	
350 (200 kW)	2005.06-2009.05	Coupe Engine M272.960	•		GWB6530	
	2005.06-2009.05	Coupe Engine M272.960		○	GHA425048	
	2005.06-2009.05	Coupe Engine M272.960		○	GWB0757	
5.4 DTM AMG (428 kW)	2004.06-2009.05	Coupe Engine M113.994	•		GWB6530	
	2004.06-2009.05	Coupe Engine M113.994		○	GWB0757	
500 (225 kW)	2002.06-2009.05	Coupe Engine M113.968	•		GWB6530	
	2002.06-2009.05	Coupe Engine M113.968		○	GHA425048	
	2002.06-2009.05	Coupe Engine M113.968		○	GWB0757	
500 (285 kW)	2006.09-2009.05	Coupe Engine M273.965	•		GWB6530	
	2006.09-2009.05	Coupe Engine M273.965		○	GHA425048	
	2006.09-2009.05	Coupe Engine M273.965		○	GWB0757	
55 AMG (270 kW)	2002.09-2009.05	Coupe Engine M113.987	•		GWB6530	
	2002.09-2009.05	Coupe Engine M113.987		○	GHA425048	
	2002.09-2009.05	Coupe Engine M113.987		○	GWB0757	
63 AMG (354 kW)	2006.09-2009.05	Coupe Engine M156.982	•		GWB6530	
	2006.09-2009.05	Coupe Engine M156.982		○	GWB0757	
63 AMG (373 kW)	2007.05-2009.05	Coupe Engine M156.982	•		GWB6530	
	2007.05-2009.05	Coupe Engine M156.982		○	GWB0757	
CLS (C218)						
CLS 250 CDI (150 kW)	2011.04-	Coupe Engine OM651.924	•		GWB6537	
	2011.04-	Coupe Engine OM651.924		○	GHA249002	K
CLS 350 (225 kW)	2011.01-	Coupe Engine M276.952	•		GWB6537	
	2011.01-	Coupe Engine M276.952		○	GHA249002	K
CLS 350 CDI (195 kW)	2011.01-	Coupe Engine OM642.853	•		GWB6537	
	2011.01-	Coupe Engine OM642.853		○	GHA249002	K
CLS 350 CDI 4-matic (195 kW)	2011.09-	Coupe Engine OM642.854		○	GHA249002	K
CLS 350 D 4-matic (190 kW)	2015.04-	Coupe Engine OM 642.54/OM 642.858		○	GHA249002	K
CLS 500 (300 kW)	2011.02-	Coupe Engine M278.922	•		GWB6537	
	2011.02-	Coupe Engine M278.922		○	GHA249002	K
CLS 500 4-matic (300 kW)	2011.09-	Coupe Engine M278.922		○	GHA249002	K
CLS 63 AMG (386 kW)	2011.02-	Coupe Engine M157.981	•		GWB6537	
	2011.02-	Coupe Engine M157.981		○	GHA249002	K
CLS 63 AMG (410 kW)	2011.01-	Coupe Engine M157.981	•		GWB6537	
	2011.01-	Coupe Engine M157.981		○	GHA249002	K
CLS (C219)						
CLS 280 (170 kW)	2008.07-2010.12	Coupe Engine M272.943	•		GWB6537	
	2008.07-2010.12	Coupe Engine M272.943		○	GHA249002	K
CLS 300 (170 kW)	2009.04-2010.12	Coupe Engine M272.943	•		GWB6537	



	 YEAR		F	R	G-AP Ref.	KIT
MERCEDES BENZ						
CLS (C219)						
CLS 300 (170 kW)	2009.04-2010.12	Coupe Engine M272.943		o	GHA249002	K
CLS 320 CDI (155 kW)	2005.01-2010.12	Coupe Engine OM 642.920	•		GWB6537	
	2005.01-2010.12	Coupe Engine OM 642.920		o	GHA249002	K
CLS 320 CDI (165 kW)	2005.10-2010.12	Coupe Engine OM642.920	•		GWB6537	
	2005.10-2010.12	Coupe Engine OM642.920		o	GHA249002	K
CLS 350 (200 kW)	2005.01-2010.12	Coupe Engine M272.964	•		GWB6537	
	2005.01-2010.12	Coupe Engine M272.964		o	GHA249002	K
CLS 350 (215 kW)	2006.04-2010.12	Coupe Engine M272.985	•		GWB6537	
	2006.04-2010.12	Coupe Engine M272.985		o	GHA249002	K
CLS 350 CDI (165 kW)	2009.04-2010.12	Coupe Engine OM642.920	•		GWB6537	
	2009.04-2010.12	Coupe Engine OM642.920		o	GHA249002	K
CLS 350 CGI (215 kW)	2009.04-2010.12	Coupe Engine M272.985	•		GWB6537	
	2009.04-2010.12	Coupe Engine M272.985		o	GHA249002	K
CLS 500 (225 kW)	2005.01-2010.12	Coupe Engine M113.967	•		GWB6537	
	2005.01-2010.12	Coupe Engine M113.967		o	GHA249002	K
CLS 500 (285 kW)	2006.04-2010.12	Coupe Engine M273.960	•		GWB6537	
	2006.04-2010.12	Coupe Engine M273.960		o	GHA249002	K
CLS 55 AMG (350 kW)	2005.01-2010.12	Coupe Engine M113.990	•		GWB6537	
	2005.01-2010.12	Coupe Engine M113.990		o	GHA249002	K
CLS 550 (285 kW)	2006.04-	Coupe Engine M 273.960	•		GWB6537	
	2006.04-	Coupe Engine M 273.960		o	GHA249002	K
CLS 63 AMG (378 kW)	2006.04-2010.12	Coupe Engine M156.983	•		GWB6537	
	2006.04-2010.12	Coupe Engine M156.983		o	GHA249002	K
CLS SHOOTING BRAKE (X218)						
CLS 220 BlueTEC (130 kW)	2014.05-	Estate Engine OM 651.924	•		GWB6537	
	2014.05-	Estate Engine OM 651.924		o	GHA249002	K
CLS 220 BlueTEC / D (120 kW)	2014.05-	Estate Engine OM 651.924	•		GWB6537	
	2014.05-	Estate Engine OM 651.924		o	GHA249002	K
CLS 220 BlueTEC / D (125 kW)	2014.05-	Estate Engine OM 651.924	•		GWB6537	
	2014.05-	Estate Engine OM 651.924		o	GHA249002	K
CLS 250 BlueTEC / D 4-matic (150 kW)	2014.05-	Estate Engine OM 651.924		o	GHA249002	K
CLS 250 CDI (150 kW)	2012.10-	Estate Engine OM651.924	•		GWB6537	
CLS 350 (225 kW)	2012.10-	Estate Engine M276.952	•		GWB6537	
CLS 350 BlueTEC / D (190 kW)	2014.05-	Estate Engine OM 642.853	•		GWB6537	
	2014.05-	Estate Engine OM 642.853		o	GHA249002	K
CLS 350 BlueTEC 4-matic (185 kW)	2014.05-	Estate Engine OM 642.858		o	GHA249002	K
CLS 350 CDI (195 kW)	2012.10-	Estate Engine OM642.853	•		GWB6537	
CLS 350 CDI 4-matic (195 kW)	2012.10-	Estate Engine OM642.854		o	GHA249002	K
CLS 350 D 4-matic (190 kW)	2015.04-	Estate Engine OM 642.854/OM 642.858		o	GHA249002	K
CLS 400 (245 kW)	2014.05-	Estate Engine M 276.820	•		GWB6537	
	2014.05-	Estate Engine M 276.820		o	GHA249002	K
	2014.07-	Estate Engine M 276.850	•		GWB6537	
	2014.07-	Estate Engine M 276.850		o	GHA249002	K
CLS 400 4-matic (245 kW)	2014.05-	Estate Engine M 276.820		o	GHA249002	K
	2014.07-	Estate Engine M 276.850		o	GHA249002	K
CLS 500 (300 kW)	2012.10-	Estate Engine M278.922	•		GWB6537	
	2012.10-	Estate Engine M278.922		o	GHA249002	K
CLS 500 4-matic (300 kW)	2012.10-	Estate Engine M278.922		o	GHA249002	K
CLS 63 AMG (410 kW)	2013.05-	Estate Engine M 157.981	•		GWB6537	
	2013.05-	Estate Engine M 157.981		o	GHA249002	K
CLS 63 AMG (386 kW)	2012.10-	Estate Engine M157.981	•		GWB6537	
	2012.10-	Estate Engine M157.981		o	GHA249002	K
CLS 63 AMG 4-matic (410 kW)	2013.05-	Estate Engine M 157.981		o	GHA249002	K
CLS 63 AMG 4-matic (430 kW)	2013.02-	Estate Engine M 157.981		o	GHA249002	K
COUPE (C124)						
220 CE (110 kW)	1992.10-1993.05	Coupe Engine M111.960	•		GWB0941	
	1992.10-1993.05	Coupe Engine M111.960		o	GWB0757	
320 CE (162 kW)	1992.10-1993.05	Coupe Engine M104.992	•		GWB0941	
	1992.10-1993.05	Coupe Engine M104.992		o	GWB0757	
E-CLASS (A124)						
E 200 (100 kW)	1993.06-1998.03	Convertible Engine M111.940	•		GWB0941	
	1993.06-1998.03	Convertible Engine M111.940		o	GWB0757	
E 220 (110 kW)	1993.06-1998.03	Convertible Engine M111.960	•		GWB0941	
	1993.06-1998.03	Convertible Engine M111.960		o	GWB0757	



	 YEAR		F	R	G-AP Ref.	KIT
MERCEDES BENZ						
E-CLASS (A124)						
E 320 (162 kW)	1993.06-1998.03	Convertible Engine M104.992/M104.995	•		GHA235024	K
	1993.06-1998.03	Convertible Engine M104.992/M104.995		○	GWB0757	
E 36 AMG (200 kW)	1994.05-1998.03	Convertible Engine M104.992(AMG3.6)		○	GWB0757	
E-CLASS (A207)						
E 200 CGI (135 kW)	2010.01-	Convertible Engine M271.860/M271.820	•		GHA499042	
	2010.01-	Convertible Engine M271.860/M271.820	•		GWB6530	
	2010.01-	Convertible Engine M271.860/M271.820		○	GHA249005	K
E 220 CDi (120 kW)	2010.02-	Convertible Engine OM 651.911	•		GWB6530	
	2010.02-	Convertible Engine OM 651.911		○	GHA249005	K
E 220 CDi (125 kW)	2010.01-	Convertible Engine OM651.911	•		GHA499042	
	2010.01-	Convertible Engine OM651.911	•		GWB6530	
	2010.01-	Convertible Engine OM651.911		○	GHA249005	K
E 250 CDi (150 kW)	2010.01-	Convertible Engine OM651.911	•		GHA499042	
	2010.01-	Convertible Engine OM651.911	•		GWB6530	
	2010.01-	Convertible Engine OM651.911		○	GHA249005	K
E 250 CGI (150 kW)	2010.01-	Convertible Engine M271.860	•		GHA499042	
	2010.01-	Convertible Engine M271.860	•		GWB6530	
	2010.01-	Convertible Engine M271.860		○	GHA249005	K
E 300 (185 kW)	2011.04-	Convertible Engine M276.957	•		GHA499042	
	2011.04-	Convertible Engine M276.957	•		GWB6530	
	2011.04-	Convertible Engine M276.957		○	GHA249005	K
E 350 (225 kW)	2011.04-	Convertible Engine M276.957	•		GHA499042	
	2011.04-	Convertible Engine M276.957	•		GWB6530	
	2011.04-	Convertible Engine M276.957		○	GHA249005	K
E 350 CDi (170 kW)	2010.01-	Convertible Engine OM642.836	•		GHA499042	
	2010.01-	Convertible Engine OM642.836	•		GWB6530	
	2010.01-	Convertible Engine OM642.836		○	GHA249005	K
E 350 CDi (195 kW)	2011.04-	Convertible Engine OM642.838	•		GHA499042	
	2011.04-	Convertible Engine OM642.838	•		GWB6530	
	2011.04-	Convertible Engine OM642.838		○	GHA249005	K
E 350 CGI (215 kW)	2010.01-	Convertible Engine M272.982/M272.984	•		GHA499042	
	2010.01-	Convertible Engine M272.982/M272.984	•		GWB6530	
	2010.01-	Convertible Engine M272.982/M272.984		○	GHA249005	K
E 500 (285 kW)	2010.01-	Convertible Engine M273.966	•		GHA499042	
	2010.01-	Convertible Engine M273.966	•		GWB6530	
	2010.01-	Convertible Engine M273.966		○	GHA249005	K
E 500 (300 kW)	2011.09-	Convertible Engine M278.922	•		GWB6530	
	2011.09-	Convertible Engine M278.922		○	GHA249005	K
E-CLASS (C124)						
E 200 (100 kW)	1993.06-1997.06	Coupe Engine M111.940	•		GWB0941	
	1993.06-1997.06	Coupe Engine M111.940		○	GWB0757	
E 220 (110 kW)	1993.06-1997.06	Coupe Engine M111.960	•		GWB0941	
	1993.06-1997.06	Coupe Engine M111.960		○	GWB0757	
E 320 (162 kW)	1993.06-1997.06	Coupe Engine M104.992	•		GHA235024	K
	1993.06-1997.06	Coupe Engine M104.992	•		GWB0941	
	1993.06-1997.06	Coupe Engine M104.992		○	GWB0757	
E 36 AMG (195 kW)	1993.06-1995.04	Coupe Engine M104.992(AMG3.6)	•		GWB0941	
	1993.06-1995.04	Coupe Engine M104.992(AMG3.6)		○	GWB0757	
E 36 AMG (200 kW)	1994.05-1997.06	Coupe Engine M104.992(AMG3.6)	•		GWB0941	
	1994.05-1997.06	Coupe Engine M104.992(AMG3.6)		○	GWB0757	
E-CLASS (C207)						
E 200 CGI (135 kW)	2010.01-	Coupe Engine M271.820/M271.860	•		GHA499042	
	2010.01-	Coupe Engine M271.820/M271.860	•		GWB6530	
	2010.01-	Coupe Engine M271.820/M271.860		○	GHA249005	K
E 220 CDi (125 kW)	2010.01-	Coupe Engine OM651.911	•		GHA499042	
	2010.01-	Coupe Engine OM651.911	•		GWB6530	
	2010.01-	Coupe Engine OM651.911		○	GHA249005	K
E 250 CDi (150 kW)	2009.01-	Coupe Engine OM651.911	•		GHA499042	
	2009.01-	Coupe Engine OM651.911	•		GWB6530	
	2009.01-	Coupe Engine OM651.911		○	GHA249005	K
E 250 CGI (150 kW)	2009.01-	Coupe Engine M271.860	•		GHA499042	
	2009.01-	Coupe Engine M271.860	•		GWB6530	
	2009.01-	Coupe Engine M271.860		○	GHA249005	K
E 300 (185 kW)	2011.04-	Coupe Engine M276.957	•		GHA499042	



	 YEAR		F	R	G-AP Ref.	KIT
MERCEDES BENZ						
E-CLASS (C207)						
E 300 (185 kW)	2011.04-	Coupe Engine M276.957	•		GWB6530	
	2011.04-	Coupe Engine M276.957		○	GHA249005	K
E 350 (200 kW)	2011.05-	Coupe Engine M272.988	•		GHA499042	
	2011.05-	Coupe Engine M272.988	•		GWB6530	
	2011.05-	Coupe Engine M272.988		○	GHA249005	K
E 350 (225 kW)	2011.04-	Coupe Engine M276.957	•		GHA499042	
	2011.04-	Coupe Engine M276.957	•		GWB6530	
	2011.04-	Coupe Engine M276.957		○	GHA249005	K
E 350 CDI (170 kW)	2009.01-	Coupe Engine OM642.836	•		GHA499042	
	2009.01-	Coupe Engine OM642.836	•		GWB6530	
	2009.01-	Coupe Engine OM642.836		○	GHA249005	K
E 350 CDI (195 kW)	2011.04-	Coupe Engine OM642.838	•		GHA499042	
	2011.04-	Coupe Engine OM642.838	•		GWB6530	
	2011.04-	Coupe Engine OM642.838		○	GHA249005	K
E 350 CGI (215 kW)	2009.01-	Coupe Engine M272.984/M272.982	•		GHA499042	
	2009.01-	Coupe Engine M272.984/M272.982	•		GWB6530	
	2009.01-	Coupe Engine M272.984/M272.982		○	GHA249005	K
E 500 (285 kW)	2009.01-	Coupe Engine M273.966	•		GHA499042	
	2009.01-	Coupe Engine M273.966	•		GWB6530	
	2009.01-	Coupe Engine M273.966		○	GHA249005	K
E 500 (300 kW)	2011.09-	Coupe Engine M278.922	•		GWB6530	
	2011.09-	Coupe Engine M278.922		○	GHA249005	K
E-CLASS (S124)						
E 200 T (100 kW)	1993.06-1996.06	Estate Engine M111.940	•		GWB0941	
	1993.06-1996.06	Estate Engine M111.940		○	GWB1347	
E 220 T (110 kW)	1993.06-1996.06	Estate Engine M111.960	•		GWB0941	
	1993.06-1996.06	Estate Engine M111.960		○	GWB1347	
E 250 T D (83 kW)	1993.06-1996.06	Estate Engine OM605.911	•		GHA235024	K
	1993.06-1996.06	Estate Engine OM605.911	•		GWB0941	
	1993.06-1996.06	Estate Engine OM605.911		○	GWB1347	
E 250 Turbo D (93 kW)	1993.06-1996.06	Estate Engine OM602.962	•		GHA235024	K
	1993.06-1996.06	Estate Engine OM602.962	•		GWB0941	
	1993.06-1996.06	Estate Engine OM602.962		○	GWB1347	
E 280 T (142 kW)	1993.06-1996.06	Estate Engine M104.942	•		GWB0941	
	1993.06-1996.06	Estate Engine M104.942		○	GWB1347	
E 280 T (145 kW)	1993.06-1996.06	Estate Engine M104.942	•		GWB0941	
	1993.06-1996.06	Estate Engine M104.942		○	GWB1347	
E 300 T 4-matic (132 kW)	1993.06-1996.06	Estate Engine M103.985	•		GHA235024	K
	1993.06-1996.06	Estate Engine M103.985		○	GWB1347	
E 300 T D (100 kW)	1993.06-1996.06	Estate Engine OM606.910	•		GHA235024	K
	1993.06-1996.06	Estate Engine OM606.910	•		GWB0941	
	1993.06-1996.06	Estate Engine OM606.910		○	GWB1347	
E 300 T Turbo-D (108 kW)	1993.06-1996.06	Estate Engine OM603.960	•		GHA235024	K
	1993.06-1996.06	Estate Engine OM603.960	•		GWB0941	
	1993.06-1996.06	Estate Engine OM603.960		○	GWB1347	
E 300 T Turbo-D 4-matic (108 kW)	1993.06-1996.06	Estate Engine OM603.963	•		GHA235024	K
	1993.06-1996.06	Estate Engine OM603.963		○	GWB1347	
E 300 TE-24 AMG (162 kW)	1993.06-1996.06	Estate Engine M104.980	•		GWB0941	
	1993.06-1996.06	Estate Engine M104.980		○	GWB1347	
E 320 T (162 kW)	1993.06-1996.06	Estate Engine M104.992	•		GHA235024	K
	1993.06-1996.06	Estate Engine M104.992	•		GWB0941	
	1993.06-1996.06	Estate Engine M104.992		○	GWB1347	
E 36 T AMG (200 kW)	1994.05-1996.06	Estate Engine M104.992(AMG3.6)	•		GWB0941	
	1994.05-1996.06	Estate Engine M104.992(AMG3.6)		○	GWB1347	
E-CLASS (S210)						
E 200 T (100 kW)	1996.06-2000.08	Estate Engine M111.942	•		GHA235024	K
	1996.06-2000.08	Estate Engine M111.942	•		GWB1498	
	1996.06-2000.08	Estate Engine M111.942		○	GWB3628	
E 200 T Kompressor (120 kW)	2000.08-2003.03	Estate Engine M111.957	•		GHA235024	K
	2000.08-2003.03	Estate Engine M111.957	•		GWB1498	
	2000.08-2003.03	Estate Engine M111.957		○	GWB3628	
E 200 T Kompressor (137 kW)	1997.06-2003.03	Estate Engine M111.947	•		GHA235024	K
	1997.06-2003.03	Estate Engine M111.947	•		GWB1498	
	1997.06-2003.03	Estate Engine M111.947		○	GWB3628	



	 YEAR		F	R	G-AP Ref.	KIT
MERCEDES BENZ						
E-CLASS (S210)						
E 220 T CDi (100 kW)	1999.05-2003.03	Estate Engine OM611.961	•		GWB1498	
	1999.05-2003.03	Estate Engine OM611.961		○	GWB3628	
E 220 T CDi (105 kW)	1999.07-2003.03	Estate Engine OM611.961	•		GHA235024	K
	1999.07-2003.03	Estate Engine OM611.961	•		GWB1498	
	1999.07-2003.03	Estate Engine OM611.961		○	GWB3628	
E 220 T CDi (92 kW)	1998.06-1999.07	Estate Engine OM611.961	•		GHA235024	K
	1998.06-1999.07	Estate Engine OM611.961	•		GWB1498	
	1998.06-1999.07	Estate Engine OM611.961		○	GWB3628	
E 230 T (110 kW)	1996.06-1997.06	Estate Engine M111.970	•		GHA235024	K
	1996.06-1997.06	Estate Engine M111.970	•		GWB1498	
	1996.06-1997.06	Estate Engine M111.970		○	GWB3628	
E 240 T (125 kW)	1997.06-2003.03	Estate Engine M112.911	•		GHA235024	K
	1997.06-2003.03	Estate Engine M112.911	•		GWB1498	
	1997.06-2003.03	Estate Engine M112.911		○	GWB3628	
	2000.08-2003.03	Estate Engine M112.914	•		GHA235024	K
	2000.08-2003.03	Estate Engine M112.914	•		GWB1498	
E 250 T D (83 kW)	2000.08-2003.03	Estate Engine M112.914		○	GWB3628	
	1996.06-1999.07	Estate Engine OM605.912	•		GHA235024	K
	1996.06-1999.07	Estate Engine OM605.912	•		GWB1498	
E 250 T Turbo-D (110 kW)	1996.06-1999.07	Estate Engine OM605.912		○	GWB3628	
	1997.06-1999.07	Estate Engine OM605.962	•		GHA235024	K
	1997.06-1999.07	Estate Engine OM605.962	•		GWB1498	
E 270 T CDi (120 kW)	1997.06-1999.07	Estate Engine OM605.962		○	GWB3628	
	2000.02-2003.03	Estate Engine OM612.961	•		GWB1498	
	2000.02-2003.03	Estate Engine OM612.961		○	GWB3628	
E 270 T CDi (125 kW)	1999.07-2003.03	Estate Engine OM612.961	•		GHA235024	K
	1999.07-2003.03	Estate Engine OM612.961	•		GWB1498	
	1999.07-2003.03	Estate Engine OM612.961		○	GWB3628	
E 280 T (150 kW)	1996.12-2003.03	Estate Engine M112.921	•		GHA235024	K
	1996.12-2003.03	Estate Engine M112.921	•		GWB1498	
	1996.12-2003.03	Estate Engine M112.921		○	GWB3628	
E 280 T 4-matic (150 kW)	1996.12-2003.03	Estate Engine M112.921	•		GWB3518	
	1996.12-2003.03	Estate Engine M112.921	•		GWB6647	
	1996.12-2003.03	Estate Engine M112.921		○	GWB3628	
E 290 T Turbo-D (95 kW)	1996.06-1999.07	Estate Engine OM602.982	•		GHA235024	K
	1996.06-1999.07	Estate Engine OM602.982	•		GWB1498	
	1996.06-1999.07	Estate Engine OM602.982		○	GWB3628	
E 300 T Turbo-D (130 kW)	1996.12-1999.07	Estate Engine OM606.962	•		GHA235024	K
	1996.12-1999.07	Estate Engine OM606.962	•		GWB1498	
	1996.12-1999.07	Estate Engine OM606.962		○	GWB3628	
E 320 T (165 kW)	1996.12-2003.03	Estate Engine M112.941	•		GHA235024	K
	1996.12-2003.03	Estate Engine M112.941	•		GWB1498	
	1996.12-2003.03	Estate Engine M112.941		○	GWB3628	
E 320 T 4-matic (165 kW)	1996.12-2003.03	Estate Engine M112.941	•		GWB3518	
	1996.12-2003.03	Estate Engine M112.941	•		GWB6647	
	1996.12-2003.03	Estate Engine M112.941		○	GWB3628	
E 320 T CDi (145 kW)	1999.07-2003.03	Estate Engine OM613.961	•		GHA235024	K
	1999.07-2003.03	Estate Engine OM613.961	•		GWB1498	
	1999.07-2003.03	Estate Engine OM613.961		○	GWB3628	
E 420 T (205 kW)	1996.06-1997.06	Estate Engine M119.985	•		GHA235024	K
	1996.06-1997.06	Estate Engine M119.985	•		GWB1498	
	1996.06-1997.06	Estate Engine M119.985		○	GWB3628	
E 430 T (205 kW)	1997.06-2003.03	Estate Engine M113.940	•		GHA235024	K
	1997.06-2003.03	Estate Engine M113.940	•		GWB1498	
	1997.06-2003.03	Estate Engine M113.940		○	GWB3628	
E 430 T 4-matic (205 kW)	1999.05-2003.03	Estate Engine M113.940	•		GWB6647	
	1999.05-2003.03	Estate Engine M113.940		○	GWB3628	
E 55 T AMG (260 kW)	1997.08-2003.03	Estate Engine M113.980	•		GHA235024	K
	1997.08-2003.03	Estate Engine M113.980	•		GWB1498	
	1997.08-2003.03	Estate Engine M113.980		○	GWB3628	
E 55 T AMG 4-matic (260 kW)	2001.03-2003.03	Estate Engine M113.980	•		GWB6647	
	2001.03-2003.03	Estate Engine M113.980		○	GWB3628	
E-CLASS (W124)						
E 200 (100 kW)	1993.06-1995.06	Saloon Engine M111.940	•		GWB0941	



	 YEAR		F	R	G-AP Ref.	KIT
MERCEDES BENZ						
E-CLASS (W124)						
E 200 (100 kW)	1993.06-1995.06	Saloon Engine M111.940		o	GWB0757	
E 200 D (55 kW)	1993.06-1995.06	Saloon Engine OM601.912	•		GWB0941	
	1993.06-1995.06	Saloon Engine OM601.912		o	GWB0757	
E 220 (110 kW)	1993.06-1995.06	Saloon Engine M111.960	•		GWB0941	
	1993.06-1995.06	Saloon Engine M111.960		o	GWB0757	
E 250 D (83 kW)	1993.07-1995.06	Saloon Engine OM605.911	•		GHA235024	K
	1993.07-1995.06	Saloon Engine OM605.911	•		GWB0941	
	1993.07-1995.06	Saloon Engine OM605.911	•		GWB1498	
	1993.07-1995.06	Saloon Engine OM605.911		o	GWB0757	
E 250 Turbo-D (93 kW)	1993.06-1995.06	Saloon Engine OM602.962	•		GHA235024	K
	1993.06-1995.06	Saloon Engine OM602.962	•		GWB0941	
	1993.06-1995.06	Saloon Engine OM602.962		o	GWB0757	
E 280 (142 kW)	1993.06-1995.06	Saloon Engine M104.942	•		GWB1498	
	1993.06-1995.06	Saloon Engine M104.942		o	GWB1347	
E 280 (145 kW)	1993.06-1995.06	Saloon Engine M104.942	•		GWB0941	
	1993.06-1995.06	Saloon Engine M104.942		o	GWB0757	
E 300 4-matic (132 kW)	1993.06-1995.06	Saloon Engine M103.985	•		GHA235024	K
	1993.06-1995.06	Saloon Engine M103.985		o	GWB0757	
E 300 D (100 kW)	1993.07-1995.06	Saloon Engine OM606.910	•		GWB0941	
	1993.07-1995.06	Saloon Engine OM606.910		o	GWB0757	
E 300 Turbo-D (108 kW)	1993.06-1995.06	Saloon Engine OM603.960	•		GHA235024	K
	1993.06-1995.06	Saloon Engine OM603.960	•		GWB0941	
	1993.06-1995.06	Saloon Engine OM603.960		o	GWB0757	
E 300 Turbo-D 4-matic (108 kW)	1993.06-1995.06	Saloon Engine OM603.963	•		GHA235024	K
	1993.06-1995.06	Saloon Engine OM603.963		o	GWB0757	
E 320 (162 kW)	1993.06-1995.06	Saloon Engine M104.992	•		GWB0941	
	1993.06-1995.06	Saloon Engine M104.992		o	GWB0757	
E 36 AMG (200 kW)	1994.07-1995.01	Saloon Engine M104.992(AMG3.6)		o	GWB0757	
E 420 (205 kW)	1993.06-1995.06	Saloon Engine M119.975	•		GWB1498	
	1993.06-1995.06	Saloon Engine M119.975		o	GWB1347	
E 500 (235 kW)	1993.06-1995.06	Saloon Engine M119.974	•		GHA235024	K
	1993.06-1995.06	Saloon Engine M119.974	•		GWB1498	
	1993.06-1995.06	Saloon Engine M119.974		o	GWB0757	
E 60 AMG (280 kW)	1994.05-1995.06	Saloon Engine M119.974AMG	•		GWB1498	
	1994.05-1995.06	Saloon Engine M119.974AMG		o	GWB0757	
E-CLASS (W210)						
E 200 (100 kW)	1995.06-2000.08	Saloon Engine M111.942	•		GHA235024	K
	1995.06-2000.08	Saloon Engine M111.942	•		GWB1498	
	1995.06-2000.08	Saloon Engine M111.942		o	GWB0757	
E 200 CDi (75 kW)	1998.06-2002.03	Saloon Engine OM611.961	•		GWB1498	
	1998.06-2002.03	Saloon Engine OM611.961		o	GWB0757	
E 200 CDi (85 kW)	1999.07-2002.03	Saloon Engine OM611.961	•		GHA235024	K
	1999.07-2002.03	Saloon Engine OM611.961	•		GWB1498	
	1999.07-2002.03	Saloon Engine OM611.961		o	GWB0757	
E 200 D (65 kW)	1996.01-2002.03	Saloon Engine OM604.917	•		GHA235024	K
	1996.01-2002.03	Saloon Engine OM604.917	•		GWB1498	
	1996.01-2002.03	Saloon Engine OM604.917		o	GWB0757	
E 200 Kompressor (120 kW)	2000.08-2002.03	Saloon Engine M111.957	•		GWB1498	
	2000.08-2002.03	Saloon Engine M111.957		o	GWB0757	
E 200 Kompressor (137 kW)	1997.06-2002.03	Saloon Engine M111.947	•		GHA235024	K
	1997.06-2002.03	Saloon Engine M111.947	•		GWB1498	
	1997.06-2002.03	Saloon Engine M111.947		o	GWB0757	
E 220 CDi (100 kW)	1999.07-2002.03	Saloon Engine OM611.961	•		GWB1498	
	1999.07-2002.03	Saloon Engine OM611.961		o	GWB0757	
E 220 CDi (105 kW)	1999.07-2002.03	Saloon Engine OM611.961	•		GHA235024	K
	1999.07-2002.03	Saloon Engine OM611.961	•		GWB1498	
	1999.07-2002.03	Saloon Engine OM611.961		o	GWB0757	
E 220 CDi (92 kW)	1998.06-1999.07	Saloon Engine OM611.961	•		GHA235024	K
	1998.06-1999.07	Saloon Engine OM611.961	•		GWB1498	
	1998.06-1999.07	Saloon Engine OM611.961		o	GWB0757	
E 220 D (55 kW)	1996.05-2002.03	Saloon Engine OM604.912	•		GWB1498	
	1996.05-2002.03	Saloon Engine OM604.912		o	GWB0757	
E 220 D (70 kW)	1995.06-1999.07	Saloon Engine OM604.912	•		GHA235024	K



	 YEAR		F	R	G-AP Ref.	KIT
MERCEDES BENZ						
E-CLASS (W210)						
E 220 D (70 kW)	1995.06-1999.07	Saloon Engine OM604.912	•		GWB1498	
	1995.06-1999.07	Saloon Engine OM604.912		◦	GWB0757	
E 230 (110 kW)	1995.06-1997.06	Saloon Engine M111.970	•		GHA235024	K
	1995.06-1997.06	Saloon Engine M111.970	•		GWB1498	
	1995.06-1997.06	Saloon Engine M111.970		◦	GWB0757	
E 240 (125 kW)	1997.06-2000.08	Saloon Engine M112.911	•		GHA235024	K
	1997.06-2000.08	Saloon Engine M112.911	•		GWB1498	
	1997.06-2000.08	Saloon Engine M112.911		◦	GWB0757	
	2000.08-2002.03	Saloon Engine M112.914	•		GHA235024	K
	2000.08-2002.03	Saloon Engine M112.914	•		GWB1498	
E 250 D (83 kW)	1995.06-1999.07	Saloon Engine OM605.912	•		GHA235024	K
	1995.06-1999.07	Saloon Engine OM605.912	•		GWB1498	
	1995.06-1999.07	Saloon Engine OM605.912		◦	GWB0757	
E 250 Turbo-D (110 kW)	1997.06-1999.07	Saloon Engine OM605.962	•		GHA235024	K
	1997.06-1999.07	Saloon Engine OM605.962	•		GWB1498	
	1997.06-1999.07	Saloon Engine OM605.962		◦	GWB0757	
E 270 CDi (120 kW)	1999.07-2002.03	Saloon Engine OM612.961	•		GWB1498	
	1999.07-2002.03	Saloon Engine OM612.961		◦	GWB0757	
E 270 CDi (125 kW)	1999.07-2002.03	Saloon Engine OM612.961	•		GHA235024	K
	1999.07-2002.03	Saloon Engine OM612.961	•		GWB1498	
	1999.07-2002.03	Saloon Engine OM612.961		◦	GWB0757	
E 280 (142 kW)	1996.01-1997.06	Saloon Engine M104.945	•		GHA235024	K
	1996.01-1997.06	Saloon Engine M104.945	•		GWB1498	
	1996.01-1997.06	Saloon Engine M104.945		◦	GWB0757	
E 280 (150 kW)	1996.12-2002.03	Saloon Engine M112.921	•		GHA235024	K
	1996.12-2002.03	Saloon Engine M112.921	•		GWB1498	
	1996.12-2002.03	Saloon Engine M112.921		◦	GWB0757	
E 280 4-matic (150 kW)	1996.12-2002.03	Saloon Engine M112.921	•		GWB3518	
	1996.12-2002.03	Saloon Engine M112.921	•		GWB6647	
	1996.12-2002.03	Saloon Engine M112.921		◦	GWB0757	
E 290 Turbo-D (95 kW)	1996.03-1999.07	Saloon Engine OM602.982	•		GHA235024	K
	1996.03-1999.07	Saloon Engine OM602.982	•		GWB1498	
	1996.03-1999.07	Saloon Engine OM602.982		◦	GWB0757	
E 300 D (100 kW)	1995.06-1997.06	Saloon Engine OM606.912	•		GHA235024	K
	1995.06-1997.06	Saloon Engine OM606.912	•		GWB1498	
	1995.06-1997.06	Saloon Engine OM606.912		◦	GWB0757	
E 300 Turbo-D (130 kW)	1996.12-1999.07	Saloon Engine OM606.962	•		GHA235024	K
	1996.12-1999.07	Saloon Engine OM606.962	•		GWB1498	
	1996.12-1999.07	Saloon Engine OM606.962		◦	GWB0757	
E 320 (162 kW)	1995.06-1997.06	Saloon Engine M104.995	•		GHA235024	K
	1995.06-1997.06	Saloon Engine M104.995	•		GWB1498	
	1995.06-1997.06	Saloon Engine M104.995		◦	GWB0757	
E 320 (165 kW)	1997.06-2002.03	Saloon Engine M112.941	•		GHA235024	K
	1997.06-2002.03	Saloon Engine M112.941	•		GWB1498	
	1997.06-2002.03	Saloon Engine M112.941		◦	GWB0757	
E 320 4-matic (165 kW)	1997.06-2002.03	Saloon Engine M112.941	•		GWB3518	
	1997.06-2002.03	Saloon Engine M112.941	•		GWB6647	
	1997.06-2002.03	Saloon Engine M112.941		◦	GWB0757	
E 320 CDi (145 kW)	1999.07-2002.03	Saloon Engine OM613.961	•		GHA235024	K
	1999.07-2002.03	Saloon Engine OM613.961	•		GWB1498	
	1999.07-2002.03	Saloon Engine OM613.961		◦	GWB0757	
E 420 (205 kW)	1996.01-1997.06	Saloon Engine M119.985	•		GHA235024	K
	1996.01-1997.06	Saloon Engine M119.985	•		GWB1498	
	1996.01-1997.06	Saloon Engine M119.985		◦	GWB0757	
E 430 (205 kW)	1997.06-2002.03	Saloon Engine M113.940	•		GHA235024	K
	1997.06-2002.03	Saloon Engine M113.940	•		GWB1498	
	1997.06-2002.03	Saloon Engine M113.940		◦	GWB0757	
	1997.06-2002.03	Saloon Engine M113.940		◦	GWB3628	
E 430 4-matic (205 kW)	1999.05-2002.03	Saloon Engine M113.940	•		GWB6647	
	1999.05-2002.03	Saloon Engine M113.940		◦	GWB0757	
	1999.05-2002.03	Saloon Engine M113.940		◦	GWB3628	
E 50 AMG (255 kW)	1996.02-1997.08	Saloon Engine M119.985(AMG5.0)	•		GHA235024	K
	1996.02-1997.08	Saloon Engine M119.985(AMG5.0)	•		GWB1498	



	 YEAR		F	R	G-AP Ref.	KIT
MERCEDES BENZ						
E-CLASS (W210)						
E 50 AMG (255 kW)	1996.02-1997.08	Saloon Engine M119.985(AMG5.0)		o	GWB0757	
E 55 AMG (260 kW)	1997.08-2002.03	Saloon Engine M113.980	•		GHA235024	K
	1997.08-2002.03	Saloon Engine M113.980	•		GWB1498	
	1997.08-2002.03	Saloon Engine M113.980		o	GWB0757	
	1997.08-2002.03	Saloon Engine M113.980		o	GWB3628	
E 55 AMG 4-matic (260 kW)	2001.03-2002.03	Saloon Engine M113.980	•		GWB6647	
	2001.03-2002.03	Saloon Engine M113.980		o	GWB0757	
	2001.03-2002.03	Saloon Engine M113.980		o	GWB3628	
E-CLASS (W211)						
E 200 CDI (100 kW)	2006.04-2008.12	Saloon Engine OM646.820	•		GWB6537	
	2006.04-2008.12	Saloon Engine OM646.820		o	GHA249002	K
E 200 CDI (75 kW)	2002.07-2008.12	Saloon Engine OM646.951	•		GWB6537	
	2002.07-2008.12	Saloon Engine OM646.951		o	GHA249002	K
E 200 CDI (90 kW)	2002.07-2008.12	Saloon Engine OM646.951	•		GWB6537	
	2002.07-2008.12	Saloon Engine OM646.951		o	GHA249002	K
E 200 Kompressor (120 kW)	2002.11-2008.12	Saloon Engine M271.941	•		GWB6537	
	2002.11-2008.12	Saloon Engine M271.941		o	GHA249002	K
E 200 Kompressor (135 kW)	2006.07-2008.12	Saloon Engine M271.956	•		GWB6537	
	2006.07-2008.12	Saloon Engine M271.956		o	GHA249002	K
E 200 NGT (120 kW)	2004.03-2008.12	Saloon Engine M271.941	•		GWB6537	
	2004.03-2008.12	Saloon Engine M271.941		o	GHA249002	K
E 220 CDI (100 kW)	2002.03-2008.12	Saloon Engine OM646.961	•		GWB6537	
	2002.03-2008.12	Saloon Engine OM646.961		o	GHA249002	K
E 220 CDI (110 kW)	2002.03-2008.12	Saloon Engine OM646.961	•		GWB6537	
	2002.03-2008.12	Saloon Engine OM646.961		o	GHA249002	K
E 220 CDI (120 kW)	2003.03-2008.12	Saloon Engine OM646.821	•		GWB6537	
	2003.03-2008.12	Saloon Engine OM646.821		o	GHA249002	K
E 220 CDI (125 kW)	2006.07-2008.03	Saloon Engine OM646.821	•		GWB6537	
	2006.07-2008.03	Saloon Engine OM646.821		o	GHA249002	K
E 230 (150 kW)	2007.09-2008.12	Saloon Engine M272.922	•		GWB6537	
	2007.09-2008.12	Saloon Engine M272.922		o	GHA249002	K
E 240 (130 kW)	2002.03-2008.12	Saloon Engine M112.913/M112.917	•		GWB6537	
	2002.03-2008.12	Saloon Engine M112.913/M112.917		o	GHA249002	K
E 240 4-matic (130 kW)	2003.03-2008.12	Saloon Engine M112.917	•		GWB6646	
	2003.03-2008.12	Saloon Engine M112.917		o	GHA249002	K
E 270 CDI (120 kW)	2002.03-2008.12	Saloon Engine OM 647.961	•		GWB6537	
	2002.03-2008.12	Saloon Engine OM 647.961		o	GHA249002	K
E 270 CDI (130 kW)	2002.03-2008.12	Saloon Engine OM647.961	•		GWB6537	
	2002.03-2008.12	Saloon Engine OM647.961		o	GHA249002	K
E 280 (170 kW)	2005.06-2006.06	Saloon Engine M272.943	•		GWB6537	
	2005.06-2006.06	Saloon Engine M272.943		o	GHA249002	K
E 280 4-matic (170 kW)	2006.01-2008.12	Saloon Engine M272.943	•		GWB6646	
	2006.01-2008.12	Saloon Engine M272.943		o	GHA249002	K
E 280 CDI (130 kW)	2004.05-2008.12	Saloon Engine OM648.961	•		GWB6537	
	2004.05-2008.12	Saloon Engine OM648.961		o	GHA249002	K
E 280 CDI (140 kW)	2005.06-2006.06	Saloon Engine OM642.920	•		GWB6537	
	2005.06-2006.06	Saloon Engine OM642.920		o	GHA249002	K
E 280 CDI 4-matic (140 kW)	2005.03-2008.12	Saloon Engine OM642.921	•		GWB6646	
	2005.03-2008.12	Saloon Engine OM642.921		o	GHA249002	K
E 300 BlueTEC (155 kW)	2007.09-2008.12	Saloon Engine OM642.920	•		GWB6537	
	2007.09-2008.12	Saloon Engine OM642.920		o	GHA249002	K
E 320 (165 kW)	2002.03-2008.12	Saloon Engine M112.949	•		GWB6537	
	2002.03-2008.12	Saloon Engine M112.949		o	GHA249002	K
E 320 4-matic (165 kW)	2003.03-2008.12	Saloon Engine M112.954	•		GWB6646	
	2003.03-2008.12	Saloon Engine M112.954		o	GHA249002	K
E 320 CDI (150 kW)	2002.11-2008.12	Saloon Engine OM648.961	•		GWB6537	
	2002.11-2008.12	Saloon Engine OM648.961		o	GHA249002	K
E 320 CDI (165 kW)	2006.07-2008.12	Saloon Engine OM642.920	•		GWB6537	
	2006.07-2008.12	Saloon Engine OM642.920		o	GHA249002	K
E 320 CDI 4-matic (165 kW)	2005.03-2008.12	Saloon Engine OM642.910	•		GWB6646	
	2005.03-2008.12	Saloon Engine OM642.910		o	GHA249002	K
E 350 (200 kW)	2004.11-2006.06	Saloon Engine M272.964	•		GWB6537	
	2004.11-2006.06	Saloon Engine M272.964		o	GHA249002	K
E 350 4-matic (200 kW)	2005.03-2008.12	Saloon Engine M272.964/M272.972	•		GWB6646	



	 YEAR		F	R	G-AP Ref.	KIT
MERCEDES BENZ						
E-CLASS (W211)						
E 350 4-matic (200 kW)	2005.03-2008.12	Saloon Engine M272.964/M272.972		o	GHA249002	K
E 350 CGI (215 kW)	2008.04-2008.12	Saloon Engine M272.985	•		GWB6537	
	2008.04-2008.12	Saloon Engine M272.985		o	GHA249002	K
E 400 CDI (191 kW)	2003.02-2008.12	Saloon Engine OM628.961	•		GWB6537	
	2003.02-2008.12	Saloon Engine OM628.961		o	GHA249002	K
E 420 CDI (231 kW)	2006.01-2008.12	Saloon Engine OM629.910	•		GWB6537	
	2006.01-2008.12	Saloon Engine OM629.910		o	GHA249002	K
E 500 (225 kW)	2002.03-2008.12	Saloon Engine M113.967	•		GWB6537	
	2002.03-2008.12	Saloon Engine M113.967		o	GHA249002	K
E 500 (285 kW)	2006.07-2008.12	Saloon Engine M273.960	•		GWB6537	
	2006.07-2008.12	Saloon Engine M273.960		o	GHA249002	K
E 500 4-matic (225 kW)	2003.10-2008.12	Saloon Engine M113.969	•		GWB6646	
	2003.10-2008.12	Saloon Engine M113.969		o	GHA249002	K
E 500 4-matic (285 kW)	2006.04-2008.12	Saloon Engine M273.962	•		GWB6646	
	2006.04-2008.12	Saloon Engine M273.962		o	GHA249002	K
E 55 AMG Kompressor (350 kW)	2002.10-2008.12	Saloon Engine M113.990	•		GWB6537	
	2002.10-2008.12	Saloon Engine M113.990		o	GHA249002	K
E 63 AMG (378 kW)	2006.07-2008.12	Saloon Engine M156.983	•		GWB6537	
	2006.07-2008.12	Saloon Engine M156.983		o	GHA249002	K
E-CLASS (W212)						
E 200 (135 kW)	2013.01-	Saloon Engine M 274.920	•		GWB6537	
	2013.01-	Saloon Engine M 274.920		o	GHA249002	K
E 200 CDI (100 kW)	2009.01-	Saloon Engine OM651.925	•		GWB6537	
	2009.01-	Saloon Engine OM651.925		o	GHA249002	K
E 200 CGI (135 kW)	2009.08-	Saloon Engine M271.820/M271.860	•		GWB6537	
	2009.08-	Saloon Engine M271.820/M271.860		o	GHA249002	K
E 200 NGT (115 kW)	2013.07-	Saloon Engine M 274.920	•		GWB6537	
	2013.07-	Saloon Engine M 274.920		o	GHA249002	K
E 200 NGT (120 kW)	2011.03-	Saloon Engine M271.958	•		GWB6537	
	2011.03-	Saloon Engine M271.958		o	GHA249002	K
E 220 BlueTEC (130 kW)	2014.05-	Saloon Engine OM 651.924	•		GWB6537	
	2014.05-	Saloon Engine OM 651.924		o	GHA249002	K
E 220 BlueTEC 4-matic (125 kW)	2015.01-	Saloon Engine OM 651.924		o	GHA249002	K
E 220 CDI (120 kW)	2009.01-	Saloon Engine OM651.924	•		GWB6537	
	2009.01-	Saloon Engine OM651.924		o	GHA249002	K
E 220 CDI/BlueTEC (125 kW)	2009.01-	Saloon Engine OM651.924	•		GWB6537	
	2009.01-	Saloon Engine OM651.924		o	GHA249002	K
E 250 (155 kW)	2013.01-	Saloon Engine M 274.920	•		GWB6537	
	2013.01-	Saloon Engine M 274.920		o	GHA249002	K
E 250 CDI (150 kW)	2009.01-	Saloon Engine OM651.924	•		GWB6537	
	2009.01-	Saloon Engine OM651.924		o	GHA249002	K
E 250 CDI 4-matic (150 kW)	2009.01-	Saloon Engine OM651.924		o	GHA249002	K
E 250 CGI (150 kW)	2009.01-	Saloon Engine M271.860	•		GWB6537	
	2009.01-	Saloon Engine M271.860		o	GHA249002	K
E 300 (170 kW)	2009.01-	Saloon Engine M 272.952	•		GWB6537	
	2009.01-	Saloon Engine M 272.952		o	GHA249002	K
E 300 (185 kW)	2011.07-	Saloon Engine M276.952	•		GWB6537	
	2011.07-	Saloon Engine M276.952		o	GHA249002	K
E 300 4-matic (185 kW)	2011.07-	Saloon Engine M276.952		o	GHA249002	K
E 300 CDI (150 kW)	2011.03-	Saloon Engine OM642.850	•		GWB6537	
	2011.03-	Saloon Engine OM642.850		o	GHA249002	K
E 300 CDI/BlueTEC (170 kW)	2011.03-	Saloon Engine OM642.850/OM642.852	•		GWB6537	
	2011.03-	Saloon Engine OM642.850/OM642.852		o	GHA249002	K
E 300 Hybrid/BlueTEC Hybrid (150 kW)	2011.12-	Saloon Engine OM651.924	•		GWB6537	
	2011.12-	Saloon Engine OM651.924		o	GHA249002	K
E 350 (200 kW)	2009.01-	Saloon Engine M272.980	•		GWB6537	
	2009.01-	Saloon Engine M272.980		o	GHA249002	K
E 350 (225 kW)	2011.09-	Saloon Engine M276.952	•		GWB6537	
	2011.09-	Saloon Engine M276.952		o	GHA249002	K
E 350 4-matic (200 kW)	2009.01-2011.08	Saloon Engine M272.977		o	GHA249002	K
E 350 4-matic (225 kW)	2011.09-	Saloon Engine M276.952		o	GHA249002	K
E 350 BlueTEC (190 kW)	2014.05-	Saloon Engine OM 642.852	•		GWB6537	
	2014.05-	Saloon Engine OM 642.852		o	GHA249002	K
E 350 BlueTEC (155 kW)	2009.01-	Saloon Engine OM624.850	•		GWB6537	



	 YEAR		F	R	G-AP Ref.	KIT
MERCEDES BENZ						
E-CLASS (W212)						
E 350 BlueTEC (155 kW)	2009.01-	Saloon Engine OM624.850		o	GHA249002	K
E 350 BlueTEC (185 kW)	2012.11-	Saloon Engine OM642.852	•		GWB6537	
	2012.11-	Saloon Engine OM642.852		o	GHA249002	K
E 350 BlueTEC 4-matic (190 kW)	2014.05-	Saloon Engine OM 642.858		o	GHA249002	K
E 350 BlueTEC 4-matic (185 kW)	2012.11-	Saloon Engine OM642.852/OM642.858		o	GHA249002	K
E 350 CDI (170 kW)	2009.01-	Saloon Engine OM642.850	•		GWB6537	
	2009.01-	Saloon Engine OM642.850		o	GHA249002	K
E 350 CDI (195 kW)	2011.03-	Saloon Engine OM642.852	•		GWB6537	
	2011.03-	Saloon Engine OM642.852		o	GHA249002	K
E 350 CDI 4-matic (170 kW)	2009.09-	Saloon Engine OM642.856		o	GHA249002	K
E 350 CDI 4-matic (195 kW)	2011.03-	Saloon Engine OM642.858		o	GHA249002	K
E 350 CGi (215 kW)	2009.01-2011.08	Saloon Engine M272.983	•		GWB6537	
	2009.01-2011.08	Saloon Engine M272.983		o	GHA249002	K
E 400 (245 kW)	2014.07-	Saloon Engine M 276.850	•		GWB6537	
	2014.07-	Saloon Engine M 276.850		o	GHA249002	K
E 400 (245 kW)	2013.01-	Saloon Engine M276.820	•		GWB6537	
	2013.01-	Saloon Engine M276.820		o	GHA249002	K
E 400 4-matic (245 kW)	2014.07-	Saloon Engine M 276.850		o	GHA249002	K
E 400 4-matic (245 kW)	2013.01-	Saloon Engine M276.820		o	GHA249002	K
E 500 (285 kW)	2009.01-	Saloon Engine M273.971	•		GWB6537	
	2009.01-	Saloon Engine M273.971		o	GHA249002	K
E 500 (300 kW)	2011.09-	Saloon Engine M278.922	•		GWB6537	
	2011.09-	Saloon Engine M278.922		o	GHA249002	K
E 500 4-matic (285 kW)	2009.01-	Saloon Engine M273.970		o	GHA249002	K
E 500 4-matic (300 kW)	2011.09-	Saloon Engine M278.922		o	GHA249002	K
E 63 AMG (386 kW)	2009.12-	Saloon Engine M156.985	•		GWB6537	
	2009.12-	Saloon Engine M156.985		o	GHA249002	K
	2011.02-	Saloon Engine M157.980/M157.981	•		GWB6537	
	2011.02-	Saloon Engine M157.980/M157.981		o	GHA249002	K
E 63 AMG (410 kW)	2011.02-	Saloon Engine M157.981	•		GWB6537	
	2011.02-	Saloon Engine M157.981		o	GHA249002	K
E 63 AMG 4-matic (410 kW)	2011.02-	Saloon Engine M157.981		o	GHA249002	K
E 63 AMG 4-matic (430 kW)	2013.02-	Estate Engine M157.981		o	GHA249002	K
E-CLASS T-MODEL (S211)						
350 CGi (215 kW)	2006.05-2009.07	Estate Engine M272.985	•		GWB6537	
	2006.05-2009.07	Estate Engine M272.985		o	GHA249002	K
E 200 CDI (100 kW)	2006.04-2009.07	Estate Engine OM646.821	•		GWB6537	
	2006.04-2009.07	Estate Engine OM646.821		o	GHA249002	K
E 200 Kompressor (135 kW)	2006.04-2009.07	Estate Engine M271.956	•		GWB6537	
	2006.04-2009.07	Estate Engine M271.956		o	GHA249002	K
E 200 T Kompressor (120 kW)	2003.05-2006.06	Estate Engine M271.941	•		GWB6537	
	2003.05-2006.06	Estate Engine M271.941		o	GHA249002	K
E 220 CDI (100 kW)	2003.03-2009.07	Estate Engine OM646.961	•		GWB6537	
	2003.03-2009.07	Estate Engine OM646.961		o	GHA249002	K
E 220 T CDI (110 kW)	2003.05-2006.06	Estate Engine OM646.961	•		GWB6537	
	2003.05-2006.06	Estate Engine OM646.961		o	GHA249002	K
E 220 T CDI (120 kW)	2003.03-2009.07	Estate Engine OM646.821	•		GWB6537	
	2003.03-2009.07	Estate Engine OM646.821		o	GHA249002	K
E 220 T CDI (125 kW)	2006.07-2009.07	Estate Engine OM646.821	•		GWB6537	
	2006.07-2009.07	Estate Engine OM646.821		o	GHA249002	K
E 230 T (150 kW)	2007.05-2009.07	Estate Engine M272.922	•		GWB6537	
	2007.05-2009.07	Estate Engine M272.922		o	GHA249002	K
E 240 T (130 kW)	2003.03-2009.07	Estate Engine M112.913	•		GWB6537	
	2003.03-2009.07	Estate Engine M112.913		o	GHA249002	K
E 240 T 4-matic (130 kW)	2003.07-2009.07	Estate Engine M112.917	•		GWB6646	
	2003.07-2009.07	Estate Engine M112.917		o	GHA249002	K
E 270 T CDI (120 kW)	2003.03-2009.07	Estate Engine OM 647.961	•		GWB6537	
	2003.03-2009.07	Estate Engine OM 647.961		o	GHA249002	K
E 270 T CDI (130 kW)	2003.05-2005.05	Estate Engine OM647.961	•		GWB6537	
	2003.05-2005.05	Estate Engine OM647.961		o	GHA249002	K
E 280 T (170 kW)	2005.06-2006.06	Estate Engine M272.943	•		GWB6537	
	2005.06-2006.06	Estate Engine M272.943		o	GHA249002	K
E 280 T 4-matic (170 kW)	2005.03-2009.07	Estate Engine M272.943	•		GWB6646	
	2005.03-2009.07	Estate Engine M272.943		o	GHA249002	K



	 YEAR		F	R	G-AP Ref.	KIT
MERCEDES BENZ						
E-CLASS T-MODEL (S211)						
E 280 T CDi (130 kW)	2004.05-2009.07	Estate Engine OM648.961	•		GWB6537	
	2004.05-2009.07	Estate Engine OM648.961		◦	GHA249002	K
E 280 T CDi (140 kW)	2005.06-2006.06	Estate Engine OM642.920	•		GWB6537	
	2005.06-2006.06	Estate Engine OM642.920		◦	GHA249002	K
E 280 T CDi 4-matic (140 kW)	2005.03-2009.07	Estate Engine OM642.921	•		GWB6646	
	2005.03-2009.07	Estate Engine OM642.921		◦	GHA249002	K
E 320 T (165 kW)	2003.03-2009.07	Estate Engine M112.949	•		GWB6537	
	2003.03-2009.07	Estate Engine M112.949		◦	GHA249002	K
E 320 T 4-matic (165 kW)	2003.07-2009.07	Estate Engine M112.954	•		GWB6646	
	2003.07-2009.07	Estate Engine M112.954		◦	GHA249002	K
E 320 T CDi (150 kW)	2003.03-2009.07	Estate Engine OM648.961	•		GWB6537	
	2003.03-2009.07	Estate Engine OM648.961		◦	GHA249002	K
E 320 T CDi (165 kW)	2005.03-2009.07	Estate Engine OM642.920	•		GWB6537	
	2005.03-2009.07	Estate Engine OM642.920		◦	GHA249002	K
E 320 T CDi 4-matic (165 kW)	2005.03-2009.07	Estate Engine OM642.920	•		GWB6646	
	2005.03-2009.07	Estate Engine OM642.920		◦	GHA249002	K
E 350 T (200 kW)	2004.11-2006.06	Estate Engine M272.964	•		GWB6537	
	2004.11-2006.06	Estate Engine M272.964		◦	GHA249002	K
E 350 T 4-matic (200 kW)	2005.03-2009.07	Estate Engine M272.972	•		GWB6646	
	2005.03-2009.07	Estate Engine M272.972		◦	GHA249002	K
E 500 T (225 kW)	2003.05-2006.06	Estate Engine M113.967	•		GWB6537	
	2003.05-2006.06	Estate Engine M113.967		◦	GHA249002	K
E 500 T (285 kW)	2006.07-2009.07	Estate Engine M273.960	•		GWB6537	
	2006.07-2009.07	Estate Engine M273.960		◦	GHA249002	K
E 500 T 4-matic (225 kW)	2003.10-2009.07	Estate Engine M113.969	•		GWB6646	
	2003.10-2009.07	Estate Engine M113.969		◦	GHA249002	K
E 500 T 4-matic (285 kW)	2006.04-2009.07	Estate Engine M273.962	•		GWB6646	
	2006.04-2009.07	Estate Engine M273.962		◦	GHA249002	K
E 55 T AMG Kompressor (350 kW)	2003.10-2006.06	Estate Engine M113.990	•		GWB6537	
	2003.10-2006.06	Estate Engine M113.990		◦	GHA249002	K
E 63 AMG (378 kW)	2006.07-2009.07	Estate Engine M156.983	•		GWB6537	
	2006.07-2009.07	Estate Engine M156.983		◦	GHA249002	K
E-CLASS T-MODEL (S212)						
E 200 (135 kW)	2012.11-	Estate Engine M 274.920	•		GWB6537	
	2012.11-	Estate Engine M 274.920		◦	GHA249002	K
E 200 CDi (100 kW)	2009.11-	Estate Engine OM651.925	•		GWB6537	
	2009.11-	Estate Engine OM651.925		◦	GHA249002	K
E 200 CGi (135 kW)	2009.11-	Estate Engine M271.860/M271.820	•		GWB6537	
	2009.11-	Estate Engine M271.860/M271.820		◦	GHA249002	K
E 220 BlueTEC (130 kW)	2015.05-	Estate Engine OM 651.924	•		GWB6537	
	2015.05-	Estate Engine OM 651.924		◦	GHA249002	K
E 220 BlueTEC 4-matic (125 kW)	2014.12-	Estate Engine OM 651.924		◦	GHA249002	K
E 220 CDi (120 kW)	2009.08-	Estate Engine OM 651.924	•		GWB6537	
	2009.08-	Estate Engine OM 651.924		◦	GHA249002	K
E 220 CDi (125 kW)	2009.11-	Estate Engine OM651.924	•		GWB6537	
	2009.11-	Estate Engine OM651.924		◦	GHA249002	K
E 250 (155 kW)	2012.11-	Estate Engine M 274.920	•		GWB6537	
	2012.11-	Estate Engine M 274.920		◦	GHA249002	K
E 250 CDi (150 kW)	2009.11-	Estate Engine OM651.924	•		GWB6537	
	2009.11-	Estate Engine OM651.924		◦	GHA249002	K
E 250 CDi 4-matic (150 kW)	2010.07-	Estate Engine OM651.924		◦	GHA249002	K
E 250 CGi (150 kW)	2009.11-	Estate Engine M271.860	•		GWB6537	
	2009.11-	Estate Engine M271.860		◦	GHA249002	K
E 300 (170 kW)	2009.11-	Estate Engine M272.952	•		GWB6537	
	2009.11-	Estate Engine M272.952		◦	GHA249002	K
E 300 (185 kW)	2011.07-	Estate Engine M276.952	•		GWB6537	
	2011.07-	Estate Engine M276.952		◦	GHA249002	K
E 300 4-matic (185 kW)	2011.07-	Estate Engine M276.952		◦	GHA249002	K
E 300 CDi (150 kW)	2011.03-	Estate Engine OM642.850	•		GWB6537	
	2011.03-	Estate Engine OM642.850		◦	GHA249002	K
E 300 CDi / BlueTEC (170 kW)	2009.11-	Estate Engine OM 642.850/OM 642.852	•		GWB6537	
	2009.11-	Estate Engine OM 642.850/OM 642.852		◦	GHA249002	K
E 300 Hybrid / BlueTEC Hybrid (150 kW)	2011.12-	Estate Engine OM 651.924	•		GWB6537	
	2011.12-	Estate Engine OM 651.924		◦	GHA249002	K



	 YEAR		F	R	G-AP Ref.	KIT
MERCEDES BENZ						
E-CLASS T-MODEL (S212)						
E 350 (200 kW)	2009.08-	Estate Engine M272.980	•		GWB6537	
	2009.08-	Estate Engine M272.980		◦	GHA249002	K
E 350 (225 kW)	2011.09-	Estate Engine M276.952	•		GWB6537	
	2011.09-	Estate Engine M276.952		◦	GHA249002	K
E 350 4-matic (200 kW)	2009.11-	Estate Engine M272.977		◦	GHA249002	K
E 350 4-matic (225 kW)	2011.09-	Estate Engine M276.952		◦	GHA249002	K
E 350 BlueTEC (190 kW)	2014.07-	Estate Engine OM 642.852	•		GWB6537	
	2014.07-	Estate Engine OM 642.852		◦	GHA249002	K
E 350 BlueTEC (155 kW)	2009.11-	Estate Engine OM642.850	•		GWB6537	
	2009.11-	Estate Engine OM642.850		◦	GHA249002	K
E 350 BlueTEC (185 kW)	2012.11-	Estate Engine OM 642.852	•		GWB6537	
	2012.11-	Estate Engine OM 642.852		◦	GHA249002	K
E 350 BlueTEC 4-matic (190 kW)	2014.07-	Estate Engine OM 642.852/OM 642.858		◦	GHA249002	K
E 350 BlueTEC 4-matic (185 kW)	2012.11-	Estate Engine OM 642.858		◦	GHA249002	K
E 350 CDI (170 kW)	2009.11-	Estate Engine OM642.850	•		GWB6537	
	2009.11-	Estate Engine OM642.850		◦	GHA249002	K
E 350 CDI (195 kW)	2011.07-	Estate Engine OM642.852	•		GWB6537	
	2011.07-	Estate Engine OM642.852		◦	GHA249002	K
E 350 CDI 4-matic (170 kW)	2009.11-	Estate Engine OM642.856		◦	GHA249002	K
E 350 CDI 4-matic (195 kW)	2011.07-	Estate Engine OM642.858		◦	GHA249002	K
E 350 CGI (215 kW)	2009.11-	Estate Engine M272.983	•		GWB6537	
	2009.11-	Estate Engine M272.983		◦	GHA249002	K
E 400 (245 kW)	2014.07-	Estate Engine M 276.850	•		GWB6537	
	2014.07-	Estate Engine M 276.850		◦	GHA249002	K
E 400 (245 kW)	2013.01-	Estate Engine M 276.820	•		GWB6537	
	2013.01-	Estate Engine M 276.820		◦	GHA249002	K
E 400 4-matic (245 kW)	2014.07-	Estate Engine M 276.850		◦	GHA249002	K
E 400 4-matic (245 kW)	2013.01-	Estate Engine M 276.820		◦	GHA249002	K
E 500 (285 kW)	2009.11-	Estate Engine M273.971	•		GWB6537	
	2009.11-	Estate Engine M273.971		◦	GHA249002	K
E 500 (300 kW)	2011.09-	Estate Engine M278.922	•		GWB6537	
	2011.09-	Estate Engine M278.922		◦	GHA249002	K
E 500 4-matic (300 kW)	2011.09-	Estate Engine M278.922		◦	GHA249002	K
E 63 AMG (386 kW)	2009.08-	Estate Engine M156.985	•		GWB6537	
	2009.08-	Estate Engine M156.985		◦	GHA249002	K
	2011.02-	Estate Engine M157.980/M157.981	•		GWB6537	
	2011.02-	Estate Engine M157.980/M157.981		◦	GHA249002	K
E 63 AMG (410 kW)	2011.02-	Estate Engine M157.981	•		GWB6537	
	2011.02-	Estate Engine M157.981		◦	GHA249002	K
E 63 AMG 4-matic (410 kW)	2011.02-	Estate Engine M 157.981		◦	GHA249002	K
E 63 AMG 4-matic (430 kW)	2013.02-	Estate Engine M157.981		◦	GHA249002	K
G-CLASS (W461)						
230 GE (90 kW)	1993.02-	Closed Off-Road Vehicle Engine M102.979	•		GWB1397	
	1993.02-	Closed Off-Road Vehicle Engine M102.979		◦	GWB1470	
230 GE (92 kW)	1993.06-	Closed Off-Road Vehicle Engine M102.996/M102.997	•		GWB1397	
	1993.06-	Closed Off-Road Vehicle Engine M102.996/M102.997		◦	GWB1470	
250 GD (68 kW)	1990.02-	Closed Off-Road Vehicle Engine OM602.939	•		GWB1397	
	1990.02-	Closed Off-Road Vehicle Engine OM602.939		◦	GWB1470	
290 GD/G 290 D (70 kW)	1992.04-	Closed Off-Road Vehicle Engine OM602.942	•		GWB1397	
	1992.04-	Closed Off-Road Vehicle Engine OM602.942		◦	GWB1470	
G 280 CDI (135 kW)	2009.04-	Closed Off-Road Vehicle Engine OM642.884	•		GWB3417	
	2009.04-	Closed Off-Road Vehicle Engine OM642.884		◦	GWB3435	
G 290 TD (88 kW)	1997.07-	Closed Off-Road Vehicle Engine OM602.983	•		GWB1397	
	1997.07-	Closed Off-Road Vehicle Engine OM602.983		◦	GWB1470	
	1997.07-	Closed Off-Road Vehicle Engine OM602.983		◦	GWB3435	
G 300 CDI (135 kW)	2010.04-	Closed Off-Road Vehicle Engine OM642.884	•		GWB3417	
G-CLASS (W463)						
200 GE (85 kW)	1990.01-1993.07	Closed Off-Road Vehicle Engine M 102.965	•		GWB3417	
	1990.01-1993.07	Closed Off-Road Vehicle Engine M 102.965		◦	GWB1470	
230 GE (93 kW)	1990.06-1993.06	Closed Off-Road Vehicle Engine M102.989	•		GWB3417	
	1990.06-1993.06	Closed Off-Road Vehicle Engine M102.989		◦	GWB1470	
250 GD (69 kW)	1990.06-	Closed Off-Road Vehicle Engine OM602.931	•		GWB3417	
	1990.06-	Closed Off-Road Vehicle Engine OM602.931		◦	GWB1470	
300 GE (125 kW)	1990.06-	Closed Off-Road Vehicle Engine M103.987	•		GWB3417	



	 YEAR		F	R	G-AP Ref.	KIT
MERCEDES BENZ						
G-CLASS (W463)						
300 GE (125 kW)	1990.06-	Closed Off-Road Vehicle Engine M103.987		o	GWB1470	
300 GE (128 kW)	1990.06-	Closed Off-Road Vehicle Engine M103.987	•		GWB3417	
	1990.06-	Closed Off-Road Vehicle Engine M103.987		o	GWB1470	
350 Turbo GD (100 kW)	1991.09-	Closed Off-Road Vehicle Engine OM603.972	•		GWB3417	
	1991.09-	Closed Off-Road Vehicle Engine OM603.972		o	GWB1470	
G 270 CDi (115 kW)	2001.10-	Closed Off-Road Vehicle Engine OM612.965	•		GWB3417	
	2001.10-	Closed Off-Road Vehicle Engine OM612.965		o	GWB3435	
G 300 TD (130 kW)	1996.08-	Closed Off-Road Vehicle Engine OM606.964	•		GWB3417	
	1996.08-	Closed Off-Road Vehicle Engine OM606.964		o	GWB1470	
	1996.08-	Closed Off-Road Vehicle Engine OM606.964		o	GWB3435	
G 320 (155 kW)	1994.09-1997.12	Closed Off-Road Vehicle Engine M104.996	•		GWB3417	
	1994.09-1997.12	Closed Off-Road Vehicle Engine M104.996		o	GWB1470	
G 320 (158 kW)	1997.07-	Closed Off-Road Vehicle Engine M112.945	•		GWB3417	
	1997.07-	Closed Off-Road Vehicle Engine M112.945		o	GWB3435	
G 320 CDi (165 kW)	2006.09-	Closed Off-Road Vehicle Engine OM642.970	•		GWB3417	
	2006.09-	Closed Off-Road Vehicle Engine OM642.970		o	GWB3435	
G 36 AMG (200 kW)	1995.01-	Closed Off-Road Vehicle Engine M104.996(AMG3,6)	•		GWB3417	
	1995.01-	Closed Off-Road Vehicle Engine M104.996(AMG3,6)		o	GWB1470	
G 400 CDi (184 kW)	2000.12-	Closed Off-Road Vehicle Engine OM628.962	•		GWB3417	
	2000.12-	Closed Off-Road Vehicle Engine OM628.962		o	GWB3435	
G 500 (218 kW)	1998.04-	Closed Off-Road Vehicle Engine M113.962	•		GWB3417	
	1998.04-	Closed Off-Road Vehicle Engine M113.962		o	GWB3435	
G 500 E (177 kW)	1993.09-	Closed Off-Road Vehicle Engine M117.965	•		GWB3417	
	1993.09-	Closed Off-Road Vehicle Engine M117.965		o	GWB1470	
G 55 AMG (260 kW)	1999.04-	Closed Off-Road Vehicle Engine M113.982	•		GWB3417	
	1999.04-	Closed Off-Road Vehicle Engine M113.982		o	GWB3435	
G 55 AMG (350 kW)	2004.06-	Closed Off-Road Vehicle Engine M113.993	•		GWB3417	
	2004.06-	Closed Off-Road Vehicle Engine M113.993		o	GWB3435	
G 55 AMG (368 kW)	2006.08-	Closed Off-Road Vehicle Engine M113.993	•		GWB3417	
	2006.08-	Closed Off-Road Vehicle Engine M113.993		o	GWB3435	
G 55 AMG (373 kW)	2008.08-	Closed Off-Road Vehicle Engine M113.993	•		GWB3417	
	2008.08-	Closed Off-Road Vehicle Engine M113.993		o	GWB3435	
G 63 AMG 6x6 (400 kW)	2014.12-	Closed Off-Road Vehicle Engine M 157.984	•		GWB3417	
	2014.12-	Closed Off-Road Vehicle Engine M 157.984		o	GWB3435	
G 65 AMG (450 kW)	2012.05-	Closed Off-Road Vehicle Engine M 279.982	•		GWB3417	
	2012.05-	Closed Off-Road Vehicle Engine M 279.982		o	GWB3435	
G-CLASS CABRIO (W463)						
200 GE (80 kW)	1990.01-1993.07	Open Off-Road Vehicle Engine M 102.965	•		GWB3417	
	1990.01-1993.07	Open Off-Road Vehicle Engine M 102.965		o	GWB1470	
200 GE (85 kW)	1990.01-1993.07	Open Off-Road Vehicle Engine M 102.965	•		GWB3417	
	1990.01-1993.07	Open Off-Road Vehicle Engine M 102.965		o	GWB1470	
230 GE (93 kW)	1990.06-1993.02	Open Off-Road Vehicle Engine M102.989	•		GWB3417	
	1990.06-1993.02	Open Off-Road Vehicle Engine M102.989		o	GWB1470	
300 GD (83 kW)	1990.12-1997.09	Open Off-Road Vehicle Engine OM603.931	•		GWB3417	
	1990.12-1997.09	Open Off-Road Vehicle Engine OM603.931		o	GWB1470	
320 GE (155 kW)	1994.09-1997.11	Open Off-Road Vehicle Engine M104.996	•		GWB3417	
	1994.09-1997.11	Open Off-Road Vehicle Engine M104.996		o	GWB1470	
350 G Turbo-D (100 kW)	1991.09-1997.09	Open Off-Road Vehicle Engine OM603.972	•		GWB3417	
	1991.09-1997.09	Open Off-Road Vehicle Engine OM603.972		o	GWB1470	
G 300 TD (130 kW)	1996.09-	Open Off-Road Vehicle Engine OM606.964	•		GWB3417	
	1996.09-	Open Off-Road Vehicle Engine OM606.964		o	GWB1470	
	1996.09-	Open Off-Road Vehicle Engine OM606.964		o	GWB3435	
G 320 (158 kW)	1997.11-	Open Off-Road Vehicle Engine M112.945	•		GWB3417	
	1997.11-	Open Off-Road Vehicle Engine M112.945		o	GWB3435	
G 320 CDi (165 kW)	2006.09-	Open Off-Road Vehicle Engine OM642.970	•		GWB3417	
	2006.09-	Open Off-Road Vehicle Engine OM642.970		o	GWB3435	
G 400 CDi (184 kW)	2000.12-	Open Off-Road Vehicle Engine OM628.962	•		GWB3417	
	2000.12-	Open Off-Road Vehicle Engine OM628.962		o	GWB3435	
G 500 (218 kW)	1998.04-	Open Off-Road Vehicle Engine M113.962	•		GWB3417	
G 500 (285 kW)	2009.12-	Open Off-Road Vehicle Engine M273.963	•		GWB3417	
GL-CLASS (X164)						
GL 320 CDi / 350 BlueTEC 4-matic (155 kW)	2009.12-	Closed Off-Road Vehicle Engine OM 642.820		o	GWB6559	
GL 320 CDi 4-matic (165 kW)	2006.09-2009.05	Closed Off-Road Vehicle Engine OM 642.940		o	GWB6559	
GL 350 CDi 4-matic (165 kW)	2009.05-	Closed Off-Road Vehicle Engine OM 642.940		o	GWB6559	



	 YEAR		F	R	G-AP Ref.	KIT
MERCEDES BENZ						
GL-CLASS (X164)						
GL 350 CDI 4-matic (195 kW)	2010.10-	Closed Off-Road Vehicle Engine OM 642.822		o	GWB6559	
GL 420 CDI 4-matic (225 kW)	2006.09-2009.05	Closed Off-Road Vehicle Engine OM 629.912		o	GWB6559	
GL 450 4-matic (250 kW)	2006.09-	Closed Off-Road Vehicle Engine OM 273.923		o	GWB6559	
GL 450 CDI 4-matic (225 kW)	2009.05-	Closed Off-Road Vehicle Engine OM 629.912		o	GWB6559	
GL-CLASS (X166)						
GL 350 CDI / BlueTec 4-matic (166.823, 166.824) (190 kW)	2012.07-	Closed Off-Road Vehicle Engine OM 642.826	•		GHA330047	
GL 500 4-matic (166.873) (320 kW)	2012.07-	Closed Off-Road Vehicle Engine M 278.928	•		GHA330047	
GL 63 AMG 4-matic (166.874) (410 kW)	2012.07-	Closed Off-Road Vehicle Engine M 157.982	•		GHA330047	
GLE (C292)						
350 D 4-matic (190 kW)	2015.03-	Coupe Engine OM 642.826	•		GHA330047	
400 4-matic (245 kW)	2015.03-	Coupe Engine M 276.821/M 276.825/M 276.925	•		GHA330047	
450 AMG 4-matic (270 kW)	2015.03-	Coupe Engine M 276.821	•		GHA330047	
AMG 63 4-matic (410 kW)	2015.03-	Coupe Engine M 157.982	•		GHA330047	
AMG 63 S 4-matic (430 kW)	2015.03-	Coupe Engine M 157.982	•		GHA330047	
GLE (W166)						
250 D 4-matic (150 kW)	2015.04-	Closed Off-Road Vehicle Engine OM 651.960	•		GHA330047	
350 D 4-matic (190 kW)	2015.04-	Closed Off-Road Vehicle Engine OM 642.826	•		GHA330047	
400 4-matic (245 kW)	2015.04-	Closed Off-Road Vehicle Engine M 276.821	•		GHA330047	
500 4-matic (320 kW)	2015.04-	Closed Off-Road Vehicle Engine M 278.928	•		GHA330047	
500 e 4-matic (245 kW)	2015.04-	Closed Off-Road Vehicle Engine M 276.821	•		GHA330047	
500 e 4-matic (325 kW)	2015.04-	Closed Off-Road Vehicle	•		GHA330047	
AMG 63 4-matic (410 kW)	2015.04-	Closed Off-Road Vehicle Engine M 157.982	•		GHA330047	
AMG 63 S 4-matic (430 kW)	2015.04-	Closed Off-Road Vehicle Engine M 157.982	•		GHA330047	
GLK-CLASS (X204)						
200 (135 kW)	2013.08-	Closed Off-Road Vehicle Engine M 274.920		o	GHA249002	K
200 CDI (100 kW)	2013.12-	Closed Off-Road Vehicle Engine OM 651.916		o	GHA249002	K
200 CDI (105 kW)	2010.07-	Closed Off-Road Vehicle Engine OM651.913/OM651.916		o	GHA249002	K
220 CDI (120 kW)	2008.12-	Closed Off-Road Vehicle Engine OM 651.916		o	GHA249002	K
220 CDI (125 kW)	2008.12-	Closed Off-Road Vehicle Engine OM651.916		o	GHA249002	K
220 CDI 4-matic (120 kW)	2008.12-	Closed Off-Road Vehicle Engine OM651.912		o	GHA249002	K
220 CDI 4-matic (125 kW)	2008.12-	Closed Off-Road Vehicle Engine OM651.912		o	GHA249002	K
250 (155 kW)	2013.08-	Closed Off-Road Vehicle Engine M 274.920		o	GHA249002	K
250 4-matic (155 kW)	2013.08-	Closed Off-Road Vehicle Engine M 274.920		o	GHA249002	K
250 CDI 4-matic (150 kW)	2009.09-	Closed Off-Road Vehicle Engine OM651.912		o	GHA249002	K
280 4-matic (170 kW)	2008.06-2009.06	Closed Off-Road Vehicle Engine M272.948		o	GHA249002	K
300 4-matic (170 kW)	2009.07-2011.04	Closed Off-Road Vehicle Engine M272.948		o	GHA249002	K
300 4-matic (185 kW)	2009.09-	Closed Off-Road Vehicle Engine M 276.957		o	GHA249002	K
320 CDI 4-matic (165 kW)	2008.06-	Closed Off-Road Vehicle Engine M642.961		o	GHA249002	K
350 (200 kW)	2009.04-	Closed Off-Road Vehicle Engine M272.991		o	GHA249002	K
350 4-matic (200 kW)	2008.06-2011.04	Closed Off-Road Vehicle Engine M272.971		o	GHA249002	K
350 4-matic (225 kW)	2008.06-	Closed Off-Road Vehicle Engine M276.957		o	GHA249002	K
350 CDI 4-matic (165 kW)	2009.07-2010.01	Closed Off-Road Vehicle Engine OM642.832		o	GHA249002	K
350 CDI 4-matic (170 kW)	2010.02-2010.05	Closed Off-Road Vehicle Engine OM642.832		o	GHA249002	K
350 CDI 4-matic (195 kW)	2012.07-	Closed Off-Road Vehicle Engine OM642.835		o	GHA249002	K
KOMBI (S124)						
200 E (77 kW)	1992.11-1993.05	Estate Engine M 102.922	•		GWB0941	
	1992.11-1993.05	Estate Engine M 102.922		o	GWB1347	
220 TE (110 kW)	1992.10-1993.05	Estate Engine M111.960	•		GWB0941	
	1992.10-1993.05	Estate Engine M111.960		o	GWB1347	
280 TE (145 kW)	1992.10-1993.06	Estate Engine M104.942	•		GWB0941	
	1992.10-1993.06	Estate Engine M104.942		o	GWB1347	
300 TD T (100 kW)	1992.06-1993.05	Estate Engine OM 603.960	•		GWB0941	
	1992.06-1993.05	Estate Engine OM 603.960		o	GWB1347	
320 TE (162 kW)	1992.10-1993.06	Estate Engine M104.992	•		GWB0941	
	1992.10-1993.06	Estate Engine M104.992		o	GWB1347	
M-CLASS (W163)						
ML 230 (110 kW)	1998.02-2005.06	Closed Off-Road Vehicle Engine M111.977	•		GWB3522	
ML 270 CDI (120 kW)	1999.12-2005.06	Closed Off-Road Vehicle Engine OM612.963	•		GWB3522	
ML 320 (160 kW)	1998.02-2002.08	Closed Off-Road Vehicle Engine M112.942	•		GWB3522	
ML 350 (173 kW)	2003.02-2005.06	Closed Off-Road Vehicle Engine M112.970	•		GWB3522	
ML 350 (180 kW)	2002.08-2005.06	Closed Off-Road Vehicle Engine M112.970	•		GWB3522	
ML 400 CDI (184 kW)	2001.09-2005.06	Closed Off-Road Vehicle Engine OM628.963	•		GWB3522	
ML 430 (200 kW)	1998.02-2005.06	Closed Off-Road Vehicle Engine M113.942	•		GWB3522	



	 YEAR		F	R	G-AP Ref.	KIT
MERCEDES BENZ						
M-CLASS (W163)						
ML 500 (215 kW)	2001.09-2005.06	Closed Off-Road Vehicle Engine M113.964/M113.965	•		GWB3522	
ML 55 AMG (255 kW)	2000.02-2005.06	Closed Off-Road Vehicle Engine M113.981	•		GWB3522	
M-CLASS (W164)						
ML 280 CDI 4-matic (140 kW)	2005.07-2009.07	Closed Off-Road Vehicle Engine OM642.940	•		GWB6559	
ML 300 CDI 4-matic (140 kW)	2009.07-	Closed Off-Road Vehicle Engine OM642.940	•		GWB6559	
ML 300 CDI 4-matic (150 kW)	2010.02-	Closed Off-Road Vehicle Engine OM642.820/OM642.832	•		GWB6559	
ML 320 CDI 4-matic (165 kW)	2005.07-2009.07	Closed Off-Road Vehicle Engine OM642.940	•		GWB6559	
ML 350 4-matic (200 kW)	2005.07-	Closed Off-Road Vehicle Engine M272.967	•		GWB6559	
ML 350 CDI 4-matic (155 kW)	2009.09-	Closed Off-Road Vehicle Engine OM642.820	•		GWB6559	
ML 350 CDI 4-matic (165 kW)	2009.07-	Closed Off-Road Vehicle Engine OM642.940	•		GWB6559	
ML 350 CDI 4-matic (170 kW)	2010.02-	Closed Off-Road Vehicle Engine OM642.820	•		GWB6559	
ML 420 CDI 4-matic (225 kW)	2006.02-2009.09	Closed Off-Road Vehicle Engine OM629.912		○	GWB6559	
ML 450 CDI 4-matic (225 kW)	2009.09-	Closed Off-Road Vehicle Engine OM629.912		○	GWB6559	
ML 500 4-matic (225 kW)	2005.07-	Closed Off-Road Vehicle Engine M113.964	•		GWB6559	
ML 500 4-matic (285 kW)	2007.12-	Closed Off-Road Vehicle Engine M273.963	•		GWB6559	
ML 63 AMG 4-matic (375 kW)	2006.01-	Closed Off-Road Vehicle Engine M156.980		○	GWB6559	
M-CLASS (W166)						
ML 250 CDI / BlueTEC 4-matic (150 kW)	2011.06-	Closed Off-Road Vehicle Engine OM 651.960	•		GHA330047	
ML 350 4-matic (166.057) (225 kW)	2011.06-	Closed Off-Road Vehicle Engine M 276.955	•		GHA330047	
ML 350 BlueTEC 4-matic (166.024) (190 kW)	2011.06-	Closed Off-Road Vehicle Engine OM 642.826	•		GHA330047	
ML 400 4-matic (166.056) (245 kW)	2013.08-	Closed Off-Road Vehicle Engine M 276.821	•		GHA330047	
ML 500 4-matic (166.073) (300 kW)	2012.02-	Closed Off-Road Vehicle Engine M 278.928	•		GHA330047	
ML 63 AMG 4-matic (166.074) (386 kW)	2011.11-	Closed Off-Road Vehicle Engine M 157.980	•		GHA330047	
ML 63 AMG 4-matic (166.074) (410 kW)	2011.11-	Closed Off-Road Vehicle Engine M 157.982	•		GHA330047	
R-CLASS (W251, V251)						
R 280 (170 kW)	2007.01-	MPV Engine M 272.945	•		GWB6559	
R 280 4-matic (170 kW)	2007.05-	MPV Engine M 272.945	•		GWB6559	
R 280 CDI (140 kW)	2006.05-	MPV Engine OM 642.870/OM 642.872/OM 642.950	•		GWB6559	
R 280 CDI 4-matic (140 kW)	2006.05-	MPV Engine OM 642.950	•		GWB6559	
R 300 (170 kW)	2009.07-	MPV Engine M 272.945	•		GWB6559	
R 300 CDI (140 kW)	2009.07-	MPV Engine OM 642.870/OM 642.872/OM 642.950	•		GWB6559	
R 300 CDI 4-matic (140 kW)	2009.07-	MPV Engine OM 642.950	•		GWB6559	
R 320 CDI 4-matic (155 kW)	2006.01-	MPV Engine OM 642.950/OM 642.870	•		GWB6559	
R 320 CDI 4-matic (165 kW)	2006.01-	MPV Engine OM 642.950	•		GWB6559	
R 350 (200 kW)	2007.01-	MPV Engine M 272.967	•		GWB6559	
R 350 4-matic (200 kW)	2006.01-	MPV Engine M 272.967	•		GWB6559	
R 350 CDI 4-matic (165 kW)	2009.07-	MPV Engine OM 642.950	•		GWB6559	
R 350 CDI 4-matic (195 kW)	2010.08-	MPV Engine OM 642.872	•		GWB6559	
R 350 CDI 4-matic (155 kW)	2006.01-	MPV Engine OM 642.950/OM 642.870	•		GWB6559	
R 350 CGI 4-matic (225 kW)	2006.01-	MPV Engine M 276.958	•		GWB6559	
R 500 4-matic (285 kW)	2007.01-	MPV Engine M 273.963	•		GWB6559	
R 500 4-matic (225 kW)	2006.01-	MPV Engine M 113.971	•		GWB6559	
R 63 AMG (375 kW)	2006.02-	MPV Engine M 156.980		○	GWB6559	
SALOON (W124)						
200 E (100 kW)	1992.10-1993.06	Saloon Engine M111.940	•		GWB0941	
	1992.10-1993.06	Saloon Engine M111.940		○	GWB0757	
220 E (110 kW)	1992.10-1993.06	Saloon Engine M111.960	•		GWB0941	
	1992.10-1993.06	Saloon Engine M111.960		○	GWB0757	
280 E (145 kW)	1992.10-1993.06	Saloon Engine M104.942	•		GWB0941	
	1992.10-1993.06	Saloon Engine M104.942		○	GWB0757	
300 D (81 kW)	1990.06-1993.06	Saloon Engine OM603.912	•		GWB0941	
	1990.06-1993.06	Saloon Engine OM603.912		○	GWB0757	
320 E (162 kW)	1992.10-1993.06	Saloon Engine M104.992	•		GWB0941	
	1992.10-1993.06	Saloon Engine M104.992		○	GWB0757	
400 E 4.2 (205 kW)	1992.10-1993.06	Saloon Engine M119.975	•		GWB1498	
	1992.10-1993.06	Saloon Engine M119.975		○	GWB0757	
500 E (240 kW)	1991.01-1993.06	Saloon Engine M119.974	•		GWB1498	
	1991.01-1993.06	Saloon Engine M119.974		○	GWB0757	
500 E AMG 6.0 (275 kW)	1992.01-1993.06	Saloon	•		GWB1498	
	1992.01-1993.06	Saloon		○	GWB0757	
S-CLASS (C140)						
CL 500 (225 kW)	1996.09-1997.12	Coupe	•		GWB1499	
	1996.09-1997.12	Coupe		○	GWB3628	



	 YEAR		F	R	G-AP Ref.	KIT
MERCEDES BENZ						
S-CLASS (C140)						
SEC/CL 420 (205 kW)	1994.10-1999.02	Coupe Engine M119.971/M119.981	•		GWB1499	
	1994.10-1999.02	Coupe Engine M119.971/M119.981		○	GWB3628	
SEC/CL 500 (235 kW)	1992.10-1999.02	Coupe Engine M119.970	•		GWB1499	
	1992.10-1999.02	Coupe Engine M119.970		○	GWB3400	
	1992.10-1999.02	Coupe Engine M119.970		○	GWB3628	
SEC/CL 600 (290 kW)	1992.09-1999.02	Coupe Engine M120.980/M120.982	•		GWB1499	
	1992.09-1999.02	Coupe Engine M120.980/M120.982		○	GWB3400	
	1992.09-1999.02	Coupe Engine M120.980/M120.982		○	GWB3628	
S-CLASS (C215)						
CL 500 (225 kW)	1999.03-2006.03	Coupe Engine M113.960	•		GWB3565	
	1999.03-2006.03	Coupe Engine M113.960		○	GWB3628	
CL 55 AMG (265 kW)	1999.10-2006.03	Coupe Engine M113.986	•		GWB3565	
	1999.10-2006.03	Coupe Engine M113.986		○	GWB3628	
CL 55 AMG Kompressor (368 kW)	2002.06-2006.03	Coupe Engine M113.991	•		GWB3565	
	2002.06-2006.03	Coupe Engine M113.991		○	GWB3628	
CL 600 (270 kW)	1999.03-2006.03	Coupe Engine M137.970	•		GWB3565	
	1999.03-2006.03	Coupe Engine M137.970		○	GWB3628	
CL 600 (368 kW)	2002.09-2006.03	Coupe Engine M275.950	•		GWB3565	
	2002.09-2006.03	Coupe Engine M275.950		○	GWB3628	
CL 63 AMG (326 kW)	2001.09-2006.03	Coupe Engine M137.980	•		GWB3565	
	2001.09-2006.03	Coupe Engine M137.980		○	GWB3628	
CL 65 AMG (450 kW)	2003.09-2006.03	Coupe Engine M275.980	•		GWB3565	
S-CLASS (C216)						
CL 500 (285 kW)	2006.09-	Coupe Engine M273.961		○	GHA249002	K
CL 500 (320 kW)	2011.02-	Coupe Engine M278.920		○	GHA249002	K
CL 500 4-matic (285 kW)	2008.02-	Coupe Engine M273.968		○	GHA249002	K
CL 500 4-matic (320 kW)	2011.02-	Coupe Engine M278.920		○	GHA249002	K
CL 600 (380 kW)	2006.09-	Coupe Engine M275.953		○	GHA249002	K
CL 63 AMG (386 kW)	2007.03-	Coupe Engine M156.984		○	GHA249002	K
CL 63 AMG (400 kW)	2011.02-	Coupe Engine M157.980		○	GHA249002	K
CL 63 AMG (420 kW)	2010.01-	Coupe Engine M157.980		○	GHA249002	K
CL 65 AMG (450 kW)	2007.05-	Coupe Engine M275.982		○	GHA249002	K
CL 65 AMG (463 kW)	2011.02-	Coupe Engine M275.982		○	GHA249002	K
S-CLASS (W140)						
300 SE 2.8 (145 kW)	1993.01-1998.10	Saloon Engine M104.944	•		GWB1499	
	1993.01-1998.10	Saloon Engine M104.944		○	GWB3400	
	1993.01-1998.10	Saloon Engine M104.944		○	GWB3628	
300 SE,SEL/S320 (170 kW)	1991.03-1998.10	Saloon Engine M104.990/M104.994	•		GWB1499	
	1991.03-1998.10	Saloon Engine M104.990/M104.994		○	GWB3400	
	1991.03-1998.10	Saloon Engine M104.990/M104.994		○	GWB3628	
400 SE,SEL/S420 (210 kW)	1991.02-1998.10	Saloon Engine M119.971	•		GWB1499	
	1991.02-1998.10	Saloon Engine M119.971		○	GWB3400	
	1991.02-1998.10	Saloon Engine M119.971		○	GWB3628	
500 SE,SEL (240 kW)	1991.02-1998.10	Saloon Engine M119.970	•		GWB1499	
	1991.02-1998.10	Saloon Engine M119.970		○	GWB3400	
	1991.02-1998.10	Saloon Engine M119.970		○	GWB3628	
600 SE,SEL (300 kW)	1991.04-1992.12	Saloon Engine M120.980/M120.982	•		GWB1499	
	1991.04-1992.12	Saloon Engine M120.980/M120.982		○	GWB3400	
	1991.04-1992.12	Saloon Engine M120.980/M120.982		○	GWB3628	
S 280 (142 kW)	1993.02-1998.10	Saloon Engine M104.944	•		GWB1499	
	1993.02-1998.10	Saloon Engine M104.944		○	GWB3400	
	1993.02-1998.10	Saloon Engine M104.944		○	GWB3628	
S 300 Turbo-D (130 kW)	1996.05-1998.10	Saloon Engine OM606.961	•		GWB1499	
	1996.05-1998.10	Saloon Engine OM606.961		○	GWB3628	
S 350 Turbo-D (110 kW)	1993.01-1998.10	Saloon Engine OM603.971	•		GWB1499	
	1993.01-1998.10	Saloon Engine OM603.971		○	GWB3400	
	1993.01-1998.10	Saloon Engine OM603.971		○	GWB3628	
S 420 (205 kW)	1993.01-1998.10	Saloon Engine M119.971	•		GWB1499	
	1993.01-1998.10	Saloon Engine M119.971		○	GWB3400	
	1993.01-1998.10	Saloon Engine M119.971		○	GWB3628	
S 500 (235 kW)	1993.01-1998.10	Saloon Engine M119.970/M119.980	•		GWB1499	
	1993.01-1998.10	Saloon Engine M119.970/M119.980		○	GWB3400	
	1993.01-1998.10	Saloon Engine M119.970/M119.980		○	GWB3628	
S 600 (290 kW)	1993.01-1998.10	Saloon Engine M120.980/M120.982	•		GWB1499	



	 YEAR		F	R	G-AP Ref.	KIT
MERCEDES BENZ						
S-CLASS (W140)						
S 600 (290 kW)	1993.01-1998.10	Saloon Engine M120.980/M120.982		o	GWB3400	
	1993.01-1998.10	Saloon Engine M120.980/M120.982		o	GWB3628	
S-CLASS (W220)						
S 280 (150 kW)	1998.10-2005.08	Saloon Engine M112.922	•		GWB3565	
	1998.10-2005.08	Saloon Engine M112.922		o	GWB3628	
S 320 (165 kW)	1998.10-2005.08	Saloon Engine M112.944	•		GWB3565	
	1998.10-2005.08	Saloon Engine M112.944		o	GWB3628	
S 320 CDI (145 kW)	1999.08-2002.09	Saloon Engine OM613.960	•		GWB3565	
	1999.08-2002.09	Saloon Engine OM613.960		o	GWB3628	
S 320 CDI (150 kW)	2002.09-2005.08	Saloon Engine OM648.960	•		GWB3565	
	2002.09-2005.08	Saloon Engine OM648.960		o	GWB3628	
S 350 (180 kW)	2002.09-2005.08	Saloon Engine M112.972	•		GWB3565	
	2002.09-2005.08	Saloon Engine M112.972		o	GWB3628	
S 350 4-matic (180 kW)	2003.06-2005.08	Saloon Engine M112.975	•		GWB6646	
	2003.06-2005.08	Saloon Engine M112.975		o	GWB3628	
S 400 CDI (184 kW)	2000.06-2005.08	Saloon Engine OM628.960	•		GWB3565	
	2000.06-2005.08	Saloon Engine OM628.960		o	GWB3628	
S 400 CDI (191 kW)	2003.06-2005.08	Saloon Engine OM628.960	•		GWB3565	
	2003.06-2005.08	Saloon Engine OM628.960		o	GWB3628	
S 430 (205 kW)	1998.10-2005.08	Saloon Engine M113.941	•		GWB3565	
	1998.10-2005.08	Saloon Engine M113.941		o	GWB3628	
S 430 4-matic (205 kW)	2002.09-2005.08	Saloon Engine M113.948	•		GWB6646	
	2002.09-2005.08	Saloon Engine M113.948		o	GWB3628	
S 500 (225 kW)	1998.10-2005.08	Saloon Engine M113.960	•		GWB3565	
	1998.10-2005.08	Saloon Engine M113.960		o	GWB3628	
S 500 4-matic (225 kW)	2002.09-2005.08	Saloon Engine M113.966	•		GWB6646	
	2002.09-2005.08	Saloon Engine M113.966		o	GWB3628	
S 55 AMG (265 kW)	1999.04-2005.08	Saloon Engine M113.986	•		GWB3565	
	1999.04-2005.08	Saloon Engine M113.986		o	GWB3628	
S 55 AMG Kompressor (368 kW)	2002.06-2005.08	Saloon Engine M113.991	•		GWB3565	
	2002.06-2005.08	Saloon Engine M113.991		o	GWB3628	
S 600 (270 kW)	2000.01-2005.08	Saloon Engine M137.970	•		GWB3565	
	2000.01-2005.08	Saloon Engine M137.970		o	GWB3628	
S 600 (368 kW)	2002.09-2005.08	Saloon Engine M275.950	•		GWB3565	
	2002.09-2005.08	Saloon Engine M275.950		o	GWB3628	
S 65 AMG (450 kW)	2004.03-2005.08	Saloon Engine M275.980	•		GWB3565	
S-CLASS (W221)						
S 250 CDI (150 kW)	2011.01-	Saloon Engine OM651.961		o	GHA249002	K
S 280 (170 kW)	2006.08-	Saloon Engine M272.946		o	GHA249002	K
S 300 (170 kW)	2006.08-	Saloon Engine M272.946		o	GHA249002	K
S 320 CDI (155 kW)	2005.10-	Saloon Engine OM642.930		o	GHA249002	K
S 320 CDI (173 kW)	2006.01-2009.06	Saloon Engine OM642.930		o	GHA249002	K
S 320 CDI 4-matic (155 kW)	2005.10-	Saloon Engine OM642.932		o	GHA249002	K
S 320 CDI 4-matic (173 kW)	2006.10-	Saloon Engine OM642.932		o	GHA249002	K
S 350 (200 kW)	2006.01-	Saloon Engine M272.965		o	GHA249002	K
S 350 4-matic (200 kW)	2008.02-	Saloon Engine M272.975		o	GHA249002	K
S 350 BlueTec (190 kW)	2011.04-	Saloon Engine OM642.862		o	GHA249002	K
S 350 BlueTEC 4-matic (190 kW)	2011.04-	Saloon Engine OM642.868		o	GHA249002	K
S 350 CGI (225 kW)	2011.04-	Saloon Engine M276.950		o	GHA249002	K
S 350 CGI 4-matic (225 kW)	2011.04-	Saloon Engine M276.950		o	GHA249002	K
S 400 Hybrid (205 kW)	2009.01-	Saloon Engine M272.974		o	GHA249002	K
S 420 CDI/S 450 CDI (235 kW)	2006.10-	Saloon Engine OM629.911		o	GHA249002	K
S 450 (250 kW)	2005.12-	Saloon Engine M273.922		o	GHA249002	K
S 450 4-matic (250 kW)	2005.12-	Saloon Engine M273.924		o	GHA249002	K
S 500 (285 kW)	2006.01-	Saloon Engine M273.961		o	GHA249002	K
S 500 4-matic (285 kW)	2005.10-	Saloon Engine M273.961/M237.968		o	GHA249002	K
S 500 CGI (320 kW)	2011.04-	Saloon Engine M278.932		o	GHA249002	K
S 500 CGI 4-matic (320 kW)	2011.03-	Saloon Engine M278.932		o	GHA249002	K
S 600 (380 kW)	2006.01-	Saloon Engine M275.953		o	GHA249002	K
S 63 AMG (386 kW)	2006.12-	Saloon Engine M156.984		o	GHA249002	K
S 63 AMG (400 kW)	2011.03-	Saloon Engine M157.980		o	GHA249002	K
S 63 AMG (420 kW)	2012.02-	Saloon Engine M157.980		o	GHA249002	K
S 65 AMG (450 kW)	2006.09-	Saloon Engine M275.982		o	GHA249002	K
S 65 AMG (463 kW)	2011.04-	Saloon Engine M275.982		o	GHA249002	K



	 YEAR		F	R	G-AP Ref.	KIT
MERCEDES BENZ						
SL (R129)						
280 (142 kW)	1993.08-2001.10	Convertible Engine M104.943		o	GWB0757	
280 (150 kW)	1998.05-2001.10	Convertible Engine M112.923/M112.925		o	GWB0757	
320 (165 kW)	1998.05-2001.10	Convertible Engine M112.943		o	GWB0757	
320 (170 kW)	1993.09-2001.10	Convertible Engine M104.991		o	GWB0757	
500 (225 kW)	1998.05-2001.10	Convertible Engine M113.961		o	GWB0757	
500 (235 kW)	1992.09-2001.10	Convertible Engine M119.972/M119.982		o	GWB0757	
55 AMG (260 kW)	2000.03-2001.10	Convertible Engine M113.985		o	GWB0757	
6.0 AMG (280 kW)	1997.05-2001.10	Convertible Engine M122.981		o	GWB0757	
600 (290 kW)	1992.07-2001.10	Convertible Engine M120.981/M120.983		o	GWB0757	
600 SL (300 kW)	1992.02-1994.08	Convertible Engine M 120.980/M 120.981/M 120.983		o	GWB0757	
SL 73 AMG (385 kW)	1999.01-2001.12	Convertible		o	GWB0757	
SL (R230)						
280 (170 kW)	2008.03-2012.01	Convertible Engine M272.949	•		GWB6537	
	2008.03-2012.01	Convertible Engine M272.949		o	GHA249005	K
300 (170 kW)	2009.04-2012.01	Convertible Engine M272.949	•		GWB6537	
	2009.04-2012.01	Convertible Engine M272.949		o	GHA249005	K
350 (180 kW)	2003.03-2012.01	Convertible Engine M112.973	•		GWB6537	
	2003.03-2012.01	Convertible Engine M112.973		o	GHA249005	K
350 (200 kW)	2006.03-2012.01	Convertible Engine M272.966	•		GWB6537	
	2006.03-2012.01	Convertible Engine M272.966		o	GHA249005	K
350 (232 kW)	2008.04-2012.01	Convertible Engine M272.968	•		GWB6537	
	2008.04-2012.01	Convertible Engine M272.968		o	GHA249005	K
500 (225 kW)	2001.10-2012.01	Convertible Engine M113.963	•		GWB6537	
	2001.10-2012.01	Convertible Engine M113.963		o	GHA249005	K
500 (285 kW)	2006.03-2012.01	Convertible Engine M273.965	•		GWB6537	
	2006.03-2012.01	Convertible Engine M273.965		o	GHA249005	K
55 AMG (350 kW)	2001.10-2002.06	Convertible Engine M113.992	•		GWB6537	
	2001.10-2002.06	Convertible Engine M113.992		o	GHA249005	K
55 AMG (380 kW)	2006.03-2012.01	Convertible Engine M113.995	•		GWB6537	
	2006.03-2012.01	Convertible Engine M113.995		o	GHA249005	K
55 AMG Kompressor (368 kW)	2002.06-2012.01	Convertible Engine M113.992	•		GWB6537	
	2002.06-2012.01	Convertible Engine M113.992		o	GHA249005	K
600 (368 kW)	2003.05-2006.02	Convertible Engine M275.951	•		GWB6537	
	2003.05-2006.02	Convertible Engine M275.951		o	GHA249005	K
600 (380 kW)	2006.03-2012.01	Convertible Engine M275.954	•		GWB6537	
	2006.03-2012.01	Convertible Engine M275.954		o	GHA249005	K
63 AMG (386 kW)	2008.03-2012.01	Convertible Engine M156.981	•		GWB6537	
	2008.03-2012.01	Convertible Engine M156.981		o	GHA249005	K
65 AMG (450 kW)	2005.04-2006.02	Convertible Engine M275.981	•		GWB6537	
SLK (R170)						
200 (100 kW)	1996.09-2000.03	Convertible Engine M111.946	•		GHA235024	K
	1996.09-2000.03	Convertible Engine M111.946	•		GWB1498	
	1996.09-2000.03	Convertible Engine M111.946		o	GHA425048	
	1996.09-2000.03	Convertible Engine M111.946		o	GWB0757	
200 Kompressor (120 kW)	2000.03-2004.04	Convertible Engine M111.958	•		GHA235024	K
	2000.03-2004.04	Convertible Engine M111.958	•		GWB1498	
	2000.03-2004.04	Convertible Engine M111.958		o	GWB0757	
200 Kompressor (141 kW)	1996.10-2000.03	Convertible Engine M111.943	•		GHA235024	K
	1996.10-2000.03	Convertible Engine M111.943	•		GWB1498	
	1996.10-2000.03	Convertible Engine M111.943		o	GHA425048	
	1996.10-2000.03	Convertible Engine M111.943		o	GWB0757	
230 Kompressor (142 kW)	1996.09-2000.03	Convertible Engine M111.973	•		GHA235024	K
	1996.09-2000.03	Convertible Engine M111.973	•		GWB1498	
	1996.09-2000.03	Convertible Engine M111.973		o	GHA425048	
	1996.09-2000.03	Convertible Engine M111.973		o	GWB0757	
230 Kompressor (145 kW)	2000.03-2004.04	Convertible Engine M111.983	•		GHA235024	K
	2000.03-2004.04	Convertible Engine M111.983	•		GWB1498	
	2000.03-2004.04	Convertible Engine M111.983		o	GWB0757	



	 YEAR		F	R	G-AP Ref.	KIT
MERCEDES BENZ						
SLK (R170)						
32 AMG Kompressor (260 kW)	2001.03-2004.04	Convertible Engine M112.960	•		GHA235024	K
	2001.03-2004.04	Convertible Engine M112.960	•		GWB1498	
	2001.03-2004.04	Convertible Engine M112.960		o	GWB0757	
320 (160 kW)	2000.03-2004.04	Convertible Engine M112.947	•		GHA235024	K
	2000.03-2004.04	Convertible Engine M112.947	•		GWB1498	
	2000.03-2004.04	Convertible Engine M112.947		o	GWB0757	
SLK (R171)						
200 Kompressor (120 kW)	2004.07-2007.04	Convertible Engine M271.944	•		GWB6530	
	2004.07-2007.04	Convertible Engine M271.944		o	GHA425048	
	2004.07-2007.04	Convertible Engine M271.944		o	GWB0757	
200 Kompressor (135 kW)	2008.01-2011.02	Convertible Engine M271.954	•		GWB6530	
	2008.01-2011.02	Convertible Engine M271.954		o	GHA425048	
	2008.01-2011.02	Convertible Engine M271.954		o	GWB0757	
280 (170 kW)	2005.06-2007.04	Convertible Engine M272.942	•		GWB6530	
	2005.06-2007.04	Convertible Engine M272.942		o	GHA425048	
	2005.06-2007.04	Convertible Engine M272.942		o	GWB0757	
300 (170 kW)	2009.04-2011.02	Convertible Engine M272.942	•		GWB6530	
	2009.04-2011.02	Convertible Engine M272.942		o	GHA425048	
	2009.04-2011.02	Convertible Engine M272.942		o	GWB0757	
350 (200 kW)	2004.07-2005.03	Convertible Engine M272.963	•		GWB6530	
	2004.07-2005.03	Convertible Engine M272.963		o	GHA425048	
	2004.07-2005.03	Convertible Engine M272.963		o	GWB0757	
350 (224 kW)	2008.01-2011.02	Convertible Engine M272.969	•		GWB6530	
	2008.01-2011.02	Convertible Engine M272.969		o	GHA425048	
	2008.01-2011.02	Convertible Engine M272.969		o	GWB0757	
55 AMG (265 kW)	2004.07-2005.03	Convertible Engine M113.989	•		GWB6530	
	2004.07-2005.03	Convertible Engine M113.989		o	GHA425048	
	2004.07-2005.03	Convertible Engine M113.989		o	GWB0757	
55 AMG (294 kW)	2006.06-2011.02	Convertible Engine M113.989	•		GWB6530	
	2006.06-2011.02	Convertible Engine M113.989		o	GHA425048	
	2006.06-2011.02	Convertible Engine M113.989		o	GWB0757	
SLK (R172)						
200 (135 kW)	2011.02-	Convertible Engine M271.860/M271.861	•		GHA499042	
	2011.02-	Convertible Engine M271.860/M271.861	•		GWB6530	
	2011.02-	Convertible Engine M271.860/M271.861		o	GHA249005	K
	2015.04-	Convertible Engine M 274.920	•		GWB6530	
	2015.04-	Convertible Engine M 274.920		o	GHA249005	K
250 (150 kW)	2011.02-	Convertible Engine M271.860/M271.861	•		GHA499042	
	2011.02-	Convertible Engine M271.860/M271.861	•		GWB6530	
	2011.02-	Convertible Engine M271.860/M271.861		o	GHA249005	K
250 CDI (150 kW)	2012.01-	Convertible Engine OM651.980	•		GHA499042	
	2012.01-	Convertible Engine OM651.980	•		GWB6530	
	2012.01-	Convertible Engine OM651.980		o	GHA249005	K
300 (180 kW)	2015.07-	Convertible Engine M 274.920	•		GWB6530	
	2015.07-	Convertible Engine M 274.920		o	GHA249005	K
350 (225 kW)	2011.02-	Convertible Engine M276.956	•		GHA499042	
	2011.02-	Convertible Engine M276.956	•		GWB6530	
	2011.02-	Convertible Engine M276.956		o	GHA249005	K
55 AMG (310 kW)	2012.01-	Convertible Engine M152.980	•		GHA499042	
	2012.01-	Convertible Engine M152.980	•		GWB6530	
	2012.01-	Convertible Engine M152.980		o	GHA249005	K
SLS AMG (A197)						
6.2 (420 kW)	2011.06-	Convertible Engine M159.980	•		GHA249002	K
	2011.06-	Convertible Engine M159.980		o	GHA249005	K
SPRINTER 2-T (901, 902)						
208 CDI (60 kW)	2000.04-2006.05	Box Engine OM611.987	•		GWB3434	
	2000.04-2006.05	Box Engine OM611.987	•		GWB6686	
	2000.04-2006.05	Box Engine OM611.987		o	GWB3435	
	2000.04-2006.05	Bus Engine OM611.987	•		GWB3434	
	2000.04-2006.05	Bus Engine OM611.987	•		GWB6686	
	2000.04-2006.05	Bus Engine OM611.987		o	GWB3435	
	2000.04-2006.05	Platform/Chassis Engine OM611.987	•		GWB3434	
	2000.04-2006.05	Platform/Chassis Engine OM611.987	•		GWB6686	



	 YEAR		F	R	G-AP Ref.	KIT
MERCEDES BENZ						
SPRINTER 2-T (901, 902)						
208 CDi (60 kW)	2000.04-2006.05	Platform/Chassis Engine OM611.987		o	GWB3435	
208 D (58 kW)	1995.01-2000.04	Platform/Chassis Engine OM601.943	•		GWB3434	
	1995.01-2000.04	Platform/Chassis Engine OM601.943	•		GWB6686	
	1995.01-2000.04	Platform/Chassis Engine OM601.943		o	GWB3435	
	1995.02-2000.04	Box Engine OM601.943	•		GWB3434	
	1995.02-2000.04	Box Engine OM601.943	•		GWB6686	
	1995.02-2000.04	Box Engine OM601.943		o	GWB3435	
	1995.02-2000.04	Bus Engine OM601.943	•		GWB3434	
	1995.02-2000.04	Bus Engine OM601.943	•		GWB6686	
	1995.02-2000.04	Bus Engine OM601.943		o	GWB3435	
	1995.02-2000.04	Bus Engine OM601.943	•		GWB3434	
208 D (60 kW)	1996.09-2000.04	Platform/Chassis Engine OM601.943	•		GWB3434	
	1996.09-2000.04	Platform/Chassis Engine OM601.943	•		GWB6686	
	1996.09-2000.04	Platform/Chassis Engine OM601.943		o	GWB3435	
	1996.10-2000.04	Box Engine OM601.943	•		GWB3434	
	1996.10-2000.04	Box Engine OM601.943	•		GWB6686	
210 D (75 kW)	1997.01-2000.04	Box Engine OM602.980	•		GWB3434	
	1997.01-2000.04	Box Engine OM602.980	•		GWB6686	
	1997.01-2000.04	Box Engine OM602.980		o	GWB3435	
	1997.01-2000.04	Platform/Chassis Engine OM602.980	•		GWB3434	
	1997.01-2000.04	Platform/Chassis Engine OM602.980	•		GWB6686	
	1997.01-2000.04	Platform/Chassis Engine OM602.980		o	GWB3435	
	1997.03-2000.04	Bus Engine OM602.980	•		GWB3434	
	1997.03-2000.04	Bus Engine OM602.980	•		GWB6686	
211 CDi (80 kW)	2000.04-2006.05	Box Engine OM611.981	•		GWB3434	
	2000.04-2006.05	Box Engine OM611.981	•		GWB6686	
	2000.04-2006.05	Box Engine OM611.981		o	GWB3435	
	2000.04-2006.05	Bus Engine OM611.981	•		GWB3434	
	2000.04-2006.05	Bus Engine OM611.981	•		GWB6686	
	2000.04-2006.05	Bus Engine OM611.981		o	GWB3435	
	2000.04-2006.05	Platform/Chassis Engine OM611.981	•		GWB3434	
	2000.04-2006.05	Platform/Chassis Engine OM611.981	•		GWB6686	
212 D (90 kW)	1995.02-2000.04	Box Engine OM602.980	•		GWB3434	
	1995.02-2000.04	Box Engine OM602.980	•		GWB6686	
	1995.02-2000.04	Box Engine OM602.980		o	GWB3435	
	1995.02-2000.04	Bus Engine OM602.980	•		GWB3434	
	1995.02-2000.04	Bus Engine OM602.980	•		GWB6686	
	1995.02-2000.04	Bus Engine OM602.980		o	GWB3435	
	1995.02-2000.04	Platform/Chassis Engine OM602.980	•		GWB3434	
	1995.02-2000.04	Platform/Chassis Engine OM602.980	•		GWB6686	
213 CDi (95 kW)	2000.04-2006.05	Box Engine OM611.981	•		GWB3434	
	2000.04-2006.05	Box Engine OM611.981	•		GWB6686	
	2000.04-2006.05	Box Engine OM611.981		o	GWB3435	
	2000.04-2006.05	Bus Engine OM611.981	•		GWB3434	
	2000.04-2006.05	Bus Engine OM611.981	•		GWB6686	
	2000.04-2006.05	Bus Engine OM611.981		o	GWB3435	
	2000.04-2006.05	Platform/Chassis Engine OM611.981	•		GWB3434	
	2000.04-2006.05	Platform/Chassis Engine OM611.981	•		GWB6686	
214 (105 kW)	1995.02-2006.05	Box Engine M111.979/M111.984	•		GWB3434	
	1995.02-2006.05	Box Engine M111.979/M111.984	•		GWB6686	
	1995.02-2006.05	Box Engine M111.979/M111.984		o	GWB3435	
	1995.02-2006.05	Bus Engine M111.979	•		GWB3434	
	1995.02-2006.05	Bus Engine M111.979	•		GWB6686	
	1995.02-2006.05	Bus Engine M111.979		o	GWB3435	
	1995.02-2006.05	Platform/Chassis Engine M111.979	•		GWB3434	
	1995.02-2006.05	Platform/Chassis Engine M111.979	•		GWB6686	
214 NGT (92 kW)	2000.04-2006.05	Box Engine M111.984	•		GWB3434	
	2000.04-2006.05	Box Engine M111.984	•		GWB6686	
	2000.04-2006.05	Box Engine M111.984		o	GWB3435	



	 YEAR		F	R	G-AP Ref.	KIT
MERCEDES BENZ						
SPRINTER 2-T (901, 902)						
214 NGT (92 kW)	2000.04-2006.05	Bus Engine M111.984	•		GWB3434	
	2000.04-2006.05	Bus Engine M111.984	•		GWB6686	
	2000.04-2006.05	Bus Engine M111.984		o	GWB3435	
	2000.04-2006.05	Platform/Chassis	•		GWB3434	
	2000.04-2006.05	Platform/Chassis	•		GWB6686	
	2000.04-2006.05	Platform/Chassis		o	GWB3435	
216 CDi (115 kW)	2000.04-2006.05	Box Engine OM612.981	•		GWB3434	
	2000.04-2006.05	Box Engine OM612.981	•		GWB6686	
	2000.04-2006.05	Box Engine OM612.981		o	GWB3435	
	2000.04-2006.05	Bus Engine OM612.981	•		GWB3434	
	2000.04-2006.05	Bus Engine OM612.981	•		GWB6686	
	2000.04-2006.05	Bus Engine OM612.981		o	GWB3435	
	2000.04-2006.05	Platform/Chassis Engine OM612.981	•		GWB3434	
	2000.04-2006.05	Platform/Chassis Engine OM612.981	•		GWB6686	
	2000.04-2006.05	Platform/Chassis Engine OM612.981		o	GWB3435	
SPRINTER 3,5 (906)						
309 CDi (65 kW)	2006.06-	Platform/Chassis Engine OM646.984	•		GHA400353	K
	2006.06-	Platform/Chassis Engine OM646.984	•		GHA400354	K
	2006.06-	Platform/Chassis Engine OM646.984		o	GHA329008	K
	2006.06-	Platform/Chassis Engine OM646.984		o	GHA329013	
310 CDi (70 kW)	2009.03-	Platform/Chassis Engine OM651.955	•		GHA400353	K
	2009.03-	Platform/Chassis Engine OM651.955	•		GHA400354	K
	2009.03-	Platform/Chassis Engine OM651.955		o	GHA329008	K
311 CDi (80 kW)	2009.03-	Platform/Chassis Engine OM651.955		o	GHA329013	
	2006.06-	Platform/Chassis Engine OM646.985	•		GHA400353	K
	2006.06-	Platform/Chassis Engine OM646.985	•		GHA400354	K
	2006.06-	Platform/Chassis Engine OM646.985		o	GHA329008	K
311 CDi 4x4 (80 kW)	2006.06-	Platform/Chassis Engine OM646.985		o	GHA329013	
	2008.02-	Platform/Chassis Engine OM646.985		o	GHA329008	K
	2008.02-	Platform/Chassis Engine OM646.985		o	GHA329013	
	2008.02-	Platform/Chassis Engine OM646.985		o	GHA329008	K
313 CDi (95 kW)	2006.06-	Platform/Chassis Engine OM646.986	•		GHA400353	K
	2006.06-	Platform/Chassis Engine OM646.986	•		GHA400354	K
	2006.06-	Platform/Chassis Engine OM646.986		o	GHA329008	K
	2006.06-	Platform/Chassis Engine OM646.986		o	GHA329013	
	2006.06-	Platform/Chassis Engine OM651.956	•		GHA400353	K
	2006.06-	Platform/Chassis Engine OM651.956	•		GHA400354	K
315 CDi (110 kW)	2006.06-	Platform/Chassis Engine OM646.990/OM646.989	•		GHA400353	K
	2006.06-	Platform/Chassis Engine OM646.990/OM646.989	•		GHA400354	K
	2006.06-	Platform/Chassis Engine OM646.990/OM646.989		o	GHA329008	K
	2006.06-	Platform/Chassis Engine OM646.990/OM646.989		o	GHA329013	
	2006.06-	Platform/Chassis Engine OM646.990/OM646.989		o	GHA329008	K
315 CDi 4x4 (110 kW)	2008.02-	Platform/Chassis Engine OM646.989/OM646.990		o	GHA329008	K
	2008.02-	Platform/Chassis Engine OM646.989/OM646.990		o	GHA329013	
316 (115 kW)	2008.09-	Platform/Chassis Engine M271.951	•		GHA400353	K
	2008.09-	Platform/Chassis Engine M271.951	•		GHA400354	K
	2008.09-	Platform/Chassis Engine M271.951		o	GHA329008	K
	2008.09-	Platform/Chassis Engine M271.951		o	GHA329013	
316 CDi (120 kW)	2009.03-	Platform/Chassis Engine OM651.957	•		GHA400353	K
	2009.03-	Platform/Chassis Engine OM651.957	•		GHA400354	K
	2009.03-	Platform/Chassis Engine OM651.957		o	GHA329008	K
	2009.03-	Platform/Chassis Engine OM651.957		o	GHA329013	
316 CDi 4x4 (120 kW)	2009.03-	Platform/Chassis Engine OM651.957		o	GHA329008	K
	2009.03-	Platform/Chassis Engine OM651.957		o	GHA329013	
316 LGT (115 kW)	2008.09-	Platform/Chassis Engine M271.951		o	GHA329008	K
	2008.09-	Platform/Chassis Engine M271.951		o	GHA329013	
316 NGT (115 kW)	2008.09-	Platform/Chassis Engine M271.951	•		GHA400353	K
	2008.09-	Platform/Chassis Engine M271.951	•		GHA400354	K
	2008.09-	Platform/Chassis Engine M271.951		o	GHA329008	K
	2008.09-	Platform/Chassis Engine M271.951		o	GHA329008	K
	2008.09-	Platform/Chassis Engine M271.951		o	GHA329013	
	2008.09-	Platform/Chassis Engine M271.951		o	GHA329013	
	2008.09-	Platform/Chassis Engine M271.951		o	GHA329013	
318 CDi (135 kW)	2006.06-	Platform/Chassis Engine OM646.992/OM646.993/OM646.896	•		GHA400353	K
	2006.06-	Platform/Chassis Engine OM646.992/OM646.993/OM646.896	•		GHA400354	K
	2006.06-	Platform/Chassis Engine OM646.992/OM646.993/OM646.896		o	GHA329008	K
	2006.06-	Platform/Chassis Engine OM646.992/OM646.993/OM646.896		o	GHA329013	



	 YEAR		F	R	G-AP Ref.	KIT
MERCEDES BENZ						
SPRINTER 3,5 (906)						
318 CDI 4x4 (135 kW)	2008.02-	Platform/Chassis Engine OM642.896/OM642.992/OM642.993		o	GHA329008	K
	2008.02-	Platform/Chassis Engine OM642.896/OM642.992/OM642.993		o	GHA329013	
319 CDI/BlueTEC (140 kW)	2009.03-	Platform/Chassis Engine OM642.896/OM642.898/OM642.992	•		GHA400353	K
	2009.03-	Platform/Chassis Engine OM642.896/OM642.898/OM642.992	•		GHA400354	K
	2009.03-	Platform/Chassis Engine OM642.896/OM642.898/OM642.992		o	GHA329008	K
	2009.03-	Platform/Chassis Engine OM642.896/OM642.898/OM642.992		o	GHA329013	
324 (190 kW)	2006.06-	Platform/Chassis Engine M272.979	•		GHA400353	K
	2006.06-	Platform/Chassis Engine M272.979	•		GHA400354	K
	2006.06-	Platform/Chassis Engine M272.979		o	GHA329008	K
	2006.06-	Platform/Chassis Engine M272.979		o	GHA329013	
SPRINTER 3,5-T (906)						
313 CDI 4x4 (95 kW)	2006.06-			o	GHA329008	K
	2006.06-			o	GHA329013	
	2009.05-			o	GHA329008	K
	2009.05-			o	GHA329013	
SPRINTER 3,5-T (906)						
309 CDI (65 kW)	2006.06-	Box Engine OM646.984	•		GHA400353	K
	2006.06-	Box Engine OM646.984	•		GHA400354	K
	2006.06-	Box Engine OM646.984		o	GHA329008	K
	2006.06-	Box Engine OM646.984		o	GHA329013	
310 CDI (70 kW)	2009.03-	Box Engine OM651.955	•		GHA400353	K
	2009.03-	Box Engine OM651.955	•		GHA400354	K
	2009.03-	Box Engine OM651.955		o	GHA329008	K
	2009.03-	Box Engine OM651.955		o	GHA329013	
	2009.03-	Bus Engine OM651.955	•		GHA400353	K
	2009.03-	Bus Engine OM651.955	•		GHA400354	K
311 CDI (80 kW)	2006.06-	Box Engine OM646.985	•		GHA400353	K
	2006.06-	Box Engine OM646.985	•		GHA400354	K
	2006.06-	Box Engine OM646.985		o	GHA329008	K
	2006.06-	Box Engine OM646.985		o	GHA329013	
	2006.06-	Bus Engine OM646.985	•		GHA400353	K
	2006.06-	Bus Engine OM646.985	•		GHA400354	K
	2006.06-	Bus Engine OM646.985		o	GHA329008	K
	2006.06-	Bus Engine OM646.985		o	GHA329013	
311 CDI 4x4 (80 kW)	2008.02-	Box Engine OM646.985		o	GHA329008	K
	2008.02-	Box Engine OM646.985		o	GHA329013	
	2008.02-	Bus Engine OM646.985		o	GHA329008	K
	2008.02-	Bus Engine OM646.985		o	GHA329013	
313 CDI (95 kW)	2009.05-	Box Engine OM 651.955/OM 651.956	•		GHA400353	K
	2009.05-	Box Engine OM 651.955/OM 651.956	•		GHA400354	K
	2011.08-	Bus Engine OM 651.955/OM 651.956	•		GHA400353	K
	2011.08-	Bus Engine OM 651.955/OM 651.956	•		GHA400354	K
313 CDI (95 kW)	2006.06-	Box Engine OM646.986/OM651.955	•		GHA400353	K
	2006.06-	Box Engine OM646.986/OM651.955	•		GHA400354	K
	2006.06-	Box Engine OM646.986/OM651.955		o	GHA329008	K
	2006.06-	Box Engine OM646.986/OM651.955		o	GHA329013	
315 CDI (110 kW)	2006.06-	Box Engine OM646.989/OM646.990	•		GHA400353	K
	2006.06-	Box Engine OM646.989/OM646.990	•		GHA400354	K
	2006.06-	Box Engine OM646.989/OM646.990		o	GHA329008	K
	2006.06-	Box Engine OM646.989/OM646.990		o	GHA329013	
	2006.06-	Bus Engine OM646.989/OM646.990	•		GHA400353	K
	2006.06-	Bus Engine OM646.989/OM646.990	•		GHA400354	K
	2006.06-	Bus Engine OM646.989/OM646.990		o	GHA329008	K
	2006.06-	Bus Engine OM646.989/OM646.990		o	GHA329013	
315 CDI 4x4 (110 kW)	2008.02-	Box Engine OM646.989/OM646.990		o	GHA329008	K
	2008.02-	Box Engine OM646.989/OM646.990		o	GHA329013	
	2008.02-	Bus Engine OM646.989/OM646.990		o	GHA329008	K
	2008.02-	Bus Engine OM646.989/OM646.990		o	GHA329013	
316 (115 kW)	2008.09-	Box Engine M271.951	•		GHA400353	K
	2008.09-	Box Engine M271.951	•		GHA400354	K
	2008.09-	Box Engine M271.951		o	GHA329008	K
	2008.09-	Box Engine M271.951		o	GHA329013	
	2008.09-	Bus Engine M271.951	•		GHA400353	K
	2008.09-	Bus Engine M271.951	•		GHA400354	K



	 YEAR		F	R	G-AP Ref.	KIT
MERCEDES BENZ						
SPRINTER 3,5-T (906)						
316 (115 kW)	2008.09-	Bus Engine M271.951		o	GHA329008	K
	2008.09-	Bus Engine M271.951		o	GHA329013	
316 CDI (120 kW)	2009.03-	Box Engine OM651.957	•		GHA400353	K
	2009.03-	Box Engine OM651.957	•		GHA400354	K
	2009.03-	Box Engine OM651.957		o	GHA329008	K
	2009.03-	Box Engine OM651.957		o	GHA329013	
	2011.08-	Bus Engine OM651.957		o	GHA329008	K
	2011.08-	Bus Engine OM651.957		o	GHA329013	
316 CDI 4x4 (120 kW)	2009.03-	Box Engine OM651.957		o	GHA329008	K
	2009.03-	Box Engine OM651.957		o	GHA329013	
316 NGT (115 kW)	2008.09-	Box Engine M271.951	•		GHA400353	K
	2008.09-	Box Engine M271.951	•		GHA400354	K
	2008.09-	Box Engine M271.951		o	GHA329008	K
	2008.09-	Box Engine M271.951		o	GHA329013	
	2008.09-	Bus Engine M271.951	•		GHA400353	K
	2008.09-	Bus Engine M271.951	•		GHA400354	K
	2008.09-	Bus Engine M271.951		o	GHA329008	K
	2008.09-	Bus Engine M271.951		o	GHA329013	
318 CDI (135 kW)	2006.06-	Box Engine OM642.992/OM642.993/OM642.896	•		GHA400353	K
	2006.06-	Box Engine OM642.992/OM642.993/OM642.896	•		GHA400354	K
	2006.06-	Box Engine OM642.992/OM642.993/OM642.896		o	GHA329008	K
	2006.06-	Box Engine OM642.992/OM642.993/OM642.896		o	GHA329013	
	2008.02-	Bus Engine OM642.896/OM642.992/OM642.993	•		GHA400353	K
	2008.02-	Bus Engine OM642.896/OM642.992/OM642.993	•		GHA400354	K
318 CDI 4x4 (135 kW)	2008.02-	Box Engine OM642.896/OM642.992/OM642.993		o	GHA329008	K
	2008.02-	Box Engine OM642.896/OM642.992/OM642.993		o	GHA329013	
319 CDI/BlueTEC (140 kW)	2009.03-	Box Engine OM642.896/OM642.898/OM642.992	•		GHA400353	K
	2009.03-	Box Engine OM642.896/OM642.898/OM642.992	•		GHA400354	K
	2009.03-	Box Engine OM642.896/OM642.898/OM642.992		o	GHA329008	K
	2009.03-	Box Engine OM642.896/OM642.898/OM642.992		o	GHA329013	
	2009.03-	Bus Engine OM642.896/OM642.898/OM642.992	•		GHA400353	K
	2009.03-	Bus Engine OM642.896/OM642.898/OM642.992	•		GHA400354	K
	2009.03-	Bus Engine OM642.896/OM642.898/OM642.992		o	GHA329008	K
	2009.03-	Bus Engine OM642.896/OM642.898/OM642.992		o	GHA329013	
324 (190 kW)	2006.06-	Box Engine M272.979	•		GHA400353	K
	2006.06-	Box Engine M272.979	•		GHA400354	K
	2006.06-	Box Engine M272.979		o	GHA329008	K
	2006.06-	Box Engine M272.979		o	GHA329013	
	2006.06-	Bus Engine M272.979	•		GHA400353	K
	2006.06-	Bus Engine M272.979	•		GHA400354	K
	2006.06-	Bus Engine M272.979		o	GHA329008	K
	2006.06-	Bus Engine M272.979		o	GHA329013	
SPRINTER 3-T (903)						
308 CDI (60 kW)	2000.04-2006.05	Box Engine OM611.987	•		GWB3434	
	2000.04-2006.05	Box Engine OM611.987	•		GWB6686	
	2000.04-2006.05	Box Engine OM611.987		o	GWB3435	
	2000.04-2006.05	Bus Engine OM611.987	•		GWB3434	
	2000.04-2006.05	Bus Engine OM611.987	•		GWB6686	
	2000.04-2006.05	Bus Engine OM611.987		o	GWB3435	
	2000.04-2006.05	Platform/Chassis Engine OM611.987	•		GWB3434	
	2000.04-2006.05	Platform/Chassis Engine OM611.987	•		GWB6686	
	2000.04-2006.05	Platform/Chassis Engine OM611.987		o	GWB3435	
308 D (58 kW)	1995.02-2000.04	Bus Engine OM601.943	•		GWB3434	
	1995.02-2000.04	Bus Engine OM601.943	•		GWB6686	
	1995.02-2000.04	Bus Engine OM601.943		o	GWB3435	
308 D 2.3 (58 kW)	1995.02-2000.04	Box Engine OM601.943	•		GWB3434	
	1995.02-2000.04	Box Engine OM601.943	•		GWB6686	
	1995.02-2000.04	Box Engine OM601.943		o	GWB3435	
	1995.02-2000.04	Platform/Chassis Engine OM601.943	•		GWB3434	
	1995.02-2000.04	Platform/Chassis Engine OM601.943	•		GWB6686	
	1995.02-2000.04	Platform/Chassis Engine OM601.943		o	GWB3435	
308 D 2.3 (60 kW)	1995.02-2000.04	Box Engine OM601.943	•		GWB3434	
	1995.02-2000.04	Box Engine OM601.943	•		GWB6686	
	1995.02-2000.04	Box Engine OM601.943		o	GWB3435	



	 YEAR		F	R	G-AP Ref.	KIT
MERCEDES BENZ						
SPRINTER 3-T (903)						
308 D 2.3 (60 kW)	1996.11-2000.04	Platform/Chassis Engine OM601.943	•		GWB3434	
	1996.11-2000.04	Platform/Chassis Engine OM601.943	•		GWB6686	
	1996.11-2000.04	Platform/Chassis Engine OM601.943		o	GWB3435	
308 E (40 kW)	2000.04-2006.05	Bus	•		GWB3434	
	2000.04-2006.05	Bus	•		GWB6686	
	2000.04-2006.05	Bus		o	GWB3435	
310 D 2.9 (75 kW)	1995.02-2000.04	Box Engine OM602.980	•		GWB3434	
	1995.02-2000.04	Box Engine OM602.980	•		GWB6686	
	1995.02-2000.04	Box Engine OM602.980		o	GWB3435	
	1997.01-2000.04	Platform/Chassis Engine OM602.980	•		GWB3434	
	1997.01-2000.04	Platform/Chassis Engine OM602.980	•		GWB6686	
1997.01-2000.04	Platform/Chassis Engine OM602.980		o	GWB3435		
310 D 4x4 (75 kW)	1997.05-2002.08	Bus Engine OM602.980		o	GWB3435	
311 CDI (80 kW)	2000.04-2006.05	Box Engine OM611.981	•		GWB3434	
	2000.04-2006.05	Box Engine OM611.981	•		GWB6686	
	2000.04-2006.05	Box Engine OM611.981		o	GWB3435	
	2000.04-2006.05	Bus Engine OM611.981	•		GWB3434	
	2000.04-2006.05	Bus Engine OM611.981	•		GWB6686	
	2000.04-2006.05	Bus Engine OM611.981		o	GWB3435	
	2000.04-2006.05	Platform/Chassis Engine OM611.981	•		GWB3434	
	2000.04-2006.05	Platform/Chassis Engine OM611.981	•		GWB6686	
	2000.04-2006.05	Platform/Chassis Engine OM611.981		o	GWB3435	
311 CDI 4x4 (80 kW)	2002.08-2006.05	Box Engine OM611.981		o	GWB3435	
	2002.08-2006.05	Bus Engine OM611.981		o	GWB3435	
	2002.08-2006.05	Platform/Chassis Engine OM611.981		o	GWB3435	
312 D 2.9 (90 kW)	1995.02-2000.04	Box Engine OM602.980	•		GWB3434	
	1995.02-2000.04	Box Engine OM602.980	•		GWB6686	
	1995.02-2000.04	Box Engine OM602.980		o	GWB3435	
	1995.02-2000.04	Bus Engine OM602.980	•		GWB3434	
	1995.02-2000.04	Bus Engine OM602.980	•		GWB6686	
	1995.02-2000.04	Bus Engine OM602.980		o	GWB3435	
	1995.02-2000.04	Platform/Chassis Engine OM602.980	•		GWB3434	
	1995.02-2000.04	Platform/Chassis Engine OM602.980	•		GWB6686	
1995.02-2000.04	Platform/Chassis Engine OM602.980		o	GWB3435		
312 D 2.9 4x4 (90 kW)	1997.05-2002.08	Box Engine OM602.980		o	GWB3435	
	1997.05-2002.08	Bus Engine OM602.980		o	GWB3435	
313 CDI (95 kW)	2000.04-2006.05	Box Engine OM611.981	•		GWB3434	
	2000.04-2006.05	Box Engine OM611.981	•		GWB6686	
	2000.04-2006.05	Box Engine OM611.981		o	GWB3435	
	2000.04-2006.05	Bus Engine OM611.981	•		GWB3434	
	2000.04-2006.05	Bus Engine OM611.981	•		GWB6686	
	2000.04-2006.05	Bus Engine OM611.981		o	GWB3435	
	2000.04-2006.05	Platform/Chassis Engine OM611.981	•		GWB3434	
	2000.04-2006.05	Platform/Chassis Engine OM611.981	•		GWB6686	
	2000.04-2006.05	Platform/Chassis Engine OM611.981		o	GWB3435	
313 CDI 4x4 (95 kW)	2002.08-2006.05	Box Engine OM611.981		o	GWB3435	
	2002.08-2006.05	Bus Engine OM611.981		o	GWB3435	
	2002.08-2006.05	Platform/Chassis Engine OM611.981		o	GWB3435	
314 (105 kW)	1995.02-2006.05	Box Engine M111.979/M111.984	•		GWB3434	
	1995.02-2006.05	Box Engine M111.979/M111.984	•		GWB6686	
	1995.02-2006.05	Box Engine M111.979/M111.984		o	GWB3435	
	1995.02-2006.05	Bus Engine M111.984	•		GWB3434	
	1995.02-2006.05	Bus Engine M111.984	•		GWB6686	
	1995.02-2006.05	Bus Engine M111.984		o	GWB3435	
	1995.02-2006.05	Platform/Chassis Engine M111.984	•		GWB3434	
	1995.02-2006.05	Platform/Chassis Engine M111.984	•		GWB6686	
1995.02-2006.05	Platform/Chassis Engine M111.984		o	GWB3435		
314 4x4 (105 kW)	2002.08-2006.05	Box Engine M111.984		o	GWB3435	
	2002.08-2006.05	Platform/Chassis Engine M111.984		o	GWB3435	
314 NGT (92 kW)	2000.04-2006.05	Box	•		GWB3434	
	2000.04-2006.05	Box	•		GWB6686	
	2000.04-2006.05	Box		o	GWB3435	
	2000.04-2006.05	Bus Engine M111.984	•		GWB3434	
	2000.04-2006.05	Bus Engine M111.984	•		GWB6686	



	 YEAR		F	R	G-AP Ref.	KIT
MERCEDES BENZ						
SPRINTER 3-T (903)						
314 NGT (92 kW)	2000.04-2006.05	Bus Engine M111.984		o	GWB3435	
	2000.04-2006.05	Platform/Chassis	•		GWB3434	
	2000.04-2006.05	Platform/Chassis	•		GWB6686	
	2000.04-2006.05	Platform/Chassis		o	GWB3435	
316 CDI (115 kW)	2000.04-2006.05	Box Engine OM612.981	•		GWB3434	
	2000.04-2006.05	Box Engine OM612.981	•		GWB6686	
	2000.04-2006.05	Box Engine OM612.981		o	GWB3435	
	2000.04-2006.05	Bus Engine OM612.981	•		GWB3434	
	2000.04-2006.05	Bus Engine OM612.981	•		GWB6686	
	2000.04-2006.05	Bus Engine OM612.981		o	GWB3435	
	2000.04-2006.05	Platform/Chassis Engine OM612.981	•		GWB3434	
	2000.04-2006.05	Platform/Chassis Engine OM612.981	•		GWB6686	
	2000.04-2006.05	Platform/Chassis Engine OM612.981		o	GWB3435	
316 CDI 4x4 (115 kW)	2002.08-2006.05	Box Engine OM612.981		o	GWB3435	
	2002.08-2006.05	Bus Engine OM612.981		o	GWB3435	
	2002.08-2006.05	Platform/Chassis Engine OM612.981		o	GWB3435	
SPRINTER 3-T (906)						
209 CDI (65 kW)	2006.06-	Box Engine OM646.984	•		GHA400353	K
	2006.06-	Box Engine OM646.984	•		GHA400354	K
	2006.06-	Box Engine OM646.984		o	GHA329008	K
	2006.06-	Box Engine OM646.984		o	GHA329013	K
	2006.06-	Platform/Chassis Engine OM646.984	•		GHA400353	K
	2006.06-	Platform/Chassis Engine OM646.984	•		GHA400354	K
	2006.06-	Platform/Chassis Engine OM646.984		o	GHA329008	K
210 CDI (70 kW)	2009.03-	Box Engine OM651.955	•		GHA400353	K
	2009.03-	Box Engine OM651.955	•		GHA400354	K
	2009.03-	Box Engine OM651.955		o	GHA329008	K
	2009.03-	Box Engine OM651.955		o	GHA329013	K
	2009.03-	Bus Engine OM651.955	•		GHA400353	K
	2009.03-	Bus Engine OM651.955	•		GHA400354	K
	2009.03-	Bus Engine OM651.955		o	GHA329008	K
	2009.03-	Bus Engine OM651.955		o	GHA329013	K
	2009.03-	Platform/Chassis Engine OM651.955	•		GHA400353	K
	2009.03-	Platform/Chassis Engine OM651.955	•		GHA400354	K
	2009.03-	Platform/Chassis Engine OM651.955		o	GHA329008	K
211 CDI (80 kW)	2006.06-	Box Engine OM646.985	•		GHA400353	K
	2006.06-	Box Engine OM646.985	•		GHA400354	K
	2006.06-	Box Engine OM646.985		o	GHA329008	K
	2006.06-	Box Engine OM646.985		o	GHA329013	K
	2006.06-	Bus Engine OM646.985	•		GHA400353	K
	2006.06-	Bus Engine OM646.985	•		GHA400354	K
	2006.06-	Bus Engine OM646.985		o	GHA329008	K
	2006.06-	Bus Engine OM646.985		o	GHA329013	K
	2006.06-	Platform/Chassis Engine OM646.985	•		GHA400353	K
	2006.06-	Platform/Chassis Engine OM646.985	•		GHA400354	K
	2006.06-	Platform/Chassis Engine OM646.985		o	GHA329008	K
	2006.06-	Platform/Chassis Engine OM646.985		o	GHA329013	K
	2006.06-	Platform/Chassis Engine OM646.985		o	GHA329013	K
	2006.06-	Platform/Chassis Engine OM646.985		o	GHA329013	K
213 CDI (95 kW)	2006.06-	Box Engine OM646.986	•		GHA400353	K
	2006.06-	Box Engine OM646.986	•		GHA400354	K
	2006.06-	Box Engine OM646.986		o	GHA329008	K
	2006.06-	Box Engine OM646.986		o	GHA329013	K
	2006.06-	Platform/Chassis Engine OM646.986	•		GHA400353	K
	2006.06-	Platform/Chassis Engine OM646.986	•		GHA400354	K
	2006.06-	Platform/Chassis Engine OM646.986		o	GHA329008	K
	2006.06-	Platform/Chassis Engine OM646.986		o	GHA329013	K
	2009.03-	Platform/Chassis Engine OM651.956	•		GHA400353	K
	2009.03-	Platform/Chassis Engine OM651.956	•		GHA400354	K
215 CDI (110 kW)	2006.06-	Box Engine OM646.989/OM646.990	•		GHA400353	K
	2006.06-	Box Engine OM646.989/OM646.990	•		GHA400354	K
	2006.06-	Box Engine OM646.989/OM646.990		o	GHA329008	K
	2006.06-	Box Engine OM646.989/OM646.990		o	GHA329013	K
	2006.06-	Bus Engine OM646.989/OM646.990	•		GHA400353	K



	 YEAR		F	R	G-AP Ref.	KIT
MERCEDES BENZ						
SPRINTER 3-T (906)						
215 CDi (110 kW)	2006.06-	Bus Engine OM646.989/OM646.990	•		GHA400354	K
	2006.06-	Bus Engine OM646.989/OM646.990		o	GHA329008	K
	2006.06-	Bus Engine OM646.989/OM646.990		o	GHA329013	
	2006.06-	Platform/Chassis Engine OM646.990/OM646.989	•		GHA400353	K
	2006.06-	Platform/Chassis Engine OM646.990/OM646.989	•		GHA400354	K
	2006.06-	Platform/Chassis Engine OM646.990/OM646.989		o	GHA329008	K
	2006.06-	Platform/Chassis Engine OM646.990/OM646.989		o	GHA329013	
	216 (115 kW)	2008.09-	Box Engine M271.951	•		GHA400353
2008.09-		Box Engine M271.951	•		GHA400354	K
2008.09-		Box Engine M271.951		o	GHA329008	K
2008.09-		Box Engine M271.951		o	GHA329013	
2008.09-		Bus Engine M271.951	•		GHA400353	K
2008.09-		Bus Engine M271.951	•		GHA400354	K
2008.09-		Bus Engine M271.951		o	GHA329008	K
2008.09-		Bus Engine M271.951		o	GHA329013	
2008.09-		Platform/Chassis Engine M271.951	•		GHA400353	K
2008.09-		Platform/Chassis Engine M271.951	•		GHA400354	K
2008.09-		Platform/Chassis Engine M271.951		o	GHA329008	K
2008.09-		Platform/Chassis Engine M271.951		o	GHA329013	
216 CDi (120 kW)	2009.03-	Box Engine OM651.957	•		GHA400353	K
	2009.03-	Box Engine OM651.957	•		GHA400354	K
	2009.03-	Box Engine OM651.957		o	GHA329008	K
	2009.03-	Box Engine OM651.957		o	GHA329013	
	2009.03-	Platform/Chassis Engine OM651.957	•		GHA400353	K
	2009.03-	Platform/Chassis Engine OM651.957	•		GHA400354	K
	2009.03-	Platform/Chassis Engine OM651.957		o	GHA329008	K
	2009.03-	Platform/Chassis Engine OM651.957		o	GHA329013	
218 CDi (135 kW)	2006.06-	Box Engine OM642.992/OM642.896	•		GHA400353	K
	2006.06-	Box Engine OM642.992/OM642.896	•		GHA400354	K
	2006.06-	Box Engine OM642.992/OM642.896		o	GHA329008	K
	2006.06-	Box Engine OM642.992/OM642.896		o	GHA329013	
	2006.06-	Platform/Chassis Engine OM642.992/OM642.993/OM642.896	•		GHA400353	K
	2006.06-	Platform/Chassis Engine OM642.992/OM642.993/OM642.896	•		GHA400354	K
	2006.06-	Platform/Chassis Engine OM642.992/OM642.993/OM642.896		o	GHA329008	K
	2006.06-	Platform/Chassis Engine OM642.992/OM642.993/OM642.896		o	GHA329013	
219 CDi/BlueTEC (140 kW)	2009.03-	Box Engine OM642.896/OM642.992	•		GHA400353	K
	2009.03-	Box Engine OM642.896/OM642.992	•		GHA400354	K
	2009.03-	Box Engine OM642.896/OM642.992		o	GHA329008	K
	2009.03-	Box Engine OM642.896/OM642.992		o	GHA329013	
	2009.03-	Platform/Chassis Engine OM642.896/OM642.992	•		GHA400353	K
	2009.03-	Platform/Chassis Engine OM642.896/OM642.992	•		GHA400354	K
	2009.03-	Platform/Chassis Engine OM642.896/OM642.992		o	GHA329008	K
	2009.03-	Platform/Chassis Engine OM642.896/OM642.992		o	GHA329013	
224 (190 kW)	2006.06-	Box Engine M272.979	•		GHA400353	K
	2006.06-	Box Engine M272.979	•		GHA400354	K
	2006.06-	Box Engine M272.979		o	GHA329008	K
	2006.06-	Box Engine M272.979		o	GHA329013	
	2006.06-	Bus Engine M272.979	•		GHA400353	K
	2006.06-	Bus Engine M272.979	•		GHA400354	K
	2006.06-	Bus Engine M272.979		o	GHA329008	K
	2006.06-	Bus Engine M272.979		o	GHA329013	
	2006.06-	Platform/Chassis Engine M272.979	•		GHA400353	K
	2006.06-	Platform/Chassis Engine M272.979	•		GHA400354	K
	2006.06-	Platform/Chassis Engine M272.979		o	GHA329008	K
	2006.06-	Platform/Chassis Engine M272.979		o	GHA329013	
SPRINTER 4,6-T (906)						
413 CDi (95 kW)	2006.06-	Box Engine OM 646.986	•		GHA400353	K
	2006.06-	Box Engine OM 646.986	•		GHA400354	K
	2006.06-	Platform/Chassis Engine OM 646.986	•		GHA400353	K
	2006.06-	Platform/Chassis Engine OM 646.986	•		GHA400354	K
415 CDi (110 kW)	2006.06-	Platform/Chassis Engine OM 646.989/OM 646.990	•		GHA400353	K
	2006.06-	Platform/Chassis Engine OM 646.989/OM 646.990	•		GHA400354	K
416 CDi (120 kW)	2009.03-	Box Engine OM651.957	•		GHA400353	K
	2009.03-	Box Engine OM651.957	•		GHA400354	K



	 YEAR		F	R	G-AP Ref.	KIT
MERCEDES BENZ						
SPRINTER 4,6-T (906)						
416 CDi (120 kW)	2009.03-	Platform/Chassis Engine OM651.957	•		GHA400353	K
	2009.03-	Platform/Chassis Engine OM651.957	•		GHA400354	K
418 CDi (135 kW)	2006.06-	Platform/Chassis Engine OM 642.896/OM 642.992/OM 642.993	•		GHA400353	K
	2006.06-	Platform/Chassis Engine OM 642.896/OM 642.992/OM 642.993	•		GHA400354	K
419 CDi (140 kW)	2009.03-	Box Engine OM 642.992	•		GHA400353	K
	2009.03-	Box Engine OM 642.992	•		GHA400354	K
419 CDi (140 kW)	2009.03-	Platform/Chassis Engine OM642.992/OM642.896/OM642.898	•		GHA400353	K
	2009.03-	Platform/Chassis Engine OM642.992/OM642.896/OM642.898	•		GHA400354	K
424 (190 kW)	2006.06-	Box Engine M272.979	•		GHA400353	K
	2006.06-	Box Engine M272.979	•		GHA400354	K
	2006.06-	Platform/Chassis Engine M272.979	•		GHA400353	K
	2006.06-	Platform/Chassis Engine M272.979	•		GHA400354	K
SPRINTER 4-T (904)						
408 CDi (60 kW)	2000.04-2006.05	Box Engine OM611.987	•		GWB3434	
	2000.04-2006.05	Box Engine OM611.987	•		GWB6686	
	2000.04-2006.05	Box Engine OM611.987		o	GWB3435	
	2000.04-2006.05	Box Engine OM611.987		o	GWB3475	
	2000.04-2006.05	Bus Engine OM611.987	•		GWB3434	
	2000.04-2006.05	Bus Engine OM611.987	•		GWB6686	
	2000.04-2006.05	Bus Engine OM611.987		o	GWB3435	
	2000.04-2006.05	Bus Engine OM611.987		o	GWB3475	
	2000.04-2006.05	Platform/Chassis Engine OM611.987	•		GWB3434	
	2000.04-2006.05	Platform/Chassis Engine OM611.987	•		GWB6686	
	2000.04-2006.05	Platform/Chassis Engine OM611.987		o	GWB3435	
	2000.04-2006.05	Platform/Chassis Engine OM611.987		o	GWB3475	
408 D (58 kW)	1996.02-2006.05	Box Engine OM601.943	•		GWB3434	
	1996.02-2006.05	Box Engine OM601.943	•		GWB6686	
	1996.02-2006.05	Box Engine OM601.943		o	GWB3435	
	1996.02-2006.05	Box Engine OM601.943		o	GWB3475	
	1996.02-2006.05	Platform/Chassis Engine OM601.943	•		GWB3434	
	1996.02-2006.05	Platform/Chassis Engine OM601.943	•		GWB6686	
	1996.02-2006.05	Platform/Chassis Engine OM601.943		o	GWB3435	
	1996.02-2006.05	Platform/Chassis Engine OM601.943		o	GWB3475	
410 D (75 kW)	1996.02-2006.05	Box Engine OM602.980	•		GWB3434	
	1996.02-2006.05	Box Engine OM602.980	•		GWB6686	
	1996.02-2006.05	Box Engine OM602.980		o	GWB3435	
	1996.02-2006.05	Box Engine OM602.980		o	GWB3475	
	1996.02-2006.05	Platform/Chassis Engine OM602.980	•		GWB3434	
	1996.02-2006.05	Platform/Chassis Engine OM602.980	•		GWB6686	
	1996.02-2006.05	Platform/Chassis Engine OM602.980		o	GWB3435	
	1996.02-2006.05	Platform/Chassis Engine OM602.980		o	GWB3475	
410 D 4x4 (75 kW)	1997.05-2006.05	Box Engine OM602.980	•		GWB3417	
	1997.05-2006.05	Box Engine OM602.980		o	GWB3435	
	1997.05-2006.05	Box Engine OM602.980		o	GWB3475	
	1997.05-2006.05	Platform/Chassis Engine OM602.980	•		GWB3417	
	1997.05-2006.05	Platform/Chassis Engine OM602.980		o	GWB3435	
	1997.05-2006.05	Platform/Chassis Engine OM602.980		o	GWB3475	
411 CDi (80 kW)	2000.04-2006.05	Box Engine OM611.981	•		GWB3434	
	2000.04-2006.05	Box Engine OM611.981	•		GWB6686	
	2000.04-2006.05	Box Engine OM611.981		o	GWB3435	
	2000.04-2006.05	Box Engine OM611.981		o	GWB3475	
	2000.04-2006.05	Bus Engine OM611.981	•		GWB3434	
	2000.04-2006.05	Bus Engine OM611.981	•		GWB6686	
	2000.04-2006.05	Bus Engine OM611.981		o	GWB3435	
	2000.04-2006.05	Bus Engine OM611.981		o	GWB3475	
	2000.04-2006.05	Platform/Chassis Engine OM611.981	•		GWB3434	
	2000.04-2006.05	Platform/Chassis Engine OM611.981	•		GWB6686	
	2000.04-2006.05	Platform/Chassis Engine OM611.981		o	GWB3435	
	2000.04-2006.05	Platform/Chassis Engine OM611.981		o	GWB3475	
411 CDi 4x4 (80 kW)	2000.04-2006.05	Box Engine OM611.981	•		GWB3417	
	2000.04-2006.05	Box Engine OM611.981		o	GWB3435	
	2000.04-2006.05	Box Engine OM611.981		o	GWB3475	
	2000.04-2006.05	Platform/Chassis Engine OM611.981	•		GWB3417	
	2000.04-2006.05	Platform/Chassis Engine OM611.981		o	GWB3435	



	 YEAR		F	R	G-AP Ref.	KIT
MERCEDES BENZ						
SPRINTER 4-T (904)						
411 CDI 4x4 (80 kW)	2000.04-2006.05	Platform/Chassis Engine OM611.981		o	GWB3475	
412 D (85 kW)	1996.02-2006.05	Box Engine OM602.980	•		GWB3434	
	1996.02-2006.05	Box Engine OM602.980	•		GWB6686	
	1996.02-2006.05	Box Engine OM602.980		o	GWB3435	
	1996.02-2006.05	Box Engine OM602.980		o	GWB3475	
	1996.02-2006.05	Platform/Chassis Engine OM602.980	•		GWB3434	
	1996.02-2006.05	Platform/Chassis Engine OM602.980	•		GWB6686	
	1996.02-2006.05	Platform/Chassis Engine OM602.980		o	GWB3435	
	1996.02-2006.05	Platform/Chassis Engine OM602.980		o	GWB3475	
412 D (90 kW)	1996.02-2006.05	Box Engine OM602.980	•		GWB3434	
	1996.02-2006.05	Box Engine OM602.980	•		GWB6686	
	1996.02-2006.05	Box Engine OM602.980		o	GWB3435	
	1996.02-2006.05	Box Engine OM602.980		o	GWB3475	
	1996.02-2006.05	Platform/Chassis Engine OM602.980	•		GWB3434	
	1996.02-2006.05	Platform/Chassis Engine OM602.980	•		GWB6686	
	1996.02-2006.05	Platform/Chassis Engine OM602.980		o	GWB3435	
	1996.02-2006.05	Platform/Chassis Engine OM602.980		o	GWB3475	
412 D 4x4 (85 kW)	1997.05-2006.05	Box Engine OM602.980	•		GWB3417	
	1997.05-2006.05	Box Engine OM602.980		o	GWB3435	
	1997.05-2006.05	Box Engine OM602.980		o	GWB3475	
	1997.05-2006.05	Platform/Chassis Engine OM602.980	•		GWB3417	
	1997.05-2006.05	Platform/Chassis Engine OM602.980		o	GWB3435	
	1997.05-2006.05	Platform/Chassis Engine OM602.980		o	GWB3475	
412 D 4x4 (90 kW)	1997.05-2006.05	Box Engine OM602.980	•		GWB3417	
	1997.05-2006.05	Box Engine OM602.980		o	GWB3435	
	1997.05-2006.05	Box Engine OM602.980		o	GWB3475	
	1997.05-2006.05	Platform/Chassis Engine OM602.980	•		GWB3417	
	1997.05-2006.05	Platform/Chassis Engine OM602.980		o	GWB3435	
	1997.05-2006.05	Platform/Chassis Engine OM602.980		o	GWB3475	
413 CDI (95 kW)	2000.04-2006.05	Box Engine OM611.981	•		GWB3434	
	2000.04-2006.05	Box Engine OM611.981	•		GWB6686	
	2000.04-2006.05	Box Engine OM611.981		o	GWB3435	
	2000.04-2006.05	Box Engine OM611.981		o	GWB3475	
	2000.04-2006.05	Bus Engine OM611.981	•		GWB3434	
	2000.04-2006.05	Bus Engine OM611.981	•		GWB6686	
	2000.04-2006.05	Bus Engine OM611.981		o	GWB3435	
	2000.04-2006.05	Bus Engine OM611.981		o	GWB3475	
	2000.04-2006.05	Platform/Chassis Engine OM611.981	•		GWB3434	
	2000.04-2006.05	Platform/Chassis Engine OM611.981	•		GWB6686	
	2000.04-2006.05	Platform/Chassis Engine OM611.981		o	GWB3435	
	2000.04-2006.05	Platform/Chassis Engine OM611.981		o	GWB3475	
413 CDI 4x4 (95 kW)	2000.04-2006.05	Box Engine OM611.981	•		GWB3417	
	2000.04-2006.05	Box Engine OM611.981		o	GWB3435	
	2000.04-2006.05	Box Engine OM611.981		o	GWB3475	
	2000.04-2006.05	Platform/Chassis Engine OM611.981	•		GWB3417	
	2000.04-2006.05	Platform/Chassis Engine OM611.981		o	GWB3435	
	2000.04-2006.05	Platform/Chassis Engine OM611.981		o	GWB3475	
414 (105 kW)	1996.02-2006.05	Box Engine M111.979	•		GWB3434	
	1996.02-2006.05	Box Engine M111.979	•		GWB6686	
	1996.02-2006.05	Box Engine M111.979		o	GWB3435	
	1996.02-2006.05	Box Engine M111.979		o	GWB3475	
	1996.02-2006.05	Bus Engine M111.979	•		GWB3434	
	1996.02-2006.05	Bus Engine M111.979	•		GWB6686	
	1996.02-2006.05	Bus Engine M111.979		o	GWB3435	
	1996.02-2006.05	Bus Engine M111.979		o	GWB3475	
	1996.02-2006.05	Platform/Chassis Engine M111.979	•		GWB3434	
	1996.02-2006.05	Platform/Chassis Engine M111.979	•		GWB6686	
	1996.02-2006.05	Platform/Chassis Engine M111.979		o	GWB3435	
	1996.02-2006.05	Platform/Chassis Engine M111.979		o	GWB3475	
414 4x4 (105 kW)	1997.05-2006.05	Box Engine M111.979	•		GWB3417	
	1997.05-2006.05	Box Engine M111.979		o	GWB3435	
	1997.05-2006.05	Box Engine M111.979		o	GWB3475	
	1997.05-2006.05	Platform/Chassis Engine M111.979	•		GWB3417	
	1997.05-2006.05	Platform/Chassis Engine M111.979		o	GWB3435	



	 YEAR		F	R	G-AP Ref.	KIT
MERCEDES BENZ						
SPRINTER 4-T (904)						
414 4x4 (105 kW)	1997.05-2006.05	Platform/Chassis Engine M111.979		o	GWB3475	
416 CDI (115 kW)	2000.04-2006.05	Box Engine OM612.981	•		GWB3434	
	2000.04-2006.05	Box Engine OM612.981	•		GWB6686	
	2000.04-2006.05	Box Engine OM612.981		o	GWB3435	
	2000.04-2006.05	Box Engine OM612.981		o	GWB3475	
	2000.04-2006.05	Bus Engine OM612.981	•		GWB3434	
	2000.04-2006.05	Bus Engine OM612.981	•		GWB6686	
	2000.04-2006.05	Bus Engine OM612.981		o	GWB3435	
	2000.04-2006.05	Bus Engine OM612.981		o	GWB3475	
	2000.04-2006.05	Platform/Chassis Engine OM612.981	•		GWB3434	
	2000.04-2006.05	Platform/Chassis Engine OM612.981	•		GWB6686	
	2000.04-2006.05	Platform/Chassis Engine OM612.981		o	GWB3435	
	2000.04-2006.05	Platform/Chassis Engine OM612.981		o	GWB3475	
416 CDI 4x4 (115 kW)	2000.04-2006.05	Box Engine OM612.981	•		GWB3417	
	2000.04-2006.05	Box Engine OM612.981		o	GWB3435	
	2000.04-2006.05	Box Engine OM612.981		o	GWB3475	
	2000.04-2006.05	Platform/Chassis Engine OM612.981	•		GWB3417	
	2000.04-2006.05	Platform/Chassis Engine OM612.981		o	GWB3435	
	2000.04-2006.05	Platform/Chassis Engine OM612.981		o	GWB3475	
SPRINTER 5-T (906)						
509 CDI (65 kW)	2006.06-	Box Engine OM646.984	•		GHA400353	K
	2006.06-	Box Engine OM646.984	•		GHA400354	K
	2006.06-	Box Engine OM646.984		o	GHA329013	
	2006.06-	Box Engine OM646.984		o	GWB6700	
	2006.06-	Platform/Chassis Engine OM646.984	•		GHA400353	K
	2006.06-	Platform/Chassis Engine OM646.984	•		GHA400354	K
	2006.06-	Platform/Chassis Engine OM646.984		o	GHA329013	
	2006.06-	Platform/Chassis Engine OM646.984		o	GWB6700	
510 CDI (70 kW)	2009.03-	Box Engine OM651.955	•		GHA400353	K
	2009.03-	Box Engine OM651.955	•		GHA400354	K
	2009.03-	Box Engine OM651.955		o	GWB6700	
	2009.03-	Platform/Chassis Engine OM651.955	•		GHA400353	K
	2009.03-	Platform/Chassis Engine OM651.955	•		GHA400354	K
	2009.03-	Platform/Chassis Engine OM651.955		o	GWB6700	
511 CDI (80 kW)	2006.06-	Box Engine OM646.985	•		GHA400353	K
	2006.06-	Box Engine OM646.985	•		GHA400354	K
	2006.06-	Box Engine OM646.985		o	GHA329013	
	2006.06-	Box Engine OM646.985		o	GWB6700	
	2006.06-	Platform/Chassis Engine OM646.985	•		GHA400353	K
	2006.06-	Platform/Chassis Engine OM646.985	•		GHA400354	K
	2006.06-	Platform/Chassis Engine OM646.985		o	GHA329013	
	2006.06-	Platform/Chassis Engine OM646.985		o	GWB6700	
511 CDI 4x4 (80 kW)	2006.06-	Box Engine OM646.985		o	GWB6700	
	2006.06-	Platform/Chassis Engine OM646.985		o	GWB6700	
513 CDI (95 kW)	2006.06-	Box Engine OM646.986	•		GHA400353	K
	2006.06-	Box Engine OM646.986	•		GHA400354	K
	2006.06-	Box Engine OM646.986		o	GWB6700	
	2006.06-	Box Engine OM651.956		o	GWB6700	
	2006.06-	Platform/Chassis Engine OM646.986	•		GHA400353	K
	2006.06-	Platform/Chassis Engine OM646.986	•		GHA400354	K
	2006.06-	Platform/Chassis Engine OM646.986		o	GWB6700	
	2006.06-	Platform/Chassis Engine OM651.956		o	GWB6700	
513 CDI 4x4 (95 kW)	2006.06-	Box Engine OM651.956		o	GWB6700	
	2011.05-	Platform/Chassis Engine OM651.955/OM651.956		o	GWB6700	
515 CDI (110 kW)	2006.06-	Box Engine OM646.989/OM646.990	•		GHA400353	K
	2006.06-	Box Engine OM646.989/OM646.990	•		GHA400354	K
	2006.06-	Box Engine OM646.989/OM646.990		o	GHA329013	
	2006.06-	Box Engine OM646.989/OM646.990		o	GWB6700	
	2006.06-	Platform/Chassis Engine OM646.990/OM646.989	•		GHA400353	K
	2006.06-	Platform/Chassis Engine OM646.990/OM646.989	•		GHA400354	K
	2006.06-	Platform/Chassis Engine OM646.990/OM646.989		o	GHA329013	
	2006.06-	Platform/Chassis Engine OM646.990/OM646.989		o	GWB6700	
515 CDI 4x4 (110 kW)	2006.06-	Box Engine OM646.990/OM646.989		o	GWB6700	
	2006.06-	Platform/Chassis Engine OM646.990/OM646.989		o	GWB6700	



	 YEAR		F	R	G-AP Ref.	KIT
MERCEDES BENZ						
SPRINTER 5-T (906)						
516 (115 kW)	2008.09-	Platform/Chassis Engine M271.951	•		GHA400353	K
	2008.09-	Platform/Chassis Engine M271.951	•		GHA400354	K
	2008.09-	Platform/Chassis Engine M271.951		○	GWB6700	
516 CDI (120 kW)	2009.03-	Box Engine OM651.957	•		GHA400353	K
	2009.03-	Box Engine OM651.957	•		GHA400354	K
	2009.03-	Box Engine OM651.957		○	GWB6700	
	2009.03-	Platform/Chassis Engine OM651.957	•		GHA400353	K
	2009.03-	Platform/Chassis Engine OM651.957	•		GHA400354	K
	2009.03-	Platform/Chassis Engine OM651.957		○	GWB6700	
516 CDI 4x4 (120 kW)	2006.06-	Box Engine OM651.957		○	GWB6700	
	2011.05-	Platform/Chassis Engine OM651.957		○	GWB6700	
516 NGT (115 kW)	2008.09-	Platform/Chassis Engine M271.951	•		GHA400353	K
	2008.09-	Platform/Chassis Engine M271.951	•		GHA400354	K
	2008.09-	Platform/Chassis Engine M271.951		○	GWB6700	
	2008.09-	Platform/Chassis Engine M271.951		○	GWB6700	
518 CDI (135 kW)	2006.06-	Box Engine OM642.992/OM642.993/OM642.896	•		GHA400353	K
	2006.06-	Box Engine OM642.992/OM642.993/OM642.896	•		GHA400354	K
	2006.06-	Box Engine OM642.992/OM642.993/OM642.896		○	GHA329013	
	2006.06-	Box Engine OM642.992/OM642.993/OM642.896		○	GWB6700	
	2006.06-	Platform/Chassis Engine OM642.992/OM642.993/OM642.896	•		GHA400353	K
	2006.06-	Platform/Chassis Engine OM642.992/OM642.993/OM642.896	•		GHA400354	K
	2006.06-	Platform/Chassis Engine OM642.992/OM642.993/OM642.896		○	GHA329013	
	2006.06-	Platform/Chassis Engine OM642.992/OM642.993/OM642.896		○	GWB6700	
518 CDI 4x4 (135 kW)	2006.06-	Box Engine OM642.992/OM642.993/OM642.896		○	GWB6700	
	2006.06-	Platform/Chassis Engine OM642.896/OM642.992/OM642.993		○	GWB6700	
519 CDI/BlueTEC (140 kW)	2009.03-	Box Engine OM642.896/OM642.898/OM642.992	•		GHA400353	K
	2009.03-	Box Engine OM642.896/OM642.898/OM642.992	•		GHA400354	K
	2009.03-	Box Engine OM642.896/OM642.898/OM642.992		○	GWB6700	
	2009.03-	Platform/Chassis Engine OM642.896/OM642.898/OM642.992	•		GHA400353	K
	2009.03-	Platform/Chassis Engine OM642.896/OM642.898/OM642.992	•		GHA400354	K
	2009.03-	Platform/Chassis Engine OM642.896/OM642.898/OM642.992		○	GWB6700	
519 CDI/BlueTEC 4x4 (140 kW)	2009.03-	Box Engine OM642.896/OM642.898/OM642.992		○	GWB6700	
	2009.03-	Platform/Chassis Engine OM642.992/OM642.898/OM642.896		○	GWB6700	
524 (190 kW)	2006.06-	Box Engine M272.979	•		GHA400353	K
	2006.06-	Box Engine M272.979	•		GHA400354	K
	2006.06-	Box Engine M272.979		○	GHA329008	K
	2006.06-	Box Engine M272.979		○	GHA329013	
	2006.06-	Box Engine M272.979		○	GWB6700	
	2006.06-	Platform/Chassis Engine M272.979	•		GHA400353	K
	2006.06-	Platform/Chassis Engine M272.979	•		GHA400354	K
	2006.06-	Platform/Chassis Engine M272.979		○	GWB6700	
SPRINTER CLASSIC 3,5-T (909)						
311 CDI (80 kW)	2013.09-		•		GWB3434	
	2013.09-		•		GWB6686	
	2013.09-			○	GWB3435	
SPRINTER CLASSIC 4,6-T (909)						
411 CDI (80 kW)	2013.09-		•		GWB3434	
	2013.09-		•		GWB6686	
	2013.09-			○	GWB3435	
T1 (602)						
308 D 2.3 (58 kW)	1990.05-1996.02	Bus Engine OM601.940	•		GWB0596	
	1990.05-1996.02	Bus Engine OM601.940	•		GWB3434	
	1990.05-1996.02	Bus Engine OM601.940		○	GWB1470	
310 D 2.9 (72 kW)	1990.06-1996.02	Bus Engine OM602.940	•		GWB0596	
	1990.06-1996.02	Bus Engine OM602.940	•		GWB3434	
	1990.06-1996.02	Bus Engine OM602.940		○	GWB1470	
VANEO (414)						
1.6 (60 kW)	2002.02-2005.07	MPV Engine M166.961	•		GHA424010	
	2002.02-2005.07	MPV Engine M166.961	•		GWB3520	
1.6 (75 kW)	2002.02-2005.07	MPV Engine M166.961	•		GHA424010	
	2002.02-2005.07	MPV Engine M166.961	•		GWB3520	
1.7 CDI (55 kW)	2002.02-2005.07	MPV Engine OM668.914	•		GHA424010	
	2002.02-2005.07	MPV Engine OM668.914	•		GWB3520	



	 YEAR		F	R	G-AP Ref.	KIT
MERCEDES BENZ						
VANEO (414)						
1.7 CDi (67 kW)	2002.02-2005.07	MPV Engine OM668.914	•		GHA424010	
	2002.02-2005.07	MPV Engine OM668.914	•		GWB3520	
1.9 (92 kW)	2002.02-2005.07	MPV Engine M166.991	•		GHA424010	
	2002.02-2005.07	MPV Engine M166.991	•		GWB3520	
V-CLASS (638/2)						
V 200 (95 kW)	1997.02-2003.07	MPV Engine M111.948/M111.950	•		GHA427019	
	1997.02-2003.07	MPV Engine M111.948/M111.950	•		GWB3486	
V 200 CDi (75 kW)	1999.03-2003.07	MPV Engine OM611.980	•		GHA427019	
	1999.03-2003.07	MPV Engine OM611.980	•		GWB3486	
V 220 CDi (90 kW)	1999.03-2003.07	MPV Engine OM611.980	•		GHA427019	
	1999.03-2003.07	MPV Engine OM611.980	•		GWB3486	
V 230 (105 kW)	1996.10-2003.07	MPV Engine M111.978	•		GHA427019	
	1996.10-2003.07	MPV Engine M111.978	•		GWB3486	
V 230 TD (72 kW)	1996.09-2003.07	MPV Engine OM601.970	•		GHA427019	
	1996.09-2003.07	MPV Engine OM601.970	•		GWB3486	
V 280 (128 kW)	1997.08-2003.07	MPV Engine M104.900	•		GHA427019	
	1997.08-2003.07	MPV Engine M104.900	•		GWB3486	
VIANO (W639)						
2.0 CDi (80 kW)	2004.01-	MPV Engine OM646.982	•		GHA400051	K
2.0 CDi (85 kW)	2005.08-	MPV Engine OM646.982	•		GHA400051	K
2.2 CDi (110 kW)	2004.01-	MPV Engine OM646.982	•		GHA400051	K
3.0 (140 kW)	2003.09-	MPV Engine M112.951	•		GHA400051	K
3.0 CDi (150 kW)	2006.04-	MPV Engine OM642.990	•		GHA400051	K
3.2 (160 kW)	2004.01-2004.10	MPV Engine M112.951	•		GHA400051	K
3.5 (190 kW)	2007.09-	MPV Engine M272.978	•		GHA400051	K
3.7 (170 kW)	2004.10-	MPV Engine M112.976	•		GHA400051	K
CDi 2.0 (100 kW)	2010.07-	MPV Engine OM 651.940	•		GHA400051	K
CDi 2.2 (120 kW)	2010.07-	MPV Engine OM 651.940	•		GHA400051	K
CDi 3.0 (165 kW)	2010.07-	MPV Engine OM 642.990	•		GHA400051	K
VITO (638)						
2.0 (95 kW)	1996.02-2003.07	Bus Engine M111.948/M111.950	•		GHA427019	
	1996.02-2003.07	Bus Engine M111.948/M111.950	•		GWB3486	
	1997.03-2003.07	Box Engine M111.948/M111.950	•		GHA427019	
	1997.03-2003.07	Box Engine M111.948/M111.950	•		GWB3486	
2.2 CDi (60 kW)	1999.03-2003.07	Box Engine OM611A	•		GHA427019	
	1999.03-2003.07	Box Engine OM611A	•		GWB3486	
	1999.03-2003.07	Bus Engine OM611A	•		GHA427019	
	1999.03-2003.07	Bus Engine OM611A	•		GWB3486	
2.2 CDi (75 kW)	1999.03-2003.07	Box Engine OM611LA(75KWCDI)	•		GHA427019	
	1999.03-2003.07	Box Engine OM611LA(75KWCDI)	•		GWB3486	
	1999.03-2003.07	Bus Engine OM611LA(75KWCDI)	•		GHA427019	
	1999.03-2003.07	Bus Engine OM611LA(75KWCDI)	•		GWB3486	
2.2 CDi (90 kW)	1999.03-2003.07	Box Engine OM611.980	•		GHA427019	
	1999.03-2003.07	Box Engine OM611.980	•		GWB3486	
	1999.03-2003.07	Bus Engine OM611.980	•		GHA427019	
	1999.03-2003.07	Bus Engine OM611.980	•		GWB3486	
2.3 (105 kW)	1996.12-2003.07	Bus Engine M111.978	•		GHA427019	
	1996.12-2003.07	Bus Engine M111.978	•		GWB3486	
	1997.03-2003.07	Box Engine M111.978	•		GHA427019	
	1997.03-2003.07	Box Engine M111.978	•		GWB3486	
2.3 D (58 kW)	1996.02-2003.07	Bus Engine OM601.942	•		GHA427019	
	1996.02-2003.07	Bus Engine OM601.942	•		GWB3486	
	1997.03-2003.07	Box Engine OM601.942	•		GHA427019	
	1997.03-2003.07	Box Engine OM601.942	•		GWB3486	
2.3 D (72 kW)	1997.03-2003.07	Box Engine OM601.970	•		GHA427019	
	1997.03-2003.07	Box Engine OM601.970	•		GWB3486	
2.3 TD (72 kW)	1996.02-2003.07	Bus Engine OM601.970	•		GHA427019	
	1996.02-2003.07	Bus Engine OM601.970	•		GWB3486	
VITO (W639)						
2.1 CDi (100 kW)	2010.09-	Bus Engine OM651.940	•		GHA400051	K
2.1 CDi (120 kW)	2010.09-	Bus Engine OM651.940	•		GHA400051	K
2.1 CDi (70 kW)	2010.09-	Bus Engine OM651.940	•		GHA400051	K
2.2 CDi (110 kW)	2003.09-	Bus Engine OM646.982	•		GHA400051	K



	 YEAR		F	R	G-AP Ref.	KIT
MERCEDES BENZ						
VITO (W639)						
2.2 CDi (65 kW)	2003.09-	Bus Engine OM646.983	•		GHA400051	K
2.2 CDi (70 kW)	2006.09-	Bus Engine OM646.980	•		GHA400051	K
2.2 CDi (80 kW)	2003.09-	Bus Engine OM646.982	•		GHA400051	K
2.2 CDi (85 kW)	2007.09-	Bus Engine OM646.980/OM646.982	•		GHA400051	K
3.0 CDi (150 kW)	2006.07-	Bus Engine OM642.990	•		GHA400051	K
3.0 CDi (165 kW)	2010.09-	Bus Engine OM642.890	•		GHA400051	K
3.2 (140 kW)	2003.09-	Bus Engine M112.951	•		GHA400051	K
3.2 (160 kW)	2003.09-	Bus Engine M112.951	•		GHA400051	K
3.5 (190 kW)	2007.09-	Bus Engine M272.978	•		GHA400051	K
3.7 (170 kW)	2004.06-	Bus Engine M112.976	•		GHA400051	K
VITO / MIXTO (W639)						
123 (165 kW)	2004.06-2008.07	Box Engine M 112.976	•		GHA400051	K
2.1 CDi (100 kW)	2010.09-	Box Engine OM651.940	•		GHA400051	K
2.1 CDi (120 kW)	2010.09-	Box Engine OM651.940	•		GHA400051	K
2.1 CDi (70 kW)	2010.09-	Box Engine OM651.940	•		GHA400051	K
2.2 CDi (110 kW)	2003.09-	Box Engine OM646.982	•		GHA400051	K
2.2 CDi (65 kW)	2003.09-	Box Engine OM646.983	•		GHA400051	K
2.2 CDi (70 kW)	2006.08-	Box Engine OM646.981	•		GHA400051	K
2.2 CDi (80 kW)	2003.09-	Box Engine OM646.982	•		GHA400051	K
2.2 CDi (85 kW)	2007.09-	Box Engine OM646.982	•		GHA400051	K
3.0 CDi (150 kW)	2006.07-	Box Engine OM642.990	•		GHA400051	K
3.0 CDi (165 kW)	2010.09-	Box Engine OM642.890	•		GHA400051	K
3.2 (140 kW)	2003.09-	Box Engine M112.951	•		GHA400051	K
3.2 (160 kW)	2003.09-	Box Engine M112.951	•		GHA400051	K
3.5 (190 kW)	2007.09-	Box Engine M272.978	•		GHA400051	K
3.7 (170 kW)	2004.06-2008.07	Box Engine M112.976	•		GHA400051	K



	 YEAR		F	R	G-AP Ref.	KIT
MERCURY						
GRAND MARQUIS						
-	2002-1997	With ABS	•		GHA237006	
MOUNTAINEER						
-	2002-2010			○	GHA429001	K
-	2006-2010		•		GHA327037	
MG						
MG ZR						
1.4 (76 kW)	2001.06-2005.04	Hatchback Engine 14K4F	•		GWB1374	
	2001.06-2005.04	Hatchback Engine 14K4F		○	GHA230117	K
1.8 (118 kW)	2001.06-2005.04	Hatchback Engine 18K4K	•		GWB1374	
	2001.06-2005.04	Hatchback Engine 18K4K		○	GHA230117	K
	2001.06-2005.04	Hatchback Engine 18K4K		○	GHA230151	K
1.8 (86 kW)	2001.06-2005.04	Hatchback Engine 18K4F	•		GWB1374	
	2001.06-2005.04	Hatchback Engine 18K4F		○	GHA230117	K
	2001.06-2005.04	Hatchback Engine 18K4F		○	GHA230151	K
2.0 TD (74 kW)	2001.06-2005.04	Hatchback Engine 20T2N	•		GWB1374	
	2001.06-2005.04	Hatchback Engine 20T2N		○	GHA230117	K
2.0 TD (83 kW)	2002.12-2005.04	Hatchback Engine 20T2N	•		GWB1374	
	2002.12-2005.04	Hatchback Engine 20T2N		○	GHA230117	K
	2002.12-2005.04	Hatchback Engine 20T2N		○	GHA230151	K
MG ZS						
1.6 (79 kW)	2003.07-2005.04	Saloon Engine 16K4F		○	GHA230117	K
	2003.07-2005.04	Saloon Engine 16K4F		○	GHA230151	K
1.6 (82 kW)	2001.11-2005.10	Hatchback Engine 16K4F		○	GHA230117	K
	2001.11-2005.10	Hatchback Engine 16K4F		○	GHA230151	K
1.8 (86 kW)	2001.07-2005.04	Saloon Engine 18K4F		○	GHA230117	K
	2001.07-2005.04	Saloon Engine 18K4F		○	GHA230151	K
	2001.07-2005.10	Hatchback Engine 18K4F		○	GHA230117	K
	2001.07-2005.10	Hatchback Engine 18K4F		○	GHA230151	K
2.0 TD (74 kW)	2004.01-2005.04	Saloon Engine 20T2N		○	GHA230117	K
	2004.01-2005.04	Saloon Engine 20T2N		○	GHA230151	K
	2004.01-2005.10	Hatchback Engine 20T2N		○	GHA230117	K
	2004.01-2005.10	Hatchback Engine 20T2N		○	GHA230151	K
2.0 TD (83 kW)	2004.01-2005.04	Saloon Engine 20T2N		○	GHA230117	K
	2004.01-2005.04	Saloon Engine 20T2N		○	GHA230151	K
	2004.01-2005.10	Hatchback Engine 20T2N		○	GHA230117	K
	2004.01-2005.10	Hatchback Engine 20T2N		○	GHA230151	K
2.5 (130 kW)	2001.07-2005.04	Saloon Engine 25K4F		○	GHA230117	K
	2001.07-2005.04	Saloon Engine 25K4F		○	GHA230151	K
	2001.07-2005.10	Hatchback Engine 25K4F		○	GHA230117	K
	2001.07-2005.10	Hatchback Engine 25K4F		○	GHA230151	K
MG ZT						
1.8 16V (88 kW)	2003.01-2005.07	Saloon Engine 18K4F	•		GWB3603	
	2003.01-2005.07	Saloon Engine 18K4F		○	GHA232023	
1.8 T 16V (118 kW)	2003.01-2005.07	Saloon Engine 18K4G	•		GWB3603	
	2003.01-2005.07	Saloon Engine 18K4G		○	GHA232023	
2.0 CDTi (85 kW)	2002.06-2003.09	Saloon Engine 204D2	•		GWB3603	
	2002.06-2003.09	Saloon Engine 204D2		○	GHA232023	
2.0 CDTi (96 kW)	2002.11-2005.07	Saloon Engine 204D2	•		GWB3603	
	2002.11-2005.07	Saloon Engine 204D2		○	GHA232023	
2.5 (118 kW)	2001.06-2005.07	Saloon Engine 25K4F	•		GWB3603	
	2001.06-2005.07	Saloon Engine 25K4F		○	GHA232023	
2.5 (130 kW)	2003.01-2005.07	Saloon Engine 25K4F	•		GWB3603	
	2003.01-2005.07	Saloon Engine 25K4F		○	GHA232023	
2.5 (140 kW)	2001.06-2005.07	Saloon Engine 25K4F	•		GWB3603	
	2001.06-2005.07	Saloon Engine 25K4F		○	GHA232023	
MG ZT- T						
1.8 16V (88 kW)	2003.01-2005.07	Estate Engine 18K4F	•		GWB3603	
	2003.01-2005.07	Estate Engine 18K4F		○	GHA232023	
1.8 T 16V (118 kW)	2003.01-2005.07	Estate Engine 18K4G	•		GWB3603	
	2003.01-2005.07	Estate Engine 18K4G		○	GHA232023	
2.0 CDTi (85 kW)	2002.06-2003.09	Estate Engine 204D2	•		GWB3603	
	2002.06-2003.09	Estate Engine 204D2		○	GHA232023	
2.0 CDTi (96 kW)	2002.11-2005.07	Estate Engine 204D2	•		GWB3603	



	 YEAR		F	R	G-AP Ref.	KIT
MG						
MG ZT- T						
2.0 CDTi (96 kW)	2002.11-2005.07	Estate Engine 204D2		o	GHA232023	
2.5 (118 kW)	2001.10-2005.07	Estate Engine 25K4F	•		GWB3603	
	2001.10-2005.07	Estate Engine 25K4F		o	GHA232023	
2.5 (130 kW)	2003.01-2005.07	Estate Engine 25K4F	•		GWB3603	
	2003.01-2005.07	Estate Engine 25K4F		o	GHA232023	
2.5 (140 kW)	2001.10-2005.07	Estate Engine 25K4F	•		GWB3603	
	2001.10-2005.07	Estate Engine 25K4F		o	GHA232023	
MINI						
MINI (R50, R53)						
1.4 (55 kW)	2003.04-2006.09	Hatchback M12x1.5	•		GHA326026	K
	2003.04-2006.09	Hatchback M12x1.5		o	GHA400154	K
	2003.04-2006.09	Hatchback M14x1.25	•		GHA326031	K
	2003.04-2006.09	Hatchback M14x1.25		o	GHA400134	F
1.4 One D (55 kW)	2003.06-2006.09	Hatchback Engine 1ND M12x1.5	•		GHA326026	K
	2003.06-2006.09	Hatchback Engine 1ND M12x1.5		o	GHA400154	K
	2003.06-2006.09	Hatchback Engine 1ND M14x1.25	•		GHA326031	K
	2003.06-2006.09	Hatchback Engine 1ND M14x1.25		o	GHA400134	F
1.4 One D (65 kW)	2003.06-2006.09	Hatchback Engine 1ND-TV M12x1.5	•		GHA326026	K
	2003.06-2006.09	Hatchback Engine 1ND-TV M12x1.5		o	GHA400154	K
	2003.06-2006.09	Hatchback Engine 1ND-TV M14x1.25	•		GHA326031	K
	2003.06-2006.09	Hatchback Engine 1ND-TV M14x1.25		o	GHA400134	F
1.6 (147 kW)	2003.11-2005.06	Hatchback Engine W11B16A M12x1.5	•		GHA326026	K
	2003.11-2005.06	Hatchback Engine W11B16A M12x1.5		o	GHA400154	K
1.6 Cooper (85 kW)	2001.06-2006.09	Hatchback Engine W10B16A M12x1.5	•		GHA326026	K
	2001.06-2006.09	Hatchback Engine W10B16A M12x1.5		o	GHA400154	K
	2001.06-2006.09	Hatchback Engine W10B16A M14x1.25	•		GHA326031	K
	2001.06-2006.09	Hatchback Engine W10B16A M14x1.25		o	GHA400134	F
1.6 Cooper S (120 kW)	2002.03-2006.09	Hatchback Engine W11B16A M12x1.5	•		GHA326026	K
	2002.03-2006.09	Hatchback Engine W11B16A M12x1.5		o	GHA400154	K
	2002.03-2006.09	Hatchback Engine W11B16A M14x1.25	•		GHA326031	K
	2002.03-2006.09	Hatchback Engine W11B16A M14x1.25		o	GHA400134	F
1.6 Cooper S (125 kW)	2004.07-2006.09	Hatchback Engine W11B16A M12x1.5	•		GHA326026	K
	2004.07-2006.09	Hatchback Engine W11B16A M12x1.5		o	GHA400154	K
	2004.07-2006.09	Hatchback Engine W11B16A M14x1.25	•		GHA326031	K
	2004.07-2006.09	Hatchback Engine W11B16A M14x1.25		o	GHA400134	F
1.6 John Cooper Works (160 kW)	2006.03-2006.09	Hatchback Engine W11B16A M12x1.5	•		GHA326026	K
	2006.03-2006.09	Hatchback Engine W11B16A M12x1.5		o	GHA400154	K
	2006.03-2006.09	Hatchback Engine W11B16A M14x1.25	•		GHA326031	K
	2006.03-2006.09	Hatchback Engine W11B16A M14x1.25		o	GHA400134	F
1.6 One (66 kW)	2001.06-2006.09	Hatchback Engine W10B16A M12x1.5	•		GHA326026	K
	2001.06-2006.09	Hatchback Engine W10B16A M12x1.5		o	GHA400154	K
	2001.06-2006.09	Hatchback Engine W10B16A M14x1.25	•		GHA326031	K
	2001.06-2006.09	Hatchback Engine W10B16A M14x1.25		o	GHA400134	F
1.6 Works (155 kW)	2003.11-2006.09	Hatchback Engine W11B16A M12x1.5	•		GHA326026	K
	2003.11-2006.09	Hatchback Engine W11B16A M12x1.5		o	GHA400154	K
	2003.11-2006.09	Hatchback Engine W11B16A M14x1.25	•		GHA326031	K
	2003.11-2006.09	Hatchback Engine W11B16A M14x1.25		o	GHA400134	F
MINI (R52)						
1.6 Cooper (85 kW)	2004.07-2007.11	Convertible Engine W10B16A M12x1.5	•		GHA326026	K
	2004.07-2007.11	Convertible Engine W10B16A M12x1.5		o	GHA400154	K
	2004.07-2007.11	Convertible Engine W10B16A M14x1.25	•		GHA326031	K
	2004.07-2007.11	Convertible Engine W10B16A M14x1.25		o	GHA400134	F
1.6 Cooper S (120 kW)	2004.07-2007.11	Convertible Engine W11B16A M12x1.5	•		GHA326026	K
	2004.07-2007.11	Convertible Engine W11B16A M12x1.5		o	GHA400154	K
	2004.07-2007.11	Convertible Engine W11B16A M14x1.25	•		GHA326031	K
	2004.07-2007.11	Convertible Engine W11B16A M14x1.25		o	GHA400134	F
1.6 Cooper S (125 kW)	2004.07-2007.11	Convertible Engine W11B16A M12x1.5	•		GHA326026	K
	2004.07-2007.11	Convertible Engine W11B16A M12x1.5		o	GHA400154	K
	2004.07-2007.11	Convertible Engine W11B16A M14x1.25	•		GHA326031	K
	2004.07-2007.11	Convertible Engine W11B16A M14x1.25		o	GHA400134	F
1.6 John Cooper Works (155 kW)	2004.07-2007.11	Convertible Engine W11B16A M12x1.5	•		GHA326026	K
	2004.07-2007.11	Convertible Engine W11B16A M12x1.5		o	GHA400154	K
	2004.07-2007.11	Convertible Engine W11B16A M14x1.25	•		GHA326031	K



	 YEAR		F	R	G-AP Ref.	KIT
MINI						
MINI (R52)						
1.6 John Cooper Works (155 kW)	2004.07-2007.11	Convertible Engine W11B16A M14×1.25		○	GHA400134	F
1.6 One (66 kW)	2004.07-2007.11	Convertible Engine W10B16A M12×1.5	●		GHA326026	K
	2004.07-2007.11	Convertible Engine W10B16A M12×1.5		○	GHA400154	K
	2004.07-2007.11	Convertible Engine W10B16A M14×1.25	●		GHA326031	K
	2004.07-2007.11	Convertible Engine W10B16A M14×1.25		○	GHA400134	F
MINI (R56)						
1.4 One (55 kW)	2009.03-	Hatchback Engine N12B14A M14×1.25	●		GHA326031	K
	2009.03-	Hatchback Engine N12B14A M14×1.25		○	GHA400134	K
1.4 One (70 kW)	2007.03-	Hatchback Engine N12B14A M14×1.25	●		GHA326031	K
	2007.03-	Hatchback Engine N12B14A M14×1.25		○	GHA400134	K
1.6 Cooper (85 kW)	2010.03-	Hatchback Engine N12B16A/N16B16A M14×1.25	●		GHA326031	K
	2010.03-	Hatchback Engine N12B16A/N16B16A M14×1.25		○	GHA400134	K
1.6 Cooper (88 kW)	2006.10-	Hatchback Engine N12B16A M14×1.25	●		GHA326031	K
	2006.10-	Hatchback Engine N12B16A M14×1.25		○	GHA400134	K
1.6 Cooper (90 kW)	2010.03-	Hatchback Engine N16B16A M14×1.25	●		GHA326031	K
	2010.03-	Hatchback Engine N16B16A M14×1.25		○	GHA400134	K
1.6 Cooper D (80 kW)	2007.03-	Hatchback Engine 9HZ(DV6TED4) M14×1.25	●		GHA326031	K
	2007.03-	Hatchback Engine 9HZ(DV6TED4) M14×1.25		○	GHA400134	K
1.6 Cooper D (82 kW)	2010.06-	Hatchback Engine N47C16A M14×1.25	●		GHA326031	K
	2010.06-	Hatchback Engine N47C16A M14×1.25		○	GHA400134	K
1.6 Cooper S (120 kW)	2010.03-	Hatchback Engine N18B16A M14×1.25	●		GHA326031	K
	2010.03-	Hatchback Engine N18B16A M14×1.25		○	GHA400134	K
1.6 Cooper S (128 kW)	2006.10-	Hatchback Engine N14B16A M14×1.25	●		GHA326031	K
	2006.10-	Hatchback Engine N14B16A M14×1.25		○	GHA400134	K
1.6 Cooper S (135 kW)	2010.03-	Hatchback Engine N18B16A M14×1.25	●		GHA326031	K
	2010.03-	Hatchback Engine N18B16A M14×1.25		○	GHA400134	K
1.6 Cooper S (147 kW)	2012.01-	Hatchback Engine N18B16A M14×1.25	●		GHA326031	K
	2012.01-	Hatchback Engine N18B16A M14×1.25		○	GHA400134	K
1.6 John Cooper Works (155 kW)	2008.03-	Hatchback Engine N14B16C M14×1.25	●		GHA326031	K
	2008.03-	Hatchback Engine N14B16C M14×1.25		○	GHA400134	K
1.6 John Cooper Works GP (160 kW)	2012.09-	Hatchback Engine N18B16B M14×1.25	●		GHA326031	K
	2012.09-	Hatchback Engine N18B16B M14×1.25		○	GHA400134	K
1.6 One (55 kW)	2010.03-	Hatchback Engine N16B16A M14×1.25	●		GHA326031	K
	2010.03-	Hatchback Engine N16B16A M14×1.25		○	GHA400134	K
1.6 One (72 kW)	2010.03-	Hatchback Engine N16B16A M14×1.25	●		GHA326031	K
	2010.03-	Hatchback Engine N16B16A M14×1.25		○	GHA400134	K
1.6 One D (66 kW)	2009.06-2010.07	Hatchback Engine 9HZ(DV6TED4) M14×1.25	●		GHA326031	K
	2009.06-2010.07	Hatchback Engine 9HZ(DV6TED4) M14×1.25		○	GHA400134	K
	2010.07-	Estate Engine N47C16A M14×1.25	●		GHA326031	K
	2010.07-	Estate Engine N47C16A M14×1.25		○	GHA400134	K
2.0 Cooper D (82 kW)	2011.02-	Hatchback Engine N47C20A M14×1.25	●		GHA326031	K
	2011.02-	Hatchback Engine N47C20A M14×1.25		○	GHA400134	K
2.0 Cooper SD (100 kW)	2011.02-	Hatchback Engine N47C20A M14×1.25	●		GHA326031	K
	2011.02-	Hatchback Engine N47C20A M14×1.25		○	GHA400134	K
2.0 Cooper SD (105 kW)	2011.02-	Hatchback Engine N47C20A M14×1.25	●		GHA326031	K
	2011.02-	Hatchback Engine N47C20A M14×1.25		○	GHA400134	K
MINI (R57)						
1.6 Cooper (85 kW)	2009.03-	Convertible Engine N16B16A M14×1.25	●		GHA326031	K
	2009.03-	Convertible Engine N16B16A M14×1.25		○	GHA400134	K
1.6 Cooper (88 kW)	2009.03-	Convertible Engine N12B16A M14×1.25	●		GHA326031	K
	2009.03-	Convertible Engine N12B16A M14×1.25		○	GHA400134	K
1.6 Cooper (90 kW)	2010.03-	Convertible Engine N16B16A M14×1.25	●		GHA326031	K
	2010.03-	Convertible Engine N16B16A M14×1.25		○	GHA400134	K
1.6 Cooper D (82 kW)	2010.06-	Convertible Engine N47C16A M14×1.25	●		GHA326031	K
	2010.06-	Convertible Engine N47C16A M14×1.25		○	GHA400134	K
1.6 Cooper S (128 kW)	2009.03-	Convertible Engine N14B16A M14×1.25	●		GHA326031	K
	2009.03-	Convertible Engine N14B16A M14×1.25		○	GHA400134	K
1.6 Cooper S (135 kW)	2010.03-	Convertible Engine N18B16A M14×1.25	●		GHA326031	K
	2010.03-	Convertible Engine N18B16A M14×1.25		○	GHA400134	K
1.6 Cooper S (147 kW)	2010.03-	Convertible Engine N18B16A M14×1.25	●		GHA326031	K
	2010.03-	Convertible Engine N18B16A M14×1.25		○	GHA400134	K
1.6 John Cooper Works (155 kW)	2008.03-	Convertible Engine N14B16C M14×1.25	●		GHA326031	K
	2008.03-	Convertible Engine N14B16C M14×1.25		○	GHA400134	K
1.6 One (72 kW)	2010.03-	Convertible Engine N16B16A M14×1.25	●		GHA326031	K



	 YEAR		F	R	G-AP Ref.	KIT
MINI						
MINI (R57)						
1.6 One (72 kW)	2010.03-	Convertible Engine N16B16A M14×1.25		○	GHA400134	K
2.0 Cooper D (82 kW)	2011.02-	Convertible Engine N47C20A M14×1.25	●		GHA326031	K
	2011.02-	Convertible Engine N47C20A M14×1.25		○	GHA400134	K
2.0 Cooper SD (105 kW)	2011.02-	Convertible Engine N47C20A M14×1.25	●		GHA326031	K
	2011.02-	Convertible Engine N47C20A M14×1.25		○	GHA400134	K
MINI (R58)						
1.6 Cooper (85 kW)	2011.09-	Coupe Engine N16B16A M14×1.25	●		GHA326031	K
	2011.09-	Coupe Engine N16B16A M14×1.25		○	GHA400134	K
1.6 Cooper (90 kW)	2011.09-	Coupe Engine N16B16A M14×1.25	●		GHA326031	K
	2011.09-	Coupe Engine N16B16A M14×1.25		○	GHA400134	K
1.6 Cooper S (120 kW)	2011.09-	Coupe Engine N18B16A M14×1.25	●		GHA326031	K
	2011.09-	Coupe Engine N18B16A M14×1.25		○	GHA400134	K
1.6 Cooper S (135 kW)	2011.09-	Coupe Engine N18B16A M14×1.25	●		GHA326031	K
	2011.09-	Coupe Engine N18B16A M14×1.25		○	GHA400134	K
1.6 Cooper S (147 kW)	2011.09-	Coupe Engine N18B16A M14×1.25	●		GHA326031	K
	2011.09-	Coupe Engine N18B16A M14×1.25		○	GHA400134	K
1.6 John Cooper Works (155 kW)	2011.09-	Coupe Engine N14B16C M14×1.25	●		GHA326031	K
	2011.09-	Coupe Engine N14B16C M14×1.25		○	GHA400134	K
2.0 Cooper SD (100 kW)	2011.09-	Coupe Engine N47C20A M14×1.25	●		GHA326031	K
	2011.09-	Coupe Engine N47C20A M14×1.25		○	GHA400134	K
2.0 Cooper SD (105 kW)	2011.09-	Coupe Engine N47C20A M14×1.25	●		GHA326031	K
	2011.09-	Coupe Engine N47C20A M14×1.25		○	GHA400134	K
MINI CLUBMAN (R55)						
1.4 One (70 kW)	2009.03-2010.02	Estate Engine N12B14A M14×1.25	●		GHA326031	K
	2009.03-2010.02	Estate Engine N12B14A M14×1.25		○	GHA400134	K
1.6 Cooper (85 kW)	2010.03-	Estate Engine N16B16A M14×1.25	●		GHA326031	K
	2010.03-	Estate Engine N16B16A M14×1.25		○	GHA400134	K
1.6 Cooper (88 kW)	2007.10-	Estate Engine N12B16A/N16B16A M14×1.25	●		GHA326031	K
	2007.10-	Estate Engine N12B16A/N16B16A M14×1.25		○	GHA400134	K
1.6 Cooper (90 kW)	2010.03-	Estate Engine N16B16A M14×1.25	●		GHA326031	K
	2010.03-	Estate Engine N16B16A M14×1.25		○	GHA400134	K
1.6 Cooper D (80 kW)	2007.10-	Estate Engine 9HZ(DV6TED4) M14×1.25	●		GHA326031	K
	2007.10-	Estate Engine 9HZ(DV6TED4) M14×1.25		○	GHA400134	K
1.6 Cooper D (82 kW)	2010.03-	Estate Engine N47C16A M14×1.25	●		GHA326031	K
	2010.03-	Estate Engine N47C16A M14×1.25		○	GHA400134	K
1.6 Cooper S (120 kW)	2007.10-	Estate Engine N14B16A M14×1.25	●		GHA326031	K
	2007.10-	Estate Engine N14B16A M14×1.25		○	GHA400134	K
1.6 Cooper S (128 kW)	2007.10-	Estate Engine N14B16A M14×1.25	●		GHA326031	K
	2007.10-	Estate Engine N14B16A M14×1.25		○	GHA400134	K
1.6 Cooper S (135 kW)	2010.03-	Estate Engine N18B16A M14×1.25	●		GHA326031	K
	2010.03-	Estate Engine N18B16A M14×1.25		○	GHA400134	K
1.6 Cooper S (147 kW)	2010.03-	Estate Engine N18B16A M14×1.25	●		GHA326031	K
	2010.03-	Estate Engine N18B16A M14×1.25		○	GHA400134	K
1.6 John Cooper Works (141 kW)	2008.10-	Estate Engine N14B16A M14×1.25	●		GHA326031	K
	2008.10-	Estate Engine N14B16A M14×1.25		○	GHA400134	K
1.6 John Cooper Works (155 kW)	2008.03-	Estate Engine N14B16C M14×1.25	●		GHA326031	K
	2008.03-	Estate Engine N14B16C M14×1.25		○	GHA400134	K
1.6 One (72 kW)	2010.03-	Estate Engine N16B16A M14×1.25	●		GHA326031	K
	2010.03-	Estate Engine N16B16A M14×1.25		○	GHA400134	K
1.6 One D (66 kW)	2010.03-	Estate Engine N47C16A M14×1.25	●		GHA326031	K
	2010.03-	Estate Engine N47C16A M14×1.25		○	GHA400134	K
2.0 Cooper D (82 kW)	2011.02-	Estate Engine N47C20A M14×1.25	●		GHA326031	K
	2011.02-	Estate Engine N47C20A M14×1.25		○	GHA400134	K
2.0 Cooper SD (100 kW)	2011.02-	Estate Engine N47C20A M14×1.25	●		GHA326031	K
	2011.02-	Estate Engine N47C20A M14×1.25		○	GHA400134	K
2.0 Cooper SD (105 kW)	2011.02-	Estate Engine N47C20A M14×1.25	●		GHA326031	K
	2011.02-	Estate Engine N47C20A M14×1.25		○	GHA400134	K
MINI COUNTRYMAN (R60)						
Cooper (85 kW)	2010.06-	Hatchback Engine N16 B16 A		○	GHA400279	
Cooper (90 kW)	2010.06-	Hatchback Engine N16 B16 A		○	GHA400279	
Cooper D (82 kW)	2010.06-	Hatchback Engine N47 C16 A		○	GHA400279	
	2011.02-	Hatchback Engine N47 C20 A		○	GHA400279	
Cooper S (135 kW)	2010.06-	Hatchback Engine N18 B16 A		○	GHA400279	
Cooper S (147 kW)	2012.02-	Hatchback Engine N18 B16 A		○	GHA400279	



	 YEAR		F	R	G-AP Ref.	KIT
MINI						
MINI COUNTRYMAN (R60)						
Cooper SD (105 kW)	2011.02-	Hatchback Engine N47 C20 A		o	GHA400279	
One (72 kW)	2010.06-	Hatchback Engine N16B16A		o	GHA400279	
One D (66 kW)	2010.06-	Hatchback Engine N47 C16 A		o	GHA400279	
MINI PACEMAN (R61)						
Cooper (88 kW)	2013.05-	Coupe Engine N16 B16 A		o	GHA400279	
Cooper (90 kW)	2012.04-	Coupe Engine N16 B16 A		o	GHA400279	
Cooper D (82 kW)	2012.09-	Coupe Engine N47 C16 A		o	GHA400279	
Cooper S (135 kW)	2012.04-	Coupe Engine N18 B16 A		o	GHA400279	
Cooper S (140 kW)	2014.07-	Coupe Engine N18 B16 A		o	GHA400279	
MINI ROADSTER (R59)						
1.6 Cooper (85 kW)	2012.02-	Convertible Engine N16B16A M14x1.25	•		GHA326031	K
	2012.02-	Convertible Engine N16B16A M14x1.25		o	GHA400134	K
1.6 Cooper (90 kW)	2012.02-	Convertible Engine N16B16A M14x1.25	•		GHA326031	K
	2012.02-	Convertible Engine N16B16A M14x1.25		o	GHA400134	K
1.6 Cooper S (120 kW)	2012.02-	Convertible Engine N18B16A M14x1.25	•		GHA326031	K
	2012.02-	Convertible Engine N18B16A M14x1.25		o	GHA400134	K
1.6 Cooper S (135 kW)	2012.02-	Convertible Engine N18B16A M14x1.25	•		GHA326031	K
	2012.02-	Convertible Engine N18B16A M14x1.25		o	GHA400134	K
1.6 Cooper S (147 kW)	2012.02-	Convertible Engine N18B16A M14x1.25	•		GHA326031	K
	2012.02-	Convertible Engine N18B16A M14x1.25		o	GHA400134	K
1.6 John Cooper Works (155 kW)	2012.02-	Convertible Engine N14B16C M14x1.25	•		GHA326031	K
	2012.02-	Convertible Engine N14B16C M14x1.25		o	GHA400134	K
2.0 Cooper SD (100 kW)	2012.02-	Convertible Engine N47C20A M14x1.25	•		GHA326031	K
	2012.02-	Convertible Engine N47C20A M14x1.25		o	GHA400134	K
2.0 Cooper SD (105 kW)	2012.02-	Convertible Engine N47C20A M14x1.25	•		GHA326031	K
	2012.02-	Convertible Engine N47C20A M14x1.25		o	GHA400134	K
MITSUBISHI						
3000 GT (Z16A)						
3.0 i 24V 4WD (210 kW)	1992.06-1999.08	Coupe Engine 6G72(DOHC24V)		o	GHA236001	
ASX (GA_W_)						
1.6 (85 kW)	2010.05-	Closed Off-Road Vehicle Engine 4A92	•		GWB7408	
	2010.05-	Closed Off-Road Vehicle Engine 4A92 With ABS		o	GHA400072	K
1.6 (86 kW)	2010.06-	Closed Off-Road Vehicle Engine 4A92	•		GWB7408	
	2010.06-	Closed Off-Road Vehicle Engine 4A92 With ABS		o	GHA400176	K
1.8 (102 kW)	2010.06-	Closed Off-Road Vehicle Engine 4A92 With ABS		o	GHA400072	K
	2010.02-	Closed Off-Road Vehicle Engine 4B10	•		GWB7408	
	2010.02-	Closed Off-Road Vehicle Engine 4B10		o	GHA325029	
	2010.02-	Closed Off-Road Vehicle Engine 4B10		o	GHA400176	K
1.8 Di-D (110 kW)	2010.02-	Closed Off-Road Vehicle Engine 4B10 With ABS		o	GHA400072	K
	2010.06-	Closed Off-Road Vehicle Engine 4N13	•		GWB7408	
	2010.06-	Closed Off-Road Vehicle Engine 4N13		o	GHA400176	K
1.8 Di-D (85 kW)	2010.06-	Closed Off-Road Vehicle Engine 4N13 With ABS		o	GHA400072	K
	2010.06-	Closed Off-Road Vehicle Engine 4N13	•		GWB7408	
	2010.06-	Closed Off-Road Vehicle Engine 4N13		o	GHA400176	K
1.8 Di-D 4WD (110 kW)	2010.06-	Closed Off-Road Vehicle Engine 4N13	•		GWB7408	
	2010.06-	Closed Off-Road Vehicle Engine 4N13		o	GHA325018	K
	2010.06-	Closed Off-Road Vehicle Engine 4N13		o	GHA325029	K
1.8 Di-D 4WD (85 kW)	2010.06-	Closed Off-Road Vehicle Engine 4N13	•		GWB7408	
	2010.06-	Closed Off-Road Vehicle Engine 4N13		o	GHA325018	K
	2010.06-	Closed Off-Road Vehicle Engine 4N13		o	GHA325029	K
2.0 i (110 kW)	2010.06-	Closed Off-Road Vehicle Engine 4B11	•		GWB7408	
	2010.06-	Closed Off-Road Vehicle Engine 4B11		o	GHA400176	K
	2010.06-	Closed Off-Road Vehicle Engine 4B11 With ABS		o	GHA400072	K
2.0 i (118 kW)	2010.06-	Closed Off-Road Vehicle Engine 4B11	•		GWB7408	
	2010.06-	Closed Off-Road Vehicle Engine 4B11 With ABS		o	GHA400072	K
2.0 i 4WD (110 kW)	2010.06-	Closed Off-Road Vehicle Engine 4B11	•		GWB7408	
	2010.06-	Closed Off-Road Vehicle Engine 4B11		o	GHA325018	K
	2010.06-	Closed Off-Road Vehicle Engine 4B11		o	GHA325029	K
2.0 i 4WD (118 kW)	2010.06-	Closed Off-Road Vehicle Engine 4B11	•		GWB7408	
	2010.06-	Closed Off-Road Vehicle Engine 4B11		o	GHA325018	K
ASX VAN (GA_W_)						
1.8 Di-D 4WD (110 kW)	2010.06-	Box Engine 4N13	•		GWB7408	



	 YEAR		F	R	G-AP Ref.	KIT
MITSUBISHI						
ASX VAN (GA_W_)						
1.8 Di-D 4WD (110 kW)	2010.06-	Box Engine 4N13		o	GHA325018	K
CARISMA (DA_)						
1.3 12V (55 kW)	2000.09-2004.1	Saloon Engine 4G13(12V)	•		GWB6913	
	2000.09-2004.1	Saloon Engine 4G13(12V)		o	GHA230053	
1.6 (66 kW)	1995.07-2006.06	Hatchback Engine 4G92	•		GWB3309	
	1995.07-2006.06	Hatchback Engine 4G92	•		GWB6913	
	1995.07-2006.06	Hatchback Engine 4G92		o	GHA228020	K
	1995.07-2006.06	Hatchback Engine 4G92		o	GHA228066	K
	1995.07-2006.06	Hatchback Engine 4G92		o	GHA230053	
	1996.09-2006.06	Saloon Engine 4G92	•		GWB3309	
	1996.09-2006.06	Saloon Engine 4G92	•		GWB6913	
	1996.09-2006.06	Saloon Engine 4G92		o	GHA228020	K
	1996.09-2006.06	Saloon Engine 4G92		o	GHA228066	K
	1996.09-2006.06	Saloon Engine 4G92		o	GHA230053	
1.6 (70 kW)	1998.12-2006.06	Hatchback Engine 4G92	•		GWB3309	
	1998.12-2006.06	Hatchback Engine 4G92	•		GWB6913	
	1998.12-2006.06	Hatchback Engine 4G92		o	GHA230053	
	1998.12-2006.06	Saloon Engine 4G92	•		GWB3309	
	1998.12-2006.06	Saloon Engine 4G92	•		GWB6913	
	1998.12-2006.06	Saloon Engine 4G92		o	GHA230053	
1.6 (73 kW)	1997.05-2006.06	Hatchback Engine 4G92	•		GWB3309	
	1997.05-2006.06	Hatchback Engine 4G92	•		GWB6913	
	1997.05-2006.06	Hatchback Engine 4G92		o	GHA228020	K
	1997.05-2006.06	Hatchback Engine 4G92		o	GHA228066	K
	1997.05-2006.06	Hatchback Engine 4G92		o	GHA230053	
	1997.05-2006.06	Saloon Engine 4G92	•		GWB3309	
	1997.05-2006.06	Saloon Engine 4G92	•		GWB6913	
	1997.05-2006.06	Saloon Engine 4G92		o	GHA228020	K
	1997.05-2006.06	Saloon Engine 4G92		o	GHA228066	K
	1997.05-2006.06	Saloon Engine 4G92		o	GHA230053	
1.6 (76 kW)	1999.08-2004.12	Hatchback Engine 4G92	•		GWB6913	
	1999.08-2004.12	Hatchback Engine 4G92		o	GHA230053	
	1999.08-2004.12	Saloon Engine 4G92	•		GWB6913	
	1999.08-2004.12	Saloon Engine 4G92		o	GHA230053	
1.8 (85 kW)	1995.07-2006.06	Hatchback Engine 4G93	•		GWB6913	
	1995.07-2006.06	Hatchback Engine 4G93		o	GHA230053	
	1996.09-2006.06	Saloon Engine 4G93	•		GWB6913	
	1996.09-2006.06	Saloon Engine 4G93		o	GHA230053	
1.8 16V (103 kW)	1995.07-2006.06	Hatchback Engine 4G93	•		GWB6913	
	1995.07-2006.06	Hatchback Engine 4G93		o	GHA230053	
1.8 16V GDi (92 kW)	1997.09-2006.06	Hatchback Engine 4G93	•		GWB6913	
	1997.09-2006.06	Hatchback Engine 4G93		o	GHA230053	
	1997.09-2006.06	Saloon Engine 4G93	•		GWB6913	
	1997.09-2006.06	Saloon Engine 4G93		o	GHA230053	
1.8 GDi (90 kW)	2000.10-2006.06	Hatchback Engine 4G93	•		GWB6913	
	2000.10-2006.06	Hatchback Engine 4G93		o	GHA230053	
	2000.10-2006.06	Saloon Engine 4G93	•		GWB6913	
	2000.10-2006.06	Saloon Engine 4G93		o	GHA230053	
1.9 Di-D (75 kW)	2000.09-2006.06	Hatchback Engine F9Q1	•		GWB6913	
	2000.09-2006.06	Hatchback Engine F9Q1		o	GHA230053	
	2000.09-2006.06	Saloon Engine F9Q1	•		GWB6913	
	2000.09-2006.06	Saloon Engine F9Q1		o	GHA230053	
1.9 Di-D (85 kW)	2000.09-2006.06	Hatchback Engine F9Q2	•		GWB6913	
	2000.09-2006.06	Hatchback Engine F9Q2		o	GHA230053	
	2000.09-2006.06	Saloon Engine F9Q2	•		GWB6913	
	2000.09-2006.06	Saloon Engine F9Q2		o	GHA230053	
1.9 TD (66 kW)	1996.10-2000.09	Hatchback Engine F8QT	•		GWB3309	
	1996.10-2000.09	Hatchback Engine F8QT	•		GWB6913	
	1996.10-2000.09	Hatchback Engine F8QT		o	GHA228020	K
	1996.10-2000.09	Hatchback Engine F8QT		o	GHA228066	K
	1996.10-2000.09	Hatchback Engine F8QT		o	GHA230053	
	1996.10-2000.09	Saloon Engine F8QT	•		GWB3309	
	1996.10-2000.09	Saloon Engine F8QT	•		GWB6913	
	1996.10-2000.09	Saloon Engine F8QT		o	GHA228020	K



	 YEAR		F	R	G-AP Ref.	KIT
MITSUBISHI						
CARISMA (DA_)						
1.9 TD (66 kW)	1996.10-2000.09	Saloon Engine F8QT		○	GHA228066	K
	1996.10-2000.09	Saloon Engine F8QT		○	GHA230053	
2.0 16V GT EVO VI/VII (206 kW)	1999.11-2006.06	Saloon Engine 4G63		○	GHA325022	K
CHALLENGER (K90)						
2.5 TD (73 kW)	1998.11-	Closed Off-Road Vehicle Engine 4D56T	●		GHA330006	K
	1998.11-	Closed Off-Road Vehicle Engine 4D56T	●		GWB1915	
	1998.11-	Closed Off-Road Vehicle Engine 4D56T		○	GWB3325	
2.5 TD (85 kW)	2000.02-2007.06	Closed Off-Road Vehicle Engine 4D56T	●		GHA330006	K
	2000.02-2007.06	Closed Off-Road Vehicle Engine 4D56T	●		GWB1915	
	2000.02-2007.06	Closed Off-Road Vehicle Engine 4D56T		○	GWB3325	
2.5 TD (98 kW)	2003.08-	Closed Off-Road Vehicle Engine 4D56T	●		GHA330006	K
	2003.08-	Closed Off-Road Vehicle Engine 4D56T	●		GWB1915	
	2003.08-	Closed Off-Road Vehicle Engine 4D56T		○	GWB3325	
3.0 V6 (123 kW)	2003.03-	Closed Off-Road Vehicle Engine 6G72(DOHC24V)	●		GHA330006	K
	2003.03-	Closed Off-Road Vehicle Engine 6G72(DOHC24V)	●		GWB1915	
	2003.03-	Closed Off-Road Vehicle Engine 6G72(DOHC24V)		○	GWB3325	
3.0 V6 (125 kW)	2001.10-2005.03	Closed Off-Road Vehicle Engine 6G72(SOHC24V)	●		GHA330006	K
	2001.10-2005.03	Closed Off-Road Vehicle Engine 6G72(SOHC24V)	●		GWB1915	
	2001.10-2005.03	Closed Off-Road Vehicle Engine 6G72(SOHC24V)		○	GWB3325	
3.0 V6 (130 kW)	1998.11-	Closed Off-Road Vehicle Engine 6G72(SOHC24V)	●		GHA330006	K
	1998.11-	Closed Off-Road Vehicle Engine 6G72(SOHC24V)	●		GWB1915	
	1998.11-	Closed Off-Road Vehicle Engine 6G72(SOHC24V)		○	GWB3325	
COLT CZC (RG)						
1.5 (80 kW)	2006.05-2009.07	Convertible Engine 4A91	●		GHA325026	K
	2006.05-2009.07	Convertible Engine 4A91		○	GHA400135	K
COLT III (C5_A)						
1.5 (66 kW)	1990.07-1992.05	Hatchback Engine 4G15	●		GWB1366	
	1990.07-1992.05	Hatchback Engine 4G15		○	GWB1962	
1.8 GTi 16V CAT (100 kW)	1990.06-1992.05	Hatchback Engine 4G67	●		GWB1366	
	1990.06-1992.05	Hatchback Engine 4G67		○	GWB1961	
COLT IV (CA_A)						
1.3 GLi 12V (55 kW)	1992.04-1996.04	Hatchback Engine 4G13	●		GWB3309	
	1992.04-1996.04	Hatchback Engine 4G13		○	GHA228020	K
	1992.04-1996.04	Hatchback Engine 4G13		○	GHA228055	
1.6 (66 kW)	1994.02-1996.04	Hatchback Engine 4G92	●		GWB3309	
	1994.02-1996.04	Hatchback Engine 4G92		○	GHA228020	K
1.6 GLXi 16V (83 kW)	1992.04-1996.04	Hatchback Engine 4G92	●		GWB3309	
	1992.04-1996.04	Hatchback Engine 4G92		○	GHA228020	K
	1992.04-1996.04	Hatchback Engine 4G92		○	GHA228055	
1.8 GTi 16V (103 kW)	1992.04-1996.04	Hatchback Engine 4G93	●		GWB3309	
	1992.04-1996.04	Hatchback Engine 4G93		○	GHA228020	K
	1992.04-1996.04	Hatchback Engine 4G93		○	GHA228055	
COLT V (CJ_, CP_)						
1.3 (60 kW)	2000.09-2003.09	Hatchback Engine 4G13(16V)	●		GWB3940	
	2000.09-2003.09	Hatchback Engine 4G13(16V)		○	GHA228020	K
	2000.09-2003.09	Hatchback Engine 4G13(16V)		○	GHA228066	K
1.3 GL, GLX (55 kW)	1996.05-2000.09	Hatchback Engine 4G13(12V)	●		GWB3309	
	1996.05-2000.09	Hatchback Engine 4G13(12V)	●		GWB3940	
	1996.05-2000.09	Hatchback Engine 4G13(12V)		○	GHA228020	K
	1996.05-2000.09	Hatchback Engine 4G13(12V)		○	GHA228066	K
1.5 (69 kW)	1995.11-2003.09	Hatchback Engine 4G15(16V)	●		GWB3309	
	1995.11-2003.09	Hatchback Engine 4G15(16V)	●		GWB3940	
	1995.11-2003.09	Hatchback Engine 4G15(16V)		○	GHA228020	K
1.6 (76 kW)	2000.09-2003.09	Hatchback Engine 4G92	●		GWB3940	
	2000.09-2003.09	Hatchback Engine 4G92		○	GHA228020	K
	2000.09-2003.09	Hatchback Engine 4G92		○	GHA228066	K
1.6 GLX (66 kW)	1996.05-2000.09	Hatchback Engine 4G92	●		GWB3309	
	1996.05-2000.09	Hatchback Engine 4G92	●		GWB3940	
	1996.05-2000.09	Hatchback Engine 4G92		○	GHA228020	K
	1996.05-2000.09	Hatchback Engine 4G92		○	GHA228066	K
COLT VI (Z3_A, Z2_A)						
1.1 (55 kW)	2004.10-2012.06	Hatchback Engine 3A91	●		GHA325026	K
	2004.10-2012.06	Hatchback Engine 3A91		○	GHA400135	K



	 YEAR		F	R	G-AP Ref.	KIT
MITSUBISHI						
COLT VI (Z3_A, Z2_A)						
1.1 Bifuel (55 kW)	2004.10-2012.06	Hatchback Engine 3A91	•		GHA325026	K
	2004.10-2012.06	Hatchback Engine 3A91		◦	GHA400135	K
1.3 (68 kW)	2004.10-2012.06	Hatchback Engine 4A90	•		GHA325026	K
	2004.10-2012.06	Hatchback Engine 4A90		◦	GHA400135	K
	2004.10-2012.06	Hatchback Engine 4A90		◦	GHA400239	
1.3 (70 kW)	2004.06-2012.06	Hatchback Engine 4A90	•		GHA325026	K
	2004.06-2012.06	Hatchback Engine 4A90		◦	GHA400135	K
	2004.06-2012.06	Hatchback Engine 4A90		◦	GHA400239	
1.3 Bifuel (70 kW)	2004.06-2012.06	Hatchback Engine 4A90	•		GHA325026	K
	2004.06-2012.06	Hatchback Engine 4A90		◦	GHA400135	K
	2004.06-2012.06	Hatchback Engine 4A90		◦	GHA400239	
1.5 (80 kW)	2004.06-2012.06	Hatchback Engine 4A91	•		GHA325026	K
	2004.06-2012.06	Hatchback Engine 4A91		◦	GHA400135	K
	2004.06-2012.06	Hatchback Engine 4A91		◦	GHA400239	
1.5 CZT (110 kW)	2005.03-2012.06	Hatchback Engine 4G15T		◦	GHA400135	K
	2005.03-2012.06	Hatchback Engine 4G15T		◦	GHA400239	
1.5 Di-D (50 kW)	2004.08-2012.06	Hatchback Engine OM639.939	•		GHA325026	K
	2004.08-2012.06	Hatchback Engine OM639.939		◦	GHA400135	K
	2004.08-2012.06	Hatchback Engine OM639.939		◦	GHA400239	
1.5 Di-D (70 kW)	2004.08-2012.06	Hatchback Engine OM639.939	•		GHA325026	K
	2004.08-2012.06	Hatchback Engine OM639.939		◦	GHA400135	K
	2004.08-2012.06	Hatchback Engine OM639.939		◦	GHA400239	
DELICA (P0_W, P1_W, P0_V, P1_V, P_2V, P2_W)						
2.5 D (55 kW)	1991.09-2003.09	Box Engine 4D56 (8V)	•		GWB1915	
	1991.09-2003.09	Box Engine 4D56 (8V)		◦	GWB3775	
DELICA (P0_W, P1_W, P2_W)						
2.5 D (55 kW)	1991.09-2003.09	Bus Engine 4D56 (8V)	•		GWB1915	
	1991.09-2003.09	Bus Engine 4D56 (8V)		◦	GWB3775	
ECLIPSE (D2_A)						
2.0 i 16V (110 kW)	1991.04-1995.11	Coupe Engine 4G63	•		GWB1970	
	1991.04-1995.11	Coupe Engine 4G63		◦	GHA233003	
2.0 i 16V 4WD (110 kW)	1991.04-1995.11	Coupe Engine 4G63	•		GWB1970	
ECLIPSE II (D3_A)						
2.0 GS 16V (107 kW)	1995.12-1999.04	Coupe Engine 4G63		◦	GHA233003	
	1995.12-1999.04	Coupe Engine 4G63		◦	GHA400027	
2.0 GT 16V (157 kW)	1995.12-1999.04	Coupe		◦	GHA233003	
	1995.12-1999.04	Coupe		◦	GHA400027	
2.4 GS 16V (105 kW)	1998.09-1999.04	Coupe Engine 4G61		◦	GHA400027	
ECLIPSE IV (DK_A)						
2.4 GS (120 kW)	2005.04-2011.12	Coupe Engine 4G69 With ABS		◦	GHA400211	
3.8 GT (192 kW)	2005.04-2011.12	Coupe Engine 6G75 With ABS		◦	GHA400211	
GALANT (DJ_, ED_, EF_)						
2.4 (116 kW)	2003.10-	Saloon Engine 4G69	•		GHA325001	
	2003.10-	Saloon Engine 4G69 With ABS		◦	GHA400211	
2.4 (118 kW)	2004.12-	Saloon Engine 4G69	•		GHA325001	
	2004.12-	Saloon Engine 4G69 With ABS		◦	GHA400211	
2.4 (121 kW)	2003.10-	Saloon Engine 4G69 With ABS		◦	GHA400211	
2.4 GDi Sport 4WD (121 kW)	2003.10-	Saloon Engine 4G69 With ABS		◦	GHA400211	
3.8 (171 kW)	2003.10-2009.12	Saloon Engine 6G75 With ABS		◦	GHA400211	
3.8 4WD (171 kW)	2003.10-	Saloon Engine 6G75 With ABS		◦	GHA400211	
GALANT IV (E3_A)						
2.0 GTi 16V 4WD CAT(110 kW)	1991.09-1992.10	Saloon Engine 4G63	•		GWB1970	
GALANT V (E5_A, E7_A, E8_A)						
1.8 (85 kW)	1994.02-1996.08	Hatchback Engine 4G93	•		GHA240001	K
	1994.02-1996.08	Hatchback Engine 4G93	•		GHA325005	
	1994.02-1996.08	Hatchback Engine 4G93		◦	GHA230008	K
	1994.02-1996.08	Hatchback Engine 4G93 Without ABS		◦	GHA400168	
	1994.02-1996.08	Hatchback Engine 4G93 Without ABS		◦	GHA400168	
	1994.02-1996.08	Saloon Engine 4G93	•		GHA240001	K
	1994.02-1996.08	Saloon Engine 4G93	•		GHA325005	
	1994.02-1996.08	Saloon Engine 4G93		◦	GHA230008	K
	1994.02-1996.08	Saloon Engine 4G93 Without ABS		◦	GHA400168	
	1994.02-1996.08	Saloon Engine 4G93 Without ABS		◦	GHA400168	



	 YEAR		F	R	G-AP Ref.	KIT	
MITSUBISHI							
GALANT V (E5_A, E7_A, E8_A)							
1.8 GLSi (93 kW)	1992.11-1996.08	Hatchback Engine 4G93(GDI)	•		GHA240001	K	
	1992.11-1996.08	Hatchback Engine 4G93(GDI)	•		GHA325005		
	1992.11-1996.08	Hatchback Engine 4G93(GDI)		○	GHA230008	K	
	1992.11-1996.08	Hatchback Engine 4G93(GDI) Without ABS		○	GHA400168		
	1992.11-1996.08	Hatchback Engine 4G93(GDI) Without ABS		○	GHA400168		
	1992.11-1996.08	Saloon Engine 4G93(GDI)	•		GHA240001	K	
	1992.11-1996.08	Saloon Engine 4G93(GDI)	•		GHA325005		
	1992.11-1996.08	Saloon Engine 4G93(GDI)		○	GHA230008	K	
	1992.11-1996.08	Saloon Engine 4G93(GDI) Without ABS		○	GHA400168		
	1992.11-1996.08	Saloon Engine 4G93(GDI) Without ABS		○	GHA400168		
	2.0 GLS TD (66 kW)	1992.11-1996.08	Hatchback Engine 4D68T	•		GHA240001	K
		1992.11-1996.08	Hatchback Engine 4D68T	•		GHA325005	
		1992.11-1996.08	Hatchback Engine 4D68T		○	GHA230008	K
		1992.11-1996.08	Hatchback Engine 4D68T Without ABS		○	GHA400168	
1992.11-1996.08		Hatchback Engine 4D68T Without ABS		○	GHA400168		
1992.11-1996.08		Saloon Engine 4D68T	•		GHA240001	K	
1992.11-1996.08		Saloon Engine 4D68T	•		GHA325005		
1992.11-1996.08		Saloon Engine 4D68T		○	GHA230008	K	
1992.11-1996.08		Saloon Engine 4D68T Without ABS		○	GHA400168		
1992.11-1996.08		Saloon Engine 4D68T Without ABS		○	GHA400168		
2.0 GLSi (101 kW)	1992.11-1996.08	Hatchback Engine 4G63(SOHC8V)	•		GHA240001	K	
	1992.11-1996.08	Hatchback Engine 4G63(SOHC8V)	•		GHA325005		
	1992.11-1996.08	Hatchback Engine 4G63(SOHC8V)		○	GHA230008	K	
	1992.11-1996.08	Hatchback Engine 4G63(SOHC8V) Without ABS		○	GHA400168		
	1992.11-1996.08	Hatchback Engine 4G63(SOHC8V) Without ABS		○	GHA400168		
	1992.11-1996.08	Saloon Engine 4G63(SOHC8V)	•		GHA240001	K	
	1992.11-1996.08	Saloon Engine 4G63(SOHC8V)	•		GHA325005		
	1992.11-1996.08	Saloon Engine 4G63(SOHC8V)		○	GHA230008	K	
	1992.11-1996.08	Saloon Engine 4G63(SOHC8V) Without ABS		○	GHA400168		
	1992.11-1996.08	Saloon Engine 4G63(SOHC8V) Without ABS		○	GHA400168		
2.0 GLSi 4WD (101 kW)	1992.11-1996.08	Hatchback Engine 4G63(SOHC8V)	•		GHA240001	K	
	1992.11-1996.08	Hatchback Engine 4G63(SOHC8V)	•		GHA325005		
	1992.11-1996.08	Saloon Engine 4G63(SOHC8V)	•		GHA240001	K	
	1992.11-1996.08	Saloon Engine 4G63(SOHC8V)	•		GHA325005		
2.0 V6-24 (110 kW)	1992.11-1996.08	Hatchback Engine 6A12	•		GHA240001	K	
	1992.11-1996.08	Hatchback Engine 6A12	•		GHA325005		
	1992.11-1996.08	Hatchback Engine 6A12		○	GHA230008	K	
	1992.11-1996.08	Hatchback Engine 6A12 With ABS		○	GHA400089		
	1992.11-1996.08	Hatchback Engine 6A12 Without ABS		○	GHA400168		
	1992.11-1996.08	Hatchback Engine 6A12 Without ABS		○	GHA400168		
	1992.11-1996.08	Saloon Engine 6A12	•		GHA240001	K	
	1992.11-1996.08	Saloon Engine 6A12	•		GHA325005		
	1992.11-1996.08	Saloon Engine 6A12		○	GHA230008	K	
	1992.11-1996.08	Saloon Engine 6A12 With ABS		○	GHA400089		
	1992.11-1996.08	Saloon Engine 6A12 Without ABS		○	GHA400168		
	1992.11-1996.08	Saloon Engine 6A12 Without ABS		○	GHA400168		
2.5 (125 kW)	1992.11-1996.09	Hatchback Engine 6G73	•		GHA240001	K	
	1992.11-1996.09	Hatchback Engine 6G73	•		GHA325005		
	1992.11-1996.09	Hatchback Engine 6G73		○	GHA230008	K	
2.5 V6-24 4WD (125 kW)	1992.11-1996.08	Hatchback Engine 6G73	•		GHA240001	K	
	1992.11-1996.08	Hatchback Engine 6G73	•		GHA325005		
	1992.11-1996.08	Saloon Engine 6G73	•		GHA240001	K	
	1992.11-1996.08	Saloon Engine 6G73	•		GHA325005		
GALANT VI (EA_)							
2.0 (100 kW)	1996.09-2000.09	Estate Engine 4G63(SOHC16V)	•		GHA240001	K	
	1996.09-2000.09	Estate Engine 4G63(SOHC16V)	•		GHA325005		
	1996.09-2000.09	Estate Engine 4G63(SOHC16V)		○	GHA230008	K	
	1996.09-2000.09	Estate Engine 4G63(SOHC16V) With ABS		○	GHA400088		
	1996.09-2000.09	Estate Engine 4G63(SOHC16V) Without ABS		○	GHA400168		
	1996.09-2000.09	Estate Engine 4G63(SOHC16V) Without ABS		○	GHA400168		
	1996.09-2000.09	Saloon Engine 4G63(SOHC16V)	•		GHA240001	K	
	1996.09-2000.09	Saloon Engine 4G63(SOHC16V)	•		GHA325005		
	1996.09-2000.09	Saloon Engine 4G63(SOHC16V)		○	GHA230008	K	
	1996.09-2000.09	Saloon Engine 4G63(SOHC16V) With ABS		○	GHA400088		



	 YEAR		F	R	G-AP Ref.	KIT
MITSUBISHI						
GALANT VI (EA_)						
2.0 (100 kW)	1996.09-2000.09	Saloon Engine 4G63(SOHC16V) Without ABS		o	GHA400168	
	1996.09-2000.09	Saloon Engine 4G63(SOHC16V) Without ABS		o	GHA400168	
2.0 (98 kW)	2000.09-2003.10	Estate Engine 4G63(SOHC16V)	•		GHA240001	K
	2000.09-2003.10	Estate Engine 4G63(SOHC16V)	•		GHA325005	
	2000.09-2003.10	Estate Engine 4G63(SOHC16V)		o	GHA230008	K
	2000.09-2003.10	Estate Engine 4G63(SOHC16V) With ABS		o	GHA400088	
	2000.09-2003.10	Estate Engine 4G63(SOHC16V) Without ABS		o	GHA400168	
	2000.09-2003.10	Estate Engine 4G63(SOHC16V) Without ABS		o	GHA400168	
	2000.09-2004.10	Saloon Engine 4G63(SOHC16V)	•		GHA240001	K
	2000.09-2004.10	Saloon Engine 4G63(SOHC16V)	•		GHA325005	
	2000.09-2004.10	Saloon Engine 4G63(SOHC16V)		o	GHA230008	K
	2000.09-2004.10	Saloon Engine 4G63(SOHC16V) With ABS		o	GHA400088	
	2000.09-2004.10	Saloon Engine 4G63(SOHC16V) Without ABS		o	GHA400168	
	2000.09-2004.10	Saloon Engine 4G63(SOHC16V) Without ABS		o	GHA400168	
2.0 GDi (107 kW)	1999.10-2004.10	Saloon Engine 4G94	•		GHA240001	K
	1999.10-2004.10	Saloon Engine 4G94	•		GHA325005	
	1999.10-2004.10	Saloon Engine 4G94		o	GHA230008	K
2.0 TDi (66 kW)	1996.09-2003.10	Estate Engine 4D68SOHC	•		GHA240001	K
	1996.09-2003.10	Estate Engine 4D68SOHC	•		GHA325005	
	1996.09-2003.10	Estate Engine 4D68SOHC		o	GHA230008	K
	1996.09-2003.10	Estate Engine 4D68SOHC With ABS		o	GHA400088	
	1996.09-2003.10	Estate Engine 4D68SOHC Without ABS		o	GHA400168	
	1996.09-2003.10	Estate Engine 4D68SOHC Without ABS		o	GHA400168	
	1996.09-2004.10	Saloon Engine 4D68(SOHC)/4D68T	•		GHA240001	K
	1996.09-2004.10	Saloon Engine 4D68(SOHC)/4D68T	•		GHA325005	
	1996.09-2004.10	Saloon Engine 4D68(SOHC)/4D68T		o	GHA230008	K
	1996.09-2004.10	Saloon Engine 4D68(SOHC)/4D68T With ABS		o	GHA400088	
	1996.09-2004.10	Saloon Engine 4D68(SOHC)/4D68T Without ABS		o	GHA400168	
	1996.09-2004.10	Saloon Engine 4D68(SOHC)/4D68T Without ABS		o	GHA400168	
2.4 GDi (106 kW)	2000.09-2003.10	Estate Engine 4G64	•		GHA240001	K
	2000.09-2003.10	Estate Engine 4G64	•		GHA325005	
	2000.09-2003.10	Estate Engine 4G64		o	GHA230008	K
	2000.09-2003.10	Estate Engine 4G64 With ABS		o	GHA400088	
	2000.09-2004.10	Saloon Engine 4G64	•		GHA240001	K
	2000.09-2004.10	Saloon Engine 4G64	•		GHA325005	
	2000.09-2004.10	Saloon Engine 4G64		o	GHA230008	K
	2000.09-2004.10	Saloon Engine 4G64 With ABS		o	GHA400088	
2.4 GDi (110 kW)	1999.02-2000.09	Saloon Engine 4G64	•		GHA240001	K
	1999.02-2000.09	Saloon Engine 4G64	•		GHA325005	
	1999.02-2000.09	Saloon Engine 4G64		o	GHA230008	K
	1999.02-2000.09	Saloon Engine 4G64 With ABS		o	GHA400088	
	1999.02-2003.10	Estate Engine 4G64	•		GHA240001	K
	1999.02-2003.10	Estate Engine 4G64	•		GHA325005	
	1999.02-2003.10	Estate Engine 4G64		o	GHA230008	K
	1999.02-2003.10	Estate Engine 4G64 With ABS		o	GHA400088	
	1999.02-2003.10	Estate Engine 4G64 Without ABS		o	GHA400168	
	1999.02-2003.10	Estate Engine 4G64 Without ABS		o	GHA400168	
2.5 Type S (151 kW)	1999.10-2004.10	Saloon	•		GHA240001	K
	1999.10-2004.10	Saloon	•		GHA325005	
	1999.10-2004.10	Saloon		o	GHA230008	K
2.5 V6 24V (118 kW)	2000.09-2003.10	Estate Engine 6A13	•		GHA240001	K
	2000.09-2003.10	Estate Engine 6A13	•		GHA325005	
	2000.09-2003.10	Estate Engine 6A13		o	GHA230008	K
	2000.09-2003.10	Estate Engine 6A13 With ABS		o	GHA400088	
	2000.09-2004.10	Saloon Engine 6A13	•		GHA240001	K
	2000.09-2004.10	Saloon Engine 6A13	•		GHA325005	
	2000.09-2004.10	Saloon Engine 6A13		o	GHA230008	K
	2000.09-2004.10	Saloon Engine 6A13 With ABS		o	GHA400088	
2.5 V6 24V (120 kW)	1996.09-2000.09	Estate Engine 6A13	•		GHA240001	K
	1996.09-2000.09	Estate Engine 6A13	•		GHA325005	
	1996.09-2000.09	Estate Engine 6A13		o	GHA230008	K
	1996.09-2000.09	Estate Engine 6A13 With ABS		o	GHA400088	
	1996.09-2000.09	Saloon Engine 6A13	•		GHA240001	K
	1996.09-2000.09	Saloon Engine 6A13	•		GHA325005	



	 YEAR		F	R	G-AP Ref.	KIT
MITSUBISHI						
GALANT VI (EA_)						
2.5 V6 24V (120 kW)	1996.09-2000.09	Saloon Engine 6A13		o	GHA230008	K
	1996.09-2000.09	Saloon Engine 6A13 With ABS		o	GHA400088	
GRANDIS (NA_W)						
2.0 Di-D (100 kW)	2005.09-2007.09	MPV Engine BSY	•		GHA328006	K
	2005.09-2007.09	MPV Engine BSY		o	GHA400165	
2.0 Di-D (103 kW)	2007.02-	MPV Engine BWC	•		GHA328006	K
	2007.02-	MPV Engine BWC		o	GHA400165	
2.4 (121 kW)	2004.04-2007.09	MPV Engine 4G69	•		GHA328006	K
	2004.04-2007.09	MPV Engine 4G69		o	GHA400165	
L 200 (K7_T, K6_T)						
2.0 (90 kW)	1996.06-2007.12	Pickup Engine 4G63(SOHC8V)	•		GWB1369	
	1996.06-2007.12	Pickup Engine 4G63(SOHC8V)		o	GWB3775	
2.4 4WD (97 kW)	1996.06-2007.12	Pickup Engine 4G64(SOHC16V)	•		GWB1915	
	1996.06-2007.12	Pickup Engine 4G64(SOHC16V)		o	GWB3775	
2.5 D (55 kW)	1996.06-2007.12	Pickup Engine 4D56(8V)	•		GWB1369	
	1996.06-2007.12	Pickup Engine 4D56(8V)		o	GWB1956	
	1996.06-2007.12	Pickup Engine 4D56(8V)		o	GWB3775	
2.5 TD (66 kW)	2001.08-2005.11	Pickup Engine 4D56T	•		GWB1915	
	2001.08-2005.11	Pickup Engine 4D56T		o	GWB3775	
2.5 TD 4WD (73 kW)	1996.06-2007.12	Pickup Engine 4D56TD	•		GWB1915	
	1996.06-2007.12	Pickup Engine 4D56TD		o	GWB3775	
2.5 TD 4WD (85 kW)	2001.09-2007.12	Pickup Engine 4D56T	•		GWB1915	
	2001.09-2007.12	Pickup Engine 4D56T		o	GWB3775	
2.5 TD 4WD (98 kW)	2001.08-2007.12	Pickup Engine 4D56T	•		GWB1915	
	2001.08-2007.12	Pickup Engine 4D56T		o	GWB3775	
L 200 (KA_T, KB_T)						
2.4 CNG (94 kW)	2009.12-	Platform/Chassis Engine 4G64 (SOHC 16V)	•		GHA330007	
L 200 (KB_T, KA_T)						
2.4 i (94 kW)	2005.11-	Pickup Engine 4G64 (SOHC 16V)	•		GHA250011	
	2005.11-	Pickup Engine 4G64 (SOHC 16V)	•		GHA330007	
2.5 DiD (100 kW)	2005.11-	Pickup Engine 4D56 HP	•		GHA330007	
2.5 Di-D (123 kW)	2007.08-	Pickup Engine 4D56HP	•		GHA250011	
	2007.08-	Pickup Engine 4D56HP	•		GHA330007	
2.5 Di-D (94 kW)	2010.04-	Pickup Engine 4D56HP	•		GHA330007	
2.5 Di-D 4WD (100 kW)	2005.11-	Pickup Engine 4D56HP	•		GHA250011	
	2005.11-	Pickup Engine 4D56HP	•		GHA330007	
2.5 Di-D 4WD (123 kW)	2007.10-	Pickup Engine 4D56HP	•		GHA250011	
	2007.10-	Pickup Engine 4D56HP	•		GHA330007	
2.5 Di-D 4WD (131 kW)	2010.04-	Pickup Engine 4D56HP	•		GHA250011	
	2010.04-	Pickup Engine 4D56HP	•		GHA330007	
3.2 Di-D 4WD (118 kW)	2006.07-	Pickup Engine 4M41	•		GHA250011	
	2006.07-	Pickup Engine 4M41	•		GHA330007	
3.2 Di-D 4WD (121 kW)	2007.05-	Pickup Engine 4M41	•		GHA250011	
	2007.05-	Pickup Engine 4M41	•		GHA330007	
3.5 4WD (147 kW)	2007.05-	Pickup Engine 6G74 (SOHC 24V)	•		GHA330007	
L 300 (P0_W, P1_W, P2_W)						
2.4 (82 kW)	1990.11-	Bus Engine 4G64(12V)	•		GWB1369	
2.4 4WD (82 kW)	1990.11-	Bus Engine 4G64(12V)	•		GWB1915	
	1990.11-	Bus Engine 4G64(12V)		o	GWB1956	
	1990.11-	Bus Engine 4G64(12V)		o	GWB3775	
L 400 (PD_W, PC_W, PB_V, PA_W, PA_V)						
2500 TD (64 kW)	1996.09-2005.06	Box Engine 4D56T	•		GWB1369	
	1996.09-2005.06	Box Engine 4D56T		o	GWB3775	
L 400 / SPACE GEAR (PD_W, PC_W, PA_V, PB_V)						
	1995.05-2005.06	Bus Engine 4D56T	•		GWB1369	
	1995.05-2005.06	Bus Engine 4D56T		o	GWB3775	
LANCER (CS_A)						
1.3 (60 kW)	2003.09-	Saloon Engine 4G13(16V)	•		GWB6926	
	2003.09-	Saloon Engine 4G13(16V)		o	GHA230100	
1.6 (72 kW)	2004.12-2008.01	Saloon Engine 4G18	•		GWB6926	
	2004.12-2008.01	Saloon Engine 4G18		o	GHA230100	
2.0 (99 kW)	2004.12-2008.01	Saloon Engine 4G63(DOHC16V)	•		GHA425049	
	2004.12-2008.01	Saloon Engine 4G63(DOHC16V)	•		GWB6926	



	 YEAR		F	R	G-AP Ref.	KIT
MITSUBISHI						
LANCER (CS_A)						
2.0 (99 kW)	2004.12-2008.01	Saloon Engine 4G63(DOHC16V) With ABS 5 hole		o	GHA230087	K
2.0 16V EVO IX (206 kW)	2006.01-	Saloon Engine 4G63	•		GHA327032	
	2006.01-	Saloon Engine 4G63		o	GHA240009	
	2006.01-	Saloon Engine 4G63		o	GHA325022	K
2.0 16V EVO VIII (195 kW)	2004.04-2008.01	Saloon Engine 4G63	•		GHA327032	
	2004.04-2008.01	Saloon Engine 4G63		o	GHA240009	
	2004.04-2008.01	Saloon Engine 4G63		o	GHA325022	K
2.0 4WD (213 kW)	2005.08-	Saloon Engine 4G63	•		GHA327032	
	2005.08-	Saloon Engine 4G63	•		GHA425049	
	2005.08-	Saloon Engine 4G63		o	GHA240009	
LANCER (CS_A, CT0)						
2.0 (85 kW)	2003.09-	Saloon Engine 4G63 (DOHC 16V)	•		GHA425049	
	2003.09-	Saloon Engine 4G63 (DOHC 16V)	•		GWB6926	
	2003.09-	Saloon Engine 4G63 (DOHC 16V) With ABS 5 hole		o	GHA230087	K
2.4 iVRX (115 kW)	2005.08-	Saloon Engine 4G69	•		GHA425049	
	2005.08-	Saloon Engine 4G69	•		GWB6926	
	2005.08-	Saloon Engine 4G69		o	GHA230100	
	2005.08-	Saloon Engine 4G69 With ABS 5 hole		o	GHA230087	K
LANCER (CS_W)						
1.6 (72 kW)	2003.09-2008.10	Estate Engine 4G18	•		GHA425049	
	2003.09-2008.10	Estate Engine 4G18	•		GWB6926	
	2003.09-2008.10	Estate Engine 4G18		o	GHA230100	
	2003.09-2008.10	Estate Engine 4G18 With ABS 5 hole		o	GHA230087	K
2.0 (99 kW)	2003.09-2007.12	Estate Engine 4G63(DOHC16V)	•		GHA425049	
	2003.09-2007.12	Estate Engine 4G63(DOHC16V)	•		GWB6926	
	2003.09-2007.12	Estate Engine 4G63(DOHC16V)		o	GHA230100	
	2003.09-2007.12	Estate Engine 4G63(DOHC16V) With ABS 5 hole		o	GHA230087	K
LANCER (CX_A)						
1.5 (80 kW)	2008.06-	Hatchback Engine 4A91	•		GHA428015	K
	2008.06-	Hatchback Engine 4A91	•		GWB7408	
	2008.06-	Hatchback Engine 4A91		o	GHA400176	K
	2008.06-	Hatchback Engine 4A91 With ABS		o	GHA400072	K
1.5 Bifuel (80 kW)	2010.03-	Hatchback Engine 4A91	•		GHA428015	K
1.6 (86 kW)	2010.05-	Hatchback Engine A492	•		GHA428015	K
	2010.05-	Hatchback Engine A492		o	GHA400176	K
1.8 (103 kW)	2009.03-	Hatchback Engine 4B10	•		GHA428015	K
	2009.03-	Hatchback Engine 4B10	•		GWB7408	
	2009.03-	Hatchback Engine 4B10		o	GHA400176	K
	2009.03-	Hatchback Engine 4B10 With ABS		o	GHA400072	K
1.8 (105 kW)	2008.06-	Hatchback Engine 4B10	•		GHA428015	K
	2008.06-	Hatchback Engine 4B10	•		GWB7408	
	2008.06-	Hatchback Engine 4B10		o	GHA400176	K
	2008.06-	Hatchback Engine 4B10 With ABS		o	GHA400072	K
1.8 Bifuel (105 kW)	2010.02-	Hatchback Engine 4B10	•		GHA428015	K
1.8 Di-D (110 kW)	2010.06-	Hatchback Engine 4N13	•		GHA428015	K
	2010.06-	Hatchback Engine 4N13		o	GHA400176	K
1.8 Di-D (85 kW)	2010.05-	Hatchback Engine 4N13	•		GHA428015	K
	2010.05-	Hatchback Engine 4N13		o	GHA400176	K
1.8 Flex (103 kW)	2009.03-	Hatchback Engine 4B10	•		GHA428015	K
2.0 Di-D (103 kW)	2008.06-	Hatchback Engine BKD/BWC	•		GHA428015	K
	2008.06-	Hatchback Engine BKD/BWC	•		GWB7408	
	2008.06-	Hatchback Engine BKD/BWC		o	GHA400176	K
	2008.06-	Hatchback Engine BKD/BWC With ABS		o	GHA400072	K
2.0 Ralliart (177 kW)	2008.10-	Hatchback Engine 4B11T/C	•		GHA428015	K
	2008.10-	Hatchback Engine 4B11T/C	•		GWB7408	
	2008.10-	Hatchback Engine 4B11T/C		o	GHA327044	K
LANCER (CY/Z_A)						
1.5 (80 kW)	2008.06-	Saloon Engine 4A91	•		GHA428015	K
	2008.06-	Saloon Engine 4A91	•		GWB7408	
	2008.06-	Saloon Engine 4A91		o	GHA400176	K
	2008.06-	Saloon Engine 4A91 With ABS		o	GHA400072	K
1.5 Bifuel (80 kW)	2010.02-	Saloon Engine 4A91	•		GHA428015	K
1.6 (86 kW)	2010.05-	Saloon Engine 4A92	•		GHA428015	K
	2010.05-	Saloon Engine 4A92		o	GHA400176	K



	 YEAR		F	R	G-AP Ref.	KIT
MITSUBISHI						
LANCER (CY/Z_A)						
1.8 (103 kW)	2010.05-	Saloon Engine 4B10	•		GHA428015	K
	2010.05-	Saloon Engine 4B10	•		GWB7408	
	2010.05-	Saloon Engine 4B10 With ABS		◦	GHA400072	K
1.8 (105 kW)	2008.01-	Saloon Engine 4B10	•		GHA428015	K
	2008.01-	Saloon Engine 4B10	•		GWB7408	
	2008.01-	Saloon Engine 4B10		◦	GHA400176	K
	2008.01-	Saloon Engine 4B10 With ABS		◦	GHA400072	K
1.8 Bifuel (105 kW)	2010.02-	Saloon Engine 4B10	•		GHA428015	K
1.8 Di-D (110 kW)	2010.06-	Saloon Engine 4N13	•		GHA428015	K
	2010.06-	Saloon Engine 4N13	•		GWB7408	
	2010.06-	Saloon Engine 4N13		◦	GHA400176	K
	2010.06-	Saloon Engine 4N13 With ABS		◦	GHA400072	K
1.8 Di-D (85 kW)	2010.05-	Saloon Engine RHE4N13	•		GHA428015	K
	2010.05-	Saloon Engine RHE4N13	•		GWB7408	
	2010.05-	Saloon Engine RHE4N13		◦	GHA400176	K
	2010.05-	Saloon Engine RHE4N13 With ABS		◦	GHA400072	K
1.8 Flex (103 kW)	2009.03-	Saloon Engine 4B10	•		GHA428015	K
2.0 (108 kW)	2009.01-	Saloon Engine 4B11	•		GHA428015	K
	2009.01-	Saloon Engine 4B11	•		GWB7408	
	2009.01-	Saloon Engine 4B11 With ABS		◦	GHA400072	K
2.0 (110 kW)	2013.01-	Saloon Engine 4B11	•		GHA428015	K
	2013.01-	Saloon Engine 4B11	•		GWB7408	
	2013.01-	Saloon Engine 4B11 With ABS		◦	GHA400072	K
2.0 (115 kW)	2008.04-	Saloon Engine 4B11	•		GHA428015	K
	2008.04-	Saloon Engine 4B11	•		GWB7408	
	2008.04-	Saloon Engine 4B11 With ABS		◦	GHA400072	K
2.0 Di-D (103 kW)	2008.01-	Saloon Engine BKD/BWC	•		GHA428015	K
	2008.01-	Saloon Engine BKD/BWC	•		GWB7408	
	2008.01-	Saloon Engine BKD/BWC		◦	GHA400176	K
	2008.01-	Saloon Engine BKD/BWC With ABS		◦	GHA400072	K
2.0 EVO (217 kW)	2008.06-	Saloon Engine 4B11T/C	•		GHA328006	K
2.0 EVO (221 kW)	2008.06-	Saloon Engine 4B11T/C	•		GHA428015	K
	2008.06-	Saloon Engine 4B11T/C	•		GWB7408	
	2008.06-	Saloon Engine 4B11T/C With ABS		◦	GHA400072	K
2.0 EVO (242 kW)	2008.06-	Saloon Engine 4B11FQ30	•		GHA428015	K
	2008.06-	Saloon Engine 4B11FQ30	•		GWB7408	
	2008.06-	Saloon Engine 4B11FQ30		◦	GHA325018	K
2.0 EVO (264 kW)	2008.06-	Saloon Engine 4B11FQ60	•		GHA428015	K
	2008.06-	Saloon Engine 4B11FQ60	•		GWB7408	
	2008.06-	Saloon Engine 4B11FQ60 With ABS		◦	GHA400072	K
2.0 i (113 kW)	2009.01-	Saloon Engine 4B11	•		GHA328006	K
	2009.01-	Saloon Engine 4B11	•		GHA428015	K
	2009.01-	Saloon Engine 4B11		◦	GHA327044	K
2.0 i (118 kW)	2009.10-	Saloon Engine 4B11	•		GHA428015	K
2.0 i Ralliart 4WD (177 kW)	2008.10-	Saloon Engine 4B11T/C	•		GHA428015	K
	2008.10-	Saloon Engine 4B11T/C	•		GWB7408	
	2008.10-	Saloon Engine 4B11T/C		◦	GHA327044	K
LANCER III (C1_V, C3_V)						
1.5 12V (66 kW)	1990.09-1991.12	Estate Engine 4G15	•		GWB1366	
1.8 4WD (69 kW)	1990.08-1992.06	Estate Engine 4G37	•		GWB1366	
LANCER IV (C6_A)						
1.3 12V (55 kW)	1990.07-1992.06	Saloon Engine 4G13	•		GWB1366	
	1990.07-1992.06	Saloon Engine 4G13		◦	GWB1962	
LANCER IV (C6_A, C7_A)						
	1992.06-1994.05	Hatchback Engine 4G13	•		GWB1366	
	1992.06-1994.05	Hatchback Engine 4G13		◦	GWB1962	
1.6 16V (83 kW)	1992.06-1994.05	Hatchback Engine 4G92	•		GWB1366	
	1992.06-1994.05	Hatchback Engine 4G92		◦	GWB1961	
	1992.06-1994.05	Hatchback Engine 4G92		◦	GWB1962	
LANCER SPORTBACK (CX_A)						
2.0 Ralliart (184 kW)	2011.08-	Hatchback Engine 4B11 T/C	•		GHA428015	K
	2011.08-	Hatchback Engine 4B11 T/C	•		GWB7408	
	2011.08-	Hatchback Engine 4B11 T/C		◦	GHA327044	K



	 YEAR		F	R	G-AP Ref.	KIT
MITSUBISHI						
LANCER V (CB/D_A)						
1.3 (55 kW)	1992.06-1996.12	Saloon Engine 4G13(12V)	•		GWB3309	
	1992.06-1996.12	Saloon Engine 4G13(12V)		◦	GHA228020	K
	1992.06-1996.12	Saloon Engine 4G13(12V)		◦	GHA228055	
1.6 16V (83 kW)	1992.06-1996.12	Saloon Engine 4G92	•		GWB3309	
	1992.06-1996.12	Saloon Engine 4G92		◦	GHA228020	K
	1992.06-1996.12	Saloon Engine 4G92		◦	GHA228055	
1.8 16V (103 kW)	1992.06-1993.12	Saloon Engine 4G93	•		GWB3309	
	1992.06-1993.12	Saloon Engine 4G93		◦	GHA228020	K
	1992.06-1993.12	Saloon Engine 4G93		◦	GHA228055	
2.0 Diesel (50 kW)	1992.06-1996.12	Saloon Engine 4D68	•		GWB3309	
	1992.06-1996.12	Saloon Engine 4D68		◦	GHA228020	K
	1992.06-1996.12	Saloon Engine 4D68		◦	GHA228055	
LANCER V STATION WAGON (CB_W, CD_W)						
1.6 16V (83 kW)	1992.12-2003.10	Estate Engine 4G92	•		GWB3309	
	1992.12-2003.10	Estate Engine 4G92	•		GWB3940	
	1992.12-2003.10	Estate Engine 4G92		◦	GHA228055	
LANCER VI (CJ-CP_)						
1.3 12V (55 kW)	1995.12-2003.08	Saloon Engine 4G13	•		GWB3309	
	1995.12-2003.08	Saloon Engine 4G13	•		GWB3940	
	1995.12-2003.08	Saloon Engine 4G13		◦	GHA228020	K
	1995.12-2003.08	Saloon Engine 4G13		◦	GHA228066	K
1.5 16V (69 kW)	1995.12-2003.08	Saloon Engine 4G15	•		GWB3309	
	1995.12-2003.08	Saloon Engine 4G15	•		GWB3940	
	1995.12-2003.08	Saloon Engine 4G15		◦	GHA228020	K
1.6 16V (66 kW)	1995.12-2003.08	Saloon Engine 4G92	•		GWB3309	
	1995.12-2003.08	Saloon Engine 4G92	•		GWB3940	
	1995.12-2003.08	Saloon Engine 4G92		◦	GHA228020	K
2.0 16V EVO (206 kW)	1996.08-2003.08	Saloon Engine 4G63	•		GHA327032	
	1996.08-2003.08	Saloon Engine 4G63		◦	GHA240009	
OUTLANDER I (CU_W)						
2.0 (100 kW)	2003.05-2006.10	Closed Off-Road Vehicle Engine 4G63(DOHC16V)	•		GHA425049	
	2003.05-2006.10	Closed Off-Road Vehicle Engine 4G63(DOHC16V)	•		GWB6926	
	2003.05-2006.10	Closed Off-Road Vehicle Engine 4G63(DOHC16V) With ABS 5 hole		◦	GHA230087	K
2.0 4WD (100 kW)	2003.05-2006.10	Closed Off-Road Vehicle Engine 4G63(DOHC16V)	•		GHA425049	
	2003.05-2006.10	Closed Off-Road Vehicle Engine 4G63(DOHC16V)	•		GWB6926	
	2003.05-2006.10	Closed Off-Road Vehicle Engine 4G63(DOHC16V)		◦	GHA425052	
2.0 4WD (177 kW)	2003.05-2006.10	Closed Off-Road Vehicle Engine 4G63 Turbo	•		GHA425049	
	2003.05-2006.10	Closed Off-Road Vehicle Engine 4G63 Turbo	•		GWB6926	
	2003.05-2006.10	Closed Off-Road Vehicle Engine 4G63 Turbo		◦	GHA425052	
2.0 4WD (93 kW)	2003.05-2006.10	Closed Off-Road Vehicle Engine 4G63(DOHC16V)	•		GHA425049	
	2003.05-2006.10	Closed Off-Road Vehicle Engine 4G63(DOHC16V)	•		GWB6926	
	2003.05-2006.10	Closed Off-Road Vehicle Engine 4G63(DOHC16V)		◦	GHA425052	
2.0 Turbo 4WD (148 kW)	2004.04-2006.10	Closed Off-Road Vehicle Engine 4G63T(DOHC16V)	•		GHA425049	
	2004.04-2006.10	Closed Off-Road Vehicle Engine 4G63T(DOHC16V)	•		GWB6926	
	2004.04-2006.10	Closed Off-Road Vehicle Engine 4G63T(DOHC16V)		◦	GHA425052	
2.4 4WD (102 kW)	2003.05-2006.10	Closed Off-Road Vehicle Engine 4G64(SOHC16V)	•		GHA425049	
	2003.05-2006.10	Closed Off-Road Vehicle Engine 4G64(SOHC16V)	•		GWB6926	
	2003.05-2006.10	Closed Off-Road Vehicle Engine 4G64(SOHC16V)		◦	GHA425052	
2.4 4WD (118 kW)	2003.10-2006.12	Closed Off-Road Vehicle Engine 4G69	•		GHA425049	
	2003.10-2006.12	Closed Off-Road Vehicle Engine 4G69	•		GWB6926	
	2003.10-2006.12	Closed Off-Road Vehicle Engine 4G69		◦	GHA425052	
2.4 4WD (119 kW)	2003.05-2006.10	Closed Off-Road Vehicle Engine 4G69	•		GHA425049	
	2003.05-2006.10	Closed Off-Road Vehicle Engine 4G69	•		GWB6926	
	2003.05-2006.10	Closed Off-Road Vehicle Engine 4G69		◦	GHA425052	
2.4 HDD Mivec (118 kW)	2003.07-2006.09	Closed Off-Road Vehicle Engine 4G69	•		GHA425049	
	2003.07-2006.09	Closed Off-Road Vehicle Engine 4G69		◦	GHA425052	
OUTLANDER II (CW_W)						
2.0 (108 kW)	2006.11-2012.11	Closed Off-Road Vehicle Engine 4B11	•		GHA428015	K
	2006.11-2012.11	Closed Off-Road Vehicle Engine 4B11	•		GWB7408	
	2006.11-2012.11	Closed Off-Road Vehicle Engine 4B11		◦	GHA325029	
	2006.11-2012.11	Closed Off-Road Vehicle Engine 4B11		◦	GHA400176	K
	2006.11-2012.11	Closed Off-Road Vehicle Engine 4B11 With ABS		◦	GHA400072	K
2.0 (118 kW)	2009.06-2012.11	Closed Off-Road Vehicle Engine 4B11	•		GHA428015	K



	 YEAR		F	R	G-AP Ref.	KIT
MITSUBISHI						
OUTLANDER II (CW_W)						
2.0 (118 kW)	2009.06-2012.11	Closed Off-Road Vehicle Engine 4B11	•		GWB7408	
	2009.06-2012.11	Closed Off-Road Vehicle Engine 4B11 With ABS		◦	GHA400072	K
2.0 4WD (108 kW)	2006.11-2012.11	Closed Off-Road Vehicle Engine 4B11	•		GHA428015	K
	2006.11-2012.11	Closed Off-Road Vehicle Engine 4B11	•		GWB7408	
	2006.11-2012.11	Closed Off-Road Vehicle Engine 4B11		◦	GHA325018	K
2.0 Di-D (103 kW)	2007.02-2012.11	Closed Off-Road Vehicle Engine BSY	•		GHA428015	K
	2007.02-2012.11	Closed Off-Road Vehicle Engine BSY	•		GWB7408	
	2007.02-2012.11	Closed Off-Road Vehicle Engine BSY		◦	GHA325018	K
	2007.02-2012.11	Closed Off-Road Vehicle Engine BSY		◦	GHA325029	
	2007.02-2012.11	Closed Off-Road Vehicle Engine BSY		◦	GHA327044	K
2.2 Di-D (130 kW)	2006.11-2012.11	Closed Off-Road Vehicle Engine 4N14		◦	GHA400176	K
2.2 Di-D 4WD (115 kW)	2007.08-2012.11	Closed Off-Road Vehicle Engine 4HK/4HN	•		GHA428015	K
	2007.08-2012.11	Closed Off-Road Vehicle Engine 4HK/4HN	•		GWB7408	
	2007.08-2012.11	Closed Off-Road Vehicle Engine 4HK/4HN		◦	GHA327044	K
2.2 Di-D 4WD (130 kW)	2006.11-2012.11	Closed Off-Road Vehicle Engine 4N14	•		GWB7408	
	2006.11-2012.11	Closed Off-Road Vehicle Engine 4N14		◦	GHA327044	K
2.4 (125 kW)	2006.11-2012.11	Closed Off-Road Vehicle Engine 4B12	•		GHA428015	K
	2006.11-2012.11	Closed Off-Road Vehicle Engine 4B12	•		GWB7408	
	2006.11-2012.11	Closed Off-Road Vehicle Engine 4B12		◦	GHA325018	K
	2006.11-2012.11	Closed Off-Road Vehicle Engine 4B12		◦	GHA327044	K
2.4 4WD (125 kW)	2007.09-2012.11	Closed Off-Road Vehicle Engine 4B12	•		GHA428015	K
	2007.09-2012.11	Closed Off-Road Vehicle Engine 4B12	•		GWB7408	
	2007.09-2012.11	Closed Off-Road Vehicle Engine 4B12		◦	GHA325018	K
	2007.09-2012.11	Closed Off-Road Vehicle Engine 4B12		◦	GHA325029	
	2007.09-2012.11	Closed Off-Road Vehicle Engine 4B12		◦	GHA327044	K
2.4 Flex 4WD (125 kW)	2007.09-2012.11	Closed Off-Road Vehicle Engine 4B12	•		GHA428015	K
3.0 4WD (162 kW)	2006.11-2012.11	Closed Off-Road Vehicle Engine 6B31	•		GHA428015	K
	2006.11-2012.11	Closed Off-Road Vehicle Engine 6B31	•		GWB7408	
	2006.11-2012.11	Closed Off-Road Vehicle Engine 6B31		◦	GHA327044	K
3.0 4WD (177 kW)	2009.10-2012.11	Closed Off-Road Vehicle Engine 6B31	•		GHA428015	K
	2009.10-2012.11	Closed Off-Road Vehicle Engine 6B31	•		GWB7408	
	2009.10-2012.11	Closed Off-Road Vehicle Engine 6B31		◦	GHA327044	K
3.0 FWD (162 kW)	2006.11-2012.11	Closed Off-Road Vehicle Engine 6B31	•		GHA428015	K
	2006.11-2012.11	Closed Off-Road Vehicle Engine 6B31	•		GWB7408	
	2006.11-2012.11	Closed Off-Road Vehicle Engine 6B31		◦	GHA327044	K
OUTLANDER II VAN (CW_W)						
2.0 Di-D (103 kW)	2006.12-2012.11	Box Engine BSY	•		GHA428015	K
OUTLANDER III (GG_W, GF_W, ZJ)						
2.0 (107 kW)	2012.10-	Closed Off-Road Vehicle Engine 4J11	•		GHA428015	K
	2012.10-	Closed Off-Road Vehicle Engine 4J11		◦	GHA325030	
2.0 (110 kW)	2012.08-	Closed Off-Road Vehicle Engine 4J11	•		GHA428015	K
	2012.08-	Closed Off-Road Vehicle Engine 4J11		◦	GHA325030	
2.0 4WD (107 kW)	2012.10-	Closed Off-Road Vehicle Engine 4J11	•		GHA428015	K
	2012.10-	Closed Off-Road Vehicle Engine 4J11		◦	GHA325030	
2.0 4WD (110 kW)	2012.08-	Closed Off-Road Vehicle Engine 4J11	•		GHA428015	K
	2012.08-	Closed Off-Road Vehicle Engine 4J11		◦	GHA325030	
2.0 HybriD 4WD (89 kW)	2012.12-	Closed Off-Road Vehicle Engine 4B11	•		GHA428015	K
	2012.12-	Closed Off-Road Vehicle Engine 4B11		◦	GHA325030	
2.2 Di-D (110 kW)	2012.08-	Closed Off-Road Vehicle Engine 4N14	•		GHA428015	K
	2012.08-	Closed Off-Road Vehicle Engine 4N14		◦	GHA325030	
2.2 Di-D 4WD (110 kW)	2012.08-	Closed Off-Road Vehicle Engine 4N14	•		GHA428015	K
	2012.08-	Closed Off-Road Vehicle Engine 4N14		◦	GHA325030	
2.4 4WD (124 kW)	2012.10-	Closed Off-Road Vehicle Engine 4J12	•		GHA428015	K
	2012.10-	Closed Off-Road Vehicle Engine 4J12		◦	GHA325030	
OUTLANDER III VAN (GF_W, GG_W)						
2.2 Di-D 4WD (110 kW)	2013.04-	Box Engine 4N14	•		GHA428015	K
	2013.04-	Box Engine 4N14		◦	GHA325030	
PAJERO / SHOGUN (L04_G, L14_G)						
2.5 TD (64 kW)	1990.01-1991.12	Closed Off-Road Vehicle Engine 4D56T	•		GWB1915	
	1990.01-1991.12	Closed Off-Road Vehicle Engine 4D56T		◦	GWB1956	
PAJERO / SHOGUN (V2_W, V4_W)						
2.5 TD 4WD (73 kW)	1990.12-2000.04	Open Off-Road Vehicle Engine 4D56TD	•		GWB1915	
	1990.12-2000.04	Open Off-Road Vehicle Engine 4D56TD		◦	GWB3325	



	 YEAR		F	R	G-AP Ref.	KIT
MITSUBISHI						
PAJERO / SHOGUN (V2_W, V4_W)						
3.0 V6 (110 kW)	1990.12-1995.12	Open Off-Road Vehicle Engine 6G72(SOHC12V)	•		GHA250001	
	1990.12-1995.12	Open Off-Road Vehicle Engine 6G72(SOHC12V)	•		GWB1915	
	1990.12-1995.12	Open Off-Road Vehicle Engine 6G72(SOHC12V)		◦	GWB3325	
3.0 V6 24V (133 kW)	1994.06-2000.04	Open Off-Road Vehicle Engine 6G72(SOHC24V)	•		GWB1915	
	1994.06-2000.04	Open Off-Road Vehicle Engine 6G72(SOHC24V)		◦	GWB3325	
PAJERO / SHOGUN CLASSIC (V2_W)						
2.5 TD (85 kW)	2002.07-	Closed Off-Road Vehicle Engine 4D56T	•		GHA250001	
	2002.07-	Closed Off-Road Vehicle Engine 4D56T	•		GWB1915	
	2002.07-	Closed Off-Road Vehicle Engine 4D56T		◦	GWB3325	
PAJERO / SHOGUN II (V3_W, V2_W, V4_W)						
2.5 TD 4WD (73 kW)	1990.12-1999.10	Closed Off-Road Vehicle Engine 4D56T	•		GWB1915	
	1990.12-1999.10	Closed Off-Road Vehicle Engine 4D56T		◦	GWB3325	
2.8 TD (92 kW)	1994.06-1999.10	Closed Off-Road Vehicle Engine 4M40-T	•		GWB1915	
	1994.06-1999.10	Closed Off-Road Vehicle Engine 4M40-T		◦	GWB3325	
3.0 V6 24V (130 kW)	1997.06-1999.10	Closed Off-Road Vehicle Engine 6G72(SOHC24V)	•		GHA250001	
3.0 V6 4WD (110 kW)	1990.12-1995.12	Closed Off-Road Vehicle Engine 6G72(SOHC12V)	•		GHA250001	
PAJERO / SHOGUN III (V6_W, V7_W)						
2.5 TDi (85 kW)	2001.09-2006.12	Open Off-Road Vehicle Engine 4D56T	•		GHA250001	
	2001.09-2006.12	Open Off-Road Vehicle Engine 4D56T	•		GHA330006	K
	2001.09-2006.12	Open Off-Road Vehicle Engine 4D56T		◦	GHA333052	K
3.2 Di-D (118 kW)	2001.10-2006.12	Open Off-Road Vehicle Engine 4M41	•		GHA250001	
	2001.10-2006.12	Open Off-Road Vehicle Engine 4M41	•		GHA330006	K
	2001.10-2006.12	Open Off-Road Vehicle Engine 4M41		◦	GHA333052	K
3.2 Di-D (121 kW)	2000.04-2006.12	Open Off-Road Vehicle Engine 4M41	•		GHA250001	
	2000.04-2006.12	Open Off-Road Vehicle Engine 4M41	•		GHA330006	K
	2000.04-2006.12	Open Off-Road Vehicle Engine 4M41		◦	GHA333052	K
PAJERO / SHOGUN III (V7_W, V6_W)						
3.2 Di-D (118 kW)	2000.04-2006.12	Closed Off-Road Vehicle Engine 4M41	•		GHA250001	
	2000.04-2006.12	Closed Off-Road Vehicle Engine 4M41		◦	GHA333052	K
3.2 Di-D (121 kW)	2000.04-2001.10	Closed Off-Road Vehicle Engine 4M41	•		GHA250001	
	2000.04-2001.10	Closed Off-Road Vehicle Engine 4M41		◦	GHA333052	K
3.5 (149 kW)	2000.04-2007.01	Closed Off-Road Vehicle Engine 6G74(DOHC24V)	•		GHA250001	
	2000.04-2007.01	Closed Off-Road Vehicle Engine 6G74(DOHC24V)		◦	GHA333052	K
PAJERO / SHOGUN IV (V8_W, V9_W)						
3.2 Di-D (118 kW)	2007.02-	Closed Off-Road Vehicle Engine 4M41	•		GHA330006	K
	2007.02-	Closed Off-Road Vehicle Engine 4M41	•		GHA330017	K
	2007.02-	Closed Off-Road Vehicle Engine 4M41	•		GHA330018	K
	2007.02-	Closed Off-Road Vehicle Engine 4M41		◦	GHA254004	K
	2007.02-	Closed Off-Road Vehicle Engine 4M41		◦	GHA333085	K
3.2 Di-D (125 kW)	2007.02-	Closed Off-Road Vehicle Engine 4M41	•		GHA330006	K
	2007.02-	Closed Off-Road Vehicle Engine 4M41	•		GHA330017	K
	2007.02-	Closed Off-Road Vehicle Engine 4M41	•		GHA330018	K
	2007.02-	Closed Off-Road Vehicle Engine 4M41		◦	GHA254004	K
	2007.02-	Closed Off-Road Vehicle Engine 4M41		◦	GHA333085	K
3.2 TD 4WD (147 kW)	2009.01-	Closed Off-Road Vehicle Engine 4M41	•		GHA330006	K
	2009.01-	Closed Off-Road Vehicle Engine 4M41	•		GHA330017	K
	2009.01-	Closed Off-Road Vehicle Engine 4M41	•		GHA330018	K
	2009.01-	Closed Off-Road Vehicle Engine 4M41		◦	GHA254004	K
	2009.01-	Closed Off-Road Vehicle Engine 4M41		◦	GHA333085	K
3.8 V6 (182 kW)	2010.02-	Closed Off-Road Vehicle Engine 6G75	•		GHA330006	K
	2010.02-	Closed Off-Road Vehicle Engine 6G75	•		GHA330017	K
	2010.02-	Closed Off-Road Vehicle Engine 6G75	•		GHA330018	K
	2010.02-	Closed Off-Road Vehicle Engine 6G75		◦	GHA254004	K
	2010.02-	Closed Off-Road Vehicle Engine 6G75		◦	GHA333085	K
3.8 V6 (184 kW)	2007.02-	Closed Off-Road Vehicle Engine 6G75	•		GHA330006	K
	2007.02-	Closed Off-Road Vehicle Engine 6G75	•		GHA330017	K
	2007.02-	Closed Off-Road Vehicle Engine 6G75	•		GHA330018	K
	2007.02-	Closed Off-Road Vehicle Engine 6G75		◦	GHA254004	K
	2007.02-	Closed Off-Road Vehicle Engine 6G75		◦	GHA333085	K
PAJERO CLASSIC (V2_W)						
3.2 Di-D (125 kW)	2006.09-	Closed Off-Road Vehicle Engine 4M41	•		GHA330006	K
	2006.09-	Closed Off-Road Vehicle Engine 4M41		◦	GHA254004	K



	 YEAR		F	R	G-AP Ref.	KIT
MITSUBISHI						
PAJERO III (V6_W, V7_W)						
3.0 (125 kW)	2001.10-2006.12	Open Off-Road Vehicle Engine 6G72 (SOHC 24V)	•		GHA250001	
	2001.10-2006.12	Open Off-Road Vehicle Engine 6G72 (SOHC 24V)		◦	GHA333052	K
3.2 D 4WD (121 kW)	2000.04-2006.12	Open Off-Road Vehicle Engine 4M41	•		GHA250001	
	2000.04-2006.12	Open Off-Road Vehicle Engine 4M41		◦	GHA333052	K
3.5 i (160 kW)	2003.09-2006.1	Open Off-Road Vehicle Engine 6G74 (DOHC 24V)/6G74 (SOHC 24V)		◦	GHA333052	K
PAJERO III (V7_W, V6_W)						
2.5 TDi (73 kW)	2000.04-2006.12	Closed Off-Road Vehicle Engine 4D56 T		◦	GHA333052	K
2.5 TDi (85 kW)	2001.09-2006.12	Closed Off-Road Vehicle Engine 4D56 T		◦	GHA333052	K
PAJERO III CANVAS TOP (V6_W, V7_W)						
2.5 TDi (73 kW)	2000.04-2006.12	Open Off-Road Vehicle Engine 4D56T	•		GHA250001	
	2000.04-2006.12	Open Off-Road Vehicle Engine 4D56T	•		GHA330006	K
	2000.04-2006.12	Open Off-Road Vehicle Engine 4D56T		◦	GHA333052	K
3.5 V6 GDi (149 kW)	2000.04-2006.12	Open Off-Road Vehicle Engine 6G74(DOHC24V)/6G74(SOHC24V)	•		GHA250001	
	2000.04-2006.12	Open Off-Road Vehicle Engine 6G74(DOHC24V)/6G74(SOHC24V)	•		GHA330006	K
	2000.04-2006.12	Open Off-Road Vehicle Engine 6G74(DOHC24V)/6G74(SOHC24V)		◦	GHA333052	K
PAJERO IV (V8_W, V9_W)						
3.2 Di-D (121 kW)	2010.01-	Closed Off-Road Vehicle Engine 4M41	•		GHA330017	K
	2010.01-	Closed Off-Road Vehicle Engine 4M41		◦	GHA333085	
3.2 Di-D 4WD (140 kW)	2007.02-	Closed Off-Road Vehicle Engine 4M41	•		GHA330017	K
	2007.02-	Closed Off-Road Vehicle Engine 4M41		◦	GHA333085	
PAJERO MINI (H5_A)						
0.7 (37 kW)	1994.10-1998.08	Closed Off-Road Vehicle Engine 4A30	•		GHA425051	
0.7 (38 kW)	1994.10-2012.08	Closed Off-Road Vehicle Engine 4A30	•		GHA425051	
0.7 4WD (37 kW)	1994.10-1998.08	Closed Off-Road Vehicle Engine 4A30	•		GHA425051	
0.7 4WD (38 kW)	1994.10-2012.08	Closed Off-Road Vehicle Engine 4A30	•		GHA425051	
0.7 4WD (47 kW)	1994.10-2012.08	Closed Off-Road Vehicle Engine 4A30T	•		GHA425051	
PAJERO SPORT II (KH_, KG_)						
2.5 Di-D (131 kW)	2008.07-	Closed Off-Road Vehicle Engine 4D56 HP	•		GHA250011	
	2008.07-	Closed Off-Road Vehicle Engine 4D56 HP	•		GHA330007	
2.5 Di-D 4WD (131 kW)	2008.07-	Closed Off-Road Vehicle Engine 4D56 HP	•		GHA250011	
	2008.07-	Closed Off-Road Vehicle Engine 4D56 HP	•		GHA330007	
2.5 TD (98 kW)	2008.09-	Closed Off-Road Vehicle Engine 4D56 T	•		GHA250011	
	2008.09-	Closed Off-Road Vehicle Engine 4D56 T	•		GHA330007	
3.0 4WD (162 kW)	2008.09-	Closed Off-Road Vehicle Engine 6B31	•		GHA250011	
	2008.09-	Closed Off-Road Vehicle Engine 6B31	•		GHA330007	
3.2 Di-D 4WD (118 kW)	2008.07-	Closed Off-Road Vehicle Engine 4M41	•		GHA250011	
	2008.07-	Closed Off-Road Vehicle Engine 4M41	•		GHA330007	
3.5 (137 kW)	2010.01-	Closed Off-Road Vehicle Engine 6G74 (DOHC 24V)/6G74 (SOHC 24V)	•		GHA250011	
	2010.01-	Closed Off-Road Vehicle Engine 6G74 (DOHC 24V)/6G74 (SOHC 24V)	•		GHA330007	
3.5 V6 24V (153 kW)	2008.09-	Closed Off-Road Vehicle Engine 6G74 (SOHC 24V)	•		GHA250011	
	2008.09-	Closed Off-Road Vehicle Engine 6G74 (SOHC 24V)	•		GHA330007	
RAIDER						
-	2006-2008		•		GHA333090	
SHOGUN PININ (H6_W, H7_W)						
1.8 (84 kW)	2001.11-2007.06	Closed Off-Road Vehicle Engine 4G93	•		GHA425051	
	2001.11-2007.06	Closed Off-Road Vehicle Engine 4G93	•		GWB3940	
1.8 GDi (88 kW)	1999.10-2007.06	Closed Off-Road Vehicle Engine 4G93	•		GHA425051	
	1999.10-2007.06	Closed Off-Road Vehicle Engine 4G93	•		GWB3309	
	1999.10-2007.06	Closed Off-Road Vehicle Engine 4G93	•		GWB3940	
2.0 GDi (95 kW)	2000.10-2007.06	Closed Off-Road Vehicle Engine 4G94	•		GHA425051	
SIGMA (F2_A, F1_A)						
3.0 V6 (130 kW)	1990.12-1996.07	Saloon Engine 6G72		◦	GHA233003	
3.0 V6 (151 kW)	1990.12-1996.07	Saloon Engine 6G72(DOHC24V)		◦	GHA233003	
SIGMA STATION WAGON (F0_W)						
3.0 (125 kW)	1992.06-1996.10	Estate Engine 6G72(SOHC12V)		◦	GHA233003	
SPACE RUNNER (N1_W, N2_W)						
1.8 (90 kW)	1991.10-1999.08	MPV Engine 4G93	•		GWB1970	
1.8 4WD (90 kW)	1991.10-1999.08	MPV Engine 4G93	•		GWB1970	
2.0 TD (60 kW)	1992.10-1999.08	MPV Engine 4D68T	•		GWB1970	
SPACE STAR (DG_A)						
1.3 16V (60 kW)	2000.09-2004.12	MPV Engine 4G13	•		GWB6845	
	2000.09-2004.12	MPV Engine 4G13	•		GWB6913	



	 YEAR		F	R	G-AP Ref.	KIT
MITSUBISHI						
SPACE STAR (DG_A)						
1.3 16V (60 kW)	2000.09-2004.12	MPV Engine 4G13		o	GHA230053	
1.3 16V (61 kW)	1998.12-2004.12	MPV Engine 4G13	•		GWB6845	
	1998.12-2004.12	MPV Engine 4G13	•		GWB6913	
	1998.12-2004.12	MPV Engine 4G13		o	GHA230053	
1.3 16V (63 kW)	1998.06-2004.12	MPV Engine 4G13	•		GWB6845	
	1998.06-2004.12	MPV Engine 4G13	•		GWB6913	
	1998.06-2004.12	MPV Engine 4G13		o	GHA230053	
1.6 16V (72 kW)	2001.01-2004.12	MPV Engine 4G18	•		GWB6913	
	2001.01-2004.12	MPV Engine 4G18		o	GHA230053	
1.8 GDi (87 kW)	1998.06-2004.12	MPV Engine 4G93	•		GWB6845	
	1998.06-2004.12	MPV Engine 4G93	•		GWB6913	
	1998.06-2004.12	MPV Engine 4G93		o	GHA230053	
1.8 GDi (90 kW)	1998.06-2004.12	MPV Engine 4G93	•		GWB6845	
	1998.06-2004.12	MPV Engine 4G93	•		GWB6913	
	1998.06-2004.12	MPV Engine 4G93		o	GHA230053	
1.8 MPI (82 kW)	2002.10-2004.12	MPV Engine 4G93	•		GWB6913	
	2002.10-2004.12	MPV Engine 4G93		o	GHA230053	
1.9 Di-D (75 kW)	2001.02-2004.12	MPV Engine F9Q1	•		GWB6845	
	2001.02-2004.12	MPV Engine F9Q1	•		GWB6913	
	2001.02-2004.12	MPV Engine F9Q1		o	GHA230053	
1.9 Di-D (85 kW)	2002.10-2004.12	MPV Engine F9Q2	•		GWB6913	
	2002.10-2004.12	MPV Engine F9Q2		o	GHA230053	
SPACE WAGON (N3_W, N4_W)						
1.8 (90 kW)	1991.10-1998.10	MPV Engine 4G93	•		GWB1970	
	1991.10-1998.10	MPV Engine 4G93 With ABS 4 hole		o	GHA230081	K
	1991.10-1998.10	MPV Engine 4G93 Without ABS 4 hole		o	GHA230040	K
1.8 4WD (90 kW)	1991.10-1998.10	MPV Engine 4G93	•		GWB1970	
1.8 TD (55 kW)	1991.10-1998.10	MPV Engine 4D65T	•		GWB1970	
	1991.10-1998.10	MPV Engine 4D65T With ABS 4 hole		o	GHA230081	K
	1991.10-1998.10	MPV Engine 4D65T Without ABS 4 hole		o	GHA230040	K
2.0 (98 kW)	1992.10-1998.10	MPV Engine 4G63(DOHC16V)	•		GWB1970	
	1992.10-1998.10	MPV Engine 4G63(DOHC16V) With ABS 4 hole		o	GHA230081	K
	1992.10-1998.10	MPV Engine 4G63(DOHC16V) Without ABS 4 hole		o	GHA230040	K
2.0 4WD (98 kW)	1992.10-1998.10	MPV Engine 4G63(DOHC16V)	•		GWB1970	
2.0 TD (60 kW)	1992.10-1998.10	MPV Engine 4D68T	•		GWB1970	
	1992.10-1998.10	MPV Engine 4D68T With ABS 4 hole		o	GHA230081	K
	1992.10-1998.10	MPV Engine 4D68T Without ABS 4 hole		o	GHA230040	K
SPACE WAGON (N9_W, N8_W)						
2.0 GDi (98 kW)	1998.10-2004.12	MPV Engine 4G63(SOHC16V)	•		GHA325001	
2.4 GDi (108 kW)	2000.09-2004.12	MPV Engine 4G64	•		GHA325001	
	2000.09-2004.12	MPV Engine 4G64		o	GHA230108	K
2.4 GDi (110 kW)	1998.10-2004.12	MPV Engine 4G64	•		GHA325001	
	1998.10-2004.12	MPV Engine 4G64		o	GHA230108	K
NISSAN						
100 NX (B13)						
1.6 (66 kW)	1990.03-1994.10	Coupe Engine GA16DS		o	GHA227007	
	1990.03-1994.10	Coupe Engine GA16DS With ABS		o	GHA227010	
1.6 SR (75 kW)	1993.09-1994.10	Coupe Engine GA16DE		o	GHA227007	
	1993.09-1994.10	Coupe Engine GA16DE With ABS		o	GHA227010	
2.0 GTi (105 kW)	1991.03-1994.10	Coupe Engine SR20DE With ABS		o	GHA227010	
200 SX (S13)						
1.8 Turbo (122 kW)	1992.01-1994.09	Coupe Engine CA18DT		o	GHA243005	
200 SX (S14)						
2.0 i 16V (118 kW)	1993.10-1999.12	Coupe Engine SR20DE		o	GHA243005	
2.0 i 16V Turbo (147 kW)	1993.10-1999.12	Coupe Engine SR20DET	•		GHA234010	
	1993.10-1999.12	Coupe Engine SR20DET		o	GHA243005	
2.0 Turbo (162 kW)	1994.04-1999.09	Coupe Engine SR20DET		o	GHA243005	
240 SX						
2.4 (112 kW)	1994.05-1997.08	Coupe Engine KA24DE		o	GHA243005	
2.4 (115 kW)	1993.04-1994.09	Coupe Engine KA24DE		o	GHA243005	
350 Z (Z33)						
3.5 (206 kW)	2003.03-2006.03	Coupe Engine VQ35DE	•		GHA400247	



	 YEAR		F	R	G-AP Ref.	KIT
NISSAN						
350 Z (Z33)						
3.5 (206 kW)	2003.03-2006.03	Coupe Engine VQ35DE		o	GHA243006	K
	2003.03-2006.03	Coupe Engine VQ35DE		o	GHA429003	
3.5 (214 kW)	2004.11-2007.01	Coupe Engine VQ35DE	•		GHA400247	
	2004.11-2007.01	Coupe Engine VQ35DE		o	GHA243006	K
	2004.11-2007.01	Coupe Engine VQ35DE		o	GHA429003	
3.5 (221 kW)	2005.01-2007.07	Coupe Engine VQ35DE	•		GHA400247	
	2005.01-2007.07	Coupe Engine VQ35DE		o	GHA243006	K
	2005.01-2007.07	Coupe Engine VQ35DE		o	GHA429003	
3.5 (230 kW)	2005.09-	Coupe Engine VQ35HR	•		GHA400247	
	2005.09-	Coupe Engine VQ35HR		o	GHA243006	K
	2005.09-	Coupe Engine VQ35HR		o	GHA429003	
350 Z ROADSTER (Z33)						
3.5 (206 kW)	2004.10-2006.03	Convertible Engine VQ35DE	•		GHA400247	
	2004.10-2006.03	Convertible Engine VQ35DE		o	GHA243006	K
	2004.10-2006.03	Convertible Engine VQ35DE		o	GHA429003	
3.5 (221 kW)	2006.03-2007.07	Convertible Engine VQ35DE	•		GHA400247	
	2006.03-2007.07	Convertible Engine VQ35DE		o	GHA243006	K
	2006.03-2007.07	Convertible Engine VQ35DE		o	GHA429003	
3.5 (230 kW)	2005.09-	Convertible Engine VQ35HR	•		GHA400247	
	2005.09-	Convertible Engine VQ35HR		o	GHA243006	K
	2005.09-	Convertible Engine VQ35HR		o	GHA429003	
370 Z (Z34)						
3.7 (241 kW)	2009.06-	Coupe Engine VQ37VHR	•		GHA400203	
	2009.06-	Coupe Engine VQ37VHR		o	GHA332011	
3.7 (243 kW)	2009.06-	Coupe Engine VQ37HR		o	GHA332011	
3.7 (245 kW)	2013.01-	Coupe Engine VQ37VHR	•		GHA400203	
3.7 (248 kW)	2009.04-	Coupe Engine VQ37VHR	•		GHA400203	
370 Z ROADSTER (Z34)						
3.7 (241 kW)	2010.01-	Convertible Engine VQ37VHR	•		GHA400203	
3.7 (243 kW)	2010.01-	Convertible Engine VQ37VHR	•		GHA400203	
	2010.01-	Convertible Engine VQ37VHR		o	GHA332011	
ALMERA (N15)						
1.4 (64 kW)	1995.09-2000.03	Hatchback Engine GA14DE	•		GHA425017	
	1995.09-2000.03	Hatchback Engine GA14DE	•		GWB3201	
	1995.09-2000.03	Hatchback Engine GA14DE		o	GHA227007	
	1995.09-2000.03	Hatchback Engine GA14DE With ABS		o	GHA227006	
	1995.09-2000.03	Hatchback Engine GA14DE Without ABS		o	GHA227001	K
	1995.09-2000.03	Hatchback Engine GA14DE Without ABS		o	GHA227001	K
	1995.09-2000.07	Saloon Engine GA14DE	•		GHA425017	
	1995.09-2000.07	Saloon Engine GA14DE	•		GWB3201	
	1995.09-2000.07	Saloon Engine GA14DE		o	GHA227007	
	1995.09-2000.07	Saloon Engine GA14DE With ABS		o	GHA227006	
	1995.09-2000.07	Saloon Engine GA14DE Without ABS		o	GHA227001	K
	1995.09-2000.07	Saloon Engine GA14DE Without ABS		o	GHA227001	K
	1.4 GX,LX (55 kW)	1995.09-2000.07	Saloon Engine GA14DE	•		GWB3201
1995.09-2000.07		Saloon Engine GA14DE With ABS		o	GHA227006	
1995.09-2000.07		Saloon Engine GA14DE Without ABS		o	GHA227001	K
1995.09-2000.07		Saloon Engine GA14DE Without ABS		o	GHA227001	K
1995.09-2000.07		Saloon Engine GA14DE Without ABS		o	GHA227001	K
1.4 S,GX,LX (55 kW)	1995.09-2000.03	Hatchback Engine GA14DE	•		GWB3201	
	1995.09-2000.03	Hatchback Engine GA14DE With ABS		o	GHA227006	
	1995.09-2000.03	Hatchback Engine GA14DE Without ABS		o	GHA227001	K
	1995.09-2000.03	Hatchback Engine GA14DE Without ABS		o	GHA227001	K
	1995.09-2000.03	Hatchback Engine GA14DE Without ABS		o	GHA227001	K
1.6 (73 kW)	1995.09-2000.03	Hatchback Engine GA16DE	•		GHA425017	
	1995.09-2000.03	Hatchback Engine GA16DE	•		GWB3201	
	1995.09-2000.03	Hatchback Engine GA16DE		o	GHA227007	
	1995.09-2000.03	Hatchback Engine GA16DE With ABS		o	GHA227006	
	1995.09-2000.03	Hatchback Engine GA16DE Without ABS		o	GHA227001	K
	1995.09-2000.03	Hatchback Engine GA16DE Without ABS		o	GHA227001	K
	1995.09-2000.07	Saloon Engine GA16DE	•		GHA425017	
	1995.09-2000.07	Saloon Engine GA16DE	•		GWB3201	
	1995.09-2000.07	Saloon Engine GA16DE		o	GHA227007	
	1995.09-2000.07	Saloon Engine GA16DE With ABS		o	GHA227006	
	1995.09-2000.07	Saloon Engine GA16DE Without ABS		o	GHA227001	K
	1995.09-2000.07	Saloon Engine GA16DE Without ABS		o	GHA227001	K



	 YEAR		F	R	G-AP Ref.	KIT
NISSAN						
ALMERA (N15)						
1.6 (75 kW)	1995.07-2000.03	Hatchback Engine GA16DE	•		GHA425017	
	1995.07-2000.03	Hatchback Engine GA16DE	•		GWB3201	
	1995.07-2000.03	Hatchback Engine GA16DE		○	GHA227007	
	1995.07-2000.03	Hatchback Engine GA16DE With ABS		○	GHA227006	
	1995.07-2000.03	Hatchback Engine GA16DE Without ABS		○	GHA227001	K
	1995.07-2000.03	Hatchback Engine GA16DE Without ABS		○	GHA227001	K
	1995.07-2000.03	Saloon Engine GA16DE	•		GHA425017	
	1995.07-2000.03	Saloon Engine GA16DE	•		GWB3201	
	1995.07-2000.03	Saloon Engine GA16DE		○	GHA227007	
	1995.07-2000.03	Saloon Engine GA16DE With ABS		○	GHA227006	
	1995.07-2000.03	Saloon Engine GA16DE Without ABS		○	GHA227001	K
	1995.07-2000.03	Saloon Engine GA16DE Without ABS		○	GHA227001	K
1.6 SLX (66 kW)	1995.09-2000.07	Saloon Engine GA16DE	•		GWB3201	
	1995.09-2000.07	Saloon Engine GA16DE With ABS		○	GHA227006	
	1995.09-2000.07	Saloon Engine GA16DE Without ABS		○	GHA227001	K
	1995.09-2000.07	Saloon Engine GA16DE Without ABS		○	GHA227001	K
1.6 SR,SLX (66 kW)	1995.09-2000.03	Hatchback Engine GA16DE	•		GWB3201	
	1995.09-2000.03	Hatchback Engine GA16DE With ABS		○	GHA227006	
	1995.09-2000.03	Hatchback Engine GA16DE Without ABS		○	GHA227001	K
	1995.09-2000.03	Hatchback Engine GA16DE Without ABS		○	GHA227001	K
2.0 D (55 kW)	1995.11-2000.03	Hatchback Engine CD20	•		GHA425017	
	1995.11-2000.03	Hatchback Engine CD20	•		GWB3201	
	1995.11-2000.03	Hatchback Engine CD20		○	GHA227007	
	1995.11-2000.03	Hatchback Engine CD20 With ABS		○	GHA227006	
	1995.11-2000.03	Hatchback Engine CD20 Without ABS		○	GHA227001	K
	1995.11-2000.03	Hatchback Engine CD20 Without ABS		○	GHA227001	K
	1995.11-2000.07	Saloon Engine CD20	•		GHA425017	
	1995.11-2000.07	Saloon Engine CD20	•		GWB3201	
	1995.11-2000.07	Saloon Engine CD20		○	GHA227007	
	1995.11-2000.07	Saloon Engine CD20 With ABS		○	GHA227006	
	1995.11-2000.07	Saloon Engine CD20 Without ABS		○	GHA227001	K
	1995.11-2000.07	Saloon Engine CD20 Without ABS		○	GHA227001	K
2.0 GTi (105 kW)	1996.07-2000.03	Hatchback Engine SR20DE	•		GHA425017	
	1996.07-2000.03	Hatchback Engine SR20DE	•		GWB3201	
	1996.07-2000.03	Hatchback Engine SR20DE With ABS		○	GHA227006	
ALMERA I (N15)						
1.5 (77 kW)	1995.07-2000.03	Hatchback Engine GA15DE With ABS		○	GHA227006	
	1995.07-2000.05	Saloon Engine GA15DE With ABS		○	GHA227006	
ALMERA II (N16)						
1.5 (66 kW)	2000.03-	Hatchback Engine QG15DE	•		GHA425018	K
	2000.03-	Hatchback Engine QG15DE	•		GWB3272	
	2000.03-	Hatchback Engine QG15DE		○	GHA227011	
	2000.03-	Hatchback Engine QG15DE		○	GHA227015	
	2000.03-	Hatchback Engine QG15DE		○	GHA227019	
	2000.03-	Hatchback Engine QG15DE		○	GHA230080	K
	2000.03-	Hatchback Engine QG15DE		○	GHA230094	K
	2000.03-	Hatchback Engine QG15DE With ABS		○	GHA227004	K
	2000.03-	Hatchback Engine QG15DE With ABS		○	GHA230039	K
	2000.03-	Hatchback Engine QG15DE Without ABS		○	GHA230070	
	2000.07-	Saloon Engine QG15DE	•		GHA425018	K
	2000.07-	Saloon Engine QG15DE	•		GWB3272	
	2000.07-	Saloon Engine QG15DE		○	GHA227011	
	2000.07-	Saloon Engine QG15DE		○	GHA227015	
	2000.07-	Saloon Engine QG15DE		○	GHA227019	
	2000.07-	Saloon Engine QG15DE		○	GHA230080	K
	2000.07-	Saloon Engine QG15DE		○	GHA230094	K
	2000.07-	Saloon Engine QG15DE With ABS		○	GHA227004	K
	2000.07-	Saloon Engine QG15DE With ABS		○	GHA230039	K
	2000.07-	Saloon Engine QG15DE Without ABS		○	GHA230070	
1.5 (72 kW)	2002.09-2007.05	Saloon Engine QG15DE	•		GHA425018	K
	2002.09-2007.05	Saloon Engine QG15DE	•		GWB3991	
	2002.09-2007.05	Saloon Engine QG15DE		○	GHA227015	
	2002.09-2007.05	Saloon Engine QG15DE		○	GHA227019	
	2002.09-2007.05	Saloon Engine QG15DE		○	GHA230080	K



	 YEAR		F	R	G-AP Ref.	KIT
NISSAN						
ALMERA II (N16)						
1.5 (72 kW)	2002.09-2007.05	Saloon Engine QG15DE		o	GHA230094	K
	2002.09-2007.05	Saloon Engine QG15DE With ABS		o	GHA227004	K
	2002.09-2007.05	Saloon Engine QG15DE With ABS		o	GHA230039	K
	2002.09-2007.05	Saloon Engine QG15DE Without ABS		o	GHA230070	
	2003.03-2004.10	Hatchback Engine QG15DE	•		GHA425018	K
	2003.03-2004.10	Hatchback Engine QG15DE	•		GWB3272	
	2003.03-2004.10	Hatchback Engine QG15DE		o	GHA227015	
	2003.03-2004.10	Hatchback Engine QG15DE		o	GHA227019	
	2003.03-2004.10	Hatchback Engine QG15DE		o	GHA230080	K
	2003.03-2004.10	Hatchback Engine QG15DE		o	GHA230094	K
	2003.03-2004.10	Hatchback Engine QG15DE With ABS		o	GHA227004	K
	2003.03-2004.10	Hatchback Engine QG15DE With ABS		o	GHA230039	K
2003.03-2004.10	Hatchback Engine QG15DE Without ABS		o	GHA230070		
1.5 DCi (60 kW)	2003.01-	Hatchback Engine K9K722	•		GHA425018	K
	2003.01-	Hatchback Engine K9K722	•		GWB3272	
	2003.01-	Hatchback Engine K9K722		o	GHA230080	K
	2003.01-	Hatchback Engine K9K722 With ABS		o	GHA230039	K
	2003.01-	Saloon Engine K9K722	•		GHA425018	K
	2003.01-	Saloon Engine K9K722	•		GWB3272	
	2003.01-	Saloon Engine K9K722		o	GHA230080	K
	2003.01-	Saloon Engine K9K722 With ABS		o	GHA230039	K
1.6 (83 kW)	2000.07-2003.02	Saloon Engine GA16DE/QG16DE	•		GHA425018	K
	2000.07-2003.02	Saloon Engine GA16DE/QG16DE		o	GHA227011	
	2000.07-2003.02	Saloon Engine GA16DE/QG16DE With ABS		o	GHA227004	K
1.8 (84 kW)	2000.01-	Hatchback Engine QG18DE	•		GHA425018	K
	2000.01-	Hatchback Engine QG18DE	•		GWB3272	
	2000.01-	Hatchback Engine QG18DE		o	GHA227011	
	2000.01-	Hatchback Engine QG18DE		o	GHA227015	
	2000.01-	Hatchback Engine QG18DE		o	GHA227019	
	2000.01-	Hatchback Engine QG18DE		o	GHA230080	K
	2000.01-	Hatchback Engine QG18DE		o	GHA230094	K
	2000.01-	Hatchback Engine QG18DE With ABS		o	GHA227004	K
	2000.01-	Hatchback Engine QG18DE With ABS		o	GHA230039	K
	2000.01-	Hatchback Engine QG18DE Without ABS		o	GHA230070	
	2000.07-	Saloon Engine QG18DE	•		GHA425018	K
	2000.07-	Saloon Engine QG18DE	•		GWB3272	
	2000.07-	Saloon Engine QG18DE		o	GHA227011	
	2000.07-	Saloon Engine QG18DE		o	GHA227015	
	2000.07-	Saloon Engine QG18DE		o	GHA227019	
	2000.07-	Saloon Engine QG18DE		o	GHA230080	K
	2000.07-	Saloon Engine QG18DE		o	GHA230094	K
	2000.07-	Saloon Engine QG18DE With ABS		o	GHA227004	K
	2000.07-	Saloon Engine QG18DE With ABS		o	GHA230039	K
	2000.07-	Saloon Engine QG18DE Without ABS		o	GHA230070	
1.8 (85 kW)	2002.09-2007.05	Hatchback Engine QG18DE	•		GHA425018	K
	2002.09-2007.05	Hatchback Engine QG18DE	•		GWB3272	
	2002.09-2007.05	Hatchback Engine QG18DE		o	GHA227015	
	2002.09-2007.05	Hatchback Engine QG18DE		o	GHA230080	K
	2002.09-2007.05	Hatchback Engine QG18DE With ABS		o	GHA227004	K
	2002.09-2007.05	Hatchback Engine QG18DE With ABS		o	GHA230039	K
	2002.09-2007.05	Hatchback Engine QG18DE Without ABS		o	GHA230070	
	2002.09-2007.05	Saloon Engine QG18DE	•		GHA425018	K
	2002.09-2007.05	Saloon Engine QG18DE	•		GWB3272	
	2002.09-2007.05	Saloon Engine QG18DE		o	GHA227015	
	2002.09-2007.05	Saloon Engine QG18DE		o	GHA230080	K
	2002.09-2007.05	Saloon Engine QG18DE With ABS		o	GHA227004	K
	2002.09-2007.05	Saloon Engine QG18DE With ABS		o	GHA230039	K
	2002.09-2007.05	Saloon Engine QG18DE Without ABS		o	GHA230070	
	1.8 (94 kW)	2002.08-	Hatchback Engine QA18DE	•		GHA425018
2002.08-		Hatchback Engine QA18DE	•		GWB3272	
2002.08-		Hatchback Engine QA18DE With ABS		o	GHA227004	K
2.2 DCi (100 kW)	2003.02-2007.05	Hatchback Engine YD22DDTi	•		GWB3272	
	2003.02-2007.05	Hatchback Engine YD22DDTi		o	GHA227019	
	2003.02-2007.05	Hatchback Engine YD22DDTi		o	GHA230094	K



	 YEAR		F	R	G-AP Ref.	KIT
NISSAN						
ALMERA II (N16)						
2.2 DCi (100 kW)	2003.02-2007.05	Hatchback Engine YD22DDTi With ABS		o	GHA230039	K
	2003.03-2004.08	Saloon Engine YD22DDTi	•		GWB3272	
	2003.03-2004.08	Saloon Engine YD22DDTi		o	GHA227019	
	2003.03-2004.08	Saloon Engine YD22DDTi		o	GHA230094	K
	2003.03-2004.08	Saloon Engine YD22DDTi With ABS		o	GHA230039	K
2.2 DCi (82 kW)	2002.09-2007.05	Saloon Engine YD22DDT	•		GWB3272	
	2002.09-2007.05	Saloon Engine YD22DDT		o	GHA227019	
	2002.09-2007.05	Saloon Engine YD22DDT		o	GHA230094	K
	2002.09-2007.05	Saloon Engine YD22DDT With ABS		o	GHA230039	K
	2003.03-2007.05	Hatchback Engine YD22DDT	•		GWB3272	
	2003.03-2007.05	Hatchback Engine YD22DDT		o	GHA227019	
	2003.03-2007.05	Hatchback Engine YD22DDT		o	GHA230094	K
	2003.03-2007.05	Hatchback Engine YD22DDT With ABS		o	GHA230039	K
	2.2 Di (81 kW)	2000.03-	Hatchback Engine YD22DDT	•		GWB3272
2000.03-		Hatchback Engine YD22DDT		o	GHA227011	
2000.03-		Hatchback Engine YD22DDT		o	GHA227015	
2000.03-		Hatchback Engine YD22DDT		o	GHA227019	
2000.03-		Hatchback Engine YD22DDT		o	GHA230080	K
2000.03-		Hatchback Engine YD22DDT		o	GHA230094	K
2000.03-		Hatchback Engine YD22DDT With ABS		o	GHA230039	K
2000.03-		Hatchback Engine YD22DDT Without ABS		o	GHA230070	
2000.07-		Saloon Engine YD22DDT	•		GWB3272	
2000.07-		Saloon Engine YD22DDT		o	GHA227011	
2000.07-		Saloon Engine YD22DDT		o	GHA227015	
2000.07-		Saloon Engine YD22DDT		o	GHA227019	
2000.07-		Saloon Engine YD22DDT		o	GHA230080	K
2000.07-		Saloon Engine YD22DDT		o	GHA230094	K
2000.07-		Saloon Engine YD22DDT With ABS		o	GHA230039	K
2000.07-		Saloon Engine YD22DDT Without ABS		o	GHA230070	
ALMERA TINO (V10)						
1.8 (84 kW)	2000.08-	MPV Engine QG18DE	•		GHA427017	
	2000.08-	MPV Engine QG18DE	•		GWB3981	
	2000.08-	MPV Engine QG18DE		o	GHA230004	
	2000.08-	MPV Engine QG18DE With ABS		o	GHA230052	K
1.8 (85 kW)	2003.03-2006.03	MPV Engine QG18DE	•		GHA427017	
	2003.03-2006.03	MPV Engine QG18DE	•		GWB3981	
	2003.03-2006.03	MPV Engine QG18DE		o	GHA230004	
	2003.03-2006.03	MPV Engine QG18DE With ABS		o	GHA230052	K
2.0 (100 kW)	2000.08-	MPV Engine SR20DE	•		GHA427017	
	2000.08-	MPV Engine SR20DE	•		GWB3981	
	2000.08-	MPV Engine SR20DE		o	GHA230004	
	2000.08-	MPV Engine SR20DE With ABS		o	GHA230052	K
2.2 DCi (100 kW)	2003.03-2006.03	MPV Engine YD22DDTi	•		GHA427017	
	2003.03-2006.03	MPV Engine YD22DDTi	•		GWB3981	
	2003.03-2006.03	MPV Engine YD22DDTi		o	GHA230004	
	2003.03-2006.03	MPV Engine YD22DDTi With ABS		o	GHA230052	K
2.2 DCi (82 kW)	2003.03-2006.03	MPV Engine YD22DDT	•		GWB3981	
	2003.03-2006.03	MPV Engine YD22DDT With ABS		o	GHA230052	K
2.2 Di (84 kW)	2000.08-	MPV Engine YD22DDTi	•		GHA427017	
	2000.08-	MPV Engine YD22DDTi	•		GWB3981	
	2000.08-	MPV Engine YD22DDTi		o	GHA230004	
	2000.08-	MPV Engine YD22DDTi With ABS		o	GHA230052	K
ALTIMA						
3.5 (180 kW)	2001.08-2006.09	Saloon Engine VQ35DE	•		GHA429002	K
3.5 (201 kW)	2006.10-	Saloon Engine VQ35DE	•		GHA332024	
ARMADA						
5.6 (227 kW)	2003.08-2006.12	Closed Off-Road Vehicle Engine VK56DE	•		GHA329017	
	2003.08-2006.12	Closed Off-Road Vehicle Engine VK56DE		o	GHA332014	
5.6 4x4 (227 kW)	2003.08-2006.12	Closed Off-Road Vehicle Engine VK56DE	•		GHA329017	
	2003.08-2006.12	Closed Off-Road Vehicle Engine VK56DE		o	GHA332014	
AVENIR						
1.8 (92 kW)	1997.11-	Estate Engine QG18DE		o	GHA230152	
2.0 4x4 (107 kW)	1997.11-2005.12	Estate Engine SR20DE	•		GWB1999	



	 YEAR		F	R	G-AP Ref.	KIT
NISSAN						
BASSARA JU30						
-	1999-2003			o	GHA234011	
CEDRIC X (Y34)						
2.5 (147 kW)	2000.05-2004.08	Saloon Engine VQ25DD		o	GHA429003	
3.0 Ultima (206 kW)	2000.08-2004.08	Saloon Engine VQ30DET		o	GHA429003	
CEFIRO I (J31)						
2.0 (103 kW)	2000.01-	Saloon Engine VQ20DE	•		GHA329001	K
2.3 (127 kW)	2004.09-	Saloon Engine VQ23DE	•		GHA329001	K
3.5 (221 kW)	2000.01-2003.09	Saloon Engine VQ35DE	•		GHA329001	K
CUBE (Z11)						
1.4 (72 kW)	2003.01-2005.09	Hatchback Engine CR14DE	•		GHA425041	K
	2003.01-2005.09	Hatchback Engine CR14DE		o	GHA400180	
1.5 (80 kW)	2003.01-2005.09	Hatchback Engine HR15DE	•		GHA425041	K
	2003.01-2005.09	Hatchback Engine HR15DE		o	GHA400180	
CUBE (Z12)						
1.5 DCi (78 kW)	2010.03-	Hatchback		o	GHA400356	
	2010.03-	Hatchback With ABS	•		GHA325016	K
	2010.03-	Hatchback With ABS	•		GHA325016	K
1.5 DCi (81 kW)	2010.03-	Hatchback		o	GHA400009	
	2010.03-	Hatchback		o	GHA400356	
	2010.03-	Hatchback With ABS	•		GHA325016	K
	2010.03-	Hatchback With ABS	•		GHA325016	K
1.6 16V (81 kW)	2010.03-	Hatchback Engine HR16DE		o	GHA400009	
	2010.03-	Hatchback Engine HR16DE		o	GHA400356	
	2010.03-	Hatchback Engine HR16DE With ABS	•		GHA325016	K
	2010.03-	Hatchback Engine HR16DE With ABS	•		GHA325016	K
ELGRAND (E51)						
2.5 (137 kW)	2004.12-2010.12	MPV Engine VQ25DE	•		GHA251004	
	2004.12-2010.12	MPV Engine VQ25DE		o	GHA250010	
	2004.12-2010.12	MPV Engine VQ25DE		o	GHA429006	
2.5 AWD (137 kW)	2004.12-2010.12	MPV Engine VQ25DE	•		GHA251004	
	2004.12-2010.12	MPV Engine VQ25DE		o	GHA250010	
	2004.12-2010.12	MPV Engine VQ25DE		o	GHA429006	
3.5 (177 kW)	2002.05-2010.12	MPV Engine VQ35DE	•		GHA251004	
	2002.05-2010.12	MPV Engine VQ35DE		o	GHA250010	
	2002.05-2010.12	MPV Engine VQ35DE		o	GHA429006	
3.5 AWD (177 kW)	2002.05-2010.12	MPV Engine VQ35DE	•		GHA251004	
	2002.05-2010.12	MPV Engine VQ35DE		o	GHA250010	
	2002.05-2010.12	MPV Engine VQ35DE		o	GHA429006	
FUGA Y50						
-	2004-2009			o	GHA329025	
INTERSTAR (X70)						
2.5 DCi (84 kW)	2002.07-	Box Engine G9U720	•		GWB3613	
	2002.07-	Box Engine G9U720		o	GWB3614	
2.5 DCi (88 kW)	2006.09-	Box Engine G9U650	•		GWB3613	
	2006.09-	Box Engine G9U650		o	GWB3614	
JUKE (F15)						
1.2 DiG-T (85 kW)	2014.05-	Hatchback Engine HR12DDT	•		GHA329006	K
	2014.05-	Hatchback Engine HR12DDT		o	GHA329012	K
1.5 DCi (81 kW)	2010.06-	Hatchback	•		GHA329006	K
	2010.06-	Hatchback	•		GHA329012	K
	2010.06-	Hatchback		o	GHA400194	
1.6 (69 kW)	2013.01-	Hatchback Engine HR16DE	•		GHA329006	K
	2013.01-	Hatchback Engine HR16DE	•		GHA329012	K
	2013.01-	Hatchback Engine HR16DE		o	GHA400194	
1.6 (86 kW)	2010.06-	Hatchback Engine HR16DE	•		GHA329006	K
	2010.06-	Hatchback Engine HR16DE	•		GHA329012	K
	2010.06-	Hatchback Engine HR16DE		o	GHA400194	
1.6 DiG-T (140 kW)	2010.06-	Hatchback Engine MR16DDT	•		GHA329006	K
	2010.06-	Hatchback Engine MR16DDT	•		GHA329012	K
	2010.06-	Hatchback Engine MR16DDT		o	GHA400194	
1.6 DiG-T 4x4 (140 kW)	2010.06-	Hatchback Engine MR16DDT	•		GHA329006	K
	2010.06-	Hatchback Engine MR16DDT	•		GHA329012	K
	2010.06-	Hatchback Engine MR16DDT		o	GHA325019	K



	 YEAR		F	R	G-AP Ref.	KIT
NISSAN						
JUKE (F15)						
1.6 DiG-T 4x4 (140 kW)	2010.06-	Hatchback Engine MR16DDT		o	GHA400194	
1.6 DiG-T NISMO (147 kW)	2012.11-	Hatchback Engine MR16DDT	•		GHA329006	K
	2012.11-	Hatchback Engine MR16DDT	•		GHA329012	K
1.6 DiG-T NISMO 4x4 (147 kW)	2012.11-	Hatchback Engine MR16DDT		o	GHA400194	
	2013.02-	Hatchback Engine MR16DDT	•		GHA329006	K
	2013.02-	Hatchback Engine MR16DDT	•		GHA329012	K
	2013.02-	Hatchback Engine MR16DDT		o	GHA325019	K
1.6 DiG-T NISMO RS (160 kW)	2013.02-	Hatchback Engine MR16DDT		o	GHA400194	
	2014.08-	Hatchback Engine MR16DDT	•		GHA329006	K
	2014.08-	Hatchback Engine MR16DDT	•		GHA329012	K
1.6 DiG-T NISMO RS 4x4 (157 kW)	2014.08-	Hatchback Engine MR16DDT		o	GHA400194	
	2014.08-	Hatchback Engine MR16DDT	•		GHA329012	K
2014.08-	2014.08-	Hatchback Engine MR16DDT		o	GHA400194	
	2014.08-	Hatchback Engine MR16DDT		o	GHA400194	
KUBISTAR						
1.2 (44 kW)	2003.08-	Box Engine D7F764	•		GWB3596	
	2003.08-	Box Engine D7F764		o	GHA225030	K
	2003.08-	Box Engine D7F764		o	GWB0976	
1.2 16V (55 kW)	2006.04-	Box Engine D4F712	•		GWB3596	
	2006.04-	Box Engine D4F712		o	GHA225030	K
	2006.04-	Box Engine D4F712		o	GWB0976	
1.5 DCi (45 kW)	2005.08-	Box Engine K9K710/K9K714	•		GWB3596	
	2005.08-	Box Engine K9K710/K9K714		o	GHA225030	K
	2005.08-	Box Engine K9K710/K9K714		o	GWB0976	
1.5 DCi (48 kW)	2003.08-	Box Engine K9K704	•		GWB3596	
	2003.08-	Box Engine K9K704		o	GHA225030	K
	2003.08-	Box Engine K9K704		o	GWB0976	
1.5 DCi (60 kW)	2003.08-	Box Engine K9K722	•		GWB3596	
	2003.08-	Box Engine K9K722		o	GHA225030	K
	2003.08-	Box Engine K9K722		o	GWB0976	
1.6 16V (70 kW)	2003.08-	Box Engine K4M752	•		GWB3596	
	2003.08-	Box Engine K4M752		o	GHA225030	K
	2003.08-	Box Engine K4M752		o	GWB0976	
KUBISTAR (X76)						
1.2 (44 kW)	2003.08-	MPV Engine D7F764	•		GWB3596	
	2003.08-	MPV Engine D7F764		o	GHA225030	K
	2003.08-	MPV Engine D7F764		o	GWB0976	
1.2 16V (55 kW)	2006.04-	MPV Engine D4F712	•		GWB3596	
	2006.04-	MPV Engine D4F712		o	GHA225030	K
	2006.04-	MPV Engine D4F712		o	GWB0976	
1.5 DCi (42 kW)	2003.08-	MPV Engine K9K710/K9K714	•		GWB3596	
	2003.08-	MPV Engine K9K710/K9K714		o	GHA225030	K
	2003.08-	MPV Engine K9K710/K9K714		o	GWB0976	
1.5 DCi (45 kW)	2005.08-	MPV Engine K9K710/K9K714	•		GWB3596	
	2005.08-	MPV Engine K9K710/K9K714		o	GHA225030	K
	2005.08-	MPV Engine K9K710/K9K714		o	GWB0976	
1.5 DCi (48 kW)	2003.08-	MPV Engine K9K704	•		GWB3596	
	2003.08-	MPV Engine K9K704		o	GHA225030	K
	2003.08-	MPV Engine K9K704		o	GWB0976	
1.5 DCi (50 kW)	2006.04-	MPV Engine K9K700	•		GWB3596	
	2006.04-	MPV Engine K9K700		o	GHA225030	K
	2006.04-	MPV Engine K9K700		o	GWB0976	
1.5 DCi (60 kW)	2003.08-	MPV Engine K9K722	•		GWB3596	
	2003.08-	MPV Engine K9K722		o	GHA225030	K
	2003.08-	MPV Engine K9K722		o	GWB0976	
1.5 DCi (62 kW)	2006.04-	MPV Engine K9K276	•		GWB3596	
	2006.04-	MPV Engine K9K276		o	GHA225030	K
	2006.04-	MPV Engine K9K276		o	GWB0976	
1.6 16V (70 kW)	2003.08-	MPV Engine K4M752	•		GWB3596	
	2003.08-	MPV Engine K4M752		o	GHA225030	K
	2003.08-	MPV Engine K4M752		o	GWB0976	
LAFESTA						
2.0 CVTC (101 kW)	2005.07-	MPV Engine MR20DE		o	GHA400326	
LEAF						
Electric (80 kW)	2010.11-	Hatchback Engine EM61	•		GHA329006	K



	 YEAR		F	R	G-AP Ref.	KIT
NISSAN						
LEAF						
Electric (80 kW)	2010.11-	Hatchback Engine EM61	•		GHA329012	K
	2010.11-	Hatchback Engine EM61		◦	GHA400194	
LIVINA / GRAND LIVINA (L10, L11)						
1.6 (77 kW)	2009.03-	MPV Engine HR16DE		◦	GHA400356	
1.6 (80 kW)	2007.02-	MPV Engine HR16DE		◦	GHA400356	
MAXIMA QX (A32)						
2.0 (103 kW)	1995.02-2000.08	Saloon Engine VQ20DE	•		GWB1999	
	1995.02-2000.08	Saloon Engine VQ20DE		◦	GHA230004	
	1995.02-2000.08	Saloon Engine VQ20DE Without ABS		◦	GHA230062	
2.5 V6 24V (140 kW)	1995.02-2000.08	Saloon Engine VQ25DE		◦	GHA230004	
3.0 (142 kW)	1995.01-2000.08	Saloon Engine VQ30DE	•		GWB1999	
	1995.01-2000.08	Saloon Engine VQ30DE		◦	GHA230004	
	1995.01-2000.08	Saloon Engine VQ30DE Without ABS		◦	GHA230062	
MAXIMA QX (A33)						
2.0 V6 24V (103 kW)	2000.03-2003.11	Saloon Engine VQ20DE	•		GHA329001	K
	2000.03-2003.11	Saloon Engine VQ20DE	•		GHA429002	K
3.0 V6 24V (147 kW)	2000.03-2003.11	Saloon Engine VQ30DE	•		GHA429002	K
	2000.03-2003.11	Saloon Engine VQ30DE	•		GWB3981	
	2000.03-2003.11	Saloon Engine VQ30DE		◦	GHA230004	
3.5 (188 kW)	2001.08-2003.02	Saloon Engine VQ35DE	•		GHA429002	K
3.5 (190 kW)	2003.03-2003.11	Saloon Engine VQ35DE	•		GHA329001	K
MAXIMA STATION WAGON						
2.0 QX (103 kW)	1997.10-	Estate Engine VQ20DE	•		GHA429002	K
	1997.10-	Estate Engine VQ20DE	•		GWB1999	
3.0 QX (142 kW)	1997.10-	Estate Engine VQ30DE	•		GHA429002	K
	1997.10-	Estate Engine VQ30DE	•		GWB1999	
	1997.10-	Estate Engine VQ30DE		◦	GHA230004	
MICRA C+C (K12)						
1.4 16V (65 kW)	2005.08-	Convertible Engine CR14DE	•		GHA425041	K
	2005.08-	Convertible Engine CR14DE	•		GWB3637	
	2005.08-	Convertible Engine CR14DE		◦	GHA499032	K
	2005.08-	Convertible Engine CR14DE		◦	GWB3525	
1.6 160 SR (81 kW)	2005.08-	Convertible Engine HR16DE	•		GWB3637	
	2005.08-	Convertible Engine HR16DE		◦	GHA499032	K
	2005.08-	Convertible Engine HR16DE		◦	GWB3525	
MICRA II (K11)						
1.0 (40 kW)	1992.01-1993.04	Hatchback Engine MA10S	•		GWB3703	
	1992.01-1993.04	Hatchback Engine MA10S		◦	GHA227017	K
	1992.01-1993.04	Hatchback Engine MA10S		◦	GHA227022	F
1.0 i 16V (40 kW)	1992.08-2000.09	Hatchback Engine CG10DE	•		GHA423017	
	1992.08-2000.09	Hatchback Engine CG10DE	•		GWB3703	
	1992.08-2000.09	Hatchback Engine CG10DE		◦	GHA227017	K
	1992.08-2000.09	Hatchback Engine CG10DE		◦	GHA227018	K
	1992.08-2000.09	Hatchback Engine CG10DE		◦	GHA227022	F
1.0 i 16V (44 kW)	2000.09-2003.02	Hatchback Engine CG10DE	•		GHA423017	
	2000.09-2003.02	Hatchback Engine CG10DE	•		GWB3703	
	2000.09-2003.02	Hatchback Engine CG10DE		◦	GHA227018	K
	2000.09-2003.02	Hatchback Engine CG10DE		◦	GHA227022	F
1.3 i 16V (55 kW)	1992.08-2000.09	Hatchback Engine CG13DE	•		GHA423017	
	1992.08-2000.09	Hatchback Engine CG13DE	•		GWB3703	
	1992.08-2000.09	Hatchback Engine CG13DE		◦	GHA227017	K
	1992.08-2000.09	Hatchback Engine CG13DE		◦	GHA227018	K
	1992.08-2000.09	Hatchback Engine CG13DE		◦	GHA227022	F
1.4 i 16V (60 kW)	2000.09-2003.02	Hatchback Engine CGA3DE	•		GHA423017	
	2000.09-2003.02	Hatchback Engine CGA3DE	•		GWB3703	
	2000.09-2003.02	Hatchback Engine CGA3DE		◦	GHA227018	K
	2000.09-2003.02	Hatchback Engine CGA3DE		◦	GHA227022	F
	2000.09-2003.02	Hatchback Engine CGA3DE		◦	GWB3272	
1.5 D (42 kW)	1998.02-2003.02	Hatchback Engine TD15	•		GWB3703	
	1998.02-2003.02	Hatchback Engine TD15		◦	GHA227018	K
	1998.02-2003.02	Hatchback Engine TD15		◦	GHA227022	F
MICRA III (K12)						
1.0 16V (48 kW)	2003.01-2010.06	Hatchback Engine CG10DE	•		GWB3637	



	 YEAR		F	R	G-AP Ref.	KIT
NISSAN						
MICRA III (K12)						
1.0 16V (48 kW)	2003.01-2010.06	Hatchback Engine CG10DE	•		GWB3991	
	2003.01-2010.06	Hatchback Engine CG10DE		◦	GHA499032	K
	2003.01-2010.06	Hatchback Engine CG10DE		◦	GWB3525	
1.2 16V (48 kW)	2007.09-2010.06	Hatchback Engine CG12DE/CR12DE	•		GHA425041	K
	2007.09-2010.06	Hatchback Engine CG12DE/CR12DE	•		GWB3637	
	2007.09-2010.06	Hatchback Engine CG12DE/CR12DE	•		GWB3991	
	2007.09-2010.06	Hatchback Engine CG12DE/CR12DE		◦	GHA499032	K
	2007.09-2010.06	Hatchback Engine CG12DE/CR12DE		◦	GWB3525	
1.2 16V (59 kW)	2003.01-2010.06	Hatchback Engine CR12DE/CG12DE	•		GHA425041	K
	2003.01-2010.06	Hatchback Engine CR12DE/CG12DE	•		GWB3637	
	2003.01-2010.06	Hatchback Engine CR12DE/CG12DE	•		GWB3991	
	2003.01-2010.06	Hatchback Engine CR12DE/CG12DE		◦	GHA499032	K
1.4 16V (65 kW)	2003.01-2007.09	Hatchback Engine CR14DE	•		GHA425041	K
	2003.01-2007.09	Hatchback Engine CR14DE	•		GWB3637	
	2003.01-2007.09	Hatchback Engine CR14DE	•		GWB3991	
	2003.01-2007.09	Hatchback Engine CR14DE		◦	GHA499032	K
	2003.01-2007.09	Hatchback Engine CR14DE		◦	GWB3525	
1.5 DCi (48 kW)	2003.01-2006.03	Hatchback Engine K9K704	•		GWB3637	
	2003.01-2006.03	Hatchback Engine K9K704		◦	GHA499032	K
	2003.01-2006.03	Hatchback Engine K9K704		◦	GWB3525	
1.5 DCi (50 kW)	2005.10-2006.06	Hatchback Engine K9K708	•		GWB3637	
	2005.10-2006.06	Hatchback Engine K9K708		◦	GHA499032	K
	2005.10-2006.06	Hatchback Engine K9K708		◦	GWB3525	
1.5 DCi (60 kW)	2003.09-2010.06	Hatchback Engine K9K722	•		GWB3637	
	2003.09-2010.06	Hatchback Engine K9K722		◦	GHA499032	K
	2003.09-2010.06	Hatchback Engine K9K722		◦	GWB3525	
1.5 DCi (63 kW)	2005.06-2010.06	Hatchback Engine K9K276	•		GWB3637	
	2005.06-2010.06	Hatchback Engine K9K276		◦	GWB3525	
1.6 SR (81 kW)	2005.05-2007.09	Hatchback Engine HR16DE	•		GWB3637	
	2005.05-2007.09	Hatchback Engine HR16DE		◦	GHA499032	K
	2005.05-2007.09	Hatchback Engine HR16DE		◦	GWB3525	
MICRA IV (K13)						
1.2 (56 kW)	2010.05-	Hatchback Engine HR12DE	•		GHA425041	K
	2010.05-	Hatchback Engine HR12DE	•		GWB3991	
1.2 (59 kW)	2010.05-	Hatchback Engine HR12DE	•		GHA425041	K
	2010.05-	Hatchback Engine HR12DE	•		GWB3991	
1.2 DiG (72 kW)	2011.04-	Hatchback Engine HR12DDR	•		GHA425041	K
	2011.04-	Hatchback Engine HR12DDR	•		GWB3991	
MURANO (Z50)						
3.5 4x4 (172 kW)	2004.10-2007.04	Closed Off-Road Vehicle	•		GHA329001	K
	2004.10-2007.04	Closed Off-Road Vehicle		◦	GHA329015	K
MURANO (Z51)						
2.5 4x4 (140 kW)	2010.01-	Closed Off-Road Vehicle Engine YD25DDTi	•		GHA332024	
	2010.01-	Closed Off-Road Vehicle Engine YD25DDTi		◦	GHA400183	
3.5 4x4 (188 kW)	2008.10-	Closed Off-Road Vehicle Engine VQ35DE	•		GHA332024	
	2008.10-	Closed Off-Road Vehicle Engine VQ35DE		◦	GHA329023	
MYRANO (Z51)						
3.5 (195 kW)	2007.11-	Closed Off-Road Vehicle Engine VQ35DE		◦	GHA329023	
NAVARA (D21)						
2.4 (91 kW)	1992.06-1997.02	Pickup Engine Z24i	•		GWB3205	
	1992.06-1997.02	Pickup Engine Z24i		◦	GWB3206	
2.4 4x4 (91 kW)	1992.06-1997.02	Pickup Engine KA24E	•		GWB3205	
	1992.06-1997.02	Pickup Engine KA24E		◦	GWB3206	
NAVARA (D40)						
2.5 DCi (106 kW)	2005.07-	Pickup Engine YD25DDTi	•		GHA400127	
	2005.07-	Pickup Engine YD25DDTi With ABS	•		GHA400160	
	2005.07-	Pickup Engine YD25DDTi Without ABS	•		GHA400172	
2.5 DCi (140 kW)	2010.03-	Platform/Chassis Engine YD25DDTi With ABS	•		GHA400160	
	2010.03-	Platform/Chassis Engine YD25DDTi Without ABS	•		GHA400172	
2.5 DCi 4WD (106 kW)	2008.08-	Platform/Chassis Engine YD25DDTi With ABS	•		GHA329005	
	2008.08-	Platform/Chassis Engine YD25DDTi Without ABS	•		GHA329009	
	2008.10-	Pickup Engine YD25DDTi	•		GHA329003	



	 YEAR		F	R	G-AP Ref.	KIT
NISSAN						
NAVARA (D40)						
2.5 DCi 4WD (126 kW)	2006.10-	Pickup Engine YD25DDTi With ABS	•		GHA329005	
	2006.10-	Pickup Engine YD25DDTi Without ABS	•		GHA329009	
	2008.08-	Platform/Chassis Engine YD25DDTi	•		GHA329003	
2.5 DCi 4WD (128 kW)	2005.07-	Pickup Engine YD25DDTi	•		GHA329003	
2.5 DCi 4WD (140 kW)	2009.12-	Pickup Engine YD25DDTi	•		GHA329003	
3.0 DCi (170 kW)	2010.03-	Platform/Chassis Engine V9X	•		GHA329003	
	2010.03-	Platform/Chassis Engine V9X With ABS	•		GHA400160	
	2010.03-	Platform/Chassis Engine V9X Without ABS	•		GHA400172	
3.0 DCi 4WD (170 kW)	2010.02-	Pickup Engine V9X	•		GHA329003	
NOTE (E11)						
1.4 (65 kW)	2006.03-2007.12	MPV Engine CR14DE	•		GWB3637	
	2006.03-2007.12	MPV Engine CR14DE		○	GHA499032	K
	2006.03-2007.12	MPV Engine CR14DE		○	GWB3525	
1.5 DCi (50 kW)	2006.03-2007.12	MPV Engine K9K700	•		GWB3637	
	2006.03-2007.12	MPV Engine K9K700		○	GWB3525	
1.5 DCi (63 kW)	2008.05-	MPV Engine K9K276	•		GWB3637	
	2008.05-	MPV Engine K9K276		○	GHA499032	K
	2008.05-	MPV Engine K9K276		○	GWB3525	
1.5 DCi (66 kW)	2010.09-	MPV Engine K9K276	•		GWB3637	
	2010.09-	MPV Engine K9K276		○	GWB3525	
1.5 DCi (76 kW)	2008.07-	MPV Engine K9K292	•		GWB3637	
	2008.07-	MPV Engine K9K292		○	GWB3525	
1.6 (81 kW)	2006.03-2007.12	MPV Engine HR16DE	•		GHA425041	K
	2006.03-2007.12	MPV Engine HR16DE	•		GWB3637	
	2006.03-2007.12	MPV Engine HR16DE		○	GHA499032	K
	2006.03-2007.12	MPV Engine HR16DE		○	GWB3525	
NOTE (E12)						
1.2 (59 kW)	2013.06-	Hatchback Engine HR12DE	•		GHA425041	K
1.2 DiG (72 kW)	2013.06-	Hatchback Engine HR12DDR	•		GHA425041	K
1.5 DCi (66 kW)	2013.06-	Hatchback Engine K9K 608/K9K 892	•		GHA425041	K
NV200						
1.5 DCi (63 kW)	2010.02-	Box Engine K9K400/K9K608/K9K628	•		GHA329010	
	2010.02-	Box Engine K9K400/K9K608/K9K628		○	GHA400177	
1.5 DCi (81 kW)	2011.04-	Box	•		GHA329010	
	2011.04-	Box		○	GHA400177	
1.6 16V (81 kW)	2010.02-	Box Engine HR16DE	•		GHA329010	
	2010.02-	Box Engine HR16DE		○	GHA400177	
NV200 / EVALIA						
	2010.07-	Bus Engine HR16DE	•		GHA329010	
	2010.07-	Bus Engine HR16DE		○	GHA400177	
NV200 EVALIA						
1.5 DCi (63 kW)	2010.07-	Bus	•		GHA329010	
	2010.07-	Bus		○	GHA400177	
1.5 DCi (66 kW)	2011.04-	Bus Engine K9K892	•		GHA329010	
	2011.04-	Bus Engine K9K892		○	GHA400177	
1.5 DCi (81 kW)	2011.04-	Bus	•		GHA329010	
	2011.04-	Bus		○	GHA400177	
NV400						
2.3 DCi (107 kW)	2011.11-	Box Engine M9T678/M9T680	•		GWB6721	
	2011.11-	Box Engine M9T678/M9T680		○	GWB6722	
	2011.11-	Box Engine M9T694/M9T696/M9T698	•		GWB6721	
	2011.11-	Box Engine M9T694/M9T696/M9T698		○	GWB6722	
	2011.11-	Bus Engine M9T678/M9T680	•		GWB6721	
	2011.11-	Bus Engine M9T678/M9T680		○	GWB6722	
	2011.11-	Platform/Chassis Engine M9T678/M9T680	•		GWB6721	
	2011.11-	Platform/Chassis Engine M9T678/M9T680		○	GWB6722	
	2011.11-	Platform/Chassis Engine M9T694/M9T696/M9T698	•		GWB6721	
	2011.11-	Platform/Chassis Engine M9T694/M9T696/M9T698		○	GWB6722	
	2.3 DCi (74 kW)	2011.11-	Box Engine M9T670/M9T672/M9T676	•		GWB6721
2011.11-		Box Engine M9T670/M9T672/M9T676		○	GWB6722	
2011.11-		Bus Engine M9T670/M9T672/M9T676	•		GWB6721	
2011.11-		Bus Engine M9T670/M9T672/M9T676		○	GWB6722	
2011.11-		Platform/Chassis Engine M9T670/M9T672/M9T676	•		GWB6721	



	 YEAR		F	R	G-AP Ref.	KIT
NISSAN						
NV400						
2.3 DCi (74 kW)	2011.11-	Platform/Chassis Engine M9T670/M9T672/M9T676		o	GWB6722	
2.3 DCi (92 kW)	2011.11-	Box Engine M9T670/M9T672/M9T676	•		GWB6721	
	2011.11-	Box Engine M9T670/M9T672/M9T676		o	GWB6722	
	2011.11-	Box Engine M9T686/M9T690/M9T692/M9T696/M9T698	•		GWB6721	
	2011.11-	Box Engine M9T686/M9T690/M9T692/M9T696/M9T698		o	GWB6722	
	2011.11-	Bus Engine M9T670/M9T672/M9T676	•		GWB6721	
	2011.11-	Bus Engine M9T670/M9T672/M9T676		o	GWB6722	
	2011.11-	Platform/Chassis Engine M9T670/M9T672/M9T676	•		GWB6721	
	2011.11-	Platform/Chassis Engine M9T670/M9T672/M9T676		o	GWB6722	
	2011.11-	Platform/Chassis Engine M9T686/M9T690/M9T692	•		GWB6721	
	2011.11-	Platform/Chassis Engine M9T686/M9T690/M9T692		o	GWB6722	
PATHFINDER (R50)						
3.3 V6 4WD (110 kW)	1998.03-2000.10	Closed Off-Road Vehicle Engine VG33E	•		GWB3205	
3.3 V6 4WD (125 kW)	1997.09-2004.12	Closed Off-Road Vehicle Engine VG33E	•		GWB3205	
3.5 V6 4WD (162 kW)	2000.11-2004.12	Closed Off-Road Vehicle Engine VQ35	•		GWB3205	
PATHFINDER (R51)						
2.5 DCi (128 kW)	2005.01-	Closed Off-Road Vehicle Engine YD25DDTi	•		GHA329003	
	2005.01-	Closed Off-Road Vehicle Engine YD25DDTi		o	GHA332005	K
2.5 DCi 4WD (120 kW)	2005.01-	Closed Off-Road Vehicle Engine YD25DDTi	•		GHA329003	
	2005.01-	Closed Off-Road Vehicle Engine YD25DDTi		o	GHA332005	K
2.5 DCi 4WD (126 kW)	2006.09-2007.12	Closed Off-Road Vehicle Engine YD25DDTi	•		GHA329003	
	2006.09-2007.12	Closed Off-Road Vehicle Engine YD25DDTi		o	GHA332005	K
2.5 DCi 4WD (128 kW)	2005.02-2006.12	Closed Off-Road Vehicle Engine YD25DDTi	•		GHA329003	
	2005.02-2006.12	Closed Off-Road Vehicle Engine YD25DDTi		o	GHA332005	K
2.5 DCi 4WD (140 kW)	2010.08-	Closed Off-Road Vehicle Engine YD25DDTi	•		GHA329003	
	2010.08-	Closed Off-Road Vehicle Engine YD25DDTi		o	GHA332005	K
3.0 DCi (170 kW)	2010.08-	Closed Off-Road Vehicle Engine V9X	•		GHA329003	
	2010.08-	Closed Off-Road Vehicle Engine V9X		o	GHA332005	K
4.0 4WD (198 kW)	2005.07-2006.12	Closed Off-Road Vehicle Engine VQ40DE	•		GHA329003	
	2005.07-2006.12	Closed Off-Road Vehicle Engine VQ40DE		o	GHA332005	K
PATROL GR (Y60, GR)						
2.8 TD (82 kW)	1995.10-1998.02	Closed Off-Road Vehicle Engine RD28T	•		GWB3331	
PATROL GR II (Y61)						
2.8 TD (95 kW)	1997.06-2000.05	Closed Off-Road Vehicle Engine RD28Ti	•		GWB3331	
	1997.06-2000.05	Closed Off-Road Vehicle Engine RD28Ti		o	GWB3332	
2.8 TDiC (96 kW)	1997.10-2000.02	Closed Off-Road Vehicle Engine RD28Ti	•		GWB3331	
	1997.10-2000.02	Closed Off-Road Vehicle Engine RD28Ti		o	GWB3332	
3.0 DTi (116 kW)	2000.05-	Closed Off-Road Vehicle Engine ZD30DDTi	•		GWB3331	
	2000.05-	Closed Off-Road Vehicle Engine ZD30DDTi		o	GWB3332	
3.0 DTi (118 kW)	2006.08-2007.12	Closed Off-Road Vehicle Engine ZD30DDTi	•		GWB3331	
	2006.08-2007.12	Closed Off-Road Vehicle Engine ZD30DDTi		o	GWB3332	
4.8 (180 kW)	2000.03-	Closed Off-Road Vehicle Engine TB48DE	•		GWB3331	
	2000.03-	Closed Off-Road Vehicle Engine TB48DE		o	GWB3332	
PICK UP (D22)						
2.4 i (88 kW)	1998.02-	Pickup Engine KA24E	•		GWB7474	
2.4 i 4WD (98 kW)	2002.03-	Pickup Engine KA24DE	•		GHA499064	
2.5 D (61 kW)	1998.02-	Pickup Engine TD25	•		GWB7474	
2.5 Di (98 kW)	2002.03-	Pickup Engine YD25DDTi	•		GHA499064	
	2002.03-	Pickup Engine YD25DDTi	•		GWB7474	
2.5 Di 4WD (98 kW)	2002.03-	Pickup Engine YD25DDTi	•		GHA499064	
PICK UP III (D22)						
2.4 (110 kW)	2003.01-	Pickup Engine KA24DE	•		GWB7474	
2.4 (79 kW)	1997.01-2002.12	Pickup Engine Z24/Z24S	•		GWB7474	
2.4 (98 kW)	2001.11-2005.04	Pickup Engine KA24DE	•		GWB7474	
PIXO (UA0)						
1.0 (50 kW)	2009.06-	Hatchback Engine K10B	•		GWB3965	
	2009.06-	Hatchback Engine K10B		o	GWB6820	
PRAIRIE PRO (M11)						
2.4 i (98 kW)	1992.04-1994.07	MPV Engine KA24E	•		GWB1999	
	1992.04-1994.07	MPV Engine KA24E		o	GHA230034	K
2.4 i 4x4 (98 kW)	1992.04-1994.07	MPV Engine KA24E	•		GWB1999	
PRESAGE U30						
-	1998-2003			o	GHA234011	



	 YEAR		F	R	G-AP Ref.	KIT
NISSAN						
PRIMASTAR (X83)						
1.9 DCi (60 kW)	2002.09-	Box Engine F9Q762	•		GWB3616	
	2002.09-	Box Engine F9Q762	•		GWB3618	
	2002.09-	Box Engine F9Q762	•		GWB3648	
	2002.09-	Box Engine F9Q762		○	GHA235025	
	2002.09-	Box Engine F9Q762		○	GWB3617	
1.9 DCi 100 (74 kW)	2002.09-	Box Engine F9Q760	•		GWB3616	
	2002.09-	Box Engine F9Q760	•		GWB3618	
	2002.09-	Box Engine F9Q760	•		GWB3648	
	2002.09-	Box Engine F9Q760		○	GHA235025	
	2002.09-	Box Engine F9Q760		○	GWB3617	
2.0 (88 kW)	2003.02-	Box Engine F4R720	•		GWB3648	
	2003.02-	Box Engine F4R720		○	GHA235025	
	2003.02-	Box Engine F4R720		○	GWB3617	
2.0 DCi (66 kW)	2006.09-	Box Engine M9R782	•		GWB3648	
	2006.09-	Box Engine M9R782		○	GHA235025	
	2006.09-	Box Engine M9R782		○	GWB3617	
2.0 DCi (84 kW)	2006.09-	Box Engine M9R780	•		GWB3648	
	2006.09-	Box Engine M9R780		○	GHA235025	
	2006.09-	Box Engine M9R780		○	GWB3617	
2.5 DCi (107 kW)	2006.09-	Box Engine G9U632	•		GWB3648	
	2006.09-	Box Engine G9U632		○	GHA235025	
	2006.09-	Box Engine G9U632		○	GWB3617	
2.5 DCi (99 kW)	2003.07-	Box Engine G9U730	•		GWB3648	
	2003.07-	Box Engine G9U730		○	GHA235025	
	2003.07-	Box Engine G9U730		○	GWB3617	
PRIMASTAR VAN (X83)						
1.9 DCi (60 kW)	2001.03-	Bus Engine F9Q762	•		GWB3616	
	2001.03-	Bus Engine F9Q762	•		GWB3618	
	2001.03-	Bus Engine F9Q762	•		GWB3648	
	2001.03-	Bus Engine F9Q762		○	GHA235025	
	2001.03-	Bus Engine F9Q762		○	GWB3617	
1.9 DCi 100 (74 kW)	2001.03-	Bus Engine F9Q760	•		GWB3616	
	2001.03-	Bus Engine F9Q760	•		GWB3618	
	2001.03-	Bus Engine F9Q760	•		GWB3648	
	2001.03-	Bus Engine F9Q760		○	GHA235025	
	2001.03-	Bus Engine F9Q760		○	GWB3617	
2.0 (88 kW)	2001.03-	Bus Engine F4R720/F4R722	•		GWB3616	
	2001.03-	Bus Engine F4R720/F4R722	•		GWB3618	
	2001.03-	Bus Engine F4R720/F4R722	•		GWB3648	
	2001.03-	Bus Engine F4R720/F4R722		○	GHA235025	
	2001.03-	Bus Engine F4R720/F4R722		○	GWB3617	
2.0 DCi (66 kW)	2006.09-	Bus Engine M9R782	•		GWB3648	
	2006.09-	Bus Engine M9R782		○	GHA235025	
	2006.09-	Bus Engine M9R782		○	GWB3617	
2.0 DCi 120 (84 kW)	2006.09-	Bus Engine M9R780	•		GWB3648	
	2006.09-	Bus Engine M9R780		○	GHA235025	
	2006.09-	Bus Engine M9R780		○	GWB3617	
2.5 DCi (107 kW)	2006.09-	Bus Engine G9U632	•		GWB3648	
	2006.09-	Bus Engine G9U632		○	GHA235025	
	2006.09-	Bus Engine G9U632		○	GWB3617	
2.5 DCi (99 kW)	2003.07-	Bus Engine G9U730	•		GWB3648	
	2003.07-	Bus Engine G9U730		○	GHA235025	
	2003.07-	Bus Engine G9U730		○	GWB3617	
PRIMERA (P10)						
1.6 (66 kW)	1990.06-1996.01	Hatchback Engine GA16DS	•		GWB1999	
	1990.06-1996.01	Hatchback Engine GA16DS		○	GHA227003	K
	1990.06-1996.01	Hatchback Engine GA16DS		○	GHA227026	K
	1990.06-1996.01	Saloon Engine GA16DS	•		GWB1999	
	1990.06-1996.01	Saloon Engine GA16DS	•		GWB3221	
	1990.06-1996.01	Saloon Engine GA16DS		○	GHA227003	K
	1990.06-1996.01	Saloon Engine GA16DS		○	GHA227026	K
1.6 (71 kW)	1990.06-1993.06	Hatchback Engine GA16DS	•		GWB1999	
	1990.06-1993.06	Hatchback Engine GA16DS		○	GHA227003	K
	1990.06-1993.06	Hatchback Engine GA16DS		○	GHA227026	K



	 YEAR		F	R	G-AP Ref.	KIT
NISSAN						
PRIMERA (P10)						
1.6 (71 kW)	1990.06-1996.01	Saloon Engine GA16DS	•		GWB1999	
	1990.06-1996.01	Saloon Engine GA16DS	•		GWB3221	
	1990.06-1996.01	Saloon Engine GA16DS		◦	GHA227003	K
	1990.06-1996.01	Saloon Engine GA16DS		◦	GHA227026	K
1.6 (75 kW)	1993.06-1996.01	Hatchback Engine GA16DE	•		GWB1999	
2.0 16V (85 kW)	1990.06-1996.01	Hatchback Engine SR20DI	•		GWB1999	
	1990.06-1996.01	Hatchback Engine SR20DI		◦	GHA227003	K
	1990.06-1996.01	Hatchback Engine SR20DI		◦	GHA227026	K
	1990.06-1996.01	Saloon Engine SR20DI	•		GWB1999	
	1990.06-1996.01	Saloon Engine SR20DI		◦	GHA227003	K
	1990.06-1996.01	Saloon Engine SR20DI		◦	GHA227026	K
2.0 16V 4x4 (85 kW)	1991.04-1996.06	Hatchback Engine SR20DI	•		GWB3221	
	1991.04-1996.06	Hatchback Engine SR20DI		◦	GWB1999	
	1991.04-1996.06	Saloon Engine SR20DI	•		GWB3221	
	1991.04-1996.06	Saloon Engine SR20DI		◦	GWB1999	
2.0 D (55 kW)	1991.01-1996.01	Hatchback Engine CD20	•		GWB1999	
	1991.01-1996.01	Hatchback Engine CD20		◦	GHA227003	K
	1991.01-1996.01	Hatchback Engine CD20		◦	GHA227026	K
	1991.01-1996.01	Saloon Engine CD20	•		GWB1999	
	1991.01-1996.01	Saloon Engine CD20		◦	GHA227003	K
	1991.01-1996.01	Saloon Engine CD20		◦	GHA227026	K
2.0 GT (110 kW)	1990.06-1996.01	Saloon Engine SR20DE	•		GWB1999	
	1990.06-1996.01	Saloon Engine SR20DE		◦	GHA227003	K
	1990.06-1996.01	Saloon Engine SR20DE		◦	GHA227026	K
2.0 i (92 kW)	1995.01-1996.06	Hatchback Engine SR20DE	•		GWB1999	
	1995.01-1996.06	Saloon Engine SR20DE	•		GWB1999	
PRIMERA (P11)						
1.6 16V (66 kW)	1996.09-2001.12	Saloon Engine GA16DE	•		GWB1999	
	1996.09-2001.12	Saloon Engine GA16DE		◦	GHA230094	K
	1996.09-2001.12	Saloon Engine GA16DE Without ABS		◦	GHA230070	
	1996.09-2002.07	Hatchback Engine GA16DE	•		GWB1999	
	1996.09-2002.07	Hatchback Engine GA16DE		◦	GHA230094	K
	1996.09-2002.07	Hatchback Engine GA16DE Without ABS		◦	GHA230070	
1.6 16V (73 kW)	1996.09-2000.10	Saloon Engine GA16DE	•		GWB1999	
	1996.09-2000.10	Saloon Engine GA16DE		◦	GHA230094	K
	1996.09-2000.10	Saloon Engine GA16DE Without ABS		◦	GHA230070	
	1996.09-2002.07	Hatchback Engine GA16DE	•		GWB1999	
	1996.09-2002.07	Hatchback Engine GA16DE		◦	GHA230094	K
	1996.09-2002.07	Hatchback Engine GA16DE Without ABS		◦	GHA230070	
1.6 16V (78 kW)	1996.06-2001.12	Saloon Engine QG16DE	•		GWB1999	
	1996.06-2001.12	Saloon Engine QG16DE		◦	GHA230094	K
	1996.06-2001.12	Saloon Engine QG16DE Without ABS		◦	GHA230070	
	2000.09-2002.07	Hatchback Engine QG16DE	•		GWB1999	
	2000.09-2002.07	Hatchback Engine QG16DE		◦	GHA230094	K
	2000.09-2002.07	Hatchback Engine QG16DE Without ABS		◦	GHA230070	
1.8 16V (84 kW)	1999.08-2001.12	Saloon Engine QG18DE	•		GWB1999	
	1999.08-2001.12	Saloon Engine QG18DE		◦	GHA230094	K
	1999.08-2002.07	Hatchback Engine QG18DE	•		GWB1999	
	1999.08-2002.07	Hatchback Engine QG18DE		◦	GHA230094	K
2.0 (140 kW)	1996.06-1999.05	Saloon Engine SR20VE	•		GWB1999	
2.0 16V (103 kW)	1999.08-2001.12	Saloon Engine SR20DE	•		GWB1999	
	1999.08-2001.12	Saloon Engine SR20DE Without ABS		◦	GHA230070	
	1999.08-2002.07	Hatchback Engine SR20DE	•		GWB1999	
	1999.08-2002.07	Hatchback Engine SR20DE Without ABS		◦	GHA230070	
2.0 16V (110 kW)	1996.09-2001.12	Saloon Engine SR20DE	•		GWB1999	
	1996.09-2001.12	Saloon Engine SR20DE Without ABS		◦	GHA230070	
	1996.09-2002.07	Hatchback Engine SR20DE	•		GWB1999	
	1996.09-2002.07	Hatchback Engine SR20DE Without ABS		◦	GHA230070	
2.0 16V (85 kW)	1996.09-2001.12	Saloon Engine SR20De	•		GWB1999	
	1996.09-2001.12	Saloon Engine SR20De		◦	GHA230094	K
	1996.09-2001.12	Saloon Engine SR20De Without ABS		◦	GHA230070	
	1996.09-2002.07	Hatchback Engine SR20De	•		GWB1999	
	1996.09-2002.07	Hatchback Engine SR20De		◦	GHA230094	K
	1996.09-2002.07	Hatchback Engine SR20De Without ABS		◦	GHA230070	



	 YEAR		F	R	G-AP Ref.	KIT
NISSAN						
PRIMERA (P11)						
2.0 16V (96 kW)	1996.09-2001.12	Saloon Engine SR20DE	•		GWB1999	
	1996.09-2001.12	Saloon Engine SR20DE Without ABS		◦	GHA230070	
	1996.09-2002.07	Hatchback Engine SR20DE	•		GWB1999	
	1996.09-2002.07	Hatchback Engine SR20DE Without ABS		◦	GHA230070	
2.0 TD (66 kW)	1996.09-2001.12	Saloon Engine CD20T	•		GWB1999	
	1996.09-2001.12	Saloon Engine CD20T		◦	GHA230094	K
	1996.09-2001.12	Saloon Engine CD20T Without ABS		◦	GHA230070	
	1996.09-2002.07	Hatchback Engine CD20T	•		GWB1999	
	1996.09-2002.07	Hatchback Engine CD20T		◦	GHA230094	K
	1996.09-2002.07	Hatchback Engine CD20T Without ABS		◦	GHA230070	
PRIMERA (P12)						
1.6 (78 kW)	2002.03-	Saloon Engine QG16DE	•		GHA427017	
	2002.03-	Saloon Engine QG16DE	•		GWB3981	
	2002.03-	Saloon Engine QG16DE		◦	GHA230058	K
	2002.07-	Hatchback Engine QG16DE	•		GHA427017	
	2002.07-	Hatchback Engine QG16DE	•		GWB3981	
	2002.07-	Hatchback Engine QG16DE		◦	GHA230058	K
1.6 (80 kW)	2002.01-	Saloon Engine QG16DE	•		GHA427017	
	2002.01-	Saloon Engine QG16DE	•		GWB3981	
	2002.01-	Saloon Engine QG16DE		◦	GHA230058	K
	2002.07-	Hatchback Engine QG16DE	•		GHA427017	
	2002.07-	Hatchback Engine QG16DE	•		GWB3981	
	2002.07-	Hatchback Engine QG16DE		◦	GHA230058	K
1.8 (85 kW)	2002.03-	Saloon Engine QG18DE	•		GHA427017	
	2002.03-	Saloon Engine QG18DE	•		GWB3981	
	2002.03-	Saloon Engine QG18DE		◦	GHA230058	K
	2002.07-	Hatchback Engine QG18DE	•		GHA427017	
	2002.07-	Hatchback Engine QG18DE	•		GWB3981	
	2002.07-	Hatchback Engine QG18DE		◦	GHA230058	K
1.9 DCi (85 kW)	2002.08-	Hatchback	•		GHA427017	
	2002.08-	Hatchback	•		GWB3981	
	2002.08-	Hatchback		◦	GHA230058	K
	2002.08-	Saloon	•		GHA427017	
	2002.08-	Saloon	•		GWB3981	
	2002.08-	Saloon		◦	GHA230058	K
1.9 DCi (88 kW)	2003.04-	Hatchback	•		GHA427017	
	2003.04-	Hatchback	•		GWB3981	
	2003.04-	Hatchback		◦	GHA230058	K
	2003.04-	Saloon	•		GHA427017	
	2003.04-	Saloon	•		GWB3981	
	2003.04-	Saloon		◦	GHA230058	K
2.0 (103 kW)	2002.03-	Saloon Engine QR20DE	•		GHA427017	
	2002.03-	Saloon Engine QR20DE	•		GWB3981	
	2002.03-	Saloon Engine QR20DE		◦	GHA230058	K
	2002.07-	Hatchback Engine QR20DE	•		GHA427017	
	2002.07-	Hatchback Engine QR20DE	•		GWB3981	
	2002.07-	Hatchback Engine QR20DE		◦	GHA230058	K
2.2 DCi (102 kW)	2003.03-2006.12	Hatchback Engine YD22DDT	•		GHA427017	
	2003.03-2006.12	Hatchback Engine YD22DDT	•		GWB3981	
	2003.03-2006.12	Hatchback Engine YD22DDT		◦	GHA230058	K
	2003.03-2006.12	Saloon Engine YD22DDT	•		GHA427017	
	2003.03-2006.12	Saloon Engine YD22DDT	•		GWB3981	
	2003.03-2006.12	Saloon Engine YD22DDT		◦	GHA230058	K
2.2 Di (93 kW)	2002.03-	Saloon Engine YD22DDT	•		GHA427017	
	2002.03-	Saloon Engine YD22DDT	•		GWB3981	
	2002.03-	Saloon Engine YD22DDT		◦	GHA230058	K
	2002.07-	Hatchback Engine YD22DDT	•		GHA427017	
	2002.07-	Hatchback Engine YD22DDT	•		GWB3981	
	2002.07-	Hatchback Engine YD22DDT		◦	GHA230058	K
PRIMERA (WP12)						
1.6 Visia (80 kW)	2002.01-	Estate Engine QG16DE	•		GHA427017	
	2002.01-	Estate Engine QG16DE	•		GWB3981	
	2002.01-	Estate Engine QG16DE		◦	GHA230058	K
1.8 (85 kW)	2002.03-	Estate Engine QG18DE	•		GHA427017	



	 YEAR		F	R	G-AP Ref.	KIT
NISSAN						
PRIMERA (WP12)						
1.8 (85 kW)	2002.03-	Estate Engine QG18DE	•		GWB3981	
	2002.03-	Estate Engine QG18DE		◦	GHA230058	K
1.9 DCi (85 kW)	2002.08-	Estate	•		GHA427017	
	2002.08-	Estate	•		GWB3981	
	2002.08-	Estate		◦	GHA230058	K
1.9 DCi (88 kW)	2003.04-	Estate	•		GHA427017	
	2003.04-	Estate	•		GWB3981	
	2003.04-	Estate		◦	GHA230058	K
2.0 (103 kW)	2002.03-	Estate Engine QR20DE	•		GHA427017	
	2002.03-	Estate Engine QR20DE	•		GWB3981	
	2002.03-	Estate Engine QR20DE		◦	GHA230058	K
2.2 DCi (102 kW)	2003.03-2006.12	Estate Engine YD22DDT	•		GHA427017	
	2003.03-2006.12	Estate Engine YD22DDT	•		GWB3981	
	2003.03-2006.12	Estate Engine YD22DDT		◦	GHA230058	K
2.2 Di (93 kW)	2002.03-	Estate Engine YD22DDT	•		GHA427017	
	2002.03-	Estate Engine YD22DDT	•		GWB3981	
	2002.03-	Estate Engine YD22DDT		◦	GHA230058	K
PRIMERA TRAVELLER (W10)						
1.6 i (66 kW)	1990.07-1998.03	Estate Engine GA16DS	•		GWB1365	
	1990.07-1998.03	Estate Engine GA16DS		◦	GHA230034	K
1.6 i (75 kW)	1994.03-1998.03	Estate Engine GA16DE	•		GWB1365	
	1994.03-1998.03	Estate Engine GA16DE		◦	GHA230034	K
2.0 D (55 kW)	1990.07-1995.12	Estate Engine CD20	•		GWB1365	
	1990.07-1995.12	Estate Engine CD20		◦	GHA230034	K
2.0 i (85 kW)	1990.07-1998.03	Estate Engine SR20DI	•		GWB1365	
	1990.07-1998.03	Estate Engine SR20DI		◦	GHA230034	K
PRIMERA TRAVELLER (WP11)						
1.6 16V (66 kW)	1998.04-2001.12	Estate Engine GA16DE	•		GWB1999	
	1998.04-2001.12	Estate Engine GA16DE Without ABS		◦	GHA230070	
1.6 16V (73 kW)	1998.04-2001.12	Estate Engine GA16DE	•		GWB1999	
	1998.04-2001.12	Estate Engine GA16DE Without ABS		◦	GHA230070	
1.8 16V (84 kW)	1999.08-2001.12	Estate Engine QG18DE	•		GWB1999	
	1999.08-2001.12	Estate Engine QG18DE Without ABS		◦	GHA230070	
2.0 16V (103 kW)	1999.08-2001.12	Estate Engine SR20DE	•		GWB1999	
	1999.08-2001.12	Estate Engine SR20DE Without ABS		◦	GHA230070	
2.0 16V (85 kW)	1996.06-2001.12	Estate Engine SR20De	•		GWB1999	
	1996.06-2001.12	Estate Engine SR20De Without ABS		◦	GHA230070	
2.0 16V (96 kW)	1998.04-2001.12	Estate Engine SR20DE	•		GWB1999	
	1998.04-2001.12	Estate Engine SR20DE Without ABS		◦	GHA230070	
2.0 TD (66 kW)	1998.04-2001.12	Estate Engine CD20T	•		GWB1999	
	1998.04-2001.12	Estate Engine CD20T Without ABS		◦	GHA230070	
QASHQAI / QASHQAI +2 (J10, JJ10)						
1.5 DCi (76 kW)	2008.07-	Closed Off-Road Vehicle	•		GHA329006	K
	2008.07-	Closed Off-Road Vehicle		◦	GHA400161	
1.5 DCi (78 kW)	2007.02-	Closed Off-Road Vehicle	•		GHA329006	K
	2007.02-	Closed Off-Road Vehicle		◦	GHA400161	
1.5 DCi (81 kW)	2010.11-	Closed Off-Road Vehicle	•		GHA329006	K
	2010.11-	Closed Off-Road Vehicle		◦	GHA400161	
1.6 (84 kW)	2007.02-	Closed Off-Road Vehicle Engine HR16DE	•		GHA329006	K
	2007.02-	Closed Off-Road Vehicle Engine HR16DE		◦	GHA400161	
1.6 DCi (96 kW)	2011.10-	Closed Off-Road Vehicle Engine R9M	•		GHA329006	K
	2011.10-	Closed Off-Road Vehicle Engine R9M	•		GHA329006	K
	2011.10-	Closed Off-Road Vehicle Engine R9M		◦	GHA325019	K
	2011.10-	Closed Off-Road Vehicle Engine R9M		◦	GHA400161	
2.0 (104 kW)	2010.11-	Closed Off-Road Vehicle Engine MR20DE	•		GHA329006	K
	2010.11-	Closed Off-Road Vehicle Engine MR20DE	•		GHA329006	K
	2010.11-	Closed Off-Road Vehicle Engine MR20DE		◦	GHA325019	K
	2010.11-	Closed Off-Road Vehicle Engine MR20DE		◦	GHA400161	
2.0 DCi (110 kW)	2007.02-	Closed Off-Road Vehicle Engine M1D/M9R	•		GHA329006	K
	2007.02-	Closed Off-Road Vehicle Engine M1D/M9R	•		GHA329006	K
	2007.02-	Closed Off-Road Vehicle Engine M1D/M9R		◦	GHA325019	K
	2007.02-	Closed Off-Road Vehicle Engine M1D/M9R		◦	GHA400161	
QUEST (V42)						
3.5 (176 kW)	2003.05-	MPV Engine VQ35DE	•		GHA329001	K



	 YEAR		F	R	G-AP Ref.	KIT
NISSAN						
R-NESSA N30						
-	1997-2001			o	GHA234011	
SENTRA IV (B14)						
1.6 (86 kW)	1995.01-1999.12	Saloon With ABS		o	GHA227006	
SENTRA V (B15)						
1.8 (88 kW)	2000.01-2006.08	Saloon Engine QG18DE	•		GHA425018	K
	2000.01-2006.08	Saloon Engine QG18DE Without ABS		o	GHA227014	
	2000.01-2006.08	Saloon Engine QG18DE Without ABS		o	GHA227014	
1.8 (93 kW)	2000.01-2006.08	Saloon Engine QG18DE	•		GHA425018	K
	2000.01-2006.08	Saloon Engine QG18DE Without ABS		o	GHA227014	
	2000.01-2006.08	Saloon Engine QG18DE Without ABS		o	GHA227014	
2.0 (107 kW)	2000.01-2006.12	Saloon Engine SR20DE	•		GHA425018	K
	2000.01-2006.12	Saloon Engine SR20DE Without ABS		o	GHA227014	
	2000.01-2006.12	Saloon Engine SR20DE Without ABS		o	GHA227014	
2.5 (129 kW)	2002.06-2006.08	Saloon Engine QR25DE Without ABS		o	GHA227014	
	2002.06-2006.08	Saloon Engine QR25DE Without ABS		o	GHA227014	
SKYLINE (R33)						
2.0 (96 kW)	1993.07-1998.05	Coupe Engine RB20E		o	GHA243005	
2.5 (140 kW)	1993.07-1998.05	Coupe Engine RB25DE		o	GHA243005	
	1993.07-1998.05	Saloon Engine RB25DE		o	GHA243005	
2.5 (184 kW)	1994.01-2000.07	Coupe Engine RB25DET		o	GHA243005	
2.5 4x4 (140 kW)	1993.07-1998.05	Coupe Engine RB25DE		o	GHA243005	
SKYLINE (R34)						
2.0 (114 kW)	1998.06-2000.07	Coupe Engine RB20DE		o	GHA243005	
	1998.06-2000.07	Saloon Engine RB20DE		o	GHA243005	
SKYLINE (V35)						
2.5 (158 kW)	2006.01-2007.08	Coupe Engine VQ25DD		o	GHA429003	
3.0 (191 kW)	2003.08-2006.12	Coupe Engine VQ30DD		o	GHA429003	
STAGEA (M35)						
2.5 AWD (138 kW)	2001.10-2006.12	Estate	•		GHA243011	
	2001.10-2006.12	Estate		o	GHA429003	
STAGEA (WC34)						
2.0 (96 kW)	1996.09-2001.1	Estate Engine RB20E		o	GHA243005	
2.5 Turbo AWD (173 kW)	1996.09-2001.1	Estate Engine RB25DET		o	GHA243005	
SUNNY (Y10)						
1.6 i 16V (66 kW)	1992.10-2000.03	Box Engine GA16DE		o	GHA227007	
1.7 D (40 kW)	1990.11-2000.03	Box Engine CD17		o	GHA227007	
SUNNY III						
1.8 (78 kW)	1995.11-2001.04	Coupe Engine QG18DE With ABS		o	GHA227006	
SUNNY III (N14)						
1.4 (60 kW)	1990.10-1995.06	Hatchback Engine GA14DS		o	GHA227007	
	1990.10-1995.06	Saloon Engine GA14DS		o	GHA227007	
1.4 i (55 kW)	1990.10-1995.05	Hatchback Engine GA14DE/GA14DS	•		GWB3201	
	1990.10-1995.05	Hatchback Engine GA14DE/GA14DS	•		GWB3201	
	1990.10-1995.05	Hatchback Engine GA14DE/GA14DS With ABS		o	GHA227010	
	1990.10-1995.05	Hatchback Engine GA14DE/GA14DS With ABS		o	GHA227010	
	1990.10-1995.05	Hatchback Engine GA14DE/GA14DS Without ABS		o	GHA227001	K
	1990.10-1995.05	Hatchback Engine GA14DE/GA14DS Without ABS		o	GHA227001	K
	1990.10-1995.05	Hatchback Engine GA14DE/GA14DS Without ABS		o	GHA227001	K
	1990.10-1995.05	Hatchback Engine GA14DE/GA14DS Without ABS		o	GHA227001	K
	1990.10-1995.05	Saloon Engine GA14DE/GA14DS	•		GWB3201	
	1990.10-1995.05	Saloon Engine GA14DE/GA14DS With ABS		o	GHA227010	
	1990.10-1995.05	Saloon Engine GA14DE/GA14DS Without ABS		o	GHA227001	K
	1990.10-1995.05	Saloon Engine GA14DE/GA14DS Without ABS		o	GHA227001	K
1.4 i 16V (64 kW)	1990.10-1995.05	Hatchback Engine GA14DE	•		GWB3201	
	1990.10-1995.05	Hatchback Engine GA14DE		o	GHA227007	
	1990.10-1995.05	Hatchback Engine GA14DE With ABS		o	GHA227010	
	1990.10-1995.05	Hatchback Engine GA14DE Without ABS		o	GHA227001	K
	1990.10-1995.05	Hatchback Engine GA14DE Without ABS		o	GHA227001	K
	1990.10-1995.06	Hatchback Engine GA14DE	•		GWB3201	
	1990.10-1995.06	Hatchback Engine GA14DE		o	GHA227007	
	1990.10-1995.06	Hatchback Engine GA14DE Without ABS		o	GHA227001	K
	1990.10-1995.06	Hatchback Engine GA14DE Without ABS		o	GHA227001	K
	1993.01-1995.10	Saloon Engine GA14DE	•		GWB3201	



	 YEAR		F	R	G-AP Ref.	KIT
NISSAN						
SUNNY III (N14)						
1.4 i 16V (64 kW)	1993.01-1995.10	Saloon Engine GA14DE		o	GHA227007	
	1993.01-1995.10	Saloon Engine GA14DE Without ABS		o	GHA227001	K
	1993.01-1995.10	Saloon Engine GA14DE Without ABS		o	GHA227001	K
1.5 (51 kW)	1990.10-1995.05	Hatchback		o	GHA227007	
	1990.10-1995.05	Hatchback With ABS		o	GHA227010	
1.6 (82 kW)	1990.08-1994.1	Saloon Engine GA16DE With ABS		o	GHA227010	
1.6 i (66 kW)	1990.10-1995.05	Hatchback Engine GA16DE/GA16DS	•		GWB3201	
	1990.10-1995.05	Hatchback Engine GA16DE/GA16DS	•		GWB3201	
	1990.10-1995.05	Hatchback Engine GA16DE/GA16DS		o	GHA227007	
	1990.10-1995.05	Hatchback Engine GA16DE/GA16DS		o	GHA227007	
	1990.10-1995.05	Hatchback Engine GA16DE/GA16DS With ABS		o	GHA227010	
	1990.10-1995.05	Hatchback Engine GA16DE/GA16DS With ABS		o	GHA227010	
	1990.10-1995.05	Hatchback Engine GA16DE/GA16DS Without ABS		o	GHA227001	K
	1990.10-1995.05	Hatchback Engine GA16DE/GA16DS Without ABS		o	GHA227001	K
	1990.10-1995.05	Hatchback Engine GA16DE/GA16DS Without ABS		o	GHA227001	K
	1990.10-1995.05	Hatchback Engine GA16DE/GA16DS Without ABS		o	GHA227001	K
	1990.10-1995.05	Saloon Engine GA16DEL/GA16DS	•		GWB3201	
	1990.10-1995.05	Saloon Engine GA16DEL/GA16DS		o	GHA227007	
	1990.10-1995.05	Saloon Engine GA16DEL/GA16DS With ABS		o	GHA227010	
	1990.10-1995.05	Saloon Engine GA16DEL/GA16DS Without ABS		o	GHA227001	K
	1990.10-1995.05	Saloon Engine GA16DEL/GA16DS Without ABS		o	GHA227001	K
	1.6 i 16V (75 kW)	1992.10-1995.05	Hatchback Engine GA16DE	•		GWB3201
1992.10-1995.05		Hatchback Engine GA16DE	•		GWB3201	
1992.10-1995.05		Hatchback Engine GA16DE		o	GHA227007	
1992.10-1995.05		Hatchback Engine GA16DE With ABS		o	GHA227010	
1992.10-1995.05		Hatchback Engine GA16DE With ABS		o	GHA227010	
1992.10-1995.05		Hatchback Engine GA16DE Without ABS		o	GHA227001	K
1992.10-1995.05		Hatchback Engine GA16DE Without ABS		o	GHA227001	K
1992.10-1995.05		Hatchback Engine GA16DE Without ABS		o	GHA227001	K
1992.10-1995.05		Hatchback Engine GA16DE Without ABS		o	GHA227001	K
1992.10-1995.05		Saloon Engine GA16DE	•		GWB3201	
1992.10-1995.05		Saloon Engine GA16DE		o	GHA227007	
1992.10-1995.05		Saloon Engine GA16DE With ABS		o	GHA227010	
1992.10-1995.05		Saloon Engine GA16DE Without ABS		o	GHA227001	K
1992.10-1995.05		Saloon Engine GA16DE Without ABS		o	GHA227001	K
1.6 i 16V 4WD (66 kW)	1990.10-1995.05	Saloon Engine GA16DS	•		GWB3201	
	1990.10-1995.05	Saloon Engine GA16DS		o	GHA227007	
1.6 i 16V 4x4 (75 kW)	1992.10-1995.05	Hatchback Engine GA16DE	•		GWB3201	
2.0 (104 kW)	1990.08-1996.12	Saloon Engine SR20DE With ABS		o	GHA227010	
2.0 D (55 kW)	1990.10-1995.05	Hatchback Engine CD20	•		GWB3201	
	1990.10-1995.05	Hatchback Engine CD20	•		GWB3201	
	1990.10-1995.05	Hatchback Engine CD20		o	GHA227007	
	1990.10-1995.05	Hatchback Engine CD20		o	GHA227007	
	1990.10-1995.05	Hatchback Engine CD20 With ABS		o	GHA227010	
	1990.10-1995.05	Hatchback Engine CD20 With ABS		o	GHA227010	
	1990.10-1995.05	Hatchback Engine CD20 Without ABS		o	GHA227001	K
	1990.10-1995.05	Hatchback Engine CD20 Without ABS		o	GHA227001	K
	1990.10-1995.05	Hatchback Engine CD20 Without ABS		o	GHA227001	K
	1990.10-1995.05	Hatchback Engine CD20 Without ABS		o	GHA227001	K
	1990.10-1995.05	Saloon Engine CD20	•		GWB3201	
	1990.10-1995.05	Saloon Engine CD20		o	GHA227007	
	1990.10-1995.05	Saloon Engine CD20 With ABS		o	GHA227010	
	1990.10-1995.05	Saloon Engine CD20 Without ABS		o	GHA227001	K
1990.10-1995.05	Saloon Engine CD20 Without ABS		o	GHA227001	K	
2.0 GTi 16V (105 kW)	1990.10-1995.05	Hatchback Engine SR20DE	•		GWB3201	
	1990.10-1995.05	Hatchback Engine SR20DE		o	GHA227007	
	1990.10-1995.05	Hatchback Engine SR20DE With ABS		o	GHA227010	
	1990.10-1995.05	Hatchback Engine SR20DE Without ABS		o	GHA227001	K
	1990.10-1995.05	Hatchback Engine SR20DE Without ABS		o	GHA227001	K
2.0 GTi-R 4x4 (162 kW)	1990.10-1995.05	Hatchback Engine SR20DET	•		GWB3201	
2.0 i 16V (105 kW)	1990.10-1995.05	Hatchback Engine SR20DE	•		GWB3201	
	1990.10-1995.05	Hatchback Engine SR20DE		o	GHA227007	
	1990.10-1995.05	Hatchback Engine SR20DE With ABS		o	GHA227010	
	1990.10-1995.05	Hatchback Engine SR20DE Without ABS		o	GHA227001	K



	 YEAR		F	R	G-AP Ref.	KIT
NISSAN						
SUNNY III (N14)						
2.0 i 16V (105 kW)	1990.10-1995.05	Hatchback Engine SR20DE Without ABS		o	GHA227001	K
SUNNY III (Y10)						
1.6 (75 kW)	1995.07-2000.03	Estate Engine GA16DE		o	GHA227007	
1.6 i (66 kW)	1991.06-2000.03	Estate Engine GA16DE/GA16DS		o	GHA227007	
1.6 i 16V 4x4 (75 kW)	1992.10-2000.03	Estate Engine GA16DE		o	GHA227007	
2.0 D (55 kW)	1991.06-2000.03	Estate Engine CD20		o	GHA227007	
SUNNY IV						
1.3 (64 kW)	1997.09-2000.03	Saloon Engine QG13DE	•		GHA425018	K
	1997.09-2000.03	Saloon Engine QG13DE With ABS		o	GHA227004	K
1.5 (77 kW)	1997.09-2000.03	Saloon Engine QG15DE	•		GHA425018	K
	1997.09-2000.03	Saloon Engine QG15DE With ABS		o	GHA227004	K
1.5 4x4 (77 kW)	1997.09-2000.03	Saloon Engine QG15DE	•		GHA425018	K
1.8 (85 kW)	2000.04-2003.09	Hatchback Engine QG18DE	•		GHA425018	K
	2000.04-2003.09	Hatchback Engine QG18DE Without ABS		o	GHA227014	
	2000.04-2003.09	Hatchback Engine QG18DE Without ABS		o	GHA227014	
	2000.04-2003.09	Saloon Engine QG18DE	•		GHA425018	K
	2000.04-2003.09	Saloon Engine QG18DE Without ABS		o	GHA227014	
	2000.04-2003.09	Saloon Engine QG18DE Without ABS		o	GHA227014	
2.0 (110 kW)	2000.01-2002.05	Saloon Engine SR20DE	•		GHA425018	K
	2000.01-2002.05	Saloon Engine SR20DE Without ABS		o	GHA227014	
	2000.01-2002.05	Saloon Engine SR20DE Without ABS		o	GHA227014	
SUNNY NEO						
-		With ABS		o	GHA227002	
SYLPHY (C13)						
1.2 DiG-T (85 kW)	2014.10-	Hatchback Engine HR12DDT	•		GHA329012	K
	2014.10-	Hatchback Engine HR12DDT	•		GWB3991	
1.5 DCi (81 kW)	2014.10-	Hatchback Engine K9K	•		GHA329012	K
1.6 DiG-T (140 kW)	2015.02-	Hatchback Engine MR16DDT	•		GHA329012	K
TEANA I (J31)						
2.0 (103 kW)	2003.10-2008.06	Saloon Engine QR20DE	•		GHA329001	K
	2003.10-2008.06	Saloon Engine QR20DE With ABS		o	GHA400011	
2.3 (127 kW)	2003.10-2008.06	Saloon Engine VQ23DE	•		GHA329001	K
	2003.10-2008.06	Saloon Engine VQ23DE With ABS		o	GHA400011	
3.5 (170 kW)	2003.10-2008.06	Saloon Engine VQ35DE	•		GHA329001	K
	2003.10-2008.06	Saloon Engine VQ35DE With ABS		o	GHA400011	
TEANA II (J32)						
2.5 (134 kW)	2008.07-2013.09	Saloon Engine VQ25DE	•		GHA329019	
	2008.07-2013.09	Saloon Engine VQ25DE		o	GHA329023	
TERRANO (WD21)						
3.0 i 4WD (109 kW)	1990.01-1995.12	Closed Off-Road Vehicle Engine VG30E	•		GWB3205	
	1990.01-1995.12	Closed Off-Road Vehicle Engine VG30E		o	GWB3206	
TERRANO II (R20)						
2.4 4WD (85 kW)	1996.05-2002.01	Closed Off-Road Vehicle Engine KA24E	•		GWB3205	
2.4 4WD (87 kW)	1996.05-	Closed Off-Road Vehicle Engine KA24E	•		GWB3205	
2.4 i 12V 4WD (91 kW)	1993.02-1996.06	Closed Off-Road Vehicle Engine KA24E	•		GWB3205	
2.7 TD 4WD (74 kW)	1993.02-2002.01	Closed Off-Road Vehicle Engine TD27T	•		GWB3205	
2.7 TDi 4WD (92 kW)	1996.05-	Closed Off-Road Vehicle Engine TD27TI	•		GWB3205	
3.0 Di 4WD (113 kW)	2002.05-	Closed Off-Road Vehicle Engine ZD30	•		GWB3205	
TIIDA (SC11X)						
1.5 DCi (76 kW)	2007.01-	Saloon Engine K9K 772		o	GHA400009	
TIIDA (C11X)						
1.5 DCi (78 kW)	2007.09-	Hatchback Engine K9K728		o	GHA400009	
	2007.09-	Hatchback Engine K9K728 With ABS	•		GHA325016	K
	2007.09-	Hatchback Engine K9K728 With ABS	•		GHA325016	K
	2007.09-	Hatchback Engine K9K728 With ABS		o	GHA400096	
	2007.09-	Hatchback Engine K9K728 Without ABS	•		GHA325020	
	2007.09-	Hatchback Engine K9K728 Without ABS	•		GHA325020	
1.6 (81 kW)	2007.09-	Hatchback Engine HR16DE	•		GHA325024	
	2007.09-	Hatchback Engine HR16DE		o	GHA400009	
	2007.09-	Hatchback Engine HR16DE		o	GHA400180	
	2007.09-	Hatchback Engine HR16DE		o	GHA400356	
	2007.09-	Hatchback Engine HR16DE With ABS	•		GHA325016	K
	2007.09-	Hatchback Engine HR16DE With ABS	•		GHA325016	K



	 YEAR		F	R	G-AP Ref.	KIT
NISSAN						
TIIDA (C11X)						
1.6 (81 kW)	2007.09-	Hatchback Engine HR16DE With ABS		○	GHA400096	
	2007.09-	Hatchback Engine HR16DE Without ABS	●		GHA325020	
	2007.09-	Hatchback Engine HR16DE Without ABS	●		GHA325020	
1.8 (93 kW)	2007.09-	Hatchback Engine MR18DE	●		GHA325024	
	2007.09-	Hatchback Engine MR18DE		○	GHA400009	
	2007.09-	Hatchback Engine MR18DE		○	GHA400180	
	2007.09-	Hatchback Engine MR18DE		○	GHA400356	
	2007.09-	Hatchback Engine MR18DE With ABS	●		GHA325016	K
	2007.09-	Hatchback Engine MR18DE With ABS	●		GHA325016	K
	2007.09-	Hatchback Engine MR18DE With ABS		○	GHA400096	
	2007.09-	Hatchback Engine MR18DE Without ABS	●		GHA325020	
	2007.09-	Hatchback Engine MR18DE Without ABS	●		GHA325020	
TIIDA (SC11X)						
1.5 DCi (78 kW)	2007.09-	Saloon		○	GHA400009	
	2007.09-	Saloon With ABS	●		GHA325016	K
	2007.09-	Saloon With ABS	●		GHA325016	K
	2007.09-	Saloon With ABS		○	GHA400096	
	2007.09-	Saloon Without ABS	●		GHA325020	
	2007.09-	Saloon Without ABS	●		GHA325020	
1.6 (81 kW)	2007.09-	Saloon Engine HR16DE	●		GHA325024	
	2007.09-	Saloon Engine HR16DE		○	GHA400009	
	2007.09-	Saloon Engine HR16DE		○	GHA400180	
	2007.09-	Saloon Engine HR16DE		○	GHA400356	
	2007.09-	Saloon Engine HR16DE With ABS	●		GHA325016	K
	2007.09-	Saloon Engine HR16DE With ABS	●		GHA325016	K
	2007.09-	Saloon Engine HR16DE With ABS		○	GHA400096	
	2007.09-	Saloon Engine HR16DE Without ABS	●		GHA325020	
	2007.09-	Saloon Engine HR16DE Without ABS	●		GHA325020	
	2007.09-	Saloon Engine HR16DE Without ABS		○	GHA400104	
TITAN						
5.6 (227 kW)	2003.10-	Pickup Engine VK56DE	●		GHA329017	
	2003.10-	Pickup Engine VK56DE		○	GHA332014	
5.6 4x4 (227 kW)	2003.10-	Pickup Engine VK56DE	●		GHA329017	
	2003.10-	Pickup Engine VK56DE		○	GHA332014	
5.6 FlexFuel 4WD (227 kW)	2003.10-2006.12	Pickup Engine VK56DE	●		GHA329017	
	2003.10-2006.12	Pickup Engine VK56DE		○	GHA332014	
URVAN (E25)						
2.0 (88 kW)	2000.10-2002.09	Box Engine KA20DE	●		GHA251001	
2.4 (103 kW)	2001.05-2012.01	Box Engine KA24DE	●		GHA251001	
3.0 D (77 kW)	2000.10-2012.01	Box Engine ZD30DD	●		GHA251001	
VANETTE (C22)						
2.0 D (49 kW)	1991.07-1995.01	Box Engine LD20II	●		GWB1999	
X-TRAIL (T30)						
2.0 (103 kW)	2006.04-2007.12	Closed Off-Road Vehicle Engine QR20DE	●		GHA429002	K
	2006.04-2007.12	Closed Off-Road Vehicle Engine QR20DE	●		GWB3981	
	2006.04-2007.12	Closed Off-Road Vehicle Engine QR20DE		○	GWB6805	
2.0 (110 kW)	2001.09-	Closed Off-Road Vehicle Engine QR20DE	●		GHA429002	K
	2001.09-	Closed Off-Road Vehicle Engine QR20DE	●		GWB3981	
	2001.09-	Closed Off-Road Vehicle Engine QR20DE		○	GWB6805	
2.0 4x4 (103 kW)	2001.07-	Closed Off-Road Vehicle Engine QR20DE	●		GHA429002	K
	2001.07-	Closed Off-Road Vehicle Engine QR20DE	●		GWB3981	
	2001.07-	Closed Off-Road Vehicle Engine QR20DE		○	GHA429003	
	2001.07-	Closed Off-Road Vehicle Engine QR20DE		○	GWB3997	
2.0 4x4 (110 kW)	2001.09-	Closed Off-Road Vehicle Engine QR20DE	●		GHA429002	K



	 YEAR		F	R	G-AP Ref.	KIT
NISSAN						
X-TRAIL (T30)						
2.0 4x4 (110 kW)	2001.09-	Closed Off-Road Vehicle Engine QR20DE	•		GWB3981	
	2001.09-	Closed Off-Road Vehicle Engine QR20DE		◦	GHA429003	
	2001.09-	Closed Off-Road Vehicle Engine QR20DE		◦	GWB3997	
2.0 4x4 (206 kW)	2001.06-	Closed Off-Road Vehicle	•		GHA429002	K
	2001.06-	Closed Off-Road Vehicle	•		GWB3981	
	2001.06-	Closed Off-Road Vehicle		◦	GHA429003	
	2001.06-	Closed Off-Road Vehicle		◦	GWB3997	
2.2 DCi (100 kW)	2005.04-2007.12	Closed Off-Road Vehicle Engine YD22DDTi	•		GHA429002	K
	2005.04-2007.12	Closed Off-Road Vehicle Engine YD22DDTi	•		GWB3981	
	2005.04-2007.12	Closed Off-Road Vehicle Engine YD22DDTi		◦	GWB6805	
2.2 DCi (84 kW)	2004.10-	Closed Off-Road Vehicle Engine YD22DDTi	•		GHA429002	K
	2004.10-	Closed Off-Road Vehicle Engine YD22DDTi	•		GWB3981	
	2004.10-	Closed Off-Road Vehicle Engine YD22DDTi		◦	GWB6805	
2.2 DCi 4x4 (100 kW)	2005.12-2007.12	Closed Off-Road Vehicle Engine YD22DDTi	•		GHA429002	K
	2005.12-2007.12	Closed Off-Road Vehicle Engine YD22DDTi	•		GWB3981	
	2005.12-2007.12	Closed Off-Road Vehicle Engine YD22DDTi		◦	GHA429003	
	2005.12-2007.12	Closed Off-Road Vehicle Engine YD22DDTi		◦	GWB3997	
2.2 DCi FWD (84 kW)	2001.06-2003.09	Closed Off-Road Vehicle Engine YD22DDTi	•		GWB3981	
	2001.06-2003.09	Closed Off-Road Vehicle Engine YD22DDTi		◦	GWB6805	
2.2 Di 4x4 (84 kW)	2001.07-	Closed Off-Road Vehicle Engine YD22ETi	•		GHA429002	K
	2001.07-	Closed Off-Road Vehicle Engine YD22ETi	•		GWB3981	
	2001.07-	Closed Off-Road Vehicle Engine YD22ETi		◦	GHA429003	
	2001.07-	Closed Off-Road Vehicle Engine YD22ETi		◦	GWB3997	
2.5 4x4 (121 kW)	2002.12-2007.12	Closed Off-Road Vehicle Engine QR25DE	•		GHA429002	K
	2002.12-2007.12	Closed Off-Road Vehicle Engine QR25DE	•		GWB3981	
	2002.12-2007.12	Closed Off-Road Vehicle Engine QR25DE		◦	GHA429003	
	2002.12-2007.12	Closed Off-Road Vehicle Engine QR25DE		◦	GWB3997	
2.5 4x4 (132 kW)	2002.11-	Closed Off-Road Vehicle Engine QR25DE	•		GHA429002	K
	2002.11-	Closed Off-Road Vehicle Engine QR25DE	•		GWB3981	
	2002.11-	Closed Off-Road Vehicle Engine QR25DE		◦	GHA429003	
	2002.11-	Closed Off-Road Vehicle Engine QR25DE		◦	GWB3997	
X-TRAIL (T31)						
2.0 (103 kW)	2008.06-	Closed Off-Road Vehicle Engine MR20DE	•		GHA329006	K
	2008.06-	Closed Off-Road Vehicle Engine MR20DE		◦	GHA325019	K
	2008.06-	Closed Off-Road Vehicle Engine MR20DE		◦	GHA400161	
2.0 (104 kW)	2007.06-	Closed Off-Road Vehicle Engine MR20DE	•		GHA329006	K
	2007.06-	Closed Off-Road Vehicle Engine MR20DE		◦	GHA325019	K
	2007.06-	Closed Off-Road Vehicle Engine MR20DE		◦	GHA400161	
2.0 DCi (110 kW)	2007.06-	Closed Off-Road Vehicle Engine M9R	•		GHA329006	K
	2007.06-	Closed Off-Road Vehicle Engine M9R	•		GHA329006	K
	2007.06-	Closed Off-Road Vehicle Engine M9R		◦	GHA325019	K
	2007.06-	Closed Off-Road Vehicle Engine M9R		◦	GHA400161	
	2007.06-	Closed Off-Road Vehicle Engine M9R		◦	GHA400161	
2.0 DCi (127 kW)	2007.07-2007.12	Closed Off-Road Vehicle Engine M9R760	•		GHA329006	K
	2007.07-2007.12	Closed Off-Road Vehicle Engine M9R760		◦	GHA325019	K
	2007.07-2007.12	Closed Off-Road Vehicle Engine M9R760		◦	GHA400161	
2.0 FWD (104 kW)	2007.03-2013.11	Closed Off-Road Vehicle Engine MR20DE	•		GHA329006	K
	2007.03-2013.11	Closed Off-Road Vehicle Engine MR20DE		◦	GHA400161	
2.5 4x4 (124 kW)	2007.06-	Closed Off-Road Vehicle Engine QR25DE	•		GHA329006	K
	2007.06-	Closed Off-Road Vehicle Engine QR25DE		◦	GHA325019	K
NISSAN DF						
TEANA (J32)						
2.0 (104 kW)	2010.11-	Saloon Engine MR20DE	•		GHA329019	
2.5 (136 kW)	2010.11-	Saloon Engine VQ25DE	•		GHA329019	
TIIDA QIDA (C11)						
1.6 (80 kW)	2005.07-	Hatchback Engine HR16DE	•		GHA325024	
	2005.07-	Hatchback Engine HR16DE		◦	GHA400180	
	2005.07-	Hatchback Engine HR16DE		◦	GHA400356	
TIIDA YIDA (C11)						
1.6 (80 kW)	2005.04-	Saloon Engine HR16DE	•		GHA325024	
	2005.04-	Saloon Engine HR16DE		◦	GHA400180	
	2005.04-	Saloon Engine HR16DE		◦	GHA400356	



	 YEAR		F	R	G-AP Ref.	KIT
OLDSMOBILE						
ALERO						
-	1999-2004			o	GHA400016	
CUTLASS SUPREME						
3.4 V6 (149 kW)	1990.09-	Coupe Engine 6V<X MPI>	•		GHA330001	K
OPEL						
ADAM						
1.0 (50 kW)	2013.07- 2013.07-	Hatchback Hatchback	•	o	GWB6550 GHA230092	S
1.0 (66 kW)	2014.07- 2014.07-	Hatchback Engine B 10 XFL Hatchback Engine B 10 XFL	•	o	GWB6550 GHA230092	S
1.0 (85 kW)	2014.07- 2014.07-	Hatchback Engine B 10 XFT Hatchback Engine B 10 XFT	•	o	GWB6550 GHA230092	S
1.2 (51 kW)	2012.10- 2012.10-	Hatchback Engine A12XEL Hatchback Engine A12XEL	•	o	GWB6550 GHA230092	S
1.2 (69 kW)	2013.07- 2013.07-	Hatchback Hatchback	•	o	GWB6550 GHA230092	S
1.4 (64 kW)	2012.10- 2012.10-	Hatchback Engine A14XEL Hatchback Engine A14XEL	•	o	GWB6550 GHA230092	S
1.4 (74 kW)	2012.10- 2012.10-	Hatchback Engine A14XER Hatchback Engine A14XER	•	o	GWB6550 GHA230092	S
1.4 LPG (64 kW)	2013.07- 2013.07-	Hatchback Engine A14XEL Hatchback Engine A14XEL	•	o	GWB6550 GHA230092	S
1.4 S (110 kW)	2014.11- 2014.11-	Hatchback Engine B 14 NEH Hatchback Engine B 14 NEH	•	o	GWB6550 GHA230092	S
AGILA (A) (H00)						
1.0 (44 kW)	2003.08-2007.12 2003.08-2007.12 2003.08-2007.12	Hatchback Engine Z10XEP Hatchback Engine Z10XEP Hatchback Engine Z10XEP	•	o	GWB3571 GWB6640 GWB6642	
1.0 12V (43 kW)	2000.09-2007.12 2000.09-2007.12 2000.09-2007.12 2000.09-2007.12	Hatchback Engine Z10XE Hatchback Engine Z10XE Hatchback Engine Z10XE Hatchback Engine Z10XE	•	o	GWB3571 GWB3572 GWB6640 GWB6642	
1.2 16V (55 kW)	2000.09-2007.12 2000.09-2007.12 2000.09-2007.12 2000.09-2007.12	Hatchback Engine Z12XE Hatchback Engine Z12XE Hatchback Engine Z12XE Hatchback Engine Z12XE	•	o	GWB3571 GWB3572 GWB6640 GWB6642	
1.2 16V Twinport (59 kW)	2004.07-2007.12 2004.07-2007.12 2004.07-2007.12	Hatchback Engine Z12XEP Hatchback Engine Z12XEP Hatchback Engine Z12XEP	•	o	GWB3571 GWB6640 GWB6642	
1.3 CDTi (51 kW)	2003.08-2007.12 2003.08-2007.12 2003.08-2007.12	Hatchback Engine Z13DT Hatchback Engine Z13DT Hatchback Engine Z13DT	•	o	GWB6643 GWB6640 GWB6642	
AGILA (B) (H08)						
1.0 (48 kW)	2008.04- 2008.04- 2008.04-	Hatchback Engine K10B Hatchback Engine K10B Hatchback Engine K10B	•	o	GWB7526 GWB6639 GWB7525	
1.0 (50 kW)	2011.07- 2011.07- 2011.07-	Hatchback Engine K10B Hatchback Engine K10B Hatchback Engine K10B	•	o	GWB7526 GWB6639 GWB7525	
1.0 LPG (48 kW)	2010.01- 2010.01- 2010.01-	Hatchback Engine K10B Hatchback Engine K10B Hatchback Engine K10B	•	o	GWB7526 GWB6639 GWB7525	
1.2 (63 kW)	2008.04- 2008.04- 2008.04-	Hatchback Engine K12B Hatchback Engine K12B Hatchback Engine K12B	•	o	GWB7526 GWB6639 GWB7525	
1.2 (69 kW)	2010.11- 2010.11- 2010.11-	Hatchback Engine K12B Hatchback Engine K12B Hatchback Engine K12B	•	o	GWB7526 GWB6639 GWB7525	
1.2 LPG (63 kW)	2008.04- 2008.04- 2008.04-	Hatchback Engine K12B Hatchback Engine K12B Hatchback Engine K12B	•	o	GWB7526 GWB6639 GWB7525	
1.3 CDTi (55 kW)	2008.04- 2008.04- 2008.04-	Hatchback Engine Z13DTJ/D13A Hatchback Engine Z13DTJ/D13A Hatchback Engine Z13DTJ/D13A	•	o	GWB7526 GWB6639 GWB7525	



	 YEAR		F	R	G-AP Ref.	KIT
OPEL						
ANTARA						
2.0 CDTi (110 kW)	2006.05-	Closed Off-Road Vehicle Engine Z20DMH/Z20S	•		GHA330010	K
	2006.05-	Closed Off-Road Vehicle Engine Z20DMH/Z20S		◦	GHA330008	K
2.0 CDTi (93 kW)	2007.03-	Closed Off-Road Vehicle Engine Z20S	•		GHA330010	K
	2007.03-	Closed Off-Road Vehicle Engine Z20S		◦	GHA330008	K
	2008.09-	Closed Off-Road Vehicle Engine Z20DM	•		GHA330010	K
	2008.09-	Closed Off-Road Vehicle Engine Z20DM		◦	GHA330008	K
2.0 CDTi 4x4 (110 kW)	2006.05-	Closed Off-Road Vehicle Engine Z20DMH/Z20S	•		GHA330010	K
	2006.05-	Closed Off-Road Vehicle Engine Z20DMH/Z20S	•		GHA330032	
	2006.05-	Closed Off-Road Vehicle Engine Z20DMH/Z20S		◦	GHA330008	K
2.2 CDTi (120 kW)	2010.12-	Closed Off-Road Vehicle Engine A22DM		◦	GHA330008	K
2.2 CDTi 4x4 (120 kW)	2010.12-	Closed Off-Road Vehicle Engine A22DM		◦	GHA330008	K
2.2 CDTi 4x4 (135 kW)	2010.12-	Closed Off-Road Vehicle Engine A22DMH		◦	GHA330008	K
2.4 (103 kW)	2008.09-	Closed Off-Road Vehicle Engine Z24XE	•		GHA330010	K
	2008.09-	Closed Off-Road Vehicle Engine Z24XE		◦	GHA330008	K
2.4 (104 kW)	2007.02-2008.03	Closed Off-Road Vehicle Engine Z24XED	•		GHA330010	K
	2007.02-2008.03	Closed Off-Road Vehicle Engine Z24XED		◦	GHA330008	K
2.4 (123 kW)	2010.12-	Closed Off-Road Vehicle Engine A24XE		◦	GHA330008	K
2.4 4x4 (103 kW)	2007.01-	Closed Off-Road Vehicle Engine Z24XE	•		GHA330010	K
	2007.01-	Closed Off-Road Vehicle Engine Z24XE		◦	GHA330008	K
2.4 4x4 (123 kW)	2010.12-	Closed Off-Road Vehicle Engine A24XE		◦	GHA330008	K
2.4 LPG (103 kW)	2008.10-	Closed Off-Road Vehicle Engine Z24XE	•		GHA330010	K
	2008.10-	Closed Off-Road Vehicle Engine Z24XE		◦	GHA330008	K
2.4 LPG 4x4 (103 kW)	2008.10-	Closed Off-Road Vehicle Engine Z24XE	•		GHA330010	K
	2008.10-	Closed Off-Road Vehicle Engine Z24XE		◦	GHA330008	K
3.0 (190 kW)	2010.11-	Closed Off-Road Vehicle Engine A30XH		◦	GHA330008	K
3.2 V6 (167 kW)	2007.03-	Closed Off-Road Vehicle Engine 10HM/Z32SEE	•		GHA330010	K
	2007.03-	Closed Off-Road Vehicle Engine 10HM/Z32SEE		◦	GHA330008	K
ASTEA H (L48)						
1.4 (59 kW)	2004.04-2004.10	Hatchback Engine Z 14 XEL	•		GHA333069	K
	2004.04-2004.10	Hatchback Engine Z 14 XEL	•		GHA333070	K
	2004.04-2004.10	Hatchback Engine Z 14 XEL		◦	GHA400133	K
	2004.04-2004.10	Hatchback Engine Z 14 XEL		◦	GHA400153	K
ASTRA F (51_, 52_)						
1.4 (55 kW)	1991.09-1993.09	Estate Engine 14NV	•		GHA422006	K
	1991.09-1993.09	Estate Engine 14NV	•		GHA422023	
	1991.09-1993.09	Estate Engine 14NV	•		GHA433007	
	1991.09-1993.09	Estate Engine 14NV	•		GWB3256	
	1991.09-1993.09	Estate Engine 14NV	•		GWB3403	
	1991.09-1993.09	Estate Engine 14NV			GWB0663	
	1991.09-1993.09	Estate Engine 14NV With ABS		◦	GHA400064	K
	1991.09-1993.09	Estate Engine 14NV Without ABS		◦	GHA400058	K
1.4 (60 kW)	1992.09-1998.01	Estate Engine 14SE	•		GHA422006	K
	1992.09-1998.01	Estate Engine 14SE	•		GHA422023	
	1992.09-1998.01	Estate Engine 14SE	•		GHA433007	
	1992.09-1998.01	Estate Engine 14SE	•		GWB0736	
	1992.09-1998.01	Estate Engine 14SE	•		GWB3256	
	1992.09-1998.01	Estate Engine 14SE	•		GWB3403	
	1992.09-1998.01	Estate Engine 14SE	•		GWB3410	
	1992.09-1998.01	Estate Engine 14SE			GWB0663	
	1992.09-1998.01	Estate Engine 14SE With ABS		◦	GHA400064	K
	1992.09-1998.01	Estate Engine 14SE Without ABS		◦	GHA400058	K
1.4 i (44 kW)	1991.09-1998.01	Estate Engine C14NZ	•		GHA422006	K
	1991.09-1998.01	Estate Engine C14NZ	•		GHA422023	
	1991.09-1998.01	Estate Engine C14NZ	•		GHA433007	
	1991.09-1998.01	Estate Engine C14NZ	•		GWB3256	
	1991.09-1998.01	Estate Engine C14NZ	•		GWB3403	
	1991.09-1998.01	Estate Engine C14NZ			GWB0663	
	1991.09-1998.01	Estate Engine C14NZ With ABS		◦	GHA400064	K
	1991.09-1998.01	Estate Engine C14NZ Without ABS		◦	GHA400058	K
1.4 i 16V (66 kW)	1996.02-1998.01	Estate Engine X14XE	•		GHA422006	K
	1996.02-1998.01	Estate Engine X14XE	•		GHA422023	
	1996.02-1998.01	Estate Engine X14XE	•		GHA433007	
	1996.02-1998.01	Estate Engine X14XE	•		GWB3403	
	1996.02-1998.01	Estate Engine X14XE With ABS		◦	GHA400064	K



	 YEAR		F	R	G-AP Ref.	KIT
OPEL						
ASTRA F (51_, 52_)						
1.4 i 16V (66 kW)	1996.02-1998.01	Estate Engine X14XE Without ABS		o	GHA400058	K
1.4 Si (60 kW)	1992.03-1998.01	Estate Engine C14SE	•		GHA422006	K
	1992.03-1998.01	Estate Engine C14SE	•		GHA422023	
	1992.03-1998.01	Estate Engine C14SE	•		GHA433007	
	1992.03-1998.01	Estate Engine C14SE	•		GWB0736	
	1992.03-1998.01	Estate Engine C14SE	•		GWB3256	
	1992.03-1998.01	Estate Engine C14SE	•		GWB3403	
	1992.03-1998.01	Estate Engine C14SE	•		GWB3410	
	1992.03-1998.01	Estate Engine C14SE			GWB0663	
	1992.03-1998.01	Estate Engine C14SE With ABS		o	GHA400064	K
1.6 (55 kW)	1992.03-1998.01	Estate Engine C14SE Without ABS		o	GHA400058	K
	1995.09-1998.01	Estate Engine 16LZ2	•		GHA422006	K
	1995.09-1998.01	Estate Engine 16LZ2	•		GHA422023	
	1995.09-1998.01	Estate Engine 16LZ2	•		GHA433007	
	1995.09-1998.01	Estate Engine 16LZ2	•		GHA433019	
	1995.09-1998.01	Estate Engine 16LZ2	•		GWB0736	
	1995.09-1998.01	Estate Engine 16LZ2	•		GWB3403	
	1995.09-1998.01	Estate Engine 16LZ2	•		GWB3410	
	1995.09-1998.01	Estate Engine 16LZ2 With ABS		o	GHA400064	K
1.6 i (52 kW)	1995.09-1998.01	Estate Engine 16LZ2 Without ABS		o	GHA400058	K
	1993.05-1996.07	Estate Engine X16SZ	•		GHA422006	K
	1993.05-1996.07	Estate Engine X16SZ	•		GHA422023	
	1993.05-1996.07	Estate Engine X16SZ	•		GHA433007	
	1993.05-1996.07	Estate Engine X16SZ	•		GWB0736	
	1993.05-1996.07	Estate Engine X16SZ	•		GWB3403	
	1993.05-1996.07	Estate Engine X16SZ	•		GWB3410	
	1993.05-1996.07	Estate Engine X16SZ With ABS		o	GHA400064	K
	1993.05-1996.07	Estate Engine X16SZ Without ABS		o	GHA400058	K
1.6 i (55 kW)	1991.09-1998.01	Estate Engine C16NZ/X16SZR	•		GHA422006	K
	1991.09-1998.01	Estate Engine C16NZ/X16SZR	•		GHA422023	
	1991.09-1998.01	Estate Engine C16NZ/X16SZR	•		GHA433007	
	1991.09-1998.01	Estate Engine C16NZ/X16SZR	•		GWB0736	
	1991.09-1998.01	Estate Engine C16NZ/X16SZR	•		GWB3256	
	1991.09-1998.01	Estate Engine C16NZ/X16SZR	•		GWB3403	
	1991.09-1998.01	Estate Engine C16NZ/X16SZR	•		GWB3410	
	1991.09-1998.01	Estate Engine C16NZ/X16SZR			GWB0663	
	1991.09-1998.01	Estate Engine C16NZ/X16SZR With ABS		o	GHA400064	K
1.6 i 16V (74 kW)	1991.09-1998.01	Estate Engine C16NZ/X16SZR Without ABS		o	GHA400058	K
	1994.08-1998.01	Estate Engine X16XEL	•		GHA422006	K
	1994.08-1998.01	Estate Engine X16XEL	•		GHA422023	
	1994.08-1998.01	Estate Engine X16XEL	•		GHA433007	
	1994.08-1998.01	Estate Engine X16XEL	•		GWB0736	
	1994.08-1998.01	Estate Engine X16XEL	•		GWB3403	
	1994.08-1998.01	Estate Engine X16XEL	•		GWB3410	
	1994.08-1998.01	Estate Engine X16XEL With ABS		o	GHA400064	K
	1994.08-1998.01	Estate Engine X16XEL Without ABS		o	GHA400058	K
1.6 Si (74 kW)	1992.03-1994.12	Estate Engine C16SE	•		GHA422006	K
	1992.03-1994.12	Estate Engine C16SE	•		GHA422023	
	1992.03-1994.12	Estate Engine C16SE	•		GHA433007	
	1992.03-1994.12	Estate Engine C16SE	•		GWB0736	
	1992.03-1994.12	Estate Engine C16SE	•		GWB3256	
	1992.03-1994.12	Estate Engine C16SE	•		GWB3403	
	1992.03-1994.12	Estate Engine C16SE			GWB0663	
	1992.03-1994.12	Estate Engine C16SE With ABS		o	GHA400064	K
	1992.03-1994.12	Estate Engine C16SE Without ABS		o	GHA400058	K
1.7 D (42 kW)	1991.12-1992.09	Estate Engine 17D	•		GHA422006	K
	1991.12-1992.09	Estate Engine 17D	•		GHA422023	
	1991.12-1992.09	Estate Engine 17D	•		GHA433007	
	1991.12-1992.09	Estate Engine 17D	•		GHA433013	
	1991.12-1992.09	Estate Engine 17D	•		GWB0736	
	1991.12-1992.09	Estate Engine 17D	•		GWB3410	
	1991.12-1992.09	Estate Engine 17D With ABS		o	GHA400064	K
1.7 D (44 kW)	1991.12-1992.09	Estate Engine 17D Without ABS		o	GHA400058	K
	1992.07-1998.01	Estate Engine 17DR	•		GHA422006	K



	 YEAR		F	R	G-AP Ref.	KIT
OPEL						
ASTRA F (51_, 52_)						
1.7 D (44 kW)	1992.07-1998.01	Estate Engine 17DR	•		GHA422023	
	1992.07-1998.01	Estate Engine 17DR	•		GHA433007	
	1992.07-1998.01	Estate Engine 17DR	•		GHA433013	
	1992.07-1998.01	Estate Engine 17DR	•		GWB0736	
	1992.07-1998.01	Estate Engine 17DR	•		GWB3410	
	1992.07-1998.01	Estate Engine 17DR With ABS		○	GHA400064	K
	1992.07-1998.01	Estate Engine 17DR Without ABS		○	GHA400058	K
1.7 TD (50 kW)	1994.11-1998.01	Estate Engine X17DTL	•		GHA422006	K
	1994.11-1998.01	Estate Engine X17DTL	•		GHA422023	
	1994.11-1998.01	Estate Engine X17DTL	•		GHA433007	
	1994.11-1998.01	Estate Engine X17DTL	•		GHA433013	
	1994.11-1998.01	Estate Engine X17DTL	•		GWB0736	
	1994.11-1998.01	Estate Engine X17DTL	•		GWB3410	
	1994.11-1998.01	Estate Engine X17DTL With ABS		○	GHA400064	K
1994.11-1998.01	Estate Engine X17DTL Without ABS		○	GHA400058	K	
1.7 TDS (60 kW)	1991.12-1998.01	Estate Engine 17DT(TC4EE1)/X17DT(TC4EE1)	•		GHA422006	K
	1991.12-1998.01	Estate Engine 17DT(TC4EE1)/X17DT(TC4EE1)	•		GHA422023	
	1991.12-1998.01	Estate Engine 17DT(TC4EE1)/X17DT(TC4EE1)	•		GHA433007	
	1991.12-1998.01	Estate Engine 17DT(TC4EE1)/X17DT(TC4EE1)	•		GHA433013	
	1991.12-1998.01	Estate Engine 17DT(TC4EE1)/X17DT(TC4EE1)	•		GWB0736	
	1991.12-1998.01	Estate Engine 17DT(TC4EE1)/X17DT(TC4EE1)	•		GWB3410	
	1991.12-1998.01	Estate Engine 17DT(TC4EE1)/X17DT(TC4EE1) With ABS		○	GHA400064	K
1991.12-1998.01	Estate Engine 17DT(TC4EE1)/X17DT(TC4EE1) Without ABS		○	GHA400058	K	
1.8 i (66 kW)	1991.09-1998.01	Estate Engine C18NZ	•		GHA422006	K
	1991.09-1998.01	Estate Engine C18NZ	•		GHA422023	
	1991.09-1998.01	Estate Engine C18NZ	•		GHA433007	
	1991.09-1998.01	Estate Engine C18NZ	•		GHA433013	
	1991.09-1998.01	Estate Engine C18NZ	•		GWB0736	
	1991.09-1998.01	Estate Engine C18NZ	•		GWB3410	
	1991.09-1998.01	Estate Engine C18NZ With ABS		○	GHA400064	K
1991.09-1998.01	Estate Engine C18NZ Without ABS		○	GHA400058	K	
1.8 i 16V (85 kW)	1994.07-1998.01	Estate Engine C18XEL/X18XE	•		GHA422006	K
	1994.07-1998.01	Estate Engine C18XEL/X18XE	•		GHA422023	
	1994.07-1998.01	Estate Engine C18XEL/X18XE	•		GHA433007	
	1994.07-1998.01	Estate Engine C18XEL/X18XE	•		GHA433013	
	1994.07-1998.01	Estate Engine C18XEL/X18XE	•		GHA433019	
	1994.07-1998.01	Estate Engine C18XEL/X18XE	•		GWB0736	
	1994.07-1998.01	Estate Engine C18XEL/X18XE	•		GWB3410	
	1994.07-1998.01	Estate Engine C18XEL/X18XE With ABS		○	GHA400064	K
1994.07-1998.01	Estate Engine C18XEL/X18XE Without ABS		○	GHA400058	K	
1.8 i 16V (92 kW)	1993.06-1998.01	Estate Engine C18XE	•		GHA422006	K
	1993.06-1998.01	Estate Engine C18XE	•		GHA422023	
	1993.06-1998.01	Estate Engine C18XE	•		GHA433007	
	1993.06-1998.01	Estate Engine C18XE	•		GHA433013	
	1993.06-1998.01	Estate Engine C18XE	•		GHA433019	
	1993.06-1998.01	Estate Engine C18XE	•		GWB0736	
	1993.06-1998.01	Estate Engine C18XE	•		GWB3410	
	1993.06-1998.01	Estate Engine C18XE With ABS		○	GHA400064	K
1993.06-1998.01	Estate Engine C18XE Without ABS		○	GHA400058	K	
2.0 i (85 kW)	1991.09-1994.07	Estate Engine C20NE	•		GHA422006	K
	1991.09-1994.07	Estate Engine C20NE	•		GHA422023	
	1991.09-1994.07	Estate Engine C20NE	•		GHA433007	
	1991.09-1994.07	Estate Engine C20NE	•		GHA433013	
	1991.09-1994.07	Estate Engine C20NE	•		GHA433019	
	1991.09-1994.07	Estate Engine C20NE	•		GWB0736	
	1991.09-1994.07	Estate Engine C20NE	•		GWB3410	
	1991.09-1994.07	Estate Engine C20NE With ABS		○	GHA400064	K
1991.09-1994.07	Estate Engine C20NE Without ABS		○	GHA400058	K	
2.0 i 16V (100 kW)	1995.02-1998.01	Estate Engine X20XEV	•		GHA422006	K
	1995.02-1998.01	Estate Engine X20XEV	•		GHA422023	
	1995.02-1998.01	Estate Engine X20XEV	•		GHA433007	
	1995.02-1998.01	Estate Engine X20XEV	•		GHA433013	
	1995.02-1998.01	Estate Engine X20XEV	•		GWB0736	
1995.02-1998.01	Estate Engine X20XEV	•		GWB3410		



	 YEAR		F	R	G-AP Ref.	KIT
OPEL						
ASTRA F (51_, 52_)						
2.0 i 16V (100 kW)	1995.02-1998.01	Estate Engine X20XE With ABS		o	GHA400064	K
	1995.02-1998.01	Estate Engine X20XE Without ABS		o	GHA400058	K
2.0 i 16V (110 kW)	1993.03-1998.01	Estate Engine C20XE	•		GHA422006	K
	1993.03-1998.01	Estate Engine C20XE	•		GHA422023	
	1993.03-1998.01	Estate Engine C20XE	•		GHA433007	
	1993.03-1998.01	Estate Engine C20XE	•		GHA433013	
	1993.03-1998.01	Estate Engine C20XE	•		GWB0736	
	1993.03-1998.01	Estate Engine C20XE	•		GWB3410	
	1993.03-1998.01	Estate Engine C20XE With ABS		o	GHA400064	K
ASTRA F (53_, 54_, 58_, 59_)						
1.4 (55 kW)	1991.09-1993.09	Hatchback Engine 14NV	•		GHA422006	K
	1991.09-1993.09	Hatchback Engine 14NV	•		GHA422023	
	1991.09-1993.09	Hatchback Engine 14NV	•		GHA433007	
	1991.09-1993.09	Hatchback Engine 14NV	•		GWB3256	
	1991.09-1993.09	Hatchback Engine 14NV	•		GWB3403	
	1991.09-1993.09	Hatchback Engine 14NV			GWB0663	
	1991.09-1993.09	Hatchback Engine 14NV With ABS		o	GHA400064	K
	1991.09-1993.09	Hatchback Engine 14NV Without ABS		o	GHA400058	K
1.4 (60 kW)	1992.09-1998.01	Hatchback Engine 14SE	•		GHA422006	K
	1992.09-1998.01	Hatchback Engine 14SE	•		GHA422023	
	1992.09-1998.01	Hatchback Engine 14SE	•		GHA433007	
	1992.09-1998.01	Hatchback Engine 14SE	•		GWB0736	
	1992.09-1998.01	Hatchback Engine 14SE	•		GWB3256	
	1992.09-1998.01	Hatchback Engine 14SE	•		GWB3403	
	1992.09-1998.01	Hatchback Engine 14SE	•		GWB3410	
	1992.09-1998.01	Hatchback Engine 14SE			GWB0663	
	1992.09-1998.01	Hatchback Engine 14SE With ABS		o	GHA400064	K
	1992.09-1998.01	Hatchback Engine 14SE Without ABS		o	GHA400058	K
1.4 i (44 kW)	1992.03-1998.01	Hatchback Engine C14NZ	•		GHA422006	K
	1992.03-1998.01	Hatchback Engine C14NZ	•		GHA422023	
	1992.03-1998.01	Hatchback Engine C14NZ	•		GHA433007	
	1992.03-1998.01	Hatchback Engine C14NZ	•		GWB3256	
	1992.03-1998.01	Hatchback Engine C14NZ	•		GWB3403	
	1992.03-1998.01	Hatchback Engine C14NZ			GWB0663	
	1992.03-1998.01	Hatchback Engine C14NZ With ABS		o	GHA400064	K
	1992.03-1998.01	Hatchback Engine C14NZ Without ABS		o	GHA400058	K
1.4 i 16V (66 kW)	1996.01-1998.01	Hatchback Engine X14XE	•		GHA422006	K
	1996.01-1998.01	Hatchback Engine X14XE	•		GHA422023	
	1996.01-1998.01	Hatchback Engine X14XE	•		GHA433007	
	1996.01-1998.01	Hatchback Engine X14XE	•		GWB3403	
	1996.01-1998.01	Hatchback Engine X14XE With ABS		o	GHA400064	K
	1996.01-1998.01	Hatchback Engine X14XE Without ABS		o	GHA400058	K
1.4 Si (60 kW)	1992.03-1998.01	Hatchback Engine C14SE	•		GHA422006	K
	1992.03-1998.01	Hatchback Engine C14SE	•		GHA422023	
	1992.03-1998.01	Hatchback Engine C14SE	•		GHA433007	
	1992.03-1998.01	Hatchback Engine C14SE	•		GWB0736	
	1992.03-1998.01	Hatchback Engine C14SE	•		GWB3256	
	1992.03-1998.01	Hatchback Engine C14SE	•		GWB3403	
	1992.03-1998.01	Hatchback Engine C14SE	•		GWB3410	
	1992.03-1998.01	Hatchback Engine C14SE			GWB0663	
	1992.03-1998.01	Hatchback Engine C14SE With ABS		o	GHA400064	K
	1992.03-1998.01	Hatchback Engine C14SE Without ABS		o	GHA400058	K
1.6 (55 kW)	1995.09-1998.01	Hatchback Engine 16LZ2/16NZR	•		GHA422006	K
	1995.09-1998.01	Hatchback Engine 16LZ2/16NZR	•		GHA422023	
	1995.09-1998.01	Hatchback Engine 16LZ2/16NZR	•		GHA433007	
	1995.09-1998.01	Hatchback Engine 16LZ2/16NZR	•		GHA433019	
	1995.09-1998.01	Hatchback Engine 16LZ2/16NZR	•		GWB0736	
	1995.09-1998.01	Hatchback Engine 16LZ2/16NZR	•		GWB3403	
	1995.09-1998.01	Hatchback Engine 16LZ2/16NZR	•		GWB3410	
	1995.09-1998.01	Hatchback Engine 16LZ2/16NZR With ABS		o	GHA400064	K
	1995.09-1998.01	Hatchback Engine 16LZ2/16NZR Without ABS		o	GHA400058	K
1.6 i (52 kW)	1993.05-1996.07	Hatchback Engine X16SZ	•		GHA422006	K
	1993.05-1996.07	Hatchback Engine X16SZ	•		GHA422023	
	1993.05-1996.07	Hatchback Engine X16SZ	•		GHA433007	



	 YEAR		F	R	G-AP Ref.	KIT
OPEL						
ASTRA F (53_, 54_, 58_, 59_)						
1.6 i (52 kW)	1993.05-1996.07	Hatchback Engine X16SZ	•		GWB0736	
	1993.05-1996.07	Hatchback Engine X16SZ	•		GWB3256	
	1993.05-1996.07	Hatchback Engine X16SZ	•		GWB3403	
	1993.05-1996.07	Hatchback Engine X16SZ	•		GWB3410	
	1993.05-1996.07	Hatchback Engine X16SZ			GWB0663	
	1993.05-1996.07	Hatchback Engine X16SZ With ABS		○	GHA400064	K
	1993.05-1996.07	Hatchback Engine X16SZ Without ABS		○	GHA400058	K
1.6 i (55 kW)	1991.09-1998.01	Hatchback Engine C16NZ/X16SZR	•		GHA422006	K
	1991.09-1998.01	Hatchback Engine C16NZ/X16SZR	•		GHA422023	
	1991.09-1998.01	Hatchback Engine C16NZ/X16SZR	•		GHA433007	
	1991.09-1998.01	Hatchback Engine C16NZ/X16SZR	•		GWB0736	
	1991.09-1998.01	Hatchback Engine C16NZ/X16SZR	•		GWB3256	
	1991.09-1998.01	Hatchback Engine C16NZ/X16SZR	•		GWB3403	
	1991.09-1998.01	Hatchback Engine C16NZ/X16SZR	•		GWB3410	
	1991.09-1998.01	Hatchback Engine C16NZ/X16SZR			GWB0663	
1.6 i 16V (74 kW)	1991.09-1998.01	Hatchback Engine C16NZ/X16SZR With ABS		○	GHA400064	K
	1991.09-1998.01	Hatchback Engine C16NZ/X16SZR Without ABS		○	GHA400058	K
	1994.08-1998.01	Hatchback Engine X16XEL	•		GHA422006	K
	1994.08-1998.01	Hatchback Engine X16XEL	•		GHA422023	
	1994.08-1998.01	Hatchback Engine X16XEL	•		GHA433007	
	1994.08-1998.01	Hatchback Engine X16XEL	•		GWB0736	
	1994.08-1998.01	Hatchback Engine X16XEL	•		GWB3403	
	1994.08-1998.01	Hatchback Engine X16XEL	•		GWB3410	
1.6 Si (74 kW)	1994.08-1998.01	Hatchback Engine X16XEL With ABS		○	GHA400064	K
	1994.08-1998.01	Hatchback Engine X16XEL Without ABS		○	GHA400058	K
	1992.03-1994.12	Hatchback Engine C16SE	•		GHA422006	K
	1992.03-1994.12	Hatchback Engine C16SE	•		GHA422023	
	1992.03-1994.12	Hatchback Engine C16SE	•		GHA433007	
	1992.03-1994.12	Hatchback Engine C16SE	•		GWB0736	
	1992.03-1994.12	Hatchback Engine C16SE	•		GWB3256	
	1992.03-1994.12	Hatchback Engine C16SE	•		GWB3403	
1.7 D (42 kW)	1992.03-1994.12	Hatchback Engine C16SE			GWB0663	
	1992.03-1994.12	Hatchback Engine C16SE With ABS		○	GHA400064	K
	1992.03-1994.12	Hatchback Engine C16SE Without ABS		○	GHA400058	K
	1991.12-1992.09	Hatchback Engine 17D	•		GHA422006	K
	1991.12-1992.09	Hatchback Engine 17D	•		GHA422023	
	1991.12-1992.09	Hatchback Engine 17D	•		GHA433007	
	1991.12-1992.09	Hatchback Engine 17D	•		GHA433013	
	1991.12-1992.09	Hatchback Engine 17D	•		GWB0736	
1.7 D (44 kW)	1991.12-1992.09	Hatchback Engine 17D	•		GWB3410	
	1991.12-1992.09	Hatchback Engine 17D With ABS		○	GHA400064	K
	1991.12-1992.09	Hatchback Engine 17D Without ABS		○	GHA400058	K
	1992.07-1998.01	Hatchback Engine 17DR	•		GHA422006	K
	1992.07-1998.01	Hatchback Engine 17DR	•		GHA422023	
	1992.07-1998.01	Hatchback Engine 17DR	•		GHA433007	
	1992.07-1998.01	Hatchback Engine 17DR	•		GHA433013	
	1992.07-1998.01	Hatchback Engine 17DR	•		GWB0736	
1.7 TD (50 kW)	1992.07-1998.01	Hatchback Engine 17DR	•		GWB3410	
	1992.07-1998.01	Hatchback Engine 17DR With ABS		○	GHA400064	K
	1992.07-1998.01	Hatchback Engine 17DR Without ABS		○	GHA400058	K
	1994.11-1998.01	Hatchback Engine X17DTL	•		GHA422006	K
	1994.11-1998.01	Hatchback Engine X17DTL	•		GHA422023	
	1994.11-1998.01	Hatchback Engine X17DTL	•		GHA433007	
	1994.11-1998.01	Hatchback Engine X17DTL	•		GHA433013	
	1994.11-1998.01	Hatchback Engine X17DTL	•		GWB0736	
1.7 TDS (60 kW)	1994.11-1998.01	Hatchback Engine X17DTL	•		GWB3410	
	1994.11-1998.01	Hatchback Engine X17DTL With ABS		○	GHA400064	K
	1994.11-1998.01	Hatchback Engine X17DTL Without ABS		○	GHA400058	K
	1991.12-1998.01	Hatchback Engine 17DT(TC4EE1)/X17DT(TC4EE1)	•		GHA422006	K
	1991.12-1998.01	Hatchback Engine 17DT(TC4EE1)/X17DT(TC4EE1)	•		GHA422023	
	1991.12-1998.01	Hatchback Engine 17DT(TC4EE1)/X17DT(TC4EE1)	•		GHA433007	
1.7 TDS (60 kW)	1991.12-1998.01	Hatchback Engine 17DT(TC4EE1)/X17DT(TC4EE1)	•		GHA433013	
	1991.12-1998.01	Hatchback Engine 17DT(TC4EE1)/X17DT(TC4EE1)	•		GWB0736	
	1991.12-1998.01	Hatchback Engine 17DT(TC4EE1)/X17DT(TC4EE1)	•		GWB3410	
	1991.12-1998.01	Hatchback Engine 17DT(TC4EE1)/X17DT(TC4EE1)	•		GWB3410	



	 YEAR		F	R	G-AP Ref.	KIT
OPEL						
ASTRA F (53_, 54_, 58_, 59_)						
1.7 TDS (60 kW)	1991.12-1998.01	Hatchback Engine 17DT(TC4EE1)/X17DT(TC4EE1) With ABS		o	GHA400064	K
	1991.12-1998.01	Hatchback Engine 17DT(TC4EE1)/X17DT(TC4EE1) Without ABS		o	GHA400058	K
1.8 i (66 kW)	1991.09-1998.01	Hatchback Engine C18NZ	•		GHA422006	K
	1991.09-1998.01	Hatchback Engine C18NZ	•		GHA422023	
	1991.09-1998.01	Hatchback Engine C18NZ	•		GHA433007	
	1991.09-1998.01	Hatchback Engine C18NZ	•		GHA433013	
	1991.09-1998.01	Hatchback Engine C18NZ	•		GWB0736	
	1991.09-1998.01	Hatchback Engine C18NZ	•		GWB3410	
	1991.09-1998.01	Hatchback Engine C18NZ With ABS		o	GHA400064	K
	1991.09-1998.01	Hatchback Engine C18NZ Without ABS		o	GHA400058	K
1.8 i 16V (85 kW)	1994.09-1998.01	Hatchback Engine C18XEL/X18XE	•		GHA422006	K
	1994.09-1998.01	Hatchback Engine C18XEL/X18XE	•		GHA422023	
	1994.09-1998.01	Hatchback Engine C18XEL/X18XE	•		GHA433007	
	1994.09-1998.01	Hatchback Engine C18XEL/X18XE	•		GHA433013	
	1994.09-1998.01	Hatchback Engine C18XEL/X18XE	•		GHA433019	
	1994.09-1998.01	Hatchback Engine C18XEL/X18XE	•		GWB0736	
	1994.09-1998.01	Hatchback Engine C18XEL/X18XE	•		GWB3410	
	1994.09-1998.01	Hatchback Engine C18XEL/X18XE With ABS		o	GHA400064	K
1.8 i 16V (92 kW)	1993.06-1994.08	Hatchback Engine C18XE	•		GHA422006	K
	1993.06-1994.08	Hatchback Engine C18XE	•		GHA422023	
	1993.06-1994.08	Hatchback Engine C18XE	•		GHA433007	
	1993.06-1994.08	Hatchback Engine C18XE	•		GHA433013	
	1993.06-1994.08	Hatchback Engine C18XE	•		GHA433019	
	1993.06-1994.08	Hatchback Engine C18XE	•		GWB0736	
	1993.06-1994.08	Hatchback Engine C18XE	•		GWB3410	
	1993.06-1994.08	Hatchback Engine C18XE With ABS		o	GHA400064	K
2.0 GSi 16V (110 kW)	1993.06-1994.08	Hatchback Engine C18XE Without ABS		o	GHA400058	K
	1991.09-1998.01	Hatchback Engine C20XE	•		GHA433013	
	1991.09-1998.01	Hatchback Engine C20XE	•		GWB0736	
	1991.09-1998.01	Hatchback Engine C20XE	•		GWB3410	
	1991.09-1998.01	Hatchback Engine C20XE With ABS		o	GHA400064	K
2.0 i (85 kW)	1991.09-1998.01	Hatchback Engine C20XE Without ABS		o	GHA400058	K
	1991.09-1998.01	Hatchback Engine C20NE	•		GHA422006	K
	1991.09-1998.01	Hatchback Engine C20NE	•		GHA422023	
	1991.09-1998.01	Hatchback Engine C20NE	•		GHA433007	
	1991.09-1998.01	Hatchback Engine C20NE	•		GHA433013	
	1991.09-1998.01	Hatchback Engine C20NE	•		GHA433019	
	1991.09-1998.01	Hatchback Engine C20NE	•		GWB0736	
	1991.09-1998.01	Hatchback Engine C20NE	•		GWB3410	
2.0 i 16V (100 kW)	1991.09-1998.01	Hatchback Engine C20NE With ABS		o	GHA400064	K
	1991.09-1998.01	Hatchback Engine C20NE Without ABS		o	GHA400058	K
	1995.02-1998.01	Hatchback Engine X20XEV	•		GHA422006	K
	1995.02-1998.01	Hatchback Engine X20XEV	•		GHA422023	
	1995.02-1998.01	Hatchback Engine X20XEV	•		GHA433007	
	1995.02-1998.01	Hatchback Engine X20XEV	•		GHA433013	
	1995.02-1998.01	Hatchback Engine X20XEV	•		GWB0736	
	1995.02-1998.01	Hatchback Engine X20XEV	•		GWB3410	
ASTRA F (53_B)	1995.02-1998.01	Hatchback Engine X20XEV With ABS		o	GHA400064	K
	1995.02-1998.01	Hatchback Engine X20XEV Without ABS		o	GHA400058	K
ASTRA F (53_B)						
1.4 i 16V (66 kW)	1996.01-2001.03	Convertible Engine X14XE	•		GHA422006	K
	1996.01-2001.03	Convertible Engine X14XE	•		GHA422023	
	1996.01-2001.03	Convertible Engine X14XE	•		GHA433007	
	1996.01-2001.03	Convertible Engine X14XE	•		GWB3403	
	1996.01-2001.03	Convertible Engine X14XE With ABS		o	GHA400064	K
	1996.01-2001.03	Convertible Engine X14XE Without ABS		o	GHA400058	K
1.4 Si (60 kW)	1993.05-2001.03	Convertible Engine C14SE	•		GHA422006	K
	1993.05-2001.03	Convertible Engine C14SE	•		GHA422023	
	1993.05-2001.03	Convertible Engine C14SE	•		GHA433007	
	1993.05-2001.03	Convertible Engine C14SE	•		GWB0736	
	1993.05-2001.03	Convertible Engine C14SE	•		GWB3256	
	1993.05-2001.03	Convertible Engine C14SE	•		GWB3403	
	1993.05-2001.03	Convertible Engine C14SE	•		GWB3410	



	 YEAR		F	R	G-AP Ref.	KIT
OPEL						
ASTRA F (53_B)						
1.4 Si (60 kW)	1993.05-2001.03	Convertible Engine C14SE			GWB0663	
	1993.05-2001.03	Convertible Engine C14SE With ABS		o	GHA400064	K
	1993.05-2001.03	Convertible Engine C14SE Without ABS		o	GHA400058	K
1.6 i (52 kW)	1993.03-1996.08	Convertible Engine X16SZ	•		GHA422006	K
	1993.03-1996.08	Convertible Engine X16SZ	•		GHA422023	
	1993.03-1996.08	Convertible Engine X16SZ	•		GHA433007	
	1993.03-1996.08	Convertible Engine X16SZ	•		GWB0736	
	1993.03-1996.08	Convertible Engine X16SZ	•		GWB3403	
	1993.03-1996.08	Convertible Engine X16SZ	•		GWB3410	
	1993.03-1996.08	Convertible Engine X16SZ With ABS		o	GHA400064	K
	1993.03-1996.08	Convertible Engine X16SZ Without ABS		o	GHA400058	K
1.6 i (55 kW)	1996.01-2001.03	Convertible Engine X16SZR	•		GHA422006	K
	1996.01-2001.03	Convertible Engine X16SZR	•		GHA422023	
	1996.01-2001.03	Convertible Engine X16SZR	•		GHA433007	
	1996.01-2001.03	Convertible Engine X16SZR	•		GWB0736	
	1996.01-2001.03	Convertible Engine X16SZR	•		GWB3403	
	1996.01-2001.03	Convertible Engine X16SZR	•		GWB3410	
	1996.01-2001.03	Convertible Engine X16SZR With ABS		o	GHA400064	K
	1996.01-2001.03	Convertible Engine X16SZR Without ABS		o	GHA400058	K
1.8 i 16V (85 kW)	1994.11-2001.03	Convertible Engine C18XEL/X18XE	•		GHA422006	K
	1994.11-2001.03	Convertible Engine C18XEL/X18XE	•		GHA422023	
	1994.11-2001.03	Convertible Engine C18XEL/X18XE	•		GHA433007	
	1994.11-2001.03	Convertible Engine C18XEL/X18XE	•		GHA433013	
	1994.11-2001.03	Convertible Engine C18XEL/X18XE	•		GHA433019	
	1994.11-2001.03	Convertible Engine C18XEL/X18XE	•		GWB0736	
	1994.11-2001.03	Convertible Engine C18XEL/X18XE	•		GWB3410	
	1994.11-2001.03	Convertible Engine C18XEL/X18XE With ABS		o	GHA400064	K
1994.11-2001.03	Convertible Engine C18XEL/X18XE Without ABS		o	GHA400058	K	
2.0 i (85 kW)	1993.03-1994.10	Convertible Engine C20NE	•		GHA422006	K
	1993.03-1994.10	Convertible Engine C20NE	•		GHA422023	
	1993.03-1994.10	Convertible Engine C20NE	•		GHA433007	
	1993.03-1994.10	Convertible Engine C20NE	•		GHA433013	
	1993.03-1994.10	Convertible Engine C20NE	•		GHA433019	
	1993.03-1994.10	Convertible Engine C20NE	•		GWB0736	
	1993.03-1994.10	Convertible Engine C20NE	•		GWB3410	
	1993.03-1994.10	Convertible Engine C20NE With ABS		o	GHA400064	K
	1993.03-1994.10	Convertible Engine C20NE Without ABS		o	GHA400058	K
ASTRA F (56_, 57_)						
1.4 (55 kW)	1991.09-1993.09	Saloon Engine 14NV	•		GHA422006	K
	1991.09-1993.09	Saloon Engine 14NV	•		GHA422023	
	1991.09-1993.09	Saloon Engine 14NV	•		GHA433007	
	1991.09-1993.09	Saloon Engine 14NV	•		GWB3256	
	1991.09-1993.09	Saloon Engine 14NV	•		GWB3403	
	1991.09-1993.09	Saloon Engine 14NV			GWB0663	
	1991.09-1993.09	Saloon Engine 14NV With ABS		o	GHA400064	K
	1991.09-1993.09	Saloon Engine 14NV Without ABS		o	GHA400058	K
1.4 (60 kW)	1992.09-1998.09	Saloon Engine 14SE	•		GHA422006	K
	1992.09-1998.09	Saloon Engine 14SE	•		GHA422023	
	1992.09-1998.09	Saloon Engine 14SE	•		GHA433007	
	1992.09-1998.09	Saloon Engine 14SE	•		GWB0736	
	1992.09-1998.09	Saloon Engine 14SE	•		GWB3256	
	1992.09-1998.09	Saloon Engine 14SE	•		GWB3403	
	1992.09-1998.09	Saloon Engine 14SE	•		GWB3410	
	1992.09-1998.09	Saloon Engine 14SE			GWB0663	
	1992.09-1998.09	Saloon Engine 14SE With ABS		o	GHA400064	K
	1992.09-1998.09	Saloon Engine 14SE Without ABS		o	GHA400058	K
1.4 i (44 kW)	1991.09-1998.09	Saloon Engine C14NZ/X14NZ	•		GHA422006	K
	1991.09-1998.09	Saloon Engine C14NZ/X14NZ	•		GHA422023	
	1991.09-1998.09	Saloon Engine C14NZ/X14NZ	•		GHA433007	
	1991.09-1998.09	Saloon Engine C14NZ/X14NZ	•		GWB3256	
	1991.09-1998.09	Saloon Engine C14NZ/X14NZ	•		GWB3403	
	1991.09-1998.09	Saloon Engine C14NZ/X14NZ			GWB0663	
	1991.09-1998.09	Saloon Engine C14NZ/X14NZ With ABS		o	GHA400064	K
	1991.09-1998.09	Saloon Engine C14NZ/X14NZ Without ABS		o	GHA400058	K



	 YEAR		F	R	G-AP Ref.	KIT
OPEL						
ASTRA F (56_, 57_)						
1.4 i 16V (66 kW)	1996.02-1998.09	Saloon Engine X14XE	•		GHA422006	K
	1996.02-1998.09	Saloon Engine X14XE	•		GHA422023	
	1996.02-1998.09	Saloon Engine X14XE	•		GHA433007	
	1996.02-1998.09	Saloon Engine X14XE	•		GWB3403	
	1996.02-1998.09	Saloon Engine X14XE With ABS		○	GHA400064	K
	1996.02-1998.09	Saloon Engine X14XE Without ABS		○	GHA400058	K
1.4 Si (60 kW)	1992.03-1998.09	Saloon Engine C14SE	•		GHA422006	K
	1992.03-1998.09	Saloon Engine C14SE	•		GHA422023	
	1992.03-1998.09	Saloon Engine C14SE	•		GHA433007	
	1992.03-1998.09	Saloon Engine C14SE	•		GWB0736	
	1992.03-1998.09	Saloon Engine C14SE	•		GWB3256	
	1992.03-1998.09	Saloon Engine C14SE	•		GWB3403	
	1992.03-1998.09	Saloon Engine C14SE	•		GWB3410	
	1992.03-1998.09	Saloon Engine C14SE			GWB0663	
	1992.03-1998.09	Saloon Engine C14SE With ABS		○	GHA400064	K
	1992.03-1998.09	Saloon Engine C14SE Without ABS		○	GHA400058	K
1.6 (55 kW)	1995.09-1998.09	Saloon Engine 16LZ2	•		GHA422006	K
	1995.09-1998.09	Saloon Engine 16LZ2	•		GHA422023	
	1995.09-1998.09	Saloon Engine 16LZ2	•		GHA433007	
	1995.09-1998.09	Saloon Engine 16LZ2	•		GHA433019	
	1995.09-1998.09	Saloon Engine 16LZ2	•		GWB0736	
	1995.09-1998.09	Saloon Engine 16LZ2	•		GWB3403	
	1995.09-1998.09	Saloon Engine 16LZ2	•		GWB3410	
	1995.09-1998.09	Saloon Engine 16LZ2 With ABS		○	GHA400064	K
1995.09-1998.09	Saloon Engine 16LZ2 Without ABS		○	GHA400058	K	
1.6 i (52 kW)	1993.05-1996.07	Saloon Engine X16SZ	•		GHA422006	K
	1993.05-1996.07	Saloon Engine X16SZ	•		GHA422023	
	1993.05-1996.07	Saloon Engine X16SZ	•		GHA433007	
	1993.05-1996.07	Saloon Engine X16SZ	•		GWB0736	
	1993.05-1996.07	Saloon Engine X16SZ	•		GWB3403	
	1993.05-1996.07	Saloon Engine X16SZ	•		GWB3410	
	1993.05-1996.07	Saloon Engine X16SZ With ABS		○	GHA400064	K
1993.05-1996.07	Saloon Engine X16SZ Without ABS		○	GHA400058	K	
1.6 i (55 kW)	1992.03-1998.09	Saloon Engine C16NZ/X16SZR	•		GHA422006	K
	1992.03-1998.09	Saloon Engine C16NZ/X16SZR	•		GHA422023	
	1992.03-1998.09	Saloon Engine C16NZ/X16SZR	•		GHA433007	
	1992.03-1998.09	Saloon Engine C16NZ/X16SZR	•		GWB0736	
	1992.03-1998.09	Saloon Engine C16NZ/X16SZR	•		GWB3256	
	1992.03-1998.09	Saloon Engine C16NZ/X16SZR	•		GWB3403	
	1992.03-1998.09	Saloon Engine C16NZ/X16SZR	•		GWB3410	
	1992.03-1998.09	Saloon Engine C16NZ/X16SZR			GWB0663	
	1992.03-1998.09	Saloon Engine C16NZ/X16SZR With ABS		○	GHA400064	K
1992.03-1998.09	Saloon Engine C16NZ/X16SZR Without ABS		○	GHA400058	K	
1.6 i 16V (74 kW)	1994.08-1998.09	Saloon Engine X16XEL	•		GHA422006	K
	1994.08-1998.09	Saloon Engine X16XEL	•		GHA422023	
	1994.08-1998.09	Saloon Engine X16XEL	•		GHA433007	
	1994.08-1998.09	Saloon Engine X16XEL	•		GWB0736	
	1994.08-1998.09	Saloon Engine X16XEL	•		GWB3403	
	1994.08-1998.09	Saloon Engine X16XEL	•		GWB3410	
	1994.08-1998.09	Saloon Engine X16XEL With ABS		○	GHA400064	K
	1994.08-1998.09	Saloon Engine X16XEL Without ABS		○	GHA400058	K
1.6 Si (74 kW)	1992.05-1994.12	Saloon Engine C16SE	•		GHA422006	K
	1992.05-1994.12	Saloon Engine C16SE	•		GHA422023	
	1992.05-1994.12	Saloon Engine C16SE	•		GHA433007	
	1992.05-1994.12	Saloon Engine C16SE	•		GWB0736	
	1992.05-1994.12	Saloon Engine C16SE	•		GWB3256	
	1992.05-1994.12	Saloon Engine C16SE	•		GWB3403	
	1992.05-1994.12	Saloon Engine C16SE			GWB0663	
	1992.05-1994.12	Saloon Engine C16SE With ABS		○	GHA400064	K
1992.05-1994.12	Saloon Engine C16SE Without ABS		○	GHA400058	K	
1.7 D (42 kW)	1992.03-1992.09	Saloon Engine 17D	•		GHA422006	K
	1992.03-1992.09	Saloon Engine 17D	•		GHA422023	
	1992.03-1992.09	Saloon Engine 17D	•		GHA433007	
	1992.03-1992.09	Saloon Engine 17D	•		GHA433013	



	 YEAR		F	R	G-AP Ref.	KIT
OPEL						
ASTRA F (56_, 57_)						
1.7 D (42 kW)	1992.03-1992.09	Saloon Engine 17D	•		GWB0736	
	1992.03-1992.09	Saloon Engine 17D	•		GWB3410	
	1992.03-1992.09	Saloon Engine 17D With ABS		◦	GHA400064	K
	1992.03-1992.09	Saloon Engine 17D Without ABS		◦	GHA400058	K
1.7 D (44 kW)	1992.07-1998.09	Saloon Engine 17DR	•		GHA422006	K
	1992.07-1998.09	Saloon Engine 17DR	•		GHA422023	
	1992.07-1998.09	Saloon Engine 17DR	•		GHA433007	
	1992.07-1998.09	Saloon Engine 17DR	•		GHA433013	
	1992.07-1998.09	Saloon Engine 17DR	•		GWB0736	
	1992.07-1998.09	Saloon Engine 17DR	•		GWB3410	
	1992.07-1998.09	Saloon Engine 17DR With ABS		◦	GHA400064	K
	1992.07-1998.09	Saloon Engine 17DR Without ABS		◦	GHA400058	K
	1.7 TD (50 kW)	1994.11-1998.09	Saloon Engine X17DTL	•		GHA422006
1994.11-1998.09		Saloon Engine X17DTL	•		GHA422023	
1994.11-1998.09		Saloon Engine X17DTL	•		GHA433007	
1994.11-1998.09		Saloon Engine X17DTL	•		GHA433013	
1994.11-1998.09		Saloon Engine X17DTL	•		GWB0736	
1994.11-1998.09		Saloon Engine X17DTL	•		GWB3410	
1994.11-1998.09		Saloon Engine X17DTL With ABS		◦	GHA400064	K
1994.11-1998.09		Saloon Engine X17DTL Without ABS		◦	GHA400058	K
1.7 TDS (60 kW)	1992.03-1998.09	Saloon Engine 17DT(TC4EE1)/X17DT(TC4EE1)	•		GHA422006	K
	1992.03-1998.09	Saloon Engine 17DT(TC4EE1)/X17DT(TC4EE1)	•		GHA422023	
	1992.03-1998.09	Saloon Engine 17DT(TC4EE1)/X17DT(TC4EE1)	•		GHA433007	
	1992.03-1998.09	Saloon Engine 17DT(TC4EE1)/X17DT(TC4EE1)	•		GHA433013	
	1992.03-1998.09	Saloon Engine 17DT(TC4EE1)/X17DT(TC4EE1)	•		GWB0736	
	1992.03-1998.09	Saloon Engine 17DT(TC4EE1)/X17DT(TC4EE1)	•		GWB3410	
	1992.03-1998.09	Saloon Engine 17DT(TC4EE1)/X17DT(TC4EE1) With ABS		◦	GHA400064	K
	1992.03-1998.09	Saloon Engine 17DT(TC4EE1)/X17DT(TC4EE1) Without ABS		◦	GHA400058	K
1.8 i (66 kW)	1992.03-1998.09	Saloon Engine C18NZ	•		GHA422006	K
	1992.03-1998.09	Saloon Engine C18NZ	•		GHA422023	
	1992.03-1998.09	Saloon Engine C18NZ	•		GHA433007	
	1992.03-1998.09	Saloon Engine C18NZ	•		GHA433013	
	1992.03-1998.09	Saloon Engine C18NZ	•		GWB0736	
	1992.03-1998.09	Saloon Engine C18NZ	•		GWB3410	
	1992.03-1998.09	Saloon Engine C18NZ With ABS		◦	GHA400064	K
	1992.03-1998.09	Saloon Engine C18NZ Without ABS		◦	GHA400058	K
	1.8 i 16V (82 kW)	1995.09-1996.09	Saloon Engine C18SE	•		GWB0736
1995.09-1996.09		Saloon Engine C18SE	•		GWB3410	
1995.09-1996.09		Saloon Engine C18SE With ABS		◦	GHA400064	K
1995.09-1996.09		Saloon Engine C18SE Without ABS		◦	GHA400058	K
1.8 i 16V (85 kW)	1994.11-1998.09	Saloon Engine C18XEL/X18XE	•		GHA422006	K
	1994.11-1998.09	Saloon Engine C18XEL/X18XE	•		GHA422023	
	1994.11-1998.09	Saloon Engine C18XEL/X18XE	•		GHA433007	
	1994.11-1998.09	Saloon Engine C18XEL/X18XE	•		GHA433013	
	1994.11-1998.09	Saloon Engine C18XEL/X18XE	•		GHA433019	
	1994.11-1998.09	Saloon Engine C18XEL/X18XE	•		GWB0736	
	1994.11-1998.09	Saloon Engine C18XEL/X18XE	•		GWB3410	
	1994.11-1998.09	Saloon Engine C18XEL/X18XE With ABS		◦	GHA400064	K
	1994.11-1998.09	Saloon Engine C18XEL/X18XE Without ABS		◦	GHA400058	K
	1995.09-1997.08	Saloon Engine C18SEL	•		GWB0736	
	1995.09-1997.08	Saloon Engine C18SEL	•		GWB3410	
	1995.09-1997.08	Saloon Engine C18SEL With ABS		◦	GHA400064	K
	1995.09-1997.08	Saloon Engine C18SEL Without ABS		◦	GHA400058	K
	1.8 i 16V (92 kW)	1993.06-1994.10	Saloon Engine C18XE	•		GHA422006
1993.06-1994.10		Saloon Engine C18XE	•		GHA422023	
1993.06-1994.10		Saloon Engine C18XE	•		GHA433007	
1993.06-1994.10		Saloon Engine C18XE	•		GHA433013	
1993.06-1994.10		Saloon Engine C18XE	•		GHA433019	
1993.06-1994.10		Saloon Engine C18XE	•		GWB0736	
1993.06-1994.10		Saloon Engine C18XE	•		GWB3410	
1993.06-1994.10		Saloon Engine C18XE With ABS		◦	GHA400064	K
1993.06-1994.10		Saloon Engine C18XE Without ABS		◦	GHA400058	K
2.0 i (85 kW)		1992.03-1998.09	Saloon Engine C20NE	•		GHA422006
	1992.03-1998.09	Saloon Engine C20NE	•		GHA422023	



	 YEAR		F	R	G-AP Ref.	KIT	
OPEL							
ASTRA F (56_, 57_)							
2.0 i (85 kW)	1992.03-1998.09	Saloon Engine C20NE	•		GHA433007		
	1992.03-1998.09	Saloon Engine C20NE	•		GHA433013		
	1992.03-1998.09	Saloon Engine C20NE	•		GHA433019		
	1992.03-1998.09	Saloon Engine C20NE	•		GWB0736		
	1992.03-1998.09	Saloon Engine C20NE	•		GWB3410		
	1992.03-1998.09	Saloon Engine C20NE With ABS		◦	GHA400064	K	
	1992.03-1998.09	Saloon Engine C20NE Without ABS		◦	GHA400058	K	
	2.0 i 16V (100 kW)	1995.02-1998.09	Saloon Engine X20XEV	•		GHA422006	K
1995.02-1998.09		Saloon Engine X20XEV	•		GHA422023		
1995.02-1998.09		Saloon Engine X20XEV	•		GHA433007		
1995.02-1998.09		Saloon Engine X20XEV	•		GHA433013		
1995.02-1998.09		Saloon Engine X20XEV	•		GWB0736		
1995.02-1998.09		Saloon Engine X20XEV	•		GWB3410		
1995.02-1998.09		Saloon Engine X20XEV With ABS		◦	GHA400064	K	
1995.02-1998.09		Saloon Engine X20XEV Without ABS		◦	GHA400058	K	
ASTRA F CLASSIC							
1.4 i (44 kW)	1998.01-2002.08	Hatchback Engine X14NZ	•		GHA422006	K	
	1998.01-2002.08	Hatchback Engine X14NZ	•		GWB3403		
	1998.01-2002.08	Hatchback Engine X14NZ With ABS		◦	GHA400064	K	
	1998.01-2002.08	Hatchback Engine X14NZ Without ABS		◦	GHA400058	K	
	1998.01-2002.08	Saloon Engine X14NZ	•		GHA422006	K	
	1998.01-2002.08	Saloon Engine X14NZ	•		GWB3403		
	1998.01-2002.08	Saloon Engine X14NZ With ABS		◦	GHA400064	K	
	1998.01-2002.08	Saloon Engine X14NZ Without ABS		◦	GHA400058	K	
	1998.01-2005.01	Estate Engine X14NZ	•		GHA422006	K	
	1998.01-2005.01	Estate Engine X14NZ	•		GHA422023		
	1998.01-2005.01	Estate Engine X14NZ	•		GHA433007		
	1998.01-2005.01	Estate Engine X14NZ	•		GWB3403		
	1998.01-2005.01	Estate Engine X14NZ With ABS		◦	GHA400064	K	
	1998.01-2005.01	Estate Engine X14NZ Without ABS		◦	GHA400058	K	
1.6 i (55 kW)	1998.01-2002.08	Hatchback Engine X16SZR	•		GHA422006	K	
	1998.01-2002.08	Hatchback Engine X16SZR	•		GWB3403		
	1998.01-2002.08	Hatchback Engine X16SZR With ABS		◦	GHA400064	K	
	1998.01-2002.08	Hatchback Engine X16SZR Without ABS		◦	GHA400058	K	
	1998.01-2002.08	Saloon Engine X16SZR	•		GHA422006	K	
	1998.01-2002.08	Saloon Engine X16SZR	•		GWB3403		
	1998.01-2002.08	Saloon Engine X16SZR With ABS		◦	GHA400064	K	
	1998.01-2002.08	Saloon Engine X16SZR Without ABS		◦	GHA400058	K	
	1998.01-2005.01	Estate Engine X16SZR	•		GHA422006	K	
	1998.01-2005.01	Estate Engine X16SZR	•		GWB3403		
	1998.01-2005.01	Estate Engine X16SZR With ABS		◦	GHA400064	K	
	1998.01-2005.01	Estate Engine X16SZR Without ABS		◦	GHA400058	K	
	1.6 i 16V (74 kW)	1998.01-2002.08	Hatchback Engine X16XEL	•		GHA422006	K
		1998.01-2002.08	Hatchback Engine X16XEL	•		GWB3403	
1998.01-2002.08		Hatchback Engine X16XEL With ABS		◦	GHA400064	K	
1998.01-2002.08		Hatchback Engine X16XEL Without ABS		◦	GHA400058	K	
1998.01-2002.08		Saloon Engine X16XEL	•		GHA422006	K	
1998.01-2002.08		Saloon Engine X16XEL	•		GWB3403		
1998.01-2002.08		Saloon Engine X16XEL With ABS		◦	GHA400064	K	
1998.01-2002.08		Saloon Engine X16XEL Without ABS		◦	GHA400058	K	
1998.01-2005.01		Estate Engine X16XEL	•		GHA422006	K	
1998.01-2005.01		Estate Engine X16XEL	•		GWB3403		
1998.01-2005.01		Estate Engine X16XEL With ABS		◦	GHA400064	K	
1998.01-2005.01		Estate Engine X16XEL Without ABS		◦	GHA400058	K	
ASTRA F VAN (55_)							
1.4 i (44 kW)		1991.10-1999.01	Box Engine C14NZ	•		GWB3256	
	1991.10-1999.01	Box Engine C14NZ	•		GWB3403		
	1991.10-1999.01	Box Engine C14NZ			GWB0663		
	1991.10-1999.01	Box Engine C14NZ With ABS		◦	GHA400064	K	
	1991.10-1999.01	Box Engine C14NZ Without ABS		◦	GHA400058	K	
1.6 i (52 kW)	1993.02-1996.07	Box Engine X16SZ	•		GWB0736		
	1993.02-1996.07	Box Engine X16SZ	•		GWB3403		
	1993.02-1996.07	Box Engine X16SZ	•		GWB3410		
	1993.02-1996.07	Box Engine X16SZ With ABS		◦	GHA400064	K	



	 YEAR		F	R	G-AP Ref.	KIT
OPEL						
ASTRA F VAN (55_)						
1.6 i (52 kW)	1993.02-1996.07	Box Engine X16SZ Without ABS		o	GHA400058	K
1.6 i (55 kW)	1991.10-1993.04	Box Engine C16NZ	•		GWB0736	
	1991.10-1993.04	Box Engine C16NZ	•		GWB3256	
	1991.10-1993.04	Box Engine C16NZ	•		GWB3403	
	1991.10-1993.04	Box Engine C16NZ	•		GWB3410	
	1991.10-1993.04	Box Engine C16NZ			GWB0663	
	1991.10-1993.04	Box Engine C16NZ With ABS		o	GHA400064	K
	1991.10-1993.04	Box Engine C16NZ Without ABS		o	GHA400058	K
1.6 i 16V (74 kW)	1994.08-1998.03	Box Engine X 16 XEL	•		GWB0736	
	1994.08-1998.03	Box Engine X 16 XEL	•		GWB3256	
	1994.08-1998.03	Box Engine X 16 XEL	•		GWB3403	
	1994.08-1998.03	Box Engine X 16 XEL	•		GWB3410	
	1994.08-1998.03	Box Engine X 16 XEL			GWB0663	
	1994.08-1998.03	Box Engine X 16 XEL With ABS		o	GHA400064	K
	1994.08-1998.03	Box Engine X 16 XEL Without ABS		o	GHA400058	K
1.7 D (42 kW)	1991.12-1992.09	Box Engine 17D	•		GHA433013	
	1991.12-1992.09	Box Engine 17D	•		GWB0736	
	1991.12-1992.09	Box Engine 17D	•		GWB3410	
	1991.12-1992.09	Box Engine 17D With ABS		o	GHA400064	K
	1991.12-1992.09	Box Engine 17D Without ABS		o	GHA400058	K
1.7 D (44 kW)	1992.07-1999.01	Box Engine 17DR	•		GHA433013	
	1992.07-1999.01	Box Engine 17DR	•		GWB0736	
	1992.07-1999.01	Box Engine 17DR	•		GWB3410	
	1992.07-1999.01	Box Engine 17DR With ABS		o	GHA400064	K
	1992.07-1999.01	Box Engine 17DR Without ABS		o	GHA400058	K
1.7 TD (50 kW)	1994.08-1999.01	Box Engine X17DTL	•		GHA433013	
	1994.08-1999.01	Box Engine X17DTL	•		GWB0736	
	1994.08-1999.01	Box Engine X17DTL	•		GWB3410	
	1994.08-1999.01	Box Engine X17DTL With ABS		o	GHA400064	K
	1994.08-1999.01	Box Engine X17DTL Without ABS		o	GHA400058	K
ASTRA F Van (55_)						
1.7 TD (60 kW)	1995.03-1998.02	Box Engine X17DT(TC4EE1)	•		GWB0736	
	1995.03-1998.02	Box Engine X17DT(TC4EE1)	•		GWB3410	
	1995.03-1998.02	Box Engine X17DT(TC4EE1) With ABS		o	GHA400064	K
	1995.03-1998.02	Box Engine X17DT(TC4EE1) Without ABS		o	GHA400058	K
ASTRA G						
1.6 16V (74 kW)	2001.03-2005.10	Convertible Engine Z16XE With ABS	•		GHA333033	K
	2001.03-2005.10	Convertible Engine Z16XE With ABS		o	GHA400064	K
	2001.03-2005.10	Convertible Engine Z16XE Without ABS	•		GHA333036	K
	2001.03-2005.10	Convertible Engine Z16XE Without ABS		o	GHA400058	K
1.8 16V (92 kW)	2001.03-2005.10	Convertible Engine Z18XE	•		GHA333102	K
	2001.03-2005.10	Convertible Engine Z18XE With ABS	•		GHA333029	K
	2001.03-2005.10	Convertible Engine Z18XE With ABS		o	GHA400052	K
2.0 16V Turbo (147 kW)	2001.03-2005.10	Convertible Engine Z18XE Without ABS		o	GHA400053	K
	2002.11-2005.10	Convertible Engine Z20LET With ABS	•		GHA333029	K
	2002.11-2005.10	Convertible Engine Z20LET With ABS		o	GHA400052	K
2.0 OPC (141 kW)	2002.03-2005.10	Convertible Engine Z20LET With ABS	•		GHA333029	K
	2002.03-2005.10	Convertible Engine Z20LET With ABS		o	GHA400052	K
2.2 16V (108 kW)	2001.03-2005.10	Convertible Engine Z22SE With ABS	•		GHA333029	K
	2001.03-2005.10	Convertible Engine Z22SE With ABS		o	GHA400052	K
2.2 DTi (92 kW)	2002.09-2005.10	Convertible Engine Y22DTR With ABS	•		GHA333029	K
	2002.09-2005.10	Convertible Engine Y22DTR With ABS		o	GHA400052	K
ASTRA G (F07_)						
1.6 16V (74 kW)	2000.03-2005.05	Coupe Engine Z16XE With ABS	•		GHA333033	K
	2000.03-2005.05	Coupe Engine Z16XE With ABS		o	GHA400064	K
	2000.03-2005.05	Coupe Engine Z16XE Without ABS	•		GHA333036	K
	2000.03-2005.05	Coupe Engine Z16XE Without ABS		o	GHA400058	K
1.6 16V (76 kW)	2000.03-2005.05	Coupe Engine Z16XEP With ABS	•		GHA333033	K
	2000.03-2005.05	Coupe Engine Z16XEP With ABS		o	GHA400064	K
	2000.03-2005.05	Coupe Engine Z16XEP Without ABS	•		GHA333036	K
	2000.03-2005.05	Coupe Engine Z16XEP Without ABS		o	GHA400058	K
1.8 16V (85 kW)	2000.03-2000.10	Coupe Engine X18XE1	•		GHA333102	K
	2000.03-2000.10	Coupe Engine X18XE1 With ABS	•		GHA333029	K
	2000.03-2000.10	Coupe Engine X18XE1 With ABS		o	GHA400052	K



	 YEAR		F	R	G-AP Ref.	KIT
OPEL						
ASTRA G (F07_)						
1.8 16V (85 kW)	2000.03-2000.10	Coupe Engine X18XE1 Without ABS		o	GHA400053	K
1.8 16V (92 kW)	2000.09-2005.05	Coupe Engine Z18XE	•		GHA333102	K
	2000.09-2005.05	Coupe Engine Z18XE With ABS	•		GHA333029	K
	2000.09-2005.05	Coupe Engine Z18XE With ABS		o	GHA400052	K
	2000.09-2005.05	Coupe Engine Z18XE Without ABS		o	GHA400053	K
	2000.09-2005.05	Coupe Engine Z20LET With ABS	•		GHA333029	K
2.0 16V Turbo (140 kW)	2000.09-2001.08	Coupe Engine Z20LET With ABS	•		GHA333029	K
	2000.09-2001.08	Coupe Engine Z20LET With ABS		o	GHA400052	K
2.0 16V Turbo (141 kW)	2001.08-2005.05	Coupe Engine Z20LET With ABS	•		GHA333029	K
	2001.08-2005.05	Coupe Engine Z20LET With ABS		o	GHA400052	K
2.0 16V Turbo (147 kW)	2000.07-2004.12	Coupe Engine Z20LET With ABS	•		GHA333029	K
	2000.07-2004.12	Coupe Engine Z20LET With ABS		o	GHA400052	K
2.2 16V (108 kW)	2000.09-2005.05	Coupe Engine Z22SE	•		GHA333102	K
	2000.09-2005.05	Coupe Engine Z22SE With ABS	•		GHA333029	K
	2000.09-2005.05	Coupe Engine Z22SE With ABS		o	GHA400052	K
	2000.09-2005.05	Coupe Engine Z22SE Without ABS		o	GHA400053	K
2.2 DTi (92 kW)	2002.09-2005.05	Coupe Engine Y22DTR With ABS	•		GHA333029	K
	2002.09-2005.05	Coupe Engine Y22DTR With ABS		o	GHA400052	K
ASTRA G (F35_)						
1.2 16V (48 kW)	1998.02-2000.09	Estate Engine X12XE With ABS	•		GHA333033	K
	1998.02-2000.09	Estate Engine X12XE With ABS		o	GHA400064	K
	1998.02-2000.09	Estate Engine X12XE Without ABS	•		GHA333036	K
	1998.02-2000.09	Estate Engine X12XE Without ABS		o	GHA400058	K
1.2 16V (55 kW)	2000.09-2004.07	Estate Engine Z12XE With ABS	•		GHA333033	K
	2000.09-2004.07	Estate Engine Z12XE With ABS		o	GHA400064	K
	2000.09-2004.07	Estate Engine Z12XE Without ABS	•		GHA333036	K
	2000.09-2004.07	Estate Engine Z12XE Without ABS		o	GHA400058	K
1.4 (66 kW)	2007.09-2009.12	Estate Engine Z14XEP With ABS	•		GHA333033	K
	2007.09-2009.12	Estate Engine Z14XEP With ABS		o	GHA400064	K
	2007.09-2009.12	Estate Engine Z14XEP Without ABS	•		GHA333036	K
	2007.09-2009.12	Estate Engine Z14XEP Without ABS		o	GHA400058	K
1.4 16V (66 kW)	1998.06-2004.07	Estate Engine X14XE/Z14XE With ABS	•		GHA333033	K
	1998.06-2004.07	Estate Engine X14XE/Z14XE With ABS		o	GHA400064	K
	1998.06-2004.07	Estate Engine X14XE/Z14XE Without ABS	•		GHA333036	K
	1998.06-2004.07	Estate Engine X14XE/Z14XE Without ABS		o	GHA400058	K
1.6 (55 kW)	1998.02-2000.09	Estate Engine X16SZR With ABS	•		GHA333033	K
	1998.02-2000.09	Estate Engine X16SZR With ABS		o	GHA400064	K
	1998.02-2000.09	Estate Engine X16SZR Without ABS	•		GHA333036	K
	1998.02-2000.09	Estate Engine X16SZR Without ABS		o	GHA400058	K
1.6 (62 kW)	2000.09-2004.07	Estate Engine Z16SE With ABS	•		GHA333033	K
	2000.09-2004.07	Estate Engine Z16SE With ABS		o	GHA400064	K
	2000.09-2004.07	Estate Engine Z16SE Without ABS	•		GHA333036	K
	2000.09-2004.07	Estate Engine Z16SE Without ABS		o	GHA400058	K
1.6 (76 kW)	2002.12-2009.07	Estate Engine Z16XEP With ABS	•		GHA333033	K
	2002.12-2009.07	Estate Engine Z16XEP With ABS		o	GHA400064	K
	2002.12-2009.07	Estate Engine Z16XEP Without ABS	•		GHA333036	K
	2002.12-2009.07	Estate Engine Z16XEP Without ABS		o	GHA400058	K
1.6 16V (74 kW)	1998.02-2004.07	Estate Engine X16XEL/Z16XE With ABS	•		GHA333033	K
	1998.02-2004.07	Estate Engine X16XEL/Z16XE With ABS		o	GHA400064	K
	1998.02-2004.07	Estate Engine X16XEL/Z16XE Without ABS	•		GHA333036	K
	1998.02-2004.07	Estate Engine X16XEL/Z16XE Without ABS		o	GHA400058	K
1.6 CNG (71 kW)	2003.03-2004.07	Estate Engine Z16YNG With ABS	•		GHA333033	K
	2003.03-2004.07	Estate Engine Z16YNG With ABS		o	GHA400064	K
	2003.03-2004.07	Estate Engine Z16YNG Without ABS	•		GHA333036	K
	2003.03-2004.07	Estate Engine Z16YNG Without ABS		o	GHA400058	K
1.7 CDTi (59 kW)	2003.04-2009.07	Estate Engine Z17DTL With ABS	•		GHA333033	K
	2003.04-2009.07	Estate Engine Z17DTL With ABS		o	GHA400064	K
	2003.04-2009.07	Estate Engine Z17DTL Without ABS	•		GHA333036	K
	2003.04-2009.07	Estate Engine Z17DTL Without ABS		o	GHA400058	K
1.7 DTi 16V (55 kW)	2000.02-2004.07	Estate Engine Y17DT With ABS	•		GHA333033	K
	2000.02-2004.07	Estate Engine Y17DT With ABS		o	GHA400064	K
	2000.02-2004.07	Estate Engine Y17DT Without ABS	•		GHA333036	K
	2000.02-2004.07	Estate Engine Y17DT Without ABS		o	GHA400058	K
1.7 TD (50 kW)	1998.02-2000.08	Estate Engine X17DTL With ABS	•		GHA333033	K
	1998.02-2000.08	Estate Engine X17DTL With ABS		o	GHA400064	K



	 YEAR		F	R	G-AP Ref.	KIT
OPEL						
ASTRA G (F35_)						
1.7 TD (50 kW)	1998.02-2000.08	Estate Engine X17DTL Without ABS	•		GHA333036	K
	1998.02-2000.08	Estate Engine X17DTL Without ABS		◦	GHA400058	K
1.8 16V (85 kW)	1998.02-2000.09	Estate Engine X18XE1 With ABS	•		GHA333029	K
	1998.02-2000.09	Estate Engine X18XE1 With ABS		◦	GHA400052	K
	1998.02-2000.09	Estate Engine X18XE1 Without ABS	•		GHA333036	K
	1998.02-2000.09	Estate Engine X18XE1 Without ABS		◦	GHA400058	K
1.8 16V (92 kW)	2000.09-2004.07	Estate Engine Z18XE With ABS	•		GHA333029	K
	2000.09-2004.07	Estate Engine Z18XE With ABS		◦	GHA400052	K
	2000.09-2004.07	Estate Engine Z18XE Without ABS	•		GHA333036	K
	2000.09-2004.07	Estate Engine Z18XE Without ABS		◦	GHA400058	K
2.0 16V (100 kW)	1998.02-2004.07	Estate Engine X20XEV	•		GHA333102	K
	1998.02-2004.07	Estate Engine X20XEV With ABS	•		GHA333029	K
	1998.02-2004.07	Estate Engine X20XEV With ABS		◦	GHA400052	K
	1998.02-2004.07	Estate Engine X20XEV Without ABS		◦	GHA400053	K
2.0 Di (60 kW)	1998.02-2004.07	Estate Engine X20DTL/Y20DTL With ABS	•		GHA333029	K
	1998.02-2004.07	Estate Engine X20DTL/Y20DTL With ABS		◦	GHA400052	K
	1998.02-2004.07	Estate Engine X20DTL/Y20DTL Without ABS	•		GHA333036	K
	1998.02-2004.07	Estate Engine X20DTL/Y20DTL Without ABS		◦	GHA400058	K
2.0 DTi 16V (74 kW)	1999.08-2004.07	Estate Engine X20DTH/Y20DTH	•		GHA333102	K
	1999.08-2004.07	Estate Engine X20DTH/Y20DTH With ABS	•		GHA333029	K
	1999.08-2004.07	Estate Engine X20DTH/Y20DTH With ABS		◦	GHA400052	K
	1999.08-2004.07	Estate Engine X20DTH/Y20DTH Without ABS		◦	GHA400053	K
2.0 OPC (141 kW)	2002.09-2004.07	Estate Engine Z20LET With ABS	•		GHA333029	K
	2002.09-2004.07	Estate Engine Z20LET With ABS		◦	GHA400052	K
2.0 OPC (147 kW)	2002.11-2004.07	Estate Engine Z20LET With ABS	•		GHA333029	K
	2002.11-2004.07	Estate Engine Z20LET With ABS		◦	GHA400052	K
2.2 16V (108 kW)	2001.03-2004.07	Estate Engine Z22SE	•		GHA333102	K
	2001.03-2004.07	Estate Engine Z22SE With ABS	•		GHA333029	K
	2001.03-2004.07	Estate Engine Z22SE With ABS		◦	GHA400052	K
	2001.03-2004.07	Estate Engine Z22SE Without ABS		◦	GHA400053	K
2.2 DTi (86 kW)	2002.09-2004.07	Estate Engine Y22DTR With ABS	•		GHA333029	K
	2002.09-2004.07	Estate Engine Y22DTR With ABS		◦	GHA400052	K
2.2 DTi (92 kW)	2002.09-2004.07	Estate Engine Y22DTR With ABS	•		GHA333029	K
	2002.09-2004.07	Estate Engine Y22DTR With ABS		◦	GHA400052	K
ASTRA G (F48_, F08_)						
1.2 16V (48 kW)	1998.02-2000.09	Hatchback Engine X12XE With ABS	•		GHA333033	K
	1998.02-2000.09	Hatchback Engine X12XE With ABS		◦	GHA400064	K
	1998.02-2000.09	Hatchback Engine X12XE Without ABS	•		GHA333036	K
	1998.02-2000.09	Hatchback Engine X12XE Without ABS		◦	GHA400058	K
1.2 16V (55 kW)	2000.09-2005.01	Hatchback Engine Z12XE With ABS	•		GHA333033	K
	2000.09-2005.01	Hatchback Engine Z12XE With ABS		◦	GHA400064	K
	2000.09-2005.01	Hatchback Engine Z12XE Without ABS	•		GHA333036	K
	2000.09-2005.01	Hatchback Engine Z12XE Without ABS		◦	GHA400058	K
1.4 (66 kW)	2007.09-2009.12	Hatchback Engine Z14XEP With ABS	•		GHA333033	K
	2007.09-2009.12	Hatchback Engine Z14XEP With ABS		◦	GHA400064	K
	2007.09-2009.12	Hatchback Engine Z14XEP Without ABS	•		GHA333036	K
	2007.09-2009.12	Hatchback Engine Z14XEP Without ABS		◦	GHA400058	K
1.4 16V (66 kW)	1998.02-2005.01	Hatchback Engine X14XE/Z14XE With ABS	•		GHA333033	K
	1998.02-2005.01	Hatchback Engine X14XE/Z14XE With ABS		◦	GHA400064	K
	1998.02-2005.01	Hatchback Engine X14XE/Z14XE Without ABS	•		GHA333036	K
	1998.02-2005.01	Hatchback Engine X14XE/Z14XE Without ABS		◦	GHA400058	K
1.6 (55 kW)	1998.02-2000.09	Hatchback Engine X16SZR With ABS	•		GHA333033	K
	1998.02-2000.09	Hatchback Engine X16SZR With ABS		◦	GHA400064	K
	1998.02-2000.09	Hatchback Engine X16SZR Without ABS	•		GHA333036	K
	1998.02-2000.09	Hatchback Engine X16SZR Without ABS		◦	GHA400058	K
1.6 (62 kW)	2000.09-2005.01	Hatchback Engine Z16SE With ABS	•		GHA333033	K
	2000.09-2005.01	Hatchback Engine Z16SE With ABS		◦	GHA400064	K
	2000.09-2005.01	Hatchback Engine Z16SE Without ABS	•		GHA333036	K
	2000.09-2005.01	Hatchback Engine Z16SE Without ABS		◦	GHA400058	K
1.6 (76 kW)	2002.12-2009.12	Hatchback Engine Z16XEP With ABS	•		GHA333033	K
	2002.12-2009.12	Hatchback Engine Z16XEP With ABS		◦	GHA400064	K
	2002.12-2009.12	Hatchback Engine Z16XEP Without ABS	•		GHA333036	K
	2002.12-2009.12	Hatchback Engine Z16XEP Without ABS		◦	GHA400058	K
1.6 16V (74 kW)	1998.02-2005.01	Hatchback Engine X16XEL/Z16XE With ABS	•		GHA333033	K



	 YEAR		F	R	G-AP Ref.	KIT
OPEL						
ASTRA G (F48_, F08_)						
1.6 16V (74 kW)	1998.02-2005.01	Hatchback Engine X16XEL/Z16XE With ABS		o	GHA400064	K
	1998.02-2005.01	Hatchback Engine X16XEL/Z16XE Without ABS	•		GHA333036	K
	1998.02-2005.01	Hatchback Engine X16XEL/Z16XE Without ABS		o	GHA400058	K
1.6 LPG (74 kW)	2002.06-2005.01	Hatchback Engine Z16XE With ABS	•		GHA333033	K
	2002.06-2005.01	Hatchback Engine Z16XE With ABS		o	GHA400064	K
	2002.06-2005.01	Hatchback Engine Z16XE Without ABS	•		GHA333036	K
	2002.06-2005.01	Hatchback Engine Z16XE Without ABS		o	GHA400058	K
1.7 CDTi (59 kW)	2003.04-2005.01	Hatchback Engine Z17DTL With ABS	•		GHA333033	K
	2003.04-2005.01	Hatchback Engine Z17DTL With ABS		o	GHA400064	K
	2003.04-2005.01	Hatchback Engine Z17DTL Without ABS	•		GHA333036	K
	2003.04-2005.01	Hatchback Engine Z17DTL Without ABS		o	GHA400058	K
1.7 DTi 16V (55 kW)	2000.02-2005.01	Hatchback Engine Y17DT With ABS	•		GHA333033	K
	2000.02-2005.01	Hatchback Engine Y17DT With ABS		o	GHA400064	K
	2000.02-2005.01	Hatchback Engine Y17DT Without ABS	•		GHA333036	K
	2000.02-2005.01	Hatchback Engine Y17DT Without ABS		o	GHA400058	K
1.7 TD (50 kW)	1998.02-2000.08	Hatchback Engine X17DTL With ABS	•		GHA333033	K
	1998.02-2000.08	Hatchback Engine X17DTL With ABS		o	GHA400064	K
	1998.02-2000.08	Hatchback Engine X17DTL Without ABS	•		GHA333036	K
	1998.02-2000.08	Hatchback Engine X17DTL Without ABS		o	GHA400058	K
1.8 16V (85 kW)	1998.02-2000.09	Hatchback Engine X18XE1 With ABS	•		GHA333029	K
	1998.02-2000.09	Hatchback Engine X18XE1 With ABS		o	GHA400052	K
	1998.02-2000.09	Hatchback Engine X18XE1 Without ABS	•		GHA333036	K
	1998.02-2000.09	Hatchback Engine X18XE1 Without ABS		o	GHA400058	K
1.8 16V (92 kW)	2000.09-2005.01	Hatchback Engine Z18XE With ABS	•		GHA333029	K
	2000.09-2005.01	Hatchback Engine Z18XE With ABS		o	GHA400052	K
	2000.09-2005.01	Hatchback Engine Z18XE Without ABS	•		GHA333036	K
	2000.09-2005.01	Hatchback Engine Z18XE Without ABS		o	GHA400058	K
2.0 16V (100 kW)	1998.02-2005.01	Hatchback Engine X20XEV	•		GHA333102	K
	1998.02-2005.01	Hatchback Engine X20XEV With ABS	•		GHA333029	K
	1998.02-2005.01	Hatchback Engine X20XEV With ABS		o	GHA400052	K
	1998.02-2005.01	Hatchback Engine X20XEV Without ABS		o	GHA400053	K
2.0 16V OPC (118 kW)	1999.11-2002.09	Hatchback Engine X20XER With ABS	•		GHA333029	K
	1999.11-2002.09	Hatchback Engine X20XER With ABS		o	GHA400052	K
2.0 Di (60 kW)	1998.02-2005.01	Hatchback Engine X20DTL/Y20DTL With ABS	•		GHA333029	K
	1998.02-2005.01	Hatchback Engine X20DTL/Y20DTL With ABS		o	GHA400052	K
	1998.02-2005.01	Hatchback Engine X20DTL/Y20DTL Without ABS	•		GHA333036	K
	1998.02-2005.01	Hatchback Engine X20DTL/Y20DTL Without ABS		o	GHA400058	K
2.0 DTi 16V (74 kW)	1999.08-2005.01	Hatchback Engine X20DTH/Y20DTH	•		GHA333102	K
	1999.08-2005.01	Hatchback Engine X20DTH/Y20DTH With ABS	•		GHA333029	K
	1999.08-2005.01	Hatchback Engine X20DTH/Y20DTH With ABS		o	GHA400052	K
	1999.08-2005.01	Hatchback Engine X20DTH/Y20DTH Without ABS		o	GHA400053	K
2.0 OPC (141 kW)	2002.09-2005.01	Hatchback Engine Z20LET With ABS	•		GHA333029	K
	2002.09-2005.01	Hatchback Engine Z20LET With ABS		o	GHA400052	K
2.0 OPC (147 kW)	2002.11-2005.01	Hatchback Engine Z20LET With ABS	•		GHA333029	K
	2002.11-2005.01	Hatchback Engine Z20LET With ABS		o	GHA400052	K
2.2 16V (108 kW)	2000.06-2005.01	Hatchback Engine Z22SE	•		GHA333102	K
	2000.06-2005.01	Hatchback Engine Z22SE With ABS	•		GHA333029	K
	2000.06-2005.01	Hatchback Engine Z22SE With ABS		o	GHA400052	K
	2000.06-2005.01	Hatchback Engine Z22SE Without ABS		o	GHA400053	K
2.2 DTi (86 kW)	2002.09-2005.01	Hatchback Engine Y22DTR With ABS	•		GHA333029	K
	2002.09-2005.01	Hatchback Engine Y22DTR With ABS		o	GHA400052	K
2.2 DTi (92 kW)	2002.09-2005.01	Hatchback Engine Y22DTR With ABS	•		GHA333029	K
	2002.09-2005.01	Hatchback Engine Y22DTR With ABS		o	GHA400052	K
ASTRA G (F69_)						
1.2 16V (48 kW)	1998.09-2000.09	Saloon Engine X12XE With ABS	•		GHA333033	K
	1998.09-2000.09	Saloon Engine X12XE With ABS		o	GHA400064	K
	1998.09-2000.09	Saloon Engine X12XE Without ABS	•		GHA333036	K
	1998.09-2000.09	Saloon Engine X12XE Without ABS		o	GHA400058	K
1.2 16V (55 kW)	2000.09-2005.01	Saloon Engine Z12XE With ABS	•		GHA333033	K
	2000.09-2005.01	Saloon Engine Z12XE With ABS		o	GHA400064	K
	2000.09-2005.01	Saloon Engine Z12XE Without ABS	•		GHA333036	K
	2000.09-2005.01	Saloon Engine Z12XE Without ABS		o	GHA400058	K
1.4 (66 kW)	2007.09-2009.12	Saloon Engine Z14XEP With ABS	•		GHA333033	K
	2007.09-2009.12	Saloon Engine Z14XEP With ABS		o	GHA400064	K



	 YEAR		F	R	G-AP Ref.	KIT
OPEL						
ASTRA G (F69_)						
1.4 (66 kW)	2007.09-2009.12	Saloon Engine Z14XEP Without ABS	•		GHA333036	K
	2007.09-2009.12	Saloon Engine Z14XEP Without ABS		◦	GHA400058	K
1.4 16V (66 kW)	1998.09-2005.01	Saloon Engine X14XE/Z14XE With ABS	•		GHA333033	K
	1998.09-2005.01	Saloon Engine X14XE/Z14XE With ABS		◦	GHA400064	K
	1998.09-2005.01	Saloon Engine X14XE/Z14XE Without ABS	•		GHA333036	K
	1998.09-2005.01	Saloon Engine X14XE/Z14XE Without ABS		◦	GHA400058	K
1.6 (55 kW)	1998.09-2000.09	Saloon Engine X16SZR With ABS	•		GHA333033	K
	1998.09-2000.09	Saloon Engine X16SZR With ABS		◦	GHA400064	K
	1998.09-2000.09	Saloon Engine X16SZR Without ABS	•		GHA333036	K
	1998.09-2000.09	Saloon Engine X16SZR Without ABS		◦	GHA400058	K
1.6 (62 kW)	2000.09-2005.01	Saloon Engine Z16SE With ABS	•		GHA333033	K
	2000.09-2005.01	Saloon Engine Z16SE With ABS		◦	GHA400064	K
	2000.09-2005.01	Saloon Engine Z16SE Without ABS	•		GHA333036	K
	2000.09-2005.01	Saloon Engine Z16SE Without ABS		◦	GHA400058	K
1.6 (76 kW)	2002.12-2005.01	Saloon Engine Z16XEP With ABS	•		GHA333033	K
	2002.12-2005.01	Saloon Engine Z16XEP With ABS		◦	GHA400064	K
	2002.12-2005.01	Saloon Engine Z16XEP Without ABS	•		GHA333036	K
	2002.12-2005.01	Saloon Engine Z16XEP Without ABS		◦	GHA400058	K
1.6 16V (74 kW)	1998.09-2005.01	Saloon Engine X16XEL/Z16XE With ABS	•		GHA333033	K
	1998.09-2005.01	Saloon Engine X16XEL/Z16XE With ABS		◦	GHA400064	K
	1998.09-2005.01	Saloon Engine X16XEL/Z16XE Without ABS	•		GHA333036	K
	1998.09-2005.01	Saloon Engine X16XEL/Z16XE Without ABS		◦	GHA400058	K
1.6 LPG (74 kW)	2002.06-2005.01	Saloon Engine Z16XE With ABS	•		GHA333033	K
	2002.06-2005.01	Saloon Engine Z16XE With ABS		◦	GHA400064	K
	2002.06-2005.01	Saloon Engine Z16XE Without ABS	•		GHA333036	K
	2002.06-2005.01	Saloon Engine Z16XE Without ABS		◦	GHA400058	K
1.7 CDTi (59 kW)	2003.04-2004.05	Saloon Engine Z17DTL With ABS	•		GHA333033	K
	2003.04-2004.05	Saloon Engine Z17DTL With ABS		◦	GHA400064	K
	2003.04-2004.05	Saloon Engine Z17DTL Without ABS	•		GHA333036	K
	2003.04-2004.05	Saloon Engine Z17DTL Without ABS		◦	GHA400058	K
1.7 DTi 16V (55 kW)	2000.02-2005.01	Saloon Engine Y17DT With ABS	•		GHA333033	K
	2000.02-2005.01	Saloon Engine Y17DT With ABS		◦	GHA400064	K
	2000.02-2005.01	Saloon Engine Y17DT Without ABS	•		GHA333036	K
	2000.02-2005.01	Saloon Engine Y17DT Without ABS		◦	GHA400058	K
1.7 TD (50 kW)	1998.09-2000.08	Saloon Engine X17DTL With ABS	•		GHA333033	K
	1998.09-2000.08	Saloon Engine X17DTL With ABS		◦	GHA400064	K
	1998.09-2000.08	Saloon Engine X17DTL Without ABS	•		GHA333036	K
	1998.09-2000.08	Saloon Engine X17DTL Without ABS		◦	GHA400058	K
1.8 16V (85 kW)	1998.09-2000.09	Saloon Engine X18XE1 With ABS	•		GHA333029	K
	1998.09-2000.09	Saloon Engine X18XE1 With ABS		◦	GHA400052	K
	1998.09-2000.09	Saloon Engine X18XE1 Without ABS	•		GHA333036	K
	1998.09-2000.09	Saloon Engine X18XE1 Without ABS		◦	GHA400058	K
1.8 16V (92 kW)	2000.06-2005.01	Saloon Engine Z18XE With ABS	•		GHA333029	K
	2000.06-2005.01	Saloon Engine Z18XE With ABS		◦	GHA400052	K
	2000.06-2005.01	Saloon Engine Z18XE Without ABS	•		GHA333036	K
	2000.06-2005.01	Saloon Engine Z18XE Without ABS		◦	GHA400058	K
2.0 16V (100 kW)	1998.09-2005.01	Saloon Engine X20XEV	•		GHA333102	K
	1998.09-2005.01	Saloon Engine X20XEV With ABS	•		GHA333029	K
	1998.09-2005.01	Saloon Engine X20XEV With ABS		◦	GHA400052	K
	1998.09-2005.01	Saloon Engine X20XEV Without ABS		◦	GHA400053	K
2.0 Di (60 kW)	1998.09-2005.01	Saloon Engine X20DTL/Y20DTL With ABS	•		GHA333029	K
	1998.09-2005.01	Saloon Engine X20DTL/Y20DTL With ABS		◦	GHA400052	K
	1998.09-2005.01	Saloon Engine X20DTL/Y20DTL Without ABS	•		GHA333036	K
	1998.09-2005.01	Saloon Engine X20DTL/Y20DTL Without ABS		◦	GHA400058	K
2.0 DTi 16V (74 kW)	1999.08-2005.01	Saloon Engine X20DTH/Y20DTH	•		GHA333102	K
	1999.08-2005.01	Saloon Engine X20DTH/Y20DTH With ABS	•		GHA333029	K
	1999.08-2005.01	Saloon Engine X20DTH/Y20DTH With ABS		◦	GHA400052	K
	1999.08-2005.01	Saloon Engine X20DTH/Y20DTH Without ABS		◦	GHA400053	K
2.2 16V (108 kW)	2001.03-2005.01	Saloon Engine Z22SE	•		GHA333102	K
	2001.03-2005.01	Saloon Engine Z22SE With ABS	•		GHA333029	K
	2001.03-2005.01	Saloon Engine Z22SE With ABS		◦	GHA400052	K
	2001.03-2005.01	Saloon Engine Z22SE Without ABS		◦	GHA400053	K
2.2 DTi (86 kW)	2002.09-2005.01	Saloon Engine Y22DTR With ABS	•		GHA333029	K
	2002.09-2005.01	Saloon Engine Y22DTR With ABS		◦	GHA400052	K



	 YEAR		F	R	G-AP Ref.	KIT
OPEL						
ASTRA G (F69_)						
2.2 DTi (92 kW)	2002.09-2005.01	Saloon Engine Y22DTR With ABS	•		GHA333029	K
	2002.09-2005.01	Saloon Engine Y22DTR With ABS		◦	GHA400052	K
ASTRA G (F70)						
1.6 (55 kW)	1999.01-2000.09	Box Engine X16SZR With ABS	•		GHA333033	K
	1999.01-2000.09	Box Engine X16SZR With ABS		◦	GHA400064	K
	1999.01-2000.09	Box Engine X16SZR Without ABS	•		GHA333036	K
	1999.01-2000.09	Box Engine X16SZR Without ABS		◦	GHA400058	K
1.6 (62 kW)	2000.09-2005.04	Box Engine Z16SE With ABS	•		GHA333033	K
	2000.09-2005.04	Box Engine Z16SE With ABS		◦	GHA400064	K
	2000.09-2005.04	Box Engine Z16SE Without ABS	•		GHA333036	K
	2000.09-2005.04	Box Engine Z16SE Without ABS		◦	GHA400058	K
1.7 TD (50 kW)	1999.01-2005.04	Box Engine X17DTL With ABS	•		GHA333033	K
	1999.01-2005.04	Box Engine X17DTL With ABS		◦	GHA400064	K
	1999.01-2005.04	Box Engine X17DTL Without ABS	•		GHA333036	K
	1999.01-2005.04	Box Engine X17DTL Without ABS		◦	GHA400058	K
2.0 Di (60 kW)	1999.01-2005.04	Box Engine X20DTL With ABS	•		GHA333029	K
	1999.01-2005.04	Box Engine X20DTL With ABS		◦	GHA400052	K
	1999.01-2005.04	Box Engine X20DTL Without ABS	•		GHA333036	K
	1999.01-2005.04	Box Engine X20DTL Without ABS		◦	GHA400058	K
ASTRA GTC J						
1.4 (103 kW)	2011.10-	Hatchback Engine A14NET Fits Rim Size 15(Inch)	•		GHA333080	K
	2011.10-	Hatchback Engine A14NET Fits Rim Size 15(Inch)		◦	GHA400164	K
1.4 (74 kW)	2011.10-	Hatchback Engine A14XER Fits Rim Size 15(Inch)	•		GHA333080	K
	2011.10-	Hatchback Engine A14XER Fits Rim Size 15(Inch)		◦	GHA400164	K
1.4 (88 kW)	2011.10-	Hatchback Engine A14NET Fits Rim Size 15(Inch)	•		GHA333080	K
	2011.10-	Hatchback Engine A14NET Fits Rim Size 15(Inch)		◦	GHA400164	K
1.6 (132 kW)	2011.10-	Hatchback Engine A16LET Fits Rim Size 15(Inch)	•		GHA333080	K
	2011.10-	Hatchback Engine A16LET Fits Rim Size 15(Inch)		◦	GHA400164	K
1.6 SiDi (125 kW)	2012.12-	Hatchback Engine A16XHT	•		GHA333019	K
	2012.12-	Hatchback Engine A16XHT		◦	GHA400193	K
1.6 SiDi (147 kW)	2013.07-	Hatchback Engine A16SHT	•		GHA333019	K
	2013.07-	Hatchback Engine A16SHT		◦	GHA400193	K
1.7 CDTi (81 kW)	2011.10-	Hatchback Engine A17DTC/A17DTE/A17DTJ	•		GHA333019	K
	2011.10-	Hatchback Engine A17DTC/A17DTE/A17DTJ		◦	GHA400193	K
1.7 CDTi (96 kW)	2011.10-	Hatchback Engine A17DTF/A17DTS	•		GHA333019	K
	2011.10-	Hatchback Engine A17DTF/A17DTS		◦	GHA400193	K
1.8 (103 kW)	2011.10-	Hatchback Engine A18XER	•		GHA333019	K
	2011.10-	Hatchback Engine A18XER		◦	GHA400193	K
2.0 (206 kW)	2012.04-	Hatchback Engine A20NFT	•		GHA333019	K
	2012.04-	Hatchback Engine A20NFT		◦	GHA400193	K
2.0 BiTurbo CDTi (143 kW)	2012.10-	Hatchback Engine A20DTR	•		GHA333019	K
	2012.10-	Hatchback Engine A20DTR		◦	GHA400193	K
2.0 CDTi (121 kW)	2011.10-	Hatchback Engine A20DTH	•		GHA333019	K
	2011.10-	Hatchback Engine A20DTH		◦	GHA400193	K
ASTRA H (L35)						
1.3 CDTi (66 kW)	2005.08-	Estate Engine Z13DTH	•		GHA333069	K
	2005.08-	Estate Engine Z13DTH	•		GHA333070	K
	2005.08-	Estate Engine Z13DTH		◦	GHA400133	K
	2005.08-	Estate Engine Z13DTH		◦	GHA400153	K
1.4 (55 kW)	2004.08-	Estate Engine Z14XEL	•		GHA333069	K
	2004.08-	Estate Engine Z14XEL	•		GHA333070	K
	2004.08-	Estate Engine Z14XEL		◦	GHA400133	K
	2004.08-	Estate Engine Z14XEL		◦	GHA400153	K
1.4 (66 kW)	2004.08-	Estate Engine Z14XEP	•		GHA333069	K
	2004.08-	Estate Engine Z14XEP	•		GHA333070	K
	2004.08-	Estate Engine Z14XEP		◦	GHA400133	K
	2004.08-	Estate Engine Z14XEP		◦	GHA400153	K
1.4 LPG (66 kW)	2009.08-	Estate Engine Z14XEP	•		GHA333069	K
	2009.08-	Estate Engine Z14XEP	•		GHA333070	K
	2009.08-	Estate Engine Z14XEP		◦	GHA400133	K
	2009.08-	Estate Engine Z14XEP		◦	GHA400153	K
1.6 (77 kW)	2004.08-	Estate Engine Z16XEP	•		GHA333069	K
	2004.08-	Estate Engine Z16XEP	•		GHA333070	K
	2004.08-	Estate Engine Z16XEP		◦	GHA400133	K



	 YEAR		F	R	G-AP Ref.	KIT
OPEL						
ASTRA H (L35)						
1.6 (77 kW)	2004.08-	Estate Engine Z16XEP		o	GHA400153	K
1.6 (85 kW)	2006.12-	Estate Engine A16XER/Z16XER	•		GHA333069	K
	2006.12-	Estate Engine A16XER/Z16XER	•		GHA333070	K
	2006.12-	Estate Engine A16XER/Z16XER		o	GHA400133	K
	2006.12-	Estate Engine A16XER/Z16XER		o	GHA400153	K
	2006.12-	Estate Engine A16XER/Z16XER		o	GHA400153	K
1.6 LPG (85 kW)	2009.08-	Estate Engine Z16XER	•		GHA333069	K
	2009.08-	Estate Engine Z16XER	•		GHA333070	K
	2009.08-	Estate Engine Z16XER		o	GHA400133	K
	2009.08-	Estate Engine Z16XER		o	GHA400153	K
1.6 Turbo (132 kW)	2007.02-	Estate Engine Z16LET	•		GHA333069	K
	2007.02-	Estate Engine Z16LET	•		GHA333070	K
	2007.02-	Estate Engine Z16LET		o	GHA400133	K
	2007.02-	Estate Engine Z16LET		o	GHA400153	K
1.7 CDTi (59 kW)	2004.08-	Estate Engine Z17DTL	•		GHA333069	K
	2004.08-	Estate Engine Z17DTL	•		GHA333070	K
	2004.08-	Estate Engine Z17DTL		o	GHA400133	K
	2004.08-	Estate Engine Z17DTL		o	GHA400153	K
1.7 CDTi (74 kW)	2006.11-2008.03	Estate Engine Z17DTH	•		GHA333069	K
	2006.11-2008.03	Estate Engine Z17DTH	•		GHA333070	K
	2006.11-2008.03	Estate Engine Z17DTH		o	GHA400133	K
	2006.11-2008.03	Estate Engine Z17DTH		o	GHA400153	K
1.7 CDTi (81 kW)	2007.02-	Estate Engine A17DTJ/Z17DTJ	•		GHA333069	K
	2007.02-	Estate Engine A17DTJ/Z17DTJ	•		GHA333070	K
	2007.02-	Estate Engine A17DTJ/Z17DTJ		o	GHA400133	K
	2007.02-	Estate Engine A17DTJ/Z17DTJ		o	GHA400153	K
1.7 CDTi (92 kW)	2007.02-	Estate Engine A17DTR/Z17DTR	•		GHA333069	K
	2007.02-	Estate Engine A17DTR/Z17DTR	•		GHA333097	K
	2007.02-	Estate Engine A17DTR/Z17DTR		o	GHA400133	K
	2007.02-	Estate Engine A17DTR/Z17DTR		o	GHA400153	K
1.8 (103 kW)	2005.08-	Estate Engine A18XER/Z18XER	•		GHA333069	K
	2005.08-	Estate Engine A18XER/Z18XER	•		GHA333070	K
	2005.08-	Estate Engine A18XER/Z18XER		o	GHA400133	K
	2005.08-	Estate Engine A18XER/Z18XER		o	GHA400153	K
1.8 (92 kW)	2004.08-	Estate Engine Z18XE	•		GHA333069	K
	2004.08-	Estate Engine Z18XE	•		GHA333070	K
	2004.08-	Estate Engine Z18XE		o	GHA400133	K
	2004.08-	Estate Engine Z18XE		o	GHA400153	K
1.9 CDTi (110 kW)	2006.11-2008.03	Estate Engine Z19DTH	•		GHA3330013	K
	2006.11-2008.03	Estate Engine Z19DTH	•		GHA333069	K
	2006.11-2008.03	Estate Engine Z19DTH		o	GHA400133	K
	2006.11-2008.03	Estate Engine Z19DTH		o	GHA400153	K
1.9 CDTi (74 kW)	2005.09-	Estate Engine Z19DTL	•		GHA333069	K
	2005.09-	Estate Engine Z19DTL	•		GHA333070	K
	2005.09-	Estate Engine Z19DTL	•		GHA333097	K
	2005.09-	Estate Engine Z19DTL		o	GHA400133	K
	2005.09-	Estate Engine Z19DTL		o	GHA400153	K
1.9 CDTi (88 kW)	2006.11-2008.03	Estate Engine Z19DT	•		GHA333069	K
	2006.11-2008.03	Estate Engine Z19DT	•		GHA333070	K
	2006.11-2008.03	Estate Engine Z19DT	•		GHA333097	K
	2006.11-2008.03	Estate Engine Z19DT		o	GHA400133	K
	2006.11-2008.03	Estate Engine Z19DT		o	GHA400153	K
1.9 CDTi 16V (88 kW)	2004.08-	Estate Engine Z19DTJ	•		GHA333069	K
	2004.08-	Estate Engine Z19DTJ	•		GHA333070	K
	2004.08-	Estate Engine Z19DTJ	•		GHA333097	K
	2004.08-	Estate Engine Z19DTJ		o	GHA400133	K
	2004.08-	Estate Engine Z19DTJ		o	GHA400153	K
2.0 Turbo (125 kW)	2004.08-	Estate Engine Z20LEL	•		GHA333069	K
	2004.08-	Estate Engine Z20LEL	•		GHA333070	K
	2004.08-	Estate Engine Z20LEL	•		GHA333097	K
	2004.08-	Estate Engine Z20LEL		o	GHA400133	K
	2004.08-	Estate Engine Z20LEL		o	GHA400153	K
2.0 Turbo (147 kW)	2004.09-	Estate Engine Z20LER	•		GHA333069	K
	2004.09-	Estate Engine Z20LER	•		GHA333070	K
	2004.09-	Estate Engine Z20LER	•		GHA333097	K



	 YEAR		F	R	G-AP Ref.	KIT
OPEL						
ASTRA H (L35)						
2.0 Turbo (147 kW)	2004.09-	Estate Engine Z20LER		o	GHA400133	K
	2004.09-	Estate Engine Z20LER		o	GHA400153	K
ASTRA H (L48)						
1.2 (59 kW)	2005.08-	Hatchback Engine Z12XEP	•		GHA333069	K
	2005.08-	Hatchback Engine Z12XEP	•		GHA333070	K
	2005.08-	Hatchback Engine Z12XEP		o	GHA400133	K
	2005.08-	Hatchback Engine Z12XEP		o	GHA400153	K
1.3 CDTi (66 kW)	2005.08-	Hatchback Engine Z13DTH	•		GHA333069	K
	2005.08-	Hatchback Engine Z13DTH	•		GHA333070	K
	2005.08-	Hatchback Engine Z13DTH		o	GHA400133	K
	2005.08-	Hatchback Engine Z13DTH		o	GHA400153	K
1.4 (55 kW)	2004.04-2004.10	Hatchback Engine Z14XEL	•		GHA333069	K
	2004.04-2004.10	Hatchback Engine Z14XEL	•		GHA333070	K
	2004.04-2004.10	Hatchback Engine Z14XEL		o	GHA400133	K
	2004.04-2004.10	Hatchback Engine Z14XEL		o	GHA400153	K
1.4 (66 kW)	2004.03-	Hatchback Engine Z14XEP	•		GHA333069	K
	2004.03-	Hatchback Engine Z14XEP	•		GHA333070	K
	2004.03-	Hatchback Engine Z14XEP		o	GHA400133	K
	2004.03-	Hatchback Engine Z14XEP		o	GHA400153	K
1.4 LPG (66 kW)	2009.08-	Hatchback Engine Z14XEP	•		GHA333069	K
	2009.08-	Hatchback Engine Z14XEP	•		GHA333070	K
	2009.08-	Hatchback Engine Z14XEP		o	GHA400133	K
	2009.08-	Hatchback Engine Z14XEP		o	GHA400153	K
1.6 (77 kW)	2004.03-	Hatchback Engine Z16XEP	•		GHA333069	K
	2004.03-	Hatchback Engine Z16XEP	•		GHA333070	K
	2004.03-	Hatchback Engine Z16XEP		o	GHA400133	K
	2004.03-	Hatchback Engine Z16XEP		o	GHA400153	K
1.6 (85 kW)	2006.12-	Hatchback Engine A16XER/Z16XER	•		GHA333069	K
	2006.12-	Hatchback Engine A16XER/Z16XER	•		GHA333070	K
	2006.12-	Hatchback Engine A16XER/Z16XER		o	GHA400133	K
	2006.12-	Hatchback Engine A16XER/Z16XER		o	GHA400153	K
1.6 Turbo (132 kW)	2007.02-	Hatchback Engine Z16LET	•		GHA333069	K
	2007.02-	Hatchback Engine Z16LET	•		GHA333070	K
	2007.02-	Hatchback Engine Z16LET		o	GHA400133	K
	2007.02-	Hatchback Engine Z16LET		o	GHA400153	K
1.7 CDTi (59 kW)	2004.03-	Hatchback Engine Z17DTL	•		GHA333069	K
	2004.03-	Hatchback Engine Z17DTL	•		GHA333070	K
	2004.03-	Hatchback Engine Z17DTL		o	GHA400133	K
	2004.03-	Hatchback Engine Z17DTL		o	GHA400153	K
1.7 CDTi (74 kW)	2005.01-2008.03	Hatchback Engine Z17DTH	•		GHA333069	K
	2005.01-2008.03	Hatchback Engine Z17DTH	•		GHA333070	K
	2005.01-2008.03	Hatchback Engine Z17DTH		o	GHA400133	K
	2005.01-2008.03	Hatchback Engine Z17DTH		o	GHA400153	K
1.7 CDTi (81 kW)	2007.02-	Hatchback Engine A17DTJ/Z17DTJ	•		GHA333069	K
	2007.02-	Hatchback Engine A17DTJ/Z17DTJ	•		GHA333070	K
	2007.02-	Hatchback Engine A17DTJ/Z17DTJ		o	GHA400133	K
	2007.02-	Hatchback Engine A17DTJ/Z17DTJ		o	GHA400153	K
1.7 CDTi (92 kW)	2007.02-	Hatchback Engine A17DTR/Z17DTR	•		GHA333069	K
	2007.02-	Hatchback Engine A17DTR/Z17DTR	•		GHA333070	K
	2007.02-	Hatchback Engine A17DTR/Z17DTR		o	GHA400133	K
	2007.02-	Hatchback Engine A17DTR/Z17DTR		o	GHA400153	K
1.8 (103 kW)	2006.06-2008.03	Hatchback Engine A18XER/Z18XER	•		GHA333069	K
	2006.06-2008.03	Hatchback Engine A18XER/Z18XER	•		GHA333070	K
	2006.06-2008.03	Hatchback Engine A18XER/Z18XER		o	GHA400133	K
	2006.06-2008.03	Hatchback Engine A18XER/Z18XER		o	GHA400153	K
1.8 (92 kW)	2004.03-	Hatchback Engine Z18XE	•		GHA333069	K
	2004.03-	Hatchback Engine Z18XE	•		GHA333070	K
	2004.03-	Hatchback Engine Z18XE		o	GHA400133	K
	2004.03-	Hatchback Engine Z18XE		o	GHA400153	K
1.9 CDTi (110 kW)	2005.01-2008.03	Hatchback Engine Z19DTH	•		GHA330013	K
	2005.01-2008.03	Hatchback Engine Z19DTH	•		GHA333069	K
	2005.01-2008.03	Hatchback Engine Z19DTH		o	GHA400133	K
	2005.01-2008.03	Hatchback Engine Z19DTH		o	GHA400153	K
1.9 CDTi (74 kW)	2005.09-	Hatchback Engine Z19DTL	•		GHA333069	K



	 YEAR		F	R	G-AP Ref.	KIT
OPEL						
ASTRA H (L48)						
1.9 CDTi (74 kW)	2005.09-	Hatchback Engine Z19DTL	•		GHA333070	K
	2005.09-	Hatchback Engine Z19DTL	•		GHA333097	K
	2005.09-	Hatchback Engine Z19DTL		◦	GHA400133	K
	2005.09-	Hatchback Engine Z19DTL		◦	GHA400153	K
1.9 CDTi (88 kW)	2006.01-2008.03	Hatchback Engine Z19DT	•		GHA333069	K
	2006.01-2008.03	Hatchback Engine Z19DT	•		GHA333070	K
	2006.01-2008.03	Hatchback Engine Z19DT	•		GHA333097	K
	2006.01-2008.03	Hatchback Engine Z19DT		◦	GHA400133	K
	2006.01-2008.03	Hatchback Engine Z19DT		◦	GHA400153	K
1.9 CDTi 16V (88 kW)	2004.06-2007.01	Hatchback Engine Z19DTJ	•		GHA333069	K
	2004.06-2007.01	Hatchback Engine Z19DTJ	•		GHA333070	K
	2004.06-2007.01	Hatchback Engine Z19DTJ	•		GHA333097	K
	2004.06-2007.01	Hatchback Engine Z19DTJ		◦	GHA400133	K
	2004.06-2007.01	Hatchback Engine Z19DTJ		◦	GHA400153	K
2.0 Turbo (125 kW)	2004.03-	Hatchback Engine Z20LEL	•		GHA333069	K
	2004.03-	Hatchback Engine Z20LEL	•		GHA333070	K
	2004.03-	Hatchback Engine Z20LEL	•		GHA333097	K
	2004.03-	Hatchback Engine Z20LEL		◦	GHA400133	K
	2004.03-	Hatchback Engine Z20LEL		◦	GHA400153	K
2.0 Turbo (147 kW)	2006.11-2008.03	Hatchback Engine Z20LER	•		GHA333069	K
	2006.11-2008.03	Hatchback Engine Z20LER	•		GHA333070	K
	2006.11-2008.03	Hatchback Engine Z20LER	•		GHA333097	K
	2006.11-2008.03	Hatchback Engine Z20LER		◦	GHA400133	K
	2006.11-2008.03	Hatchback Engine Z20LER		◦	GHA400153	K
2.0 Turbo (177 kW)	2005.04-2008.03	Hatchback Engine Z20LEH	•		GHA330013	K
	2005.04-2008.03	Hatchback Engine Z20LEH	•		GHA333069	K
	2005.04-2008.03	Hatchback Engine Z20LEH		◦	GHA400133	K
	2005.04-2008.03	Hatchback Engine Z20LEH		◦	GHA400153	K
ASTRA H (L69)						
1.3 CDTi (66 kW)	2007.02-	Saloon Engine Z13DTH	•		GHA333069	K
	2007.02-	Saloon Engine Z13DTH	•		GHA333070	K
	2007.02-	Saloon Engine Z13DTH		◦	GHA400133	K
	2007.02-	Saloon Engine Z13DTH		◦	GHA400153	K
1.6 (85 kW)	2007.02-	Saloon Engine Z16XER	•		GHA333069	K
	2007.02-	Saloon Engine Z16XER	•		GHA333070	K
	2007.02-	Saloon Engine Z16XER		◦	GHA400133	K
	2007.02-	Saloon Engine Z16XER		◦	GHA400153	K
1.7 CDTi (74 kW)	2007.02-	Saloon Engine Z17DTH	•		GHA333069	K
	2007.02-	Saloon Engine Z17DTH	•		GHA333070	K
	2007.02-	Saloon Engine Z17DTH		◦	GHA400133	K
	2007.02-	Saloon Engine Z17DTH		◦	GHA400153	K
1.7 CDTi (81 kW)	2007.02-	Saloon Engine Z17DTJ	•		GHA333069	K
	2007.02-	Saloon Engine Z17DTJ	•		GHA333070	K
	2007.02-	Saloon Engine Z17DTJ		◦	GHA400133	K
	2007.02-	Saloon Engine Z17DTJ		◦	GHA400153	K
1.7 CDTi (92 kW)	2010.07-	Saloon Engine A17DTR/Z17DTR	•		GHA333069	K
	2010.07-	Saloon Engine A17DTR/Z17DTR	•		GHA333097	K
	2010.07-	Saloon Engine A17DTR/Z17DTR		◦	GHA400133	K
	2010.07-	Saloon Engine A17DTR/Z17DTR		◦	GHA400153	K
1.8 (103 kW)	2007.02-	Saloon Engine A18XER/Z18XER	•		GHA333069	K
	2007.02-	Saloon Engine A18XER/Z18XER	•		GHA333070	K
	2007.02-	Saloon Engine A18XER/Z18XER		◦	GHA400133	K
	2007.02-	Saloon Engine A18XER/Z18XER		◦	GHA400153	K
ASTRA H GTC (L08)						
1.2 (59 kW)	2005.08-	Hatchback Engine Z12XEP	•		GHA333069	K
	2005.08-	Hatchback Engine Z12XEP	•		GHA333070	K
	2005.08-	Hatchback Engine Z12XEP		◦	GHA400133	K
	2005.08-	Hatchback Engine Z12XEP		◦	GHA400153	K
ASTRA H SPORP HATCH (L08)						
1.3 CDTi (66 kW)	2005.04-	Hatchback Engine Z13DTH	•		GHA333069	K
	2005.04-	Hatchback Engine Z13DTH	•		GHA333070	K
	2005.04-	Hatchback Engine Z13DTH		◦	GHA400133	K
	2005.04-	Hatchback Engine Z13DTH		◦	GHA400153	K
1.4 (55 kW)	2005.03-	Hatchback Engine Z14XEL	•		GHA333069	K



	 YEAR		F	R	G-AP Ref.	KIT
OPEL						
ASTRA H SPORP HATCH (L08)						
1.4 (55 kW)	2005.03-	Hatchback Engine Z14XEL	•		GHA333070	K
	2005.03-	Hatchback Engine Z14XEL		◦	GHA400133	K
	2005.03-	Hatchback Engine Z14XEL		◦	GHA400153	K
1.4 (66 kW)	2005.03-	Hatchback Engine Z14XEP	•		GHA333069	K
	2005.03-	Hatchback Engine Z14XEP	•		GHA333070	K
	2005.03-	Hatchback Engine Z14XEP		◦	GHA400133	K
	2005.03-	Hatchback Engine Z14XEP		◦	GHA400153	K
1.6 (77 kW)	2005.03-	Hatchback Engine Z16XEP	•		GHA333069	K
	2005.03-	Hatchback Engine Z16XEP	•		GHA333070	K
	2005.03-	Hatchback Engine Z16XEP		◦	GHA400133	K
	2005.03-	Hatchback Engine Z16XEP		◦	GHA400153	K
1.6 (85 kW)	2006.12-	Hatchback Engine Z16XER	•		GHA333069	K
	2006.12-	Hatchback Engine Z16XER	•		GHA333070	K
	2006.12-	Hatchback Engine Z16XER		◦	GHA400133	K
	2006.12-	Hatchback Engine Z16XER		◦	GHA400153	K
1.6 Turbo (132 kW)	2007.02-	Hatchback Engine Z16LET	•		GHA333069	K
	2007.02-	Hatchback Engine Z16LET	•		GHA333070	K
	2007.02-	Hatchback Engine Z16LET		◦	GHA400133	K
	2007.02-	Hatchback Engine Z16LET		◦	GHA400153	K
1.7 CDTi (59 kW)	2005.03-	Hatchback Engine Z17DTL	•		GHA333069	K
	2005.03-	Hatchback Engine Z17DTL	•		GHA333070	K
	2005.03-	Hatchback Engine Z17DTL		◦	GHA400133	K
	2005.03-	Hatchback Engine Z17DTL		◦	GHA400153	K
1.7 CDTi (74 kW)	2007.04-2008.03	Hatchback Engine Z17DTH	•		GHA333069	K
	2007.04-2008.03	Hatchback Engine Z17DTH	•		GHA333070	K
	2007.04-2008.03	Hatchback Engine Z17DTH		◦	GHA400133	K
	2007.04-2008.03	Hatchback Engine Z17DTH		◦	GHA400153	K
1.7 CDTi (81 kW)	2007.02-	Hatchback Engine A17DTJ	•		GHA333069	K
	2007.02-	Hatchback Engine A17DTJ	•		GHA333070	K
	2007.02-	Hatchback Engine A17DTJ		◦	GHA400133	K
	2007.02-	Hatchback Engine A17DTJ		◦	GHA400153	K
1.7 CDTi (92 kW)	2007.02-	Hatchback Engine A17DTR	•		GHA333069	K
	2007.02-	Hatchback Engine A17DTR	•		GHA333097	K
	2007.02-	Hatchback Engine A17DTR		◦	GHA400133	K
	2007.02-	Hatchback Engine A17DTR		◦	GHA400153	K
1.8 (103 kW)	2006.01-	Hatchback Engine Z18XER	•		GHA333069	K
	2006.01-	Hatchback Engine Z18XER	•		GHA333070	K
	2006.01-	Hatchback Engine Z18XER		◦	GHA400133	K
	2006.01-	Hatchback Engine Z18XER		◦	GHA400153	K
1.8 (92 kW)	2005.03-	Hatchback Engine Z18XE	•		GHA333069	K
	2005.03-	Hatchback Engine Z18XE	•		GHA333070	K
	2005.03-	Hatchback Engine Z18XE		◦	GHA400133	K
	2005.03-	Hatchback Engine Z18XE		◦	GHA400153	K
1.9 CDTi (110 kW)	2006.11-2008.03	Hatchback Engine Z19DTH	•		GHA330013	K
	2006.11-2008.03	Hatchback Engine Z19DTH	•		GHA333069	K
	2006.11-2008.03	Hatchback Engine Z19DTH		◦	GHA400133	K
	2006.11-2008.03	Hatchback Engine Z19DTH		◦	GHA400153	K
1.9 CDTi (74 kW)	2006.01-	Hatchback Engine Z19DTL	•		GHA333069	K
	2006.01-	Hatchback Engine Z19DTL	•		GHA333070	K
	2006.01-	Hatchback Engine Z19DTL	•		GHA333097	K
	2006.01-	Hatchback Engine Z19DTL		◦	GHA400133	K
	2006.01-	Hatchback Engine Z19DTL		◦	GHA400153	K
1.9 CDTi (88 kW)	2005.09-	Hatchback Engine Z19DT	•		GHA333069	K
	2005.09-	Hatchback Engine Z19DT	•		GHA333070	K
	2005.09-	Hatchback Engine Z19DT	•		GHA333097	K
	2005.09-	Hatchback Engine Z19DT		◦	GHA400133	K
	2005.09-	Hatchback Engine Z19DT		◦	GHA400153	K
1.9 CDTi 16V (88 kW)	2005.03-	Hatchback Engine Z19DTJ	•		GHA333069	K
	2005.03-	Hatchback Engine Z19DTJ	•		GHA333070	K
	2005.03-	Hatchback Engine Z19DTJ	•		GHA333097	K
	2005.03-	Hatchback Engine Z19DTJ		◦	GHA400133	K
	2005.03-	Hatchback Engine Z19DTJ		◦	GHA400153	K
2.0 Turbo (125 kW)	2005.03-	Hatchback Engine Z20LEL	•		GHA333069	K
	2005.03-	Hatchback Engine Z20LEL	•		GHA333070	K



	 YEAR		F	R	G-AP Ref.	KIT
OPEL						
ASTRA H SPORP HATCH (L08)						
2.0 Turbo (125 kW)	2005.03-	Hatchback Engine Z20LEL	•		GHA333097	K
	2005.03-	Hatchback Engine Z20LEL		◦	GHA400133	K
	2005.03-	Hatchback Engine Z20LEL		◦	GHA400153	K
2.0 Turbo (147 kW)	2005.03-	Hatchback Engine Z20LER	•		GHA333069	K
	2005.03-	Hatchback Engine Z20LER	•		GHA333070	K
	2005.03-	Hatchback Engine Z20LER	•		GHA333097	K
	2005.03-	Hatchback Engine Z20LER		◦	GHA400133	K
	2005.03-	Hatchback Engine Z20LER		◦	GHA400153	K
2.0 Turbo (177 kW)	2005.08-	Hatchback Engine Z20LEH	•		GHA3330013	K
	2005.08-	Hatchback Engine Z20LEH	•		GHA333069	K
	2005.08-	Hatchback Engine Z20LEH		◦	GHA400133	K
	2005.08-	Hatchback Engine Z20LEH		◦	GHA400153	K
ASTRA H TWINTOP (L67)						
1.6 (77 kW)	2005.09-	Convertible Engine Z16XE1/Z16XEP	•		GHA333069	K
	2005.09-	Convertible Engine Z16XE1/Z16XEP	•		GHA333070	K
	2005.09-	Convertible Engine Z16XE1/Z16XEP		◦	GHA400133	K
	2005.09-	Convertible Engine Z16XE1/Z16XEP		◦	GHA400153	K
1.6 (85 kW)	2006.12-	Convertible Engine Z16XER	•		GHA333069	K
	2006.12-	Convertible Engine Z16XER	•		GHA333070	K
	2006.12-	Convertible Engine Z16XER		◦	GHA400133	K
	2006.12-	Convertible Engine Z16XER		◦	GHA400153	K
1.6 Turbo (132 kW)	2007.02-	Convertible Engine Z16LET	•		GHA333069	K
	2007.02-	Convertible Engine Z16LET	•		GHA333070	K
	2007.02-	Convertible Engine Z16LET		◦	GHA400133	K
	2007.02-	Convertible Engine Z16LET		◦	GHA400153	K
1.8 (103 kW)	2006.05-2008.03	Convertible Engine A18XER/Z18XER	•		GHA333069	K
	2006.05-2008.03	Convertible Engine A18XER/Z18XER	•		GHA333070	K
	2006.05-2008.03	Convertible Engine A18XER/Z18XER		◦	GHA400133	K
	2006.05-2008.03	Convertible Engine A18XER/Z18XER		◦	GHA400153	K
1.8 (92 kW)	2005.09-	Convertible Engine Z18XE	•		GHA333069	K
	2005.09-	Convertible Engine Z18XE	•		GHA333070	K
	2005.09-	Convertible Engine Z18XE		◦	GHA400133	K
	2005.09-	Convertible Engine Z18XE		◦	GHA400153	K
1.9 CDTi (110 kW)	2007.04-2008.03	Convertible Engine Z19DTH	•		GHA3330013	K
	2007.04-2008.03	Convertible Engine Z19DTH	•		GHA333069	K
	2007.04-2008.03	Convertible Engine Z19DTH		◦	GHA400133	K
	2007.04-2008.03	Convertible Engine Z19DTH		◦	GHA400153	K
2.0 Turbo (125 kW)	2005.09-	Convertible Engine Z20LEL	•		GHA333069	K
	2005.09-	Convertible Engine Z20LEL	•		GHA333070	K
	2005.09-	Convertible Engine Z20LEL	•		GHA333097	K
	2005.09-	Convertible Engine Z20LEL		◦	GHA400133	K
	2005.09-	Convertible Engine Z20LEL		◦	GHA400153	K
2.0 Turbo (147 kW)	2007.04-2008.03	Convertible Engine Z20LER	•		GHA333069	K
	2007.04-2008.03	Convertible Engine Z20LER	•		GHA333070	K
	2007.04-2008.03	Convertible Engine Z20LER	•		GHA333097	K
	2007.04-2008.03	Convertible Engine Z20LER		◦	GHA400133	K
	2007.04-2008.03	Convertible Engine Z20LER		◦	GHA400153	K
ASTRA H VAN (L70)						
1.3 CDTi (66 kW)	2005.08-	Box Engine Z13DTH	•		GHA333069	K
	2005.08-	Box Engine Z13DTH	•		GHA333070	K
	2005.08-	Box Engine Z13DTH		◦	GHA400133	K
	2005.08-	Box Engine Z13DTH		◦	GHA400153	K
1.7 CDTi (74 kW)	2004.03-	Box Engine Z17DTH	•		GHA333069	K
	2004.03-	Box Engine Z17DTH	•		GHA333070	K
	2004.03-	Box Engine Z17DTH		◦	GHA400133	K
	2004.03-	Box Engine Z17DTH		◦	GHA400153	K
1.7 CDTi (81 kW)	2007.02-	Box Engine A17DTJ/Z17DTJ	•		GHA333069	K
	2007.02-	Box Engine A17DTJ/Z17DTJ	•		GHA333070	K
	2007.02-	Box Engine A17DTJ/Z17DTJ		◦	GHA400133	K
	2007.02-	Box Engine A17DTJ/Z17DTJ		◦	GHA400153	K
1.7 CDTi (92 kW)	2007.02-	Box Engine A17DTJ/Z17DTJ	•		GHA333069	K
	2007.02-	Box Engine A17DTJ/Z17DTJ	•		GHA333097	K
	2007.02-	Box Engine A17DTJ/Z17DTJ		◦	GHA400133	K
	2007.02-	Box Engine A17DTJ/Z17DTJ		◦	GHA400153	K



	 YEAR		F	R	G-AP Ref.	KIT
OPEL						
ASTRA H VAN (L70)						
1.9 CDTi (110 kW)	2004.09-	Box Engine Z19DTH	•		GHA330013	K
	2004.09-	Box Engine Z19DTH	•		GHA333069	K
	2004.09-	Box Engine Z19DTH		○	GHA400133	K
	2004.09-	Box Engine Z19DTH		○	GHA400153	K
1.9 CDTi (88 kW)	2005.09-	Box Engine Z19DT	•		GHA333069	K
	2005.09-	Box Engine Z19DT	•		GHA333097	K
	2005.09-	Box Engine Z19DT		○	GHA400133	K
	2005.09-	Box Engine Z19DT		○	GHA400153	K
ASTRA J						
1.3 CDTi (70 kW)	2009.12-	Hatchback Engine A13DTE	•		GHA330019	K
	2009.12-	Hatchback Engine A13DTE Fits Rim Size 15(Inch)	•		GHA333080	K
	2009.12-	Hatchback Engine A13DTE Fits Rim Size 15(Inch)		○	GHA400164	K
	2012.06-	Saloon Engine A13DTE	•		GHA330019	K
	2012.06-	Saloon Engine A13DTE Fits Rim Size 15(Inch)	•		GHA333080	K
	2012.06-	Saloon Engine A13DTE Fits Rim Size 15(Inch)		○	GHA400164	K
1.4 (64 kW)	2009.12-	Hatchback Engine A14XEL	•		GHA330019	K
	2009.12-	Hatchback Engine A14XEL Fits Rim Size 15(Inch)	•		GHA333080	K
	2009.12-	Hatchback Engine A14XEL Fits Rim Size 15(Inch)		○	GHA400164	K
1.4 (74 kW)	2009.12-	Hatchback Engine A14XER	•		GHA330019	K
	2009.12-	Hatchback Engine A14XER Fits Rim Size 15(Inch)	•		GHA333080	K
	2009.12-	Hatchback Engine A14XER Fits Rim Size 15(Inch)		○	GHA400164	K
	2012.06-	Saloon Engine A14XER	•		GHA330019	K
	2012.06-	Saloon Engine A14XER Fits Rim Size 15(Inch)	•		GHA333080	K
	2012.06-	Saloon Engine A14XER Fits Rim Size 15(Inch)		○	GHA400164	K
1.4 LPG (103 kW)	2012.01-	Hatchback Engine A14NET	•		GHA330019	K
	2012.01-	Hatchback Engine A14NET Fits Rim Size 15(Inch)	•		GHA333080	K
	2012.01-	Hatchback Engine A14NET Fits Rim Size 15(Inch)		○	GHA400164	K
	2014.07-	Saloon Engine A14NET	•		GHA330019	K
	2014.07-	Saloon Engine A14NET Fits Rim Size 15(Inch)	•		GHA333080	K
1.4 Turbo (103 kW)	2009.12-	Hatchback Engine A14NET	•		GHA330019	K
	2009.12-	Hatchback Engine A14NET Fits Rim Size 15(Inch)	•		GHA333080	K
	2009.12-	Hatchback Engine A14NET Fits Rim Size 15(Inch)		○	GHA400164	K
	2012.06-	Saloon Engine A14NET	•		GHA330019	K
	2012.06-	Saloon Engine A14NET Fits Rim Size 15(Inch)	•		GHA333080	K
	2012.06-	Saloon Engine A14NET Fits Rim Size 15(Inch)		○	GHA400164	K
1.4 Turbo (88 kW)	2010.10-	Hatchback Engine A14NEL Fits Rim Size 15(Inch)	•		GHA333080	K
	2010.10-	Hatchback Engine A14NEL Fits Rim Size 15(Inch)		○	GHA400164	K
	2012.06-	Saloon Engine A14NEL	•		GHA330019	K
	2012.06-	Saloon Engine A14NEL Fits Rim Size 15(Inch)	•		GHA333080	K
	2012.06-	Saloon Engine A14NEL Fits Rim Size 15(Inch)		○	GHA400164	K
	2012.06-	Saloon Engine A14NEL Fits Rim Size 15(Inch)	•		GHA330019	K
1.6 (85 kW)	2009.12-	Hatchback Engine A16XER	•		GHA330019	K
	2009.12-	Hatchback Engine A16XER Fits Rim Size 15(Inch)	•		GHA333080	K
	2009.12-	Hatchback Engine A16XER Fits Rim Size 15(Inch)		○	GHA400164	K
	2012.06-	Saloon Engine A16XER	•		GHA330019	K
	2012.06-	Saloon Engine A16XER Fits Rim Size 15(Inch)	•		GHA333080	K
	2012.06-	Saloon Engine A16XER Fits Rim Size 15(Inch)		○	GHA400164	K
1.6 CDTi (100 kW)	2014.01-	Hatchback Engine B16DTH	•		GHA330019	K
	2014.01-	Hatchback Engine B16DTH Fits Rim Size 15(Inch)	•		GHA333080	K
	2014.01-	Saloon Engine B16DTH	•		GHA330019	K
	2014.01-	Saloon Engine B16DTH Fits Rim Size 15(Inch)	•		GHA333080	K
	2014.01-	Saloon Engine B16DTH Fits Rim Size 15(Inch)		○	GHA400164	K
1.6 CDTi (81 kW)	2014.02-	Hatchback Engine B16DTL	•		GHA330019	K
	2014.02-	Hatchback Engine B16DTL Fits Rim Size 15(Inch)	•		GHA333080	K
	2014.04-	Saloon Engine B16DTL	•		GHA330019	K
	2014.04-	Saloon Engine B16DTL Fits Rim Size 15(Inch)	•		GHA333080	K
1.6 SiDi (125 kW)	2012.12-	Hatchback Engine A16XHT	•		GHA330019	K
	2012.12-	Hatchback Engine A16XHT Fits Rim Size 15(Inch)	•		GHA333080	K
	2012.12-	Saloon Engine A16XHT	•		GHA330019	K
	2012.12-	Saloon Engine A16XHT Fits Rim Size 15(Inch)	•		GHA333080	K
1.6 Turbo (132 kW)	2009.12-	Hatchback Engine A16LET	•		GHA330019	K
	2009.12-	Hatchback Engine A16LET		○	GHA400193	K
	2009.12-	Hatchback Engine A16LET Fits Rim Size 15(Inch)	•		GHA333080	K
	2012.06-	Saloon Engine A16LET	•		GHA330019	K
	2012.06-	Saloon Engine A16LET		○	GHA400193	K
	2012.06-	Saloon Engine A16LET Fits Rim Size 15(Inch)	•		GHA333080	K



	 YEAR		F	R	G-AP Ref.	KIT
OPEL						
ASTRA J						
1.7 CDTi (74 kW)	2010.10-	Hatchback Engine A17DTL	•		GHA330019	K
	2010.10-	Hatchback Engine A17DTL		◦	GHA400193	K
	2010.10-	Hatchback Engine A17DTL Fits Rim Size 15(Inch)	•		GHA333080	K
1.7 CDTi (81 kW)	2009.12-	Hatchback Engine A17DTC/A17DTE/A17DTJ	•		GHA330019	K
	2009.12-	Hatchback Engine A17DTC/A17DTE/A17DTJ		◦	GHA400193	K
	2009.12-	Hatchback Engine A17DTC/A17DTE/A17DTJ Fits Rim Size 15(Inch)	•		GHA333080	K
	2012.06-	Saloon Engine A17DTC/A17DTE/A17DTJ	•		GHA330019	K
	2012.06-	Saloon Engine A17DTC/A17DTE/A17DTJ		◦	GHA400193	K
	2012.06-	Saloon Engine A17DTC/A17DTE/A17DTJ Fits Rim Size 15(Inch)	•		GHA333080	K
1.7 CDTi (92 kW)	2009.12-	Hatchback Engine A17DTR	•		GHA330019	K
	2009.12-	Hatchback Engine A17DTR		◦	GHA400193	K
	2009.12-	Hatchback Engine A17DTR Fits Rim Size 15(Inch)	•		GHA333080	K
1.7 CDTi (96 kW)	2009.12-	Hatchback Engine A17DTF/A17DTS	•		GHA330019	K
	2009.12-	Hatchback Engine A17DTF/A17DTS		◦	GHA400193	K
	2009.12-	Hatchback Engine A17DTF/A17DTS Fits Rim Size 15(Inch)	•		GHA333080	K
	2012.06-	Saloon Engine A17DTF/A17DTS	•		GHA330019	K
	2012.06-	Saloon Engine A17DTF/A17DTS		◦	GHA400193	K
	2012.06-	Saloon Engine A17DTF/A17DTS Fits Rim Size 15(Inch)	•		GHA333080	K
2.0 BiTurbo CDTi (143 kW)	2012.12-	Hatchback Engine A20DTR	•		GHA330019	K
	2012.12-	Hatchback Engine A20DTR		◦	GHA400193	K
	2012.12-	Hatchback Engine A20DTR Fits Rim Size 15(Inch)	•		GHA333080	K
2.0 CDTi (118 kW)	2009.12-	Hatchback Engine A20DTH	•		GHA330019	K
	2009.12-	Hatchback Engine A20DTH		◦	GHA400193	K
	2009.12-	Hatchback Engine A20DTH Fits Rim Size 15(Inch)	•		GHA333080	K
2.0 CDTi (121 kW)	2011.06-	Hatchback Engine A20DTH	•		GHA330019	K
	2011.06-	Hatchback Engine A20DTH		◦	GHA400193	K
	2011.06-	Hatchback Engine A20DTH Fits Rim Size 15(Inch)	•		GHA333080	K
ASTRA J SPORTS TOURER						
1.3 CDTi (70 kW)	2010.10-	Estate Engine A13DTE Fits Rim Size 15(Inch)	•		GHA333080	K
	2010.10-	Estate Engine A13DTE Fits Rim Size 15(Inch)		◦	GHA400164	K
1.4 (74 kW)	2010.10-	Estate Engine A14XER Fits Rim Size 15(Inch)	•		GHA333080	K
	2010.10-	Estate Engine A14XER Fits Rim Size 15(Inch)		◦	GHA400164	K
1.4 LPG (103 kW)	2012.01-	Estate Engine A14NET Fits Rim Size 15(Inch)	•		GHA333080	K
	2012.01-	Estate Engine A14NET Fits Rim Size 15(Inch)		◦	GHA400164	K
1.4 Turbo (103 kW)	2010.10-	Estate Engine A14NET Fits Rim Size 15(Inch)	•		GHA333080	K
	2010.10-	Estate Engine A14NET Fits Rim Size 15(Inch)		◦	GHA400164	K
1.4 Turbo (88 kW)	2010.10-	Estate Engine A14NEL	•		GHA330019	K
	2010.10-	Estate Engine A14NEL Fits Rim Size 15(Inch)	•		GHA333080	K
	2010.10-	Estate Engine A14NEL Fits Rim Size 15(Inch)		◦	GHA400164	K
1.6 (85 kW)	2010.10-	Estate Engine A16XER Fits Rim Size 15(Inch)	•		GHA333080	K
	2010.10-	Estate Engine A16XER Fits Rim Size 15(Inch)		◦	GHA400164	K
1.6 CDTi (100 kW)	2014.01-	Estate Engine B16DTH	•		GHA330019	K
	2014.01-	Estate Engine B16DTH Fits Rim Size 15(Inch)	•		GHA333080	K
1.6 CDTi (81 kW)	2014.02-	Estate Engine B16DTL	•		GHA330019	K
	2014.02-	Estate Engine B16DTL Fits Rim Size 15(Inch)	•		GHA333080	K
1.6 LPG (84 kW)	2012.10-	Estate Engine A16XER Fits Rim Size 15(Inch)	•		GHA333080	K
	2012.10-	Estate Engine A16XER Fits Rim Size 15(Inch)		◦	GHA400164	K
1.6 Turbo (132 kW)	2010.10-	Estate Engine A16LET	•		GHA330019	K
	2010.10-	Estate Engine A16LET		◦	GHA400193	K
1.7 CDTi (74 kW)	2010.10-	Estate Engine A17DTL	•		GHA330019	K
	2010.10-	Estate Engine A17DTL		◦	GHA400193	K
1.7 CDTi (81 kW)	2010.10-	Estate Engine A17DTC/A17DTE/A17DTJ	•		GHA330019	K
	2010.10-	Estate Engine A17DTC/A17DTE/A17DTJ		◦	GHA400193	K
1.7 CDTi (92 kW)	2010.10-	Estate Engine A17DTR	•		GHA330019	K
	2010.10-	Estate Engine A17DTR		◦	GHA400193	K
1.7 CDTi (96 kW)	2010.10-	Estate Engine A17DTF/A17DTS	•		GHA330019	K
	2010.10-	Estate Engine A17DTF/A17DTS		◦	GHA400193	K
2.0 BiTurbo CDTi (143 kW)	2012.12-	Estate Engine A20DTR	•		GHA330019	K
	2012.12-	Estate Engine A20DTR		◦	GHA400193	K
2.0 CDTi (118 kW)	2010.10-	Estate Engine A20DTH	•		GHA330019	K
	2010.10-	Estate Engine A20DTH		◦	GHA400193	K
2.0 CDTi (121 kW)	2011.08-	Estate Engine A20DTH	•		GHA330019	K
	2011.08-	Estate Engine A20DTH		◦	GHA400193	K



	 YEAR		F	R	G-AP Ref.	KIT
OPEL						
CALIBRA A (85_)						
2.0 i (85 kW)	1990.06-1997.07	Coupe Engine C20NE	•		GHA433007	
	1990.06-1997.07	Coupe Engine C20NE	•		GHA433013	
	1990.06-1997.07	Coupe Engine C20NE	•		GHA433019	
	1990.06-1997.07	Coupe Engine C20NE	•		GWB0736	
	1990.06-1997.07	Coupe Engine C20NE	•		GWB3410	
	1990.06-1997.07	Coupe Engine C20NE		◦	GWB1326	
2.0 i 16V (100 kW)	1994.02-1997.07	Coupe Engine X20XEV	•		GHA433007	
	1994.02-1997.07	Coupe Engine X20XEV	•		GHA433013	
	1994.02-1997.07	Coupe Engine X20XEV	•		GHA433019	
	1994.02-1997.07	Coupe Engine X20XEV	•		GWB0736	
	1994.02-1997.07	Coupe Engine X20XEV	•		GWB3410	
	1994.02-1997.07	Coupe Engine X20XEV		◦	GWB1326	
2.0 i 16V (110 kW)	1990.06-1994.02	Coupe Engine C20XE	•		GHA433007	
	1990.06-1994.02	Coupe Engine C20XE	•		GHA433013	
	1990.06-1994.02	Coupe Engine C20XE	•		GHA433019	
	1990.06-1994.02	Coupe Engine C20XE	•		GWB0736	
	1990.06-1994.02	Coupe Engine C20XE		◦	GWB1326	
2.0 i 16V 4x4 (100 kW)	1994.02-1997.07	Coupe Engine X20XEV	•		GHA433007	
	1994.02-1997.07	Coupe Engine X20XEV	•		GHA433019	
	1994.02-1997.07	Coupe Engine X20XEV	•		GWB0736	
	1994.02-1997.07	Coupe Engine X20XEV	•		GWB3410	
2.0 i 16V 4x4 (110 kW)	1990.06-1994.02	Coupe Engine C20XE	•		GHA433007	
	1990.06-1994.02	Coupe Engine C20XE	•		GHA433019	
	1990.06-1994.02	Coupe Engine C20XE	•		GWB0736	
	1990.06-1994.02	Coupe Engine C20XE		◦	GWB1326	
2.0 i 4x4 (85 kW)	1990.06-1997.07	Coupe Engine C20NE	•		GHA433007	
	1990.06-1997.07	Coupe Engine C20NE	•		GHA433019	
	1990.06-1997.07	Coupe Engine C20NE	•		GWB0736	
	1990.06-1997.07	Coupe Engine C20NE	•		GWB3410	
2.0 i Turbo 4x4 (150 kW)	1992.03-1997.07	Coupe Engine C20LET	•		GHA433004	
	1992.03-1997.07	Coupe Engine C20LET	•		GWB0736	
	1992.03-1997.07	Coupe Engine C20LET	•		GWB3410	
	1992.03-1997.07	Coupe Engine C20LET		◦	GWB1326	
2.5 i V6 (125 kW)	1993.04-1997.07	Coupe Engine C25XE/X25XE	•		GHA433004	
	1993.04-1997.07	Coupe Engine C25XE/X25XE	•		GWB3410	
	1993.04-1997.07	Coupe Engine C25XE/X25XE		◦	GWB1326	
CASCADA (W13)						
1.4 (88 kW)	2013.03-	Convertible Engine A14NEL	•		GHA330019	K
1.4 Turbo (103 kW)	2013.03-	Convertible Engine A14NET	•		GHA330019	K
1.6 SiDi (125 kW)	2013.03-	Convertible Engine A 16 XHT	•		GHA330019	K
2.0 CDTi (121 kW)	2013.03-	Convertible Engine A20DTH	•		GHA330019	K
2.0 CDTi (143 kW)	2013.03-	Convertible Engine A20DTR	•		GHA330019	K
COMBO						
1.3 CDTi 16V (51 kW)	2005.08-	Box Body / Estate Engine Z13DT	•		GHA422014	
	2005.08-	Box Body / Estate Engine Z13DT With ABS		◦	GHA400064	K
	2005.08-	Box Body / Estate Engine Z13DT Without ABS		◦	GHA400058	K
1.3 CDTi 16V (55 kW)	2005.10-	Box Body / Estate Engine Z13DTJ	•		GHA422014	
	2005.10-	Box Body / Estate Engine Z13DTJ With ABS		◦	GHA400064	K
	2005.10-	Box Body / Estate Engine Z13DTJ Without ABS		◦	GHA400058	K
1.4 16V (66 kW)	2005.08-	Box Body / Estate Engine Z14XEP	•		GHA422014	
	2005.08-	Box Body / Estate Engine Z14XEP With ABS		◦	GHA400064	K
	2005.08-	Box Body / Estate Engine Z14XEP Without ABS		◦	GHA400058	K
1.6 (64 kW)	2001.10-	Box Body / Estate Engine Z16SE	•		GHA422014	
	2001.10-	Box Body / Estate Engine Z16SE With ABS		◦	GHA400064	K
	2001.10-	Box Body / Estate Engine Z16SE Without ABS		◦	GHA400058	K
1.6 CNG 16V (69 kW)	2006.06-	Box Body / Estate Engine Z16YNG	•		GHA422014	
	2006.06-	Box Body / Estate Engine Z16YNG With ABS		◦	GHA400064	K
	2006.06-	Box Body / Estate Engine Z16YNG Without ABS		◦	GHA400058	K
1.6 CNG 16V (71 kW)	2005.04-	Box Body / Estate Engine Z16YNG	•		GHA422014	
	2005.04-	Box Body / Estate Engine Z16YNG With ABS		◦	GHA400064	K
	2005.04-	Box Body / Estate Engine Z16YNG Without ABS		◦	GHA400058	K
1.7 CDTi 16V (74 kW)	2004.12-	Box Body / Estate Engine Z17DTH	•		GWB0736	



	 YEAR		F	R	G-AP Ref.	KIT
OPEL						
COMBO						
1.7 CDTi 16V (74 kW)	2004.12-	Box Body / Estate Engine Z17DTH With ABS		o	GHA400052	K
	2004.12-	Box Body / Estate Engine Z17DTH With ABS		o	GHA400064	K
	2004.12-	Box Body / Estate Engine Z17DTH Without ABS		o	GHA400058	K
1.7 Di 16V (48 kW)	2001.10-	Box Body / Estate Engine Y17DTL	•		GHA422014	
	2001.10-	Box Body / Estate Engine Y17DTL With ABS		o	GHA400064	K
	2001.10-	Box Body / Estate Engine Y17DTL Without ABS		o	GHA400058	K
1.7 DTi 16V (55 kW)	2001.10-	Box Body / Estate Engine Y17DT	•		GHA422014	
	2001.10-	Box Body / Estate Engine Y17DT With ABS		o	GHA400064	K
	2001.10-	Box Body / Estate Engine Y17DT Without ABS		o	GHA400058	K
COMBO (71_)						
1.2 (33 kW)	1994.07-2001.10	Box Engine C12NZ/X12SZ	•		GWB3403	
	1994.07-2001.10	Box Engine C12NZ/X12SZ		o	GWB0526	
1.4 (44 kW)	1994.07-2001.10	Box Engine C14NZ/X14SZ	•		GWB3403	
	1994.07-2001.10	Box Engine C14NZ/X14SZ		o	GWB0526	
1.4 (60 kW)	1994.07-2001.10	Box Engine C14SE	•		GWB3403	
	1994.07-2001.10	Box Engine C14SE		o	GWB0526	
1.4 16V (66 kW)	1999.08-2001.10	Box Engine X14XE	•		GWB3403	
	1999.08-2001.10	Box Engine X14XE		o	GWB0526	
1.7 D (44 kW)	1994.07-2001.10	Box Engine 17D(4EE1)/X17D(4EE1)	•		GWB3403	
	1994.07-2001.10	Box Engine 17D(4EE1)/X17D(4EE1)		o	GWB0526	
COMBO (X12)						
1.3 CDTi (66 kW)	2012.02-	Box Body / Estate Engine A13FD	•		GWB3598	
	2012.02-	Box Body / Estate Engine A13FD		o	GHA230086	K
	2012.02-	Box Body / Estate Engine A13FD With ABS		o	GHA230128	
	2012.02-	Box Body / Estate Engine A13FD Without ABS		o	GHA230127	
1.4 (70 kW)	2012.02-	Box Body / Estate Engine A14FP	•		GWB3598	
	2012.02-	Box Body / Estate Engine A14FP		o	GHA230086	K
	2012.02-	Box Body / Estate Engine A14FP With ABS		o	GHA230128	
	2012.02-	Box Body / Estate Engine A14FP Without ABS		o	GHA230127	
1.4 (88 kW)	2012.02-	Box Body / Estate Engine A14FC	•		GWB3599	
	2012.02-	Box Body / Estate Engine A14FC With ABS		o	GHA230128	
	2012.02-	Box Body / Estate Engine A14FC Without ABS		o	GHA230127	
1.4 CNG (88 kW)	2012.02-	Box Body / Estate Engine A14FC	•		GWB3599	
	2012.02-	Box Body / Estate Engine A14FC With ABS		o	GHA230128	
1.6 CDTi (66 kW)	2012.02-	Box Body / Estate Engine A16FDL	•		GWB3598	
	2012.02-	Box Body / Estate Engine A16FDL	•		GWB3599	
	2012.02-	Box Body / Estate Engine A16FDL	•		GWB6774	
	2012.02-	Box Body / Estate Engine A16FDL		o	GHA230086	K
	2012.02-	Box Body / Estate Engine A16FDL With ABS		o	GHA230128	
	2012.02-	Box Body / Estate Engine A16FDL Without ABS		o	GHA230127	
1.6 CDTi (74 kW)	2012.02-	Box Body / Estate Engine A16FDH	•		GWB3598	
	2012.02-	Box Body / Estate Engine A16FDH	•		GWB3599	
	2012.02-	Box Body / Estate Engine A16FDH	•		GWB6774	
	2012.02-	Box Body / Estate Engine A16FDH		o	GHA230086	K
	2012.02-	Box Body / Estate Engine A16FDH With ABS		o	GHA230128	
1.6 CDTi (77 kW)	2012.02-	Box Body / Estate Engine A16FDH	•		GWB3598	
	2012.02-	Box Body / Estate Engine A16FDH	•		GWB3599	
	2012.02-	Box Body / Estate Engine A16FDH	•		GWB6774	
	2012.02-	Box Body / Estate Engine A16FDH		o	GHA230086	K
	2012.02-	Box Body / Estate Engine A16FDH With ABS		o	GHA230128	
	2012.02-	Box Body / Estate Engine A16FDH Without ABS		o	GHA230127	
2.0 CDTi (99 kW)	2012.02-	Box Body / Estate Engine A20FD	•		GWB3599	
	2012.02-	Box Body / Estate Engine A20FD	•		GWB6774	
	2012.02-	Box Body / Estate Engine A20FD		o	GHA230086	K
	2012.02-	Box Body / Estate Engine A20FD With ABS		o	GHA230128	
	2012.02-	Box Body / Estate Engine A20FD Without ABS		o	GHA230127	
COMBO TOUR						
1.3 CDTi 16V (51 kW)	2004.10-	MPV Engine Y13DT/Z13DT	•		GHA422014	
	2004.10-	MPV Engine Y13DT/Z13DT With ABS		o	GHA400064	K
	2004.10-	MPV Engine Y13DT/Z13DT Without ABS		o	GHA400058	K
1.3 CDTi 16V (55 kW)	2005.10-	MPV Engine Z13DTJ	•		GHA422014	
	2005.10-	MPV Engine Z13DTJ With ABS		o	GHA400064	K
	2005.10-	MPV Engine Z13DTJ Without ABS		o	GHA400058	K
1.4 (66 kW)	2004.10-	MPV Engine Z14XEP With ABS		o	GHA400064	K



	 YEAR		F	R	G-AP Ref.	KIT
OPEL						
COMBO TOUR						
1.4 (66 kW)	2004.10-	MPV Engine Z14XEP Without ABS		o	GHA400058	K
1.6 (64 kW)	2001.10-	MPV Engine Z16SE	•		GHA422014	
	2001.10-	MPV Engine Z16SE With ABS		o	GHA400064	K
	2001.10-	MPV Engine Z16SE Without ABS		o	GHA400058	K
1.6 CNG (69 kW)	2006.06-	MPV Engine Z16YNG	•		GHA422014	
	2006.06-	MPV Engine Z16YNG With ABS		o	GHA400064	K
	2006.06-	MPV Engine Z16YNG Without ABS		o	GHA400058	K
1.6 CNG (71 kW)	2005.04-	MPV Engine Z16YNG	•		GHA422014	
	2005.04-	MPV Engine Z16YNG With ABS		o	GHA400064	K
	2005.04-	MPV Engine Z16YNG Without ABS		o	GHA400058	K
1.7 CDTi 16V (74 kW)	2004.12-	MPV Engine Z17DTH	•		GWB0736	
	2004.12-	MPV Engine Z17DTH With ABS		o	GHA400052	K
	2004.12-	MPV Engine Z17DTH With ABS		o	GHA400064	K
	2004.12-	MPV Engine Z17DTH Without ABS		o	GHA400058	K
1.7 Di 16V (48 kW)	2001.10-	MPV Engine Y17DTL	•		GHA422014	
	2001.10-	MPV Engine Y17DTL With ABS		o	GHA400064	K
	2001.10-	MPV Engine Y17DTL Without ABS		o	GHA400058	K
1.7 DTi 16V (55 kW)	2001.10-	MPV Engine Y17DT	•		GHA422014	
	2001.10-	MPV Engine Y17DT With ABS		o	GHA400064	K
	2001.10-	MPV Engine Y17DT Without ABS		o	GHA400058	K
COMBO TOUR (X12)						
1.3 CDTi (66 kW)	2012.02-	MPV Engine A13FD	•		GWB3598	
	2012.02-	MPV Engine A13FD		o	GHA230086	K
	2012.02-	MPV Engine A13FD With ABS		o	GHA230128	
1.4 (70 kW)	2012.02-	MPV Engine A14FP	•		GWB3598	
	2012.02-	MPV Engine A14FP		o	GHA230086	K
	2012.02-	MPV Engine A14FP With ABS		o	GHA230128	
1.4 (88 kW)	2012.02-	MPV Engine A14FC	•		GWB3599	
	2012.02-	MPV Engine A14FC		o	GHA230086	K
	2012.02-	MPV Engine A14FC With ABS		o	GHA230128	
1.4 CNG (88 kW)	2012.02-	MPV Engine A14FC	•		GWB3599	
1.6 CDTi (66 kW)	2012.02-	MPV Engine A16FDL	•		GWB3598	
	2012.02-	MPV Engine A16FDL	•		GWB3599	
	2012.02-	MPV Engine A16FDL	•		GWB6774	
	2012.02-	MPV Engine A16FDL		o	GHA230086	K
	2012.02-	MPV Engine A16FDL With ABS		o	GHA230128	
1.6 CDTi (74 kW)	2012.02-	MPV Engine A16FDH	•		GWB3598	
	2012.02-	MPV Engine A16FDH	•		GWB3599	
	2012.02-	MPV Engine A16FDH	•		GWB6774	
	2012.02-	MPV Engine A16FDH		o	GHA230086	K
	2012.02-	MPV Engine A16FDH With ABS		o	GHA230128	
1.6 CDTi (77 kW)	2012.02-	MPV Engine A16FDH	•		GWB3598	
	2012.02-	MPV Engine A16FDH	•		GWB3599	
	2012.02-	MPV Engine A16FDH	•		GWB6774	
	2012.02-	MPV Engine A16FDH		o	GHA230086	K
	2012.02-	MPV Engine A16FDH With ABS		o	GHA230128	
2.0 CDTi (99 kW)	2012.02-	MPV Engine A20FD	•		GWB3599	
	2012.02-	MPV Engine A20FD	•		GWB6774	
	2012.02-	MPV Engine A20FD		o	GHA230086	K
	2012.02-	MPV Engine A20FD With ABS		o	GHA230128	
CORSA A (93_, 94_, 98_, 99_)						
1.2 N (38 kW)	1990.01-1993.03	Hatchback Engine 12NV	•		GHA422006	K
	1990.01-1993.03	Hatchback Engine 12NV	•		GWB3256	
	1990.01-1993.03	Hatchback Engine 12NV	•		GWB3403	
	1990.01-1993.03	Hatchback Engine 12NV		o	GHA499004	
	1990.01-1993.03	Hatchback Engine 12NV		o	GWB0944	
	1990.01-1993.03	Hatchback Engine 12NV			GWB0663	
1.4 i (44 kW)	1990.01-1993.03	Hatchback Engine C14NZ	•		GHA422006	K
	1990.01-1993.03	Hatchback Engine C14NZ	•		GWB3256	
	1990.01-1993.03	Hatchback Engine C14NZ	•		GWB3403	
	1990.01-1993.03	Hatchback Engine C14NZ		o	GHA499004	
	1990.01-1993.03	Hatchback Engine C14NZ		o	GWB0944	
	1990.01-1993.03	Hatchback Engine C14NZ			GWB0663	
1.4 S (53 kW)	1990.01-1993.03	Hatchback Engine 14NV	•		GHA422006	K



	 YEAR		F	R	G-AP Ref.	KIT	
OPEL							
CORSA A (93_, 94_, 98_, 99_)							
1.4 S (53 kW)	1990.01-1993.03	Hatchback Engine 14NV	•		GWB3256		
	1990.01-1993.03	Hatchback Engine 14NV	•		GWB3403		
	1990.01-1993.03	Hatchback Engine 14NV		◦	GHA499004		
	1990.01-1993.03	Hatchback Engine 14NV		◦	GWB0944		
	1990.01-1993.03	Hatchback Engine 14NV			GWB0663		
1.4 Si (60 kW)	1991.09-1993.03	Hatchback Engine C14SE	•		GHA422006	K	
	1991.09-1993.03	Hatchback Engine C14SE	•		GWB3256		
	1991.09-1993.03	Hatchback Engine C14SE	•		GWB3403		
	1991.09-1993.03	Hatchback Engine C14SE		◦	GHA499004		
	1991.09-1993.03	Hatchback Engine C14SE		◦	GWB0944		
1.6 GSi CAT (74 kW)	1991.09-1993.03	Hatchback Engine C14SE		◦	GWB0663		
	1992.02-1993.03	Hatchback Engine C16SE	•		GHA422006	K	
	1992.02-1993.03	Hatchback Engine C16SE	•		GWB3256		
	1992.02-1993.03	Hatchback Engine C16SE	•		GWB3403		
	1992.02-1993.03	Hatchback Engine C16SE		◦	GHA499004		
1.6 GSi CAT (74 kW)	1992.02-1993.03	Hatchback Engine C16SE		◦	GWB0944		
	1992.02-1993.03	Hatchback Engine C16SE			GWB0663		
	CORSA B (73_)						
	1.4 i (44 kW)	1999.08-2000.09	Box Engine X14SZ	•		GWB3403	
		1999.08-2000.09	Box Engine X14SZ		◦	GHA499004	
1999.08-2000.09		Box Engine X14SZ		◦	GWB0944		
1.7 D (44 kW)	1999.08-2000.09	Box Engine 17D(4EE1)/X17D(4EE1)	•		GWB3403		
	1999.08-2000.09	Box Engine 17D(4EE1)/X17D(4EE1)		◦	GHA499004		
	1999.08-2000.09	Box Engine 17D(4EE1)/X17D(4EE1)		◦	GWB0944		
CORSA B (73_, 78_, 79_)							
1.0 i 12V (40 kW)	1996.11-2000.09	Hatchback Engine X10XE	•		GHA422006	K	
	1996.11-2000.09	Hatchback Engine X10XE	•		GWB3403		
	1996.11-2000.09	Hatchback Engine X10XE		◦	GHA499004		
	1996.11-2000.09	Hatchback Engine X10XE		◦	GWB0944		
1.2 i (33 kW)	1993.03-2000.09	Hatchback Engine 12NZ	•		GHA422006	K	
	1993.03-2000.09	Hatchback Engine 12NZ	•		GWB3403		
	1993.03-2000.09	Hatchback Engine 12NZ		◦	GHA499004		
	1993.03-2000.09	Hatchback Engine 12NZ		◦	GWB0944		
	1993.03-2000.09	Hatchback Engine C12NZ/X12SZ	•		GHA422006	K	
	1993.03-2000.09	Hatchback Engine C12NZ/X12SZ	•		GWB3403		
	1993.03-2000.09	Hatchback Engine C12NZ/X12SZ		◦	GHA499004		
	1993.03-2000.09	Hatchback Engine C12NZ/X12SZ		◦	GWB0944		
1.2 i 16V (48 kW)	1998.03-2000.09	Hatchback Engine X12XE	•		GHA422006	K	
	1998.03-2000.09	Hatchback Engine X12XE	•		GWB3403		
	1998.03-2000.09	Hatchback Engine X12XE		◦	GHA499004		
	1998.03-2000.09	Hatchback Engine X12XE		◦	GWB0944		
1.4 (54 kW)	1993.04-1994.08	Hatchback Engine C 14 SE	•		GHA422006	K	
	1993.04-1994.08	Hatchback Engine C 14 SE	•		GWB3403		
	1993.04-1994.08	Hatchback Engine C 14 SE		◦	GWB0944		
1.4 i (40 kW)	1993.03-2000.09	Hatchback Engine C 14 NZ/X 14 SZ	•		GWB3403		
	1993.03-2000.09	Hatchback Engine C 14 NZ/X 14 SZ		◦	GWB0944		
1.4 i (44 kW)	1993.03-2000.09	Hatchback Engine C14NZ/X14SZ	•		GHA422006	K	
	1993.03-2000.09	Hatchback Engine C14NZ/X14SZ	•		GWB3403		
	1993.03-2000.09	Hatchback Engine C14NZ/X14SZ		◦	GHA499004		
	1993.03-2000.09	Hatchback Engine C14NZ/X14SZ		◦	GWB0944		
1.4 i 16V (63 kW)	1997.08-2000.09	Hatchback Engine C14SEL	•		GWB3403		
	1997.08-2000.09	Hatchback Engine C14SEL		◦	GWB0944		
1.4 i 16V (66 kW)	1994.09-2000.09	Hatchback Engine X14XE	•		GHA422006	K	
	1994.09-2000.09	Hatchback Engine X14XE	•		GWB3403		
	1994.09-2000.09	Hatchback Engine X14XE		◦	GHA499004		
	1994.09-2000.09	Hatchback Engine X14XE		◦	GWB0944		
1.4 i 16V (67 kW)	1994.09-2000.09	Hatchback Engine X14XE	•		GWB3403		
	1994.09-2000.09	Hatchback Engine X14XE		◦	GHA499004		
	1994.09-2000.09	Hatchback Engine X14XE		◦	GWB0944		
1.4 Si (60 kW)	1993.03-2000.09	Hatchback Engine C14SE	•		GHA422006	K	
	1993.03-2000.09	Hatchback Engine C14SE	•		GWB3403		
	1993.03-2000.09	Hatchback Engine C14SE		◦	GHA499004		
	1993.03-2000.09	Hatchback Engine C14SE		◦	GWB0944		
1.5 D (37 kW)	1993.03-2000.09	Hatchback Engine 15D(4EC1)	•		GHA422006	K	



	 YEAR		F	R	G-AP Ref.	KIT
OPEL						
CORSA B (73_, 78_, 79_)						
1.5 D (37 kW)	1993.03-2000.09	Hatchback Engine 15D(4EC1)	•		GWB3403	
	1993.03-2000.09	Hatchback Engine 15D(4EC1)		◦	GHA499004	
	1993.03-2000.09	Hatchback Engine 15D(4EC1)		◦	GWB0944	
1.5 TD (49 kW)	1993.03-2000.09	Hatchback Engine 15DT(T4EC1)/X15DT(T4EC1)	•		GHA422006	K
	1993.03-2000.09	Hatchback Engine 15DT(T4EC1)/X15DT(T4EC1)	•		GWB3403	
	1993.03-2000.09	Hatchback Engine 15DT(T4EC1)/X15DT(T4EC1)		◦	GHA499004	
	1993.03-2000.09	Hatchback Engine 15DT(T4EC1)/X15DT(T4EC1)		◦	GWB0944	
1.6 GSi 16V (80 kW)	1993.03-2000.09	Hatchback Engine C16XE	•		GHA422006	K
	1993.03-2000.09	Hatchback Engine C16XE	•		GWB3403	
	1993.03-2000.09	Hatchback Engine C16XE		◦	GHA499004	
	1993.03-2000.09	Hatchback Engine C16XE		◦	GWB0944	
1.6 i 16V (74 kW)	1997.08-2000.09	Hatchback Engine C16SEL	•		GHA422006	K
	1997.08-2000.09	Hatchback Engine C16SEL	•		GWB3403	
	1997.08-2000.09	Hatchback Engine C16SEL		◦	GWB0944	
1.6 i 16V (78 kW)	1994.09-2000.09	Hatchback Engine X16XE	•		GHA422006	K
	1994.09-2000.09	Hatchback Engine X16XE	•		GWB3403	
	1994.09-2000.09	Hatchback Engine X16XE		◦	GHA499004	
	1994.09-2000.09	Hatchback Engine X16XE		◦	GWB0944	
1.7 D (44 kW)	1996.02-2000.09	Hatchback Engine 17D(4EE1)/X17D(4EE1)	•		GHA422006	K
	1996.02-2000.09	Hatchback Engine 17D(4EE1)/X17D(4EE1)	•		GWB3403	
	1996.02-2000.09	Hatchback Engine 17D(4EE1)/X17D(4EE1)		◦	GHA499004	
	1996.02-2000.09	Hatchback Engine 17D(4EE1)/X17D(4EE1)		◦	GWB0944	
CORSA B (F35)						
1.4 i 16V (66 kW)	1999.01-	Estate Engine X14XE	•		GWB3403	
	1999.01-	Estate Engine X14XE		◦	GWB0944	
1.7 D (44 kW)	1999.01-	Estate Engine X 17 D (4EE1)	•		GWB3403	
	1999.01-	Estate Engine X 17 D (4EE1)		◦	GWB0944	
CORSA C (F08, F68)						
1.0 (43 kW)	2000.09-2009.12	Hatchback Engine Z10XE	•		GHA422014	
	2000.09-2009.12	Hatchback Engine Z10XE		◦	GHA227023	K
	2000.09-2009.12	Hatchback Engine Z10XE		◦	GWB3601	
1.0 (44 kW)	2003.06-2009.12	Hatchback Engine Z10XEP	•		GHA422014	
	2003.06-2009.12	Hatchback Engine Z10XEP		◦	GHA227023	K
	2003.06-2009.12	Hatchback Engine Z10XEP		◦	GWB3601	
1.2 (55 kW)	2000.09-2009.12	Hatchback Engine Z12XE	•		GHA422014	
	2000.09-2009.12	Hatchback Engine Z12XE		◦	GHA227023	K
	2000.09-2009.12	Hatchback Engine Z12XE		◦	GWB3601	
1.2 Twinport (59 kW)	2004.07-2009.12	Hatchback Engine Z12XEP	•		GHA422014	
	2004.07-2009.12	Hatchback Engine Z12XEP		◦	GHA227023	K
	2004.07-2009.12	Hatchback Engine Z12XEP		◦	GWB3601	
1.3 CDTi (51 kW)	2003.08-2007.01	Hatchback Engine Z13DT	•		GHA422014	
	2003.08-2007.01	Hatchback Engine Z13DT		◦	GHA227023	K
	2003.08-2007.01	Hatchback Engine Z13DT		◦	GWB3601	
1.4 (66 kW)	2000.09-2009.12	Hatchback Engine Z14XE	•		GHA422014	
	2000.09-2009.12	Hatchback Engine Z14XE		◦	GHA227023	K
	2000.09-2009.12	Hatchback Engine Z14XE		◦	GWB3601	
1.4 Twinport (66 kW)	2003.06-2009.12	Hatchback Engine Z14XEP	•		GHA422014	
	2003.06-2009.12	Hatchback Engine Z14XEP		◦	GHA227023	K
	2003.06-2009.12	Hatchback Engine Z14XEP		◦	GWB3601	
1.7 CDTi (74 kW)	2003.08-2004.12	Hatchback Engine Z17DTH	•		GWB0736	
	2003.08-2004.12	Hatchback Engine Z17DTH		◦	GHA227023	K
	2003.08-2004.12	Hatchback Engine Z17DTH		◦	GWB3601	
1.7 Di (48 kW)	2000.09-2009.12	Hatchback Engine Y17DTL	•		GHA422014	
	2000.09-2009.12	Hatchback Engine Y17DTL		◦	GHA227023	K
	2000.09-2009.12	Hatchback Engine Y17DTL		◦	GWB3601	
1.7 DTi (55 kW)	2000.09-2009.12	Hatchback Engine Y17DT	•		GHA422014	
	2000.09-2009.12	Hatchback Engine Y17DT		◦	GHA227023	K
	2000.09-2009.12	Hatchback Engine Y17DT		◦	GWB3601	
1.8 (92 kW)	2000.09-2009.12	Hatchback Engine Z18XE	•		GHA422014	
	2000.09-2009.12	Hatchback Engine Z18XE		◦	GHA227023	K
	2000.09-2009.12	Hatchback Engine Z18XE		◦	GWB3601	
CORSA C (F08, W5L)						
1.2 (59 kW)	2005.07-	Box Engine Z12XEP	•		GHA422014	
	2005.07-	Box Engine Z12XEP		◦	GHA227023	K



	 YEAR		F	R	G-AP Ref.	KIT
OPEL						
CORSA C (F08, W5L)						
1.2 (59 kW)	2005.07-	Box Engine Z12XEP		o	GWB3601	
1.2 16V (55 kW)	2000.09-	Box Engine Z12XE	•		GHA422014	
	2000.09-	Box Engine Z12XE		o	GHA227023	K
	2000.09-	Box Engine Z12XE		o	GWB3601	
1.3 CDTi 16V (51 kW)	2005.08-	Box Engine Z13DT	•		GHA422014	
	2005.08-	Box Engine Z13DT		o	GHA227023	K
	2005.08-	Box Engine Z13DT		o	GWB3601	
1.4 (66 kW)	2003.08-	Box Engine Z14XEP	•		GHA422014	
	2003.08-	Box Engine Z14XEP		o	GHA227023	K
	2003.08-	Box Engine Z14XEP		o	GWB3601	
1.7 CDTi (74 kW)	2003.08-	Box Engine Z17DTH	•		GWB0736	
	2003.08-	Box Engine Z17DTH		o	GHA227023	K
	2003.08-	Box Engine Z17DTH		o	GWB3601	
1.7 Di 16V (48 kW)	2000.09-	Box Engine Y17DTL		o	GHA227023	K
	2000.09-	Box Engine Y17DTL		o	GWB3601	
1.7 DTi 16V (55 kW)	2000.09-	Box Engine Y17DT	•		GHA422014	
	2000.09-	Box Engine Y17DT		o	GHA227023	K
	2000.09-	Box Engine Y17DT		o	GWB3601	
CORSA D						
1.0 (44 kW)	2006.07-2008.03	Hatchback Engine Z10XEP	•		GWB6550	
	2006.07-2008.03	Hatchback Engine Z10XEP		o	GHA230092	S
	2006.07-2008.03	Hatchback Engine Z10XEP		o	GHA230098	K
1.0 (48 kW)	2010.01-	Hatchback Engine A10XEP	•		GWB6550	
	2010.01-	Hatchback Engine A10XEP		o	GHA230092	S
	2010.01-	Hatchback Engine A10XEP		o	GHA230098	K
1.2 (51 kW)	2010.06-	Hatchback Engine A12XEL	•		GWB6550	
	2010.06-	Hatchback Engine A12XEL		o	GHA230092	S
	2010.06-	Hatchback Engine A12XEL		o	GHA230098	K
1.2 (59 kW)	2006.07-2008.03	Hatchback Engine Z12XEP	•		GWB6550	
	2006.07-2008.03	Hatchback Engine Z12XEP		o	GHA230092	S
	2006.07-2008.03	Hatchback Engine Z12XEP		o	GHA230098	K
1.2 (63 kW)	2010.06-	Hatchback Engine A12XER	•		GWB6550	
	2010.06-	Hatchback Engine A12XER		o	GHA230092	S
	2010.06-	Hatchback Engine A12XER		o	GHA230098	K
1.2 LPG (59 kW)	2009.09-	Hatchback Engine Z12XEP	•		GWB6550	
	2009.09-	Hatchback Engine Z12XEP		o	GHA230092	S
	2009.09-	Hatchback Engine Z12XEP		o	GWB3539	
	2009.09-	Hatchback Engine Z12XEP		o	GWB6540	
1.2 LPG (61 kW)	2011.06-	Hatchback Engine A12XER	•		GWB6550	
	2011.06-	Hatchback Engine A12XER		o	GHA230092	S
	2011.06-	Hatchback Engine A12XER		o	GHA230098	K
1.2 LPG (63 kW)	2011.08-	Hatchback Engine A12XER	•		GWB6550	
	2011.08-	Hatchback Engine A12XER		o	GHA230092	S
	2011.08-	Hatchback Engine A12XER		o	GHA230098	K
1.3 CDTi (55 kW)	2006.07-2007.04	Hatchback Engine A13DTC/Z13DTJ	•		GWB3539	
	2006.07-2007.04	Hatchback Engine A13DTC/Z13DTJ	•		GWB6540	
	2006.07-2007.04	Hatchback Engine A13DTC/Z13DTJ		o	GHA230092	S
	2006.07-2007.04	Hatchback Engine A13DTC/Z13DTJ		o	GHA230098	K
1.3 CDTi (66 kW)	2006.07-2008.03	Hatchback Engine Z13DTH	•		GWB3539	
	2006.07-2008.03	Hatchback Engine Z13DTH	•		GWB6540	
	2006.07-2008.03	Hatchback Engine Z13DTH		o	GHA230092	S
	2006.07-2008.03	Hatchback Engine Z13DTH		o	GHA230098	K
1.3 CDTi (70 kW)	2010.06-	Hatchback Engine A13DTR/A13DTE/Z13DTE	•		GWB3539	
	2010.06-	Hatchback Engine A13DTR/A13DTE/Z13DTE	•		GWB6540	
	2010.06-	Hatchback Engine A13DTR/A13DTE/Z13DTE		o	GHA230092	S
	2010.06-	Hatchback Engine A13DTR/A13DTE/Z13DTE		o	GHA230098	K
1.4 (64 kW)	2009.09-	Hatchback Engine A14XEL	•		GWB6550	
	2009.09-	Hatchback Engine A14XEL		o	GHA230092	S
	2009.09-	Hatchback Engine A14XEL		o	GHA230098	K
1.4 (66 kW)	2006.07-	Hatchback Engine Z14XEP	•		GWB6550	
	2006.07-	Hatchback Engine Z14XEP		o	GHA230092	S
	2006.07-	Hatchback Engine Z14XEP		o	GHA230098	K
1.4 (74 kW)	2010.06-	Hatchback Engine A14XER	•		GWB6550	
	2010.06-	Hatchback Engine A14XER		o	GHA230092	S



	 YEAR		F	R	G-AP Ref.	KIT
OPEL						
CORSA D						
1.4 (74 kW)	2010.06-	Hatchback Engine A14XER		o	GHA230098	K
1.4 (88 kW)	2012.07-	Hatchback Engine A14NEL	•		GWB3539	
	2012.07-	Hatchback Engine A14NEL	•		GWB6540	
	2012.07-	Hatchback Engine A14NEL		o	GHA230092	S
	2012.07-	Hatchback Engine A14NEL		o	GHA230098	K
	2012.07-	Hatchback Engine A14NEL		o	GHA230098	K
1.4 LPG (64 kW)	2009.09-	Hatchback Engine A14XEL	•		GWB6550	
	2009.09-	Hatchback Engine A14XEL		o	GHA230092	S
	2009.09-	Hatchback Engine A14XEL		o	GHA230098	K
1.4 LPG (66 kW)	2006.07-2008.03	Hatchback Engine Z14XEP	•		GWB6550	
	2006.07-2008.03	Hatchback Engine Z14XEP		o	GHA230092	S
	2006.07-2008.03	Hatchback Engine Z14XEP		o	GHA230098	K
1.6 Turbo (110 kW)	2007.02-	Hatchback Engine A16LEL/Z16LEL	•		GWB3539	
	2007.02-	Hatchback Engine A16LEL/Z16LEL	•		GWB6540	
	2007.02-	Hatchback Engine A16LEL/Z16LEL		o	GHA230092	S
	2007.02-	Hatchback Engine A16LEL/Z16LEL		o	GHA230098	K
1.6 Turbo (141 kW)	2007.02-	Hatchback Engine A16LER/Z16LER	•		GWB3539	
	2007.02-	Hatchback Engine A16LER/Z16LER	•		GWB6540	
	2007.02-	Hatchback Engine A16LER/Z16LER		o	GHA230092	S
	2007.02-	Hatchback Engine A16LER/Z16LER		o	GHA230098	K
1.6 Turbo (155 kW)	2011.06-	Hatchback Engine A16LER/Z16LER	•		GWB3539	
	2011.06-	Hatchback Engine A16LER/Z16LER	•		GWB6540	
	2011.06-	Hatchback Engine A16LER/Z16LER		o	GHA230092	S
	2011.06-	Hatchback Engine A16LER/Z16LER		o	GHA230098	K
1.7 CDTi (92 kW)	2006.07-2008.03	Hatchback Engine Z17DTR	•		GWB3539	
	2006.07-2008.03	Hatchback Engine Z17DTR	•		GWB6540	
	2006.07-2008.03	Hatchback Engine Z17DTR		o	GHA230092	S
	2006.07-2008.03	Hatchback Engine Z17DTR		o	GHA230098	K
1.7 CDTi (96 kW)	2010.06-	Hatchback Engine A17DTS	•		GWB3539	
	2010.06-	Hatchback Engine A17DTS	•		GWB6540	
	2010.06-	Hatchback Engine A17DTS		o	GHA230092	S
	2010.06-	Hatchback Engine A17DTS		o	GHA230098	K
CORSA D VAN						
1.0 (44 kW)	2006.07-	Box Engine A10XEP	•		GWB6550	
	2006.07-	Box Engine A10XEP		o	GHA230092	S
	2006.07-	Box Engine A10XEP		o	GHA230098	K
1.0 (48 kW)	2010.01-	Box Engine A10XEP	•		GWB6550	
	2010.01-	Box Engine A10XEP		o	GHA230092	S
	2010.01-	Box Engine A10XEP		o	GHA230098	K
1.2 (51 kW)	2010.06-	Box Engine A12XEL	•		GWB6550	
	2010.06-	Box Engine A12XEL		o	GHA230092	S
	2010.06-	Box Engine A12XEL		o	GHA230098	K
1.2 (59 kW)	2009.07-	Box Engine Z12XEP	•		GHA422014	
	2009.07-	Box Engine Z12XEP	•		GWB6550	
	2009.07-	Box Engine Z12XEP		o	GHA230092	S
	2009.07-	Box Engine Z12XEP		o	GHA230098	K
1.2 (63 kW)	2010.06-	Box Engine A12XER	•		GWB6550	
	2010.06-	Box Engine A12XER		o	GHA230092	S
	2010.06-	Box Engine A12XER		o	GHA230098	K
1.3 CDTi (55 kW)	2006.07-	Box Engine A13DTC/Z13DTJ	•		GWB3539	
	2006.07-	Box Engine A13DTC/Z13DTJ	•		GWB6540	
	2006.07-	Box Engine A13DTC/Z13DTJ		o	GHA230092	S
	2006.07-	Box Engine A13DTC/Z13DTJ		o	GHA230098	K
1.3 CDTi (66 kW)	2006.07-	Box Engine Z13DTH	•		GWB3539	
	2006.07-	Box Engine Z13DTH	•		GWB6540	
	2006.07-	Box Engine Z13DTH		o	GHA230092	S
	2006.07-	Box Engine Z13DTH		o	GHA230098	K
1.3 CDTi (70 kW)	2010.06-	Box Engine A13DTR/Z13DTE	•		GWB3539	
	2010.06-	Box Engine A13DTR/Z13DTE	•		GWB6540	
	2010.06-	Box Engine A13DTR/Z13DTE		o	GHA230092	S
	2010.06-	Box Engine A13DTR/Z13DTE		o	GHA230098	K
CORSA E						
1.0 (66 kW)	2014.09-	Hatchback Engine B 10 XFL	•		GWB3539	
	2014.09-	Hatchback Engine B 10 XFL	•		GWB6540	
	2014.09-	Hatchback Engine B 10 XFL	•		GWB6550	



	 YEAR		F	R	G-AP Ref.	KIT
OPEL						
CORSA E						
1.0 (85 kW)	2014.09-	Hatchback Engine B 10 XFT	•		GWB3539	
	2014.09-	Hatchback Engine B 10 XFT	•		GWB6540	
	2014.09-	Hatchback Engine B 10 XFT	•		GWB6550	
1.2 (51 kW)	2014.09-	Hatchback Engine B 12 XEL	•		GWB6550	
1.3 CDTi (55 kW)	2014.09-	Hatchback Engine B 13 DTC	•		GWB3539	
	2014.09-	Hatchback Engine B 13 DTC	•		GWB6540	
1.3 CDTi (70 kW)	2014.09-	Hatchback Engine B 13 DTE/B 13 DTR	•		GWB3539	
	2014.09-	Hatchback Engine B 13 DTE/B 13 DTR	•		GWB6540	
1.4 (55 kW)	2014.09-	Hatchback Engine B 14 XEJ	•		GWB3539	
	2014.09-	Hatchback Engine B 14 XEJ	•		GWB6540	
	2014.09-	Hatchback Engine B 14 XEJ	•		GWB6550	
1.4 (66 kW)	2014.09-	Hatchback Engine B 14 XEL	•		GWB6550	
1.4 Turbo (74 kW)	2014.09-	Hatchback Engine B 14 NEJ	•		GWB3539	
	2014.09-	Hatchback Engine B 14 NEJ	•		GWB6540	
CORSA E VAN						
1.2 (51 kW)	2015.01-	Box Engine B 12 XEL	•		GWB6550	
1.3 CDTi (55 kW)	2015.01-	Box Engine B 13 DTC	•		GWB3539	
	2015.01-	Box Engine B 13 DTC	•		GWB6540	
1.3 CDTi (70 kW)	2014.09-	Box Engine B 13 DTE/B 13 DTR	•		GWB3539	
	2014.09-	Box Engine B 13 DTE/B 13 DTR	•		GWB6540	
1.4 (55 kW)	2014.09-	Box Engine B 14 XEJ	•		GWB3539	
	2014.09-	Box Engine B 14 XEJ	•		GWB6540	
	2014.09-	Box Engine B 14 XEJ	•		GWB6550	
1.4 (66 kW)	2014.09-	Box Engine B 14 XEL	•		GWB3539	
	2014.09-	Box Engine B 14 XEL	•		GWB6540	
	2014.09-	Box Engine B 14 XEL	•		GWB6550	
GT						
2.0 (194 kW)	2007.06-	Convertible Engine LNF/Z 20 NHH Without ABS		◦	GHA330028	
INSIGNIA						
1.4 (103 kW)	2011.04-	Hatchback Engine A14NET Without ABS	•		GHA330024	K
	2011.04-	Hatchback Engine A14NET Without ABS		◦	GHA330024	S
	2011.04-	Saloon Engine A14NET Without ABS	•		GHA330024	K
	2011.04-	Saloon Engine A14NET Without ABS		◦	GHA330024	S
1.6 (85 kW)	2008.07-	Hatchback Engine A16XER Without ABS	•		GHA330024	K
	2008.07-	Hatchback Engine A16XER Without ABS		◦	GHA330024	S
	2008.07-	Saloon Engine A16XER Without ABS	•		GHA330024	K
	2008.07-	Saloon Engine A16XER Without ABS		◦	GHA330024	S
1.6 SiDi (125 kW)	2013.03-	Hatchback Engine A16XHT Without ABS	•		GHA330024	K
	2013.03-	Saloon Engine A16XHT Without ABS	•		GHA330024	K
1.6 Turbo (132 kW)	2008.07-	Hatchback Engine A16LET Without ABS	•		GHA330024	K
	2008.07-	Hatchback Engine A16LET Without ABS		◦	GHA330024	S
	2009.01-	Saloon Engine A16LET Without ABS	•		GHA330024	K
	2009.01-	Saloon Engine A16LET Without ABS		◦	GHA330024	S
	2008.07-	Hatchback Engine A18XER Without ABS	•		GHA330024	K
1.8 (103 kW)	2008.07-	Hatchback Engine A18XER Without ABS		◦	GHA330024	S
	2008.07-	Saloon Engine A18XER Without ABS	•		GHA330024	K
	2008.07-	Saloon Engine A18XER Without ABS		◦	GHA330024	S
	2008.07-	Saloon Engine A18XER Without ABS	•		GHA330024	K
2.0 Biturbo CDTi (140 kW)	2008.07-	Hatchback Engine A20DTR Without ABS	•		GHA330024	K
	2008.07-	Hatchback Engine A20DTR Without ABS		◦	GHA330024	S
	2008.07-	Saloon Engine A20DTR Without ABS	•		GHA330024	K
	2008.07-	Saloon Engine A20DTR Without ABS		◦	GHA330024	S
2.0 Biturbo CDTi (143 kW)	2012.01-	Hatchback Engine A20DTR Without ABS	•		GHA330024	K
	2012.01-	Saloon Engine A20DTR Without ABS	•		GHA330024	K
2.0 Biturbo CDTi 4x4 (140 kW)	2008.07-	Saloon Engine A20DTR Without ABS	•		GHA330024	K
	2008.07-	Saloon Engine A20DTR Without ABS		◦	GHA330024	F
	2009.05-	Hatchback Engine A20DTR Without ABS	•		GHA330024	K
	2009.05-	Hatchback Engine A20DTR Without ABS		◦	GHA330024	F
2.0 Biturbo CDTi 4x4 (143 kW)	2012.01-	Hatchback Engine A20DTR Without ABS	•		GHA330024	K
	2012.01-	Hatchback Engine A20DTR Without ABS		◦	GHA330024	F
	2012.01-	Saloon Engine A20DTR Without ABS	•		GHA330024	K
	2012.01-	Saloon Engine A20DTR Without ABS		◦	GHA330024	F
2.0 CDTi (103 kW)	2013.07-	Hatchback Engine A20DTE Without ABS	•		GHA330024	K
	2013.07-	Saloon Engine A20DTE Without ABS	•		GHA330024	K
2.0 CDTi (118 kW)	2008.07-	Hatchback Engine A20DTH Without ABS	•		GHA330024	K



	 YEAR		F	R	G-AP Ref.	KIT
OPEL						
INSIGNIA						
2.0 CDTi (118 kW)	2008.07-	Hatchback Engine A20DTH Without ABS		o	GHA330024	S
	2008.07-	Saloon Engine A20DTH Without ABS	•		GHA330024	K
	2008.07-	Saloon Engine A20DTH Without ABS		o	GHA330024	S
2.0 CDTi (120 kW)	2013.07-	Hatchback Engine A20DTH Without ABS	•		GHA330024	K
	2013.07-	Saloon Engine A20DTH Without ABS	•		GHA330024	K
2.0 CDTi (125 kW)	2014.11-	Hatchback Engine B 20 DTH Without ABS	•		GHA330024	K
2.0 CDTi (81 kW)	2008.07-	Hatchback Engine A20DTC/A20DTL Without ABS	•		GHA330024	K
	2008.07-	Hatchback Engine A20DTC/A20DTL Without ABS		o	GHA330024	S
	2008.07-	Saloon Engine A20DTC/A20DTL Without ABS	•		GHA330024	K
	2008.07-	Saloon Engine A20DTC/A20DTL Without ABS		o	GHA330024	S
2.0 CDTi (88 kW)	2012.03-	Hatchback Engine A20DTE Without ABS	•		GHA330024	K
	2012.03-	Saloon Engine A20DTE Without ABS	•		GHA330024	K
2.0 CDTi (96 kW)	2008.07-	Hatchback Engine A20DT/A20DTJ Without ABS	•		GHA330024	K
	2008.07-	Hatchback Engine A20DT/A20DTJ Without ABS		o	GHA330024	S
	2008.07-	Saloon Engine A20DT/A20DTJ Without ABS	•		GHA330024	K
	2008.07-	Saloon Engine A20DT/A20DTJ Without ABS		o	GHA330024	S
2.0 CDTi 4x4 (118 kW)	2010.06-	Hatchback Engine A20DTH Without ABS	•		GHA330024	K
	2010.06-	Hatchback Engine A20DTH Without ABS		o	GHA330024	F
	2010.06-	Saloon Engine A20DTH Without ABS	•		GHA330024	K
	2010.06-	Saloon Engine A20DTH Without ABS		o	GHA330024	F
2.0 CDTi 4x4 (120 kW)	2013.07-	Saloon Engine A20DTH Without ABS	•		GHA330024	K
	2013.07-	Saloon Engine A20DTH Without ABS	•		GHA330024	K
	2013.07-	Saloon Engine A20DTH Without ABS		o	GHA330024	F
	2013.07-	Saloon Engine A20DTH Without ABS		o	GHA330024	F
2.0 CDTi 4x4 (125 kW)	2014.11-	Hatchback Engine B 20 DTH Without ABS	•		GHA330024	K
	2014.11-	Hatchback Engine B 20 DTH Without ABS		o	GHA330024	F
2.0 E85 Turbo (162 kW)	2010.09-	Hatchback Engine A20NHT Without ABS	•		GHA330024	K
	2010.09-	Hatchback Engine A20NHT Without ABS		o	GHA330024	S
2.0 Turbo (162 kW)	2008.07-	Hatchback Engine A20NHT Without ABS	•		GHA330024	K
	2008.07-	Hatchback Engine A20NHT Without ABS		o	GHA330024	S
	2008.07-	Saloon Engine A20NHT Without ABS	•		GHA330024	K
	2008.07-	Saloon Engine A20NHT Without ABS		o	GHA330024	S
2.0 Turbo (184 kW)	2014.04-	Estate Engine A20NHT Without ABS	•		GHA330024	K
	2014.04-	Estate Engine A20NHT Without ABS		o	GHA330024	S
	2014.04-	Hatchback Engine A20NHT Without ABS	•		GHA330024	K
	2014.04-	Hatchback Engine A20NHT Without ABS		o	GHA330024	S
	2014.04-	Saloon Engine A20NHT Without ABS	•		GHA330024	K
	2014.04-	Saloon Engine A20NHT Without ABS		o	GHA330024	S
2.0 Turbo 4x4 (162 kW)	2008.07-	Hatchback Engine A20NHT Without ABS	•		GHA330024	K
	2008.07-	Hatchback Engine A20NHT Without ABS		o	GHA330024	F
	2008.07-	Saloon Engine A20NHT Without ABS	•		GHA330024	K
	2008.07-	Saloon Engine A20NHT Without ABS		o	GHA330024	F
2.0 Turbo 4x4 (184 kW)	2011.09-	Hatchback Engine A20NFT Without ABS	•		GHA330024	K
	2011.09-	Hatchback Engine A20NFT Without ABS		o	GHA330024	F
	2011.09-	Saloon Engine A20NFT Without ABS	•		GHA330024	K
	2011.09-	Saloon Engine A20NFT Without ABS		o	GHA330024	F
2.0 Turbo E85 (162 kW)	2008.07-	Saloon Engine A20NHT Without ABS	•		GHA330024	K
	2008.07-	Saloon Engine A20NHT Without ABS		o	GHA330024	S
2.8 V6 Turbo 4x4 (191 kW)	2008.07-	Hatchback Engine A28NET Without ABS	•		GHA330024	K
	2008.07-	Hatchback Engine A28NET Without ABS		o	GHA330024	F
	2008.07-	Saloon Engine A28NET Without ABS	•		GHA330024	K
	2008.07-	Saloon Engine A28NET Without ABS		o	GHA330024	F
2.8 V6 Turbo OPC 4x4 (239 kW)	2009.07-	Hatchback Engine A28NER Without ABS	•		GHA330024	K
	2009.07-	Hatchback Engine A28NER Without ABS		o	GHA330024	F
	2009.07-	Saloon Engine A28NER Without ABS	•		GHA330024	K
	2009.07-	Saloon Engine A28NER Without ABS		o	GHA330024	F
INSIGNIA SPORTS TOURER						
1.4 (103 kW)	2011.09-	Estate Engine A14NET Without ABS	•		GHA330024	K
	2011.09-	Estate Engine A14NET Without ABS		o	GHA330024	S
1.6 (85 kW)	2008.07-	Estate Engine A16XER Without ABS	•		GHA330024	K
	2008.07-	Estate Engine A16XER Without ABS		o	GHA330024	S
1.6 SiDi (125 kW)	2013.03-	Estate Engine A16XHT Without ABS	•		GHA330024	K
1.6 Turbo (132 kW)	2009.01-	Estate Engine A16LET Without ABS	•		GHA330024	K
	2009.01-	Estate Engine A16LET Without ABS		o	GHA330024	S



	 YEAR		F	R	G-AP Ref.	KIT
OPEL						
INSIGNIA SPORTS TOURER						
1.8 (103 kW)	2008.07-	Estate Engine A18XER Without ABS	•		GHA330024	K
	2008.07-	Estate Engine A18XER Without ABS		◦	GHA330024	S
2.0 Biturbo CDTi (140 kW)	2008.07-	Estate Engine A20DTR Without ABS	•		GHA330024	K
	2008.07-	Estate Engine A20DTR Without ABS		◦	GHA330024	S
2.0 Biturbo CDTi (143 kW)	2012.01-	Estate Engine A20DTR Without ABS	•		GHA330024	K
2.0 Biturbo CDTi 4x4 (140 kW)	2008.07-	Estate Engine A20DTR Without ABS	•		GHA330024	K
	2008.07-	Estate Engine A20DTR Without ABS		◦	GHA330024	F
2.0 Biturbo CDTi 4x4 (143 kW)	2012.01-	Estate Engine A20DTR Without ABS	•		GHA330024	K
	2012.01-	Estate Engine A20DTR Without ABS		◦	GHA330024	F
2.0 CDTi (103 kW)	2013.07-	Estate Engine A20DTE Without ABS	•		GHA330024	K
2.0 CDTi (118 kW)	2008.07-	Estate Engine A20DTH Without ABS	•		GHA330024	K
	2008.07-	Estate Engine A20DTH Without ABS		◦	GHA330024	S
2.0 CDTi (120 kW)	2013.07-	Estate Engine A20DTH Without ABS	•		GHA330024	K
2.0 CDTi (81 kW)	2008.07-	Estate Engine A20DTC/A20DTL Without ABS	•		GHA330024	K
	2008.07-	Estate Engine A20DTC/A20DTL Without ABS		◦	GHA330024	S
2.0 CDTi (88 kW)	2012.03-	Estate Engine A20DTE Without ABS	•		GHA330024	K
2.0 CDTi (96 kW)	2008.07-	Estate Engine A20DT/A20DTJ Without ABS	•		GHA330024	K
	2008.07-	Estate Engine A20DT/A20DTJ Without ABS		◦	GHA330024	S
2.0 CDTi 4x4 (118 kW)	2010.06-	Estate Engine A20DTH Without ABS	•		GHA330024	K
	2010.06-	Estate Engine A20DTH Without ABS		◦	GHA330024	F
2.0 CDTi 4x4 (120 kW)	2013.07-	Saloon Engine K24B Without ABS	•		GHA330024	K
	2013.07-	Saloon Engine K24B Without ABS		◦	GHA330024	F
2.0 E85 Turbo (162 kW)	2010.09-	Estate Engine A20NHT Without ABS	•		GHA330024	K
	2010.09-	Estate Engine A20NHT Without ABS		◦	GHA330024	S
2.0 Turbo (162 kW)	2008.07-	Estate Engine A20NHT Without ABS	•		GHA330024	K
	2008.07-	Estate Engine A20NHT Without ABS		◦	GHA330024	S
2.0 Turbo 4x4 (162 kW)	2008.07-	Estate Engine A20NHT Without ABS	•		GHA330024	K
	2008.07-	Estate Engine A20NHT Without ABS		◦	GHA330024	F
2.0 Turbo 4x4 (184 kW)	2011.09-	Estate Engine A20NFT Without ABS	•		GHA330024	K
	2011.09-	Estate Engine A20NFT Without ABS		◦	GHA330024	F
2.8 V6 Turbo 4x4 (191 kW)	2008.10-	Estate Engine A28NET Without ABS	•		GHA330024	K
	2008.10-	Estate Engine A28NET Without ABS		◦	GHA330024	F
2.8 V6 Turbo OPC 4x4 (239 kW)	2009.07-	Estate Engine A28NER Without ABS	•		GHA330024	K
	2009.07-	Estate Engine A28NER Without ABS		◦	GHA330024	F
KADETT E (33_, 34_, 43_, 44_)						
1.4 i (44 kW)	1990.01-1991.08	Hatchback Engine C14NZ	•		GHA422006	K
	1990.01-1991.08	Hatchback Engine C14NZ	•		GWB3256	
	1990.01-1991.08	Hatchback Engine C14NZ	•		GWB3403	
	1990.01-1991.08	Hatchback Engine C14NZ		◦	GWB0944	
	1990.01-1991.08	Hatchback Engine C14NZ			GWB0663	
1.4 S (55 kW)	1990.01-1991.08	Hatchback Engine 14NV	•		GHA422006	K
	1990.01-1991.08	Hatchback Engine 14NV	•		GWB3256	
	1990.01-1991.08	Hatchback Engine 14NV	•		GWB3403	
	1990.01-1991.08	Hatchback Engine 14NV		◦	GWB0944	
	1990.01-1991.08	Hatchback Engine 14NV			GWB0663	
KADETT E (35_, 36_, 45_, 46_)						
1.4 i (44 kW)	1990.01-1991.08	Estate Engine C14NZ	•		GHA422006	K
	1990.01-1991.08	Estate Engine C14NZ	•		GWB3256	
	1990.01-1991.08	Estate Engine C14NZ	•		GWB3403	
	1990.01-1991.08	Estate Engine C14NZ		◦	GWB0944	
	1990.01-1991.08	Estate Engine C14NZ			GWB0663	
1.4 S (55 kW)	1990.01-1991.08	Estate Engine 14NV	•		GHA422006	K
	1990.01-1991.08	Estate Engine 14NV	•		GWB3256	
	1990.01-1991.08	Estate Engine 14NV	•		GWB3403	
	1990.01-1991.08	Estate Engine 14NV		◦	GWB0944	
	1990.01-1991.08	Estate Engine 14NV			GWB0663	
KADETT E (37_, 47_)						
1.4 i (44 kW)	1990.01-1991.08	Box Engine C14NZ	•		GWB3256	
	1990.01-1991.08	Box Engine C14NZ	•		GWB3403	
	1990.01-1991.08	Box Engine C14NZ		◦	GWB0944	
	1990.01-1991.08	Box Engine C14NZ			GWB0663	
KADETT E (39_, 49_)						
1.4 i (44 kW)	1990.01-1991.08	Saloon Engine C14NZ	•		GHA422006	K
	1990.01-1991.08	Saloon Engine C14NZ	•		GWB3256	



	 YEAR		F	R	G-AP Ref.	KIT
OPEL						
KADETT E (39_, 49_)						
1.4 i (44 kW)	1990.01-1991.08	Saloon Engine C14NZ	•		GWB3403	
	1990.01-1991.08	Saloon Engine C14NZ		◦	GWB0944	
	1990.01-1991.08	Saloon Engine C14NZ			GWB0663	
1.4 S (55 kW)	1990.01-1991.08	Saloon Engine 14NV	•		GHA422006	K
	1990.01-1991.08	Saloon Engine 14NV	•		GWB3256	
	1990.01-1991.08	Saloon Engine 14NV	•		GWB3403	
	1990.01-1991.08	Saloon Engine 14NV		◦	GWB0944	
	1990.01-1991.08	Saloon Engine 14NV			GWB0663	
1.8 i (66 kW)	1990.09-1991.08	Saloon Engine 18SV/C18NT/C18NZ	•		GHA433007	
	1990.09-1991.08	Saloon Engine 18SV/C18NT/C18NZ	•		GHA433013	
	1990.09-1991.08	Saloon Engine 18SV/C18NT/C18NZ	•		GWB0736	
	1990.09-1991.08	Saloon Engine 18SV/C18NT/C18NZ		◦	GWB0944	
KADETT E (43B_)						
1.4 i (44 kW)	1990.01-1991.08	Convertible Engine C14NZ	•		GHA422006	K
	1990.01-1991.08	Convertible Engine C14NZ	•		GWB3256	
	1990.01-1991.08	Convertible Engine C14NZ	•		GWB3403	
	1990.01-1991.08	Convertible Engine C14NZ		◦	GWB0944	
	1990.01-1991.08	Convertible Engine C14NZ			GWB0663	
1.4 S (55 kW)	1990.08-1993.02	Convertible Engine 14NV	•		GWB3256	
	1990.08-1993.02	Convertible Engine 14NV	•		GWB3403	
	1990.08-1993.02	Convertible Engine 14NV		◦	GWB0944	
	1990.08-1993.02	Convertible Engine 14NV			GWB0663	
2.0 (110 kW)	1990.09-1992.05	Convertible Engine C20XE	•		GHA433007	
	1990.09-1992.05	Convertible Engine C20XE	•		GWB0736	
	1990.09-1992.05	Convertible Engine C20XE		◦	GWB0944	
2.0 GSi (115 kW)	1990.09-1992.05	Convertible Engine 20SER	•		GWB0736	
	1990.09-1992.05	Convertible Engine 20SER		◦	GWB0944	
KADETT E COMBO (38_, 48_)						
1.4 i (44 kW)	1991.08-1994.07	Box Engine C14NZ	•		GHA433013	
	1991.08-1994.07	Box Engine C14NZ	•		GWB3256	
	1991.08-1994.07	Box Engine C14NZ	•		GWB3403	
	1991.08-1994.07	Box Engine C14NZ		◦	GWB0526	
	1991.08-1994.07	Box Engine C14NZ			GWB0663	
1.6 i (55 kW)	1991.08-1994.07	Box Engine C16NZ	•		GHA422006	K
	1991.08-1994.07	Box Engine C16NZ	•		GHA433013	
	1991.08-1994.07	Box Engine C16NZ	•		GWB3256	
	1991.08-1994.07	Box Engine C16NZ	•		GWB3403	
	1991.08-1994.07	Box Engine C16NZ		◦	GWB0526	
1.7 D (44 kW)	1991.08-1994.07	Box Engine C16NZ			GWB0663	
	1992.07-1994.07	Box Engine 17DR	•		GHA433013	
	1992.07-1994.07	Box Engine 17DR	•		GWB0736	
1992.07-1994.07	Box Engine 17DR		◦	GWB0526		
MERIVA						
1.3 CDTi (51 kW)	2005.04-2010.05	MPV Engine Y13DT/Z13DT	•		GHA422014	
	2005.04-2010.05	MPV Engine Y13DT/Z13DT With ABS		◦	GHA400064	K
	2005.04-2010.05	MPV Engine Y13DT/Z13DT Without ABS		◦	GHA400058	K
1.3 CDTi (55 kW)	2003.09-2010.05	MPV Engine Z13DTJ	•		GHA422014	
	2003.09-2010.05	MPV Engine Z13DTJ With ABS		◦	GHA400052	K
	2003.09-2010.05	MPV Engine Z13DTJ With ABS		◦	GHA400064	K
1.4 16V Twinport (66 kW)	2004.07-2010.05	MPV Engine Z14XEP	•		GHA422014	
	2004.07-2010.05	MPV Engine Z14XEP With ABS		◦	GHA400064	K
1.4 16V Twinport LPG (66 kW)	2004.07-2010.05	MPV Engine Z14XEP	•		GHA422014	
	2004.07-2010.05	MPV Engine Z14XEP With ABS		◦	GHA400064	K
1.6 (64 kW)	2003.05-2010.05	MPV Engine Z16SE	•		GHA422014	
	2003.05-2010.05	MPV Engine Z16SE With ABS		◦	GHA400064	K
	2003.05-2010.05	MPV Engine Z16SE Without ABS		◦	GHA400058	K
1.6 (77 kW)	2006.01-2010.05	MPV Engine Z16XEP	•		GHA422014	
	2006.01-2010.05	MPV Engine Z16XEP With ABS		◦	GHA400064	K
1.6 16V (74 kW)	2003.05-2006.01	MPV Engine Z16XE	•		GHA422014	
	2003.05-2006.01	MPV Engine Z16XE With ABS		◦	GHA400064	K
	2003.05-2006.01	MPV Engine Z16XE Without ABS		◦	GHA400058	K
1.6 Turbo (132 kW)	2005.09-2010.05	MPV Engine Z16LET	•		GHA422014	
	2005.09-2010.05	MPV Engine Z16LET	•		GWB0736	
	2005.09-2010.05	MPV Engine Z16LET With ABS		◦	GHA400052	K



	 YEAR		F	R	G-AP Ref.	KIT
OPEL						
MERIVA						
1.7 CDTi (74 kW)	2003.09-2010.05	MPV Engine Z17DT/Z17DTH	•		GHA422014	
	2003.09-2010.05	MPV Engine Z17DT/Z17DTH	•		GWB0736	
	2003.09-2010.05	MPV Engine Z17DT/Z17DTH With ABS		◦	GHA400052	K
1.7 CDTi (92 kW)	2006.09-2010.05	MPV Engine A17DTR/Z17DTR	•		GHA422014	
	2006.09-2010.05	MPV Engine A17DTR/Z17DTR	•		GWB0736	
	2006.09-2010.05	MPV Engine A17DTR/Z17DTR With ABS		◦	GHA400052	K
1.7 DTi (55 kW)	2003.09-2010.05	MPV Engine Y17DT	•		GHA422014	
	2003.09-2010.05	MPV Engine Y17DT With ABS		◦	GHA400064	K
	2003.09-2010.05	MPV Engine Y17DT Without ABS		◦	GHA400058	K
1.8 (92 kW)	2003.05-2010.05	MPV Engine Z18XE	•		GHA422014	
	2003.05-2010.05	MPV Engine Z18XE With ABS		◦	GHA400064	K
	2003.05-2010.05	MPV Engine Z18XE Without ABS		◦	GHA400058	K
MERIVA B						
1.3 CDTi (55 kW)	2010.06-	MPV Engine A13DTC	•		GHA422014	
	2010.06-	MPV Engine A13DTC	•		GWB6720	
	2010.06-	MPV Engine A13DTC		◦	GHA400133	K
1.3 CDTi (70 kW)	2010.06-	MPV Engine A13DTE	•		GHA422014	
	2010.06-	MPV Engine A13DTE	•		GWB6720	
	2010.06-	MPV Engine A13DTE		◦	GHA400133	K
1.4 (103 kW)	2010.06-	MPV Engine A14NEL/B14NEL	•		GHA422014	
	2010.06-	MPV Engine A14NEL/B14NEL	•		GWB6720	
	2010.06-	MPV Engine A14NEL/B14NEL		◦	GHA400133	K
1.4 (74 kW)	2010.06-	MPV Engine A14NEL/B14NEL	•		GHA422014	
	2010.06-	MPV Engine A14NEL/B14NEL	•		GWB6720	
	2010.06-	MPV Engine A14NEL/B14NEL		◦	GHA400133	K
1.4 (88 kW)	2010.06-	MPV Engine A14NEL/B14NEL	•		GHA422014	
	2010.06-	MPV Engine A14NEL/B14NEL	•		GWB6720	
	2010.06-	MPV Engine A14NEL/B14NEL		◦	GHA400133	K
1.4 LPG (88 kW)	2011.06-	MPV Engine A14NEL/B14NEL	•		GWB6720	
	2011.06-	MPV Engine A14NEL/B14NEL		◦	GHA400133	K
1.6 CDTi (100 kW)	2013.08-	MPV Engine B16DTH	•		GWB6720	
	2013.08-	MPV Engine B16DTH		◦	GHA400133	K
1.6 CDTi (70 kW)	2014.01-	MPV Engine B16DTC	•		GWB6720	
	2014.01-	MPV Engine B16DTC		◦	GHA400133	K
1.6 CDTi (81 kW)	2014.03-	MPV Engine B16DTE/B16DTL/B16DTN	•		GWB6720	
	2014.03-	MPV Engine B16DTE/B16DTL/B16DTN		◦	GHA400133	K
1.7 CDTi (74 kW)	2010.06-	MPV Engine A17DT	•		GHA422014	
	2010.06-	MPV Engine A17DT	•		GWB6720	
	2010.06-	MPV Engine A17DT		◦	GHA400133	K
1.7 CDTi (81 kW)	2010.06-	MPV Engine A17DTC/A17DTI	•		GHA422014	
	2010.06-	MPV Engine A17DTC/A17DTI	•		GWB6720	
	2010.06-	MPV Engine A17DTC/A17DTI		◦	GHA400133	K
1.7 CDTi (96 kW)	2010.06-	MPV Engine A17DTS	•		GHA422014	
	2010.06-	MPV Engine A17DTS	•		GWB6720	
	2010.06-	MPV Engine A17DTS		◦	GHA400133	K
MOKKA						
1.4 (103 kW)	2013.04-	Closed Off-Road Vehicle Engine A14NET	•		GWB6720	
	2013.04-	Closed Off-Road Vehicle Engine A14NET		◦	GHA400259	
1.4 4x4 (103 kW)	2012.06-	Closed Off-Road Vehicle Engine A14NET	•		GWB6720	
1.4 LPG (103 kW)	2013.04-	Closed Off-Road Vehicle Engine A 14 NET	•		GWB6720	
	2013.04-	Closed Off-Road Vehicle Engine A 14 NET		◦	GHA400259	
1.6 (85 kW)	2012.06-	Closed Off-Road Vehicle Engine A16XER	•		GWB6720	
	2012.06-	Closed Off-Road Vehicle Engine A16XER		◦	GHA400259	
1.6 CDTi (100 kW)	2015.01-	Closed Off-Road Vehicle Engine B 16 DTH	•		GWB6720	
	2015.01-	Closed Off-Road Vehicle Engine B 16 DTH		◦	GHA400259	
1.6 CDTi 4x4 (100 kW)	2015.01-	Closed Off-Road Vehicle Engine B 16 DTH	•		GWB6720	
1.7 CDTi (96 kW)	2012.06-	Closed Off-Road Vehicle Engine A17DTS	•		GWB6720	
	2012.06-	Closed Off-Road Vehicle Engine A17DTS		◦	GHA400259	
1.7 CDTi 4x4 (96 kW)	2012.06-	Closed Off-Road Vehicle Engine A17DTS	•		GWB6720	
1.8 (103 kW)	2013.01-	Closed Off-Road Vehicle Engine A18XER	•		GWB6720	
	2013.01-	Closed Off-Road Vehicle Engine A18XER		◦	GHA400259	
1.8 4x4 (103 kW)	2013.01-	Closed Off-Road Vehicle Engine A 18 XER	•		GWB6720	
MOVANO (F9)						
1.9 DTi (59 kW)	2000.09-2001.10	Box Engine F9Q770	•		GWB3500	



	 YEAR		F	R	G-AP Ref.	KIT
OPEL						
MOVANO (F9)						
1.9 DTi (59 kW)	2000.09-2001.10	Box Engine F9Q770	•		GWB3613	
	2000.09-2001.10	Box Engine F9Q770		◦	GWB3501	
	2000.09-2001.10	Box Engine F9Q770		◦	GWB3614	
1.9 DTi (60 kW)	2001.10-	Box Engine F9Q772/F9Q774	•		GWB3500	
	2001.10-	Box Engine F9Q772/F9Q774	•		GWB3613	
	2001.10-	Box Engine F9Q772/F9Q774		◦	GWB3501	
	2001.10-	Box Engine F9Q772/F9Q774		◦	GWB3614	
2.2 DTi (66 kW)	2000.09-	Box Engine G9T720/G9T722/G9T750	•		GWB3500	
	2000.09-	Box Engine G9T720/G9T722/G9T750	•		GWB3613	
	2000.09-	Box Engine G9T720/G9T722/G9T750		◦	GWB3501	
	2000.09-	Box Engine G9T720/G9T722/G9T750		◦	GWB3614	
2.5 CDTi (107 kW)	2003.10-	Box Engine G9U632/G9U650	•		GWB3613	
	2003.10-	Box Engine G9U632/G9U650		◦	GWB3501	
	2003.10-	Box Engine G9U632/G9U650		◦	GWB3614	
2.5 CDTi (74 kW)	2003.10-	Box Engine G9U650	•		GWB3613	
	2003.10-	Box Engine G9U650		◦	GWB3501	
	2003.10-	Box Engine G9U650		◦	GWB3614	
2.5 CDTi (88 kW)	2003.10-	Box Engine G9U632/G9U650	•		GWB3613	
	2003.10-	Box Engine G9U632/G9U650		◦	GWB3501	
	2003.10-	Box Engine G9U632/G9U650		◦	GWB3614	
2.5 D (59 kW)	1999.01-2000.09	Box Engine S8U770/S8U772	•		GWB3500	
	1999.01-2000.09	Box Engine S8U770/S8U772	•		GWB3613	
	1999.01-2000.09	Box Engine S8U770/S8U772		◦	GWB3501	
	1999.01-2000.09	Box Engine S8U770/S8U772		◦	GWB3614	
2.5 DTi (73 kW)	2003.10-	Box Engine G9U754	•		GWB3613	
	2003.10-	Box Engine G9U754		◦	GWB3501	
	2003.10-	Box Engine G9U754		◦	GWB3614	
2.5 DTi (84 kW)	2001.10-	Box Engine G9U720/G8U724/G9U754	•		GWB3500	
	2001.10-	Box Engine G9U720/G8U724/G9U754	•		GWB3613	
	2001.10-	Box Engine G9U720/G8U724/G9U754		◦	GWB3501	
	2001.10-	Box Engine G9U720/G8U724/G9U754		◦	GWB3614	
2.8 DTi (84 kW)	1999.01-2001.10	Box Engine S9W700/S9W702	•		GWB3500	
	1999.01-2001.10	Box Engine S9W700/S9W702	•		GWB3613	
	1999.01-2001.10	Box Engine S9W700/S9W702		◦	GWB3501	
	1999.01-2001.10	Box Engine S9W700/S9W702		◦	GWB3614	
3.0 DTi (100 kW)	2003.10-	Box Engine ZD3200/ZD3202	•		GWB3613	
	2003.10-	Box Engine ZD3200/ZD3202		◦	GWB3501	
	2003.10-	Box Engine ZD3200/ZD3202		◦	GWB3614	
MOVANO (H9)						
2.2 DTi (66 kW)	2000.09-	Dumptruck Engine G9T720/G9T722/G9T750	•		GWB3500	
	2000.09-	Dumptruck Engine G9T720/G9T722/G9T750	•		GWB3613	
	2000.09-	Dumptruck Engine G9T720/G9T722/G9T750		◦	GWB3501	
	2000.09-	Dumptruck Engine G9T720/G9T722/G9T750		◦	GWB3614	
2.5 CDTi (107 kW)	2006.08-	Dumptruck Engine G9U650/G9U632	•		GWB3613	
	2006.08-	Dumptruck Engine G9U650/G9U632		◦	GWB3501	
	2006.08-	Dumptruck Engine G9U650/G9U632		◦	GWB3614	
2.5 CDTi (74 kW)	2006.08-	Dumptruck Engine G9U650	•		GWB3613	
	2006.08-	Dumptruck Engine G9U650		◦	GWB3501	
	2006.08-	Dumptruck Engine G9U650		◦	GWB3614	
2.5 CDTi (88 kW)	2006.08-	Dumptruck Engine G9U650/G9U632	•		GWB3613	
	2006.08-	Dumptruck Engine G9U650/G9U632		◦	GWB3501	
	2006.08-	Dumptruck Engine G9U650/G9U632		◦	GWB3614	
2.5 D (59 kW)	1999.01-2000.09	Dumptruck Engine S8U770/S8U772	•		GWB3500	
	1999.01-2000.09	Dumptruck Engine S8U770/S8U772	•		GWB3613	
	1999.01-2000.09	Dumptruck Engine S8U770/S8U772		◦	GWB3501	
	1999.01-2000.09	Dumptruck Engine S8U770/S8U772		◦	GWB3614	
2.5 DTi (73 kW)	2003.10-	Dumptruck Engine G9U754	•		GWB3613	
	2003.10-	Dumptruck Engine G9U754		◦	GWB3501	
	2003.10-	Dumptruck Engine G9U754		◦	GWB3614	
2.5 DTi (84 kW)	2001.10-	Dumptruck Engine G9U720/G9U724/G9U750/G9U754	•		GWB3500	
	2001.10-	Dumptruck Engine G9U720/G9U724/G9U750/G9U754	•		GWB3613	
2.8 DTi (84 kW)	1999.01-2001.10	Dumptruck Engine S9W700/S9W702	•		GWB3500	
	1999.01-2001.10	Dumptruck Engine S9W700/S9W702	•		GWB3613	
	1999.01-2001.10	Dumptruck Engine S9W700/S9W702		◦	GWB3501	



	 YEAR		F	R	G-AP Ref.	KIT
OPEL						
MOVANO (H9)						
2.8 DTi (84 kW)	1999.01-2001.10	Dumptruck Engine S9W700/S9W702		o	GWB3614	
3.0 DTi (100 kW)	2003.10-	Dumptruck Engine ZD3200/ZD3202	•		GWB3613	
	2003.10-	Dumptruck Engine ZD3200/ZD3202		o	GWB3501	
	2003.10-	Dumptruck Engine ZD3200/ZD3202		o	GWB3614	
MOVANO (J9)						
1.9 DTi (59 kW)	2000.09-2001.10	Bus Engine F9Q770	•		GWB3500	
	2000.09-2001.10	Bus Engine F9Q770	•		GWB3613	
	2000.09-2001.10	Bus Engine F9Q770		o	GWB3501	
	2000.09-2001.10	Bus Engine F9Q770		o	GWB3614	
1.9 DTi (60 kW)	2001.10-	Bus Engine F9Q772/F9Q774	•		GWB3500	
	2001.10-	Bus Engine F9Q772/F9Q774	•		GWB3613	
	2001.10-	Bus Engine F9Q772/F9Q774		o	GWB3501	
	2001.10-	Bus Engine F9Q772/F9Q774		o	GWB3614	
2.2 DTi (66 kW)	2000.09-	Bus Engine G9T720/G9T722/G9T750	•		GWB3500	
	2000.09-	Bus Engine G9T720/G9T722/G9T750	•		GWB3613	
	2000.09-	Bus Engine G9T720/G9T722/G9T750		o	GWB3501	
	2000.09-	Bus Engine G9T720/G9T722/G9T750		o	GWB3614	
2.5 CDTi (107 kW)	2006.08-	Bus Engine G9U632/G9U650	•		GWB3613	
	2006.08-	Bus Engine G9U632/G9U650		o	GWB3501	
	2006.08-	Bus Engine G9U632/G9U650		o	GWB3614	
2.5 CDTi (73 kW)	2003.10-2006.12	Bus	•		GWB3613	
	2003.10-2006.12	Bus		o	GWB3501	
	2003.10-2006.12	Bus		o	GWB3614	
2.5 CDTi (74 kW)	2007.09-	Bus Engine G9U650	•		GWB3613	
	2007.09-	Bus Engine G9U650		o	GWB3501	
	2007.09-	Bus Engine G9U650		o	GWB3614	
2.5 CDTi (88 kW)	2006.08-	Bus Engine G9U632/G9U650	•		GWB3613	
	2006.08-	Bus Engine G9U632/G9U650		o	GWB3501	
	2006.08-	Bus Engine G9U632/G9U650		o	GWB3614	
2.5 D (59 kW)	1998.07-2000.09	Bus Engine S8U770/S8U772	•		GWB3500	
	1998.07-2000.09	Bus Engine S8U770/S8U772	•		GWB3613	
	1998.07-2000.09	Bus Engine S8U770/S8U772		o	GWB3501	
	1998.07-2000.09	Bus Engine S8U770/S8U772		o	GWB3614	
2.5 DTi (84 kW)	2001.10-	Bus Engine G9U720/G9U724/G9U750/G9U754	•		GWB3500	
	2001.10-	Bus Engine G9U720/G9U724/G9U750/G9U754	•		GWB3613	
	2001.10-	Bus Engine G9U720/G9U724/G9U750/G9U754		o	GWB3501	
	2001.10-	Bus Engine G9U720/G9U724/G9U750/G9U754		o	GWB3614	
2.8 DTi (84 kW)	1998.07-2001.10	Bus Engine S9W700/S9W702	•		GWB3500	
	1998.07-2001.10	Bus Engine S9W700/S9W702	•		GWB3613	
	1998.07-2001.10	Bus Engine S9W700/S9W702		o	GWB3501	
	1998.07-2001.10	Bus Engine S9W700/S9W702		o	GWB3614	
3.0 DTi (100 kW)	2003.10-	Bus Engine ZD3200/ZD3202	•		GWB3613	
	2003.10-	Bus Engine ZD3200/ZD3202		o	GWB3501	
	2003.10-	Bus Engine ZD3200/ZD3202		o	GWB3614	
MOVANO (U9, E9)						
2.2 DTi (66 kW)	2000.09-	Platform/Chassis Engine G9T720/G9T722/G9T750	•		GWB3500	
	2000.09-	Platform/Chassis Engine G9T720/G9T722/G9T750	•		GWB3613	
	2000.09-	Platform/Chassis Engine G9T720/G9T722/G9T750		o	GWB3501	
	2000.09-	Platform/Chassis Engine G9T720/G9T722/G9T750		o	GWB3614	
2.5 CDTi (107 kW)	2006.08-	Platform/Chassis Engine G9U632/G9U650	•		GWB3613	
	2006.08-	Platform/Chassis Engine G9U632/G9U650		o	GWB3501	
	2006.08-	Platform/Chassis Engine G9U632/G9U650		o	GWB3614	
2.5 CDTi (74 kW)	2006.08-	Platform/Chassis Engine G9U650	•		GWB3613	
	2006.08-	Platform/Chassis Engine G9U650		o	GWB3501	
	2006.08-	Platform/Chassis Engine G9U650		o	GWB3614	
2.5 CDTi (88 kW)	2006.08-	Platform/Chassis Engine G9U632/G9U650	•		GWB3613	
	2006.08-	Platform/Chassis Engine G9U632/G9U650		o	GWB3501	
	2006.08-	Platform/Chassis Engine G9U632/G9U650		o	GWB3614	
2.5 D (59 kW)	1998.07-2000.09	Platform/Chassis Engine S8U770/S8U772	•		GWB3500	
	1998.07-2000.09	Platform/Chassis Engine S8U770/S8U772	•		GWB3613	
	1998.07-2000.09	Platform/Chassis Engine S8U770/S8U772		o	GWB3501	
	1998.07-2000.09	Platform/Chassis Engine S8U770/S8U772		o	GWB3614	
2.5 DTi (73 kW)	2003.10-	Platform/Chassis Engine G9U754	•		GWB3613	
	2003.10-	Platform/Chassis Engine G9U754		o	GWB3501	



	 YEAR		F	R	G-AP Ref.	KIT
OPEL						
MOVANO (U9, E9)						
2.5 DTi (73 kW)	2003.10-	Platform/Chassis Engine G9U754		o	GWB3614	
2.5 DTi (84 kW)	2001.10-	Platform/Chassis Engine G9U720/G9U724/G9U750/G9U754	•		GWB3500	
	2001.10-	Platform/Chassis Engine G9U720/G9U724/G9U750/G9U754	•		GWB3613	
	2001.10-	Platform/Chassis Engine G9U720/G9U724/G9U750/G9U754		o	GWB3501	
	2001.10-	Platform/Chassis Engine G9U720/G9U724/G9U750/G9U754		o	GWB3614	
	2001.10-	Platform/Chassis Engine G9U720/G9U724/G9U750/G9U754		o	GWB3614	
2.8 DTi (84 kW)	1998.07-2001.10	Platform/Chassis Engine S9W700/S9W702	•		GWB3500	
	1998.07-2001.10	Platform/Chassis Engine S9W700/S9W702	•		GWB3613	
	1998.07-2001.10	Platform/Chassis Engine S9W700/S9W702		o	GWB3501	
	1998.07-2001.10	Platform/Chassis Engine S9W700/S9W702		o	GWB3614	
3.0 DTi (100 kW)	2003.10-	Platform/Chassis Engine ZD3200/ZD3202	•		GWB3613	
	2003.10-	Platform/Chassis Engine ZD3200/ZD3202		o	GWB3501	
	2003.10-	Platform/Chassis Engine ZD3200/ZD3202		o	GWB3614	
MOVANO B						
2.3 CDTi (107 kW)	2010.12-	Bus Engine M9T678/M9T680		o	GWB6722	
2.3 CDTi (74 kW)	2010.05-	Box Engine M9T672/M9T670/M9T676	•		GWB6721	
	2010.05-	Box Engine M9T672/M9T670/M9T676		o	GWB6722	
	2010.05-	Box Engine M9T690/M9T692	•		GWB6721	
	2010.05-	Box Engine M9T690/M9T692		o	GWB6742	
	2010.12-	Bus Engine M9T670/M9T672/M9T676		o	GWB6722	
2.3 CDTi (92 kW)	2010.05-	Box Engine M9T672/M9T670/M9T676	•		GWB6721	
	2010.05-	Box Engine M9T672/M9T670/M9T676		o	GWB6722	
	2010.05-	Box Engine M9T686/M9T690/M9T696	•		GWB6721	
	2010.05-	Box Engine M9T686/M9T690/M9T696		o	GWB6742	
	2010.12-	Bus Engine M9T670/M9T672/M9T676/M9T680		o	GWB6722	
2.3 CDTi [RWD] (107 kW)	2010.05-	Box Engine M9T 694	•		GWB6721	
	2010.05-	Box Engine M9T 694		o	GWB6742	
	2010.05-	Platform/Chassis Engine M9T 694/M9T 696/M9T 698	•		GWB6721	
	2010.05-	Platform/Chassis Engine M9T 694/M9T 696/M9T 698		o	GWB6742	
2.3 CDTi [RWD] (74 kW)	2010.05-	Platform/Chassis Engine M9T 690/M9T 692	•		GWB6721	
	2010.05-	Platform/Chassis Engine M9T 690/M9T 692		o	GWB6742	
2.3 CDTi [RWD] (92 kW)	2010.05-	Platform/Chassis Engine M9T 692	•		GWB6721	
	2010.05-	Platform/Chassis Engine M9T 692		o	GWB6742	
2.3 CDTi FWD (107 kW)	2010.05-	Box Engine M9T 678	•		GWB6721	
	2010.05-	Box Engine M9T 678		o	GWB6722	
	2010.05-	Platform/Chassis Engine M9T 678/M9T 680	•		GWB6721	
	2010.05-	Platform/Chassis Engine M9T 678/M9T 680		o	GWB6722	
2.3 CDTi FWD (74 kW)	2010.05-	Platform/Chassis Engine M9T 670/M9T 672	•		GWB6721	
	2010.05-	Platform/Chassis Engine M9T 670/M9T 672		o	GWB6722	
2.3 CDTi FWD (92 kW)	2010.05-	Platform/Chassis Engine M9T 670/M9T 672/M9T 676/M9T 680/M9T 876	•		GWB6721	
	2010.05-	Platform/Chassis Engine M9T 670/M9T 672/M9T 676/M9T 680/M9T 876		o	GWB6722	
OMEGA A (16_, 17_, 19_)						
2.0 (73 kW)	1990.09-1994.03	Saloon Engine C20NEJ		o	GWB0754	
	1990.09-1994.03	Saloon Engine C20NEJ With ABS	•		GHA235001	K
	1990.09-1994.03	Saloon Engine C20NEJ With ABS	•		GHA235001	K
	1990.09-1994.03	Saloon Engine C20NEJ Without ABS	•		GHA235013	
	1990.09-1994.03	Saloon Engine C20NEJ Without ABS	•		GHA235013	
2.0 (74 kW)	1990.09-1994.03	Saloon Engine C20NEF		o	GWB0754	
	1990.09-1994.03	Saloon Engine C20NEF With ABS	•		GHA235001	K
	1990.09-1994.03	Saloon Engine C20NEF With ABS	•		GHA235001	K
	1990.09-1994.03	Saloon Engine C20NEF Without ABS	•		GHA235013	
	1990.09-1994.03	Saloon Engine C20NEF Without ABS	•		GHA235013	
	1990.09-1994.03	Saloon Engine C20NEF Without ABS	•		GHA235013	
2.6 i (110 kW)	1990.09-1994.03	Saloon Engine C26NE		o	GWB1326	
	1990.09-1994.03	Saloon Engine C26NE With ABS	•		GHA235001	K
	1990.09-1994.03	Saloon Engine C26NE With ABS	•		GHA235001	K
	1990.09-1994.03	Saloon Engine C26NE Without ABS	•		GHA235013	
	1990.09-1994.03	Saloon Engine C26NE Without ABS	•		GHA235013	
3.0 24V Evolution500 (169 kW)	1991.03-1992.07	Saloon Engine C30XEI		o	GWB1326	
	1991.03-1992.07	Saloon Engine C30XEI With ABS	•		GHA235001	K
	1991.03-1992.07	Saloon Engine C30XEI With ABS	•		GHA235001	K
	1991.03-1992.07	Saloon Engine C30XEI Without ABS	•		GHA235013	
	1991.03-1992.07	Saloon Engine C30XEI Without ABS	•		GHA235013	
	1991.03-1992.07	Saloon Engine C30XEI Without ABS	•		GHA235013	
3.6 24V Lotus (277 kW)	1990.08-1992.09	Saloon Engine C36GET		o	GWB1326	
	1990.08-1992.09	Saloon Engine C36GET With ABS	•		GHA235001	K
	1990.08-1992.09	Saloon Engine C36GET With ABS	•		GHA235001	K



	 YEAR		F	R	G-AP Ref.	KIT
OPEL						
OMEGA A (16_, 17_, 19_)						
3.6 24V Lotus (277 kW)	1990.08-1992.09	Saloon Engine C36GET Without ABS	•		GHA235013	
	1990.08-1992.09	Saloon Engine C36GET Without ABS	•		GHA235013	
OMEGA A (66_, 67_)						
2.0 (74 kW)	1990.09-1994.03	Estate Engine C20NEF		○	GWB1326	
	1990.09-1994.03	Estate Engine C20NEF With ABS	•		GHA235001	K
	1990.09-1994.03	Estate Engine C20NEF With ABS	•		GHA235001	K
	1990.09-1994.03	Estate Engine C20NEF Without ABS	•		GHA235013	
	1990.09-1994.03	Estate Engine C20NEF Without ABS	•		GHA235013	
2.0 i (73 kW)	1990.09-1994.03	Estate Engine C20NEJ		○	GWB1326	
	1990.09-1994.03	Estate Engine C20NEJ With ABS	•		GHA235001	K
	1990.09-1994.03	Estate Engine C20NEJ With ABS	•		GHA235001	K
	1990.09-1994.03	Estate Engine C20NEJ Without ABS	•		GHA235013	
	1990.09-1994.03	Estate Engine C20NEJ Without ABS	•		GHA235013	
2.6 i (110 kW)	1990.09-1994.03	Estate Engine C26NE		○	GWB1326	
	1990.09-1994.03	Estate Engine C26NE With ABS	•		GHA235001	K
	1990.09-1994.03	Estate Engine C26NE With ABS	•		GHA235001	K
	1990.09-1994.03	Estate Engine C26NE Without ABS	•		GHA235013	
	1990.09-1994.03	Estate Engine C26NE Without ABS	•		GHA235013	
OMEGA B (21_, 22_, 23_)						
2.0 (85 kW)	1994.03-1999.09	Estate Engine X20SE		○	GWB1326	
	1994.03-1999.09	Estate Engine X20SE With ABS	•		GHA235001	K
	1994.03-1999.09	Estate Engine X20SE With ABS	•		GHA235001	K
	1994.03-1999.09	Estate Engine X20SE Without ABS	•		GHA235013	
	1994.03-1999.09	Estate Engine X20SE Without ABS	•		GHA235013	
2.0 (90 kW)	1994.05-1999.05	Estate Engine XF 20 E		○	GWB1326	
	1994.05-1999.05	Estate Engine XF 20 E With ABS	•		GHA235001	K
	1994.05-1999.05	Estate Engine XF 20 E With ABS	•		GHA235001	K
2.0 16V (100 kW)	1994.03-1999.09	Estate Engine X20XEV		○	GWB1326	
	1994.03-1999.09	Estate Engine X20XEV With ABS	•		GHA235001	K
	1994.03-1999.09	Estate Engine X20XEV With ABS	•		GHA235001	K
	1994.03-1999.09	Estate Engine X20XEV Without ABS	•		GHA235013	
	1994.03-1999.09	Estate Engine X20XEV Without ABS	•		GHA235013	
2.0 DTi 16V (74 kW)	1997.09-2000.09	Estate Engine X20DTH		○	GWB1326	
	1997.09-2000.09	Estate Engine X20DTH With ABS	•		GHA235001	K
	1997.09-2000.09	Estate Engine X20DTH With ABS	•		GHA235001	K
	1997.09-2000.09	Estate Engine X20DTH Without ABS	•		GHA235013	
	1997.09-2000.09	Estate Engine X20DTH Without ABS	•		GHA235013	
2.2 16V (106 kW)	1999.09-2003.07	Estate Engine Y22XE/Z22XE		○	GWB1326	
	1999.09-2003.07	Estate Engine Y22XE/Z22XE With ABS	•		GHA235001	K
	1999.09-2003.07	Estate Engine Y22XE/Z22XE With ABS	•		GHA235001	K
	1999.09-2003.07	Estate Engine Y22XE/Z22XE Without ABS	•		GHA235013	
	1999.09-2003.07	Estate Engine Y22XE/Z22XE Without ABS	•		GHA235013	
2.2 DTi 16V (81 kW)	2000.09-2003.07	Estate Engine Y22DTH		○	GWB1326	
	2000.09-2003.07	Estate Engine Y22DTH With ABS	•		GHA235001	K
	2000.09-2003.07	Estate Engine Y22DTH With ABS	•		GHA235001	K
	2000.09-2003.07	Estate Engine Y22DTH Without ABS	•		GHA235013	
	2000.09-2003.07	Estate Engine Y22DTH Without ABS	•		GHA235013	
2.2 DTi 16V (88 kW)	2000.09-2003.07	Estate Engine Y22DTH		○	GWB1326	
	2000.09-2003.07	Estate Engine Y22DTH With ABS	•		GHA235001	K
	2000.09-2003.07	Estate Engine Y22DTH With ABS	•		GHA235001	K
	2000.09-2003.07	Estate Engine Y22DTH Without ABS	•		GHA235013	
	2000.09-2003.07	Estate Engine Y22DTH Without ABS	•		GHA235013	
2.5 DTi (110 kW)	2001.09-2003.07	Estate Engine Y25DT		○	GWB1326	
	2001.09-2003.07	Estate Engine Y25DT With ABS	•		GHA235001	K
	2001.09-2003.07	Estate Engine Y25DT With ABS	•		GHA235001	K
	2001.09-2003.07	Estate Engine Y25DT Without ABS	•		GHA235013	
	2001.09-2003.07	Estate Engine Y25DT Without ABS	•		GHA235013	
2.5 TD (96 kW)	1994.04-2001.07	Estate Engine 25DT/X25DT/X25TD		○	GWB1326	
	1994.04-2001.07	Estate Engine 25DT/X25DT/X25TD With ABS	•		GHA235001	K
	1994.04-2001.07	Estate Engine 25DT/X25DT/X25TD With ABS	•		GHA235001	K
	1994.04-2001.07	Estate Engine 25DT/X25DT/X25TD Without ABS	•		GHA235013	
	1994.04-2001.07	Estate Engine 25DT/X25DT/X25TD Without ABS	•		GHA235013	
2.5 V6 (125 kW)	1994.03-2000.09	Estate Engine X25XE		○	GWB1326	
	1994.03-2000.09	Estate Engine X25XE With ABS	•		GHA235001	K



	 YEAR		F	R	G-AP Ref.	KIT
OPEL						
OMEGA B (21_, 22_, 23_)						
2.5 V6 (125 kW)	1994.03-2000.09	Estate Engine X25XE With ABS	•		GHA235001	K
	1994.03-2000.09	Estate Engine X25XE Without ABS	•		GHA235013	
	1994.03-2000.09	Estate Engine X25XE Without ABS	•		GHA235013	
2.6 V6 (132 kW)	2000.09-2003.07	Estate Engine Y26SE		○	GWB1326	
	2000.09-2003.07	Estate Engine Y26SE With ABS	•		GHA235001	K
	2000.09-2003.07	Estate Engine Y26SE With ABS	•		GHA235001	K
	2000.09-2003.07	Estate Engine Y26SE Without ABS	•		GHA235013	
	2000.09-2003.07	Estate Engine Y26SE Without ABS	•		GHA235013	
3.0 V6 (155 kW)	1994.04-2001.02	Estate Engine X30XE		○	GWB1326	
	1994.04-2001.02	Estate Engine X30XE With ABS	•		GHA235001	K
	1994.04-2001.02	Estate Engine X30XE With ABS	•		GHA235001	K
	1994.04-2001.02	Estate Engine X30XE Without ABS	•		GHA235013	
	1994.04-2001.02	Estate Engine X30XE Without ABS	•		GHA235013	
3.2 V6 (160 kW)	2001.02-2003.07	Estate Engine Y32SE		○	GWB1326	
	2001.02-2003.07	Estate Engine Y32SE With ABS	•		GHA235001	K
	2001.02-2003.07	Estate Engine Y32SE With ABS	•		GHA235001	K
	2001.02-2003.07	Estate Engine Y32SE Without ABS	•		GHA235013	
	2001.02-2003.07	Estate Engine Y32SE Without ABS	•		GHA235013	
OMEGA B (21_, 22_, 23_)						
2.6 (138 kW)	1994.05-1999.05	Wagon		○	GWB1326	
	1994.05-1999.05	Wagon With ABS	•		GHA235001	K
	1994.05-1999.05	Wagon With ABS	•		GHA235001	K
OMEGA B (25_, 26_, 27_)						
2.0 (85 kW)	1994.03-1999.09	Saloon Engine X20SE		○	GWB1326	
	1994.03-1999.09	Saloon Engine X20SE		○	GWB3410	
	1994.03-1999.09	Saloon Engine X20SE With ABS	•		GHA235001	K
	1994.03-1999.09	Saloon Engine X20SE With ABS	•		GHA235001	K
	1994.03-1999.09	Saloon Engine X20SE Without ABS	•		GHA235013	
	1994.03-1999.09	Saloon Engine X20SE Without ABS	•		GHA235013	
	1994.03-2000.12	Saloon Engine 20SE		○	GWB1326	
	1994.03-2000.12	Saloon Engine 20SE		○	GWB3410	
	1994.03-2000.12	Saloon Engine 20SE With ABS	•		GHA235001	K
	1994.03-2000.12	Saloon Engine 20SE With ABS	•		GHA235001	K
	1994.03-2000.12	Saloon Engine 20SE Without ABS	•		GHA235013	
	1994.03-2000.12	Saloon Engine 20SE Without ABS	•		GHA235013	
	2.0 (90 kW)	1994.05-1999.05	Saloon Engine XF 20 E		○	GWB1326
1994.05-1999.05		Saloon Engine XF 20 E		○	GWB3410	
1994.05-1999.05		Saloon Engine XF 20 E With ABS	•		GHA235001	K
1994.05-1999.05		Saloon Engine XF 20 E With ABS	•		GHA235001	K
2.0 16V (100 kW)	1994.03-1999.09	Saloon Engine X20XEV		○	GWB1326	
	1994.03-1999.09	Saloon Engine X20XEV		○	GWB3410	
	1994.03-1999.09	Saloon Engine X20XEV With ABS	•		GHA235001	K
	1994.03-1999.09	Saloon Engine X20XEV With ABS	•		GHA235001	K
	1994.03-1999.09	Saloon Engine X20XEV Without ABS	•		GHA235013	
2.0 DTi 16V (74 kW)	1997.09-2000.09	Saloon Engine X20DTH		○	GWB1326	
	1997.09-2000.09	Saloon Engine X20DTH		○	GWB3410	
	1997.09-2000.09	Saloon Engine X20DTH With ABS	•		GHA235001	K
	1997.09-2000.09	Saloon Engine X20DTH With ABS	•		GHA235001	K
	1997.09-2000.09	Saloon Engine X20DTH Without ABS	•		GHA235013	
2.2 16V (106 kW)	1999.09-2003.07	Saloon Engine Y22XE/Z22XE		○	GWB1326	
	1999.09-2003.07	Saloon Engine Y22XE/Z22XE		○	GWB3410	
	1999.09-2003.07	Saloon Engine Y22XE/Z22XE With ABS	•		GHA235001	K
	1999.09-2003.07	Saloon Engine Y22XE/Z22XE With ABS	•		GHA235001	K
	1999.09-2003.07	Saloon Engine Y22XE/Z22XE Without ABS	•		GHA235013	
2.2 DTi 16V (81 kW)	1999.09-2003.07	Saloon Engine Y22XE/Z22XE Without ABS	•		GHA235013	
	2000.09-2003.07	Saloon Engine Y22DTH		○	GWB1326	
	2000.09-2003.07	Saloon Engine Y22DTH		○	GWB3410	
	2000.09-2003.07	Saloon Engine Y22DTH With ABS	•		GHA235001	K
	2000.09-2003.07	Saloon Engine Y22DTH With ABS	•		GHA235001	K
2.2 DTi 16V (86 kW)	2000.09-2003.07	Saloon Engine Y22DTH Without ABS	•		GHA235013	
	2000.09-2003.07	Saloon Engine Y22DTH Without ABS	•		GHA235013	
	2001.01-	Saloon Engine Y 22 DTR		○	GWB1326	



	 YEAR		F	R	G-AP Ref.	KIT
OPEL						
OMEGA B (25_, 26_, 27_)						
2.2 DTi 16V (86 kW)	2001.01-	Saloon Engine Y 22 DTR		o	GWB3410	
	2001.01-	Saloon Engine Y 22 DTR With ABS	•		GHA235001	K
	2001.01-	Saloon Engine Y 22 DTR With ABS	•		GHA235001	K
2.2 DTi 16V (88 kW)	2000.09-2003.07	Saloon Engine Y22DTH		o	GWB1326	
	2000.09-2003.07	Saloon Engine Y22DTH		o	GWB3410	
	2000.09-2003.07	Saloon Engine Y22DTH With ABS	•		GHA235001	K
	2000.09-2003.07	Saloon Engine Y22DTH With ABS	•		GHA235001	K
	2000.09-2003.07	Saloon Engine Y22DTH Without ABS	•		GHA235013	
	2000.09-2003.07	Saloon Engine Y22DTH Without ABS	•		GHA235013	
2.5 DTi (110 kW)	2001.09-2003.07	Saloon Engine Y25DT		o	GWB1326	
	2001.09-2003.07	Saloon Engine Y25DT		o	GWB3410	
	2001.09-2003.07	Saloon Engine Y25DT With ABS	•		GHA235001	K
	2001.09-2003.07	Saloon Engine Y25DT With ABS	•		GHA235001	K
	2001.09-2003.07	Saloon Engine Y25DT Without ABS	•		GHA235013	
2.5 TD (96 kW)	1994.04-2003.07	Saloon Engine 25DT/X25DT/X25TD		o	GWB1326	
	1994.04-2003.07	Saloon Engine 25DT/X25DT/X25TD		o	GWB3410	
	1994.04-2003.07	Saloon Engine 25DT/X25DT/X25TD With ABS	•		GHA235001	K
	1994.04-2003.07	Saloon Engine 25DT/X25DT/X25TD With ABS	•		GHA235001	K
	1994.04-2003.07	Saloon Engine 25DT/X25DT/X25TD Without ABS	•		GHA235013	
	1994.04-2003.07	Saloon Engine 25DT/X25DT/X25TD Without ABS	•		GHA235013	
2.5 V6 (125 kW)	1994.03-2000.09	Saloon Engine X25XE		o	GWB1326	
	1994.03-2000.09	Saloon Engine X25XE		o	GWB3410	
	1994.03-2000.09	Saloon Engine X25XE With ABS	•		GHA235001	K
	1994.03-2000.09	Saloon Engine X25XE With ABS	•		GHA235001	K
	1994.03-2000.09	Saloon Engine X25XE Without ABS	•		GHA235013	
	1994.03-2000.09	Saloon Engine X25XE Without ABS	•		GHA235013	
2.6 V6 (132 kW)	2000.09-2003.07	Saloon Engine Y26SE		o	GWB1326	
	2000.09-2003.07	Saloon Engine Y26SE		o	GWB3410	
	2000.09-2003.07	Saloon Engine Y26SE With ABS	•		GHA235001	K
	2000.09-2003.07	Saloon Engine Y26SE With ABS	•		GHA235001	K
	2000.09-2003.07	Saloon Engine Y26SE Without ABS	•		GHA235013	
	2000.09-2003.07	Saloon Engine Y26SE Without ABS	•		GHA235013	
3.0 V6 (155 kW)	1994.04-2001.02	Saloon Engine X30XE		o	GWB1326	
	1994.04-2001.02	Saloon Engine X30XE		o	GWB3410	
	1994.04-2001.02	Saloon Engine X30XE With ABS	•		GHA235001	K
	1994.04-2001.02	Saloon Engine X30XE With ABS	•		GHA235001	K
	1994.04-2001.02	Saloon Engine X30XE Without ABS	•		GHA235013	
	1994.04-2001.02	Saloon Engine X30XE Without ABS	•		GHA235013	
3.2 V6 (160 kW)	2001.02-2003.07	Saloon Engine Y32SE		o	GWB1326	
	2001.02-2003.07	Saloon Engine Y32SE		o	GWB3410	
	2001.02-2003.07	Saloon Engine Y32SE With ABS	•		GHA235001	K
	2001.02-2003.07	Saloon Engine Y32SE With ABS	•		GHA235001	K
	2001.02-2003.07	Saloon Engine Y32SE Without ABS	•		GHA235013	
	2001.02-2003.07	Saloon Engine Y32SE Without ABS	•		GHA235013	
SENATOR B (29_)						
2.5 i (103 kW)	1990.09-1993.09	Saloon Engine 25NE		o	GWB1326	
	1990.09-1993.09	Saloon Engine 25NE With ABS	•		GHA235001	K
	1990.09-1993.09	Saloon Engine 25NE With ABS	•		GHA235001	K
	1990.09-1993.09	Saloon Engine 25NE Without ABS	•		GHA235013	
	1990.09-1993.09	Saloon Engine 25NE Without ABS	•		GHA235013	
2.6 i (110 kW)	1990.09-1993.09	Saloon Engine C26NE		o	GWB1326	
	1990.09-1993.09	Saloon Engine C26NE With ABS	•		GHA235001	K
	1990.09-1993.09	Saloon Engine C26NE With ABS	•		GHA235001	K
	1990.09-1993.09	Saloon Engine C26NE Without ABS	•		GHA235013	
	1990.09-1993.09	Saloon Engine C26NE Without ABS	•		GHA235013	
3.6 (147 kW)	1991.09-1993.08	Saloon Engine C 36 NEI		o	GWB1326	
	1991.09-1993.08	Saloon Engine C 36 NEI With ABS	•		GHA235001	K
	1991.09-1993.08	Saloon Engine C 36 NEI With ABS	•		GHA235001	K
SIGNUM						
1.8 (103 kW)	2005.11-2007.01	Hatchback Engine Z18XER	•		GHA330021	K
	2005.11-2007.01	Hatchback Engine Z18XER		o	GHA400137	K
1.8 (90 kW)	2004.07-2006.01	Hatchback Engine Z18XE	•		GHA330011	K
	2004.07-2006.01	Hatchback Engine Z18XE	•		GHA330021	K



	 YEAR		F	R	G-AP Ref.	KIT
OPEL						
SIGNUM						
1.8 (90 kW)	2004.07-2006.01	Hatchback Engine Z18XE		o	GHA400137	K
1.9 CDTi (110 kW)	2004.04-	Hatchback Engine Z19DTH	•		GHA330011	K
	2004.04-	Hatchback Engine Z19DTH	•		GHA330021	K
1.9 CDTi (74 kW)	2004.04-	Hatchback Engine Z19DTH		o	GHA400137	K
	2005.08-	Hatchback Engine Z19DT	•		GHA330021	K
1.9 CDTi (88 kW)	2005.08-	Hatchback Engine Z19DT		o	GHA400137	K
	2004.04-	Hatchback Engine Z19DT	•		GHA330011	K
2.0 DTi (74 kW)	2004.04-	Hatchback Engine Z19DT	•		GHA330021	K
	2004.04-	Hatchback Engine Z19DT		o	GHA400137	K
	2003.05-	Hatchback Engine Y20DTH	•		GHA330011	K
2.0 Turbo (129 kW)	2003.05-	Hatchback Engine Y20DTH	•		GHA330021	K
	2003.05-	Hatchback Engine Y20DTH		o	GHA400137	K
	2003.05-	Hatchback Engine Z20NET	•		GHA330011	K
2.2 Direct (114 kW)	2003.05-	Hatchback Engine Z20NET	•		GHA330021	K
	2003.05-	Hatchback Engine Z22YH		o	GHA400137	K
	2003.05-	Hatchback Engine Z22YH	•		GHA330011	K
2.2 DTi (92 kW)	2003.05-	Hatchback Engine Z22YH	•		GHA330021	K
	2003.05-	Hatchback Engine Y22DTR		o	GHA400137	K
	2003.05-	Hatchback Engine Y22DTR	•		GHA330011	K
2.2 DTi 16V (86 kW)	2003.05-	Hatchback Engine Y22DTR	•		GHA330021	K
	2003.05-2008.06	Hatchback Engine Y 22 DTR		o	GHA400137	K
	2003.05-2008.06	Hatchback Engine Y 22 DTR	•		GHA330011	K
2.8 V6 Turbo (169 kW)	2003.05-2008.06	Hatchback Engine Y 22 DTR	•		GHA330021	K
	2005.09-	Hatchback Engine Z28NEL		o	GHA400137	K
2.8 V6 Turbo (184 kW)	2005.09-	Hatchback Engine Z28NEL	•		GHA330011	K
	2006.11-	Hatchback Engine Z28NET		o	GHA400137	K
3.0 V6 CDTi (130 kW)	2006.11-	Hatchback Engine Z28NET	•		GHA330021	K
	2003.05-	Hatchback Engine Y30DT		o	GHA400137	K
	2003.05-	Hatchback Engine Y30DT	•		GHA330011	K
3.0 V6 CDTi (135 kW)	2003.05-	Hatchback Engine Y30DT	•		GHA330021	K
	2003.05-	Hatchback Engine Y30DT		o	GHA400137	K
	2005.09-	Hatchback Engine Z30DT	•		GHA330011	K
3.2 V6 (155 kW)	2005.09-	Hatchback Engine Z30DT		o	GHA400137	K
	2003.05-	Hatchback Engine Z32SE	•		GHA330011	K
	2003.05-	Hatchback Engine Z32SE	•		GHA330021	K
	2003.05-	Hatchback Engine Z32SE		o	GHA400137	K
SINTRA						
2.2 DTi (85 kW)	1997.07-1999.04	MPV Engine X22DTH	•		GHA333083	K
	1997.07-1999.04	MPV Engine X22DTH		o	GHA400013	
	1997.07-1999.04	MPV Engine X22DTH		o	GHA400031	
2.2 i 16V (104 kW)	1996.11-1999.04	MPV Engine X22XE	•		GHA333083	K
	1996.11-1999.04	MPV Engine X22XE		o	GHA400013	
	1996.11-1999.04	MPV Engine X22XE		o	GHA400031	
3.0 i 24V (148 kW)	1996.11-1999.04	MPV Engine X22XE	•		GHA333083	K
	1996.11-1999.04	MPV Engine X30XE		o	GHA400013	
	1996.11-1999.04	MPV Engine X30XE		o	GHA400031	
TIGRA (95_)						
1.4 16V (63 kW)	1997.08-2000.12	Coupe Engine X14XE	•		GWB3403	
	1997.08-2000.12	Coupe Engine X14XE		o	GWB0944	
1.4 16V (66 kW)	1994.07-2000.12	Coupe Engine X14XE	•		GHA422006	K
	1994.07-2000.12	Coupe Engine X14XE	•		GWB3403	
	1994.07-2000.12	Coupe Engine X14XE		o	GHA499004	
	1994.07-2000.12	Coupe Engine X14XE		o	GWB0944	
1.6 16V (74 kW)	1997.08-1998.08	Coupe Engine C16SEL	•		GWB3403	
	1997.08-1998.08	Coupe Engine C16SEL		o	GWB0944	
1.6 16V (78 kW)	1994.07-1998.08	Coupe Engine X16XE	•		GHA422006	K
	1994.07-1998.08	Coupe Engine X16XE	•		GWB3403	
	1994.07-1998.08	Coupe Engine X16XE		o	GHA499004	
	1994.07-1998.08	Coupe Engine X16XE		o	GWB0944	
TIGRA TWINTOP						
1.3 CDTi (51 kW)	2004.06-	Convertible Engine Z13DT	•		GHA422014	
	2004.06-	Convertible Engine Z13DT		o	GHA227023	K
	2004.06-	Convertible Engine Z13DT		o	GWB3601	
1.4 (66 kW)	2006.11-2008.03	Convertible Engine Z14XEP	•		GHA422014	



	 YEAR		F	R	G-AP Ref.	KIT
OPEL						
TIGRA TWINTOP						
1.4 (66 kW)	2006.11-2008.03	Convertible Engine Z14XEP		o	GHA227023	K
	2006.11-2008.03	Convertible Engine Z14XEP		o	GWB3601	
1.8 (92 kW)	2006.11-2008.03	Convertible Engine Z18XE	•		GHA422014	
	2006.11-2008.03	Convertible Engine Z18XE		o	GHA227023	K
	2006.11-2008.03	Convertible Engine Z18XE		o	GWB3601	
VECTRA A (86_, 87_)						
1.6 (51 kW)	1992.08-1993.07	Saloon Engine C16LZ2	•		GHA422006	K
	1992.08-1993.07	Saloon Engine C16LZ2	•		GHA433007	
1.6 i (52 kW)	1993.09-1995.11	Saloon Engine X16SZ	•		GHA422006	K
	1993.09-1995.11	Saloon Engine X16SZ	•		GWB3256	
	1993.09-1995.11	Saloon Engine X16SZ	•		GWB3403	
	1993.09-1995.11	Saloon Engine X16SZ			GWB0663	
	1993.09-1995.11	Saloon Engine X16SZ With ABS		o	GHA400064	K
	1993.09-1995.11	Saloon Engine X16SZ Without ABS		o	GHA400058	K
1.6 i (55 kW)	1993.09-1995.11	Saloon Engine 16LZ2	•		GHA433013	
	1993.09-1995.11	Saloon Engine 16LZ2	•		GWB0736	
	1993.09-1995.11	Saloon Engine 16LZ2	•		GWB3403	
	1993.09-1995.11	Saloon Engine 16LZ2 With ABS		o	GHA400064	K
	1993.09-1995.11	Saloon Engine 16LZ2 Without ABS		o	GHA400058	K
1.7 D (44 kW)	1992.07-1995.11	Saloon Engine 17DR	•		GHA433007	
	1992.07-1995.11	Saloon Engine 17DR	•		GHA433013	
	1992.07-1995.11	Saloon Engine 17DR	•		GWB0736	
	1992.07-1995.11	Saloon Engine 17DR		o	GWB0944	
	1992.07-1995.11	Saloon Engine 17DR With ABS		o	GHA400064	K
	1992.07-1995.11	Saloon Engine 17DR Without ABS		o	GHA400058	K
1.7 TD (60 kW)	1990.03-1995.11	Saloon Engine 17DT(TC4EE1)/X17DT(TC4EE1)	•		GHA433007	
	1990.03-1995.11	Saloon Engine 17DT(TC4EE1)/X17DT(TC4EE1)	•		GHA433013	
	1990.03-1995.11	Saloon Engine 17DT(TC4EE1)/X17DT(TC4EE1)	•		GWB0736	
	1990.03-1995.11	Saloon Engine 17DT(TC4EE1)/X17DT(TC4EE1)		o	GWB0944	
	1990.03-1995.11	Saloon Engine 17DT(TC4EE1)/X17DT(TC4EE1) With ABS		o	GHA400064	K
	1990.03-1995.11	Saloon Engine 17DT(TC4EE1)/X17DT(TC4EE1) Without ABS		o	GHA400058	K
1.8 i CAT (66 kW)	1990.03-1995.11	Saloon Engine C18NZ	•		GHA433007	
	1990.03-1995.11	Saloon Engine C18NZ	•		GHA433013	
	1990.03-1995.11	Saloon Engine C18NZ	•		GWB0736	
	1990.03-1995.11	Saloon Engine C18NZ		o	GWB0944	
	1990.03-1995.11	Saloon Engine C18NZ With ABS		o	GHA400064	K
	1990.03-1995.11	Saloon Engine C18NZ Without ABS		o	GHA400058	K
2.0 GT 16V 4x4 CAT (110 kW)	1990.02-1995.11	Saloon Engine C20XE	•		GHA433013	
	1990.02-1995.11	Saloon Engine C20XE	•		GWB0736	
	1990.02-1995.11	Saloon Engine C20XE		o	GWB1326	
2.0 GT 16V CAT (110 kW)	1990.02-1995.11	Saloon Engine C20XE	•		GHA433007	
	1990.02-1995.11	Saloon Engine C20XE	•		GHA433013	
	1990.02-1995.11	Saloon Engine C20XE	•		GWB0736	
	1990.02-1995.11	Saloon Engine C20XE		o	GWB1326	
	1990.02-1995.11	Saloon Engine C20XE With ABS		o	GHA400064	K
	1990.02-1995.11	Saloon Engine C20XE Without ABS		o	GHA400058	K
2.0 i 16V (100 kW)	1994.06-1995.11	Saloon Engine X20XEV	•		GHA433007	
	1994.06-1995.11	Saloon Engine X20XEV	•		GWB0736	
	1994.06-1995.11	Saloon Engine X20XEV With ABS		o	GHA400064	K
	1994.06-1995.11	Saloon Engine X20XEV Without ABS		o	GHA400058	K
2.0 i 16V 4x4 (100 kW)	1994.06-1995.11	Saloon Engine X20XEV	•		GHA433007	
	1994.06-1995.11	Saloon Engine X20XEV	•		GWB0736	
	1994.06-1995.11	Saloon Engine X20XEV		o	GWB1326	
2.0 i Turbo 4x4 (150 kW)	1994.06-1995.11	Saloon Engine C20LET	•		GWB3410	
	1994.06-1995.11	Saloon Engine C20LET		o	GWB1326	
2.5 V6 (125 kW)	1993.02-1995.11	Saloon Engine C25XE	•		GWB3410	
	1993.02-1995.11	Saloon Engine C25XE With ABS		o	GHA400052	K
VECTRA A (88_, 89_)						
1.6 (51 kW)	1992.08-1993.07	Hatchback Engine C 16 LZ2	•		GHA422006	K
	1992.08-1993.07	Hatchback Engine C 16 LZ2	•		GHA433007	
1.6 i (52 kW)	1993.09-1995.11	Hatchback Engine X16SZ	•		GHA422006	K
	1993.09-1995.11	Hatchback Engine X16SZ	•		GWB3256	
	1993.09-1995.11	Hatchback Engine X16SZ	•		GWB3403	
	1993.09-1995.11	Hatchback Engine X16SZ			GWB0663	



	 YEAR		F	R	G-AP Ref.	KIT	
OPEL							
VECTRA A (88_, 89_)							
1.6 i (52 kW)	1993.09-1995.11	Hatchback Engine X16SZ With ABS		o	GHA400064	K	
	1993.09-1995.11	Hatchback Engine X16SZ Without ABS		o	GHA400058	K	
1.6 i (55 kW)	1993.09-1995.11	Hatchback Engine 16LZ2	•		GHA433013		
	1993.09-1995.11	Hatchback Engine 16LZ2	•		GWB0736		
	1993.09-1995.11	Hatchback Engine 16LZ2	•		GWB3403		
	1993.09-1995.11	Hatchback Engine 16LZ2 With ABS		o	GHA400064	K	
	1993.09-1995.11	Hatchback Engine 16LZ2 Without ABS		o	GHA400058	K	
	1.7 D (44 kW)	1992.07-1995.11	Hatchback Engine 17DR	•		GHA433007	
	1992.07-1995.11	Hatchback Engine 17DR	•		GHA433013		
	1992.07-1995.11	Hatchback Engine 17DR	•		GWB0736		
	1992.07-1995.11	Hatchback Engine 17DR		o	GWB0944		
	1992.07-1995.11	Hatchback Engine 17DR With ABS		o	GHA400064	K	
	1992.07-1995.11	Hatchback Engine 17DR Without ABS		o	GHA400058	K	
1.7 TD (60 kW)	1990.03-1995.11	Hatchback Engine X17DT(TC4EE1)/17DT(TC4EE1)	•		GHA433007		
	1990.03-1995.11	Hatchback Engine X17DT(TC4EE1)/17DT(TC4EE1)	•		GHA433013		
	1990.03-1995.11	Hatchback Engine X17DT(TC4EE1)/17DT(TC4EE1)	•		GWB0736		
	1990.03-1995.11	Hatchback Engine X17DT(TC4EE1)/17DT(TC4EE1)		o	GWB0944		
	1990.03-1995.11	Hatchback Engine X17DT(TC4EE1)/17DT(TC4EE1) With ABS		o	GHA400064	K	
	1990.03-1995.11	Hatchback Engine X17DT(TC4EE1)/17DT(TC4EE1) Without ABS		o	GHA400058	K	
1.8 i CAT (66 kW)	1990.03-1995.11	Hatchback Engine C18NZ	•		GHA433007		
	1990.03-1995.11	Hatchback Engine C18NZ	•		GHA433013		
	1990.03-1995.11	Hatchback Engine C18NZ	•		GWB0736		
	1990.03-1995.11	Hatchback Engine C18NZ		o	GWB0944		
	1990.03-1995.11	Hatchback Engine C18NZ With ABS		o	GHA400064	K	
	1990.03-1995.11	Hatchback Engine C18NZ Without ABS		o	GHA400058	K	
	2.0 i 16V (100 kW)	1994.06-1995.11	Hatchback Engine X20XEV	•		GHA433007	
	1994.06-1995.11	Hatchback Engine X20XEV	•		GHA433013		
	1994.06-1995.11	Hatchback Engine X20XEV	•		GWB0736		
	1994.06-1995.11	Hatchback Engine X20XEV With ABS		o	GHA400064	K	
	1994.06-1995.11	Hatchback Engine X20XEV Without ABS		o	GHA400058	K	
2.0 i 16V CAT (110 kW)	1990.02-1995.11	Hatchback Engine C20XE	•		GHA433007		
	1990.02-1995.11	Hatchback Engine C20XE	•		GHA433013		
	1990.02-1995.11	Hatchback Engine C20XE	•		GWB0736		
	1990.02-1995.11	Hatchback Engine C20XE		o	GWB1326		
	1990.02-1995.11	Hatchback Engine C20XE With ABS		o	GHA400064	K	
	1990.02-1995.11	Hatchback Engine C20XE Without ABS		o	GHA400058	K	
2.5 V6 (125 kW)	1993.02-1995.11	Hatchback Engine C25XE	•		GWB3410		
	1993.02-1995.11	Hatchback Engine C25XE With ABS		o	GHA400052	K	
VECTRA B (31_)							
1.6 i (55 kW)	1996.11-2000.06	Estate Engine 16LZ2	•		GHA433004		
	1996.11-2000.06	Estate Engine 16LZ2	•		GHA433019		
	1996.11-2000.06	Estate Engine 16LZ2	•		GWB3410		
	1996.11-2000.06	Estate Engine 16LZ2 With ABS		o	GHA400052	K	
	1996.11-2000.06	Estate Engine 16LZ2 With ABS		o	GHA400064	K	
	1996.11-2000.06	Estate Engine X16SZR	•		GHA422023		
	1996.11-2000.06	Estate Engine X16SZR	•		GHA433004		
	1996.11-2000.06	Estate Engine X16SZR	•		GHA433019		
	1996.11-2000.06	Estate Engine X16SZR	•		GWB3410		
	1996.11-2000.06	Estate Engine X16SZR With ABS		o	GHA400052	K	
	1996.11-2000.06	Estate Engine X16SZR With ABS		o	GHA400064	K	
	1.6 i 16V (74 kW)	1996.11-2002.07	Estate Engine X16XEL/Y16XE/Z16XE	•		GHA422023	
		1996.11-2002.07	Estate Engine X16XEL/Y16XE/Z16XE	•		GHA433004	
	1996.11-2002.07	Estate Engine X16XEL/Y16XE/Z16XE	•		GHA433019		
	1996.11-2002.07	Estate Engine X16XEL/Y16XE/Z16XE	•		GWB3410		
	1996.11-2002.07	Estate Engine X16XEL/Y16XE/Z16XE With ABS		o	GHA400052	K	
	1996.11-2002.07	Estate Engine X16XEL/Y16XE/Z16XE With ABS		o	GHA400064	K	
1.7 TD (60 kW)	1996.11-1997.12	Estate Engine X17DT(TC4EE1)	•		GHA433004		
	1996.11-1997.12	Estate Engine X17DT(TC4EE1)	•		GHA433019		
	1996.11-1997.12	Estate Engine X17DT(TC4EE1)	•		GWB3410		
	1996.11-1997.12	Estate Engine X17DT(TC4EE1) With ABS		o	GHA400064	K	
1.8 i 16V (85 kW)	1996.11-2000.09	Estate Engine X18XE	•		GHA433004		
	1996.11-2000.09	Estate Engine X18XE	•		GHA433019		
	1996.11-2000.09	Estate Engine X18XE	•		GWB3410		
	1996.11-2000.09	Estate Engine X18XE With ABS		o	GHA400052	K	



	 YEAR		F	R	G-AP Ref.	KIT
OPEL						
VECTRA B (31_)						
1.8 i 16V (85 kW)	1996.11-2000.09	Estate Engine X18XE With ABS		o	GHA400064	K
	1996.11-2000.09	Estate Engine X18XE1	•		GHA433004	
	1996.11-2000.09	Estate Engine X18XE1	•		GHA433019	
	1996.11-2000.09	Estate Engine X18XE1	•		GWB3410	
	1996.11-2000.09	Estate Engine X18XE1 With ABS		o	GHA400052	K
	1996.11-2000.09	Estate Engine X18XE1 With ABS		o	GHA400064	K
1.8 i 16V (92 kW)	2000.09-2003.07	Estate Engine Z18XE	•		GHA433004	
	2000.09-2003.07	Estate Engine Z18XE	•		GHA433019	
	2000.09-2003.07	Estate Engine Z18XE	•		GWB3410	
	2000.09-2003.07	Estate Engine Z18XE With ABS		o	GHA400052	K
	2000.09-2003.07	Estate Engine Z18XE With ABS		o	GHA400064	K
2.0 Di 16V (60 kW)	1996.11-2000.06	Estate Engine X20DTL	•		GHA433004	
	1996.11-2000.06	Estate Engine X20DTL	•		GHA433019	
	1996.11-2000.06	Estate Engine X20DTL	•		GWB3410	
	1996.11-2000.06	Estate Engine X20DTL With ABS		o	GHA400052	K
	1996.11-2000.06	Estate Engine X20DTL With ABS		o	GHA400064	K
2.0 DTi 16V (74 kW)	1997.06-2003.07	Estate Engine X20DTH/Y20DTH	•		GHA433004	
	1997.06-2003.07	Estate Engine X20DTH/Y20DTH	•		GHA433019	
	1997.06-2003.07	Estate Engine X20DTH/Y20DTH	•		GWB3410	
	1997.06-2003.07	Estate Engine X20DTH/Y20DTH With ABS		o	GHA400052	K
	1997.06-2003.07	Estate Engine X20DTH/Y20DTH With ABS		o	GHA400064	K
2.0 i (82 kW)	1996.11-2002.02	Estate Engine 20NEJ	•		GHA433004	
	1996.11-2002.02	Estate Engine 20NEJ	•		GHA433019	
	1996.11-2002.02	Estate Engine 20NEJ	•		GWB3410	
	1996.11-2002.02	Estate Engine 20NEJ With ABS		o	GHA400052	K
	1996.11-2002.02	Estate Engine 20NEJ With ABS		o	GHA400064	K
2.0 i 16V (100 kW)	1996.11-2000.09	Estate Engine X20XEV	•		GHA433004	
	1996.11-2000.09	Estate Engine X20XEV	•		GWB3410	
	1996.11-2000.09	Estate Engine X20XEV With ABS		o	GHA400052	K
	1996.11-2000.09	Estate Engine X20XEV With ABS		o	GHA400064	K
2.2 DTi 16V (88 kW)	2000.09-2002.04	Estate Engine Y22DTR	•		GHA433004	
	2000.09-2002.04	Estate Engine Y22DTR	•		GWB3410	
	2000.09-2002.04	Estate Engine Y22DTR With ABS		o	GHA400052	K
2.2 DTi 16V (92 kW)	2000.09-2003.07	Estate Engine Y22DTR	•		GHA433004	
	2000.09-2003.07	Estate Engine Y22DTR	•		GWB3410	
	2000.09-2003.07	Estate Engine Y22DTR With ABS		o	GHA400052	K
2.2 i 16V (108 kW)	2000.09-2003.07	Estate Engine Z22SE	•		GHA433004	
	2000.09-2003.07	Estate Engine Z22SE	•		GWB3410	
	2000.09-2003.07	Estate Engine Z22SE With ABS		o	GHA400052	K
2.5 (143 kW)	1998.05-2000.09	Estate Engine X25XE	•		GWB3410	
	1998.05-2000.09	Estate Engine X25XE With ABS		o	GHA400052	K
	1998.05-2000.09	Estate Engine X25XE With ABS		o	GHA400064	K
2.5 i V6 (125 kW)	1996.11-2000.09	Estate Engine X25XE	•		GHA433004	
	1996.11-2000.09	Estate Engine X25XE	•		GWB3410	
	1996.11-2000.09	Estate Engine X25XE With ABS		o	GHA400052	K
	1996.11-2000.09	Estate Engine X25XE With ABS		o	GHA400064	K
2.6 i V6 (125 kW)	2000.09-2003.07	Estate Engine Y26SE	•		GHA433004	
	2000.09-2003.07	Estate Engine Y26SE	•		GWB3410	
	2000.09-2003.07	Estate Engine Y26SE With ABS		o	GHA400052	K
VECTRA B (36_)						
1.6 GL (60 kW)	1995.09-1996.08	Saloon Engine 16 SV	•		GWB3410	
	1995.09-1996.08	Saloon Engine 16 SV With ABS		o	GHA400064	K
1.6 i (55 kW)	1995.10-2002.04	Saloon Engine 16LZ2	•		GHA433004	
	1995.10-2002.04	Saloon Engine 16LZ2	•		GHA433019	
	1995.10-2002.04	Saloon Engine 16LZ2	•		GWB3410	
	1995.10-2002.04	Saloon Engine 16LZ2 With ABS		o	GHA400052	K
	1995.10-2002.04	Saloon Engine 16LZ2 With ABS		o	GHA400064	K
	1995.10-2002.04	Saloon Engine X16SZR	•		GHA422023	
	1995.10-2002.04	Saloon Engine X16SZR	•		GHA433004	
	1995.10-2002.04	Saloon Engine X16SZR	•		GHA433019	
	1995.10-2002.04	Saloon Engine X16SZR	•		GWB3410	
	1995.10-2002.04	Saloon Engine X16SZR With ABS		o	GHA400052	K
1995.10-2002.04	Saloon Engine X16SZR With ABS		o	GHA400064	K	
1.6 i 16V (74 kW)	1995.10-2002.04	Saloon Engine X16XEL/Y16XE/Z16XE	•		GHA422023	



	 YEAR		F	R	G-AP Ref.	KIT
OPEL						
VECTRA B (36_)						
1.6 i 16V (74 kW)	1995.10-2002.04	Saloon Engine X16XEL/Y16XE/Z16XE	•		GHA433004	
	1995.10-2002.04	Saloon Engine X16XEL/Y16XE/Z16XE	•		GHA433019	
	1995.10-2002.04	Saloon Engine X16XEL/Y16XE/Z16XE	•		GWB3410	
	1995.10-2002.04	Saloon Engine X16XEL/Y16XE/Z16XE With ABS		○	GHA400052	K
	1995.10-2002.04	Saloon Engine X16XEL/Y16XE/Z16XE With ABS		○	GHA400064	K
1.7 TD (60 kW)	1995.10-1998.12	Saloon Engine X17DT(TC4EE1)	•		GHA433004	
	1995.10-1998.12	Saloon Engine X17DT(TC4EE1)	•		GHA433019	
	1995.10-1998.12	Saloon Engine X17DT(TC4EE1)	•		GWB3410	
	1995.10-1998.12	Saloon Engine X17DT(TC4EE1) With ABS		○	GHA400064	K
1.8 i 16V (85 kW)	1995.10-2000.09	Saloon Engine X18XE	•		GHA433004	
	1995.10-2000.09	Saloon Engine X18XE	•		GHA433019	
	1995.10-2000.09	Saloon Engine X18XE	•		GWB3410	
	1995.10-2000.09	Saloon Engine X18XE With ABS		○	GHA400052	K
	1995.10-2000.09	Saloon Engine X18XE With ABS		○	GHA400064	K
	1995.10-2000.09	Saloon Engine X18XE1	•		GHA433004	
	1995.10-2000.09	Saloon Engine X18XE1	•		GHA433019	
	1995.10-2000.09	Saloon Engine X18XE1	•		GWB3410	
	1995.10-2000.09	Saloon Engine X18XE1 With ABS		○	GHA400052	K
	1995.10-2000.09	Saloon Engine X18XE1 With ABS		○	GHA400064	K
1.8 i 16V (92 kW)	2000.09-2002.04	Saloon Engine Z18XE	•		GHA433004	
	2000.09-2002.04	Saloon Engine Z18XE	•		GHA433019	
	2000.09-2002.04	Saloon Engine Z18XE	•		GWB3410	
	2000.09-2002.04	Saloon Engine Z18XE With ABS		○	GHA400052	K
	2000.09-2002.04	Saloon Engine Z18XE With ABS		○	GHA400064	K
2.0 Di 16V (60 kW)	1996.11-2002.04	Saloon Engine X20DTL	•		GHA433004	
	1996.11-2002.04	Saloon Engine X20DTL	•		GHA433019	
	1996.11-2002.04	Saloon Engine X20DTL	•		GWB3410	
	1996.11-2002.04	Saloon Engine X20DTL With ABS		○	GHA400052	K
	1996.11-2002.04	Saloon Engine X20DTL With ABS		○	GHA400064	K
2.0 DTi 16V (74 kW)	1997.06-2002.04	Saloon Engine X20DTH/Y20DTH	•		GHA433004	
	1997.06-2002.04	Saloon Engine X20DTH/Y20DTH	•		GHA433019	
	1997.06-2002.04	Saloon Engine X20DTH/Y20DTH	•		GWB3410	
	1997.06-2002.04	Saloon Engine X20DTH/Y20DTH With ABS		○	GHA400052	K
	1997.06-2002.04	Saloon Engine X20DTH/Y20DTH With ABS		○	GHA400064	K
2.0 i (82 kW)	1995.10-2002.04	Saloon Engine 20NEJ	•		GHA433004	
	1995.10-2002.04	Saloon Engine 20NEJ	•		GHA433019	
	1995.10-2002.04	Saloon Engine 20NEJ	•		GWB3410	
	1995.10-2002.04	Saloon Engine 20NEJ With ABS		○	GHA400052	K
	1995.10-2002.04	Saloon Engine 20NEJ With ABS		○	GHA400064	K
2.0 i 16V (100 kW)	1995.10-2000.09	Saloon Engine X20XEV	•		GHA433004	
	1995.10-2000.09	Saloon Engine X20XEV	•		GWB3410	
	1995.10-2000.09	Saloon Engine X20XEV With ABS		○	GHA400052	K
	1995.10-2000.09	Saloon Engine X20XEV With ABS		○	GHA400064	K
2.2 DTi 16V (88 kW)	2000.09-2002.04	Saloon Engine Y22DTR	•		GWB3410	
	2000.09-2002.04	Saloon Engine Y22DTR With ABS		○	GHA400052	K
2.2 DTi 16V (92 kW)	2000.09-2002.04	Saloon Engine Y22DTR	•		GHA433004	
	2000.09-2002.04	Saloon Engine Y22DTR	•		GWB3410	
	2000.09-2002.04	Saloon Engine Y22DTR With ABS		○	GHA400052	K
2.2 i 16V (108 kW)	2000.09-2002.04	Saloon Engine Z22SE	•		GHA433004	
	2000.09-2002.04	Saloon Engine Z22SE	•		GWB3410	
	2000.09-2002.04	Saloon Engine Z22SE With ABS		○	GHA400052	K
2.5 (143 kW)	1998.05-2000.09	Saloon Engine X25XE	•		GWB3410	
	1998.05-2000.09	Saloon Engine X25XE With ABS		○	GHA400052	K
	1998.05-2000.09	Saloon Engine X25XE With ABS		○	GHA400064	K
2.5 i V6 (125 kW)	1995.10-2000.09	Saloon Engine X25XE	•		GHA433004	
	1995.10-2000.09	Saloon Engine X25XE	•		GWB3410	
	1995.10-2000.09	Saloon Engine X25XE With ABS		○	GHA400052	K
	1995.10-2000.09	Saloon Engine X25XE With ABS		○	GHA400064	K
2.6 i V6 (125 kW)	2000.09-2002.04	Saloon Engine Y26SE	•		GHA433004	
	2000.09-2002.04	Saloon Engine Y26SE	•		GWB3410	
	2000.09-2002.04	Saloon Engine Y26SE With ABS		○	GHA400052	K
VECTRA B (38_)						
1.6 i (55 kW)	1995.10-2003.07	Hatchback Engine 16LZ2	•		GHA433004	
	1995.10-2003.07	Hatchback Engine 16LZ2	•		GHA433019	



	 YEAR		F	R	G-AP Ref.	KIT
OPEL						
VECTRA B (38_)						
1.6 i (55 kW)	1995.10-2003.07	Hatchback Engine 16LZ2	•		GWB3410	
	1995.10-2003.07	Hatchback Engine 16LZ2 With ABS		○	GHA400052	K
	1995.10-2003.07	Hatchback Engine 16LZ2 With ABS		○	GHA400064	K
	1995.10-2003.07	Hatchback Engine X16SZR	•		GHA422023	
	1995.10-2003.07	Hatchback Engine X16SZR	•		GHA433004	
	1995.10-2003.07	Hatchback Engine X16SZR	•		GHA433019	
	1995.10-2003.07	Hatchback Engine X16SZR	•		GWB3410	
	1995.10-2003.07	Hatchback Engine X16SZR With ABS		○	GHA400052	K
	1995.10-2003.07	Hatchback Engine X16SZR With ABS		○	GHA400064	K
1.6 i 16V (74 kW)	1995.10-2002.07	Hatchback Engine X16XEL/Y16XE/Z16XE	•		GHA422023	
	1995.10-2002.07	Hatchback Engine X16XEL/Y16XE/Z16XE	•		GHA433004	
	1995.10-2002.07	Hatchback Engine X16XEL/Y16XE/Z16XE	•		GHA433019	
	1995.10-2002.07	Hatchback Engine X16XEL/Y16XE/Z16XE	•		GWB3410	
	1995.10-2002.07	Hatchback Engine X16XEL/Y16XE/Z16XE With ABS		○	GHA400052	K
	1995.10-2002.07	Hatchback Engine X16XEL/Y16XE/Z16XE With ABS		○	GHA400064	K
1.7 TD (60 kW)	1995.10-1998.12	Hatchback Engine X17DT(TC4EE1)	•		GHA433004	
	1995.10-1998.12	Hatchback Engine X17DT(TC4EE1)	•		GHA433019	
	1995.10-1998.12	Hatchback Engine X17DT(TC4EE1)	•		GWB3410	
	1995.10-1998.12	Hatchback Engine X17DT(TC4EE1) With ABS		○	GHA400064	K
1.8 i 16V (85 kW)	1995.10-2000.09	Hatchback Engine X18XE	•		GHA433004	
	1995.10-2000.09	Hatchback Engine X18XE	•		GHA433019	
	1995.10-2000.09	Hatchback Engine X18XE	•		GWB3410	
	1995.10-2000.09	Hatchback Engine X18XE With ABS		○	GHA400052	K
	1995.10-2000.09	Hatchback Engine X18XE With ABS		○	GHA400064	K
	1995.10-2000.09	Hatchback Engine X18XE1/Z18XEL	•		GHA433004	
	1995.10-2000.09	Hatchback Engine X18XE1/Z18XEL	•		GHA433019	
	1995.10-2000.09	Hatchback Engine X18XE1/Z18XEL	•		GWB3410	
	1995.10-2000.09	Hatchback Engine X18XE1/Z18XEL With ABS		○	GHA400052	K
1.8 i 16V (92 kW)	1995.10-2000.09	Hatchback Engine X18XE1/Z18XEL With ABS		○	GHA400064	K
	2000.09-2003.07	Hatchback Engine Z18XE	•		GHA433004	
	2000.09-2003.07	Hatchback Engine Z18XE	•		GHA433019	
	2000.09-2003.07	Hatchback Engine Z18XE	•		GWB3410	
	2000.09-2003.07	Hatchback Engine Z18XE With ABS		○	GHA400052	K
	2000.09-2003.07	Hatchback Engine Z18XE With ABS		○	GHA400064	K
2.0 Di 16V (60 kW)	1996.11-2000.06	Hatchback Engine X20DTL	•		GHA433004	
	1996.11-2000.06	Hatchback Engine X20DTL	•		GHA433019	
	1996.11-2000.06	Hatchback Engine X20DTL	•		GWB3410	
	1996.11-2000.06	Hatchback Engine X20DTL With ABS		○	GHA400052	K
	1996.11-2000.06	Hatchback Engine X20DTL With ABS		○	GHA400064	K
	1996.11-2000.06	Hatchback Engine X20DTL With ABS		○	GHA400064	K
2.0 DTi 16V (74 kW)	1997.06-2003.07	Hatchback Engine X20DTH/Y20DTH	•		GHA433004	
	1997.06-2003.07	Hatchback Engine X20DTH/Y20DTH	•		GHA433019	
	1997.06-2003.07	Hatchback Engine X20DTH/Y20DTH	•		GWB3410	
	1997.06-2003.07	Hatchback Engine X20DTH/Y20DTH With ABS		○	GHA400052	K
	1997.06-2003.07	Hatchback Engine X20DTH/Y20DTH With ABS		○	GHA400064	K
2.0 i (82 kW)	1995.10-2002.02	Hatchback Engine 20NEJ	•		GHA433004	
	1995.10-2002.02	Hatchback Engine 20NEJ	•		GHA433019	
	1995.10-2002.02	Hatchback Engine 20NEJ	•		GWB3410	
	1995.10-2002.02	Hatchback Engine 20NEJ With ABS		○	GHA400052	K
	1995.10-2002.02	Hatchback Engine 20NEJ With ABS		○	GHA400064	K
	1995.10-2002.02	Hatchback Engine 20NEJ With ABS		○	GHA400064	K
2.0 i 16V (100 kW)	1995.10-2000.09	Hatchback Engine X20XEV	•		GHA433004	
	1995.10-2000.09	Hatchback Engine X20XEV	•		GWB3410	
	1995.10-2000.09	Hatchback Engine X20XEV With ABS		○	GHA400052	K
	1995.10-2000.09	Hatchback Engine X20XEV With ABS		○	GHA400064	K
2.2 DTi 16V (88 kW)	2000.09-2002.04	Hatchback Engine Y22DTR	•		GHA433004	
	2000.09-2002.04	Hatchback Engine Y22DTR	•		GWB3410	
	2000.09-2002.04	Hatchback Engine Y22DTR With ABS		○	GHA400052	K
2.2 DTi 16V (92 kW)	2000.09-2003.07	Hatchback Engine Y22DTR	•		GHA433004	
	2000.09-2003.07	Hatchback Engine Y22DTR	•		GWB3410	
	2000.09-2003.07	Hatchback Engine Y22DTR With ABS		○	GHA400052	K
	2000.09-2003.07	Hatchback Engine Y22DTR With ABS		○	GHA400052	K
2.2 i 16V (108 kW)	2000.09-2003.07	Hatchback Engine Z22SE	•		GHA433004	
	2000.09-2003.07	Hatchback Engine Z22SE	•		GWB3410	
	2000.09-2003.07	Hatchback Engine Z22SE With ABS		○	GHA400052	K
2.5 (144 kW)	1999.10-2000.06	Hatchback Engine X25XE	•		GHA433004	
	1999.10-2000.06	Hatchback Engine X25XE	•		GWB3410	



	 YEAR		F	R	G-AP Ref.	KIT
OPEL						
VECTRA B (38_)						
2.5 (144 kW)	1999.10-2000.06	Hatchback Engine X25XE With ABS		o	GHA400052	K
	1999.10-2000.06	Hatchback Engine X25XE With ABS		o	GHA400064	K
2.5 i V6 (125 kW)	1995.10-2000.09	Hatchback Engine X25XE	•		GHA433004	
	1995.10-2000.09	Hatchback Engine X25XE	•		GWB3410	
	1995.10-2000.09	Hatchback Engine X25XE With ABS		o	GHA400052	K
	1995.10-2000.09	Hatchback Engine X25XE With ABS		o	GHA400064	K
2.6 i V6 (125 kW)	2000.09-2003.07	Hatchback Engine Y26SE	•		GHA433004	
	2000.09-2003.07	Hatchback Engine Y26SE	•		GWB3410	
	2000.09-2003.07	Hatchback Engine Y26SE With ABS		o	GHA400052	K
VECTRA C						
1.6 (77 kW)	2006.01-	Estate Engine Z16XEP	•		GHA330021	K
	2006.01-	Estate Engine Z16XEP		o	GHA400137	K
	2006.01-	Saloon Engine Z16XEP	•		GHA330021	K
	2006.01-	Saloon Engine Z16XEP		o	GHA400137	K
1.6 16V (74 kW)	2004.06-	Estate Engine Z16XE	•		GHA330011	K
	2004.06-	Estate Engine Z16XE	•		GHA330021	K
	2004.06-	Estate Engine Z16XE		o	GHA400137	K
	2004.06-	Saloon Engine Z16XE	•		GHA330011	K
	2004.06-	Saloon Engine Z16XE	•		GHA330021	K
	2004.06-	Saloon Engine Z16XE		o	GHA400137	K
1.8 (103 kW)	2006.01-	Estate Engine Z18XER	•		GHA330021	K
	2006.01-	Estate Engine Z18XER		o	GHA400137	K
	2006.01-	Saloon Engine Z18XER	•		GHA330021	K
	2006.01-	Saloon Engine Z18XER		o	GHA400137	K
1.8 (81 kW)	2002.04-	Saloon Engine Z18XEL	•		GHA330011	K
	2002.04-	Saloon Engine Z18XEL	•		GHA330021	K
	2002.04-	Saloon Engine Z18XEL		o	GHA400137	K
1.8 (90 kW)	2003.10-	Estate Engine Z18XE	•		GHA330011	K
	2003.10-	Estate Engine Z18XE	•		GHA330021	K
	2003.10-	Estate Engine Z18XE		o	GHA400137	K
1.8 16V (90 kW)	2002.04-	Saloon Engine Z18XE	•		GHA330011	K
	2002.04-	Saloon Engine Z18XE	•		GHA330021	K
	2002.04-	Saloon Engine Z18XE		o	GHA400137	K
1.9 CDTi (110 kW)	2004.04-	Estate Engine Z19DTH	•		GHA330011	K
	2004.04-	Estate Engine Z19DTH	•		GHA330021	K
	2004.04-	Estate Engine Z19DTH		o	GHA400137	K
	2004.04-	Saloon Engine Z19DTH	•		GHA330011	K
	2004.04-	Saloon Engine Z19DTH	•		GHA330021	K
	2004.04-	Saloon Engine Z19DTH		o	GHA400137	K
1.9 CDTi (74 kW)	2005.10-	Estate Engine Z19DTL	•		GHA330021	K
	2005.10-	Estate Engine Z19DTL		o	GHA400137	K
	2005.10-	Saloon Engine Z19DT	•		GHA330021	K
	2005.10-	Saloon Engine Z19DT		o	GHA400137	K
1.9 CDTi (88 kW)	2004.04-	Estate Engine Z19DT	•		GHA330011	K
	2004.04-	Estate Engine Z19DT	•		GHA330021	K
	2004.04-	Estate Engine Z19DT		o	GHA400137	K
	2004.04-	Saloon Engine Z19DT	•		GHA330011	K
	2004.04-	Saloon Engine Z19DT	•		GHA330021	K
	2004.04-	Saloon Engine Z19DT		o	GHA400137	K
2.0 16V Turbo (129 kW)	2003.05-2005.08	Saloon Engine Z20NET	•		GHA330011	K
	2003.05-2005.08	Saloon Engine Z20NET	•		GHA330021	K
	2003.05-2005.08	Saloon Engine Z20NET		o	GHA400137	K
2.0 DTi (74 kW)	2003.10-	Estate Engine Y20DTH	•		GHA330011	K
	2003.10-	Estate Engine Y20DTH	•		GHA330021	K
	2003.10-	Estate Engine Y20DTH		o	GHA400137	K
2.0 DTi 16V (74 kW)	2002.04-	Saloon Engine Y20DTH	•		GHA330011	K
	2002.04-	Saloon Engine Y20DTH	•		GHA330021	K
	2002.04-	Saloon Engine Y20DTH		o	GHA400137	K
2.0 Turbo (129 kW)	2003.10-	Estate Engine Z20NET	•		GHA330011	K
	2003.10-	Estate Engine Z20NET	•		GHA330021	K
	2003.10-	Estate Engine Z20NET		o	GHA400137	K
2.2 16V (108 kW)	2002.04-	Saloon Engine Z22SE	•		GHA330011	K
	2002.04-	Saloon Engine Z22SE	•		GHA330021	K
	2002.04-	Saloon Engine Z22SE		o	GHA400137	K



	 YEAR		F	R	G-AP Ref.	KIT
OPEL						
VECTRA C						
2.2 Direct (114 kW)	2003.10-	Estate Engine Z22YH	•		GHA330011	K
	2003.10-	Estate Engine Z22YH	•		GHA330021	K
	2003.10-	Estate Engine Z22YH		◦	GHA400137	K
	2003.10-	Saloon Engine Z22YH	•		GHA330011	K
	2003.10-	Saloon Engine Z22YH	•		GHA330021	K
	2003.10-	Saloon Engine Z22YH		◦	GHA400137	K
2.2 DTi (86 kW)	2003.10-2008.06	Estate Engine Y 22 DTR	•		GHA330011	K
	2003.10-2008.06	Estate Engine Y 22 DTR	•		GHA330021	K
	2003.10-2008.06	Estate Engine Y 22 DTR		◦	GHA400137	K
2.2 DTi (92 kW)	2003.10-	Estate Engine Y22DTR	•		GHA330011	K
	2003.10-	Estate Engine Y22DTR	•		GHA330021	K
	2003.10-	Estate Engine Y22DTR		◦	GHA400137	K
2.2 DTi 16V (86 kW)	2002.04-2004.12	Saloon Engine Y22DTR	•		GHA330011	K
	2002.04-2004.12	Saloon Engine Y22DTR	•		GHA330021	K
	2002.04-2004.12	Saloon Engine Y22DTR		◦	GHA400137	K
2.2 DTi 16V (92 kW)	2002.04-	Saloon Engine Y22DTR	•		GHA330011	K
	2002.04-	Saloon Engine Y22DTR	•		GHA330021	K
	2002.04-	Saloon Engine Y22DTR		◦	GHA400137	K
2.8 V6 Turbo (169 kW)	2005.07-2007.01	Saloon Engine Z28NEL	•		GHA330021	K
	2005.07-2007.01	Saloon Engine Z28NEL		◦	GHA400137	K
	2005.08-	Estate Engine Z28NEL	•		GHA330021	K
	2005.08-	Estate Engine Z28NEL		◦	GHA400137	K
2.8 V6 Turbo (184 kW)	2006.11-2008.03	Saloon Engine Z28NET	•		GHA330021	K
	2006.11-2008.03	Saloon Engine Z28NET		◦	GHA400137	K
	2007.01-	Estate Engine Z28NET	•		GHA330021	K
	2007.01-	Estate Engine Z28NET		◦	GHA400137	K
2.8 V6 Turbo (188 kW)	2005.08-	Estate Engine Z28NET	•		GHA330021	K
	2005.08-	Estate Engine Z28NET		◦	GHA400137	K
	2005.08-2007.01	Saloon Engine Z28NET	•		GHA330021	K
	2005.08-2007.01	Saloon Engine Z28NET		◦	GHA400137	K
2.8 V6 Turbo (206 kW)	2007.01-	Estate Engine Z28NET	•		GHA330021	K
	2007.01-	Estate Engine Z28NET		◦	GHA400137	K
2.8 V6 Turbo OPC (206 kW)	2006.09-2008.09	Saloon Engine Z 28 NET	•		GHA330021	K
	2006.09-2008.09	Saloon Engine Z 28 NET		◦	GHA400137	K
3.0 CDTi (130 kW)	2003.06-	Saloon Engine Y30DT	•		GHA330011	K
	2003.06-	Saloon Engine Y30DT	•		GHA330021	K
	2003.06-	Saloon Engine Y30DT		◦	GHA400137	K
3.0 CDTi (135 kW)	2005.08-	Saloon Engine Z30DT	•		GHA330021	K
	2005.08-	Saloon Engine Z30DT		◦	GHA400137	K
3.0 V6 CDTi (130 kW)	2003.10-	Estate Engine Y30DT	•		GHA330011	K
	2003.10-	Estate Engine Y30DT	•		GHA330021	K
	2003.10-	Estate Engine Y30DT		◦	GHA400137	K
3.0 V6 CDTi (135 kW)	2005.08-	Estate Engine Z30DT	•		GHA330021	K
	2005.08-	Estate Engine Z30DT		◦	GHA400137	K
3.2 V6 (155 kW)	2002.08-	Saloon Engine Z32SE	•		GHA330011	K
	2002.08-	Saloon Engine Z32SE	•		GHA330021	K
	2002.08-	Saloon Engine Z32SE		◦	GHA400137	K
	2003.10-	Estate Engine Z32SE	•		GHA330011	K
	2003.10-	Estate Engine Z32SE	•		GHA330021	K
	2003.10-	Estate Engine Z32SE		◦	GHA400137	K
VECTRA C GTS						
1.6 (74 kW)	2005.08-	Hatchback Engine Z16XE	•		GHA330021	K
	2005.08-	Hatchback Engine Z16XE		◦	GHA400137	K
1.6 (77 kW)	2006.01-	Hatchback Engine Z16XEP	•		GHA330021	K
	2006.01-	Hatchback Engine Z16XEP		◦	GHA400137	K
1.8 (103 kW)	2006.01-	Hatchback Engine Z18XER	•		GHA330021	K
	2006.01-	Hatchback Engine Z18XER		◦	GHA400137	K
1.8 16V (81 kW)	2002.08-2006.12	Hatchback Engine Z18XEL	•		GHA330011	K
	2002.08-2006.12	Hatchback Engine Z18XEL	•		GHA330021	K
	2002.08-2006.12	Hatchback Engine Z18XEL		◦	GHA400137	K
1.8 16V (90 kW)	2002.08-	Hatchback Engine Z18XE	•		GHA330011	K
	2002.08-	Hatchback Engine Z18XE	•		GHA330021	K
	2002.08-	Hatchback Engine Z18XE		◦	GHA400137	K
1.9 CDTi (110 kW)	2004.04-	Hatchback Engine Z19DTH	•		GHA330011	K



	 YEAR		F	R	G-AP Ref.	KIT
OPEL						
VECTRA C GTS						
1.9 CDTi (110 kW)	2004.04-	Hatchback Engine Z19DTH	•		GHA330021	K
	2004.04-	Hatchback Engine Z19DTH		◦	GHA400137	K
1.9 CDTi (74 kW)	2005.10-	Hatchback Engine Z19DTL	•		GHA330021	K
	2005.10-	Hatchback Engine Z19DTL		◦	GHA400137	K
1.9 CDTi (88 kW)	2004.04-	Hatchback Engine Z19DT	•		GHA330011	K
	2004.04-	Hatchback Engine Z19DT	•		GHA330021	K
	2004.04-	Hatchback Engine Z19DT		◦	GHA400137	K
2.0 16V Turbo (129 kW)	2003.03-	Hatchback Engine Z20NET	•		GHA330011	K
	2003.03-	Hatchback Engine Z20NET	•		GHA330021	K
	2003.03-	Hatchback Engine Z20NET		◦	GHA400137	K
2.0 DTi 16V (74 kW)	2002.08-	Hatchback Engine Y20DTH	•		GHA330011	K
	2002.08-	Hatchback Engine Y20DTH	•		GHA330021	K
	2002.08-	Hatchback Engine Y20DTH		◦	GHA400137	K
2.2 16V (108 kW)	2002.08-	Hatchback Engine Z22SE	•		GHA330011	K
	2002.08-	Hatchback Engine Z22SE	•		GHA330021	K
	2002.08-	Hatchback Engine Z22SE		◦	GHA400137	K
2.2 Direct (114 kW)	2003.10-	Hatchback Engine Z22YH	•		GHA330011	K
	2003.10-	Hatchback Engine Z22YH	•		GHA330021	K
	2003.10-	Hatchback Engine Z22YH		◦	GHA400137	K
2.2 DTi 16V (86 kW)	2002.08-2008.06	Hatchback Engine Y22DTR	•		GHA330011	K
	2002.08-2008.06	Hatchback Engine Y22DTR	•		GHA330021	K
	2002.08-2008.06	Hatchback Engine Y22DTR		◦	GHA400137	K
2.2 DTi 16V (92 kW)	2002.08-	Hatchback Engine Y22DTR	•		GHA330011	K
	2002.08-	Hatchback Engine Y22DTR	•		GHA330021	K
	2002.08-	Hatchback Engine Y22DTR		◦	GHA400137	K
2.8 V6 Turbo (169 kW)	2005.08-	Hatchback Engine Z28NEL	•		GHA330021	K
	2005.08-	Hatchback Engine Z28NEL		◦	GHA400137	K
2.8 V6 Turbo (184 kW)	2006.08-	Hatchback Engine Z28NET	•		GHA330021	K
	2006.08-	Hatchback Engine Z28NET		◦	GHA400137	K
2.8 V6 Turbo (188 kW)	2005.08-	Hatchback Engine Z28NET	•		GHA330021	K
	2005.08-	Hatchback Engine Z28NET		◦	GHA400137	K
2.8 V6 Turbo (206 kW)	2006.10-2008.03	Hatchback Engine Z28NET	•		GHA330021	K
	2006.10-2008.03	Hatchback Engine Z28NET		◦	GHA400137	K
3.0 CDTi (130 kW)	2003.06-	Hatchback Engine Y30DT	•		GHA330011	K
	2003.06-	Hatchback Engine Y30DT	•		GHA330021	K
	2003.06-	Hatchback Engine Y30DT		◦	GHA400137	K
3.0 CDTi (135 kW)	2005.08-	Hatchback Engine Z30DT	•		GHA330021	K
	2005.08-	Hatchback Engine Z30DT		◦	GHA400137	K
3.2 V6 (155 kW)	2002.08-	Hatchback Engine Z32SE	•		GHA330011	K
	2002.08-	Hatchback Engine Z32SE	•		GHA330021	K
	2002.08-	Hatchback Engine Z32SE		◦	GHA400137	K
VIVARO (E7)						
1.9 Di (60 kW)	2006.08-	Platform/Chassis Engine F9Q762	•		GWB3648	
	2006.08-	Platform/Chassis Engine F9Q762		◦	GWB3617	
1.9 DTi (74 kW)	2006.08-	Platform/Chassis Engine F9Q760	•		GWB3648	
	2006.08-	Platform/Chassis Engine F9Q760		◦	GWB3617	
2.0 16V (88 kW)	2006.08-	Platform/Chassis Engine F4R720	•		GWB3648	
	2006.08-	Platform/Chassis Engine F4R720		◦	GWB3617	
2.0 CDTi (66 kW)	2006.01-	Platform/Chassis Engine M9R782	•		GWB3648	
	2006.01-	Platform/Chassis Engine M9R782		◦	GHA235025	
	2006.01-	Platform/Chassis Engine M9R782		◦	GWB3617	
2.0 CDTi (84 kW)	2006.08-	Platform/Chassis Engine M9R780	•		GWB3648	
	2006.08-	Platform/Chassis Engine M9R780		◦	GHA235025	
	2006.08-	Platform/Chassis Engine M9R780		◦	GWB3617	
2.0 EcoTec (86 kW)	2006.08-	Platform/Chassis Engine F4R820	•		GWB3648	
	2006.08-	Platform/Chassis Engine F4R820		◦	GWB3617	
2.5 CDTi (107 kW)	2006.08-	Platform/Chassis Engine G9U630	•		GWB3648	
	2006.08-	Platform/Chassis Engine G9U630		◦	GHA235025	
	2006.08-	Platform/Chassis Engine G9U630		◦	GWB3617	
2.5 CDTi (84 kW)	2006.08-	Platform/Chassis Engine G9U630	•		GWB3648	
	2006.08-	Platform/Chassis Engine G9U630		◦	GWB3617	
2.5 DTi (99 kW)	2006.08-	Platform/Chassis Engine G9U730	•		GWB3648	
	2006.08-	Platform/Chassis Engine G9U730		◦	GWB3617	



	 YEAR		F	R	G-AP Ref.	KIT
OPEL						
VIVARO (F7)						
1.9 Di (60 kW)	2001.08-	Box Engine F9Q762	•		GWB3616	
	2001.08-	Box Engine F9Q762	•		GWB3618	
	2001.08-	Box Engine F9Q762	•		GWB3648	
	2001.08-	Box Engine F9Q762		○	GHA235025	
	2001.08-	Box Engine F9Q762		○	GWB3617	
1.9 DTi (74 kW)	2001.08-	Box Engine F9Q760	•		GWB3616	
	2001.08-	Box Engine F9Q760	•		GWB3618	
	2001.08-	Box Engine F9Q760	•		GWB3648	
	2001.08-	Box Engine F9Q760		○	GHA235025	
	2001.08-	Box Engine F9Q760		○	GWB3617	
2.0 16V (88 kW)	2001.08-	Box Engine F4R720	•		GWB3616	
	2001.08-	Box Engine F4R720	•		GWB3618	
	2001.08-	Box Engine F4R720	•		GWB3648	
	2001.08-	Box Engine F4R720		○	GHA235025	
	2001.08-	Box Engine F4R720		○	GWB3617	
2.0 CDTi (66 kW)	2006.08-	Box Engine M9R630/M9R780/M9R782/M9R786	•		GWB3648	
	2006.08-	Box Engine M9R630/M9R780/M9R782/M9R786		○	GHA235025	
	2006.08-	Box Engine M9R630/M9R780/M9R782/M9R786		○	GWB3617	
2.0 CDTi (84 kW)	2006.08-	Box Engine M9R692/M9R780/M9R784/M9R786/M9R788	•		GWB3648	
	2006.08-	Box Engine M9R692/M9R780/M9R784/M9R786/M9R788		○	GHA235025	
	2006.08-	Box Engine M9R692/M9R780/M9R784/M9R786/M9R788		○	GWB3617	
2.0 EcoTec (86 kW)	2006.08-	Box Engine F4R820	•		GWB3648	
	2006.08-	Box Engine F4R820		○	GHA235025	
	2006.08-	Box Engine F4R820		○	GWB3617	
2.5 CDTi (107 kW)	2006.08-	Box Engine G9MB6/G9U630	•		GWB3648	
	2006.08-	Box Engine G9MB6/G9U630		○	GHA235025	
	2006.08-	Box Engine G9MB6/G9U630		○	GWB3617	
2.5 CDTi (84 kW)	2006.08-	Box Engine G9U630	•		GWB3648	
	2006.08-	Box Engine G9U630		○	GWB3617	
2.5 DTi (99 kW)	2003.05-	Box Engine G9U730	•		GWB3616	
	2003.05-	Box Engine G9U730	•		GWB3618	
	2003.05-	Box Engine G9U730	•		GWB3648	
	2003.05-	Box Engine G9U730		○	GHA235025	
	2003.05-	Box Engine G9U730		○	GWB3617	
VIVARO (J7)						
1.9 Di (60 kW)	2001.08-	Bus Engine F9Q762/F9Q774	•		GWB3616	
	2001.08-	Bus Engine F9Q762/F9Q774	•		GWB3618	
	2001.08-	Bus Engine F9Q762/F9Q774	•		GWB3648	
	2001.08-	Bus Engine F9Q762/F9Q774		○	GHA235025	
	2001.08-	Bus Engine F9Q762/F9Q774		○	GWB3617	
1.9 DTi (74 kW)	2001.08-	Bus Engine F9Q760	•		GWB3616	
	2001.08-	Bus Engine F9Q760	•		GWB3618	
	2001.08-	Bus Engine F9Q760	•		GWB3648	
	2001.08-	Bus Engine F9Q760		○	GHA235025	
	2001.08-	Bus Engine F9Q760		○	GWB3617	
2.0 16V (88 kW)	2001.08-	Bus Engine F4R720	•		GWB3616	
	2001.08-	Bus Engine F4R720	•		GWB3618	
	2001.08-	Bus Engine F4R720	•		GWB3648	
	2001.08-	Bus Engine F4R720		○	GHA235025	
	2001.08-	Bus Engine F4R720		○	GWB3617	
2.0 CDTi (66 kW)	2006.08-	Bus Engine M9R780/M9R782/M9R786	•		GWB3648	
	2006.08-	Bus Engine M9R780/M9R782/M9R786		○	GHA235025	
	2006.08-	Bus Engine M9R780/M9R782/M9R786		○	GWB3617	
2.0 CDTi (84 kW)	2006.08-	Bus Engine M9R780/M9R784/M9R786/M9R788/M9R630/M9R692	•		GWB3648	
	2006.08-	Bus Engine M9R780/M9R784/M9R786/M9R788/M9R630/M9R692		○	GHA235025	
	2006.08-	Bus Engine M9R780/M9R784/M9R786/M9R788/M9R630/M9R692		○	GWB3617	
2.0 EcoTec (86 kW)	2006.08-	Bus Engine F4R820	•		GWB3648	
	2006.08-	Bus Engine F4R820		○	GHA235025	
	2006.08-	Bus Engine F4R820		○	GWB3617	
2.5 CDTi (107 kW)	2006.08-	Bus Engine G9U630	•		GWB3648	
	2006.08-	Bus Engine G9U630		○	GHA235025	
	2006.08-	Bus Engine G9U630		○	GWB3617	
2.5 CDTi (84 kW)	2006.08-	Bus Engine G9U630	•		GWB3648	
	2006.08-	Bus Engine G9U630		○	GWB3617	



	 YEAR		F	R	G-AP Ref.	KIT
OPEL						
VIVARO (J7)						
2.5 DTi (99 kW)	2003.05-	Bus Engine G9U730	•		GWB3616	
	2003.05-	Bus Engine G9U730	•		GWB3618	
	2003.05-	Bus Engine G9U730	•		GWB3648	
	2003.05-	Bus Engine G9U730		○	GHA235025	
	2003.05-	Bus Engine G9U730		○	GWB3617	
ZAFIRA A (F75_)						
1.6 16V (74 kW)	1999.04-2005.06	MPV Engine X16XEL/Z16XE	•		GHA333102	K
	1999.04-2005.06	MPV Engine X16XEL/Z16XE With ABS	•		GHA333029	K
	1999.04-2005.06	MPV Engine X16XEL/Z16XE With ABS		○	GHA400052	K
	1999.04-2005.06	MPV Engine X16XEL/Z16XE Without ABS		○	GHA400053	K
1.6 CNG (71 kW)	2001.09-2005.06	MPV Engine Z16YNG	•		GHA333102	K
	2001.09-2005.06	MPV Engine Z16YNG With ABS	•		GHA333029	K
	2001.09-2005.06	MPV Engine Z16YNG With ABS		○	GHA400052	K
	2001.09-2005.06	MPV Engine Z16YNG Without ABS		○	GHA400053	K
1.8 16V (85 kW)	1999.04-2000.09	MPV Engine X18XE1	•		GHA333102	K
	1999.04-2000.09	MPV Engine X18XE1 With ABS	•		GHA333029	K
	1999.04-2000.09	MPV Engine X18XE1 With ABS		○	GHA400052	K
	1999.04-2000.09	MPV Engine X18XE1 Without ABS		○	GHA400053	K
1.8 16V (92 kW)	2000.09-2005.06	MPV Engine Z18XE	•		GHA333102	K
	2000.09-2005.06	MPV Engine Z18XE With ABS	•		GHA333029	K
	2000.09-2005.06	MPV Engine Z18XE With ABS		○	GHA400052	K
	2000.09-2005.06	MPV Engine Z18XE Without ABS		○	GHA400053	K
2.0 Di 16V (60 kW)	1999.10-2005.06	MPV Engine X20DTL	•		GHA333102	K
	1999.10-2005.06	MPV Engine X20DTL With ABS	•		GHA333029	K
	1999.10-2005.06	MPV Engine X20DTL With ABS		○	GHA400052	K
	1999.10-2005.06	MPV Engine X20DTL Without ABS		○	GHA400053	K
2.0 DTi (63 kW)	2003.11-2005.06	MPV Engine Y20DTL	•		GHA333102	K
	2003.11-2005.06	MPV Engine Y20DTL With ABS	•		GHA333029	K
	2003.11-2005.06	MPV Engine Y20DTL With ABS		○	GHA400052	K
	2003.11-2005.06	MPV Engine Y20DTL Without ABS		○	GHA400053	K
2.0 DTi 16V (74 kW)	2000.09-2005.06	MPV Engine Y20DTH	•		GHA333102	K
	2000.09-2005.06	MPV Engine Y20DTH With ABS	•		GHA333029	K
	2000.09-2005.06	MPV Engine Y20DTH With ABS		○	GHA400052	K
	2000.09-2005.06	MPV Engine Y20DTH Without ABS		○	GHA400053	K
2.0 OPC (141 kW)	2001.09-2005.06	MPV Engine Z20LET	•		GHA333102	K
	2001.09-2005.06	MPV Engine Z20LET With ABS	•		GHA333029	K
	2001.09-2005.06	MPV Engine Z20LET With ABS		○	GHA400052	K
	2001.09-2005.06	MPV Engine Z20LET Without ABS		○	GHA400053	K
2.0 OPC (147 kW)	2002.11-2005.06	MPV Engine Z20LER/Z20LET	•		GHA333102	K
	2002.11-2005.06	MPV Engine Z20LER/Z20LET With ABS	•		GHA333029	K
	2002.11-2005.06	MPV Engine Z20LER/Z20LET With ABS		○	GHA400052	K
	2002.11-2005.06	MPV Engine Z20LER/Z20LET Without ABS		○	GHA400053	K
2.2 16V (108 kW)	2000.09-2005.06	MPV Engine Z22SE	•		GHA333102	K
	2000.09-2005.06	MPV Engine Z22SE With ABS	•		GHA333029	K
	2000.09-2005.06	MPV Engine Z22SE With ABS		○	GHA400052	K
	2000.09-2005.06	MPV Engine Z22SE Without ABS		○	GHA400053	K
2.2 DTi 16V (86 kW)	2002.01-2005.06	MPV Engine Y22DTR	•		GHA333102	K
	2002.01-2005.06	MPV Engine Y22DTR With ABS	•		GHA333029	K
	2002.01-2005.06	MPV Engine Y22DTR With ABS		○	GHA400052	K
	2002.01-2005.06	MPV Engine Y22DTR Without ABS		○	GHA400053	K
2.2 DTi 16V (92 kW)	2002.01-2005.06	MPV Engine Y22DTR	•		GHA333102	K
	2002.01-2005.06	MPV Engine Y22DTR With ABS	•		GHA333029	K
	2002.01-2005.06	MPV Engine Y22DTR With ABS		○	GHA400052	K
	2002.01-2005.06	MPV Engine Y22DTR Without ABS		○	GHA400053	K
ZAFIRA B (A05)						
1.6 (77 kW)	2005.07-	MPV Engine Z16XE1/Z16XEP	•		GHA333070	K
	2005.07-	MPV Engine Z16XE1/Z16XEP		○	GHA400133	K
1.6 (85 kW)	2008.01-	MPV Engine A16XER/Z16XER	•		GHA333070	K
	2008.01-	MPV Engine A16XER/Z16XER		○	GHA400133	K
1.6 CNG (69 kW)	2006.01-	MPV Engine Z16YNG	•		GHA333070	K
	2006.01-	MPV Engine Z16YNG	•		GHA333097	K
	2006.01-	MPV Engine Z16YNG		○	GHA400338	K
1.6 CNG Turbo (110 kW)	2009.02-	MPV Engine A16XNT/Z16XNT	•		GHA333097	K
	2009.02-	MPV Engine A16XNT/Z16XNT		○	GHA400338	K



	 YEAR		F	R	G-AP Ref.	KIT
OPEL						
ZAFIRA B (A05)						
1.7 CDTi (81 kW)	2008.01-	MPV Engine A17DTJ/Z17DTJ	•		GHA333097	K
	2008.01-	MPV Engine A17DTJ/Z17DTJ		◦	GHA400133	K
1.7 CDTi (92 kW)	2008.01-	MPV Engine A17DTR	•		GHA333097	K
	2008.01-	MPV Engine A17DTR		◦	GHA400133	K
1.8 (103 kW)	2005.09-2008.03	MPV Engine A18XER/Z18XER	•		GHA333070	K
	2005.09-2008.03	MPV Engine A18XER/Z18XER		◦	GHA400133	K
1.8 (88 kW)	2013.06-	MPV Engine A 18 XEL	•		GHA333070	K
	2013.06-	MPV Engine A 18 XEL		◦	GHA400133	K
1.9 CDTi (110 kW)	2005.07-	MPV Engine Z19DTH	•		GHA3330013	K
	2005.07-	MPV Engine Z19DTH		◦	GHA400133	K
1.9 CDTi (74 kW)	2005.07-	MPV Engine Z19DTL	•		GHA333070	K
	2005.07-	MPV Engine Z19DTL	•		GHA333097	K
	2005.07-	MPV Engine Z19DTL		◦	GHA400133	K
1.9 CDTi (88 kW)	2005.07-	MPV Engine Z19DT	•		GHA333070	K
	2005.07-	MPV Engine Z19DT	•		GHA333097	K
	2005.07-	MPV Engine Z19DT		◦	GHA400133	K
2.0 (147 kW)	2005.07-	MPV Engine Z20LER	•		GHA333070	K
	2005.07-	MPV Engine Z20LER	•		GHA333097	K
	2005.07-	MPV Engine Z20LER		◦	GHA400133	K
2.0 (177 kW)	2005.07-2008.03	MPV Engine Z20LEH	•		GHA3330013	K
	2005.07-2008.03	MPV Engine Z20LEH		◦	GHA400133	K
2.2 (110 kW)	2005.07-	MPV Engine Z22YH	•		GHA333070	K
	2005.07-	MPV Engine Z22YH	•		GHA333097	K
	2005.07-	MPV Engine Z22YH		◦	GHA400133	K
ZAFIRA B VAN						
1.6 CNG Turbo (110 kW)	2009.02-	Box Engine A16XNT/Z16XNT	•		GHA333097	K
1.7 CDTi (81 kW)	2008.01-	Box Engine A17DTJ/Z17DTJ	•		GHA333097	K
	2008.01-	Box Engine A17DTJ/Z17DTJ		◦	GHA400133	K
1.7 CDTi (92 kW)	2008.01-	Box Engine A17DTR	•		GHA333097	K
	2008.01-	Box Engine A17DTR		◦	GHA400133	K
1.8 (103 kW)	2005.07-	Box Engine A18XER/Z18XER	•		GHA333070	K
	2005.07-	Box Engine A18XER/Z18XER		◦	GHA400133	K
ZAFIRA TOURER C (P12)						
1.4 (103 kW)	2011.10-	MPV Engine A14NET	•		GHA3330019	K
	2011.10-	MPV Engine A14NET		◦	GHA400193	K
1.4 (88 kW)	2011.10-	MPV Engine A14NEL	•		GHA3330019	K
	2011.10-	MPV Engine A14NEL		◦	GHA400193	K
1.4 LPG (103 kW)	2011.10-	MPV Engine A14NET	•		GHA3330019	K
	2011.10-	MPV Engine A14NET		◦	GHA400193	K
1.6 CDTi (100 kW)	2013.02-	MPV Engine B 16 DTH	•		GHA3330019	K
1.6 CDTi (88 kW)	2014.07-	MPV Engine B 16 DTH	•		GHA3330019	K
1.6 CNG (110 kW)	2011.10-	MPV Engine A16XNT	•		GHA3330019	K
	2011.10-	MPV Engine A16XNT		◦	GHA400193	K
1.6 SiDi (125 kW)	2012.12-	MPV Engine A16XHT	•		GHA3330019	K
1.6 SiDi (147 kW)	2013.07-	MPV Engine A 16 SHT	•		GHA3330019	K
1.8 (103 kW)	2011.10-	MPV Engine A18XER	•		GHA3330019	K
	2011.10-	MPV Engine A18XER		◦	GHA400193	K
1.8 (85 kW)	2011.10-	MPV Engine A18XEL	•		GHA3330019	K
	2011.10-	MPV Engine A18XEL		◦	GHA400193	K
1.8 (88 kW)	2011.10-	MPV Engine A18XEI	•		GHA3330019	K
	2011.10-	MPV Engine A18XEI		◦	GHA400193	K
1.8 LPG (101 kW)	2011.10-	MPV Engine A14NET	•		GHA3330019	K
	2011.10-	MPV Engine A14NET		◦	GHA400193	K
2.0 BiTurbo CDTi (143 kW)	2013.01-	MPV Engine A20DTR	•		GHA3330019	K
2.0 CDTi (118 kW)	2011.10-	MPV Engine A20DTH	•		GHA3330019	K
	2011.10-	MPV Engine A20DTH		◦	GHA400193	K
2.0 CDTi (121 kW)	2011.10-	MPV Engine A20DTH	•		GHA3330019	K
	2011.10-	MPV Engine A20DTH		◦	GHA400193	K
2.0 CDTi (81 kW)	2011.10-	MPV Engine A20DTL	•		GHA3330019	K
	2011.10-	MPV Engine A20DTL		◦	GHA400193	K
2.0 CDTi (96 kW)	2011.10-	MPV Engine A20DT/Y20DTJ/Z20DTJ	•		GHA3330019	K
	2011.10-	MPV Engine A20DT/Y20DTJ/Z20DTJ		◦	GHA400193	K



	 YEAR		F	R	G-AP Ref.	KIT
PEUGEOT						
1007 (KM_)						
1.4 (54 kW)	2005.04-2007.06	Hatchback Engine KFV(TU3JP)	•		GHA421003	
	2005.04-2007.06	Hatchback Engine KFV(TU3JP)	•		GWB3657	
	2005.04-2007.06	Hatchback Engine KFV(TU3JP)		◦	GHA225011	K
	2005.04-2007.06	Hatchback Engine KFV(TU3JP)		◦	GWB3658	
1.4 16V (65 kW)	2006.03-2007.06	Hatchback Engine KFU(ET3J4)	•		GHA421003	
	2006.03-2007.06	Hatchback Engine KFU(ET3J4)	•		GWB3657	
	2006.03-2007.06	Hatchback Engine KFU(ET3J4)		◦	GHA225011	K
	2006.03-2007.06	Hatchback Engine KFU(ET3J4)		◦	GWB3658	
1.4 HDi (50 kW)	2005.04-2007.06	Hatchback Engine 8HX(DV4TD)/8HZ(DV4TD)	•		GHA421003	
	2005.04-2007.06	Hatchback Engine 8HX(DV4TD)/8HZ(DV4TD)	•		GWB3657	
	2005.04-2007.06	Hatchback Engine 8HX(DV4TD)/8HZ(DV4TD)		◦	GHA225011	K
	2005.04-2007.06	Hatchback Engine 8HX(DV4TD)/8HZ(DV4TD)		◦	GWB3658	
1.6 16V (80 kW)	2005.04-2007.06	Hatchback Engine NFU(TU5JP4)	•		GHA421003	
	2005.04-2007.06	Hatchback Engine NFU(TU5JP4)	•		GWB3657	
	2005.04-2007.06	Hatchback Engine NFU(TU5JP4)		◦	GHA225011	K
	2005.04-2007.06	Hatchback Engine NFU(TU5JP4)		◦	GWB3658	
1.6 HDi (80 kW)	2007.07-	Hatchback Engine 9HZ(DV6TED4)	•		GHA421003	
	2007.07-	Hatchback Engine 9HZ(DV6TED4)	•		GWB3657	
	2007.07-	Hatchback Engine 9HZ(DV6TED4)		◦	GHA225011	K
	2007.07-	Hatchback Engine 9HZ(DV6TED4)		◦	GWB3658	
106 (1A, 1C)						
1.0 (33 kW)	1991.09-1996.04	Hatchback Engine CDY(TU9M)/TU9	•		GWB0882	
	1991.09-1996.04	Hatchback Engine CDY(TU9M)/TU9	•		GWB1327	
	1991.09-1996.04	Hatchback Engine CDY(TU9M)/TU9		◦	GWB0961	
1.0 (37 kW)	1991.09-1996.04	Hatchback Engine CDZ(TU9M)	•		GWB0882	
	1991.09-1996.04	Hatchback Engine CDZ(TU9M)	•		GWB1327	
	1991.09-1996.04	Hatchback Engine CDZ(TU9M)		◦	GWB0961	
1.1 (44 kW)	1991.09-1996.04	Hatchback Engine HDZ(TU1M)	•		GWB0882	
	1991.09-1996.04	Hatchback Engine HDZ(TU1M)	•		GWB1327	
	1991.09-1996.04	Hatchback Engine HDZ(TU1M)		◦	GWB0961	
1.3 (72 kW)	1993.10-1996.04	Hatchback Engine TU2J2	•		GWB0882	
	1993.10-1996.04	Hatchback Engine TU2J2		◦	GWB0961	
1.4 (51 kW)	1991.08-1996.03	Hatchback Engine TU3	•		GWB0882	
	1991.08-1996.03	Hatchback Engine TU3		◦	GWB0961	
1.4 (55 kW)	1991.09-1996.04	Hatchback Engine KDX(TU3MC)/KDY(TU3M)	•		GWB0882	
	1991.09-1996.04	Hatchback Engine KDX(TU3MC)/KDY(TU3M)		◦	GWB0961	
1.4 (69 kW)	1991.09-1996.04	Hatchback Engine KFZ(TU3J2/Z)	•		GWB0882	
	1991.09-1996.04	Hatchback Engine KFZ(TU3J2/Z)		◦	GWB0961	
1.4 (72 kW)	1991.08-1996.03	Hatchback	•		GWB0882	
	1991.08-1996.03	Hatchback		◦	GWB0961	
1.4 D (37 kW)	1992.09-1996.04	Hatchback Engine K9Y(TUD3Y)	•		GWB0882	
	1992.09-1996.04	Hatchback Engine K9Y(TUD3Y)		◦	GWB0961	
1.5 D (40 kW)	1994.06-1996.04	Hatchback Engine VJY(TUD5)	•		GWB0882	
	1994.06-1996.04	Hatchback Engine VJY(TUD5)		◦	GWB0961	
1.5 D (43 kW)	1994.06-1996.04	Hatchback Engine VJY(TUD5)	•		GWB0882	
	1994.06-1996.04	Hatchback Engine VJY(TUD5)		◦	GWB0961	
1.6 (65 kW)	1993.06-1996.04	Hatchback Engine NFZ(TU5JP)	•		GWB0882	
	1993.06-1996.04	Hatchback Engine NFZ(TU5JP)		◦	GWB0961	
1.6 (76 kW)	1994.01-1996.04	Hatchback Engine NFY(TU5J2)	•		GWB0882	
	1994.01-1996.04	Hatchback Engine NFY(TU5J2)		◦	GHA225031	K
106 II (1)						
1.0 i (33 kW)	1996.05-	Hatchback Engine CDY(TU9M)	•		GHA421003	
	1996.05-	Hatchback Engine CDY(TU9M)	•		GWB0882	
	1996.05-	Hatchback Engine CDY(TU9M)	•		GWB1327	
	1996.05-	Hatchback Engine CDY(TU9M)	•		GWB3554A	
	1996.05-	Hatchback Engine CDY(TU9M)		◦	GWB0961	
	1996.05-	Hatchback Engine CDY(TU9M)		◦	GWB3556	
1.0 i (37 kW)	1997.01-	Hatchback Engine CDZ(TU9M)	•		GHA421003	
	1997.01-	Hatchback Engine CDZ(TU9M)	•		GWB0882	
	1997.01-	Hatchback Engine CDZ(TU9M)	•		GWB1327	
	1997.01-	Hatchback Engine CDZ(TU9M)	•		GWB3554A	
	1997.01-	Hatchback Engine CDZ(TU9M)		◦	GWB0961	
	1997.01-	Hatchback Engine CDZ(TU9M)		◦	GWB3556	
1.1 i (40 kW)	1997.01-	Hatchback Engine HDY(TU1M)	•		GHA421003	



	 YEAR		F	R	G-AP Ref.	KIT
PEUGEOT						
106 II (1)						
1.1 i (40 kW)	1997.01-	Hatchback Engine HDY(TU1M)	•		GWB0882	
	1997.01-	Hatchback Engine HDY(TU1M)	•		GWB1327	
	1997.01-	Hatchback Engine HDY(TU1M)	•		GWB3554A	
	1997.01-	Hatchback Engine HDY(TU1M)		○	GWB0961	
	1997.01-	Hatchback Engine HDY(TU1M)		○	GWB3556	
1.1 i (44 kW)	1996.05-	Hatchback Engine HDZ(TU1M)/HFX(TU1JP)	•		GHA421003	
	1996.05-	Hatchback Engine HDZ(TU1M)/HFX(TU1JP)	•		GWB0882	
	1996.05-	Hatchback Engine HDZ(TU1M)/HFX(TU1JP)	•		GWB1327	
	1996.05-	Hatchback Engine HDZ(TU1M)/HFX(TU1JP)	•		GWB3554A	
	1996.05-	Hatchback Engine HDZ(TU1M)/HFX(TU1JP)		○	GWB0961	
	1996.05-	Hatchback Engine HDZ(TU1M)/HFX(TU1JP)		○	GWB3556	
1.4 i (55 kW)	1996.05-	Hatchback Engine KFW(TU3JP)/KFX(TU3JP)	•		GHA421003	
	1996.05-	Hatchback Engine KFW(TU3JP)/KFX(TU3JP)	•		GWB0882	
	1996.05-	Hatchback Engine KFW(TU3JP)/KFX(TU3JP)	•		GWB3554A	
	1996.05-	Hatchback Engine KFW(TU3JP)/KFX(TU3JP)		○	GWB0961	
	1996.05-	Hatchback Engine KFW(TU3JP)/KFX(TU3JP)		○	GWB3556	
1.5 D (40 kW)	1996.05-	Hatchback Engine VJY(TUD5)	•		GHA421003	
	1996.05-	Hatchback Engine VJY(TUD5)	•		GWB0882	
	1996.05-	Hatchback Engine VJY(TUD5)	•		GWB3554A	
	1996.05-	Hatchback Engine VJY(TUD5)		○	GWB0961	
	1996.05-	Hatchback Engine VJY(TUD5)		○	GWB3556	
1.5 D (42 kW)	1998.04-	Hatchback Engine VJX(TUD5)	•		GHA421003	
	1998.04-	Hatchback Engine VJX(TUD5)	•		GWB3554A	
	1998.04-	Hatchback Engine VJX(TUD5)		○	GWB3556	
1.6 i (65 kW)	1996.05-	Hatchback Engine NFZ(TU5JP)	•		GHA421003	
	1996.05-	Hatchback Engine NFZ(TU5JP)	•		GWB0882	
	1996.05-	Hatchback Engine NFZ(TU5JP)		○	GWB0961	
	1996.05-	Hatchback Engine NFZ(TU5JP)		○	GWB3556	
1.6 i (74 kW)	1996.05-	Hatchback Engine NFW(TU5J2)/NFY(TU5J2)	•		GHA421003	
	1996.05-	Hatchback Engine NFW(TU5J2)/NFY(TU5J2)	•		GWB0882	
	1996.05-	Hatchback Engine NFW(TU5J2)/NFY(TU5J2)	•		GWB3554A	
	1996.05-	Hatchback Engine NFW(TU5J2)/NFY(TU5J2)		○	GHA225031	K
1.6 S16 (87 kW)	1996.05-	Hatchback Engine NFX(TU5J4)	•		GHA421003	
	1996.05-	Hatchback Engine NFX(TU5J4)	•		GWB0882	
	1996.05-	Hatchback Engine NFX(TU5J4)	•		GWB3554A	
	1996.05-	Hatchback Engine NFX(TU5J4)		○	GHA225031	K
Electric (20 kW)	1996.04-2004.07	Hatchback	•		GHA421003	
	1996.04-2004.07	Hatchback	•		GWB3554A	
	1996.04-2004.07	Hatchback		○	GWB0961	
	1996.04-2004.07	Hatchback		○	GWB3556	
106 VAN (1_)						
1.0 (33 kW)	1991.09-2001.03	Box Engine CDY(TU9M)/TU9	•		GWB0882	
	1991.09-2001.03	Box Engine CDY(TU9M)/TU9	•		GWB1327	
	1991.09-2001.03	Box Engine CDY(TU9M)/TU9	•		GWB3554A	
	1991.09-2001.03	Box Engine CDY(TU9M)/TU9		○	GWB0961	
	1991.09-2001.03	Box Engine CDY(TU9M)/TU9		○	GWB3556	
1.5 D (40 kW)	1996.05-2001.03	Box Engine VJY(TUD5)	•		GHA421003	
	1996.05-2001.03	Box Engine VJY(TUD5)	•		GWB0882	
	1996.05-2001.03	Box Engine VJY(TUD5)	•		GWB3554A	
	1996.05-2001.03	Box Engine VJY(TUD5)		○	GWB0961	
	1996.05-2001.03	Box Engine VJY(TUD5)		○	GWB3556	
1.5 D (42 kW)	2000.10-2001.03	Box Engine VJX(TUD5)	•		GHA421003	
	2000.10-2001.03	Box Engine VJX(TUD5)	•		GWB3554A	
	2000.10-2001.03	Box Engine VJX(TUD5)		○	GWB3556	
Electric (20 kW)	1996.04-2004.07	Box	•		GWB3554A	
	1996.04-2004.07	Box		○	GWB0961	
	1996.04-2004.07	Box		○	GWB3556	
107						
1.0 (50 kW)	2005.06-	Hatchback Engine 1KR(384F)	•		GWB3684	
	2005.06-	Hatchback Engine 1KR(384F)		○	GHA400149	
1.4 HDi (40 kW)	2005.06-	Hatchback Engine 8HT(DV4TD)	•		GWB3684	
	2005.06-	Hatchback Engine 8HT(DV4TD)		○	GHA400149	
108						
1.0 VTi (51 kW)	2014.05-	Hatchback Engine 1KR-FE	•		GWB3684	



	 YEAR		F	R	G-AP Ref.	KIT
PEUGEOT						
108						
1.0 VTi (51 kW)	2014.05-	Hatchback Engine 1KR-FE		o	GHA400149	
1.2 (60 kW)	2014.05-	Hatchback	•		GWB3684	
	2014.05-	Hatchback		o	GHA400149	
2008						
1.2 THP (81 kW)	2015.01-	Estate Engine HNE(EB2DT)	•		GWB3584	
	2015.01-	Estate Engine HNE(EB2DT)	•		GWB3657	
	2015.01-	Estate Engine HNE(EB2DT)		o	GWB6544	
1.2 THP (96 kW)	2015.01-	Estate Engine HNY(EB2DTS)	•		GWB3584	
	2015.01-	Estate Engine HNY(EB2DTS)	•		GWB3657	
	2015.01-	Estate Engine HNY(EB2DTS)		o	GWB6544	
1.2 VTi (60 kW)	2013.03-	Estate	•		GWB3584	
	2013.03-	Estate	•		GWB3657	
	2013.03-	Estate		o	GWB6544	
1.4 HDi (50 kW)	2013.06-	Estate Engine 8HR(DV4C)	•		GWB3584	
	2013.06-	Estate Engine 8HR(DV4C)	•		GWB3657	
	2013.06-	Estate Engine 8HR(DV4C)		o	GWB6544	
1.6 BlueHDi (73 kW)	2015.01-	Estate Engine BHY(DV6FD)	•		GWB3584	
	2015.01-	Estate Engine BHY(DV6FD)	•		GWB3657	
	2015.01-	Estate Engine BHY(DV6FD)		o	GWB6544	
1.6 BlueHDi (88 kW)	2014.07-	Estate Engine BHZ(DV6FC)	•		GWB3584	
	2014.07-	Estate Engine BHZ(DV6FC)	•		GWB3657	
	2014.07-	Estate Engine BHZ(DV6FC)		o	GWB6544	
1.6 HDi (68 kW)	2013.03-	Estate Engine 9HP(DV6DTED)	•		GWB3584	
	2013.03-	Estate Engine 9HP(DV6DTED)	•		GWB3657	
	2013.03-	Estate Engine 9HP(DV6DTED)		o	GWB6544	
1.6 HDi (84 kW)	2013.03-	Estate Engine 9HD(DV6CTED)	•		GWB3584	
	2013.03-	Estate Engine 9HD(DV6CTED)	•		GWB3657	
	2013.03-	Estate Engine 9HD(DV6CTED)		o	GWB6544	
1.6 VTi (88 kW)	2013.03-	Estate Engine 5FS(EP6C)	•		GWB3584	
	2013.03-	Estate Engine 5FS(EP6C)	•		GWB3657	
	2013.03-	Estate Engine 5FS(EP6C)		o	GWB6544	
205 (741B, 20D)						
1.4 CJ (55 kW)	1991.05-1994.12	Convertible Engine KDY(TU3M)/KDZ(TU3M)	•		GWB0882	
	1991.05-1994.12	Convertible Engine KDY(TU3M)/KDZ(TU3M)		o	GWB0961	
1.6 CJ (65 kW)	1992.08-1994.12	Convertible Engine BDY(XU5M3Z)	•		GWB0882	
	1992.08-1994.12	Convertible Engine BDY(XU5M3Z)	•		GWB0915	
	1992.08-1994.12	Convertible Engine BDY(XU5M3Z)		o	GWB0961	
1.9 CTi (92 kW)	1990.08-1992.07	Convertible	•		GWB0882	
	1990.08-1992.07	Convertible	•		GWB0915	
	1990.08-1992.07	Convertible		o	GWB0961	
205 II (20A/C)						
1.0 (37 kW)	1992.08-1997.05	Hatchback Engine CDZ (TU9M)	•		GWB0882	
	1992.08-1997.05	Hatchback Engine CDZ (TU9M)		o	GWB0961	
1.3 (47 kW)	1990.08-1992.07	Hatchback Engine G1A	•		GWB0882	
	1990.08-1992.07	Hatchback Engine G1A		o	GWB0961	
1.4 (50 kW)	1990.08-1992.07	Hatchback	•		GWB0882	
	1990.08-1992.07	Hatchback		o	GWB0961	
1.4 (55 kW)	1990.08-1998.07	Hatchback Engine KDX(TU3MC)/TU32	•		GWB0882	
	1990.08-1998.07	Hatchback Engine KDX(TU3MC)/TU32		o	GHA225032	K
	1990.08-1998.07	Hatchback Engine KDX(TU3MC)/TU32		o	GWB0961	
1.6 (66 kW)	1990.08-1992.07	Hatchback Engine 171(XU5S)	•		GHA425022	
	1990.08-1992.07	Hatchback Engine 171(XU5S)	•		GWB0882	
	1990.08-1992.07	Hatchback Engine 171(XU5S)	•		GWB0915	
	1990.08-1992.07	Hatchback Engine 171(XU5S)		o	GHA225032	K
	1990.08-1992.07	Hatchback Engine 171(XU5S)		o	GWB0961	
1.6 Aut. (65 kW)	1990.05-1998.09	Hatchback Engine BDY(XU5M2Z)/BDY(XU5M3Z)	•		GWB0882	
	1990.05-1998.09	Hatchback Engine BDY(XU5M2Z)/BDY(XU5M3Z)	•		GWB0915	
	1990.05-1998.09	Hatchback Engine BDY(XU5M2Z)/BDY(XU5M3Z)		o	GWB0961	
1.7 TD (57 kW)	1990.01-1998.09	Hatchback Engine A8B(XUD7TE)	•		GHA425022	
	1990.01-1998.09	Hatchback Engine A8B(XUD7TE)	•		GWB0882	
	1990.01-1998.09	Hatchback Engine A8B(XUD7TE)	•		GWB0915	
	1990.01-1998.09	Hatchback Engine A8B(XUD7TE)		o	GWB0961	
1.8 XDT (58 kW)	1990.08-1997.05	Hatchback Engine XUD7T	•		GHA425022	
	1990.08-1997.05	Hatchback Engine XUD7T	•		GWB0882	



	 YEAR		F	R	G-AP Ref.	KIT
PEUGEOT						
205 II (20A/C)						
1.8 XDT (58 kW)	1990.08-1997.05	Hatchback Engine XUD7T	•		GWB0915	
	1990.08-1997.05	Hatchback Engine XUD7T		◦	GHA225032	K
	1990.08-1997.05	Hatchback Engine XUD7T		◦	GWB0961	
1.9 (96 kW)	1990.08-1992.07	Hatchback	•		GHA425022	
205 VAN						
1.7 Diesel (44 kW)	1994.03-	Box Engine 161A(XUD7)	•		GHA425022	
	1994.03-	Box Engine 161A(XUD7)	•		GWB0882	
	1994.03-	Box Engine 161A(XUD7)	•		GWB0915	
	1994.03-	Box Engine 161A(XUD7)		◦	GWB0961	
	1994.03-	Box Engine 161A(XUD7)		◦	GWB3556	
206						
1.4 (55 kW)	2007.03-	Saloon Engine KFW(TU3JP)/KfV(TU3A)	•		GHA421003	
	2007.03-	Saloon Engine KFW(TU3JP)/KfV(TU3A)	•		GWB3554A	
	2007.03-	Saloon Engine KFW(TU3JP)/KfV(TU3A)		◦	GWB3556	
1.4 HDi Eco (50 kW)	2008.09-	Saloon Engine 8HZ(DV4TD)	•		GHA421003	
	2008.09-	Saloon Engine 8HZ(DV4TD)	•		GWB3554A	
	2008.09-	Saloon Engine 8HZ(DV4TD)		◦	GWB3556	
1.6 16V (80 kW)	2007.03-	Saloon Engine NFU(TU5JP4)	•		GHA425022	
	2007.03-	Saloon Engine NFU(TU5JP4)	•		GWB3554A	
	2007.03-	Saloon Engine NFU(TU5JP4)		◦	GWB3556	
206 (2A/C)						
1.1 (40 kW)	1998.08-2000.07	Hatchback	•		GHA421003	
	1998.08-2000.07	Hatchback	•		GWB3554A	
	1998.08-2000.07	Hatchback		◦	GWB3556	
1.1 i (44 kW)	1998.09-	Hatchback Engine HFX(TU1JP)/HFZ(TU1JP)	•		GHA421003	
	1998.09-	Hatchback Engine HFX(TU1JP)/HFZ(TU1JP)	•		GWB3554A	
	1998.09-	Hatchback Engine HFX(TU1JP)/HFZ(TU1JP)		◦	GWB3556	
1.4 16V (65 kW)	2003.10-2007.03	Hatchback Engine KFU(ET3J4)	•		GHA421003	
	2003.10-2007.03	Hatchback Engine KFU(ET3J4)	•		GWB3554A	
	2003.10-2007.03	Hatchback Engine KFU(ET3J4)		◦	GHA225011	K
	2003.10-2007.03	Hatchback Engine KFU(ET3J4)		◦	GWB3556	
1.4 HDi (51 kW)	2002.09-2007.02	Hatchback Engine 8HX(DV4TD)	•		GHA421003	
	2002.09-2007.02	Hatchback Engine 8HX(DV4TD)	•		GWB3554A	
	2002.09-2007.02	Hatchback Engine 8HX(DV4TD)		◦	GWB3556	
1.4 HDi Eco (50 kW)	2001.09-	Hatchback Engine 8HX(DV4TD)/8HZ(DV4TD)	•		GHA421003	
	2001.09-	Hatchback Engine 8HX(DV4TD)/8HZ(DV4TD)	•		GWB3554A	
	2001.09-	Hatchback Engine 8HX(DV4TD)/8HZ(DV4TD)		◦	GWB3556	
1.4 i (55 kW)	1998.09-	Hatchback Engine KFW(TU3JP)/KfX(TU3JP)	•		GHA421003	
	1998.09-	Hatchback Engine KFW(TU3JP)/KfX(TU3JP)	•		GWB3554A	
	1998.09-	Hatchback Engine KFW(TU3JP)/KfX(TU3JP)		◦	GWB3556	
1.4 LPG (55 kW)	2006.05-2007.09	Hatchback Engine KfV(TU3JP)	•		GHA421003	
	2006.05-2007.09	Hatchback Engine KfV(TU3JP)	•		GWB3554A	
	2006.05-2007.09	Hatchback Engine KfV(TU3JP)		◦	GWB3556	
1.6 16V (80 kW)	2000.12-	Hatchback Engine NFU(TU5JP4)	•		GHA425022	
	2000.12-	Hatchback Engine NFU(TU5JP4)	•		GWB0915	
	2000.12-	Hatchback Engine NFU(TU5JP4)		◦	GHA225011	K
	2000.12-	Hatchback Engine NFU(TU5JP4) With ABS		◦	GHA225010	K
	2000.12-	Hatchback Engine NFU(TU5JP4) Without ABS		◦	GHA225016	
1.6 HDi (80 kW)	2004.04-2007.03	Hatchback Engine 9HY(DV6TED4)/9HZ(DV6TED4)	•		GHA425022	
	2004.04-2007.03	Hatchback Engine 9HY(DV6TED4)/9HZ(DV6TED4)	•		GWB0915	
	2004.04-2007.03	Hatchback Engine 9HY(DV6TED4)/9HZ(DV6TED4)		◦	GHA225011	K
1.6 i (65 kW)	1998.09-2000.12	Hatchback Engine NFZ(TU5JP)	•		GHA421003	
	1998.09-2000.12	Hatchback Engine NFZ(TU5JP)	•		GWB3554A	
	1998.09-2000.12	Hatchback Engine NFZ(TU5JP)		◦	GWB3556	
1.9 D (51 kW)	1998.09-2001.11	Hatchback Engine WJZ(DW8)	•		GHA421003	
	1998.09-2001.11	Hatchback Engine WJZ(DW8)	•		GWB3554A	
	1998.09-2001.11	Hatchback Engine WJZ(DW8)		◦	GWB3556	
2.0 HDi (66 kW)	1999.12-	Hatchback Engine RHY(DW10TD)	•		GHA425022	
	1999.12-	Hatchback Engine RHY(DW10TD)	•		GWB0915	
	1999.12-	Hatchback Engine RHY(DW10TD)		◦	GWB3556	
	1999.12-	Hatchback Engine RHY(DW10TD) Without ABS		◦	GHA225016	
2.0 RC (130 kW)	2002.10-2007.03	Hatchback Engine RFK(EW10J4S)	•		GHA425022	
	2002.10-2007.03	Hatchback Engine RFK(EW10J4S)	•		GWB0915	
	2002.10-2007.03	Hatchback Engine RFK(EW10J4S)		◦	GHA225011	K



	 YEAR		F	R	G-AP Ref.	KIT
PEUGEOT						
206 (2A/C)						
2.0 S16 (100 kW)	1999.06-	Hatchback Engine RFN(EW10J4)	•		GHA425022	
	1999.06-	Hatchback Engine RFN(EW10J4)	•		GWB0915	
	1999.06-	Hatchback Engine RFN(EW10J4)		○	GHA225011	K
	1999.06-	Hatchback Engine RFN(EW10J4) With ABS		○	GHA225010	K
	1999.06-	Hatchback Engine RFN(EW10J4) Without ABS		○	GHA225016	
2.0 S16 (99 kW)	1999.04-2000.10	Hatchback Engine RFR(DEW10J4)	•		GHA425022	
	1999.04-2000.10	Hatchback Engine RFR(DEW10J4)	•		GWB0915	
	1999.04-2000.10	Hatchback Engine RFR(DEW10J4) With ABS		○	GHA225010	K
	1999.04-2000.10	Hatchback Engine RFR(DEW10J4) Without ABS		○	GHA225016	
206 (2E/K)						
1.1 (44 kW)	2002.07-	Estate Engine HFX(TU1JP)	•		GHA421003	
	2002.07-	Estate Engine HFX(TU1JP)	•		GWB3554A	
	2002.07-	Estate Engine HFX(TU1JP)		○	GHA225011	K
	2002.07-	Estate Engine HFX(TU1JP)		○	GWB3556	
	2002.07-	Estate Engine HFX(TU1JP) With ABS		○	GHA225010	K
1.4 (55 kW)	2002.07-	Estate Engine HFX(TU1JP) Without ABS		○	GHA225016	
	2002.07-	Estate Engine KFV(TU3A)/KFW(TU3JP)	•		GHA421003	
	2002.07-	Estate Engine KFV(TU3A)/KFW(TU3JP)	•		GWB3554A	
	2002.07-	Estate Engine KFV(TU3A)/KFW(TU3JP)		○	GHA225011	K
	2002.07-	Estate Engine KFV(TU3A)/KFW(TU3JP)		○	GWB3556	
1.4 16V (65 kW)	2002.07-	Estate Engine KFV(TU3A)/KFW(TU3JP) With ABS		○	GHA225010	K
	2002.07-	Estate Engine KFV(TU3A)/KFW(TU3JP) Without ABS		○	GHA225016	
	2003.10-2005.03	Estate Engine KFU(ET3J4)	•		GHA421003	
	2003.10-2005.03	Estate Engine KFU(ET3J4)	•		GWB3554A	
	2003.10-2005.03	Estate Engine KFU(ET3J4)		○	GHA225011	K
1.4 HDi (50 kW)	2003.10-2005.03	Estate Engine KFU(ET3J4)		○	GWB3556	
	2002.07-	Estate Engine 8HX(DV4TD)	•		GHA421003	
	2002.07-	Estate Engine 8HX(DV4TD)	•		GWB3554A	
1.6 16V (80 kW)	2002.07-	Estate Engine 8HX(DV4TD)		○	GWB3556	
	2002.07-	Estate Engine NFU(TU5JP4)	•		GHA425022	
	2002.07-	Estate Engine NFU(TU5JP4)	•		GWB0915	
	2002.07-	Estate Engine NFU(TU5JP4)		○	GHA225011	K
	2002.07-	Estate Engine NFU(TU5JP4)		○	GWB3556	
1.6 HDi (80 kW)	2002.07-	Estate Engine NFU(TU5JP4) With ABS		○	GHA225010	K
	2002.07-	Estate Engine NFU(TU5JP4) Without ABS		○	GHA225016	
	2005.10-2007.03	Estate Engine 9HZ(DV6TED4)	•		GHA425022	
	2005.10-2007.03	Estate Engine 9HZ(DV6TED4)	•		GWB0915	
	2005.10-2007.03	Estate Engine 9HZ(DV6TED4)		○	GHA225011	K
2.0 16V (100 kW)	2005.10-2007.03	Estate Engine 9HZ(DV6TED4)		○	GWB3556	
	2002.07-	Estate Engine RFN(EW10J4)	•		GHA425022	
	2002.07-	Estate Engine RFN(EW10J4)	•		GWB0915	
	2002.07-	Estate Engine RFN(EW10J4)		○	GHA225011	K
	2002.07-	Estate Engine RFN(EW10J4)		○	GWB3556	
2.0 HDi (66 kW)	2002.07-	Estate Engine RFN(EW10J4) With ABS		○	GHA225010	K
	2002.07-	Estate Engine RFN(EW10J4) Without ABS		○	GHA225016	
	2002.07-	Estate Engine RHY(DW10TD)	•		GHA425022	
	2002.07-	Estate Engine RHY(DW10TD)	•		GWB0915	
	2002.07-	Estate Engine RHY(DW10TD)		○	GHA225011	K
206 2A/C)	2002.07-	Estate Engine RHY(DW10TD)		○	GWB3556	
	2002.07-	Estate Engine RHY(DW10TD) With ABS		○	GHA225010	K
	2002.07-	Estate Engine RHY(DW10TD) Without ABS		○	GHA225016	
	2002.07-	Estate Engine RHY(DW10TD)		○	GWB3556	
	2002.07-	Estate Engine RHY(DW10TD) Without ABS		○	GHA225016	
206 2A/C)						
1.0 (48 kW)	2002.09-2007.02	Hatchback	•		GWB3554A	
	2002.09-2007.02	Hatchback		○	GWB3556	
206 CC (2D)						
1.6 16V (80 kW)	2000.09-	Convertible Engine NFU(TU5JP4)	•		GHA425022	
	2000.09-	Convertible Engine NFU(TU5JP4)	•		GWB0915	
	2000.09-	Convertible Engine NFU(TU5JP4)		○	GHA225011	K
	2000.09-	Convertible Engine NFU(TU5JP4) With ABS		○	GHA225010	K
	2000.09-	Convertible Engine NFU(TU5JP4) Without ABS		○	GHA225016	
1.6 HDi (80 kW)	2005.04-	Convertible Engine 9HZ(DV6TED4)	•		GHA425022	
	2005.04-	Convertible Engine 9HZ(DV6TED4)	•		GWB0915	
	2005.04-	Convertible Engine 9HZ(DV6TED4)		○	GHA225011	K
2.0 S16 (100 kW)	2000.09-	Convertible Engine RFN(EW10J4)	•		GHA425022	



	 YEAR		F	R	G-AP Ref.	KIT
PEUGEOT						
206 CC (2D)						
2.0 S16 (100 kW)	2000.09-	Convertible Engine RFN(EW10J4)	•		GWB0915	
	2000.09-	Convertible Engine RFN(EW10J4)		○	GHA225011	K
	2000.09-	Convertible Engine RFN(EW10J4) With ABS		○	GHA225010	K
	2000.09-	Convertible Engine RFN(EW10J4) Without ABS		○	GHA225016	
206 (2A/C)						
1.6 (81 kW)	2005.5-2008.7	Hatchback	•		GWB0915	
	2005.5-2008.7	Hatchback		○	GHA225011	K
	2005.5-2008.7	Hatchback		○	GWB3556	
206 SW (2E/K)						
1.6 (81 kW)	2005.5-2008.7	Estate	•		GHA425022	
	2005.5-2008.7	Estate	•		GWB0915	
	2005.5-2008.7	Estate		○	GHA225011	K
	2005.5-2008.7	Estate		○	GWB3556	
206 VAN						
1.4 HDi (50 kW)	2001.09-2009.03	Box Engine 8HX(DV4TD)/8HZ(DV4TD)	•		GHA421003	
	2001.09-2009.03	Box Engine 8HX(DV4TD)/8HZ(DV4TD)	•		GWB3554A	
	2001.09-2009.03	Box Engine 8HX(DV4TD)/8HZ(DV4TD)		○	GWB3556	
1.9 D (51 kW)	1999.04-2007.05	Box Engine WJZ(DW8)	•		GHA421003	
	1999.04-2007.05	Box Engine WJZ(DW8)	•		GWB0915	
	1999.04-2007.05	Box Engine WJZ(DW8)		○	GWB3556	
206+ (T3E)						
1.1 (44 kW)	2009.01-	Hatchback Engine HFX(TU1JP)/HFX(TU1A)/TU1AE5	•		GHA421003	
	2009.01-	Hatchback Engine HFX(TU1JP)/HFX(TU1A)/TU1AE5	•		GWB3554A	
	2009.01-	Hatchback Engine HFX(TU1JP)/HFX(TU1A)/TU1AE5		○	GWB3556	
1.4 HDi Eco (50 kW)	2009.01-	Hatchback Engine 8HX(DV4TD)/8HZ(DV4TD)	•		GHA421003	
	2009.01-	Hatchback Engine 8HX(DV4TD)/8HZ(DV4TD)	•		GWB3554A	
	2009.01-	Hatchback Engine 8HX(DV4TD)/8HZ(DV4TD)		○	GWB3556	
1.4 i (54 kW)	2010.09-	Hatchback Engine KFT(TU3A)	•		GHA421003	
	2010.09-	Hatchback Engine KFT(TU3A)		○	GWB3556	
1.4 i (55 kW)	2009.01-	Hatchback Engine KFW(TU3A)/KFW(TU3A)	•		GHA421003	
	2009.01-	Hatchback Engine KFW(TU3A)/KFW(TU3A)	•		GWB3554A	
	2009.01-	Hatchback Engine KFW(TU3A)/KFW(TU3A)		○	GWB3556	
1.6 16V (80 kW)	2010.07-	Hatchback Engine NFU (TU5JP4)		○	GWB3556	
207						
1.4 (54 kW)	2007.12-	Saloon Engine KFU(TU3A)	•		GHA421003	
	2007.12-	Saloon Engine KFU(TU3A)	•		GWB3584	
	2007.12-	Saloon Engine KFU(TU3A)		○	GWB6544	
1.4 Flex (60 kW)	2008.11-	Saloon Engine KFW (TU3A)	•		GHA421003	
	2008.11-	Saloon Engine KFW (TU3A)	•		GWB3584	
	2008.11-	Saloon Engine KFW (TU3A)		○	GWB6544	
1.6 (81 kW)	2009.09-2011.12	Saloon	•		GHA425022	
	2009.09-2011.12	Saloon	•		GWB3584	
	2009.09-2011.12	Saloon		○	GWB6544	
1.6 Bioflex (83 kW)	2008.01-	Saloon Engine N6A (TU5JP4)	•		GHA425022	
	2008.01-	Saloon Engine N6A (TU5JP4)	•		GWB3584	
	2008.01-	Saloon Engine N6A (TU5JP4)		○	GWB6544	
207 (WA_, WC_)						
1.4 (53 kW)	2006.05-2007.09	Hatchback Engine KFU(TU3A)	•		GWB3657	
	2006.05-2007.09	Hatchback Engine KFU(TU3A)		○	GHA230145	K
	2006.05-2007.09	Hatchback Engine KFU(TU3A)		○	GWB6544	
1.4 (54 kW)	2007.12-	Hatchback Engine KFU(TU3A)	•		GHA421003	
	2007.12-	Hatchback Engine KFU(TU3A)	•		GWB3584	
	2007.12-	Hatchback Engine KFU(TU3A)		○	GHA230145	K
	2007.12-	Hatchback Engine KFU(TU3A)		○	GWB6544	
1.4 (55 kW)	2008.08-	Hatchback Engine KFU(TU3A)/KFW(TU3A)	•		GHA421003	
	2008.08-	Hatchback Engine KFU(TU3A)/KFW(TU3A)	•		GWB3584	
	2008.08-	Hatchback Engine KFU(TU3A)/KFW(TU3A)		○	GWB6544	
1.4 16V (65 kW)	2006.05-2007.02	Hatchback Engine KFU(ET3J4)	•		GHA421003	
	2006.05-2007.02	Hatchback Engine KFU(ET3J4)	•		GWB3657	
	2006.05-2007.02	Hatchback Engine KFU(ET3J4)		○	GHA230145	K
	2006.05-2007.02	Hatchback Engine KFU(ET3J4)		○	GWB6544	
1.4 16V (70 kW)	2007.06-	Hatchback Engine 8FS(EP3)/EP3/EP3C	•		GHA421003	
	2007.06-	Hatchback Engine 8FS(EP3)/EP3/EP3C	•		GHA425022	



	 YEAR		F	R	G-AP Ref.	KIT
PEUGEOT						
207 (WA_, WC_)						
1.4 16V (70 kW)	2007.06-	Hatchback Engine 8FS(EP3)/EP3/EP3C	•		GWB3584	
	2007.06-	Hatchback Engine 8FS(EP3)/EP3/EP3C	•		GWB3657	
	2007.06-	Hatchback Engine 8FS(EP3)/EP3/EP3C		○	GHA230145	K
	2007.06-	Hatchback Engine 8FS(EP3)/EP3/EP3C		○	GWB6544	
1.4 16V (72 kW)	2009.10-	Hatchback	•		GHA421003	
	2009.10-	Hatchback	•		GHA425022	
	2009.10-	Hatchback	•		GWB3584	
	2009.10-	Hatchback	•		GWB3657	
	2009.10-	Hatchback		○	GHA230145	K
	2009.10-	Hatchback		○	GWB6544	
1.4 Bioflex (60 kW)	2008.08-	Hatchback Engine KFW (TU3JP)	•		GWB3584	
	2008.08-	Hatchback Engine KFW (TU3JP)	•		GWB3657	
	2008.08-	Hatchback Engine KFW (TU3JP)		○	GWB6544	
1.4 HDi (50 kW)	2006.05-2007.09	Hatchback Engine 8HR(DV4C)/8HZ(DV4TD)	•		GHA421003	
	2006.05-2007.09	Hatchback Engine 8HR(DV4C)/8HZ(DV4TD)	•		GHA425022	
	2006.05-2007.09	Hatchback Engine 8HR(DV4C)/8HZ(DV4TD)	•		GWB3584	
	2006.05-2007.09	Hatchback Engine 8HR(DV4C)/8HZ(DV4TD)	•		GWB3657	
	2006.05-2007.09	Hatchback Engine 8HR(DV4C)/8HZ(DV4TD)		○	GHA230145	K
	2006.05-2007.09	Hatchback Engine 8HR(DV4C)/8HZ(DV4TD)		○	GWB6544	
1.6 (81 kW)	2008.08-	Hatchback Engine N6A (TU5JP4)	•		GWB3584	
	2008.08-	Hatchback Engine N6A (TU5JP4)		○	GWB6544	
1.6 16V (80 kW)	2006.05-	Hatchback Engine NFU(TU5JP4)	•		GHA425022	
	2006.05-	Hatchback Engine NFU(TU5JP4)	•		GWB3584	
	2006.05-	Hatchback Engine NFU(TU5JP4)		○	GHA230145	K
	2006.05-	Hatchback Engine NFU(TU5JP4)		○	GWB6544	
1.6 16V RC (128 kW)	2007.06-	Hatchback Engine 5FY(EP6DTS)	•		GHA425022	
	2007.06-	Hatchback Engine 5FY(EP6DTS)	•		GWB3584	
	2007.06-	Hatchback Engine 5FY(EP6DTS)		○	GHA230145	K
	2007.06-	Hatchback Engine 5FY(EP6DTS)		○	GWB6544	
1.6 16V Turbo (110 kW)	2006.05-	Hatchback Engine 5FX(EP6DT)	•		GHA425022	
	2006.05-	Hatchback Engine 5FX(EP6DT)	•		GWB3584	
	2006.05-	Hatchback Engine 5FX(EP6DT)		○	GHA230145	K
	2006.05-	Hatchback Engine 5FX(EP6DT)		○	GWB6544	
1.6 16V Turbo (115 kW)	2009.10-	Hatchback Engine 5FR(EP6DT)	•		GHA425022	
	2009.10-	Hatchback Engine 5FR(EP6DT)	•		GWB3584	
	2009.10-	Hatchback Engine 5FR(EP6DT)		○	GHA230145	K
	2009.10-	Hatchback Engine 5FR(EP6DT)		○	GWB6544	
1.6 16V VTi (88 kW)	2007.01-2007.09	Hatchback Engine 5FS(EP6C)/EP6	•		GHA425022	
	2007.01-2007.09	Hatchback Engine 5FS(EP6C)/EP6	•		GWB3584	
	2007.01-2007.09	Hatchback Engine 5FS(EP6C)/EP6		○	GHA230145	K
	2007.01-2007.09	Hatchback Engine 5FS(EP6C)/EP6		○	GWB6544	
1.6 HDi (66 kW)	2006.05-	Hatchback Engine 9HX(DV6ATED4)/9HV(DV6ATED4)/9HV(DV6TED4)	•		GHA425022	
	2006.05-	Hatchback Engine 9HX(DV6ATED4)/9HV(DV6ATED4)/9HV(DV6TED4)	•		GWB3584	
	2006.05-	Hatchback Engine 9HX(DV6ATED4)/9HV(DV6ATED4)/9HV(DV6TED4)		○	GHA230145	K
	2006.05-	Hatchback Engine 9HX(DV6ATED4)/9HV(DV6ATED4)/9HV(DV6TED4)		○	GWB6544	
1.6 HDi (68 kW)	2009.11-	Hatchback Engine 9HP(DV6DTED)	•		GHA425022	
	2009.11-	Hatchback Engine 9HP(DV6DTED)	•		GWB3584	
	2009.11-	Hatchback Engine 9HP(DV6DTED)		○	GHA230145	K
	2009.11-	Hatchback Engine 9HP(DV6DTED)		○	GWB6544	
1.6 HDi (80 kW)	2006.05-2007.09	Hatchback Engine 9HY(DV6TED4)/9HZ(DV6TED4)	•		GHA425022	
	2006.05-2007.09	Hatchback Engine 9HY(DV6TED4)/9HZ(DV6TED4)	•		GWB3584	
	2006.05-2007.09	Hatchback Engine 9HY(DV6TED4)/9HZ(DV6TED4)		○	GHA230145	K
	2006.05-2007.09	Hatchback Engine 9HY(DV6TED4)/9HZ(DV6TED4)		○	GWB6544	
1.6 HDi (82 kW)	2009.08-	Hatchback Engine 9HR(DV6C)	•		GHA425022	
	2009.08-	Hatchback Engine 9HR(DV6C)	•		GWB3584	
	2009.08-	Hatchback Engine 9HR(DV6C)		○	GHA230145	K
	2009.08-	Hatchback Engine 9HR(DV6C)		○	GWB6544	
207 (WK_)						
1.4 (54 kW)	2007.06-	Estate Engine Kfv(TU3A)	•		GHA421003	
	2007.06-	Estate Engine Kfv(TU3A)	•		GWB3657	
	2007.06-	Estate Engine Kfv(TU3A)		○	GHA230145	K
	2007.06-	Estate Engine Kfv(TU3A)		○	GWB6544	
1.4 16V (70 kW)	2007.07-	Estate Engine 8FS(EP3)/EP3/EP3C	•		GHA421003	
	2007.07-	Estate Engine 8FS(EP3)/EP3/EP3C	•		GHA425022	



	 YEAR		F	R	G-AP Ref.	KIT
PEUGEOT						
207 (WK_)						
1.4 16V (70 kW)	2007.07-	Estate Engine 8FS(EP3)/EP3/EP3C	•		GWB3584	
	2007.07-	Estate Engine 8FS(EP3)/EP3/EP3C	•		GWB3657	
	2007.07-	Estate Engine 8FS(EP3)/EP3/EP3C		◦	GHA230145	K
	2007.07-	Estate Engine 8FS(EP3)/EP3/EP3C		◦	GWB6544	
1.4 16V (72 kW)	2009.11-	Estate	•		GHA421003	
	2009.11-	Estate	•		GHA425022	
	2009.11-	Estate	•		GWB3584	
	2009.11-	Estate		◦	GHA230145	K
	2009.11-	Estate		◦	GWB6544	
1.6 16V (88 kW)	2008.01-	Estate Engine EP6/5FS(EP6C)	•		GHA425022	
	2008.01-	Estate Engine EP6/5FS(EP6C)	•		GWB3584	
	2008.01-	Estate Engine EP6/5FS(EP6C)		◦	GHA230145	K
	2008.01-	Estate Engine EP6/5FS(EP6C)		◦	GWB6544	
1.6 16V RC (128 kW)	2007.02-	Estate Engine 5FY(EP6DTS)	•		GHA425022	
	2007.02-	Estate Engine 5FY(EP6DTS)	•		GWB3584	
	2007.02-	Estate Engine 5FY(EP6DTS)		◦	GHA230145	K
	2007.02-	Estate Engine 5FY(EP6DTS)		◦	GWB6544	
1.6 HDi (66 kW)	2007.07-	Estate Engine 9HX(DV6ATED4)	•		GHA425022	
	2007.07-	Estate Engine 9HX(DV6ATED4)	•		GWB3584	
	2007.07-	Estate Engine 9HX(DV6ATED4)		◦	GHA230145	K
	2007.07-	Estate Engine 9HX(DV6ATED4)		◦	GWB6544	
1.6 HDi (68 kW)	2009.11-	Estate Engine 9HP(DV6DTEd)	•		GHA425022	
	2009.11-	Estate Engine 9HP(DV6DTEd)	•		GWB3584	
	2009.11-	Estate Engine 9HP(DV6DTEd)		◦	GHA230145	K
	2009.11-	Estate Engine 9HP(DV6DTEd)		◦	GWB6544	
1.6 HDi (80 kW)	2008.01-	Estate Engine 9HZ(DV6TED4)	•		GHA425022	
	2008.01-	Estate Engine 9HZ(DV6TED4)	•		GWB3584	
	2008.01-	Estate Engine 9HZ(DV6TED4)		◦	GHA230145	K
	2008.01-	Estate Engine 9HZ(DV6TED4)		◦	GWB6544	
1.6 HDi (82 kW)	2009.08-	Estate Engine 9HR(DV6C)	•		GHA425022	
	2009.08-	Estate Engine 9HR(DV6C)	•		GWB3584	
	2009.08-	Estate Engine 9HR(DV6C)		◦	GHA230145	K
	2009.08-	Estate Engine 9HR(DV6C)		◦	GWB6544	
207 CC (WD_)						
1.6 (90 kW)	2010.09-2011.12	Convertible	•		GWB3584	
	2010.09-2011.12	Convertible		◦	GWB6544	
1.6 16V (88 kW)	2007.02-	Convertible Engine EP6/5FS(EP6C)	•		GHA425022	
	2007.02-	Convertible Engine EP6/5FS(EP6C)	•		GWB3584	
	2007.02-	Convertible Engine EP6/5FS(EP6C)		◦	GHA230145	K
	2007.02-	Convertible Engine EP6/5FS(EP6C)		◦	GWB6544	
1.6 16V Turbo (110 kW)	2007.02-	Convertible Engine 5FX(EP6DT)	•		GHA425022	
	2007.02-	Convertible Engine 5FX(EP6DT)	•		GWB3584	
	2007.02-	Convertible Engine 5FX(EP6DT)		◦	GHA230145	K
	2007.02-	Convertible Engine 5FX(EP6DT)		◦	GWB6544	
1.6 16V Turbo (115 kW)	2009.10-	Convertible Engine 5FR(EP6DT)	•		GHA425022	
	2009.10-	Convertible Engine 5FR(EP6DT)	•		GWB3584	
	2009.10-	Convertible Engine 5FR(EP6DT)		◦	GHA230145	K
	2009.10-	Convertible Engine 5FR(EP6DT)		◦	GWB6544	
1.6 HDi (80 kW)	2007.02-	Convertible Engine 9HZ(DV6TED4)	•		GHA425022	
	2007.02-	Convertible Engine 9HZ(DV6TED4)	•		GWB3584	
	2007.02-	Convertible Engine 9HZ(DV6TED4)		◦	GHA230145	K
	2007.02-	Convertible Engine 9HZ(DV6TED4)		◦	GWB6544	
1.6 HDi (82 kW)	2009.08-	Convertible Engine 9HR(DV6C)	•		GHA425022	
	2009.08-	Convertible Engine 9HR(DV6C)	•		GWB3584	
	2009.08-	Convertible Engine 9HR(DV6C)		◦	GHA230145	K
	2009.08-	Convertible Engine 9HR(DV6C)		◦	GWB6544	
207 SW (WK_)						
1.6 16V Turbo (110 kW)	2007.02-	Estate Engine 5FX (EP6DT)	•		GWB3584	
207 VAN						
1.4 (54 kW)	2007.06-2008.10	Box Engine KFV (TU3A)	•		GWB3584	
	2007.06-2008.10	Box Engine KFV (TU3A)	•		GWB3657	
	2007.06-2008.10	Box Engine KFV (TU3A)		◦	GHA230145	K
	2007.06-2008.10	Box Engine KFV (TU3A)		◦	GWB6544	
1.4 HDi (50 kW)	2007.04-	Box Engine 8HZ(DV4TD)	•		GHA421003	



	 YEAR		F	R	G-AP Ref.	KIT
PEUGEOT						
207 VAN						
1.4 HDi (50 kW)	2007.04-	Box Engine 8HZ(DV4TD)	•		GHA425022	
	2007.04-	Box Engine 8HZ(DV4TD)	•		GWB3584	
	2007.04-	Box Engine 8HZ(DV4TD)	•		GWB3657	
	2007.04-	Box Engine 8HZ(DV4TD)		○	GHA230145	K
	2007.04-	Box Engine 8HZ(DV4TD)		○	GWB6544	
1.6 HDi (66 kW)	2007.04-	Box Engine 9HX(DV6ATED4)	•		GHA425022	
	2007.04-	Box Engine 9HX(DV6ATED4)	•		GWB3584	
	2007.04-	Box Engine 9HX(DV6ATED4)		○	GHA230145	K
	2007.04-	Box Engine 9HX(DV6ATED4)		○	GWB6544	
208						
1.0 (50 kW)	2012.03-	Hatchback	•		GHA421003	
	2012.03-	Hatchback	•		GHA425022	
	2012.03-	Hatchback	•		GWB3584	
	2012.03-	Hatchback	•		GWB3657	
	2012.03-	Hatchback		○	GWB6544	
	2012.03-	Hatchback		○	GWB6726	
1.2 (60 kW)	2012.03-	Hatchback	•		GHA421003	
	2012.03-	Hatchback	•		GHA425022	
	2012.03-	Hatchback	•		GWB3584	
	2012.03-	Hatchback	•		GWB3657	
	2012.03-	Hatchback		○	GWB6544	
	2012.03-	Hatchback		○	GWB6726	
1.2 THP (81 kW)	2013.01-	Hatchback Engine HNE(EB2DT)	•		GWB3584	
	2013.01-	Hatchback Engine HNE(EB2DT)	•		GWB3657	
	2013.01-	Hatchback Engine HNE(EB2DT)		○	GWB6544	
	2013.01-	Hatchback Engine HNE(EB2DT)		○	GWB6726	
1.4 (70 kW)	2012.03-	Hatchback Engine EP3C/8FS(EP3)	•		GHA421003	
	2012.03-	Hatchback Engine EP3C/8FS(EP3)	•		GHA425022	
	2012.03-	Hatchback Engine EP3C/8FS(EP3)	•		GWB3584	
	2012.03-	Hatchback Engine EP3C/8FS(EP3)	•		GWB3657	
	2012.03-	Hatchback Engine EP3C/8FS(EP3)		○	GWB6544	
	2012.03-	Hatchback Engine EP3C/8FS(EP3)		○	GWB6726	
1.4 GPL (70 kW)	2013.10-	Hatchback Engine EP3C	•		GHA421003	
	2013.10-	Hatchback Engine EP3C	•		GHA425022	
1.4 HDi (50 kW)	2012.03-	Hatchback Engine 8HP(DV4C)/8HR(DV4C)	•		GHA421003	
	2012.03-	Hatchback Engine 8HP(DV4C)/8HR(DV4C)	•		GHA425022	
	2012.03-	Hatchback Engine 8HP(DV4C)/8HR(DV4C)	•		GWB3584	
	2012.03-	Hatchback Engine 8HP(DV4C)/8HR(DV4C)	•		GWB3657	
	2012.03-	Hatchback Engine 8HP(DV4C)/8HR(DV4C)		○	GWB6544	
	2012.03-	Hatchback Engine 8HP(DV4C)/8HR(DV4C)		○	GWB6726	
1.6 (115 kW)	2012.03-	Hatchback Engine 5FV(EP6DT)/EP6CDT	•		GHA421003	
	2012.03-	Hatchback Engine 5FV(EP6DT)/EP6CDT	•		GHA425022	
	2012.03-	Hatchback Engine 5FV(EP6DT)/EP6CDT	•		GWB3584	
	2012.03-	Hatchback Engine 5FV(EP6DT)/EP6CDT	•		GWB3657	
	2012.03-	Hatchback Engine 5FV(EP6DT)/EP6CDT		○	GWB6544	
	2012.03-	Hatchback Engine 5FV(EP6DT)/EP6CDT		○	GWB6726	
1.6 (88 kW)	2012.03-	Hatchback Engine 5FS(EP6C)	•		GHA421003	
	2012.03-	Hatchback Engine 5FS(EP6C)	•		GHA425022	
	2012.03-	Hatchback Engine 5FS(EP6C)	•		GWB3584	
	2012.03-	Hatchback Engine 5FS(EP6C)	•		GWB3657	
	2012.03-	Hatchback Engine 5FS(EP6C)		○	GWB6544	
	2012.03-	Hatchback Engine 5FS(EP6C)		○	GWB6726	
1.6 BlueHDi (73 kW)	2015.01-	Hatchback Engine BHY(DV6FD)	•		GWB3584	
	2015.01-	Hatchback Engine BHY(DV6FD)	•		GWB3657	
	2015.01-	Hatchback Engine BHY(DV6FD)		○	GWB6726	
1.6 BlueHDi (88 kW)	2013.11-	Hatchback	•		GHA421003	
	2013.11-	Hatchback	•		GWB3584	
	2013.11-	Hatchback	•		GWB3657	
	2013.11-	Hatchback		○	GWB6726	
1.6 GTi (147 kW)	2012.08-	Hatchback Engine 5FU(EP6CDTX)	•		GHA421003	
	2012.08-	Hatchback Engine 5FU(EP6CDTX)	•		GHA425022	
	2012.08-	Hatchback Engine 5FU(EP6CDTX)	•		GWB3584	
	2012.08-	Hatchback Engine 5FU(EP6CDTX)	•		GWB3657	
	2012.08-	Hatchback Engine 5FU(EP6CDTX)		○	GWB6544	



	 YEAR		F	R	G-AP Ref.	KIT
PEUGEOT						
208						
1.6 GTi (147 kW)	2012.08-	Hatchback Engine 5FU(EP6CDTX)		o	GWB6726	
1.6 GTi (153 kW)	2014.10-	Hatchback	•		GHA421003	
	2014.10-	Hatchback	•		GHA425022	
	2014.10-	Hatchback	•		GWB3584	
	2014.10-	Hatchback	•		GWB3657	
1.6 HDi (68 kW)	2012.03-	Hatchback Engine 9HP(DV6DTED)	•		GHA421003	
	2012.03-	Hatchback Engine 9HP(DV6DTED)	•		GHA425022	
	2012.03-	Hatchback Engine 9HP(DV6DTED)	•		GWB3584	
	2012.03-	Hatchback Engine 9HP(DV6DTED)	•		GWB3657	
	2012.03-	Hatchback Engine 9HP(DV6DTED)		o	GWB6544	
	2012.03-	Hatchback Engine 9HP(DV6DTED)		o	GWB6726	
1.6 HDi (84 kW)	2012.03-	Hatchback	•		GHA421003	
	2012.03-	Hatchback	•		GHA425022	
	2012.03-	Hatchback	•		GWB3584	
	2012.03-	Hatchback	•		GWB3657	
	2012.03-	Hatchback		o	GWB6544	
	2012.03-	Hatchback		o	GWB6726	
1.6 HDi (85 kW)	2014.04-	Hatchback Engine BHX (DV6FC)	•		GHA421003	
1.6 HDi / BlueHDi 75 (55 kW)	2013.01-	Hatchback Engine 9HK (DV6ETEDM)/BHW (DV6FE)	•		GWB3584	
	2013.01-	Hatchback Engine 9HK (DV6ETEDM)/BHW (DV6FE)	•		GWB3657	
	2013.01-	Hatchback Engine 9HK (DV6ETEDM)/BHW (DV6FE)		o	GWB6544	
	2013.01-	Hatchback Engine 9HK (DV6ETEDM)/BHW (DV6FE)		o	GWB6726	
1.6 THP 165 (121 kW)	2015.03-	Hatchback	•		GWB3584	
	2015.03-	Hatchback	•		GWB3657	
	2015.03-	Hatchback		o	GWB6726	
3008						
1.2 (96 kW)	2015.01-	MPV	•		GWB3584	
	2015.01-	MPV		o	GWB6549	
1.6 BlueHDi 120 (88 kW)	2014.05-	MPV Engine BHZ (DV6FC)	•		GWB3584	
	2014.05-	MPV Engine BHZ (DV6FC)		o	GWB6549	
1.6 HDi (80 kW)	2009.06-	MPV Engine 9HZ(DV6TED4)	•		GHA425022	
	2009.06-	MPV Engine 9HZ(DV6TED4)	•		GWB3584	
	2009.06-	MPV Engine 9HZ(DV6TED4)		o	GWB6549	
1.6 HDi (82 kW)	2010.08-	MPV Engine 9HR(DV6C)	•		GHA425022	
	2010.08-	MPV Engine 9HR(DV6C)	•		GWB3584	
	2010.08-	MPV Engine 9HR(DV6C)		o	GWB6549	
1.6 HDi (84 kW)	2013.03-	MPV Engine 9HD(DV6CTED)	•		GHA425022	
	2013.03-	MPV Engine 9HD(DV6CTED)	•		GWB3584	
	2013.03-	MPV Engine 9HD(DV6CTED)		o	GWB6549	
1.6 THP (110 kW)	2009.06-	MPV Engine 5FX(EP6DT)	•		GHA425022	
	2009.06-	MPV Engine 5FX(EP6DT)	•		GWB3584	
	2009.06-	MPV Engine 5FX(EP6DT)		o	GWB6549	
1.6 THP (115 kW)	2009.06-	MPV Engine 5FV(EP6DT)	•		GHA425022	
	2009.06-	MPV Engine 5FV(EP6DT)	•		GWB3584	
	2009.06-	MPV Engine 5FV(EP6DT)		o	GWB6549	
1.6 Turbo (121 kW)	2014.05-	MPV Engine 5GZ (EP6FDT)	•		GWB3584	
1.6 VTi (88 kW)	2009.06-	MPV Engine 5FS(EP6C)/EP6	•		GHA425022	
	2009.06-	MPV Engine 5FS(EP6C)/EP6	•		GWB3584	
	2009.06-	MPV Engine 5FS(EP6C)/EP6		o	GWB6549	
2.0 HDi (100 kW)	2011.09-	MPV	•		GWB3584	
	2011.09-	MPV		o	GWB6549	
2.0 HDi (110 kW)	2009.06-	MPV Engine RHE(DW10CTED4)/AHX(DW10FD)	•		GHA425022	
	2009.06-	MPV Engine RHE(DW10CTED4)/AHX(DW10FD)	•		GWB3584	
	2009.06-	MPV Engine RHE(DW10CTED4)/AHX(DW10FD)		o	GWB6549	
2.0 HDi (120 kW)	2009.06-	MPV Engine RHH(DW10CTED4)	•		GHA425022	
	2009.06-	MPV Engine RHH(DW10CTED4)	•		GWB3584	
	2009.06-	MPV Engine RHH(DW10CTED4)		o	GWB6549	
2.0 HDi HybrID4 (120 kW)	2011.02-	MPV Engine RHH(DW10CTED4)	•		GHA425022	
	2011.02-	MPV Engine RHH(DW10CTED4)	•		GWB3584	
	2011.02-	MPV Engine RHH(DW10CTED4)		o	GWB3683	
2.0 HDi HybrID4 (147 kW)	2011.11-	MPV	•		GWB3584	
	2011.11-	MPV		o	GWB3683	
301						
1.2 VTi 72 (53 kW)	2012.11-	Saloon	•		GHA421003	



	 YEAR		F	R	G-AP Ref.	KIT
PEUGEOT						
301						
1.2 VTi 72 (53 kW)	2012.11- 2012.11-	Saloon Saloon	•	○	GWB3657 GWB6726	
1.6 HDi (68 kW)	2012.11- 2012.11- 2012.11-	Saloon Engine 9HF(DV6DTE) Saloon Engine 9HF(DV6DTE) Saloon Engine 9HF(DV6DTE)	•	○	GHA421003 GWB3657 GWB6726	
1.6 VTi (85 kW)	2012.11- 2012.11- 2012.11-	Saloon Engine NFP(EC5) Saloon Engine NFP(EC5) Saloon Engine NFP(EC5)	•	○	GHA421003 GWB3657 GWB6726	
306 (7A, 7C, N3, N5)						
1.1 (44 kW)	1993.05-2001.05 1993.05-2001.05 1993.05-2001.05 1993.05-2001.05 1993.05-2001.05 1993.05-2001.05 1993.05-2001.05	Hatchback Engine HDZ(TU1M) Hatchback Engine HDZ(TU1M) Hatchback Engine HDZ(TU1M) Hatchback Engine HDZ(TU1M) Hatchback Engine HDZ(TU1M) Hatchback Engine HDZ(TU1M) Hatchback Engine HDZ(TU1M)	•	○	GHA425022 GWB0882 GWB0915 GWB3554A GHA225009 GHA225037 GWB0961 GWB3556	A K
1.4 (55 kW)	1993.05-2001.05 1993.05-2001.05 1993.05-2001.05 1993.05-2001.05 1993.05-2001.05 1993.05-2001.05 1993.05-2001.05 1993.05-2001.05 1993.05-2001.05 1993.05-2001.05	Hatchback Engine KDX(TU3MC)/KFW(TU3JP)/KFX(TU3JP) Hatchback Engine KDX(TU3MC)/KFW(TU3JP)/KFX(TU3JP) Hatchback Engine KDX(TU3MC)/KFW(TU3JP)/KFX(TU3JP) Hatchback Engine KDX(TU3MC)/KFW(TU3JP)/KFX(TU3JP) Hatchback Engine KDX(TU3MC)/KFW(TU3JP)/KFX(TU3JP) Hatchback Engine KDX(TU3MC)/KFW(TU3JP)/KFX(TU3JP) Hatchback Engine KDX(TU3MC)/KFW(TU3JP)/KFX(TU3JP) Hatchback Engine KDX(TU3MC)/KFW(TU3JP)/KFX(TU3JP) Hatchback Engine KDX(TU3MC)/KFW(TU3JP)/KFX(TU3JP) Hatchback Engine KDX(TU3MC)/KFW(TU3JP)/KFX(TU3JP)	•	○	GHA421003 GHA425022 GWB0882 GWB0915 GWB3554A GHA225009 GHA225012 GHA225037 GWB0961 GWB3556	A K
1.6 (65 kW)	1993.05-2000.10 1993.05-2000.10 1993.05-2000.10 1993.05-2000.10 1993.05-2000.10 1993.05-2000.10 1993.05-2000.10 1993.05-2000.10 1993.05-2000.10	Hatchback Engine NFZ(TU5JP) Hatchback Engine NFZ(TU5JP) Hatchback Engine NFZ(TU5JP) Hatchback Engine NFZ(TU5JP) Hatchback Engine NFZ(TU5JP) Hatchback Engine NFZ(TU5JP) Hatchback Engine NFZ(TU5JP) Hatchback Engine NFZ(TU5JP) Hatchback Engine NFZ(TU5JP)	•	○	GHA425022 GWB0882 GWB0915 GWB3554A GHA225009 GHA225012 GHA225037 GWB0961 GWB3556	A K
1.6 (66 kW)	2000.07-2001.05 2000.07-2001.05 2000.07-2001.05 2000.07-2001.05	Hatchback Hatchback Hatchback Hatchback	•	○	GWB0882 GWB0915 GWB3554A GWB3556	
1.6 (72 kW)	2000.10-2001.05 2000.10-2001.05 2000.10-2001.05 2000.10-2001.05 2000.10-2001.05 2000.10-2001.05	Hatchback Engine NFT Hatchback Engine NFT Hatchback Engine NFT Hatchback Engine NFT Hatchback Engine NFT Hatchback Engine NFT	•	○	GHA421003 GHA425022 GWB0882 GWB0915 GWB3554A GWB3556	
1.8 (74 kW)	1993.05-2001.05 1993.05-2001.05 1993.05-2001.05 1993.05-2001.05 1993.05-2001.05 1993.05-2001.05 1993.05-2001.05 1993.05-2001.05 1997.05-1999.04 1997.05-1999.04 1997.05-1999.04 1997.05-1999.04 1997.05-1999.04 1997.05-1999.04 1997.05-1999.04 1997.05-1999.04	Hatchback Engine LfZ(XU7JP) Hatchback Engine LfZ(XU7JP) Hatchback Engine LfZ(XU7JP) Hatchback Engine LfZ(XU7JP) Hatchback Engine LfZ(XU7JP) Hatchback Engine LfZ(XU7JP) Hatchback Engine LfZ(XU7JP) Hatchback Engine LfZ(XU7JP) Hatchback Engine LfZ(XU7JP) Hatchback Engine LfZ(XU7JP) Hatchback Engine LfZ(XU7JP) Hatchback Engine LfZ(XU7JP) Hatchback Engine LfZ(XU7JP) Hatchback Engine LfZ(XU7JP) Hatchback Engine LfZ(XU7JP) Hatchback Engine LfZ(XU7JP) Hatchback Engine LfZ(XU7JP)	•	○	GHA425022 GWB0915 GHA225009 GHA225012 GHA225013 GHA225037 GWB0961 GWB3556 GHA425022 GWB0915 GHA225012 GHA225013 GHA225037 GWB0961 GWB3556	A K K K
1.8 16V (81 kW)	1997.03-2001.05 1997.03-2001.05 1997.03-2001.05	Hatchback Engine LfY(XU7JP4) Hatchback Engine LfY(XU7JP4) Hatchback Engine LfY(XU7JP4)	•	○	GHA425022 GWB0915 GHA225009	A



	 YEAR		F	R	G-AP Ref.	KIT
PEUGEOT						
306 (7A, 7C, N3, N5)						
1.8 16V (81 kW)	1997.03-2001.05	Hatchback Engine LFY(XU7JP4)		o	GHA225012	K
	1997.03-2001.05	Hatchback Engine LFY(XU7JP4)		o	GHA225013	K
	1997.03-2001.05	Hatchback Engine LFY(XU7JP4)		o	GHA225037	K
	1997.03-2001.05	Hatchback Engine LFY(XU7JP4)		o	GWB0961	
	1997.03-2001.05	Hatchback Engine LFY(XU7JP4)		o	GWB3556	
1.8 D (43 kW)	1993.05-2001.05	Hatchback Engine A9A(XUD7)	•		GHA425022	
	1993.05-2001.05	Hatchback Engine A9A(XUD7)	•		GWB0915	
	1993.05-2001.05	Hatchback Engine A9A(XUD7)		o	GHA225009	A
	1993.05-2001.05	Hatchback Engine A9A(XUD7)		o	GHA225012	K
	1993.05-2001.05	Hatchback Engine A9A(XUD7)		o	GHA225013	K
	1993.05-2001.05	Hatchback Engine A9A(XUD7)		o	GHA225037	K
	1993.05-2001.05	Hatchback Engine A9A(XUD7)		o	GWB0961	
1.8 D (44 kW)	1993.04-1999.05	Hatchback Engine A9A (XUD7)	•		GHA425022	
	1993.04-1999.05	Hatchback Engine A9A (XUD7)	•		GWB0915	
1.9 D (47 kW)	1993.05-2001.05	Hatchback Engine DJZ(XUD9Y)	•		GHA425022	
	1993.05-2001.05	Hatchback Engine DJZ(XUD9Y)	•		GWB0915	
	1993.05-2001.05	Hatchback Engine DJZ(XUD9Y)		o	GHA225009	A
	1993.05-2001.05	Hatchback Engine DJZ(XUD9Y)		o	GHA225012	K
	1993.05-2001.05	Hatchback Engine DJZ(XUD9Y)		o	GHA225013	K
	1993.05-2001.05	Hatchback Engine DJZ(XUD9Y)		o	GHA225037	K
	1993.05-2001.05	Hatchback Engine DJZ(XUD9Y)		o	GWB0961	
	1993.05-2001.05	Hatchback Engine DJZ(XUD9Y)		o	GWB3556	
1.9 D (50 kW)	1994.06-2001.05	Hatchback Engine DJY(XUD9A)	•		GHA425022	
	1994.06-2001.05	Hatchback Engine DJY(XUD9A)	•		GWB0915	
	1994.06-2001.05	Hatchback Engine DJY(XUD9A)		o	GHA225009	A
	1994.06-2001.05	Hatchback Engine DJY(XUD9A)		o	GHA225012	K
	1994.06-2001.05	Hatchback Engine DJY(XUD9A)		o	GHA225013	K
	1994.06-2001.05	Hatchback Engine DJY(XUD9A)		o	GHA225037	K
	1994.06-2001.05	Hatchback Engine DJY(XUD9A)		o	GWB0961	
1.9 D (51 kW)	1993.04-1999.05	Hatchback Engine XUD9	•		GHA425022	
	1993.04-1999.05	Hatchback Engine XUD9	•		GWB0915	
	1993.04-1999.05	Hatchback Engine XUD9		o	GHA225012	K
	1993.04-1999.05	Hatchback Engine XUD9		o	GHA225013	K
	1993.04-1999.05	Hatchback Engine XUD9		o	GHA225037	K
	1993.04-1999.05	Hatchback Engine XUD9		o	GWB0961	
	1993.04-1999.05	Hatchback Engine XUD9		o	GWB3556	
	1998.09-2001.05	Hatchback Engine WJY(DW8B)/WJZ(DW8)	•		GHA425022	
	1998.09-2001.05	Hatchback Engine WJY(DW8B)/WJZ(DW8)	•		GWB0915	
	1998.09-2001.05	Hatchback Engine WJY(DW8B)/WJZ(DW8)		o	GHA225012	K
	1998.09-2001.05	Hatchback Engine WJY(DW8B)/WJZ(DW8)		o	GHA225013	K
	1998.09-2001.05	Hatchback Engine WJY(DW8B)/WJZ(DW8)		o	GHA225037	K
	1998.09-2001.05	Hatchback Engine WJY(DW8B)/WJZ(DW8)		o	GWB0961	
	1998.09-2001.05	Hatchback Engine WJY(DW8B)/WJZ(DW8)		o	GWB3556	
1.9 D (55 kW)	1998.03-2001.05	Hatchback Engine DHV(XUD9BSD)	•		GHA425022	
	1998.03-2001.05	Hatchback Engine DHV(XUD9BSD)	•		GWB0915	
	1998.03-2001.05	Hatchback Engine DHV(XUD9BSD)		o	GHA225012	K
	1998.03-2001.05	Hatchback Engine DHV(XUD9BSD)		o	GHA225013	K
	1998.03-2001.05	Hatchback Engine DHV(XUD9BSD)		o	GHA225037	K
	1998.03-2001.05	Hatchback Engine DHV(XUD9BSD)		o	GWB0961	
1.9 D (69 kW)	1993.04-1997.04	Hatchback Engine XUD9TE	•		GHA425022	
	1993.04-1997.04	Hatchback Engine XUD9TE	•		GWB0915	
	1993.04-1997.04	Hatchback Engine XUD9TE		o	GHA225037	K
	1993.04-1997.04	Hatchback Engine XUD9TE		o	GWB0961	
1.9 DT (66 kW)	1993.05-2001.05	Hatchback Engine DHY(XUD9TE)	•		GHA425022	
	1993.05-2001.05	Hatchback Engine DHY(XUD9TE)	•		GWB0915	
	1993.05-2001.05	Hatchback Engine DHY(XUD9TE)		o	GHA225009	A
	1993.05-2001.05	Hatchback Engine DHY(XUD9TE)		o	GHA225012	K
	1993.05-2001.05	Hatchback Engine DHY(XUD9TE)		o	GHA225013	K
	1993.05-2001.05	Hatchback Engine DHY(XUD9TE)		o	GHA225037	K
	1993.05-2001.05	Hatchback Engine DHY(XUD9TE)		o	GWB0961	
2.0 16V (97 kW)	1997.03-2001.05	Hatchback Engine RFV(XU10J4R)	•		GHA425022	



	 YEAR		F	R	G-AP Ref.	KIT	
PEUGEOT							
306 (7A, 7C, N3, N5)							
2.0 16V (97 kW)	1997.03-2001.05	Hatchback Engine RFV(XU10J4R)	•		GWB0915		
	1997.03-2001.05	Hatchback Engine RFV(XU10J4R)		◦	GHA225009	A	
	1997.03-2001.05	Hatchback Engine RFV(XU10J4R)		◦	GHA225012	K	
	1997.03-2001.05	Hatchback Engine RFV(XU10J4R)		◦	GHA225013	K	
	1997.03-2001.05	Hatchback Engine RFV(XU10J4R)		◦	GHA225037	K	
	1997.03-2001.05	Hatchback Engine RFV(XU10J4R)		◦	GWB0961		
	1997.03-2001.05	Hatchback Engine RFV(XU10J4R)		◦	GWB3556		
2.0 16V (99 kW)	1997.03-2000.06	Hatchback Engine RFV(XU10J4R)	•		GWB0915		
	1997.03-2000.06	Hatchback Engine RFV(XU10J4R)		◦	GHA225013	K	
	1997.03-2000.06	Hatchback Engine RFV(XU10J4R)		◦	GWB0961		
	1997.03-2000.06	Hatchback Engine RFV(XU10J4R)		◦	GWB3556		
2.0 HDi (66 kW)	1999.06-2001.05	Hatchback Engine RHY(DW10TD)	•		GHA425022		
	1999.06-2001.05	Hatchback Engine RHY(DW10TD)	•		GWB0915		
	1999.06-2001.05	Hatchback Engine RHY(DW10TD)		◦	GHA225012	K	
	1999.06-2001.05	Hatchback Engine RHY(DW10TD)		◦	GHA225013	K	
2.0 S16 (110 kW)	1994.06-2001.05	Hatchback Engine RFT(XU10J4)	•		GHA425022		
	1994.06-2001.05	Hatchback Engine RFT(XU10J4)	•		GWB0915		
	1994.06-2001.05	Hatchback Engine RFT(XU10J4)		◦	GHA225009	A	
	1994.06-2001.05	Hatchback Engine RFT(XU10J4)		◦	GHA225012	K	
	1994.06-2001.05	Hatchback Engine RFT(XU10J4)		◦	GHA225013	K	
	1994.06-2001.05	Hatchback Engine RFT(XU10J4)		◦	GHA225037	K	
	1994.06-2001.05	Hatchback Engine RFT(XU10J4)		◦	GWB0961		
2.0 S16 (112 kW)	1993.05-2001.05	Hatchback Engine RFY(XU10J4Z)	•		GHA425022		
	1993.05-2001.05	Hatchback Engine RFY(XU10J4Z)	•		GWB0915		
	1993.05-2001.05	Hatchback Engine RFY(XU10J4Z)		◦	GHA225009	A	
	1993.05-2001.05	Hatchback Engine RFY(XU10J4Z)		◦	GHA225012	K	
	1993.05-2001.05	Hatchback Engine RFY(XU10J4Z)		◦	GHA225013	K	
	1993.05-2001.05	Hatchback Engine RFY(XU10J4Z)		◦	GHA225037	K	
	1993.05-2001.05	Hatchback Engine RFY(XU10J4Z)		◦	GWB0961		
2.0 S16 (120 kW)	1996.03-2001.05	Hatchback Engine RFS(XU10J4RS)	•		GHA425022		
	1996.03-2001.05	Hatchback Engine RFS(XU10J4RS)	•		GWB0915		
	1996.03-2001.05	Hatchback Engine RFS(XU10J4RS)		◦	GHA225009	A	
	1996.03-2001.05	Hatchback Engine RFS(XU10J4RS)		◦	GHA225012	K	
	1996.03-2001.05	Hatchback Engine RFS(XU10J4RS)		◦	GHA225013	K	
	1996.03-2001.05	Hatchback Engine RFS(XU10J4RS)		◦	GHA225037	K	
	1996.03-2001.05	Hatchback Engine RFS(XU10J4RS)		◦	GWB0961		
2.0 XSi (89 kW)	1993.05-2001.05	Hatchback Engine RFX(XU10J2)	•		GHA425022		
	1993.05-2001.05	Hatchback Engine RFX(XU10J2)	•		GWB0915		
	1993.05-2001.05	Hatchback Engine RFX(XU10J2)		◦	GHA225009	A	
	1993.05-2001.05	Hatchback Engine RFX(XU10J2)		◦	GHA225012	K	
	1993.05-2001.05	Hatchback Engine RFX(XU10J2)		◦	GHA225013	K	
	1993.05-2001.05	Hatchback Engine RFX(XU10J2)		◦	GHA225037	K	
	1993.05-2001.05	Hatchback Engine RFX(XU10J2)		◦	GWB0961		
306 (7B, N3, N5)							
	1.1 (44 kW)	1994.06-2001.05	Saloon Engine HDZ(TU1M)	•		GHA425022	
		1994.06-2001.05	Saloon Engine HDZ(TU1M)	•		GWB0882	
		1994.06-2001.05	Saloon Engine HDZ(TU1M)	•		GWB0915	
		1994.06-2001.05	Saloon Engine HDZ(TU1M)	•		GWB3554A	
		1994.06-2001.05	Saloon Engine HDZ(TU1M)		◦	GHA225009	A
		1994.06-2001.05	Saloon Engine HDZ(TU1M)		◦	GHA225012	K
		1994.06-2001.05	Saloon Engine HDZ(TU1M)		◦	GHA225037	K
	1.4 SL (55 kW)	1994.06-2001.05	Saloon Engine HDZ(TU1M)		◦	GWB0961	
		1994.06-2001.05	Saloon Engine HDZ(TU1M)		◦	GWB3556	
		1994.06-2001.05	Saloon Engine KDX(TU3MC)/KFW(TU3JP)/KFX(TU3JP)	•		GHA425022	
		1994.06-2001.05	Saloon Engine KDX(TU3MC)/KFW(TU3JP)/KFX(TU3JP)	•		GWB0882	
		1994.06-2001.05	Saloon Engine KDX(TU3MC)/KFW(TU3JP)/KFX(TU3JP)	•		GWB0915	
		1994.06-2001.05	Saloon Engine KDX(TU3MC)/KFW(TU3JP)/KFX(TU3JP)	•		GWB3554A	
1994.06-2001.05		Saloon Engine KDX(TU3MC)/KFW(TU3JP)/KFX(TU3JP)		◦	GHA225009	A	
1994.06-2001.05	Saloon Engine KDX(TU3MC)/KFW(TU3JP)/KFX(TU3JP)		◦	GHA225012	K		



	 YEAR		F	R	G-AP Ref.	KIT
PEUGEOT						
306 (7B, N3, N5)						
1.4 SL (55 kW)	1994.06-2001.05	Saloon Engine KDX(TU3MC)/KFW(TU3JP)/KFX(TU3JP)		o	GHA225013	K
	1994.06-2001.05	Saloon Engine KDX(TU3MC)/KFW(TU3JP)/KFX(TU3JP)		o	GHA225037	K
	1994.06-2001.05	Saloon Engine KDX(TU3MC)/KFW(TU3JP)/KFX(TU3JP)		o	GWB0961	
	1994.06-2001.05	Saloon Engine KDX(TU3MC)/KFW(TU3JP)/KFX(TU3JP)		o	GWB3556	
1.6 (66 kW)	2000.07-2001.05	Saloon	•		GWB0882	
	2000.07-2001.05	Saloon	•		GWB0915	
	2000.07-2001.05	Saloon	•		GWB3554A	
	2000.07-2001.05	Saloon		o	GWB3556	
1.6 (72 kW)	2000.10-2001.05	Saloon Engine NFT	•		GHA421003	
	2000.10-2001.05	Saloon Engine NFT	•		GHA425022	
	2000.10-2001.05	Saloon Engine NFT	•		GWB0882	
	2000.10-2001.05	Saloon Engine NFT	•		GWB0915	
	2000.10-2001.05	Saloon Engine NFT	•		GWB3554A	
	2000.10-2001.05	Saloon Engine NFT		o	GWB3556	
1.6 SR (65 kW)	1994.06-2000.10	Saloon Engine NFZ(TU5JP)	•		GHA425022	
	1994.06-2000.10	Saloon Engine NFZ(TU5JP)	•		GWB0882	
	1994.06-2000.10	Saloon Engine NFZ(TU5JP)	•		GWB0915	
	1994.06-2000.10	Saloon Engine NFZ(TU5JP)	•		GWB3554A	
	1994.06-2000.10	Saloon Engine NFZ(TU5JP)		o	GHA225009	A
	1994.06-2000.10	Saloon Engine NFZ(TU5JP)		o	GHA225012	K
	1994.06-2000.10	Saloon Engine NFZ(TU5JP)		o	GHA225037	K
	1994.06-2000.10	Saloon Engine NFZ(TU5JP)		o	GWB0961	
	1994.06-2000.10	Saloon Engine NFZ(TU5JP)		o	GWB3556	
1.8 (74 kW)	1995.10-1997.04	Saloon Engine LFZ(XU7JP)	•		GHA425022	
	1995.10-1997.04	Saloon Engine LFZ(XU7JP)	•		GWB0915	
	1995.10-1997.04	Saloon Engine LFZ(XU7JP)		o	GHA225037	K
	1995.10-1997.04	Saloon Engine LFZ(XU7JP)		o	GWB0961	
1.8 16V (81 kW)	1997.03-2001.05	Saloon Engine LFY(XU7JP4)	•		GHA425022	
	1997.03-2001.05	Saloon Engine LFY(XU7JP4)	•		GWB0915	
	1997.03-2001.05	Saloon Engine LFY(XU7JP4)		o	GHA225009	A
	1997.03-2001.05	Saloon Engine LFY(XU7JP4)		o	GHA225012	K
	1997.03-2001.05	Saloon Engine LFY(XU7JP4)		o	GHA225013	K
	1997.03-2001.05	Saloon Engine LFY(XU7JP4)		o	GHA225037	K
	1997.03-2001.05	Saloon Engine LFY(XU7JP4)		o	GWB0961	
	1997.03-2001.05	Saloon Engine LFY(XU7JP4)		o	GWB3556	
1.8 ST (74 kW)	1994.06-2001.05	Saloon Engine LFZ(XU7JP)	•		GHA425022	
	1994.06-2001.05	Saloon Engine LFZ(XU7JP)	•		GWB0915	
	1994.06-2001.05	Saloon Engine LFZ(XU7JP)		o	GHA225009	A
	1994.06-2001.05	Saloon Engine LFZ(XU7JP)		o	GHA225012	K
	1994.06-2001.05	Saloon Engine LFZ(XU7JP)		o	GHA225013	K
	1994.06-2001.05	Saloon Engine LFZ(XU7JP)		o	GHA225037	K
	1994.06-2001.05	Saloon Engine LFZ(XU7JP)		o	GWB0961	
	1994.06-2001.05	Saloon Engine LFZ(XU7JP)		o	GWB3556	
1.9 D (51 kW)	1998.09-2001.05	Saloon Engine WJY(DW8B)/WJZ(DW8)	•		GHA425022	
	1998.09-2001.05	Saloon Engine WJY(DW8B)/WJZ(DW8)	•		GWB0915	
	1998.09-2001.05	Saloon Engine WJY(DW8B)/WJZ(DW8)		o	GHA225012	K
	1998.09-2001.05	Saloon Engine WJY(DW8B)/WJZ(DW8)		o	GHA225013	K
	1998.09-2001.05	Saloon Engine WJY(DW8B)/WJZ(DW8)		o	GHA225037	K
	1998.09-2001.05	Saloon Engine WJY(DW8B)/WJZ(DW8)		o	GWB0961	
	1998.09-2001.05	Saloon Engine WJY(DW8B)/WJZ(DW8)		o	GWB3556	
1.9 D (55 kW)	1998.03-2001.05	Saloon Engine DHV(XUD9BSD)	•		GHA425022	
	1998.03-2001.05	Saloon Engine DHV(XUD9BSD)	•		GWB0915	
	1998.03-2001.05	Saloon Engine DHV(XUD9BSD)		o	GHA225012	K
	1998.03-2001.05	Saloon Engine DHV(XUD9BSD)		o	GHA225013	K
	1998.03-2001.05	Saloon Engine DHV(XUD9BSD)		o	GHA225037	K
	1998.03-2001.05	Saloon Engine DHV(XUD9BSD)		o	GWB0961	
	1998.03-2001.05	Saloon Engine DHV(XUD9BSD)		o	GWB3556	
1.9 D (69 kW)	1994.02-1997.04	Saloon Engine XUD9TE	•		GHA425022	
	1994.02-1997.04	Saloon Engine XUD9TE	•		GWB0915	
	1994.02-1997.04	Saloon Engine XUD9TE		o	GHA225037	K
	1994.02-1997.04	Saloon Engine XUD9TE		o	GWB0961	
1.9 SLD (47 kW)	1994.06-2001.05	Saloon Engine DJZ(XUD9Y)	•		GHA425022	
	1994.06-2001.05	Saloon Engine DJZ(XUD9Y)	•		GWB0915	
	1994.06-2001.05	Saloon Engine DJZ(XUD9Y)		o	GHA225009	A



	 YEAR		F	R	G-AP Ref.	KIT
PEUGEOT						
306 (7B, N3, N5)						
1.9 SLD (47 kW)	1994.06-2001.05	Saloon Engine DJZ(XUD9Y)		o	GHA225012	K
	1994.06-2001.05	Saloon Engine DJZ(XUD9Y)		o	GHA225013	K
	1994.06-2001.05	Saloon Engine DJZ(XUD9Y)		o	GHA225037	K
	1994.06-2001.05	Saloon Engine DJZ(XUD9Y)		o	GWB0961	
	1994.06-2001.05	Saloon Engine DJZ(XUD9Y)		o	GWB3556	
1.9 SLD (50 kW)	1994.06-2001.05	Saloon Engine DJY(XUD9A)	•		GHA425022	
	1994.06-2001.05	Saloon Engine DJY(XUD9A)	•		GWB0915	
	1994.06-2001.05	Saloon Engine DJY(XUD9A)		o	GHA225009	A
	1994.06-2001.05	Saloon Engine DJY(XUD9A)		o	GHA225012	K
	1994.06-2001.05	Saloon Engine DJY(XUD9A)		o	GHA225013	K
	1994.06-2001.05	Saloon Engine DJY(XUD9A)		o	GHA225037	K
	1994.06-2001.05	Saloon Engine DJY(XUD9A)		o	GWB0961	
1.9 SRDT (66 kW)	1994.06-2001.05	Saloon Engine DHY(XUD9TE)	•		GHA425022	
	1994.06-2001.05	Saloon Engine DHY(XUD9TE)	•		GWB0915	
	1994.06-2001.05	Saloon Engine DHY(XUD9TE)		o	GHA225009	A
	1994.06-2001.05	Saloon Engine DHY(XUD9TE)		o	GHA225012	K
	1994.06-2001.05	Saloon Engine DHY(XUD9TE)		o	GHA225013	K
	1994.06-2001.05	Saloon Engine DHY(XUD9TE)		o	GHA225037	K
	1994.06-2001.05	Saloon Engine DHY(XUD9TE)		o	GWB0961	
1.9 STD (51 kW)	1994.02-1995.10	Saloon Engine XUD9	•		GHA425022	
	1994.02-1995.10	Saloon Engine XUD9	•		GWB0915	
	1994.02-1995.10	Saloon Engine XUD9		o	GHA225009	A
	1994.02-1995.10	Saloon Engine XUD9		o	GHA225037	K
	1994.02-1995.10	Saloon Engine XUD9		o	GWB0961	
2.0 (97 kW)	1997.03-2001.05	Saloon Engine RFV(XU10J4R)	•		GHA425022	
	1997.03-2001.05	Saloon Engine RFV(XU10J4R)	•		GWB0915	
	1997.03-2001.05	Saloon Engine RFV(XU10J4R)		o	GHA225009	A
	1997.03-2001.05	Saloon Engine RFV(XU10J4R)		o	GHA225012	K
	1997.03-2001.05	Saloon Engine RFV(XU10J4R)		o	GHA225013	K
	1997.03-2001.05	Saloon Engine RFV(XU10J4R)		o	GHA225037	K
	1997.03-2001.05	Saloon Engine RFV(XU10J4R)		o	GWB0961	
2.0 HDi (66 kW)	1999.06-2001.05	Saloon Engine RHY(DW10TD)	•		GHA425022	
	1999.06-2001.05	Saloon Engine RHY(DW10TD)	•		GWB0915	
	1999.06-2001.05	Saloon Engine RHY(DW10TD)		o	GHA225012	K
	1999.06-2001.05	Saloon Engine RHY(DW10TD)		o	GHA225013	K
	1999.06-2001.05	Saloon Engine RHY(DW10TD)		o	GWB3556	
2.0 S16 (110 kW)	1994.06-2001.05	Saloon Engine RFT(XU10J4)	•		GHA425022	
	1994.06-2001.05	Saloon Engine RFT(XU10J4)	•		GWB0915	
	1994.06-2001.05	Saloon Engine RFT(XU10J4)		o	GHA225009	A
	1994.06-2001.05	Saloon Engine RFT(XU10J4)		o	GHA225012	K
	1994.06-2001.05	Saloon Engine RFT(XU10J4)		o	GHA225013	K
	1994.06-2001.05	Saloon Engine RFT(XU10J4)		o	GHA225037	K
	1994.06-2001.05	Saloon Engine RFT(XU10J4)		o	GWB0961	
2.0 S16 (112 kW)	1994.06-2001.05	Saloon Engine RFY(XU10J4Z)	•		GHA425022	
	1994.06-2001.05	Saloon Engine RFY(XU10J4Z)	•		GWB0915	
	1994.06-2001.05	Saloon Engine RFY(XU10J4Z)		o	GHA225012	K
	1994.06-2001.05	Saloon Engine RFY(XU10J4Z)		o	GHA225013	K
	1994.06-2001.05	Saloon Engine RFY(XU10J4Z)		o	GHA225037	K
	1994.06-2001.05	Saloon Engine RFY(XU10J4Z)		o	GWB0961	
	1994.06-2001.05	Saloon Engine RFY(XU10J4Z)		o	GWB3556	
2.0 ST (89 kW)	1994.07-2001.05	Saloon Engine RFX(XU10J2)	•		GHA425022	
	1994.07-2001.05	Saloon Engine RFX(XU10J2)	•		GWB0915	
	1994.07-2001.05	Saloon Engine RFX(XU10J2)		o	GHA225009	A
	1994.07-2001.05	Saloon Engine RFX(XU10J2)		o	GHA225012	K
	1994.07-2001.05	Saloon Engine RFX(XU10J2)		o	GHA225013	K
	1994.07-2001.05	Saloon Engine RFX(XU10J2)		o	GHA225037	K
	1994.07-2001.05	Saloon Engine RFX(XU10J2)		o	GWB0961	
306 (7D, N3, N5)						
1.6 (65 kW)	1996.04-2000.10	Convertible Engine NFZ(TU5JP)	•		GHA425022	



	 YEAR		F	R	G-AP Ref.	KIT
PEUGEOT						
306 (7D, N3, N5)						
1.6 (65 kW)	1996.04-2000.10	Convertible Engine NFZ(TU5JP)	•		GWB0882	
	1996.04-2000.10	Convertible Engine NFZ(TU5JP)	•		GWB0915	
	1996.04-2000.10	Convertible Engine NFZ(TU5JP)	•		GWB3554A	
	1996.04-2000.10	Convertible Engine NFZ(TU5JP)		○	GHA225009	A
	1996.04-2000.10	Convertible Engine NFZ(TU5JP)		○	GWB0961	
	1996.04-2000.10	Convertible Engine NFZ(TU5JP)		○	GWB3556	
1.6 (72 kW)	2000.10-2002.04	Convertible Engine NFT	•		GHA421003	
	2000.10-2002.04	Convertible Engine NFT	•		GHA425022	
	2000.10-2002.04	Convertible Engine NFT	•		GWB0882	
	2000.10-2002.04	Convertible Engine NFT	•		GWB0915	
	2000.10-2002.04	Convertible Engine NFT	•		GWB3554A	
	2000.10-2002.04	Convertible Engine NFT		○	GHA225013	K
1.8 (74 kW)	2000.10-2002.04	Convertible Engine NFT		○	GWB3556	
	1994.03-2002.04	Convertible Engine LFZ(XU7JP)	•		GHA425022	
	1994.03-2002.04	Convertible Engine LFZ(XU7JP)	•		GWB0915	
	1994.03-2002.04	Convertible Engine LFZ(XU7JP)		○	GHA225009	A
	1994.03-2002.04	Convertible Engine LFZ(XU7JP)		○	GHA225013	K
	1994.03-2002.04	Convertible Engine LFZ(XU7JP)		○	GHA225037	K
1.8 16V (81 kW)	1994.03-2002.04	Convertible Engine LFZ(XU7JP)		○	GWB0961	
	1994.03-2002.04	Convertible Engine LFZ(XU7JP)		○	GWB3556	
	2000.07-2002.04	Convertible Engine LFY(XU7JP4)	•		GHA425022	
	2000.07-2002.04	Convertible Engine LFY(XU7JP4)	•		GWB0915	
	2000.07-2002.04	Convertible Engine LFY(XU7JP4)		○	GHA225013	K
	2000.07-2002.04	Convertible Engine LFY(XU7JP4)		○	GWB3556	
2.0 (89 kW)	1994.03-2002.04	Convertible Engine RFX(XU10J2)	•		GHA425022	
	1994.03-2002.04	Convertible Engine RFX(XU10J2)	•		GWB0915	
	1994.03-2002.04	Convertible Engine RFX(XU10J2)		○	GHA225009	A
	1994.03-2002.04	Convertible Engine RFX(XU10J2)		○	GHA225013	K
	1994.03-2002.04	Convertible Engine RFX(XU10J2)		○	GHA225037	K
	1994.03-2002.04	Convertible Engine RFX(XU10J2)		○	GWB0961	
2.0 16V (97 kW)	1994.03-2002.04	Convertible Engine RFX(XU10J2)		○	GWB3556	
	1997.03-2002.04	Convertible Engine RFV(XU10J4R)	•		GHA425022	
	1997.03-2002.04	Convertible Engine RFV(XU10J4R)	•		GWB0915	
	1997.03-2002.04	Convertible Engine RFV(XU10J4R)		○	GHA225009	A
	1997.03-2002.04	Convertible Engine RFV(XU10J4R)		○	GHA225013	K
	1997.03-2002.04	Convertible Engine RFV(XU10J4R)		○	GWB0961	
2.0 16V (99 kW)	1997.03-2002.04	Convertible Engine RFV(XU10J4R)		○	GWB3556	
	1997.03-2002.04	Convertible Engine RFV(XU10J4R)	•		GHA425022	
	1997.03-2002.04	Convertible Engine RFV(XU10J4R)	•		GWB0915	
	1997.03-2002.04	Convertible Engine RFV(XU10J4R)		○	GHA225013	K
	1997.03-2002.04	Convertible Engine RFV(XU10J4R)		○	GWB0961	
	1997.03-2002.04	Convertible Engine RFV(XU10J4R)		○	GWB3556	
306 BREAK (7E, N3, N5)						
1.4 (55 kW)	1997.03-2002.04	Estate Engine KFW(TU3JP)/KFX(TU3JP)	•		GHA421003	
	1997.03-2002.04	Estate Engine KFW(TU3JP)/KFX(TU3JP)	•		GHA425022	
	1997.03-2002.04	Estate Engine KFW(TU3JP)/KFX(TU3JP)	•		GWB0882	
	1997.03-2002.04	Estate Engine KFW(TU3JP)/KFX(TU3JP)	•		GWB0915	
	1997.03-2002.04	Estate Engine KFW(TU3JP)/KFX(TU3JP)	•		GWB3554A	
	1997.03-2002.04	Estate Engine KFW(TU3JP)/KFX(TU3JP)		○	GHA225012	K
	1997.03-2002.04	Estate Engine KFW(TU3JP)/KFX(TU3JP)		○	GHA225013	K
	1997.03-2002.04	Estate Engine KFW(TU3JP)/KFX(TU3JP)		○	GHA225037	K
1.6 (65 kW)	1997.03-2000.10	Estate Engine NFZ(TU5JP)	•		GHA421003	
	1997.03-2000.10	Estate Engine NFZ(TU5JP)	•		GHA425022	
	1997.03-2000.10	Estate Engine NFZ(TU5JP)	•		GWB0882	
	1997.03-2000.10	Estate Engine NFZ(TU5JP)	•		GWB0915	
	1997.03-2000.10	Estate Engine NFZ(TU5JP)	•		GWB3554A	
	1997.03-2000.10	Estate Engine NFZ(TU5JP)		○	GHA225012	K
	1997.03-2000.10	Estate Engine NFZ(TU5JP)		○	GHA225013	K
	1997.03-2000.10	Estate Engine NFZ(TU5JP)		○	GHA225037	K
1.6 (72 kW)	2000.10-2002.04	Estate Engine NFT	•		GHA421003	
	2000.10-2002.04	Estate Engine NFT	•		GHA425022	
	2000.10-2002.04	Estate Engine NFT	•		GWB0882	
	2000.10-2002.04	Estate Engine NFT	•		GWB0915	
	2000.10-2002.04	Estate Engine NFT	•		GWB3554A	



	 YEAR		F	R	G-AP Ref.	KIT
PEUGEOT						
306 BREAK (7E, N3, N5)						
1.6 (72 kW)	2000.10-2002.04	Estate Engine NFT		o	GHA225012	K
	2000.10-2002.04	Estate Engine NFT		o	GHA225013	K
1.8 (74 kW)	1997.03-2002.04	Estate Engine LFZ(XU7JP)	•		GHA425022	
	1997.03-2002.04	Estate Engine LFZ(XU7JP)	•		GWB0915	
	1997.03-2002.04	Estate Engine LFZ(XU7JP)		o	GHA225012	K
	1997.03-2002.04	Estate Engine LFZ(XU7JP)		o	GHA225013	K
	1997.03-2002.04	Estate Engine LFZ(XU7JP)		o	GHA225037	K
	1997.03-2002.04	Estate Engine LFZ(XU7JP)		o	GHA225012	K
1.8 16V (81 kW)	1997.03-2002.04	Estate Engine LFY(XU7JP4)	•		GHA425022	
	1997.03-2002.04	Estate Engine LFY(XU7JP4)	•		GWB0915	
	1997.03-2002.04	Estate Engine LFY(XU7JP4)		o	GHA225009	A
	1997.03-2002.04	Estate Engine LFY(XU7JP4)		o	GHA225012	K
	1997.03-2002.04	Estate Engine LFY(XU7JP4)		o	GHA225013	K
	1997.03-2002.04	Estate Engine LFY(XU7JP4)		o	GHA225037	K
1.9 D (50 kW)	1997.03-2002.04	Estate Engine DJY(XUD9A)	•		GHA425022	
	1997.03-2002.04	Estate Engine DJY(XUD9A)	•		GWB0915	
	1997.03-2002.04	Estate Engine DJY(XUD9A)		o	GHA225012	K
	1997.03-2002.04	Estate Engine DJY(XUD9A)		o	GHA225013	K
	1997.03-2002.04	Estate Engine DJY(XUD9A)		o	GHA225037	K
1.9 D (51 kW)	1997.05-1999.05	Estate Engine DJY(XUD9A)	•		GHA425022	
	1997.05-1999.05	Estate Engine DJY(XUD9A)	•		GWB0915	
	1997.05-1999.05	Estate Engine DJY(XUD9A)		o	GHA225012	K
	1997.05-1999.05	Estate Engine DJY(XUD9A)		o	GHA225013	K
	1997.05-1999.05	Estate Engine DJY(XUD9A)		o	GHA225037	K
	1998.09-2002.04	Estate Engine WJY(DW8B)/WJZ(DW8)	•		GHA425022	
	1998.09-2002.04	Estate Engine WJY(DW8B)/WJZ(DW8)	•		GWB0915	
	1998.09-2002.04	Estate Engine WJY(DW8B)/WJZ(DW8)		o	GHA225012	K
1.9 D (55 kW)	1998.03-2002.04	Estate Engine DHV(XUD9BSD)	•		GHA425022	
	1998.03-2002.04	Estate Engine DHV(XUD9BSD)	•		GWB0915	
	1998.03-2002.04	Estate Engine DHV(XUD9BSD)		o	GHA225012	K
	1998.03-2002.04	Estate Engine DHV(XUD9BSD)		o	GHA225013	K
	1998.03-2002.04	Estate Engine DHV(XUD9BSD)		o	GHA225037	K
1.9 TD (66 kW)	1997.02-2002.04	Estate Engine DHY(XUD9TE)	•		GHA425022	
	1997.02-2002.04	Estate Engine DHY(XUD9TE)	•		GWB0915	
	1997.02-2002.04	Estate Engine DHY(XUD9TE)		o	GHA225012	K
	1997.02-2002.04	Estate Engine DHY(XUD9TE)		o	GHA225013	K
	1997.02-2002.04	Estate Engine DHY(XUD9TE)		o	GHA225037	K
2.0 (97 kW)	1997.03-2002.04	Estate Engine RFV(XU10J4R)	•		GHA425022	
	1997.03-2002.04	Estate Engine RFV(XU10J4R)	•		GWB0915	
	1997.03-2002.04	Estate Engine RFV(XU10J4R)		o	GHA225009	A
	1997.03-2002.04	Estate Engine RFV(XU10J4R)		o	GHA225012	K
	1997.03-2002.04	Estate Engine RFV(XU10J4R)		o	GHA225013	K
	1997.03-2002.04	Estate Engine RFV(XU10J4R)		o	GHA225037	K
2.0 HDi (66 kW)	1999.06-2002.04	Estate Engine RHY(DW10TD)	•		GHA425022	
	1999.06-2002.04	Estate Engine RHY(DW10TD)	•		GWB0915	
	1999.06-2002.04	Estate Engine RHY(DW10TD)		o	GHA225013	K
306 VAN (N_, 7_)						
1.9 D (51 kW)	1999.02-2002.08	Box Engine WJY (DW8B)/WJZ (DW8)	•		GHA425022	
1.9 D (69 kW)	1994.02-1999.04	Box Engine XUD9TE	•		GWB0915	
	1994.02-1999.04	Box Engine XUD9TE		o	GHA225037	K
	1994.02-1999.04	Box Engine XUD9TE		o	GWB0961	
1.9 STD (51 kW)	1994.02-1995.10	Box Engine XUD9	•		GWB0915	
	1994.02-1995.10	Box Engine XUD9		o	GHA225009	A
	1994.02-1995.10	Box Engine XUD9		o	GHA225037	K
	1994.02-1995.10	Box Engine XUD9		o	GWB0961	
307 (3A/C)						
1.4 (55 kW)	2000.08-	Hatchback Engine KFW(TU3JP)	•		GHA425022	
	2000.08-	Hatchback Engine KFW(TU3JP)	•		GWB3584	
	2000.08-	Hatchback Engine KFW(TU3JP)		o	GHA225014	K
	2000.08-	Hatchback Engine KFW(TU3JP)		o	GHA225042	K
	2000.08-	Hatchback Engine KFW(TU3JP)		o	GWB3680	
	2000.08-	Hatchback Engine KFW(TU3JP)		o	GWB6544	
1.4 16V (65 kW)	2003.10-2007.01	Hatchback Engine KFU(ET3J4)	•		GHA425022	
	2003.10-2007.01	Hatchback Engine KFU(ET3J4)	•		GWB3584	



	 YEAR		F	R	G-AP Ref.	KIT
PEUGEOT						
307 (3A/C)						
1.4 16V (65 kW)	2003.10-2007.01	Hatchback Engine KFU(ET3J4)		o	GHA225014	K
	2003.10-2007.01	Hatchback Engine KFU(ET3J4)		o	GHA225042	K
	2003.10-2007.01	Hatchback Engine KFU(ET3J4)		o	GHA230145	K
	2003.10-2007.01	Hatchback Engine KFU(ET3J4)		o	GWB3680	
	2003.10-2007.01	Hatchback Engine KFU(ET3J4)		o	GWB6544	
1.4 HDi (50 kW)	2001.10-	Hatchback Engine 8HX(DV4TD)/8HZ(DV4TD)	•		GHA425022	
	2001.10-	Hatchback Engine 8HX(DV4TD)/8HZ(DV4TD)	•		GWB3584	
	2001.10-	Hatchback Engine 8HX(DV4TD)/8HZ(DV4TD)		o	GHA225014	K
	2001.10-	Hatchback Engine 8HX(DV4TD)/8HZ(DV4TD)		o	GHA225042	K
	2001.10-	Hatchback Engine 8HX(DV4TD)/8HZ(DV4TD)		o	GWB3680	
	2001.10-	Hatchback Engine 8HX(DV4TD)/8HZ(DV4TD)		o	GWB6544	
1.6 (81 kW)	2006.07-	Hatchback	•		GHA425022	
	2006.07-	Hatchback	•		GWB3584	
	2006.07-	Hatchback		o	GWB6544	
1.6 16V (80 kW)	2000.08-	Hatchback Engine NFU(TU5JP4)	•		GHA425022	
	2000.08-	Hatchback Engine NFU(TU5JP4)	•		GWB3584	
	2000.08-	Hatchback Engine NFU(TU5JP4)		o	GHA225014	K
	2000.08-	Hatchback Engine NFU(TU5JP4)		o	GHA225042	K
	2000.08-	Hatchback Engine NFU(TU5JP4)		o	GHA230145	K
	2000.08-	Hatchback Engine NFU(TU5JP4)		o	GWB3680	
	2000.08-	Hatchback Engine NFU(TU5JP4)		o	GWB6544	
1.6 BioFlex (80 kW)	2007.09-	Hatchback Engine NFU(TU5JP4)	•		GHA425022	
	2007.09-	Hatchback Engine NFU(TU5JP4)	•		GWB3584	
	2007.09-	Hatchback Engine NFU(TU5JP4)		o	GWB6544	
1.6 HDi (66 kW)	2005.06-2007.01	Hatchback Engine 9HV(DV6ATED4)	•		GHA425022	
	2005.06-2007.01	Hatchback Engine 9HV(DV6ATED4)	•		GWB3584	
	2005.06-2007.01	Hatchback Engine 9HV(DV6ATED4)		o	GHA225014	K
	2005.06-2007.01	Hatchback Engine 9HV(DV6ATED4)		o	GHA225042	K
	2005.06-2007.01	Hatchback Engine 9HV(DV6ATED4)		o	GHA230145	K
	2005.06-2007.01	Hatchback Engine 9HV(DV6ATED4)		o	GWB3680	
1.6 HDi (80 kW)	2005.03-2006.05	Hatchback Engine 9HY(DV6TED4)/9HZ(DV6TED4)	•		GHA425022	
	2005.03-2006.05	Hatchback Engine 9HY(DV6TED4)/9HZ(DV6TED4)	•		GWB3584	
	2005.03-2006.05	Hatchback Engine 9HY(DV6TED4)/9HZ(DV6TED4)		o	GHA225014	K
	2005.03-2006.05	Hatchback Engine 9HY(DV6TED4)/9HZ(DV6TED4)		o	GHA225042	K
	2005.03-2006.05	Hatchback Engine 9HY(DV6TED4)/9HZ(DV6TED4)		o	GHA230145	K
	2005.03-2006.05	Hatchback Engine 9HY(DV6TED4)/9HZ(DV6TED4)		o	GWB3680	
	2005.03-2006.05	Hatchback Engine 9HY(DV6TED4)/9HZ(DV6TED4)		o	GWB6544	
2.0 (105 kW)	2008.08-	Hatchback Engine RFN(EW10J4)	•		GHA425022	
	2008.08-	Hatchback Engine RFN(EW10J4)	•		GWB3584	
	2008.08-	Hatchback Engine RFN(EW10J4)		o	GWB6544	
2.0 16V (100 kW)	2000.08-	Hatchback Engine RFN(EW10J4)	•		GHA425022	
	2000.08-	Hatchback Engine RFN(EW10J4)	•		GWB3584	
	2000.08-	Hatchback Engine RFN(EW10J4)		o	GHA225014	K
	2000.08-	Hatchback Engine RFN(EW10J4)		o	GHA225042	K
	2000.08-	Hatchback Engine RFN(EW10J4)		o	GWB3680	
	2000.08-	Hatchback Engine RFN(EW10J4)		o	GWB6544	
2.0 16V (103 kW)	2006.06-	Hatchback Engine RFJ(EW10A)	•		GHA425022	
	2006.06-	Hatchback Engine RFJ(EW10A)	•		GWB3584	
	2006.06-	Hatchback Engine RFJ(EW10A)		o	GHA225014	K
	2006.06-	Hatchback Engine RFJ(EW10A)		o	GHA225042	K
	2006.06-	Hatchback Engine RFJ(EW10A)		o	GHA230145	K
	2006.06-	Hatchback Engine RFJ(EW10A)		o	GWB3680	
	2006.06-	Hatchback Engine RFJ(EW10A)		o	GWB6544	
2.0 16V (130 kW)	2005.06-2006.05	Hatchback Engine RFK(EW10J4S)	•		GHA425022	
	2005.06-2006.05	Hatchback Engine RFK(EW10J4S)	•		GWB3584	
	2005.06-2006.05	Hatchback Engine RFK(EW10J4S)		o	GHA225014	K
	2005.06-2006.05	Hatchback Engine RFK(EW10J4S)		o	GHA230145	K
	2005.06-2006.05	Hatchback Engine RFK(EW10J4S)		o	GWB3680	
	2005.06-2006.05	Hatchback Engine RFK(EW10J4S)		o	GWB6544	
2.0 HDi (100 kW)	2004.04-2006.05	Hatchback Engine RHR(DW10BTED4)	•		GHA425022	
	2004.04-2006.05	Hatchback Engine RHR(DW10BTED4)	•		GWB3584	
	2004.04-2006.05	Hatchback Engine RHR(DW10BTED4)		o	GHA225014	K
	2004.04-2006.05	Hatchback Engine RHR(DW10BTED4)		o	GHA225042	K



	 YEAR		F	R	G-AP Ref.	KIT
PEUGEOT						
307 (3A/C)						
2.0 HDi (100 kW)	2004.04-2006.05	Hatchback Engine RHR(DW10BTED4)		o	GHA230145	K
	2004.04-2006.05	Hatchback Engine RHR(DW10BTED4)		o	GWB3680	
	2004.04-2006.05	Hatchback Engine RHR(DW10BTED4)		o	GWB6544	
2.0 HDi (66 kW)	2000.08-	Hatchback Engine RHY(DW10TD)	•		GHA425022	
	2000.08-	Hatchback Engine RHY(DW10TD)	•		GWB3584	
	2000.08-	Hatchback Engine RHY(DW10TD)		o	GHA225014	K
	2000.08-	Hatchback Engine RHY(DW10TD)		o	GHA225042	K
	2000.08-	Hatchback Engine RHY(DW10TD)		o	GHA230145	K
	2000.08-	Hatchback Engine RHY(DW10TD)		o	GWB3680	
	2000.08-	Hatchback Engine RHY(DW10TD)		o	GWB6544	
2.0 HDi (79 kW)	2000.08-	Hatchback Engine RHS(DW10ATED)	•		GHA425022	
	2000.08-	Hatchback Engine RHS(DW10ATED)	•		GWB3584	
	2000.08-	Hatchback Engine RHS(DW10ATED)		o	GHA225014	K
	2000.08-	Hatchback Engine RHS(DW10ATED)		o	GHA225042	K
	2000.08-	Hatchback Engine RHS(DW10ATED)		o	GWB3680	
	2000.08-	Hatchback Engine RHS(DW10ATED)		o	GWB6544	
307 (3E)						
1.4 (55 kW)	2002.04-2003.09	Estate Engine TU3JP	•		GHA425022	
	2002.04-2003.09	Estate Engine TU3JP	•		GWB3584	
	2002.04-2003.09	Estate Engine TU3JP		o	GHA225014	K
	2002.04-2003.09	Estate Engine TU3JP		o	GWB3680	
1.4 16V (65 kW)	2003.11-2004.11	Estate Engine KFU(ET3J4)	•		GHA425022	
	2003.11-2004.11	Estate Engine KFU(ET3J4)	•		GWB3584	
	2003.11-2004.11	Estate Engine KFU(ET3J4)		o	GHA225014	K
	2003.11-2004.11	Estate Engine KFU(ET3J4)		o	GHA225042	K
	2003.11-2004.11	Estate Engine KFU(ET3J4)		o	GHA230145	K
	2003.11-2004.11	Estate Engine KFU(ET3J4)		o	GWB3680	
	2003.11-2004.11	Estate Engine KFU(ET3J4)		o	GWB6544	
1.4 HDi (50 kW)	2002.03-2004.11	Estate Engine 8HZ(DV4TD)	•		GHA425022	
	2002.03-2004.11	Estate Engine 8HZ(DV4TD)	•		GWB3584	
	2002.03-2004.11	Estate Engine 8HZ(DV4TD)		o	GHA225014	K
	2002.03-2004.11	Estate Engine 8HZ(DV4TD)		o	GHA225042	K
	2002.03-2004.11	Estate Engine 8HZ(DV4TD)		o	GWB3680	
1.6 16V (80 kW)	2002.03-2006.05	Estate Engine NFU(TU5JP4)	•		GHA425022	
	2002.03-2006.05	Estate Engine NFU(TU5JP4)	•		GWB3584	
	2002.03-2006.05	Estate Engine NFU(TU5JP4)		o	GHA225014	K
	2002.03-2006.05	Estate Engine NFU(TU5JP4)		o	GHA225042	K
	2002.03-2006.05	Estate Engine NFU(TU5JP4)		o	GHA230145	K
	2002.03-2006.05	Estate Engine NFU(TU5JP4)		o	GWB3680	
	2002.03-2006.05	Estate Engine NFU(TU5JP4)		o	GWB6544	
1.6 BioFlex (80 kW)	2007.09-	Estate Engine NFU(TU5JP4)	•		GHA425022	
	2007.09-	Estate Engine NFU(TU5JP4)	•		GWB3584	
	2007.09-	Estate Engine NFU(TU5JP4)		o	GHA230145	K
	2007.09-	Estate Engine NFU(TU5JP4)		o	GWB6544	
1.6 HDi (66 kW)	2005.06-2007.01	Estate Engine 9HV(DV6ATED4)	•		GHA425022	
	2005.06-2007.01	Estate Engine 9HV(DV6ATED4)	•		GWB3584	
	2005.06-2007.01	Estate Engine 9HV(DV6ATED4)		o	GHA225014	K
	2005.06-2007.01	Estate Engine 9HV(DV6ATED4)		o	GHA225042	K
	2005.06-2007.01	Estate Engine 9HV(DV6ATED4)		o	GHA230145	K
	2005.06-2007.01	Estate Engine 9HV(DV6ATED4)		o	GWB3680	
	2005.06-2007.01	Estate Engine 9HV(DV6ATED4)		o	GWB6544	
1.6 HDi (80 kW)	2004.04-2005.05	Estate Engine 9HY(DV6TED4)/9HZ(DV6TED4)	•		GHA425022	
	2004.04-2005.05	Estate Engine 9HY(DV6TED4)/9HZ(DV6TED4)	•		GWB3584	
	2004.04-2005.05	Estate Engine 9HY(DV6TED4)/9HZ(DV6TED4)		o	GHA225014	K
	2004.04-2005.05	Estate Engine 9HY(DV6TED4)/9HZ(DV6TED4)		o	GHA225042	K
	2004.04-2005.05	Estate Engine 9HY(DV6TED4)/9HZ(DV6TED4)		o	GHA230145	K
	2004.04-2005.05	Estate Engine 9HY(DV6TED4)/9HZ(DV6TED4)		o	GWB3680	
	2004.04-2005.05	Estate Engine 9HY(DV6TED4)/9HZ(DV6TED4)		o	GWB6544	
2.0 (100 kW)	2002.11-2004.11	Estate Engine RFN(EW10J4)	•		GHA425022	
	2002.11-2004.11	Estate Engine RFN(EW10J4)	•		GWB3584	
	2002.11-2004.11	Estate Engine RFN(EW10J4)		o	GHA225014	K
	2002.11-2004.11	Estate Engine RFN(EW10J4)		o	GHA225042	K
	2002.11-2004.11	Estate Engine RFN(EW10J4)		o	GWB3680	



	 YEAR		F	R	G-AP Ref.	KIT
PEUGEOT						
307 (3E)						
2.0 (100 kW)	2002.11-2004.11	Estate Engine RFN(EW10J4)		o	GWB6544	
2.0 16V (103 kW)	2005.03-	Estate Engine RFJ(EW10A)	•		GHA425022	
	2005.03-	Estate Engine RFJ(EW10A)	•		GWB3584	
	2005.03-	Estate Engine RFJ(EW10A)		o	GHA225014	K
	2005.03-	Estate Engine RFJ(EW10A)		o	GHA225042	K
	2005.03-	Estate Engine RFJ(EW10A)		o	GHA230145	K
	2005.03-	Estate Engine RFJ(EW10A)		o	GWB3680	
	2005.03-	Estate Engine RFJ(EW10A)		o	GWB6544	
	2.0 16V (130 kW)	2006.06-2007.01	Estate Engine RFK(EW10J4S)	•		GHA425022
2006.06-2007.01		Estate Engine RFK(EW10J4S)	•		GWB3584	
2006.06-2007.01		Estate Engine RFK(EW10J4S)		o	GHA225014	K
2006.06-2007.01		Estate Engine RFK(EW10J4S)		o	GWB3680	
2006.06-2007.01		Estate Engine RFK(EW10J4S)		o	GWB6544	
2.0 HDi (100 kW)	2006.06-2007.01	Estate Engine RHR(DW10BTED4)	•		GHA425022	
	2006.06-2007.01	Estate Engine RHR(DW10BTED4)	•		GWB3584	
	2006.06-2007.01	Estate Engine RHR(DW10BTED4)		o	GHA225014	K
	2006.06-2007.01	Estate Engine RHR(DW10BTED4)		o	GHA225042	K
	2006.06-2007.01	Estate Engine RHR(DW10BTED4)		o	GWB3680	
	2006.06-2007.01	Estate Engine RHR(DW10BTED4)		o	GWB6544	
2.0 HDi (66 kW)	2002.03-2005.03	Estate Engine RHY(DW10TD)	•		GHA425022	
	2002.03-2005.03	Estate Engine RHY(DW10TD)	•		GWB3584	
	2002.03-2005.03	Estate Engine RHY(DW10TD)		o	GHA225014	K
	2002.03-2005.03	Estate Engine RHY(DW10TD)		o	GHA225042	K
	2002.03-2005.03	Estate Engine RHY(DW10TD)		o	GHA230145	K
	2002.03-2005.03	Estate Engine RHY(DW10TD)		o	GWB3680	
	2002.03-2005.03	Estate Engine RHY(DW10TD)		o	GWB6544	
2.0 HDi (79 kW)	2002.03-	Estate Engine RHS(DW10ATED)	•		GHA425022	
	2002.03-	Estate Engine RHS(DW10ATED)	•		GWB3584	
	2002.03-	Estate Engine RHS(DW10ATED)		o	GHA225014	K
	2002.03-	Estate Engine RHS(DW10ATED)		o	GHA225042	K
	2002.03-	Estate Engine RHS(DW10ATED)		o	GWB3680	
	2002.03-	Estate Engine RHS(DW10ATED)		o	GWB6544	
307 (3H)						
1.4 (55 kW)	2002.04-2003.09	Estate Engine KFW(TU3JP)	•		GHA425022	
	2002.04-2003.09	Estate Engine KFW(TU3JP)	•		GWB3584	
	2002.04-2003.09	Estate Engine KFW(TU3JP)		o	GHA225014	K
	2002.04-2003.09	Estate Engine KFW(TU3JP)		o	GWB3680	
1.4 16V (65 kW)	2003.11-	Estate Engine KFU(ET3J4)	•		GHA425022	
	2003.11-	Estate Engine KFU(ET3J4)	•		GWB3584	
	2003.11-	Estate Engine KFU(ET3J4)		o	GHA225014	K
	2003.11-	Estate Engine KFU(ET3J4)		o	GWB3680	
	2003.11-	Estate Engine KFU(ET3J4)		o	GWB6544	
1.4 HDi (50 kW)	2002.03-2005.01	Estate Engine 8HZ(DV4TD)	•		GWB3584	
	2002.03-2005.01	Estate Engine 8HZ(DV4TD)		o	GHA225014	K
	2002.03-2005.01	Estate Engine 8HZ(DV4TD)		o	GWB3680	
1.6 16V (80 kW)	2002.03-	Estate Engine NFU(TU5JP4)	•		GHA425022	
	2002.03-	Estate Engine NFU(TU5JP4)	•		GWB3584	
	2002.03-	Estate Engine NFU(TU5JP4)		o	GHA225014	K
	2002.03-	Estate Engine NFU(TU5JP4)		o	GHA225042	K
	2002.03-	Estate Engine NFU(TU5JP4)		o	GHA230145	K
	2002.03-	Estate Engine NFU(TU5JP4)		o	GWB3680	
	2002.03-	Estate Engine NFU(TU5JP4)		o	GWB6544	
1.6 HDi (66 kW)	2006.12-	Estate Engine 9HV(DV6ATED4)/9HX(DV6ATED4)	•		GHA425022	
	2006.12-	Estate Engine 9HV(DV6ATED4)/9HX(DV6ATED4)	•		GWB3584	
	2006.12-	Estate Engine 9HV(DV6ATED4)/9HX(DV6ATED4)		o	GHA230145	K
	2006.12-	Estate Engine 9HV(DV6ATED4)/9HX(DV6ATED4)		o	GWB6544	
1.6 HDi (80 kW)	2004.04-2007.03	Estate Engine 9HY(DV6TED4)/9HZ(DV6TED4)	•		GHA425022	
	2004.04-2007.03	Estate Engine 9HY(DV6TED4)/9HZ(DV6TED4)	•		GWB3584	
	2004.04-2007.03	Estate Engine 9HY(DV6TED4)/9HZ(DV6TED4)		o	GHA225014	K
	2004.04-2007.03	Estate Engine 9HY(DV6TED4)/9HZ(DV6TED4)		o	GHA225042	K
	2004.04-2007.03	Estate Engine 9HY(DV6TED4)/9HZ(DV6TED4)		o	GHA230145	K
	2004.04-2007.03	Estate Engine 9HY(DV6TED4)/9HZ(DV6TED4)		o	GWB3680	
	2004.04-2007.03	Estate Engine 9HY(DV6TED4)/9HZ(DV6TED4)		o	GWB6544	
	2004.04-2007.03	Estate Engine 9HY(DV6TED4)/9HZ(DV6TED4)		o	GWB6544	
2.0 16V (100 kW)	2002.03-	Estate Engine RFN(EW10J4)	•		GHA425022	



	 YEAR		F	R	G-AP Ref.	KIT
PEUGEOT						
307 (3H)						
2.0 16V (100 kW)	2002.03-	Estate Engine RFN(EW10J4)	•		GWB3584	
	2002.03-	Estate Engine RFN(EW10J4)		◦	GHA225014	K
	2002.03-	Estate Engine RFN(EW10J4)		◦	GHA225042	K
	2002.03-	Estate Engine RFN(EW10J4)		◦	GWB3680	
	2002.03-	Estate Engine RFN(EW10J4)		◦	GWB6544	
2.0 16V (103 kW)	2005.04-2006.05	Estate Engine RFJ(EW10A)	•		GHA425022	
	2005.04-2006.05	Estate Engine RFJ(EW10A)	•		GWB3584	
	2005.04-2006.05	Estate Engine RFJ(EW10A)		◦	GHA225014	K
	2005.04-2006.05	Estate Engine RFJ(EW10A)		◦	GHA225042	K
	2005.04-2006.05	Estate Engine RFJ(EW10A)		◦	GHA230145	K
	2005.04-2006.05	Estate Engine RFJ(EW10A)		◦	GWB3680	
2.0 HDi (100 kW)	2005.04-2006.05	Estate Engine RFJ(EW10A)		◦	GWB6544	
	2004.04-2007.03	Estate Engine RHR(DW10BTED4)	•		GHA425022	
	2004.04-2007.03	Estate Engine RHR(DW10BTED4)	•		GWB3584	
	2004.04-2007.03	Estate Engine RHR(DW10BTED4)		◦	GHA225014	K
	2004.04-2007.03	Estate Engine RHR(DW10BTED4)		◦	GHA225042	K
	2004.04-2007.03	Estate Engine RHR(DW10BTED4)		◦	GHA230145	K
2.0 HDi (66 kW)	2004.04-2007.03	Estate Engine RHR(DW10BTED4)		◦	GWB3680	
	2004.04-2007.03	Estate Engine RHR(DW10BTED4)		◦	GWB6544	
	2002.03-	Estate Engine RHY(DW10TD)	•		GHA425022	
	2002.03-	Estate Engine RHY(DW10TD)	•		GWB3584	
	2002.03-	Estate Engine RHY(DW10TD)		◦	GHA225014	K
	2002.03-	Estate Engine RHY(DW10TD)		◦	GHA225042	K
2.0 HDi (79 kW)	2002.03-	Estate Engine RHY(DW10TD)		◦	GHA230145	K
	2002.03-	Estate Engine RHY(DW10TD)		◦	GWB3680	
	2002.03-	Estate Engine RHY(DW10TD)		◦	GWB6544	
	2002.03-	Estate Engine RHS(DW10ATED)	•		GHA425022	
	2002.03-	Estate Engine RHS(DW10ATED)	•		GWB3584	
	2002.03-	Estate Engine RHS(DW10ATED)		◦	GHA225014	K
307 CC (3B)	2002.03-	Estate Engine RHS(DW10ATED)		◦	GHA225042	K
	2002.03-	Estate Engine RHS(DW10ATED)		◦	GWB3680	
	2002.03-	Estate Engine RHS(DW10ATED)		◦	GWB6544	
	2005.02-	Convertible Engine NFU(TU5JP4)	•		GHA425022	
	2005.02-	Convertible Engine NFU(TU5JP4)	•		GWB3584	
1.6 16V (80 kW)	2005.02-	Convertible Engine NFU(TU5JP4)		◦	GHA225014	K
	2005.02-	Convertible Engine NFU(TU5JP4)		◦	GHA225042	K
	2005.02-	Convertible Engine NFU(TU5JP4)		◦	GHA230145	K
	2005.02-	Convertible Engine NFU(TU5JP4)		◦	GWB3680	
	2005.02-	Convertible Engine NFU(TU5JP4)		◦	GWB6544	
	2005.02-	Convertible Engine NFU(TU5JP4)		◦	GWB6544	
2.0 16V (100 kW)	2003.10-	Convertible Engine RFN(EW10J4)	•		GHA425022	
	2003.10-	Convertible Engine RFN(EW10J4)	•		GWB3584	
	2003.10-	Convertible Engine RFN(EW10J4)		◦	GHA225014	K
	2003.10-	Convertible Engine RFN(EW10J4)		◦	GHA225042	K
	2003.10-	Convertible Engine RFN(EW10J4)		◦	GWB3680	
	2003.10-	Convertible Engine RFN(EW10J4)		◦	GWB6544	
2.0 16V (103 kW)	2003.10-	Convertible Engine RFN(EW10J4)		◦	GWB6544	
	2005.03-	Convertible Engine RFJ(EW10A)	•		GHA425022	
	2005.03-	Convertible Engine RFJ(EW10A)	•		GWB3584	
	2005.03-	Convertible Engine RFJ(EW10A)		◦	GHA225014	K
	2005.03-	Convertible Engine RFJ(EW10A)		◦	GHA225042	K
	2005.03-	Convertible Engine RFJ(EW10A)		◦	GHA230145	K
2.0 16V (130 kW)	2005.03-	Convertible Engine RFJ(EW10A)		◦	GWB3680	
	2005.03-	Convertible Engine RFJ(EW10A)		◦	GWB6544	
	2003.10-	Convertible Engine RFK(EW10J4S)	•		GHA425022	
	2003.10-	Convertible Engine RFK(EW10J4S)	•		GWB3584	
	2003.10-	Convertible Engine RFK(EW10J4S)		◦	GHA225014	K
	2003.10-	Convertible Engine RFK(EW10J4S)		◦	GHA225042	K
2.0 HDi (100 kW)	2003.10-	Convertible Engine RFK(EW10J4S)		◦	GHA230145	K
	2003.10-	Convertible Engine RFK(EW10J4S)		◦	GWB3680	
	2003.10-	Convertible Engine RFK(EW10J4S)		◦	GWB6544	
	2005.06-	Convertible Engine RHR(DW10BTED4)	•		GHA425022	
	2005.06-	Convertible Engine RHR(DW10BTED4)	•		GWB3584	
	2005.06-	Convertible Engine RHR(DW10BTED4)		◦	GHA225014	K
	2005.06-	Convertible Engine RHR(DW10BTED4)		◦	GHA225042	K



	 YEAR		F	R	G-AP Ref.	KIT
PEUGEOT						
307 CC (3B)						
2.0 HDi (100 kW)	2005.06-	Convertible Engine RHR(DW10BTED4)		o	GHA230145	K
	2005.06-	Convertible Engine RHR(DW10BTED4)		o	GWB3680	
	2005.06-	Convertible Engine RHR(DW10BTED4)		o	GWB6544	
307 SW (3H)						
1.6 BioFlex (80 kW)	2007.09-	Estate Engine NFU(TU5JP4)	•		GHA425022	
	2007.09-	Estate Engine NFU(TU5JP4)	•		GWB3584	
	2007.09-	Estate Engine NFU(TU5JP4)		o	GHA230145	K
	2007.09-	Estate Engine NFU(TU5JP4)		o	GWB6544	
308						
2.0 Bioflex (103 kW)	2008.01-	Estate Engine RFJ(EW10A)	•		GHA425022	
	2008.01-	Estate Engine RFJ(EW10A)	•		GWB3584	
	2008.01-	Estate Engine RFJ(EW10A)		o	GWB6549	
308 (4A_ , 4C_)						
1.4 16V (70 kW)	2007.09-	Hatchback Engine EP3/8FS(EP3)	•		GHA425022	
	2007.09-	Hatchback Engine EP3/8FS(EP3)	•		GWB3584	
	2007.09-	Hatchback Engine EP3/8FS(EP3)		o	GHA230146	K
	2007.09-	Hatchback Engine EP3/8FS(EP3)		o	GWB6549	
1.4 16V (72 kW)	2009.12-	Hatchback	•		GHA425022	
	2009.12-	Hatchback	•		GWB3584	
	2009.12-	Hatchback		o	GHA230146	K
	2009.12-	Hatchback		o	GWB6549	
1.6 (120 kW)	2012.01-	Hatchback Engine 5FV(EP6DT)	•		GHA425022	
	2012.01-	Hatchback Engine 5FV(EP6DT)	•		GWB3584	
	2012.01-	Hatchback Engine 5FV(EP6DT)		o	GWB6549	
1.6 16V (103 kW)	2007.09-	Hatchback Engine 5FT(EP6DT)	•		GHA425022	
	2007.09-	Hatchback Engine 5FT(EP6DT)	•		GWB3584	
	2007.09-	Hatchback Engine 5FT(EP6DT)		o	GHA230146	K
	2007.09-	Hatchback Engine 5FT(EP6DT)		o	GWB6549	
1.6 16V (110 kW)	2007.09-	Hatchback Engine 5FX(EP6DT)	•		GHA425022	
	2007.09-	Hatchback Engine 5FX(EP6DT)	•		GWB3584	
	2007.09-	Hatchback Engine 5FX(EP6DT)		o	GHA230146	K
	2007.09-	Hatchback Engine 5FX(EP6DT)		o	GWB6549	
	2007.09-	Hatchback Engine 5FX(EP6DT)		o	GWB6549	
1.6 16V (115 kW)	2009.10-	Hatchback Engine EP6CDT	•		GHA425022	
	2009.10-	Hatchback Engine EP6CDT	•		GWB3584	
	2009.10-	Hatchback Engine EP6CDT		o	GHA230146	K
	2009.10-	Hatchback Engine EP6CDT		o	GWB6549	
1.6 16V (128 kW)	2008.03-	Hatchback Engine 5FY(EP6DTS)	•		GHA425022	
	2008.03-	Hatchback Engine 5FY(EP6DTS)	•		GWB3584	
	2008.03-	Hatchback Engine 5FY(EP6DTS)		o	GHA230146	K
	2008.03-	Hatchback Engine 5FY(EP6DTS)		o	GWB6549	
1.6 16V (88 kW)	2007.09-	Hatchback Engine EP6	•		GHA425022	
	2007.09-	Hatchback Engine EP6	•		GWB3584	
	2007.09-	Hatchback Engine EP6		o	GHA230146	K
	2007.09-	Hatchback Engine EP6		o	GWB6549	
1.6 BioFlex (80 kW)	2008.04-	Hatchback Engine NFU(TU5JP4)	•		GHA425022	
	2008.04-	Hatchback Engine NFU(TU5JP4)	•		GWB3584	
	2008.04-	Hatchback Engine NFU(TU5JP4)		o	GHA230146	K
	2008.04-	Hatchback Engine NFU(TU5JP4)		o	GWB6549	
1.6 GTi (147 kW)	2010.07-	Hatchback Engine EP6CDTX	•		GHA425022	
	2010.07-	Hatchback Engine EP6CDTX	•		GWB3683	
	2010.07-	Hatchback Engine EP6CDTX		o	GHA230146	K
1.6 HDi (66 kW)	2007.09-	Hatchback	•		GHA425022	
	2007.09-	Hatchback	•		GWB3584	
	2007.09-	Hatchback		o	GHA230146	K
	2007.09-	Hatchback		o	GWB6549	
1.6 HDi (68 kW)	2009.11-	Hatchback Engine 9HP(DV6DTED)	•		GHA425022	
	2009.11-	Hatchback Engine 9HP(DV6DTED)	•		GWB3584	
	2009.11-	Hatchback Engine 9HP(DV6DTED)		o	GHA230146	K
	2009.11-	Hatchback Engine 9HP(DV6DTED)		o	GWB6549	
1.6 HDi (80 kW)	2007.09-	Hatchback Engine 9HZ(DV6TED4)	•		GHA425022	
	2007.09-	Hatchback Engine 9HZ(DV6TED4)	•		GWB3584	
	2007.09-	Hatchback Engine 9HZ(DV6TED4)		o	GHA230146	K
	2007.09-	Hatchback Engine 9HZ(DV6TED4)		o	GWB6549	
1.6 HDi (82 kW)	2009.12-	Hatchback Engine 9HR(DV6C)	•		GHA425022	



	 YEAR		F	R	G-AP Ref.	KIT
PEUGEOT						
308 (4A_, 4C_)						
1.6 HDi (82 kW)	2009.12-	Hatchback Engine 9HR(DV6C)	•		GWB3584	
	2009.12-	Hatchback Engine 9HR(DV6C)		◦	GHA230146	K
	2009.12-	Hatchback Engine 9HR(DV6C)		◦	GWB6549	
1.6 HDi (84 kW)	2013.03-	Hatchback	•		GWB3584	
	2013.03-	Hatchback		◦	GWB6549	
2.0 HDi (100 kW)	2007.09-	Hatchback Engine RHR(DW10BTED4)	•		GHA425022	
	2007.09-	Hatchback Engine RHR(DW10BTED4)	•		GWB3584	
	2007.09-	Hatchback Engine RHR(DW10BTED4)		◦	GHA230146	K
	2007.09-	Hatchback Engine RHR(DW10BTED4)		◦	GWB6549	
2.0 HDi (103 kW)	2010.07-	Hatchback Engine RHR(DW10BTED4)	•		GHA425022	
	2010.07-	Hatchback Engine RHR(DW10BTED4)	•		GWB3584	
	2010.07-	Hatchback Engine RHR(DW10BTED4)		◦	GHA230146	K
	2010.07-	Hatchback Engine RHR(DW10BTED4)		◦	GWB6549	
2.0 HDi (110 kW)	2011.10-	Hatchback Engine RHE(DW10CTED4)	•		GHA425022	
	2011.10-	Hatchback Engine RHE(DW10CTED4)	•		GWB3584	
	2011.10-	Hatchback Engine RHE(DW10CTED4)		◦	GHA230146	K
	2011.10-	Hatchback Engine RHE(DW10CTED4)		◦	GWB6549	
2.0 HDi (120 kW)	2012.04-	Hatchback Engine RHH(DW10CTED4)	•		GHA425022	
	2012.04-	Hatchback Engine RHH(DW10CTED4)	•		GWB3584	
	2012.04-	Hatchback Engine RHH(DW10CTED4)		◦	GHA230146	K
	2012.04-	Hatchback Engine RHH(DW10CTED4)		◦	GWB6549	
308 CC						
1.6 16V (103 kW)	2009.06-	Convertible Engine 5FT(EP6DT)	•		GHA425022	
	2009.06-	Convertible Engine 5FT(EP6DT)	•		GWB3584	
	2009.06-	Convertible Engine 5FT(EP6DT)		◦	GWB6549	
1.6 16V (110 kW)	2009.06-	Convertible Engine 5FX(EP6DT)	•		GHA425022	
	2009.06-	Convertible Engine 5FX(EP6DT)	•		GWB3584	
	2009.06-	Convertible Engine 5FX(EP6DT)		◦	GWB6549	
1.6 16V (115 kW)	2009.06-	Convertible Engine EP6CDT	•		GHA425022	
	2009.06-	Convertible Engine EP6CDT	•		GWB3584	
	2009.06-	Convertible Engine EP6CDT		◦	GWB6549	
1.6 16V (88 kW)	2009.06-	Convertible Engine EP6	•		GHA425022	
	2009.06-	Convertible Engine EP6	•		GWB3584	
	2009.06-	Convertible Engine EP6		◦	GWB6549	
1.6 HDi (82 kW)	2009.06-	Convertible Engine Engine9HR(DV6C)	•		GHA425022	
	2009.06-	Convertible Engine Engine9HR(DV6C)	•		GWB3584	
	2009.06-	Convertible Engine Engine9HR(DV6C)		◦	GWB6549	
1.6 HDi (84 kW)	2013.03-	Convertible	•		GWB3584	
	2013.03-	Convertible		◦	GWB6549	
1.6 THP (147 kW)	2010.10-	Convertible Engine EP6CDTX	•		GHA425022	
	2010.10-	Convertible Engine EP6CDTX	•		GWB3683	
2.0 HDi (100 kW)	2009.04-	Convertible Engine RHR(DW10BTED4)	•		GHA425022	
	2009.04-	Convertible Engine RHR(DW10BTED4)	•		GWB3584	
	2009.04-	Convertible Engine RHR(DW10BTED4)		◦	GWB6549	
2.0 HDi (103 kW)	2009.04-	Convertible Engine RHF(DW10BTED4)	•		GHA425022	
	2009.04-	Convertible Engine RHF(DW10BTED4)	•		GWB3584	
	2009.04-	Convertible Engine RHF(DW10BTED4)		◦	GWB6549	
2.0 HDi (120 kW)	2009.06-	Convertible Engine RHH(DW10CTED4)	•		GHA425022	
	2009.06-	Convertible Engine RHH(DW10CTED4)	•		GWB3584	
	2009.06-	Convertible Engine RHH(DW10CTED4)		◦	GWB6549	
308 SW						
1.4 16V (70 kW)	2007.09-	Estate Engine 8FS(EP3)	•		GHA425022	
	2007.09-	Estate Engine 8FS(EP3)	•		GWB3584	
	2007.09-	Estate Engine 8FS(EP3)		◦	GHA230148	K
	2007.09-	Estate Engine 8FS(EP3)		◦	GWB6549	
1.4 16V (72 kW)	2009.12-	Estate	•		GHA425022	
	2009.12-	Estate	•		GWB3584	
	2009.12-	Estate		◦	GHA230148	K
	2009.12-	Estate		◦	GWB6549	
1.6 16V (103 kW)	2007.09-	Estate Engine 5FT(EP6DT)	•		GHA425022	
	2007.09-	Estate Engine 5FT(EP6DT)	•		GWB3584	
	2007.09-	Estate Engine 5FT(EP6DT)		◦	GHA230148	K
	2007.09-	Estate Engine 5FT(EP6DT)		◦	GWB6549	
1.6 16V (110 kW)	2007.09-	Estate Engine 5FX(EP6DT)	•		GHA425022	



	 YEAR		F	R	G-AP Ref.	KIT
PEUGEOT						
308 SW						
1.6 16V (110 kW)	2007.09-	Estate Engine 5FX(EP6DT)	•		GWB3584	
	2007.09-	Estate Engine 5FX(EP6DT)		◦	GHA230148	K
	2007.09-	Estate Engine 5FX(EP6DT)		◦	GWB6549	
1.6 16V (115 kW)	2009.10-	Estate Engine EP6CDT	•		GHA425022	
	2009.10-	Estate Engine EP6CDT	•		GWB3584	
	2009.10-	Estate Engine EP6CDT		◦	GHA230148	K
	2009.10-	Estate Engine EP6CDT		◦	GWB6549	
1.6 16V (128 kW)	2008.03-	Estate Engine 5FY(EP6DTS)	•		GHA425022	
	2008.03-	Estate Engine 5FY(EP6DTS)	•		GWB3584	
	2008.03-	Estate Engine 5FY(EP6DTS)		◦	GHA230148	K
	2008.03-	Estate Engine 5FY(EP6DTS)		◦	GWB6549	
1.6 16V (88 kW)	2007.09-	Estate Engine EP6	•		GHA425022	
	2007.09-	Estate Engine EP6	•		GWB3584	
	2007.09-	Estate Engine EP6		◦	GHA230148	K
	2007.09-	Estate Engine EP6		◦	GWB6549	
1.6 Bioflex (82 kW)	2009.03-	Estate Engine NFU(TU5JP4)	•		GHA425022	
	2009.03-	Estate Engine NFU(TU5JP4)	•		GWB3584	
	2009.03-	Estate Engine NFU(TU5JP4)		◦	GHA230148	K
	2009.03-	Estate Engine NFU(TU5JP4)		◦	GWB6549	
1.6 HDi (66 kW)	2007.09-	Estate Engine 9HV(DV6ATED4)/9HX(DV6ATED4)	•		GHA425022	
	2007.09-	Estate Engine 9HV(DV6ATED4)/9HX(DV6ATED4)	•		GWB3584	
	2007.09-	Estate Engine 9HV(DV6ATED4)/9HX(DV6ATED4)		◦	GHA230148	K
	2007.09-	Estate Engine 9HV(DV6ATED4)/9HX(DV6ATED4)		◦	GWB6549	
1.6 HDi (68 kW)	2009.11-	Estate Engine 9HP(DV6DTED)	•		GHA425022	
	2009.11-	Estate Engine 9HP(DV6DTED)	•		GWB3584	
	2009.11-	Estate Engine 9HP(DV6DTED)		◦	GHA230148	K
	2009.11-	Estate Engine 9HP(DV6DTED)		◦	GWB6549	
1.6 HDi (80 kW)	2007.09-	Estate Engine 9HZ(DV6TED4)	•		GHA425022	
	2007.09-	Estate Engine 9HZ(DV6TED4)	•		GWB3584	
	2007.09-	Estate Engine 9HZ(DV6TED4)		◦	GHA230148	K
	2007.09-	Estate Engine 9HZ(DV6TED4)		◦	GWB6549	
1.6 HDi (82 kW)	2009.12-	Estate Engine 9HR(DV6C)	•		GHA425022	
	2009.12-	Estate Engine 9HR(DV6C)	•		GWB3584	
	2009.12-	Estate Engine 9HR(DV6C)		◦	GHA230148	K
	2009.12-	Estate Engine 9HR(DV6C)		◦	GWB6549	
1.6 HDi (84 kW)	2013.03-	Estate	•		GWB3584	
	2013.03-	Estate		◦	GWB6549	
2.0 HDi (100 kW)	2007.09-	Estate Engine RHR(DW10BTED4)	•		GHA425022	
	2007.09-	Estate Engine RHR(DW10BTED4)	•		GWB3584	
	2007.09-	Estate Engine RHR(DW10BTED4)		◦	GHA230148	K
	2007.09-	Estate Engine RHR(DW10BTED4)		◦	GWB6549	
2.0 HDi (103 kW)	2007.09-	Estate Engine RHR(DW10BTED4)	•		GHA425022	
	2007.09-	Estate Engine RHR(DW10BTED4)	•		GWB3584	
	2007.09-	Estate Engine RHR(DW10BTED4)		◦	GHA230148	K
	2007.09-	Estate Engine RHR(DW10BTED4)		◦	GWB6549	
2.0 HDi (110 kW)	2011.04-	Estate Engine RHE(DW10CTED4)	•		GHA425022	
	2011.04-	Estate Engine RHE(DW10CTED4)	•		GWB3584	
	2011.04-	Estate Engine RHE(DW10CTED4)		◦	GHA230148	K
	2011.04-	Estate Engine RHE(DW10CTED4)		◦	GWB6549	
2.0 HDi (120 kW)	2009.06-	Estate Engine RHH(DW10CTED4)	•		GHA425022	
	2009.06-	Estate Engine RHH(DW10CTED4)	•		GWB3584	
	2009.06-	Estate Engine RHH(DW10CTED4)		◦	GHA230148	K
	2009.06-	Estate Engine RHH(DW10CTED4)		◦	GWB6549	
309 II (3C, 3A)						
1.1 (44 kW)	1990.08-1993.12	Hatchback Engine HDZ(TU1M)	•		GHA425022	
	1990.08-1993.12	Hatchback Engine HDZ(TU1M)	•		GWB0882	
	1990.08-1993.12	Hatchback Engine HDZ(TU1M)		◦	GWB0961	
1.4 (49 kW)	1990.07-1993.12	Hatchback Engine K1D(TU3A)	•		GHA425022	
	1990.07-1993.12	Hatchback Engine K1D(TU3A)	•		GWB0882	
	1990.07-1993.12	Hatchback Engine K1D(TU3A)		◦	GWB0961	
1.9 (80 kW)	1990.10-1993.12	Hatchback Engine DDZ(XU9M)	•		GHA425022	
	1990.10-1993.12	Hatchback Engine DDZ(XU9M)	•		GWB0915	
	1990.10-1993.12	Hatchback Engine DDZ(XU9M)		◦	GWB0961	
1.9 GTi 16V (108 kW)	1990.10-1993.12	Hatchback Engine DFW(XU9J4Z)	•		GHA425022	



	 YEAR		F	R	G-AP Ref.	KIT
PEUGEOT						
309 II (3C, 3A)						
1.9 GTi 16V (108 kW)	1990.10-1993.12	Hatchback Engine DFW(XU9J4Z)	•		GWB0915	
	1990.10-1993.12	Hatchback Engine DFW(XU9J4Z)		◦	GHA225032	K
	1990.10-1993.12	Hatchback Engine DFW(XU9J4Z)		◦	GWB0961	
4007 (GP_)						
2.0 (108 kW)	2010.11-	Closed Off-Road Vehicle Engine 4B11	•		GWB7408	
2.0 4x4 (108 kW)	2010.11-	Closed Off-Road Vehicle Engine 4B11	•		GWB7408	
	2010.11-	Closed Off-Road Vehicle Engine 4B11		◦	GHA325018	K
2.2 HDi (115 kW)	2007.07-	Closed Off-Road Vehicle Engine 4HN(DW12MTED4)	•		GWB7408	
	2007.07-	Closed Off-Road Vehicle Engine 4HN(DW12MTED4)		◦	GHA327044	K
2.4 16V (125 kW)	2008.01-	Closed Off-Road Vehicle	•		GWB7408	
	2008.01-	Closed Off-Road Vehicle		◦	GHA327044	K
4008						
1.6 HDi AWC (84 kW)	2012.05-	Closed Off-Road Vehicle	•		GWB7408	
	2012.05-	Closed Off-Road Vehicle		◦	GHA325018	K
1.8 HDi AWC (110 kW)	2012.05-	Closed Off-Road Vehicle	•		GWB7408	
	2012.05-	Closed Off-Road Vehicle		◦	GHA325018	K
2.0 AWC (110 kW)	2012.05-	Closed Off-Road Vehicle Engine 4B11	•		GWB7408	
	2012.05-	Closed Off-Road Vehicle Engine 4B11		◦	GHA325018	K
405 I (15B)						
1.9 4x4 (93 kW)	1990.07-1992.07	Saloon	•		GWB0915	
	1990.07-1992.07	Saloon		◦	GHA425022	
405 I BREAK (15E)						
1.8 GLD (44 kW)	1990.04-1992.07	Estate	•		GHA425022	
	1990.04-1992.07	Estate	•		GWB0915	
	1990.04-1992.07	Estate Without ABS		◦	GHA232004	K
1.9 4x4 (108 kW)	1990.07-1992.07	Estate	•		GWB0915	
	1990.07-1992.07	Estate		◦	GHA425022	
1.9 4x4 (88 kW)	1990.07-1992.07	Estate Engine DKZ (XU9JAZ)	•		GHA425022	
	1990.07-1992.07	Estate Engine DKZ (XU9JAZ)	•		GWB0915	
405 II (4B)						
1.4 (55 kW)	1992.08-1995.10	Saloon Engine KDX(TU3MC)	•		GHA425022	
	1992.08-1995.10	Saloon Engine KDX(TU3MC)	•		GWB0915	
	1992.08-1995.10	Saloon Engine KDX(TU3MC) Without ABS		◦	GHA232004	K
1.6 (65 kW)	1992.08-1995.10	Saloon Engine BDY(XU5M2Z)/BDY(XU5M3Z)/BDZ(XU5M)/BFZ(XU5JP)	•		GHA425022	
	1992.08-1995.10	Saloon Engine BDY(XU5M2Z)/BDY(XU5M3Z)/BDZ(XU5M)/BFZ(XU5JP)	•		GWB0915	
	1992.08-1995.10	Saloon Engine BDY(XU5M2Z)/BDY(XU5M3Z)/BDZ(XU5M)/BFZ(XU5JP) Without ABS		◦	GHA232004	K
1.6 (66 kW)	1992.08-1997.05	Saloon Engine B2A (XU52C/K)/BFZ (XU5JP)	•		GHA425022	
	1992.08-1997.05	Saloon Engine B2A (XU52C/K)/BFZ (XU5JP)	•		GWB0915	
	1992.08-1997.05	Saloon Engine B2A (XU52C/K)/BFZ (XU5JP) Without ABS		◦	GHA232004	K
1.6 (68 kW)	1992.08-1994.08	Saloon Engine B2A (XU52C/K)	•		GHA425022	
	1992.08-1994.08	Saloon Engine B2A (XU52C/K)	•		GWB0915	
	1992.08-1994.08	Saloon Engine B2A (XU52C/K) Without ABS		◦	GHA232004	K
1.8 (74 kW)	1992.08-1995.10	Saloon Engine LFZ(XU7JP)	•		GHA425022	
	1992.08-1995.10	Saloon Engine LFZ(XU7JP)	•		GWB0915	
	1992.08-1995.10	Saloon Engine LFZ(XU7JP) Without ABS		◦	GHA232004	K
1.8 (76 kW)	1996.08-1999.11	Saloon Engine LFZ (XU7JP)	•		GHA425022	
	1996.08-1999.11	Saloon Engine LFZ (XU7JP)	•		GWB0915	
	1996.08-1999.11	Saloon Engine LFZ (XU7JP) Without ABS		◦	GHA232004	K
1.9 D (47 kW)	1992.08-1995.10	Saloon Engine DJZ(XUD9Y)	•		GHA425022	
	1992.08-1995.10	Saloon Engine DJZ(XUD9Y)	•		GWB0915	
	1992.08-1995.10	Saloon Engine DJZ(XUD9Y) Without ABS		◦	GHA232004	K
1.9 D (50 kW)	1994.06-1995.10	Saloon Engine DJY(XUD9A)	•		GHA425022	
	1994.06-1995.10	Saloon Engine DJY(XUD9A)	•		GWB0915	
	1994.06-1995.10	Saloon Engine DJY(XUD9A) Without ABS		◦	GHA232004	K
1.9 D (51 kW)	1992.08-1994.08	Saloon	•		GHA425022	
	1992.08-1994.08	Saloon	•		GWB0915	
	1992.08-1994.08	Saloon Without ABS		◦	GHA232004	K
1.9 D (52 kW)	1997.08-1999.11	Saloon Engine DJY(XUD9A)	•		GHA425022	
	1997.08-1999.11	Saloon Engine DJY(XUD9A)	•		GWB0915	
	1997.08-1999.11	Saloon Engine DJY(XUD9A) Without ABS		◦	GHA232004	K
1.9 TD (66 kW)	1992.08-1995.10	Saloon Engine DHY(XUD9TE)	•		GHA425022	
	1992.08-1995.10	Saloon Engine DHY(XUD9TE)	•		GWB0915	
	1992.08-1995.10	Saloon Engine DHY(XUD9TE) Without ABS		◦	GHA232004	K



	 YEAR		F	R	G-AP Ref.	KIT
PEUGEOT						
405 II (4B)						
1.9 TD (69 kW)	1992.08-1997.05	Saloon Engine DJY(XUD9TE)	•		GHA425022	
	1992.08-1997.05	Saloon Engine DJY(XUD9TE)	•		GWB0915	
	1992.08-1997.05	Saloon Engine DJY(XUD9TE) Without ABS		○	GHA232004	K
2.0 (89 kW)	1992.08-1995.10	Saloon Engine RFX(XU10J2)	•		GHA425022	
	1992.08-1995.10	Saloon Engine RFX(XU10J2)	•		GWB0915	
	1992.08-1995.10	Saloon Engine RFX(XU10J2) Without ABS		○	GHA232004	K
2.0 16V (110 kW)	1994.06-1995.10	Saloon Engine RFT(XU10J4)	•		GHA425022	
	1994.06-1995.10	Saloon Engine RFT(XU10J4)	•		GWB0915	
	1994.06-1995.10	Saloon Engine RFT(XU10J4) Without ABS		○	GHA232004	K
2.0 MI-16 (112 kW)	1992.08-1995.10	Saloon Engine RFY(XU10J4Z)	•		GHA425022	
	1992.08-1995.10	Saloon Engine RFY(XU10J4Z)	•		GWB0915	
	1992.08-1995.10	Saloon Engine RFY(XU10J4Z) Without ABS		○	GHA232004	K
2.0 T 16 X4 (144 kW)	1992.08-1995.10	Saloon Engine RGZ(XU10J4TE/Z)	•		GWB0915	
	1992.08-1995.10	Saloon Engine RGZ(XU10J4TE/Z)		○	GHA425022	
2.0 X4 (89 kW)	1992.08-1995.10	Saloon Engine RFX(XU10J2)	•		GWB0915	
	1992.08-1995.10	Saloon Engine RFX(XU10J2)		○	GHA425022	
405 II (4E)						
1.4 (55 kW)	1992.08-1996.10	Estate Engine KDX(TU3MC)	•		GHA425022	
	1992.08-1996.10	Estate Engine KDX(TU3MC)	•		GWB0915	
	1992.08-1996.10	Estate Engine KDX(TU3MC) Without ABS		○	GHA232004	K
1.6 (65 kW)	1992.08-1996.10	Estate Engine BDY(XU5M2Z)/BDY(XU5M3Z)/BDZ(XU5M)/BFZ(XU5JP)	•		GHA425022	
	1992.08-1996.10	Estate Engine BDY(XU5M2Z)/BDY(XU5M3Z)/BDZ(XU5M)/BFZ(XU5JP)	•		GWB0915	
	1992.08-1996.10	Estate Engine BDY(XU5M2Z)/BDY(XU5M3Z)/BDZ(XU5M)/BFZ(XU5JP) Without ABS		○	GHA232004	K
1.8 (74 kW)	1992.08-1996.10	Estate Engine LFZ(XU7JP)	•		GHA425022	
	1992.08-1996.10	Estate Engine LFZ(XU7JP)	•		GWB0915	
	1992.08-1996.10	Estate Engine LFZ(XU7JP) Without ABS		○	GHA232004	K
1.9 D (47 kW)	1992.08-1996.10	Estate Engine DJZ(XUD9Y)	•		GHA425022	
	1992.08-1996.10	Estate Engine DJZ(XUD9Y)	•		GWB0915	
	1992.08-1996.10	Estate Engine DJZ(XUD9Y) Without ABS		○	GHA232004	K
1.9 D (50 kW)	1994.06-1996.10	Estate Engine DJY(XUD9A)	•		GHA425022	
	1994.06-1996.10	Estate Engine DJY(XUD9A)	•		GWB0915	
	1994.06-1996.10	Estate Engine DJY(XUD9A) Without ABS		○	GHA232004	K
1.9 D (51 kW)	1993.09-1995.12	Estate Engine XUD9	•		GHA425022	
	1993.09-1995.12	Estate Engine XUD9	•		GWB0915	
	1993.09-1995.12	Estate Engine XUD9 Without ABS		○	GHA232004	K
1.9 TD (66 kW)	1992.08-1996.10	Estate Engine DHY(XUD9TE)	•		GHA425022	
	1992.08-1996.10	Estate Engine DHY(XUD9TE)	•		GWB0915	
	1992.08-1996.10	Estate Engine DHY(XUD9TE) Without ABS		○	GHA232004	K
2.0 (89 kW)	1992.08-1996.10	Estate Engine RFX(XU10J2)	•		GHA425022	
	1992.08-1996.10	Estate Engine RFX(XU10J2)	•		GWB0915	
	1992.08-1996.10	Estate Engine RFX(XU10J2) Without ABS		○	GHA232004	K
2.0 4x4 (144 kW)	1992.08-1995.12	Estate Engine RGZ(XU10J4TE/Z)	•		GWB0915	
	1992.08-1995.12	Estate Engine RGZ(XU10J4TE/Z)		○	GHA425022	
2.0 4x4 (89 kW)	1992.08-1996.10	Estate Engine RFX(XU10J2)	•		GWB0915	
	1992.08-1996.10	Estate Engine RFX(XU10J2)		○	GHA425022	
405 II BREAK (4E)						
1.4 (58 kW)	1993.07-1994.06	Estate	•		GWB0915	
	1993.07-1994.06	Estate Without ABS		○	GHA232004	K
1.6 (68 kW)	1992.08-1994.08	Estate Engine BDZ (XU5M)/BFZ (XU5JP)	•		GHA425022	
1.6 (80 kW)	1992.08-1996.1	Estate Engine NFU (TU5JP4)	•		GHA425022	
1.9 TD (69 kW)	1992.08-1996.1	Estate Engine DHY (XUD9TE)	•		GHA425022	
406 (8B)						
1.6 (65 kW)	1995.11-2004.05	Saloon Engine BFZ(XU5JP)	•		GHA425022	
	1995.11-2004.05	Saloon Engine BFZ(XU5JP)	•		GWB0915	
	1995.11-2004.05	Saloon Engine BFZ(XU5JP)		○	GHA232013	K
	1995.11-2004.05	Saloon Engine BFZ(XU5JP)		○	GHA232035	K
	1995.11-2004.05	Saloon Engine BFZ(XU5JP) Without ABS		○	GHA232011	K
1.8 (66 kW)	1997.05-2004.05	Saloon Engine LFX(XU7JB)	•		GHA425022	
	1997.05-2004.05	Saloon Engine LFX(XU7JB)	•		GWB0915	
	1997.05-2004.05	Saloon Engine LFX(XU7JB)		○	GHA232013	K
	1997.05-2004.05	Saloon Engine LFX(XU7JB)		○	GHA232035	K
	1997.05-2004.05	Saloon Engine LFX(XU7JB) Without ABS		○	GHA232011	K
1.8 16V (81 kW)	1995.11-2000.10	Saloon Engine LFY(XU7JP4)	•		GHA425022	
	1995.11-2000.10	Saloon Engine LFY(XU7JP4)	•		GWB0915	



	 YEAR		F	R	G-AP Ref.	KIT
PEUGEOT						
406 (8B)						
1.8 16V (81 kW)	1995.11-2000.10	Saloon Engine LFY(XU7JP4)		o	GHA232013	K
	1995.11-2000.10	Saloon Engine LFY(XU7JP4)		o	GHA232035	K
	1995.11-2000.10	Saloon Engine LFY(XU7JP4) Without ABS		o	GHA232011	K
1.8 16V (85 kW)	2000.10-2004.05	Saloon Engine 6FZ(EW7J4)	•		GHA425022	
	2000.10-2004.05	Saloon Engine 6FZ(EW7J4)	•		GWB0915	
	2000.10-2004.05	Saloon Engine 6FZ(EW7J4)		o	GHA232035	K
1.9 D (55 kW)	1996.10-2004.05	Saloon Engine DHW(XUD9SD)	•		GHA425022	
	1996.10-2004.05	Saloon Engine DHW(XUD9SD)	•		GWB0915	
	1996.10-2004.05	Saloon Engine DHW(XUD9SD)		o	GHA232013	K
	1996.10-2004.05	Saloon Engine DHW(XUD9SD)		o	GHA232035	K
	1996.10-2004.05	Saloon Engine DHW(XUD9SD) Without ABS		o	GHA232011	K
1.9 TD (66 kW)	1996.01-2004.05	Saloon Engine DHX(XUD9TE)	•		GHA425022	
	1996.01-2004.05	Saloon Engine DHX(XUD9TE)	•		GWB0915	
	1996.01-2004.05	Saloon Engine DHX(XUD9TE)		o	GHA232013	K
	1996.01-2004.05	Saloon Engine DHX(XUD9TE)		o	GHA232035	K
	1996.01-2004.05	Saloon Engine DHX(XUD9TE) Without ABS		o	GHA232011	K
1.9 TD (68 kW)	1996.01-2004.05	Saloon Engine DHY(XUD9TE)	•		GHA425022	
	1996.01-2004.05	Saloon Engine DHY(XUD9TE)	•		GWB0915	
	1996.01-2004.05	Saloon Engine DHY(XUD9TE)		o	GHA232013	K
	1996.01-2004.05	Saloon Engine DHY(XUD9TE)		o	GHA232035	K
	1996.01-2004.05	Saloon Engine DHY(XUD9TE) Without ABS		o	GHA232011	K
2.0 (104 kW)	1996.11-1999.03	Saloon Engine RGY (XU10J2TE)	•		GHA425022	
	1996.11-1999.03	Saloon Engine RGY (XU10J2TE)	•		GWB0915	
	1996.11-1999.03	Saloon Engine RGY (XU10J2TE)		o	GHA232013	K
	1996.11-1999.03	Saloon Engine RGY (XU10J2TE)		o	GHA232035	K
	1996.11-1999.03	Saloon Engine RGY (XU10J2TE) Without ABS		o	GHA232011	K
2.0 16V (100 kW)	2000.08-2004.06	Saloon Engine RFN(EW10J4)	•		GHA425022	
	2000.08-2004.06	Saloon Engine RFN(EW10J4)	•		GWB0915	
	2000.08-2004.06	Saloon Engine RFN(EW10J4)		o	GHA232035	K
2.0 16V (97 kW)	1995.11-2004.05	Saloon Engine RFV(XU10J4R)	•		GHA425022	
	1995.11-2004.05	Saloon Engine RFV(XU10J4R)	•		GWB0915	
	1995.11-2004.05	Saloon Engine RFV(XU10J4R)		o	GHA232013	K
	1995.11-2004.05	Saloon Engine RFV(XU10J4R)		o	GHA232035	K
	1995.11-2004.05	Saloon Engine RFV(XU10J4R) Without ABS		o	GHA232011	K
2.0 16V (99 kW)	1999.01-2000.08	Saloon Engine RFR(DEW10J4)	•		GWB0915	
	1999.01-2000.08	Saloon Engine RFR(DEW10J4)		o	GHA232035	K
2.0 16V HPi (103 kW)	2001.05-2004.05	Saloon Engine RLZ(EW10D)	•		GHA425022	
	2001.05-2004.05	Saloon Engine RLZ(EW10D)	•		GWB0915	
	2001.05-2004.05	Saloon Engine RLZ(EW10D)		o	GHA232035	K
2.0 HDi (66 kW)	1999.02-2004.05	Saloon Engine RHY(DW10TD)	•		GHA425022	
	1999.02-2004.05	Saloon Engine RHY(DW10TD)	•		GWB0915	
	1999.02-2004.05	Saloon Engine RHY(DW10TD)		o	GHA232035	K
2.0 HDi (79 kW)	2001.08-2004.05	Saloon Engine RHS(DW10ATED)/RHZ(DW10ATED)	•		GHA425022	
	2001.08-2004.05	Saloon Engine RHS(DW10ATED)/RHZ(DW10ATED)	•		GWB0915	
	2001.08-2004.05	Saloon Engine RHS(DW10ATED)/RHZ(DW10ATED)		o	GHA232035	K
2.0 HDi (80 kW)	1998.06-2001.08	Saloon Engine RHZ(DW10ATED)	•		GHA425022	
	1998.06-2001.08	Saloon Engine RHZ(DW10ATED)	•		GWB0915	
	1998.06-2001.08	Saloon Engine RHZ(DW10ATED)		o	GHA232035	K
2.0 Turbo (108 kW)	1996.04-2004.05	Saloon Engine RGX(XU10J2TE)	•		GHA425022	
	1996.04-2004.05	Saloon Engine RGX(XU10J2TE)	•		GWB0915	
	1996.04-2004.05	Saloon Engine RGX(XU10J2TE)		o	GHA232013	K
	1996.04-2004.05	Saloon Engine RGX(XU10J2TE)		o	GHA232035	K
	1996.04-2004.05	Saloon Engine RGX(XU10J2TE) Without ABS		o	GHA232011	K
2.1 TD 12V (80 kW)	1996.01-2004.05	Saloon Engine P8C(XUD11BTE)	•		GHA425022	
	1996.01-2004.05	Saloon Engine P8C(XUD11BTE)	•		GWB0915	
	1996.01-2004.05	Saloon Engine P8C(XUD11BTE)		o	GHA232013	K
	1996.01-2004.05	Saloon Engine P8C(XUD11BTE)		o	GHA232035	K
	1996.01-2004.05	Saloon Engine P8C(XUD11BTE) Without ABS		o	GHA232011	K
2.2 (116 kW)	2000.07-2004.05	Saloon Engine 3FZ(EW12J4)	•		GHA425022	
	2000.07-2004.05	Saloon Engine 3FZ(EW12J4)	•		GWB0915	
	2000.07-2004.05	Saloon Engine 3FZ(EW12J4)		o	GHA232035	K
2.2 HDi (98 kW)	2000.03-2004.05	Saloon Engine 4HX(DW12TED4/FAP)	•		GHA425022	
	2000.03-2004.05	Saloon Engine 4HX(DW12TED4/FAP)	•		GWB0915	
	2000.03-2004.05	Saloon Engine 4HX(DW12TED4/FAP)		o	GHA232035	K



	 YEAR		F	R	G-AP Ref.	KIT
PEUGEOT						
406 (8B)						
3.0 24V (140 kW)	1996.10-2004.05	Saloon Engine XFZ(ES9J4)	•		GHA425022	
	1996.10-2004.05	Saloon Engine XFZ(ES9J4)	•		GWB0915	
	1996.10-2004.05	Saloon Engine XFZ(ES9J4)		○	GHA232013	K
	1996.10-2004.05	Saloon Engine XFZ(ES9J4)		○	GHA232035	K
	1996.10-2004.05	Saloon Engine XFZ(ES9J4) Without ABS		○	GHA232011	K
3.0 V6 (152 kW)	2000.03-2004.05	Saloon Engine XFX(ES9J4S)	•		GHA425022	
	2000.03-2004.05	Saloon Engine XFX(ES9J4S)	•		GWB0915	
	2000.03-2004.05	Saloon Engine XFX(ES9J4S)		○	GHA232035	K
406 (8C)						
2.0 16V (100 kW)	2000.10-2004.12	Coupe Engine RFN(EW10J4)	•		GHA425022	
	2000.10-2004.12	Coupe Engine RFN(EW10J4)	•		GWB0915	
	2000.10-2004.12	Coupe Engine RFN(EW10J4)		○	GHA232035	K
2.0 16V (97 kW)	1997.03-2004.12	Coupe Engine RFV(XU10J4R)	•		GHA425022	
	1997.03-2004.12	Coupe Engine RFV(XU10J4R)	•		GWB0915	
	1997.03-2004.12	Coupe Engine RFV(XU10J4R)		○	GHA232013	K
	1997.03-2004.12	Coupe Engine RFV(XU10J4R)		○	GHA232035	K
2.0 16V (99 kW)	1999.01-2000.10	Coupe Engine RFR(DEW10J4)	•		GHA425022	
	1999.01-2000.10	Coupe Engine RFR(DEW10J4)	•		GWB0915	
	1999.01-2000.10	Coupe Engine RFR(DEW10J4)		○	GHA232035	K
	1999.04-2004.09	Coupe Engine RFV(XU10J4R)	•		GHA425022	
	1999.04-2004.09	Coupe Engine RFV(XU10J4R)	•		GWB0915	
	1999.04-2004.09	Coupe Engine RFV(XU10J4R)		○	GHA232035	K
2.2 (116 kW)	2002.03-2004.12	Coupe Engine 3FZ(EW12J4)	•		GHA425022	
	2002.03-2004.12	Coupe Engine 3FZ(EW12J4)	•		GWB0915	
	2002.03-2004.12	Coupe Engine 3FZ(EW12J4)		○	GHA232035	K
2.2 HDi (98 kW)	2000.03-2004.12	Coupe Engine 4HX(DW12TED4/FAP)	•		GHA425022	
	2000.03-2004.12	Coupe Engine 4HX(DW12TED4/FAP)	•		GWB0915	
	2000.03-2004.12	Coupe Engine 4HX(DW12TED4/FAP)		○	GHA232035	K
3.0 V6 (152 kW)	2000.03-2004.12	Coupe Engine XFX(ES9J4S)	•		GHA425022	
	2000.03-2004.12	Coupe Engine XFX(ES9J4S)	•		GWB0915	
	2000.03-2004.12	Coupe Engine XFX(ES9J4S)		○	GHA232035	K
3.0 V6 24V (140 kW)	1997.03-2004.12	Coupe Engine XFZ(ES9J4)	•		GHA425022	
	1997.03-2004.12	Coupe Engine XFZ(ES9J4)	•		GWB0915	
	1997.03-2004.12	Coupe Engine XFZ(ES9J4)		○	GHA232013	K
	1997.03-2004.12	Coupe Engine XFZ(ES9J4)		○	GHA232035	K
406 (8E/F)						
1.8 (66 kW)	1997.05-2004.10	Estate Engine LFX(XU7JB)	•		GHA425022	
	1997.05-2004.10	Estate Engine LFX(XU7JB)	•		GWB0915	
	1997.05-2004.10	Estate Engine LFX(XU7JB)		○	GHA232013	K
	1997.05-2004.10	Estate Engine LFX(XU7JB)		○	GHA232035	K
	1997.05-2004.10	Estate Engine LFX(XU7JB) Without ABS		○	GHA232011	K
1.8 16V (81 kW)	1996.10-2000.10	Estate Engine LFY(XU7JP4)	•		GHA425022	
	1996.10-2000.10	Estate Engine LFY(XU7JP4)	•		GWB0915	
	1996.10-2000.10	Estate Engine LFY(XU7JP4)		○	GHA232013	K
	1996.10-2000.10	Estate Engine LFY(XU7JP4)		○	GHA232035	K
	1996.10-2000.10	Estate Engine LFY(XU7JP4) Without ABS		○	GHA232011	K
1.8 16V (85 kW)	2000.10-2004.10	Estate Engine 6FZ(EW7J4)	•		GHA425022	
	2000.10-2004.10	Estate Engine 6FZ(EW7J4)	•		GWB0915	
	2000.10-2004.10	Estate Engine 6FZ(EW7J4)		○	GHA232035	K
1.9 D (55 kW)	1996.10-2004.10	Estate Engine DHW(XUD9SD)	•		GHA425022	
	1996.10-2004.10	Estate Engine DHW(XUD9SD)	•		GWB0915	
	1996.10-2004.10	Estate Engine DHW(XUD9SD)		○	GHA232013	K
	1996.10-2004.10	Estate Engine DHW(XUD9SD)		○	GHA232035	K
	1996.10-2004.10	Estate Engine DHW(XUD9SD) Without ABS		○	GHA232011	K
1.9 TD (66 kW)	1996.10-2004.10	Estate Engine DHX(XUD9TE)	•		GHA425022	
	1996.10-2004.10	Estate Engine DHX(XUD9TE)	•		GWB0915	
	1996.10-2004.10	Estate Engine DHX(XUD9TE)		○	GHA232013	K
	1996.10-2004.10	Estate Engine DHX(XUD9TE)		○	GHA232035	K
	1996.10-2004.10	Estate Engine DHX(XUD9TE) Without ABS		○	GHA232011	K
2.0 16V (100 kW)	2000.10-2004.10	Estate Engine RFN(EW10J4)	•		GHA425022	
	2000.10-2004.10	Estate Engine RFN(EW10J4)	•		GWB0915	
	2000.10-2004.10	Estate Engine RFN(EW10J4)		○	GHA232035	K
2.0 16V (97 kW)	1996.10-2004.10	Estate Engine RFV(XU10J4R)	•		GHA425022	
	1996.10-2004.10	Estate Engine RFV(XU10J4R)	•		GWB0915	



	 YEAR		F	R	G-AP Ref.	KIT
PEUGEOT						
406 (8E/F)						
2.0 16V (97 kW)	1996.10-2004.10	Estate Engine RFV(XU10J4R)		o	GHA232013	K
	1996.10-2004.10	Estate Engine RFV(XU10J4R)		o	GHA232035	K
	1996.10-2004.10	Estate Engine RFV(XU10J4R) Without ABS		o	GHA232011	K
2.0 16V (99 kW)	1999.01-2000.10	Estate Engine RFR(DEW10J4)	•		GHA425022	
	1999.01-2000.10	Estate Engine RFR(DEW10J4)	•		GWB0915	
	1999.01-2000.10	Estate Engine RFR(DEW10J4)		o	GHA232035	K
2.0 16V HPi (103 kW)	2001.05-2004.10	Estate Engine RLZ(EW10D)	•		GHA425022	
	2001.05-2004.10	Estate Engine RLZ(EW10D)	•		GWB0915	
	2001.05-2004.10	Estate Engine RLZ(EW10D)		o	GHA232035	K
2.0 HDi (66 kW)	1999.02-2004.10	Estate Engine RHY(DW10TD)	•		GHA425022	
	1999.02-2004.10	Estate Engine RHY(DW10TD)	•		GWB0915	
	1999.02-2004.10	Estate Engine RHY(DW10TD)		o	GHA232035	K
2.0 HDi (79 kW)	2001.08-2004.10	Estate Engine RHS(DW10ATED)/RHZ(DW10ATED)	•		GHA425022	
	2001.08-2004.10	Estate Engine RHS(DW10ATED)/RHZ(DW10ATED)	•		GWB0915	
	2001.08-2004.10	Estate Engine RHS(DW10ATED)/RHZ(DW10ATED)		o	GHA232035	K
2.0 HDi (80 kW)	1999.02-2004.04	Estate Engine RHZ(DW10ATED)	•		GHA425022	
	1999.02-2004.04	Estate Engine RHZ(DW10ATED)	•		GWB0915	
	1999.02-2004.04	Estate Engine RHZ(DW10ATED)		o	GHA232035	K
2.0 Turbo (108 kW)	1996.10-2004.10	Estate Engine RGX(XU10J2TE)	•		GHA425022	
	1996.10-2004.10	Estate Engine RGX(XU10J2TE)	•		GWB0915	
	1996.10-2004.10	Estate Engine RGX(XU10J2TE)		o	GHA232013	K
	1996.10-2004.10	Estate Engine RGX(XU10J2TE)		o	GHA232035	K
	1996.10-2004.10	Estate Engine RGX(XU10J2TE) Without ABS		o	GHA232011	K
2.1 TD 12V (80 kW)	1996.10-2004.10	Estate Engine P8C(XUD11BTE)	•		GHA425022	
	1996.10-2004.10	Estate Engine P8C(XUD11BTE)	•		GWB0915	
	1996.10-2004.10	Estate Engine P8C(XUD11BTE)		o	GHA232013	K
	1996.10-2004.10	Estate Engine P8C(XUD11BTE)		o	GHA232035	K
	1996.10-2004.10	Estate Engine P8C(XUD11BTE) Without ABS		o	GHA232011	K
2.2 (116 kW)	2000.07-2004.10	Estate Engine 3FZ(EW12J4)	•		GHA425022	
	2000.07-2004.10	Estate Engine 3FZ(EW12J4)	•		GWB0915	
	2000.07-2004.10	Estate Engine 3FZ(EW12J4)		o	GHA232035	K
2.2 HDi (98 kW)	2000.03-2004.10	Estate Engine 4HX(DW12TED4/FAP)	•		GHA425022	
	2000.03-2004.10	Estate Engine 4HX(DW12TED4/FAP)	•		GWB0915	
	2000.03-2004.10	Estate Engine 4HX(DW12TED4/FAP)		o	GHA232035	K
3.0 24V (140 kW)	1996.10-2004.10	Estate Engine XFZ(ES9J4)	•		GHA425022	
	1996.10-2004.10	Estate Engine XFZ(ES9J4)	•		GWB0915	
	1996.10-2004.10	Estate Engine XFZ(ES9J4)		o	GHA232013	K
	1996.10-2004.10	Estate Engine XFZ(ES9J4)		o	GHA232035	K
	1996.10-2004.10	Estate Engine XFZ(ES9J4) Without ABS		o	GHA232011	K
3.0 V6 (152 kW)	2000.03-2004.10	Estate Engine XFX(ES9J4S)	•		GHA425022	
	2000.03-2004.10	Estate Engine XFX(ES9J4S)	•		GWB0915	
	2000.03-2004.10	Estate Engine XFX(ES9J4S)		o	GHA232035	K
406 BREAK (8E/F)						
2.0 (104 kW)	1996.11-1999.03	Estate Engine RGY (XU10J2TE)	•		GHA425022	
	1996.11-1999.03	Estate Engine RGY (XU10J2TE)	•		GWB0915	
	1996.11-1999.03	Estate Engine RGY (XU10J2TE)		o	GHA232013	K
	1996.11-1999.03	Estate Engine RGY (XU10J2TE)		o	GHA232035	K
	1996.11-1999.03	Estate Engine RGY (XU10J2TE) Without ABS		o	GHA232011	K
407 (6C_)						
2.0 HDi (100 kW)	2005.10-	Coupe Engine RHR(DW10BTED4)	•		GWB3683	
	2005.10-	Coupe Engine RHR(DW10BTED4)		o	GHA232038	K
2.0 HDi (103 kW)	2008.09-2009.12	Coupe Engine RHR (DW10BTED4)	•		GWB3683	
	2008.09-2009.12	Coupe Engine RHR (DW10BTED4)		o	GHA232038	K
2.0 HDi (110 kW)	2010.02-	Coupe Engine RHE(DW10CTED4)	•		GWB3683	
	2010.02-	Coupe Engine RHE(DW10CTED4)		o	GHA232038	K
2.0 HDi (120 kW)	2009.06-	Coupe Engine RHH(DW10CTED4)	•		GWB3683	
	2009.06-	Coupe Engine RHH(DW10CTED4)		o	GHA232038	K
2.2 16V (120 kW)	2005.10-2006.12	Coupe Engine 3FY(EW12J4)	•		GWB3683	
	2005.10-2006.12	Coupe Engine 3FY(EW12J4)		o	GHA232038	K
2.7 HDi (150 kW)	2005.10-2006.12	Coupe Engine UHZ(DT17)	•		GWB3683	
	2005.10-2006.12	Coupe Engine UHZ(DT17)		o	GHA232038	K
3.0 HDi (177 kW)	2009.06-	Coupe Engine DT20C	•		GWB3683	
	2009.06-	Coupe Engine DT20C		o	GHA232038	K
3.0 V6 (155 kW)	2005.10-2006.12	Coupe Engine XFX(ES9A)	•		GWB3683	



	 YEAR		F	R	G-AP Ref.	KIT
PEUGEOT						
407 (6C_)						
3.0 V6 (155 kW)	2005.10-2006.12	Coupe Engine Xfv(ES9A)		o	GHA232038	K
407 (6D_)						
1.6 HDi (80 kW)	2004.05- 2004.05-	Saloon Engine 9HY(DV6TED4)/9HZ(DV6TED4) Saloon Engine 9HY(DV6TED4)/9HZ(DV6TED4)	•	o	GWB3683 GHA232029	K
1.8 (85 kW)	2004.05- 2004.05-	Saloon Engine 6FZ(EW7J4) Saloon Engine 6FZ(EW7J4)	•	o	GWB3683 GHA232029	K
1.8 16V (92 kW)	2005.10-2007.04 2005.10-2007.04	Saloon Engine 6FY(EW7A) Saloon Engine 6FY(EW7A)	•	o	GWB3683 GHA232029	K
2.0 (100 kW)	2004.05- 2004.05-	Saloon Engine RFN(EW10J4) Saloon Engine RFN(EW10J4)	•	o	GWB3683 GHA232029	K
2.0 16V (103 kW)	2005.10-2007.04 2005.10-2007.04	Saloon Engine RFJ(EW10A) Saloon Engine RFJ(EW10A)	•	o	GWB3683 GHA232029	K
2.0 Bioflex (103 kW)	2007.09- 2007.09-	Saloon Engine RFJ(EW10A) Saloon Engine RFJ(EW10A)	•	o	GWB3683 GHA232029	K
2.0 HDi (100 kW)	2004.05- 2004.05-	Saloon Engine RHR(DW10BTED4) Saloon Engine RHR(DW10BTED4)	•	o	GWB3683 GHA232029	K
2.0 HDi (103 kW)	2008.08- 2008.08-	Saloon Engine RHF(DW10BTED4)/RHR(DW10BTED4) Saloon Engine RHF(DW10BTED4)/RHR(DW10BTED4)	•	o	GWB3683 GHA232029	K
2.0 HDi (110 kW)	2010.02- 2010.02-	Saloon Engine RHE(DW10CTED4) Saloon Engine RHE(DW10CTED4)	•	o	GWB3683 GHA232029	K
2.0 HDi (120 kW)	2009.07- 2009.07-	Saloon Engine RHH(DW10CTED4) Saloon Engine RHH(DW10CTED4)	•	o	GWB3683 GHA232029	K
2.2 (116 kW)	2004.05- 2004.05-	Saloon Engine 3FZ(EW12J4) Saloon Engine 3FZ(EW12J4)	•	o	GWB3683 GHA232029	K
2.2 16V (120 kW)	2005.10-2008.03 2005.10-2008.03	Saloon Engine 3FY(EW12J4) Saloon Engine 3FY(EW12J4)	•	o	GWB3683 GHA232029	K
2.2 HDi (120 kW)	2008.06- 2008.06-	Saloon Engine 4HP(DW12BTED4) Saloon Engine 4HP(DW12BTED4)	•	o	GWB3683 GHA232029	K
2.2 HDi (125 kW)	2006.06-2008.03 2006.06-2008.03	Saloon Engine 4HT(DW12BTED4) Saloon Engine 4HT(DW12BTED4)	•	o	GWB3683 GHA232029	K
2.7 HDi (150 kW)	2006.04-2008.03 2006.04-2008.03	Saloon Engine UHZ(DT17) Saloon Engine UHZ(DT17)	•	o	GWB3683 GHA232029	K
3.0 (155 kW)	2004.05- 2004.05-	Saloon Engine Xfv(ES9A) Saloon Engine Xfv(ES9A)	•	o	GWB3683 GHA232029	K
407 (6E_)						
1.6 HDi (80 kW)	2004.05- 2004.05-	Estate Engine 9HY(DV6TED4)/9HZ(DV6TED4) Estate Engine 9HY(DV6TED4)/9HZ(DV6TED4)	•	o	GWB3683 GHA232029	K
1.8 (85 kW)	2004.05- 2004.05-	Estate Engine 6FZ(EW7J4) Estate Engine 6FZ(EW7J4)	•	o	GWB3683 GHA232029	K
1.8 16V (92 kW)	2005.10-2007.04 2005.10-2007.04	Estate Engine 6FY(EW7A) Estate Engine 6FY(EW7A)	•	o	GWB3683 GHA232029	K
2.0 (100 kW)	2004.05- 2004.05-	Estate Engine RFN(EW10J4) Estate Engine RFN(EW10J4)	•	o	GWB3683 GHA232029	K
2.0 16V (103 kW)	2005.10-2007.04 2005.10-2007.04	Estate Engine RFJ(EW10A) Estate Engine RFJ(EW10A)	•	o	GWB3683 GHA232029	K
2.0 Bioflex (103 kW)	2008.01- 2008.01-	Estate Engine RFJ(EW10A) Estate Engine RFJ(EW10A)	•	o	GWB3683 GHA232029	K
2.0 HDi (100 kW)	2004.05- 2004.05-	Estate Engine RHR(DW10BTED4) Estate Engine RHR(DW10BTED4)	•	o	GWB3683 GHA232029	K
2.0 HDi (103 kW)	2008.08- 2008.08-	Estate Engine RHR(DW10BTED4) Estate Engine RHR(DW10BTED4)	•	o	GWB3683 GHA232029	K
2.0 HDi (110 kW)	2010.02- 2010.02-	Estate Engine RHE(DW10CTED4) Estate Engine RHE(DW10CTED4)	•	o	GWB3683 GHA232029	K
2.0 HDi (120 kW)	2009.07- 2009.07-	Estate Engine RHH(DW10CTED4) Estate Engine RHH(DW10CTED4)	•	o	GWB3683 GHA232029	K
2.2 (116 kW)	2004.05- 2004.05-	Estate Engine 3FZ(EW12J4) Estate Engine 3FZ(EW12J4)	•	o	GWB3683 GHA232029	K
2.2 16V (120 kW)	2005.10-2008.03 2005.10-2008.03	Estate Engine 3FY(EW12J4) Estate Engine 3FY(EW12J4)	•	o	GWB3683 GHA232029	K
2.2 HDi (120 kW)	2008.06- 2008.06-	Estate Engine 4HP(DW12BTED4) Estate Engine 4HP(DW12BTED4)	•	o	GWB3683 GHA232029	K
2.2 HDi (125 kW)	2006.06-2008.03 2006.06-2008.03	Estate Engine 4HT(DW12BTED4) Estate Engine 4HT(DW12BTED4)	•	o	GWB3683 GHA232029	K
2.7 HDi (150 kW)	2006.04-2008.03	Estate Engine UHZ(DT17)	•		GWB3683	



	 YEAR		F	R	G-AP Ref.	KIT
PEUGEOT						
407 (6E_)						
2.7 HDi (150 kW)	2006.04-2008.03	Estate Engine UHZ(DT17)		o	GHA232029	K
3.0 (155 kW)	2004.05-	Estate Engine Xfv(ES9A)	•		GWB3683	
	2004.05-	Estate Engine Xfv(ES9A)		o	GHA232029	K
408						
1.6 16V (80 kW)	2010.02-	Saloon	•		GWB3584	
2.0 16V (108 kW)	2010.02-	Saloon	•		GWB3584	
5008						
1.6 (120 kW)	2012.02-	MPV	•		GWB3584	
	2012.02-	MPV		o	GWB6549	
1.6 16V (115 kW)	2009.09-	MPV Engine EP6CDT	•		GHA425022	
	2009.09-	MPV Engine EP6CDT	•		GWB3584	
	2009.09-	MPV Engine EP6CDT		o	GWB6549	
1.6 16V (88 kW)	2009.09-	MPV Engine EP6/5FS(EP6C)	•		GHA425022	
	2009.09-	MPV Engine EP6/5FS(EP6C)	•		GWB3584	
	2009.09-	MPV Engine EP6/5FS(EP6C)		o	GWB6549	
1.6 BlueHDi 120 (88 kW)	2014.05-	MPV Engine BHZ (DV6FC)	•		GWB3584	
	2014.05-	MPV Engine BHZ (DV6FC)		o	GWB6549	
1.6 HDi (80 kW)	2009.09-	MPV Engine 9HZ(DV6TED4)	•		GHA425022	
	2009.09-	MPV Engine 9HZ(DV6TED4)	•		GWB3584	
	2009.09-	MPV Engine 9HZ(DV6TED4)		o	GWB6549	
1.6 HDi (82 kW)	2010.08-	MPV Engine 9HR(DV6C)	•		GHA425022	
	2010.08-	MPV Engine 9HR(DV6C)	•		GWB3584	
	2010.08-	MPV Engine 9HR(DV6C)		o	GWB6549	
1.6 HDi (84 kW)	2013.03-	MPV Engine 9HD(DV6CTED)	•		GWB3584	
	2013.03-	MPV Engine 9HD(DV6CTED)		o	GWB6549	
1.6 THP (110 kW)	2012.02-	MPV	•		GHA425022	
	2012.02-	MPV	•		GWB3584	
	2012.02-	MPV		o	GWB6549	
2.0 HDi (100 kW)	2012.02-	MPV Engine AHV (DW10FD)/RHD(DW10CTED4)	•		GHA425022	
	2012.02-	MPV Engine AHV (DW10FD)/RHD(DW10CTED4)	•		GWB3584	
	2012.02-	MPV Engine AHV (DW10FD)/RHD(DW10CTED4)		o	GWB6549	
2.0 HDi (110 kW)	2009.06-	MPV Engine RHE(DW10CTED4)	•		GHA425022	
	2009.06-	MPV Engine RHE(DW10CTED4)	•		GWB3584	
	2009.06-	MPV Engine RHE(DW10CTED4)		o	GWB6549	
2.0 HDi (120 kW)	2009.09-	MPV Engine RHH(DW10CTED4)	•		GHA425022	
	2009.09-	MPV Engine RHH(DW10CTED4)	•		GWB3584	
	2009.09-	MPV Engine RHH(DW10CTED4)		o	GWB6549	
508						
1.6 (120 kW)	2012.01-	Saloon	•		GWB3683	
	2012.01-	Saloon		o	GHA232029	K
	2012.01-	Saloon		o	GHA232031	K
1.6 (121 kW)	2011.09-	Saloon		o	GHA232031	K
1.6 BlueHDi (88 kW)	2014.03-	Saloon Engine BHZ (DV6FC)		o	GHA232031	K
1.6 HDi (82 kW)	2010.11-	Estate Engine 9HR(DV6C)	•		GWB3683	
	2010.11-	Estate Engine 9HR(DV6C)		o	GHA232029	K
	2010.11-	Estate Engine 9HR(DV6C)		o	GHA232031	K
	2010.11-	Saloon Engine 9HR(DV6C)	•		GWB3683	
	2010.11-	Saloon Engine 9HR(DV6C)		o	GHA232029	K
	2010.11-	Saloon Engine 9HR(DV6C)		o	GHA232031	K
1.6 HDi (84 kW)	2012.02-	Estate Engine 9HD(DV6CTED)	•		GWB3683	
	2012.02-	Estate Engine 9HD(DV6CTED)		o	GHA232029	K
	2012.02-	Estate Engine 9HD(DV6CTED)		o	GHA232031	K
	2012.02-	Saloon Engine 9HD(DV6CTED)	•		GWB3683	
	2012.02-	Saloon Engine 9HD(DV6CTED)		o	GHA232029	K
	2012.02-	Saloon Engine 9HD(DV6CTED)		o	GHA232031	K
1.6 THP (110 kW)	2010.11-	Estate Engine 5FX(EP6DT)	•		GWB3683	
	2010.11-	Estate Engine 5FX(EP6DT)		o	GHA232029	K
	2010.11-	Estate Engine 5FX(EP6DT)		o	GHA232031	K
	2010.11-	Saloon	•		GWB3683	
	2010.11-	Saloon		o	GHA232029	K
	2010.11-	Saloon		o	GHA232031	K
1.6 THP (115 kW)	2010.11-	Estate Engine EP6CDT	•		GWB3683	
	2010.11-	Estate Engine EP6CDT		o	GHA232029	K
	2010.11-	Estate Engine EP6CDT		o	GHA232031	K



	 YEAR		F	R	G-AP Ref.	KIT
PEUGEOT						
508						
1.6 THP (115 kW)	2010.11-	Saloon Engine EP6CDT	•		GWB3683	
	2010.11-	Saloon Engine EP6CDT		◦	GHA232029	K
	2010.11-	Saloon Engine EP6CDT		◦	GHA232031	K
1.6 VTi (85 kW)	2010.11-	Estate	•		GWB3683	
	2010.11-	Estate		◦	GHA232029	K
	2010.11-	Estate		◦	GHA232031	K
	2010.11-	Saloon	•		GWB3683	
	2010.11-	Saloon		◦	GHA232029	K
	2010.11-	Saloon		◦	GHA232031	K
1.6 VTi (88 kW)	2010.11-	Estate Engine 5FS(EP6C)	•		GWB3683	
	2010.11-	Estate Engine 5FS(EP6C)		◦	GHA232029	K
	2010.11-	Estate Engine 5FS(EP6C)		◦	GHA232031	K
	2010.11-	Saloon Engine 5FS(EP6C)	•		GWB3683	
	2010.11-	Saloon Engine 5FS(EP6C)		◦	GHA232029	K
	2010.11-	Saloon Engine 5FS(EP6C)		◦	GHA232031	K
2.0 BlueHDi (110 kW)	2014.04-	Estate Engine AHX(DW10FD)	•		GWB3683	
	2014.04-	Estate Engine AHX(DW10FD)		◦	GHA232029	K
	2014.04-	Estate Engine AHX(DW10FD)		◦	GHA232031	K
	2014.04-	Saloon Engine AHX(DW10FD)	•		GWB3683	
	2014.04-	Saloon Engine AHX(DW10FD)		◦	GHA232029	K
	2014.04-	Saloon Engine AHX(DW10FD)		◦	GHA232031	K
2.0 BlueHDi (133 kW)	2014.04-	Saloon Engine AHW(DW10FC)	•		GWB3683	
	2014.04-	Saloon Engine AHW(DW10FC)		◦	GHA232029	K
	2014.04-	Saloon Engine AHW(DW10FC)		◦	GHA232031	K
2.0 HDi (100 kW)	2010.11-	Estate Engine RHR(DW10BTED4)	•		GWB3683	
	2010.11-	Estate Engine RHR(DW10BTED4)		◦	GHA232029	K
	2010.11-	Estate Engine RHR(DW10BTED4)		◦	GHA232031	K
	2010.11-	Saloon Engine RHR(DW10BTED4)	•		GWB3683	
	2010.11-	Saloon Engine RHR(DW10BTED4)		◦	GHA232029	K
	2010.11-	Saloon Engine RHR(DW10BTED4)		◦	GHA232031	K
2.0 HDi (103 kW)	2010.11-	Estate Engine RHF(DW10BTED4)	•		GWB3683	
	2010.11-	Estate Engine RHF(DW10BTED4)		◦	GHA232029	K
	2010.11-	Estate Engine RHF(DW10BTED4)		◦	GHA232031	K
	2010.11-	Saloon Engine RHF(DW10BTED4)	•		GWB3683	
	2010.11-	Saloon Engine RHF(DW10BTED4)		◦	GHA232029	K
	2010.11-	Saloon Engine RHF(DW10BTED4)		◦	GHA232031	K
2.0 HDi (120 kW)	2010.11-	Estate Engine RHH(DW10CTED4)	•		GWB3683	
	2010.11-	Estate Engine RHH(DW10CTED4)		◦	GHA232029	K
	2010.11-	Estate Engine RHH(DW10CTED4)		◦	GHA232031	K
	2010.11-	Saloon Engine RHH(DW10CTED4)	•		GWB3683	
	2010.11-	Saloon Engine RHH(DW10CTED4)		◦	GHA232029	K
	2010.11-	Saloon Engine RHH(DW10CTED4)		◦	GHA232031	K
2.0 HDi HybrID4 (147 kW)	2010.11-	Saloon	•		GWB3683	
	2010.11-	Saloon		◦	GHA232029	K
2.0 HDi HybrID4 AWC (120 kW)	2010.11-	Saloon Engine RHC(DW10CTED4)	•		GWB3683	
	2010.11-	Saloon Engine RHC(DW10CTED4)		◦	GHA232029	K
2.2 HDi (150 kW)	2010.11-	Estate Engine 4HL(DW12C)	•		GWB3683	
	2010.11-	Estate Engine 4HL(DW12C)		◦	GHA232029	K
	2010.11-	Saloon Engine 4HL(DW12C)	•		GWB3683	
	2010.11-	Saloon Engine 4HL(DW12C)		◦	GHA232029	K
508 SW						
1.6 (121 kW)	2012.02-	Estate		◦	GHA232031	K
1.6 BlueHDi (88 kW)	2014.03-	Estate Engine BHZ (DV6FC)		◦	GHA232031	K
2.0 BlueHDi 180 (133 kW)	2014.04-	Estate Engine AHW (DW10FC)	•		GWB3683	
	2014.04-	Estate Engine AHW (DW10FC)		◦	GHA232029	K
	2014.04-	Estate Engine AHW (DW10FC)		◦	GHA232031	K
2.0 HDi 180 RXH (133 kW)	2014.10-	Estate	•		GWB3683	
	2014.10-	Estate		◦	GHA232029	K
2.0 HDi RXH HybrID4 (120 kW)	2010.11-	Estate Engine RHC (DW10CTED4)	•		GWB3683	
	2010.11-	Estate Engine RHC (DW10CTED4)		◦	GHA232029	K
605 (6B)						
2.0 (79 kW)	1990.02-1999.09	Saloon	•		GWB3490	
	1990.02-1999.09	Saloon		◦	GHA232001	K
	1990.02-1999.09	Saloon		◦	GHA232039	K



	 YEAR		F	R	G-AP Ref.	KIT
PEUGEOT						
605 (6B)						
2.0 (79 kW)	1990.02-1999.09	Saloon			GWB1412	
2.0 16V (97 kW)	1994.07-1999.09	Saloon Engine RFV(XU10J4R)	•		GWB3490	
	1994.07-1999.09	Saloon Engine RFV(XU10J4R)		◦	GHA232001	K
	1994.07-1999.09	Saloon Engine RFV(XU10J4R)			GWB1412	
2.0 Turbo (104 kW)	1992.07-1999.09	Saloon Engine RGY(XU10J2TE)	•		GWB3490	
	1992.07-1999.09	Saloon Engine RGY(XU10J2TE)		◦	GHA232001	K
	1992.07-1999.09	Saloon Engine RGY(XU10J2TE)			GWB1412	
2.0 Turbo (108 kW)	1991.07-1999.09	Saloon Engine RGX(XU10J2TE)	•		GWB3490	
	1991.07-1999.09	Saloon Engine RGX(XU10J2TE)		◦	GHA232001	K
	1991.07-1999.09	Saloon Engine RGX(XU10J2TE)			GWB1412	
2.1 TD 12V (80 kW)	1994.08-1999.09	Saloon Engine P8C(XUD11BTE)	•		GWB3490	
	1994.08-1999.09	Saloon Engine P8C(XUD11BTE)		◦	GHA232001	K
	1994.08-1999.09	Saloon Engine P8C(XUD11BTE)			GWB1412	
2.5 Turbo Diesel (95 kW)	1994.07-1999.09	Saloon Engine THY(DK5ATE)	•		GWB3490	
	1994.07-1999.09	Saloon Engine THY(DK5ATE)		◦	GHA232001	K
	1994.07-1999.09	Saloon Engine THY(DK5ATE)			GWB1412	
3.0 V6 (140 kW)	1997.04-1999.09	Saloon Engine XFZ(ES9J4)	•		GWB3490	
	1997.04-1999.09	Saloon Engine XFZ(ES9J4)		◦	GHA232001	K
	1997.04-1999.09	Saloon Engine XFZ(ES9J4)			GWB1412	
607 (9D, 9U)						
2.0 (100 kW)	2001.04-2004.11	Saloon Engine RFN(EW10J4)	•		GWB3490	
	2001.04-2004.11	Saloon Engine RFN(EW10J4)	•		GWB3683	
	2001.04-2004.11	Saloon Engine RFN(EW10J4)		◦	GHA232029	K
	2001.04-2004.11	Saloon Engine RFN(EW10J4)		◦	GHA232034	K
2.0 HDi (100 kW)	2000.10-2005.10	Saloon Engine RHR(DW10BTED4)	•		GWB3683	
	2000.10-2005.10	Saloon Engine RHR(DW10BTED4)		◦	GHA232029	K
2.0 HDi (79 kW)	2001.03-2004.07	Saloon Engine RHS(DW10ATED)	•		GWB3490	
	2001.03-2004.07	Saloon Engine RHS(DW10ATED)		◦	GHA232034	K
2.0 HDi (80 kW)	2001.04-2005.10	Saloon Engine RHZ(DW10ATED)	•		GWB3490	
	2001.04-2005.10	Saloon Engine RHZ(DW10ATED)	•		GWB3683	
	2001.04-2005.10	Saloon Engine RHZ(DW10ATED)		◦	GHA232029	K
	2001.04-2005.10	Saloon Engine RHZ(DW10ATED)		◦	GHA232034	K
2.2 16V (116 kW)	2000.02-	Saloon Engine 3FZ(EW12J4)	•		GWB3490	
	2000.02-	Saloon Engine 3FZ(EW12J4)	•		GWB3683	
	2000.02-	Saloon Engine 3FZ(EW12J4)		◦	GHA232029	K
	2000.02-	Saloon Engine 3FZ(EW12J4)		◦	GHA232034	K
2.2 16V (120 kW)	2005.09-	Saloon Engine 3FY(EW12J4)	•		GWB3683	
	2005.09-	Saloon Engine 3FY(EW12J4)		◦	GHA232029	K
2.2 HDi (125 kW)	2006.05-	Saloon Engine 4HT(DW12BTED4)	•		GWB3683	
	2006.05-	Saloon Engine 4HT(DW12BTED4)		◦	GHA232029	K
2.2 HDi (98 kW)	2000.02-	Saloon Engine 4HX(DW12TED4/FAP)	•		GWB3490	
	2000.02-	Saloon Engine 4HX(DW12TED4/FAP)	•		GWB3683	
	2000.02-	Saloon Engine 4HX(DW12TED4/FAP)		◦	GHA232029	K
	2000.02-	Saloon Engine 4HX(DW12TED4/FAP)		◦	GHA232034	K
2.7 HDi 24V (150 kW)	2004.12-	Saloon Engine DT17TED4	•		GWB3683	
	2004.12-	Saloon Engine DT17TED4		◦	GHA232029	K
3.0 V6 24V (152 kW)	2000.02-	Saloon Engine XFX(ES9J4S)	•		GWB3490	
	2000.02-	Saloon Engine XFX(ES9J4S)	•		GWB3683	
	2000.02-	Saloon Engine XFX(ES9J4S)		◦	GHA232029	K
	2000.02-	Saloon Engine XFX(ES9J4S)		◦	GHA232034	K
3.0 V6 24V (155 kW)	2005.10-	Saloon Engine XFV(ES9A)	•		GWB3683	
	2005.10-	Saloon Engine XFV(ES9A)		◦	GHA232029	K
806 (221)						
1.8 (73 kW)	1995.07-2002.08	MPV Engine LFW(XU7JP)	•		GWB3423	
	1995.07-2002.08	MPV Engine LFW(XU7JP)		◦	GHA230111	K
1.9 TD (66 kW)	1995.07-2002.08	MPV Engine DHX(XUD9TE)	•		GWB3423	
	1995.07-2002.08	MPV Engine DHX(XUD9TE)		◦	GHA230111	K
1.9 TD (68 kW)	1997.05-2002.08	MPV Engine DHY(XUD9TE)	•		GWB3423	
	1997.05-2002.08	MPV Engine DHY(XUD9TE)		◦	GHA230111	K
2.0 (89 kW)	1994.06-2002.08	MPV Engine RFU(XU10J2)	•		GWB3423	
	1994.06-2002.08	MPV Engine RFU(XU10J2)		◦	GHA230111	K
2.0 16V (100 kW)	2000.09-2002.08	MPV Engine RFN(EW10J4)	•		GWB3423	
	2000.09-2002.08	MPV Engine RFN(EW10J4)		◦	GHA230111	K
2.0 16V (97 kW)	1998.05-2000.09	MPV Engine RFV(XU10J4R)	•		GWB3423	



	 YEAR		F	R	G-AP Ref.	KIT
PEUGEOT						
806 (221)						
2.0 16V (97 kW)	1998.05-2000.09	MPV Engine RFV(XU10J4R)		o	GHA230111	K
2.0 HDi (80 kW)	1999.08-2002.08	MPV Engine RHZ(DW10ATED)	•		GWB3423	
	1999.08-2002.08	MPV Engine RHZ(DW10ATED)		o	GHA230111	K
2.0 HDi 16V (80 kW)	1999.08-2002.05	MPV Engine RHW(DW10ATED4)	•		GWB3423	
	1999.08-2002.05	MPV Engine RHW(DW10ATED4)		o	GHA230111	K
2.0 Turbo (108 kW)	1994.06-2002.08	MPV Engine RGX(XU10J2TE)	•		GWB3423	
	1994.06-2002.08	MPV Engine RGX(XU10J2TE)		o	GHA230111	K
2.1 TD 12V (80 kW)	1996.06-1999.08	MPV Engine P8C(XUD11BTE)	•		GWB3423	
	1996.06-1999.08	MPV Engine P8C(XUD11BTE)		o	GHA230111	K
807 (E)						
2.0 (100 kW)	2002.06-	MPV Engine RFN(EW10J4)	•		GWB3633	
	2002.06-	MPV Engine RFN(EW10J4)		o	GHA230121	K
2.0 16V (103 kW)	2005.10-	MPV Engine RFJ(EW10A)	•		GWB3633	
	2005.10-	MPV Engine RFJ(EW10A)		o	GHA230121	K
2.0 HDi (100 kW)	2006.07-	MPV Engine RHR(DW10BTED4)	•		GWB3633	
	2006.07-	MPV Engine RHR(DW10BTED4)		o	GHA230121	K
2.0 HDi (120 kW)	2009.06-	MPV Engine RHH(DW10CTED4)		o	GHA230121	K
2.0 HDi (79 kW)	2002.06-	MPV Engine RHM(DW10ATED4)/RHT(DW10ATED4)/RHW(DW10ATED4)	•		GWB3633	
	2002.06-	MPV Engine RHM(DW10ATED4)/RHT(DW10ATED4)/RHW(DW10ATED4)		o	GHA230121	K
2.0 HDi (80 kW)	2004.04-2006.05	MPV Engine RHW(DW10ATED4)	•		GWB3633	
	2004.04-2006.05	MPV Engine RHW(DW10ATED4)		o	GHA230121	K
2.0 HDi (88 kW)	2006.02-	MPV Engine RHK(DW10UTED4)	•		GWB3633	
	2006.02-	MPV Engine RHK(DW10UTED4)		o	GHA230121	K
2.2 (116 kW)	2002.06-	MPV Engine 3FZ(EW12J4)	•		GWB3633	
	2002.06-	MPV Engine 3FZ(EW12J4)		o	GHA230121	K
2.2 HDi (120 kW)	2006.06-	MPV Engine 4HT(DW12BTED4)	•		GWB3633	
	2006.06-	MPV Engine 4HT(DW12BTED4)		o	GHA230121	K
2.2 HDi (125 kW)	2006.06-	MPV Engine 4HT(DW12BTED4)		o	GHA230121	K
2.2 HDi (94 kW)	2002.06-	MPV Engine 4HX(DW12TED4/FAP)	•		GWB3633	
	2002.06-	MPV Engine 4HX(DW12TED4/FAP)		o	GHA230121	K
3.0 V6 (150 kW)	2002.06-	MPV Engine XFX(ES9J4S)	•		GWB3649	
	2002.06-	MPV Engine XFX(ES9J4S)		o	GHA230121	K
BIPPER (AA_)						
1.3 HDi (55 kW)	2010.10-	Box Engine 199A9.000	•		GWB3539	
	2010.10-	Box Engine 199A9.000	•		GWB6540	
	2010.10-	Box Engine 199A9.000 With ABS		o	GHA230046	K
1.4 (54 kW)	2008.02-	Box Engine KFV(TU3A)	•		GWB3538	
	2008.02-	Box Engine KFV(TU3A) With ABS		o	GHA230046	K
1.4 HDi (50 kW)	2008.02-	Box Engine 8HS(DV4TD)	•		GWB3539	
	2008.02-	Box Engine 8HS(DV4TD)	•		GWB6540	
	2008.02-	Box Engine 8HS(DV4TD) With ABS		o	GHA230046	K
BIPPER TEPEE						
1.3 HDi (55 kW)	2010.10-	Estate Engine 199A9.000	•		GWB3539	
	2010.10-	Estate Engine 199A9.000	•		GWB6540	
	2010.10-	Estate Engine 199A9.000 With ABS		o	GHA230046	K
1.4 (54 kW)	2008.04-	Estate Engine KFV(TU3A)	•		GWB3538	
	2008.04-	Estate Engine KFV(TU3A) With ABS		o	GHA230046	K
1.4 HDi (50 kW)	2008.04-	Estate Engine 8HS(DV4TD)	•		GWB3539	
	2008.04-	Estate Engine 8HS(DV4TD)	•		GWB6540	
	2008.04-	Estate Engine 8HS(DV4TD) With ABS		o	GHA230046	K
BOXER						
2.2 HDi (110 kW)	2011.03-	Box	•		GWB6570	
	2011.03-	Box		o	GHA242007	K
	2011.03-	Box		o	GHA242008	K
	2011.03-	Bus	•		GWB6570	
	2011.03-	Bus		o	GHA242007	K
	2011.03-	Bus		o	GHA242008	K
	2011.03-	Platform/Chassis	•		GWB6570	
	2011.03-	Platform/Chassis		o	GHA242007	K
	2011.03-	Platform/Chassis		o	GHA242008	K
2.2 HDi (74 kW)	2006.04-	Box Engine 4HV(P22DTE)	•		GWB6570	
	2006.04-	Box Engine 4HV(P22DTE)		o	GHA242007	K
	2006.04-	Box Engine 4HV(P22DTE)		o	GHA242008	K
	2006.04-	Bus Engine 4HV(P22DTE)	•		GWB6570	



	 YEAR		F	R	G-AP Ref.	KIT
PEUGEOT BOXER						
2.2 HDi (74 kW)	2006.04-	Bus Engine 4HV(P22DTE)		o	GHA242007	K
	2006.04-	Bus Engine 4HV(P22DTE)		o	GHA242008	K
	2006.04-	Platform/Chassis Engine 4HV(P22DTE)	•		GWB6570	
	2006.04-	Platform/Chassis Engine 4HV(P22DTE)		o	GHA242007	K
	2006.04-	Platform/Chassis Engine 4HV(P22DTE)		o	GHA242008	K
2.2 HDi (81 kW)	2011.03-	Box	•		GWB6570	
	2011.03-	Box		o	GHA242007	K
	2011.03-	Box		o	GHA242008	K
	2011.03-	Bus	•		GWB6570	
	2011.03-	Bus		o	GHA242007	K
	2011.03-	Bus		o	GHA242008	K
	2011.03-	Platform/Chassis	•		GWB6570	
	2011.03-	Platform/Chassis		o	GHA242007	K
2.2 HDi (88 kW)	2006.04-	Box Engine 4HU(P22DTE)	•		GWB6570	
	2006.04-	Box Engine 4HU(P22DTE)		o	GHA242007	K
	2006.04-	Box Engine 4HU(P22DTE)		o	GHA242008	K
	2006.04-	Bus Engine 4HU(P22DTE)	•		GWB6570	
	2006.04-	Bus Engine 4HU(P22DTE)		o	GHA242007	K
	2006.04-	Bus Engine 4HU(P22DTE)		o	GHA242008	K
	2006.04-	Platform/Chassis Engine 4HU(P22DTE)	•		GWB6570	
	2006.04-	Platform/Chassis Engine 4HU(P22DTE)		o	GHA242007	K
2.2 HDi (96 kW)	2011.03-	Box	•		GWB6570	
	2011.03-	Box		o	GHA242007	K
	2011.03-	Box		o	GHA242008	K
	2011.03-	Bus	•		GWB6570	
	2011.03-	Bus		o	GHA242007	K
	2011.03-	Bus		o	GHA242008	K
	2011.03-	Platform/Chassis	•		GWB6570	
3.0 HDi (107 kW)	2010.04-	Box	•		GWB6570	
	2010.04-	Box		o	GHA242007	K
	2010.04-	Box		o	GHA242008	K
	2010.04-	Bus	•		GWB6570	
	2010.04-	Bus		o	GHA242007	K
	2010.04-	Bus		o	GHA242008	K
	2010.04-	Platform/Chassis Engine 33276	•		GWB6570	
	2010.04-	Platform/Chassis Engine 33276		o	GHA242007	K
3.0 HDi (115 kW)	2006.07-	Box	•		GWB6570	
	2006.07-	Box		o	GHA242007	K
	2006.07-	Box		o	GHA242008	K
	2007.02-	Platform/Chassis	•		GWB6570	
	2007.02-	Platform/Chassis		o	GHA242007	K
3.0 HDi (116 kW)	2006.04-	Box Engine F1CE0481D(F30DT)	•		GWB6570	
	2006.04-	Box Engine F1CE0481D(F30DT)		o	GHA242007	K
	2006.04-	Box Engine F1CE0481D(F30DT)		o	GHA242008	K
	2006.04-	Bus Engine F1CE0481D(F30DT)	•		GWB6570	
	2006.04-	Bus Engine F1CE0481D(F30DT)		o	GHA242007	K
	2006.04-	Bus Engine F1CE0481D(F30DT)		o	GHA242008	K
	2006.04-	Platform/Chassis Engine F1CE0481D(F30DT)	•		GWB6570	
	2006.04-	Platform/Chassis Engine F1CE0481D(F30DT)		o	GHA242007	K
3.0 HDi (130 kW)	2011.03-	Box	•		GWB6570	
	2011.03-	Box		o	GHA242007	K
	2011.03-	Box		o	GHA242008	K
	2011.03-	Bus	•		GWB6570	
	2011.03-	Bus		o	GHA242007	K
	2011.03-	Bus		o	GHA242008	K
	2011.03-	Platform/Chassis	•		GWB6570	
2011.03-	Platform/Chassis		o	GHA242007	K	



	 YEAR		F	R	G-AP Ref.	KIT
PEUGEOT						
BOXER						
3.0 HDi (130 kW)	2011.03-	Platform/Chassis		o	GHA242008	K
BOXER (ZCT_)						
2.8 HDi All-wheel Drive (93 kW)	2000.10-2001.11	Platform/Chassis Engine 8140.43S (F28DTCR)	•		GHA428004	
	2000.10-2001.11	Platform/Chassis Engine 8140.43S (F28DTCR)	•		GHA428006	
	2000.10-2001.11	Platform/Chassis Engine 8140.43S (F28DTCR)	•		GHA435002	
BOXER (230L)						
1.9 D (50 kW)	1999.07-2002.04	Box Engine DJY(XUD9A)	•		GHA428004	
	1999.07-2002.04	Box Engine DJY(XUD9A)	•		GHA428006	
	1999.07-2002.04	Box Engine DJY(XUD9A)	•		GHA435001	
	1999.07-2002.04	Box Engine DJY(XUD9A)	•		GHA435002	
	1999.07-2002.04	Box Engine DJY(XUD9A)	•		GWB1444	
	1999.07-2002.04	Box Engine DJY(XUD9A)	•		GWB3428	
	1999.07-2002.04	Box Engine DJY(XUD9A)	•		GWB3640	
	1999.07-2002.04	Box Engine DJY(XUD9A)	•		GWB3641	
	1999.07-2002.04	Box Engine DJY(XUD9A)		o	GWB3429	
	1999.07-2002.04	Box Engine DJY(XUD9A)		o	GWB3430	
	1999.07-2002.04	Box Engine DJY(XUD9A)		o	GWB3642	
1.9 D (51 kW)	1994.03-2002.04	Box Engine D9B(XUD9AU)	•		GHA428004	
	1994.03-2002.04	Box Engine D9B(XUD9AU)	•		GHA428006	
	1994.03-2002.04	Box Engine D9B(XUD9AU)	•		GHA435001	
	1994.03-2002.04	Box Engine D9B(XUD9AU)	•		GHA435002	
	1994.03-2002.04	Box Engine D9B(XUD9AU)	•		GWB1444	
	1994.03-2002.04	Box Engine D9B(XUD9AU)	•		GWB3428	
	1994.03-2002.04	Box Engine D9B(XUD9AU)	•		GWB3640	
	1994.03-2002.04	Box Engine D9B(XUD9AU)	•		GWB3641	
	1994.03-2002.04	Box Engine D9B(XUD9AU)		o	GWB3429	
	1994.03-2002.04	Box Engine D9B(XUD9AU)		o	GWB3430	
	1994.03-2002.04	Box Engine D9B(XUD9AU)		o	GWB3642	
1.9 DT 4x4 (66 kW)	1996.03-1998.09	Box Engine XUD9TE	•		GHA428004	
	1996.03-1998.09	Box Engine XUD9TE	•		GHA428006	
	1996.03-1998.09	Box Engine XUD9TE	•		GHA435002	
	1996.03-1998.09	Box Engine XUD9TE	•		GWB1444	
	1996.03-1998.09	Box Engine XUD9TE	•		GWB3428	
	1996.03-1998.09	Box Engine XUD9TE	•		GWB3640	
	1996.03-1998.09	Box Engine XUD9TE	•		GWB3641	
	1996.03-1998.09	Box Engine XUD9TE		o	GWB3679	
1.9 TD (66 kW)	1999.07-2002.04	Box Engine XUD9TE	•		GHA428004	
	1999.07-2002.04	Box Engine XUD9TE	•		GHA428006	
	1999.07-2002.04	Box Engine XUD9TE	•		GHA435001	
	1999.07-2002.04	Box Engine XUD9TE	•		GHA435002	
	1999.07-2002.04	Box Engine XUD9TE	•		GWB1444	
	1999.07-2002.04	Box Engine XUD9TE	•		GWB3428	
	1999.07-2002.04	Box Engine XUD9TE	•		GWB3640	
	1999.07-2002.04	Box Engine XUD9TE	•		GWB3641	
	1999.07-2002.04	Box Engine XUD9TE		o	GWB3429	
	1999.07-2002.04	Box Engine XUD9TE		o	GWB3430	
	1999.07-2002.04	Box Engine XUD9TE		o	GWB3642	
1.9 TD (68 kW)	1994.03-2002.04	Box Engine D8C(XUD9UTF)	•		GHA428004	
	1994.03-2002.04	Box Engine D8C(XUD9UTF)	•		GHA428006	
	1994.03-2002.04	Box Engine D8C(XUD9UTF)	•		GHA435001	
	1994.03-2002.04	Box Engine D8C(XUD9UTF)	•		GHA435002	
	1994.03-2002.04	Box Engine D8C(XUD9UTF)	•		GWB1444	
	1994.03-2002.04	Box Engine D8C(XUD9UTF)	•		GWB3428	
	1994.03-2002.04	Box Engine D8C(XUD9UTF)	•		GWB3640	
	1994.03-2002.04	Box Engine D8C(XUD9UTF)	•		GWB3641	
	1994.03-2002.04	Box Engine D8C(XUD9UTF)		o	GWB3429	
	1994.03-2002.04	Box Engine D8C(XUD9UTF)		o	GWB3430	
	1994.03-2002.04	Box Engine D8C(XUD9UTF)		o	GWB3642	
2.0 4x4 (80 kW)	1996.03-1998.09	Box	•		GHA428004	
	1996.03-1998.09	Box	•		GHA428006	
	1996.03-1998.09	Box	•		GHA435002	
2.0 HDi (62 kW)	2001.08-2002.04	Box Engine RHV(DW10UTD)	•		GHA428004	
	2001.08-2002.04	Box Engine RHV(DW10UTD)	•		GHA428006	
	2001.08-2002.04	Box Engine RHV(DW10UTD)	•		GHA435001	



	 YEAR		F	R	G-AP Ref.	KIT
PEUGEOT						
BOXER (230L)						
2.0 HDi (62 kW)	2001.08-2002.04	Box Engine RHV(DW10UTD)	•		GHA435002	
	2001.08-2002.04	Box Engine RHV(DW10UTD)	•		GWB1444	
	2001.08-2002.04	Box Engine RHV(DW10UTD)	•		GWB3428	
	2001.08-2002.04	Box Engine RHV(DW10UTD)	•		GWB3640	
	2001.08-2002.04	Box Engine RHV(DW10UTD)	•		GWB3641	
	2001.08-2002.04	Box Engine RHV(DW10UTD)		○	GWB3429	
	2001.08-2002.04	Box Engine RHV(DW10UTD)		○	GWB3430	
	2001.08-2002.04	Box Engine RHV(DW10UTD)		○	GWB3642	
2.0 i (80 kW)	1994.06-2002.04	Box Engine RFW(XU10J2)	•		GHA428004	
	1994.06-2002.04	Box Engine RFW(XU10J2)	•		GHA428006	
	1994.06-2002.04	Box Engine RFW(XU10J2)	•		GHA435002	
	1994.06-2002.04	Box Engine RFW(XU10J2)	•		GWB1444	
	1994.06-2002.04	Box Engine RFW(XU10J2)	•		GWB3428	
	1994.06-2002.04	Box Engine RFW(XU10J2)	•		GWB3640	
	1994.06-2002.04	Box Engine RFW(XU10J2)	•		GWB3641	
	1994.06-2002.04	Box Engine RFW(XU10J2)		○	GWB3429	
	1994.06-2002.04	Box Engine RFW(XU10J2)		○	GWB3430	
	1994.06-2002.04	Box Engine RFW(XU10J2)		○	GWB3642	
2.5 D (63 kW)	1994.03-2002.04	Box Engine T9A(DJ5)	•		GHA428004	
	1994.03-2002.04	Box Engine T9A(DJ5)	•		GHA428006	
	1994.03-2002.04	Box Engine T9A(DJ5)	•		GHA435001	
	1994.03-2002.04	Box Engine T9A(DJ5)	•		GHA435002	
	1994.03-2002.04	Box Engine T9A(DJ5)	•		GWB1444	
	1994.03-2002.04	Box Engine T9A(DJ5)	•		GWB3428	
	1994.03-2002.04	Box Engine T9A(DJ5)	•		GWB3640	
	1994.03-2002.04	Box Engine T9A(DJ5)	•		GWB3641	
	1994.03-2002.04	Box Engine T9A(DJ5)		○	GWB3429	
	1994.03-2002.04	Box Engine T9A(DJ5)		○	GWB3430	
	1994.03-2002.04	Box Engine T9A(DJ5)		○	GWB3642	
2.5 D 4x4 (63 kW)	1999.07-2002.04	Box Engine T9A(DJ5)	•		GHA428004	
	1999.07-2002.04	Box Engine T9A(DJ5)	•		GHA428006	
	1999.07-2002.04	Box Engine T9A(DJ5)	•		GHA435001	
	1999.07-2002.04	Box Engine T9A(DJ5)	•		GHA435002	
	1999.07-2002.04	Box Engine T9A(DJ5)	•		GWB1444	
	1999.07-2002.04	Box Engine T9A(DJ5)	•		GWB3428	
	1999.07-2002.04	Box Engine T9A(DJ5)	•		GWB3640	
	1999.07-2002.04	Box Engine T9A(DJ5)	•		GWB3641	
	1999.07-2002.04	Box Engine T9A(DJ5)		○	GWB3679	
2.5 DT (62 kW)	1997.10-2001.11	Box	•		GHA428004	
	1997.10-2001.11	Box	•		GHA428006	
	1997.10-2001.11	Box	•		GHA435002	
	1997.10-2001.11	Box	•		GWB1444	
	1997.10-2001.11	Box	•		GWB3428	
	1997.10-2001.11	Box	•		GWB3640	
	1997.10-2001.11	Box	•		GWB3641	
	1997.10-2001.11	Box		○	GWB3429	
	1997.10-2001.11	Box		○	GWB3430	
	1997.10-2001.11	Box		○	GWB3642	
2.5 TD (76 kW)	1994.03-2002.04	Box Engine T8A(DJ5T)	•		GHA428004	
	1994.03-2002.04	Box Engine T8A(DJ5T)	•		GHA428006	
	1994.03-2002.04	Box Engine T8A(DJ5T)	•		GHA435001	
	1994.03-2002.04	Box Engine T8A(DJ5T)	•		GHA435002	
	1994.03-2002.04	Box Engine T8A(DJ5T)	•		GWB1444	
	1994.03-2002.04	Box Engine T8A(DJ5T)	•		GWB3428	
	1994.03-2002.04	Box Engine T8A(DJ5T)	•		GWB3640	
	1994.03-2002.04	Box Engine T8A(DJ5T)	•		GWB3641	
	1994.03-2002.04	Box Engine T8A(DJ5T)		○	GWB3429	
	1994.03-2002.04	Box Engine T8A(DJ5T)		○	GWB3430	
	1994.03-2002.04	Box Engine T8A(DJ5T)		○	GWB3642	
	2.5 TDi (79 kW)	1997.01-2002.04	Box Engine THX(DJ5TED)	•		GHA428004
1997.01-2002.04		Box Engine THX(DJ5TED)	•		GHA428006	
1997.01-2002.04		Box Engine THX(DJ5TED)	•		GHA435001	
1997.01-2002.04		Box Engine THX(DJ5TED)	•		GHA435002	
1997.01-2002.04		Box Engine THX(DJ5TED)	•		GWB1444	



	 YEAR		F	R	G-AP Ref.	KIT
PEUGEOT						
BOXER (230L)						
2.5 TDi (79 kW)	1997.01-2002.04	Box Engine THX(DJ5TED)	•		GWB3428	
	1997.01-2002.04	Box Engine THX(DJ5TED)	•		GWB3640	
	1997.01-2002.04	Box Engine THX(DJ5TED)	•		GWB3641	
	1997.01-2002.04	Box Engine THX(DJ5TED)		○	GWB3429	
	1997.01-2002.04	Box Engine THX(DJ5TED)		○	GWB3430	
	1997.01-2002.04	Box Engine THX(DJ5TED)		○	GWB3642	
	2.5 TDi 4x4 (79 kW)	1999.07-2002.04	Box Engine THX(DJ5TED)	•		GHA428004
1999.07-2002.04		Box Engine THX(DJ5TED)	•		GHA428006	
1999.07-2002.04		Box Engine THX(DJ5TED)	•		GHA435001	
1999.07-2002.04		Box Engine THX(DJ5TED)	•		GHA435002	
1999.07-2002.04		Box Engine THX(DJ5TED)	•		GWB1444	
1999.07-2002.04		Box Engine THX(DJ5TED)	•		GWB3428	
1999.07-2002.04		Box Engine THX(DJ5TED)	•		GWB3640	
1999.07-2002.04		Box Engine THX(DJ5TED)	•	○	GWB3641	
2.8 D (64 kW)	1999.01-2002.02	Box Engine 8140.63(F28D)	•		GHA428004	
	1999.01-2002.02	Box Engine 8140.63(F28D)	•		GHA428006	
	1999.01-2002.02	Box Engine 8140.63(F28D)	•		GHA435002	
	1999.01-2002.02	Box Engine 8140.63(F28D)	•		GWB1444	
	1999.01-2002.02	Box Engine 8140.63(F28D)	•		GWB3428	
	1999.01-2002.02	Box Engine 8140.63(F28D)	•		GWB3640	
	1999.01-2002.02	Box Engine 8140.63(F28D)	•		GWB3641	
	1999.01-2002.02	Box Engine 8140.63(F28D)		○	GWB3429	
	1999.01-2002.02	Box Engine 8140.63(F28D)		○	GWB3430	
	1999.01-2002.02	Box Engine 8140.63(F28D)		○	GWB3642	
2.8 HDi (93 kW)	2000.10-2001.11	Box Engine 8140.43S(F28DTCR)	•		GHA428004	
	2000.10-2001.11	Box Engine 8140.43S(F28DTCR)	•		GHA428006	
	2000.10-2001.11	Box Engine 8140.43S(F28DTCR)	•		GHA435002	
	2000.10-2001.11	Box Engine 8140.43S(F28DTCR)	•		GWB1444	
	2000.10-2001.11	Box Engine 8140.43S(F28DTCR)	•		GWB3428	
	2000.10-2001.11	Box Engine 8140.43S(F28DTCR)	•		GWB3640	
	2000.10-2001.11	Box Engine 8140.43S(F28DTCR)	•		GWB3641	
	2000.10-2001.11	Box Engine 8140.43S(F28DTCR)		○	GWB3429	
	2000.10-2001.11	Box Engine 8140.43S(F28DTCR)		○	GWB3430	
	2000.10-2001.11	Box Engine 8140.43S(F28DTCR)		○	GWB3642	
2.8 HDi (94 kW)	2000.11-2002.04	Box Engine 8140.43S(F28DTCR)	•		GHA428004	
	2000.11-2002.04	Box Engine 8140.43S(F28DTCR)	•		GHA428006	
	2000.11-2002.04	Box Engine 8140.43S(F28DTCR)	•		GHA435001	
	2000.11-2002.04	Box Engine 8140.43S(F28DTCR)	•		GHA435002	
	2000.11-2002.04	Box Engine 8140.43S(F28DTCR)	•		GWB1444	
	2000.11-2002.04	Box Engine 8140.43S(F28DTCR)	•		GWB3428	
	2000.11-2002.04	Box Engine 8140.43S(F28DTCR)	•		GWB3640	
	2000.11-2002.04	Box Engine 8140.43S(F28DTCR)	•		GWB3641	
	2000.11-2002.04	Box Engine 8140.43S(F28DTCR)		○	GWB3429	
	2000.11-2002.04	Box Engine 8140.43S(F28DTCR)		○	GWB3430	
2.8 HDi 4x4 (93 kW)	2000.10-2001.11	Box Engine 8140.43S (F28DTCR)	•		GHA428004	
	2000.10-2001.11	Box Engine 8140.43S (F28DTCR)	•		GHA428006	
	2000.10-2001.11	Box Engine 8140.43S (F28DTCR)	•		GHA435002	
	2000.10-2001.11	Box Engine 8140.43S (F28DTCR)	•		GWB1444	
	2000.10-2001.11	Box Engine 8140.43S (F28DTCR)	•		GWB3428	
	2000.10-2001.11	Box Engine 8140.43S (F28DTCR)	•		GWB3640	
	2000.10-2001.11	Box Engine 8140.43S (F28DTCR)	•		GWB3641	
	2000.10-2001.11	Box Engine 8140.43S (F28DTCR)		○	GWB3679	
2.8 HDi 4x4 (94 kW)	2000.10-2002.04	Box Engine 8140.43S(F28DTCR)	•		GHA428004	
	2000.10-2002.04	Box Engine 8140.43S(F28DTCR)	•		GHA428006	
	2000.10-2002.04	Box Engine 8140.43S(F28DTCR)	•		GHA435002	
	2000.10-2002.04	Box Engine 8140.43S(F28DTCR)	•		GWB1444	
	2000.10-2002.04	Box Engine 8140.43S(F28DTCR)	•		GWB3428	
	2000.10-2002.04	Box Engine 8140.43S(F28DTCR)	•		GWB3640	
	2000.10-2002.04	Box Engine 8140.43S(F28DTCR)	•		GWB3641	
	2000.10-2002.04	Box Engine 8140.43S(F28DTCR)		○	GWB3679	



	 YEAR		F	R	G-AP Ref.	KIT
PEUGEOT						
BOXER (230P)						
1.9 D (51 kW)	1994.03-2002.04	Bus Engine D9B(XUD9AU)	•		GHA428004	
	1994.03-2002.04	Bus Engine D9B(XUD9AU)	•		GHA428006	
	1994.03-2002.04	Bus Engine D9B(XUD9AU)	•		GHA435001	
	1994.03-2002.04	Bus Engine D9B(XUD9AU)	•		GHA435002	
	1994.03-2002.04	Bus Engine D9B(XUD9AU)	•		GWB1444	
	1994.03-2002.04	Bus Engine D9B(XUD9AU)	•		GWB3428	
	1994.03-2002.04	Bus Engine D9B(XUD9AU)	•		GWB3640	
	1994.03-2002.04	Bus Engine D9B(XUD9AU)	•		GWB3641	
	1994.03-2002.04	Bus Engine D9B(XUD9AU)		○	GWB3429	
	1994.03-2002.04	Bus Engine D9B(XUD9AU)		○	GWB3430	
1.9 TD (66 kW)	1994.08-2002.04	Bus Engine DHY(XUD9TE)	•		GHA428004	
	1994.08-2002.04	Bus Engine DHY(XUD9TE)	•		GHA428006	
	1994.08-2002.04	Bus Engine DHY(XUD9TE)	•		GHA435001	
	1994.08-2002.04	Bus Engine DHY(XUD9TE)	•		GHA435002	
	1994.08-2002.04	Bus Engine DHY(XUD9TE)	•		GWB1444	
	1994.08-2002.04	Bus Engine DHY(XUD9TE)	•		GWB3428	
	1994.08-2002.04	Bus Engine DHY(XUD9TE)	•		GWB3640	
	1994.08-2002.04	Bus Engine DHY(XUD9TE)	•		GWB3641	
	1994.08-2002.04	Bus Engine DHY(XUD9TE)		○	GWB3429	
	1994.08-2002.04	Bus Engine DHY(XUD9TE)		○	GWB3430	
1.9 TD (68 kW)	1994.03-2002.04	Bus Engine D8C(XUD9UTF)	•		GHA428004	
	1994.03-2002.04	Bus Engine D8C(XUD9UTF)	•		GHA428006	
	1994.03-2002.04	Bus Engine D8C(XUD9UTF)	•		GHA435001	
	1994.03-2002.04	Bus Engine D8C(XUD9UTF)	•		GHA435002	
	1994.03-2002.04	Bus Engine D8C(XUD9UTF)	•		GWB1444	
	1994.03-2002.04	Bus Engine D8C(XUD9UTF)	•		GWB3428	
	1994.03-2002.04	Bus Engine D8C(XUD9UTF)	•		GWB3640	
	1994.03-2002.04	Bus Engine D8C(XUD9UTF)	•		GWB3641	
	1994.03-2002.04	Bus Engine D8C(XUD9UTF)		○	GWB3429	
	1994.03-2002.04	Bus Engine D8C(XUD9UTF)		○	GWB3430	
1.9 TD 4x4 (68 kW)	1996.07-2002.04	Bus Engine D8C(XUD9UTF)	•		GHA435001	
	1996.07-2002.04	Bus Engine D8C(XUD9UTF)	•		GWB1444	
	1996.07-2002.04	Bus Engine D8C(XUD9UTF)	•		GWB3428	
	1996.07-2002.04	Bus Engine D8C(XUD9UTF)	•		GWB3640	
	1996.07-2002.04	Bus Engine D8C(XUD9UTF)	•		GWB3641	
	1996.07-2002.04	Bus Engine D8C(XUD9UTF)		○	GWB3679	
2.0 i (80 kW)	1994.03-2002.04	Bus Engine RFW(XU10J2)	•		GHA428004	
	1994.03-2002.04	Bus Engine RFW(XU10J2)	•		GHA428006	
	1994.03-2002.04	Bus Engine RFW(XU10J2)	•		GHA435002	
	1994.03-2002.04	Bus Engine RFW(XU10J2)	•		GWB1444	
	1994.03-2002.04	Bus Engine RFW(XU10J2)	•		GWB3428	
	1994.03-2002.04	Bus Engine RFW(XU10J2)	•		GWB3640	
	1994.03-2002.04	Bus Engine RFW(XU10J2)	•		GWB3641	
	1994.03-2002.04	Bus Engine RFW(XU10J2)		○	GWB3429	
	1994.03-2002.04	Bus Engine RFW(XU10J2)		○	GWB3430	
	1994.03-2002.04	Bus Engine RFW(XU10J2)		○	GWB3642	
2.0 i 4x4 (80 kW)	1996.08-2002.04	Bus Engine RFW(XU10J2)	•		GHA428004	
	1996.08-2002.04	Bus Engine RFW(XU10J2)	•		GHA428006	
	1996.08-2002.04	Bus Engine RFW(XU10J2)	•		GHA435002	
	1996.08-2002.04	Bus Engine RFW(XU10J2)	•		GWB1444	
	1996.08-2002.04	Bus Engine RFW(XU10J2)	•		GWB3428	
	1996.08-2002.04	Bus Engine RFW(XU10J2)	•		GWB3640	
	1996.08-2002.04	Bus Engine RFW(XU10J2)	•		GWB3641	
	1996.08-2002.04	Bus Engine RFW(XU10J2)		○	GWB3679	
2.5 D (63 kW)	1994.08-2002.04	Bus Engine T9A(DJ5)	•		GHA428004	
	1994.08-2002.04	Bus Engine T9A(DJ5)	•		GHA428006	
	1994.08-2002.04	Bus Engine T9A(DJ5)	•		GHA435001	
	1994.08-2002.04	Bus Engine T9A(DJ5)	•		GHA435002	
	1994.08-2002.04	Bus Engine T9A(DJ5)	•		GWB1444	
	1994.08-2002.04	Bus Engine T9A(DJ5)	•		GWB3428	
	1994.08-2002.04	Bus Engine T9A(DJ5)	•		GWB3640	
	1994.08-2002.04	Bus Engine T9A(DJ5)		○	GWB3679	



	 YEAR		F	R	G-AP Ref.	KIT	
PEUGEOT							
BOXER (230P)							
2.5 D (63 kW)	1994.08-2002.04	Bus Engine T9A(DJ5)	•		GWB3641		
	1994.08-2002.04	Bus Engine T9A(DJ5)		○	GWB3429		
	1994.08-2002.04	Bus Engine T9A(DJ5)		○	GWB3430		
	1994.08-2002.04	Bus Engine T9A(DJ5)		○	GWB3642		
2.5 D 4x4 (63 kW)	1996.07-2002.04	Bus Engine T9A(DJ5)	•		GHA428004		
	1996.07-2002.04	Bus Engine T9A(DJ5)	•		GHA428006		
	1996.07-2002.04	Bus Engine T9A(DJ5)	•		GHA435001		
	1996.07-2002.04	Bus Engine T9A(DJ5)	•		GHA435002		
	1996.07-2002.04	Bus Engine T9A(DJ5)	•		GWB1444		
	1996.07-2002.04	Bus Engine T9A(DJ5)	•		GWB3428		
	1996.07-2002.04	Bus Engine T9A(DJ5)	•		GWB3640		
	1996.07-2002.04	Bus Engine T9A(DJ5)	•		GWB3641		
	1996.07-2002.04	Bus Engine T9A(DJ5)		○	GWB3679		
	1996.07-2002.04	Bus Engine T9A(DJ5)		○	GWB3642		
2.5 DT (62 kW)	1997.10-2001.11	Bus	•		GHA428004		
	1997.10-2001.11	Bus	•		GHA428006		
	1997.10-2001.11	Bus	•		GHA435002		
2.5 TD (76 kW)	1994.07-2002.04	Bus Engine T8A(DJ5T)	•		GHA428004		
	1994.07-2002.04	Bus Engine T8A(DJ5T)	•		GHA428006		
	1994.07-2002.04	Bus Engine T8A(DJ5T)	•		GHA435001		
	1994.07-2002.04	Bus Engine T8A(DJ5T)	•		GHA435002		
	1994.07-2002.04	Bus Engine T8A(DJ5T)	•		GWB1444		
	1994.07-2002.04	Bus Engine T8A(DJ5T)	•		GWB3428		
	1994.07-2002.04	Bus Engine T8A(DJ5T)	•		GWB3640		
	1994.07-2002.04	Bus Engine T8A(DJ5T)	•		GWB3641		
	1994.07-2002.04	Bus Engine T8A(DJ5T)		○	GWB3429		
	1994.07-2002.04	Bus Engine T8A(DJ5T)		○	GWB3430		
	1994.07-2002.04	Bus Engine T8A(DJ5T)		○	GWB3642		
	2.5 TD 4x4 (76 kW)	1996.07-2002.04	Bus Engine T8A(DJ5T)	•		GHA428004	
		1996.07-2002.04	Bus Engine T8A(DJ5T)	•		GHA428006	
1996.07-2002.04		Bus Engine T8A(DJ5T)	•		GHA435001		
1996.07-2002.04		Bus Engine T8A(DJ5T)	•		GHA435002		
1996.07-2002.04		Bus Engine T8A(DJ5T)	•		GWB1444		
1996.07-2002.04		Bus Engine T8A(DJ5T)	•		GWB3428		
1996.07-2002.04		Bus Engine T8A(DJ5T)	•		GWB3640		
1996.07-2002.04		Bus Engine T8A(DJ5T)	•		GWB3641		
1996.07-2002.04		Bus Engine T8A(DJ5T)		○	GWB3679		
1996.07-2002.04		Bus Engine T8A(DJ5T)		○	GWB3642		
2.5 TDi (79 kW)	1997.01-2002.04	Bus Engine THX(DJ5TED)	•		GHA428004		
	1997.01-2002.04	Bus Engine THX(DJ5TED)	•		GHA428006		
	1997.01-2002.04	Bus Engine THX(DJ5TED)	•		GHA435001		
	1997.01-2002.04	Bus Engine THX(DJ5TED)	•		GHA435002		
	1997.01-2002.04	Bus Engine THX(DJ5TED)	•		GWB1444		
	1997.01-2002.04	Bus Engine THX(DJ5TED)	•		GWB3428		
	1997.01-2002.04	Bus Engine THX(DJ5TED)	•		GWB3640		
	1997.01-2002.04	Bus Engine THX(DJ5TED)	•		GWB3641		
	1997.01-2002.04	Bus Engine THX(DJ5TED)		○	GWB3429		
	1997.01-2002.04	Bus Engine THX(DJ5TED)		○	GWB3430		
	1997.01-2002.04	Bus Engine THX(DJ5TED)		○	GWB3642		
2.5 TDi 4x4 (79 kW)	1997.01-2002.04	Bus Engine THX(DJ5TED)	•		GHA428004		
	1997.01-2002.04	Bus Engine THX(DJ5TED)	•		GHA428006		
	1997.01-2002.04	Bus Engine THX(DJ5TED)	•		GHA435001		
	1997.01-2002.04	Bus Engine THX(DJ5TED)	•		GHA435002		
	1997.01-2002.04	Bus Engine THX(DJ5TED)	•		GWB1444		
	1997.01-2002.04	Bus Engine THX(DJ5TED)	•		GWB3428		
	1997.01-2002.04	Bus Engine THX(DJ5TED)	•		GWB3640		
	1997.01-2002.04	Bus Engine THX(DJ5TED)	•		GWB3641		
	1997.01-2002.04	Bus Engine THX(DJ5TED)		○	GWB3679		
	1997.01-2002.04	Bus Engine THX(DJ5TED)		○	GWB3642		
2.8 D (64 kW)	1999.01-2002.02	Bus Engine 8140.63(F28D)	•		GHA428004		
	1999.01-2002.02	Bus Engine 8140.63(F28D)	•		GHA428006		
	1999.01-2002.02	Bus Engine 8140.63(F28D)	•		GHA435002		
	1999.01-2002.02	Bus Engine 8140.63(F28D)	•		GWB1444		
	1999.01-2002.02	Bus Engine 8140.63(F28D)	•		GWB3428		
	1999.01-2002.02	Bus Engine 8140.63(F28D)	•		GWB3640		
	1999.01-2002.02	Bus Engine 8140.63(F28D)	•		GWB3641		
	1999.01-2002.02	Bus Engine 8140.63(F28D)		○	GWB3429		



	 YEAR		F	R	G-AP Ref.	KIT
PEUGEOT						
BOXER (230P)						
2.8 D (64 kW)	1999.01-2002.02	Bus Engine 8140.63(F28D)		○	GWB3430	
	1999.01-2002.02	Bus Engine 8140.63(F28D)		○	GWB3642	
2.8 HDi (93 kW)	2000.10-2001.11	Bus Engine 8140.43S(F28DTCR)	●		GHA428004	
	2000.10-2001.11	Bus Engine 8140.43S(F28DTCR)	●		GHA428006	
	2000.10-2001.11	Bus Engine 8140.43S(F28DTCR)	●		GHA435002	
	2000.10-2001.11	Bus Engine 8140.43S(F28DTCR)	●		GWB1444	
	2000.10-2001.11	Bus Engine 8140.43S(F28DTCR)	●		GWB3428	
	2000.10-2001.11	Bus Engine 8140.43S(F28DTCR)	●		GWB3640	
	2000.10-2001.11	Bus Engine 8140.43S(F28DTCR)	●		GWB3641	
	2000.10-2001.11	Bus Engine 8140.43S(F28DTCR)		○	GWB3429	
	2000.10-2001.11	Bus Engine 8140.43S(F28DTCR)		○	GWB3430	
	2000.10-2001.11	Bus Engine 8140.43S(F28DTCR)		○	GWB3642	
2.8 HDi (94 kW)	2000.11-2002.04	Bus Engine 8140.43S(F28DTCR)	●		GHA428004	
	2000.11-2002.04	Bus Engine 8140.43S(F28DTCR)	●		GHA428006	
	2000.11-2002.04	Bus Engine 8140.43S(F28DTCR)	●		GHA435001	
	2000.11-2002.04	Bus Engine 8140.43S(F28DTCR)	●		GHA435002	
	2000.11-2002.04	Bus Engine 8140.43S(F28DTCR)	●		GWB1444	
	2000.11-2002.04	Bus Engine 8140.43S(F28DTCR)	●		GWB3428	
	2000.11-2002.04	Bus Engine 8140.43S(F28DTCR)	●		GWB3640	
	2000.11-2002.04	Bus Engine 8140.43S(F28DTCR)	●		GWB3641	
	2000.11-2002.04	Bus Engine 8140.43S(F28DTCR)		○	GWB3429	
	2000.11-2002.04	Bus Engine 8140.43S(F28DTCR)		○	GWB3430	
2.8 HDi 4x4 (94 kW)	2000.10-2002.04	Bus Engine 8140.43S(F28DTCR)	●		GHA428004	
	2000.10-2002.04	Bus Engine 8140.43S(F28DTCR)	●		GHA428006	
	2000.10-2002.04	Bus Engine 8140.43S(F28DTCR)	●		GHA435002	
	2000.10-2002.04	Bus Engine 8140.43S(F28DTCR)	●		GWB1444	
	2000.10-2002.04	Bus Engine 8140.43S(F28DTCR)	●		GWB3428	
	2000.10-2002.04	Bus Engine 8140.43S(F28DTCR)	●		GWB3640	
	2000.10-2002.04	Bus Engine 8140.43S(F28DTCR)	●		GWB3641	
	2000.10-2002.04	Bus Engine 8140.43S(F28DTCR)		○	GWB3679	
2.8 HDi All-wheel Drive (93 kW)	2000.10-2001.11	Bus Engine 8140.43S (F28DTCR)	●		GHA428004	
	2000.10-2001.11	Bus Engine 8140.43S (F28DTCR)	●		GHA428006	
	2000.10-2001.11	Bus Engine 8140.43S (F28DTCR)	●		GHA435002	
	2000.10-2001.11	Bus Engine 8140.43S (F28DTCR)	●		GWB1444	
	2000.10-2001.11	Bus Engine 8140.43S (F28DTCR)	●		GWB3428	
	2000.10-2001.11	Bus Engine 8140.43S (F28DTCR)	●		GWB3640	
	2000.10-2001.11	Bus Engine 8140.43S (F28DTCR)	●		GWB3641	
	2000.10-2001.11	Bus Engine 8140.43S (F28DTCR)		○	GWB3679	
BOXER (244)						
2.0 (81 kW)	2002.04-	Box Engine RFL(XU10J2U)	●		GHA428006	
	2002.04-	Box Engine RFL(XU10J2U)	●		GHA435002	
	2002.04-	Box Engine RFL(XU10J2U)	●		GWB3640	
	2002.04-	Box Engine RFL(XU10J2U)	●		GWB3641	
	2002.04-	Box Engine RFL(XU10J2U)	●		GWB3690	
	2002.04-	Box Engine RFL(XU10J2U)		○	GWB3642	
2.0 BiFuel (81 kW)	2001.12-2006.06	Box	●		GHA428006	
	2001.12-2006.06	Box	●		GHA435002	
	2001.12-2006.06	Platform/Chassis	●		GHA428006	
	2001.12-2006.06	Platform/Chassis	●		GHA435002	
2.0 HDi (62 kW)	2002.04-	Box Engine RHV(DW10TD)/RHV(DW10UTD)	●		GHA428006	
	2002.04-	Box Engine RHV(DW10TD)/RHV(DW10UTD)	●		GHA435002	
	2002.04-	Box Engine RHV(DW10TD)/RHV(DW10UTD)	●		GWB3640	
	2002.04-	Box Engine RHV(DW10TD)/RHV(DW10UTD)	●		GWB3641	
	2002.04-	Box Engine RHV(DW10TD)/RHV(DW10UTD)	●		GWB3690	
	2002.04-	Box Engine RHV(DW10TD)/RHV(DW10UTD)		○	GWB3642	
	2002.04-	Platform/Chassis Engine RHV(DW10TD)/RHV(DW10UTD)	●		GHA428006	
	2002.04-	Platform/Chassis Engine RHV(DW10TD)/RHV(DW10UTD)	●		GHA435002	
	2002.04-	Platform/Chassis Engine RHV(DW10TD)/RHV(DW10UTD)	●		GWB3640	
	2002.04-	Platform/Chassis Engine RHV(DW10TD)/RHV(DW10UTD)	●		GWB3641	
2.2 HDi (74 kW)	2002.04-	Box Engine 4HY(DW12UTD)	●		GHA428006	
	2002.04-	Box Engine 4HY(DW12UTD)	●		GHA435002	



	 YEAR		F	R	G-AP Ref.	KIT	
PEUGEOT							
BOXER (244)							
2.2 HDi (74 kW)	2002.04-	Box Engine 4HY(DW12UTED)	•		GWB3640		
	2002.04-	Box Engine 4HY(DW12UTED)	•		GWB3641		
	2002.04-	Box Engine 4HY(DW12UTED)	•		GWB3690		
	2002.04-	Box Engine 4HY(DW12UTED)		○	GWB3642		
	2002.04-	Platform/Chassis Engine 4HY(DW12UTED)	•		GHA428006		
	2002.04-	Platform/Chassis Engine 4HY(DW12UTED)	•		GHA435002		
	2002.04-	Platform/Chassis Engine 4HY(DW12UTED)	•		GWB3640		
	2002.04-	Platform/Chassis Engine 4HY(DW12UTED)	•		GWB3641		
	2002.04-	Platform/Chassis Engine 4HY(DW12UTED)	•		GWB3690		
	2002.04-	Platform/Chassis Engine 4HY(DW12UTED)		○	GWB3642		
	2.8 HDi (107 kW)	2004.04-	Box Engine 8140.43N	•		GHA428006	
		2004.04-	Box Engine 8140.43N	•		GHA435002	
		2004.04-	Box Engine 8140.43N	•		GWB3640	
		2004.04-	Box Engine 8140.43N	•		GWB3641	
2004.04-		Box Engine 8140.43N	•		GWB3690		
2004.04-		Box Engine 8140.43N		○	GWB3642		
2004.04-		Platform/Chassis Engine 8140.43N	•		GHA428006		
2004.04-		Platform/Chassis Engine 8140.43N	•		GHA435002		
2004.04-		Platform/Chassis Engine 8140.43N	•		GWB3640		
2004.04-		Platform/Chassis Engine 8140.43N	•		GWB3641		
2004.04-		Platform/Chassis Engine 8140.43N	•		GWB3690		
2004.04-		Platform/Chassis Engine 8140.43N		○	GWB3642		
2.8 HDi (93 kW)	2005.09-2009.09	Box Engine 8140.43S(F28DTCR)	•		GHA428006		
	2005.09-2009.09	Box Engine 8140.43S(F28DTCR)	•		GHA435002		
	2005.09-2009.09	Box Engine 8140.43S(F28DTCR)	•		GWB3640		
	2005.09-2009.09	Box Engine 8140.43S(F28DTCR)	•		GWB3641		
	2005.09-2009.09	Box Engine 8140.43S(F28DTCR)	•		GWB3690		
	2005.09-2009.09	Box Engine 8140.43S(F28DTCR)		○	GWB3642		
2.8 HDi (94 kW)	2002.04-	Box Engine 8140.43S(F28DTCR)	•		GHA428006		
	2002.04-	Box Engine 8140.43S(F28DTCR)	•		GHA435002		
	2002.04-	Box Engine 8140.43S(F28DTCR)	•		GWB3640		
	2002.04-	Box Engine 8140.43S(F28DTCR)	•		GWB3641		
	2002.04-	Box Engine 8140.43S(F28DTCR)	•		GWB3690		
	2002.04-	Box Engine 8140.43S(F28DTCR)		○	GWB3642		
	2002.04-	Platform/Chassis Engine 8140.43S(F28DTCR)	•		GHA428006		
	2002.04-	Platform/Chassis Engine 8140.43S(F28DTCR)	•		GHA435002		
	2002.04-	Platform/Chassis Engine 8140.43S(F28DTCR)	•		GWB3640		
	2002.04-	Platform/Chassis Engine 8140.43S(F28DTCR)	•		GWB3641		
	2002.04-	Platform/Chassis Engine 8140.43S(F28DTCR)	•		GWB3690		
	2002.04-	Platform/Chassis Engine 8140.43S(F28DTCR)		○	GWB3642		
	2.8 HDi 4x4 (94 kW)	2002.04-	Box Engine 8140.43S(F28DTCR)	•		GHA428006	
		2002.04-	Box Engine 8140.43S(F28DTCR)	•		GHA435002	
2002.04-		Box Engine 8140.43S(F28DTCR)	•		GWB3640		
2002.04-		Box Engine 8140.43S(F28DTCR)	•		GWB3641		
2002.04-		Box Engine 8140.43S(F28DTCR)	•		GWB3690		
2002.04-		Box Engine 8140.43S(F28DTCR)		○	GWB3679		
2002.04-		Platform/Chassis Engine 8140.43S(F28DTCR)	•		GHA428006		
2002.04-		Platform/Chassis Engine 8140.43S(F28DTCR)	•		GHA435002		
2002.04-		Platform/Chassis Engine 8140.43S(F28DTCR)	•		GWB3640		
2002.04-		Platform/Chassis Engine 8140.43S(F28DTCR)	•		GWB3641		
2002.04-		Platform/Chassis Engine 8140.43S(F28DTCR)	•		GWB3690		
2002.04-		Platform/Chassis Engine 8140.43S(F28DTCR)		○	GWB3679		
BOXER (244, Z_)							
2.0 (81 kW)		2002.04-	Bus Engine RFL(XU10J2U)	•		GHA428006	
	2002.04-	Bus Engine RFL(XU10J2U)	•		GHA435002		
	2002.04-	Bus Engine RFL(XU10J2U)	•		GWB3640		
	2002.04-	Bus Engine RFL(XU10J2U)	•		GWB3641		
	2002.04-	Bus Engine RFL(XU10J2U)	•		GWB3690		
	2002.04-	Bus Engine RFL(XU10J2U)		○	GWB3642		
2.0 BiFuel (81 kW)	2001.12-2006.06	Bus	•		GHA428006		
	2001.12-2006.06	Bus	•		GHA435002		
2.0 HDi (62 kW)	2002.04-	Bus Engine RHV(DW10TD)/RHV(DW10UTD)	•		GHA428006		
	2002.04-	Bus Engine RHV(DW10TD)/RHV(DW10UTD)	•		GHA435002		
	2002.04-	Bus Engine RHV(DW10TD)/RHV(DW10UTD)	•		GWB3640		



	 YEAR		F	R	G-AP Ref.	KIT	
PEUGEOT BOXER (244, Z_)							
2.0 HDi (62 kW)	2002.04-	Bus Engine RHV(DW10TD)/RHV(DW10UTD)	•		GWB3641		
	2002.04-	Bus Engine RHV(DW10TD)/RHV(DW10UTD)	•		GWB3690		
	2002.04-	Bus Engine RHV(DW10TD)/RHV(DW10UTD)		◦	GWB3642		
2.2 HDi (74 kW)	2002.04-	Bus Engine 4HY(DW12UTED)	•		GHA428006		
	2002.04-	Bus Engine 4HY(DW12UTED)	•		GHA435002		
	2002.04-	Bus Engine 4HY(DW12UTED)	•		GWB3640		
	2002.04-	Bus Engine 4HY(DW12UTED)	•		GWB3641		
	2002.04-	Bus Engine 4HY(DW12UTED)	•		GWB3690		
	2002.04-	Bus Engine 4HY(DW12UTED)		◦	GWB3642		
2.8 HDi (107 kW)	2004.04-	Bus Engine 8140.43N	•		GHA428006		
	2004.04-	Bus Engine 8140.43N	•		GHA435002		
	2004.04-	Bus Engine 8140.43N	•		GWB3640		
	2004.04-	Bus Engine 8140.43N	•		GWB3641		
	2004.04-	Bus Engine 8140.43N	•		GWB3690		
	2004.04-	Bus Engine 8140.43N		◦	GWB3642		
2.8 HDi (94 kW)	2002.04-	Bus Engine 8140.43S(F28DTCR)	•		GHA428006		
	2002.04-	Bus Engine 8140.43S(F28DTCR)	•		GHA435002		
	2002.04-	Bus Engine 8140.43S(F28DTCR)	•		GWB3640		
	2002.04-	Bus Engine 8140.43S(F28DTCR)	•		GWB3641		
	2002.04-	Bus Engine 8140.43S(F28DTCR)	•		GWB3690		
	2002.04-	Bus Engine 8140.43S(F28DTCR)		◦	GWB3642		
2.8 HDi 4x4 (94 kW)	2002.04-	Bus Engine 8140.43S(F28DTCR)	•		GHA428006		
	2002.04-	Bus Engine 8140.43S(F28DTCR)	•		GHA435002		
	2002.04-	Bus Engine 8140.43S(F28DTCR)	•		GWB3640		
	2002.04-	Bus Engine 8140.43S(F28DTCR)	•		GWB3641		
	2002.04-	Bus Engine 8140.43S(F28DTCR)	•		GWB3690		
	2002.04-	Bus Engine 8140.43S(F28DTCR)		◦	GWB3679		
BOXER (ZCT_)							
1.9 TD (66 kW)	1998.12-2002.04	Platform/Chassis Engine DHY(XUD9TE)	•		GHA428004		
	1998.12-2002.04	Platform/Chassis Engine DHY(XUD9TE)	•		GHA428006		
	1998.12-2002.04	Platform/Chassis Engine DHY(XUD9TE)	•		GHA435001		
	1998.12-2002.04	Platform/Chassis Engine DHY(XUD9TE)	•		GHA435002		
	1998.12-2002.04	Platform/Chassis Engine DHY(XUD9TE)	•		GWB1444		
	1998.12-2002.04	Platform/Chassis Engine DHY(XUD9TE)	•		GWB3428		
	1998.12-2002.04	Platform/Chassis Engine DHY(XUD9TE)	•		GWB3640		
	1998.12-2002.04	Platform/Chassis Engine DHY(XUD9TE)	•		GWB3641		
	1998.12-2002.04	Platform/Chassis Engine DHY(XUD9TE)		◦	GWB3429		
	1998.12-2002.04	Platform/Chassis Engine DHY(XUD9TE)		◦	GWB3430		
	1998.12-2002.04	Platform/Chassis Engine DHY(XUD9TE)		◦	GWB3642		
	1.9 TD (68 kW)	1996.07-2002.04	Platform/Chassis Engine D8C(XUD9UTF)	•		GHA428004	
		1996.07-2002.04	Platform/Chassis Engine D8C(XUD9UTF)	•		GHA428006	
		1996.07-2002.04	Platform/Chassis Engine D8C(XUD9UTF)	•		GHA435001	
1996.07-2002.04		Platform/Chassis Engine D8C(XUD9UTF)	•		GHA435002		
1996.07-2002.04		Platform/Chassis Engine D8C(XUD9UTF)	•		GWB1444		
1996.07-2002.04		Platform/Chassis Engine D8C(XUD9UTF)	•		GWB3428		
1996.07-2002.04		Platform/Chassis Engine D8C(XUD9UTF)	•		GWB3640		
1996.07-2002.04		Platform/Chassis Engine D8C(XUD9UTF)	•		GWB3641		
1996.07-2002.04		Platform/Chassis Engine D8C(XUD9UTF)		◦	GWB3429		
1996.07-2002.04		Platform/Chassis Engine D8C(XUD9UTF)		◦	GWB3430		
1996.07-2002.04		Platform/Chassis Engine D8C(XUD9UTF)		◦	GWB3642		
2.0 (81 kW)	2001.12-2002.04	Platform/Chassis Engine RFL(XU10J2U)	•		GHA428006		
	2001.12-2002.04	Platform/Chassis Engine RFL(XU10J2U)	•		GHA435002		
2.0 i (80 kW)	1994.06-2002.04	Platform/Chassis Engine RFW(XU10J2)	•		GHA428004		
	1994.06-2002.04	Platform/Chassis Engine RFW(XU10J2)	•		GHA428006		
	1994.06-2002.04	Platform/Chassis Engine RFW(XU10J2)	•		GHA435002		
	1994.06-2002.04	Platform/Chassis Engine RFW(XU10J2)	•		GWB1444		
	1994.06-2002.04	Platform/Chassis Engine RFW(XU10J2)	•		GWB3428		
	1994.06-2002.04	Platform/Chassis Engine RFW(XU10J2)	•		GWB3640		
	1994.06-2002.04	Platform/Chassis Engine RFW(XU10J2)	•		GWB3641		
	1994.06-2002.04	Platform/Chassis Engine RFW(XU10J2)		◦	GWB3429		
	1994.06-2002.04	Platform/Chassis Engine RFW(XU10J2)		◦	GWB3430		
	1994.06-2002.04	Platform/Chassis Engine RFW(XU10J2)		◦	GWB3642		
2.5 D (63 kW)	1994.03-2002.04	Platform/Chassis Engine T9A(DJ5)	•		GHA428004		
	1994.03-2002.04	Platform/Chassis Engine T9A(DJ5)	•		GHA428006		



	 YEAR		F	R	G-AP Ref.	KIT	
PEUGEOT							
BOXER (ZCT_)							
2.5 D (63 kW)	1994.03-2002.04	Platform/Chassis Engine T9A(DJ5)	•		GHA435001		
	1994.03-2002.04	Platform/Chassis Engine T9A(DJ5)	•		GHA435002		
	1994.03-2002.04	Platform/Chassis Engine T9A(DJ5)	•		GWB1444		
	1994.03-2002.04	Platform/Chassis Engine T9A(DJ5)	•		GWB3428		
	1994.03-2002.04	Platform/Chassis Engine T9A(DJ5)	•		GWB3640		
	1994.03-2002.04	Platform/Chassis Engine T9A(DJ5)	•		GWB3641		
	1994.03-2002.04	Platform/Chassis Engine T9A(DJ5)		○	GWB3429		
	1994.03-2002.04	Platform/Chassis Engine T9A(DJ5)		○	GWB3430		
	1994.03-2002.04	Platform/Chassis Engine T9A(DJ5)		○	GWB3642		
2.5 D 4x4 (63 kW)	1999.07-2002.04	Platform/Chassis Engine T9A(DJ5)	•		GHA428004		
	1999.07-2002.04	Platform/Chassis Engine T9A(DJ5)	•		GHA428006		
	1999.07-2002.04	Platform/Chassis Engine T9A(DJ5)	•		GHA435001		
	1999.07-2002.04	Platform/Chassis Engine T9A(DJ5)	•		GHA435002		
	1999.07-2002.04	Platform/Chassis Engine T9A(DJ5)	•		GWB1444		
	1999.07-2002.04	Platform/Chassis Engine T9A(DJ5)	•		GWB3428		
	1999.07-2002.04	Platform/Chassis Engine T9A(DJ5)	•		GWB3640		
	1999.07-2002.04	Platform/Chassis Engine T9A(DJ5)	•		GWB3641		
	1999.07-2002.04	Platform/Chassis Engine T9A(DJ5)		○	GWB3679		
2.5 TD (76 kW)	1994.03-2002.04	Platform/Chassis Engine T8A(DJ5T)	•		GHA428004		
	1994.03-2002.04	Platform/Chassis Engine T8A(DJ5T)	•		GHA428006		
	1994.03-2002.04	Platform/Chassis Engine T8A(DJ5T)	•		GHA435001		
	1994.03-2002.04	Platform/Chassis Engine T8A(DJ5T)	•		GHA435002		
	1994.03-2002.04	Platform/Chassis Engine T8A(DJ5T)	•		GWB1444		
	1994.03-2002.04	Platform/Chassis Engine T8A(DJ5T)	•		GWB3428		
	1994.03-2002.04	Platform/Chassis Engine T8A(DJ5T)	•		GWB3640		
	1994.03-2002.04	Platform/Chassis Engine T8A(DJ5T)	•		GWB3641		
	1994.03-2002.04	Platform/Chassis Engine T8A(DJ5T)		○	GWB3429		
	1994.03-2002.04	Platform/Chassis Engine T8A(DJ5T)		○	GWB3430		
	1994.03-2002.04	Platform/Chassis Engine T8A(DJ5T)		○	GWB3642		
	2.5 TDi (79 kW)	1997.01-2002.04	Platform/Chassis Engine THX(DJ5TED)	•		GHA428004	
		1997.01-2002.04	Platform/Chassis Engine THX(DJ5TED)	•		GHA428006	
1997.01-2002.04		Platform/Chassis Engine THX(DJ5TED)	•		GHA435001		
1997.01-2002.04		Platform/Chassis Engine THX(DJ5TED)	•		GHA435002		
1997.01-2002.04		Platform/Chassis Engine THX(DJ5TED)	•		GWB1444		
1997.01-2002.04		Platform/Chassis Engine THX(DJ5TED)	•		GWB3428		
1997.01-2002.04		Platform/Chassis Engine THX(DJ5TED)	•		GWB3640		
1997.01-2002.04		Platform/Chassis Engine THX(DJ5TED)	•		GWB3641		
1997.01-2002.04		Platform/Chassis Engine THX(DJ5TED)		○	GWB3429		
1997.01-2002.04		Platform/Chassis Engine THX(DJ5TED)		○	GWB3430		
1997.01-2002.04	Platform/Chassis Engine THX(DJ5TED)		○	GWB3642			
2.5 TDi 4x4 (79 kW)	1999.07-2002.04	Platform/Chassis Engine THX(DJ5TED)	•		GHA428004		
	1999.07-2002.04	Platform/Chassis Engine THX(DJ5TED)	•		GHA428006		
	1999.07-2002.04	Platform/Chassis Engine THX(DJ5TED)	•		GHA435001		
	1999.07-2002.04	Platform/Chassis Engine THX(DJ5TED)	•		GHA435002		
	1999.07-2002.04	Platform/Chassis Engine THX(DJ5TED)	•		GWB1444		
	1999.07-2002.04	Platform/Chassis Engine THX(DJ5TED)	•		GWB3428		
	1999.07-2002.04	Platform/Chassis Engine THX(DJ5TED)	•		GWB3640		
	1999.07-2002.04	Platform/Chassis Engine THX(DJ5TED)	•		GWB3641		
	1999.07-2002.04	Platform/Chassis Engine THX(DJ5TED)		○	GWB3679		
2.8 D (64 kW)	1999.01-2002.02	Platform/Chassis Engine 8140.63(F28D)	•		GHA428004		
	1999.01-2002.02	Platform/Chassis Engine 8140.63(F28D)	•		GHA428006		
	1999.01-2002.02	Platform/Chassis Engine 8140.63(F28D)	•		GHA435002		
	1999.01-2002.02	Platform/Chassis Engine 8140.63(F28D)	•		GWB1444		
	1999.01-2002.02	Platform/Chassis Engine 8140.63(F28D)	•		GWB3428		
	1999.01-2002.02	Platform/Chassis Engine 8140.63(F28D)	•		GWB3640		
	1999.01-2002.02	Platform/Chassis Engine 8140.63(F28D)	•		GWB3641		
	1999.01-2002.02	Platform/Chassis Engine 8140.63(F28D)		○	GWB3429		
	1999.01-2002.02	Platform/Chassis Engine 8140.63(F28D)		○	GWB3430		
	1999.01-2002.02	Platform/Chassis Engine 8140.63(F28D)		○	GWB3642		
2.8 HDi (93 kW)	2000.10-2001.11	Platform/Chassis Engine 8140.43S(F28DTCR)	•		GHA428004		
	2000.10-2001.11	Platform/Chassis Engine 8140.43S(F28DTCR)	•		GHA428006		
	2000.10-2001.11	Platform/Chassis Engine 8140.43S(F28DTCR)	•		GHA435002		
	2000.10-2001.11	Platform/Chassis Engine 8140.43S(F28DTCR)	•		GWB1444		
	2000.10-2001.11	Platform/Chassis Engine 8140.43S(F28DTCR)	•		GWB3428		



	 YEAR		F	R	G-AP Ref.	KIT
PEUGEOT						
BOXER (ZCT_)						
2.8 HDi (93 kW)	2000.10-2001.11	Platform/Chassis Engine 8140.43S(F28DTCR)	•		GWB3640	
	2000.10-2001.11	Platform/Chassis Engine 8140.43S(F28DTCR)	•		GWB3641	
	2000.10-2001.11	Platform/Chassis Engine 8140.43S(F28DTCR)		○	GWB3429	
	2000.10-2001.11	Platform/Chassis Engine 8140.43S(F28DTCR)		○	GWB3430	
	2000.10-2001.11	Platform/Chassis Engine 8140.43S(F28DTCR)		○	GWB3642	
2.8 HDi (94 kW)	2000.11-2002.04	Platform/Chassis Engine 8140.43S(F28DTCR)	•		GHA428004	
	2000.11-2002.04	Platform/Chassis Engine 8140.43S(F28DTCR)	•		GHA428006	
	2000.11-2002.04	Platform/Chassis Engine 8140.43S(F28DTCR)	•		GHA435001	
	2000.11-2002.04	Platform/Chassis Engine 8140.43S(F28DTCR)	•		GHA435002	
	2000.11-2002.04	Platform/Chassis Engine 8140.43S(F28DTCR)	•		GWB1444	
	2000.11-2002.04	Platform/Chassis Engine 8140.43S(F28DTCR)	•		GWB3428	
	2000.11-2002.04	Platform/Chassis Engine 8140.43S(F28DTCR)	•		GWB3640	
	2000.11-2002.04	Platform/Chassis Engine 8140.43S(F28DTCR)	•		GWB3641	
	2000.11-2002.04	Platform/Chassis Engine 8140.43S(F28DTCR)		○	GWB3429	
	2000.11-2002.04	Platform/Chassis Engine 8140.43S(F28DTCR)		○	GWB3430	
	2000.11-2002.04	Platform/Chassis Engine 8140.43S(F28DTCR)		○	GWB3642	
EXPERT						
1.6 HDi (66 kW)	2007.01-	Platform/Chassis Engine 9HU(DV6UTED4)	•		GWB6575	
	2007.01-	Platform/Chassis Engine 9HU(DV6UTED4)		○	GHA400182	K
2.0 HDi (100 kW)	2007.01-	Platform/Chassis Engine RHR(DW10BTED4)	•		GWB6575	
	2007.01-	Platform/Chassis Engine RHR(DW10BTED4)		○	GHA400182	K
2.0 HDi (88 kW)	2007.01-	Platform/Chassis Engine RHK(DW10UTED4)	•		GWB6575	
	2007.01-	Platform/Chassis Engine RHK(DW10UTED4)		○	GHA400182	K
EXPERT (223)						
1.6 (58 kW)	1996.02-	Platform/Chassis Engine 222A2(1580SPI)	•		GWB3423	
	1996.02-	Platform/Chassis Engine 222A2(1580SPI)		○	GHA230111	K
1.9 D (51 kW)	1996.02-	Platform/Chassis Engine D9B(XUD9AU)	•		GWB3423	
	1996.02-	Platform/Chassis Engine D9B(XUD9AU)		○	GHA230111	K
	1998.06-2003.11	Platform/Chassis Engine WJY(DW8B)/WJZ(DW8)	•		GWB3423	
	1998.06-2003.11	Platform/Chassis Engine WJY(DW8B)/WJZ(DW8)		○	GHA230111	K
1.9 TD (66 kW)	1996.02-	Platform/Chassis Engine DHX(XUD9TE)	•		GWB3423	
	1996.02-	Platform/Chassis Engine DHX(XUD9TE)		○	GHA230111	K
1.9 TD (68 kW)	1996.02-	Platform/Chassis Engine D8B(XUD9TE)	•		GWB3423	
	1996.02-	Platform/Chassis Engine D8B(XUD9TE)		○	GHA230111	K
2.0 HDi (80 kW)	2000.10-2006.10	Platform/Chassis Engine RHW(DW10ATED4)	•		GWB3423	
	2000.10-2006.10	Platform/Chassis Engine RHW(DW10ATED4)		○	GHA230111	K
EXPERT (224)						
1.6 (58 kW)	1996.02-	MPV Engine 222A2(1580SPI)	•		GWB3423	
	1996.02-	MPV Engine 222A2(1580SPI)		○	GHA230111	K
1.8 (74 kW)	1996.10-2000.09	MPV Engine LFZ(XU7JP)	•		GWB3423	
	1996.10-2000.09	MPV Engine LFZ(XU7JP)		○	GHA230111	K
1.9 D (51 kW)	1996.02-	MPV Engine D9B(XUD9AU)	•		GWB3423	
	1996.02-	MPV Engine D9B(XUD9AU)		○	GHA230111	K
	2003.12-	MPV Engine WJY(DW8B)/WJZ(DW8)	•		GWB3423	
	2003.12-	MPV Engine WJY(DW8B)/WJZ(DW8)		○	GHA230111	K
1.9 TD (66 kW)	1996.02-	MPV Engine DHX(XUD9TE)	•		GWB3423	
	1996.02-	MPV Engine DHX(XUD9TE)		○	GHA230111	K
1.9 TD (68 kW)	1996.02-	MPV Engine D8B(XUD9TE)	•		GWB3423	
	1996.02-	MPV Engine D8B(XUD9TE)		○	GHA230111	K
2.0 (100 kW)	2000.07-	MPV Engine RFN(EW10J4)	•		GWB3423	
	2000.07-	MPV Engine RFN(EW10J4)		○	GHA230111	K
2.0 HDi (69 kW)	2000.10-2003.11	MPV Engine RHX(DW10BTED)	•		GWB3423	
	2000.10-2003.11	MPV Engine RHX(DW10BTED)		○	GHA230111	K
2.0 HDi (80 kW)	2000.07-	MPV Engine RHZ(DW10ATED)	•		GWB3423	
	2000.07-	MPV Engine RHZ(DW10ATED)		○	GHA230111	K
	2004.03-2007.01	MPV Engine RHW(DW10ATED4)	•		GWB3423	
	2004.03-2007.01	MPV Engine RHW(DW10ATED4)		○	GHA230111	K
EXPERT (VF3A_, VF3U_, VF3X_)						
1.6 HDi (66 kW)	2007.01-	Box Engine 9HU(DV6UTED4)	•		GWB6575	
	2007.01-	Box Engine 9HU(DV6UTED4)		○	GHA400182	K
1.6 HDi 8V (66 kW)	2007.01-	Box Engine 9HH(DV6DUM)/9HM(DV6UC)	•		GWB6575	
	2007.01-	Box Engine 9HH(DV6DUM)/9HM(DV6UC)		○	GHA400182	K
2.0 16V (103 kW)	2007.01-	Box Engine RFH(EW10A)/RFJ(EW10A)	•		GWB6575	
	2007.01-	Box Engine RFH(EW10A)/RFJ(EW10A)		○	GHA400182	K



	 YEAR		F	R	G-AP Ref.	KIT
PEUGEOT						
EXPERT (VF3A_, VF3U_, VF3X_)						
2.0 HDi (100 kW)	2007.01-	Box Engine RHR(DW10BTED4)	•		GWB6575	
	2007.01-	Box Engine RHR(DW10BTED4)		◦	GHA400182	K
2.0 HDi (120 kW)	2009.09-	Box Engine RHH(DW10CTED4)	•		GWB6575	
2.0 HDi (72 kW)	2011.03-	Box	•		GWB6575	
2.0 HDi (88 kW)	2007.01-	Box Engine RHK(DW10UTED4)	•		GWB6575	
	2007.01-	Box Engine RHK(DW10UTED4)		◦	GHA400182	K
2.0 HDi (94 kW)	2011.03-	Box	•		GWB6575	
2.0 HDi 120 4x4 (88 kW)	2010.01-	Box Engine RHK (DW10UTED4)	•		GWB6575	
2.0 HDi 130 4x4 (94 kW)	2012.01-	Box Engine AHZ (DW10CD)	•		GWB6575	
EXPERT TEPEE (VF3V_)						
1.6 HDi (66 kW)	2007.01-	MPV Engine 9HU(DV6HUTED4)	•		GWB6575	
	2007.01-	MPV Engine 9HU(DV6HUTED4)		◦	GHA400182	K
1.6 HDi 8V (66 kW)	2007.01-	MPV Engine 9HH(DV6DUM)/9HM(DV6UC)	•		GWB6575	
	2007.01-	MPV Engine 9HH(DV6DUM)/9HM(DV6UC)		◦	GHA400182	K
2.0 16V (103 kW)	2007.01-	MPV Engine RFH(EW10A)/RFJ(EW10A)	•		GWB6575	
	2007.01-	MPV Engine RFH(EW10A)/RFJ(EW10A)		◦	GHA400182	K
2.0 HDi (100 kW)	2007.01-	MPV Engine RHR(DW10BTED4)	•		GWB6575	
	2007.01-	MPV Engine RHR(DW10BTED4)		◦	GHA400182	K
2.0 HDi (120 kW)	2009.09-	MPV Engine RHH(DW10CTED4)	•		GWB6575	
2.0 HDi (72 kW)	2011.03-	MPV	•		GWB6575	
2.0 HDi (88 kW)	2007.01-	MPV Engine RHK(DW10UTED4)	•		GWB6575	
	2007.01-	MPV Engine RHK(DW10UTED4)		◦	GHA400182	K
2.0 HDi (94 kW)	2011.03-	MPV Engine AHZ(DW10CD)	•		GWB6575	
2.0 HDi 130 4x4 (94 kW)	2011.03-	MPV Engine AHZ (DW10CD)	•		GWB6575	
	2011.03-	MPV Engine AHZ (DW10CD)		◦	GHA400182	K
2.0 HDi 4x4 (88 kW)	2007.01-	MPV Engine RHK(DW10UTED4)	•		GWB6575	
	2007.01-	MPV Engine RHK(DW10UTED4)		◦	GHA400182	K
EXPERT VAN (222)						
1.6 (58 kW)	1996.02-	Box Engine 222A2(1580SPI)	•		GWB3423	
	1996.02-	Box Engine 222A2(1580SPI)		◦	GHA230111	K
1.8 (74 kW)	1996.10-2000.09	Box Engine LFZ(XU7JP)	•		GWB3423	
	1996.10-2000.09	Box Engine LFZ(XU7JP)		◦	GHA230111	K
1.9 D (51 kW)	1996.02-	Box Engine D9B(XUD9AU)	•		GWB3423	
	1996.02-	Box Engine D9B(XUD9AU)		◦	GHA230111	K
	1999.05-	Box Engine WJY(DW8B)/WJZ(DW8)	•		GWB3423	
	1999.05-	Box Engine WJY(DW8B)/WJZ(DW8)		◦	GHA230111	K
1.9 TD (66 kW)	1996.02-	Box Engine DHX(XUD9TE)	•		GWB3423	
	1996.02-	Box Engine DHX(XUD9TE)		◦	GHA230111	K
1.9 TD (68 kW)	1996.02-	Box Engine D8B(XUD9TE)	•		GWB3423	
	1996.02-	Box Engine D8B(XUD9TE)		◦	GHA230111	K
2.0 (100 kW)	2002.09-	Box Engine RFN(EW10J4)	•		GWB3423	
	2002.09-	Box Engine RFN(EW10J4)		◦	GHA230111	K
2.0 HDi (69 kW)	2000.07-	Box Engine RHX(DW10BTED)	•		GWB3423	
	2000.07-	Box Engine RHX(DW10BTED)		◦	GHA230111	K
2.0 HDi (80 kW)	2000.07-	Box Engine RHW(DW10ATED4)	•		GWB3423	
	2000.07-	Box Engine RHW(DW10ATED4)		◦	GHA230111	K
	2000.07-	Box Engine RHZ(DW10ATED)/RHZ(DW10BTED)	•		GWB3423	
	2000.07-	Box Engine RHZ(DW10ATED)/RHZ(DW10BTED)		◦	GHA230111	K
J5 (290L)						
1.9 D (51 kW)	1990.10-1994.02	Platform/Chassis Engine D9B(XUD9A)	•		GWB1444	
	1990.10-1994.02	Platform/Chassis Engine D9B(XUD9A)		◦	GWB1445	
	1990.10-1994.03	Box Engine D9B(XUD9A)	•		GWB1444	
	1990.10-1994.03	Box Engine D9B(XUD9A)		◦	GWB1445	
2.0 (62 kW)	1990.10-1994.02	Platform/Chassis Engine 170D(XN1TACP)	•		GWB1444	
	1990.10-1994.02	Platform/Chassis Engine 170D(XN1TACP)		◦	GWB1445	
2.5 D (54 kW)	1990.09-1994.01	Box Engine CRD93	•		GWB1444	
	1990.10-1994.02	Platform/Chassis Engine CRD93(U25/661)	•		GWB1444	
	1990.10-1994.02	Platform/Chassis Engine CRD93(U25/661)		◦	GWB1445	
2.5 D 4x4 (54 kW)	1990.10-1994.02	Platform/Chassis Engine CRD93(U25/661)	•		GWB1444	
	1990.10-1994.03	Box Engine CRD93(U25/661)	•		GWB1444	
2.5 TD (70 kW)	1990.10-1994.02	Platform/Chassis Engine CRD93LS(U25/673)	•		GWB1444	
	1990.10-1994.02	Platform/Chassis Engine CRD93LS(U25/673)		◦	GWB1445	
2.5 TD 4x4 (70 kW)	1990.10-1994.02	Platform/Chassis Engine CRD93LS(U25/673)	•		GWB1444	
	1990.10-1994.03	Box Engine CRD93LS(U25/673)	•		GWB1444	



	 YEAR		F	R	G-AP Ref.	KIT
PEUGEOT						
J5 (290P)						
1.9 D (51 kW)	1990.10-1994.02	Bus Engine D9B(XUD9A)	•		GWB1444	
	1990.10-1994.02	Bus Engine D9B(XUD9A)		◦	GWB1445	
2.0 (62 kW)	1990.10-1994.02	Bus Engine 170D(XN1TACP)	•		GWB1444	
	1990.10-1994.02	Bus Engine 170D(XN1TACP)		◦	GWB1445	
2.5 D (54 kW)	1990.10-1994.02	Bus Engine CRD93(U25/661)	•		GWB1444	
	1990.10-1994.02	Bus Engine CRD93(U25/661)		◦	GWB1445	
2.5 D 4x4 (54 kW)	1990.10-1994.02	Bus Engine CRD93(U25/661)	•		GWB1444	
2.5 TD (70 kW)	1990.10-1994.02	Bus Engine CRD93LS(U25/673)	•		GWB1444	
	1990.10-1994.02	Bus Engine CRD93LS(U25/673)		◦	GWB1445	
2.5 TD 4x4 (70 kW)	1990.10-1994.02	Bus Engine CRD93LS(U25/673)	•		GWB1444	
PARTNER						
1.6 (66 kW)	2008.04-	Box Engine NFR(TU5JP4B)	•		GHA425022	
	2008.04-	Box Engine NFR(TU5JP4B)	•		GWB3584	
	2008.04-	Box Engine NFR(TU5JP4B)		◦	GHA230148	K
	2008.04-	Box Engine NFR(TU5JP4B)		◦	GWB6549	
1.6 (72 kW)	2010.11-	Box	•		GHA425022	
	2010.11-	Box	•		GWB3584	
	2010.11-	Box		◦	GWB6549	
1.6 (80 kW)	2008.04-	Box Engine NFU(TU5JP4)	•		GHA425022	
	2008.04-	Box Engine NFU(TU5JP4)	•		GWB3584	
	2008.04-	Box Engine NFU(TU5JP4)		◦	GWB6549	
1.6 (88 kW)	2010.04-	Box	•		GHA425022	
	2010.04-	Box	•		GWB3584	
	2010.04-	Box		◦	GWB6549	
1.6 BlueHdi 100 (73 kW)	2015.04-	Box Engine BHY (DV6FD)	•		GWB3584	
	2015.04-	Box Engine BHY (DV6FD)		◦	GWB6549	
1.6 BlueHdi 120 (88 kW)	2015.04-	Box Engine BHZ (DV6FC)	•		GWB3584	
	2015.04-	Box Engine BHZ (DV6FC)		◦	GWB6549	
1.6 HDi (55 kW)	2008.04-	Box Engine 9HT(DV6BTED4)	•		GHA425022	
	2008.04-	Box Engine 9HT(DV6BTED4)	•		GWB3584	
	2008.04-	Box Engine 9HT(DV6BTED4)		◦	GHA230148	K
	2008.04-	Box Engine 9HT(DV6BTED4)		◦	GWB6549	
	2009.01-	Platform/Chassis Engine 9HT (DV6BTED4)	•		GHA425022	
	2009.01-	Platform/Chassis Engine 9HT (DV6BTED4)	•		GWB3584	
	2009.01-	Platform/Chassis Engine 9HT (DV6BTED4)		◦	GWB6549	
1.6 HDi (66 kW)	2008.04-	Box Engine 9HX(DV6ATED4)	•		GHA425022	
	2008.04-	Box Engine 9HX(DV6ATED4)	•		GWB3584	
	2008.04-	Box Engine 9HX(DV6ATED4)		◦	GHA230148	K
	2008.04-	Box Engine 9HX(DV6ATED4)		◦	GWB6549	
1.6 HDi (68 kW)	2010.04-	Box Engine 9HP(DV6DTED)	•		GWB3584	
	2010.04-	Box Engine 9HP(DV6DTED)		◦	GWB6549	
1.6 HDi (80 kW)	2008.04-	Box Engine 9HZ(DV6TED4)	•		GHA425022	
	2008.04-	Box Engine 9HZ(DV6TED4)	•		GWB3584	
	2008.04-	Box Engine 9HZ(DV6TED4)		◦	GWB6549	
1.6 HDi (82 kW)	2010.08-	Box	•		GWB3584	
	2010.08-	Box		◦	GWB6549	
1.6 HDi (84 kW)	2013.03-	Box Engine 9HL(DV6C)	•		GHA425022	
	2013.03-	Box Engine 9HL(DV6C)	•		GWB3584	
	2013.03-	Box Engine 9HL(DV6C)		◦	GWB6549	
1.6 HDi 16V (66 kW)	2009.01-	Platform/Chassis Engine 9HS(DV6TED4BU)/9HX(DV6ATED4)	•		GHA425022	
	2009.01-	Platform/Chassis Engine 9HS(DV6TED4BU)/9HX(DV6ATED4)	•		GWB3584	
	2009.01-	Platform/Chassis Engine 9HS(DV6TED4BU)/9HX(DV6ATED4)		◦	GHA230148	K
	2009.01-	Platform/Chassis Engine 9HS(DV6TED4BU)/9HX(DV6ATED4)		◦	GWB6549	
1.6 HDi 16V 4x4 (66 kW)	2012.04-	Box Engine 9HS(DV6TED4BU)/9HX(DV6ATED4)	•		GHA425022	
	2012.04-	Box Engine 9HS(DV6TED4BU)/9HX(DV6ATED4)	•		GWB3584	
	2012.04-	Box Engine 9HS(DV6TED4BU)/9HX(DV6ATED4)		◦	GWB6549	
ectrique (49 kW)	2013.06-	Box	•		GWB3584	
	2013.06-	Box		◦	GWB6549	
PARTNER (5)						
1.6 (80 kW)	2000.09-2002.10	Box Engine NFU(TU5JP4)	•		GHA425022	
	2000.09-2002.10	Box Engine NFU(TU5JP4)	•		GWB0915	
	2000.09-2002.10	Box Engine NFU(TU5JP4)		◦	GHA232028	K
	2000.09-2002.10	Box Engine NFU(TU5JP4) With ABS		◦	GHA232032	K
	2000.09-2002.10	Box Engine NFU(TU5JP4) Without ABS		◦	GHA232012	K



	 YEAR		F	R	G-AP Ref.	KIT
PEUGEOT						
PARTNER (5)						
1.9 D (50 kW)	1996.05-1998.12	Box Engine DJY(XUD9A)	•		GHA425022	
	1996.05-1998.12	Box Engine DJY(XUD9A)	•		GWB0915	
	1996.05-1998.12	Box Engine DJY(XUD9A)		○	GHA232028	K
	1996.05-1998.12	Box Engine DJY(XUD9A)		○	GHA232033	K
	1996.05-1998.12	Box Engine DJY(XUD9A) Without ABS		○	GHA232011	K
2.0 HDi 4x4 (66 kW)	2004.04-	Box Engine RHY(DW10TD)	•		GHA425022	
	2004.04-	Box Engine RHY(DW10TD)	•		GWB0915	
	2004.04-	Box Engine RHY(DW10TD)		○	GHA232021	K
	2004.04-	Box Engine RHY(DW10TD)		○	GHA232028	K
	2004.04-	Box Engine RHY(DW10TD) With ABS		○	GHA232032	K
Electric (25 kW)	1996.04-2002.12	Box Engine RHY(DW10TD) Without ABS		○	GHA232012	K
	1996.04-2002.12	Box	•		GHA425022	
	1996.04-2002.12	Box	•		GWB0915	
	1996.04-2002.12	Box		○	GHA232028	K
	1996.04-2002.12	Box		○	GHA232033	K
	1996.04-2002.12	Box With ABS		○	GHA232032	K
PARTNER (5F)	1996.04-2002.12	Box Without ABS		○	GHA232011	K
	1996.04-2002.12	Box Without ABS		○	GHA232012	K
	1998.01-2001.12	MPV	•		GHA425022	
	1998.01-2001.12	MPV	•		GWB0915	
	1998.01-2001.12	MPV		○	GHA232028	K
	1998.01-2001.12	MPV		○	GHA232033	K
PARTNER BOX (5)	1998.01-2001.12	MPV With ABS		○	GHA232032	K
	1998.01-2001.12	MPV Without ABS		○	GHA232011	K
	1998.01-2001.12	MPV Without ABS		○	GHA232012	K
	2002.11-2006.1	Box Engine KFV (TU3A)	•		GHA425022	
	2002.11-2006.1	Box Engine KFV (TU3A)	•		GWB0915	
	2002.11-2006.1	Box Engine KFV (TU3A)		○	GHA232021	K
PARTNER COMBISPACE (5F)	2002.11-2006.1	Box Engine KFV (TU3A)		○	GHA232028	K
	2002.11-2006.1	Box Engine KFV (TU3A) With ABS		○	GHA232032	K
	2002.11-2006.1	Box Engine KFV (TU3A) Without ABS		○	GHA232012	K
	1996.06-	MPV Engine HDZ(TU1M)	•		GHA425022	
	1996.06-	MPV Engine HDZ(TU1M)	•		GWB0915	
	1996.06-	MPV Engine HDZ(TU1M)		○	GHA232021	K
1.4 (54 kW)	1996.06-	MPV Engine HDZ(TU1M)		○	GHA232028	K
	1996.06-	MPV Engine HDZ(TU1M)		○	GHA232033	K
	1996.06-	MPV Engine HDZ(TU1M) With ABS		○	GHA232032	K
	1996.06-	MPV Engine HDZ(TU1M) Without ABS		○	GHA232011	K
	1996.06-	MPV Engine HDZ(TU1M) Without ABS		○	GHA232012	K
	2002.11-2006.10	MPV Engine KFW(TU3JP)	•		GHA425022	
	2002.11-2006.10	MPV Engine KFW(TU3JP)	•		GWB0915	
	2002.11-2006.10	MPV Engine KFW(TU3JP)		○	GHA232021	K
1.4 (55 kW)	2002.11-2006.10	MPV Engine KFW(TU3JP)		○	GHA232028	K
	2002.11-2006.10	MPV Engine KFW(TU3JP) With ABS		○	GHA232032	K
	2002.11-2006.10	MPV Engine KFW(TU3JP) Without ABS		○	GHA232012	K
	1996.06-	MPV Engine KFW(TU3JP)/KFX(TU3JP)/TU32	•		GHA425022	
	1996.06-	MPV Engine KFW(TU3JP)/KFX(TU3JP)/TU32	•		GWB0915	
	1996.06-	MPV Engine KFW(TU3JP)/KFX(TU3JP)/TU32		○	GHA232021	K
	1996.06-	MPV Engine KFW(TU3JP)/KFX(TU3JP)/TU32		○	GHA232028	K
	1996.06-	MPV Engine KFW(TU3JP)/KFX(TU3JP)/TU32		○	GHA232033	K
	1996.06-	MPV Engine KFW(TU3JP)/KFX(TU3JP)/TU32 With ABS		○	GHA232032	K
	1996.06-	MPV Engine KFW(TU3JP)/KFX(TU3JP)/TU32 Without ABS		○	GHA232011	K
1.6 16V (80 kW)	1996.06-	MPV Engine KFW(TU3JP)/KFX(TU3JP)/TU32 Without ABS		○	GHA232012	K
	2001.07-	MPV Engine NFU(TU5JP4)	•		GHA425022	
	2001.07-	MPV Engine NFU(TU5JP4)	•		GWB0915	
	2001.07-	MPV Engine NFU(TU5JP4)		○	GHA232021	K
	2001.07-	MPV Engine NFU(TU5JP4)		○	GHA232028	K
	2001.07-	MPV Engine NFU(TU5JP4) With ABS		○	GHA232032	K
1.6 HDi (55 kW)	2001.07-	MPV Engine NFU(TU5JP4) Without ABS		○	GHA232012	K
	2006.02-	MPV Engine 9HW(DV6BTD4)	•		GHA425022	
	2006.02-	MPV Engine 9HW(DV6BTD4)	•		GWB0915	



	 YEAR		F	R	G-AP Ref.	KIT
PEUGEOT						
PARTNER COMBISPACE (5F)						
1.6 HDi (55 kW)	2006.02-	MPV Engine 9HW(DV6BTED4)		o	GHA232021	K
	2006.02-	MPV Engine 9HW(DV6BTED4) With ABS		o	GHA232032	K
	2006.02-	MPV Engine 9HW(DV6BTED4) Without ABS		o	GHA232012	K
1.6 HDi (66 kW)	2005.10-	MPV Engine 9HX(DV6ATED4)	•		GHA425022	
	2005.10-	MPV Engine 9HX(DV6ATED4)	•		GWB0915	
	2005.10-	MPV Engine 9HX(DV6ATED4)		o	GHA232021	K
	2005.10-	MPV Engine 9HX(DV6ATED4) With ABS		o	GHA232032	K
	2005.10-	MPV Engine 9HX(DV6ATED4) Without ABS		o	GHA232012	K
1.8 (66 kW)	1997.05-	MPV Engine LFX(XU7JB)	•		GHA425022	
	1997.05-	MPV Engine LFX(XU7JB)	•		GWB0915	
	1997.05-	MPV Engine LFX(XU7JB)		o	GHA232021	K
	1997.05-	MPV Engine LFX(XU7JB)		o	GHA232028	K
	1997.05-	MPV Engine LFX(XU7JB)		o	GHA232033	K
	1997.05-	MPV Engine LFX(XU7JB) With ABS		o	GHA232032	K
	1997.05-	MPV Engine LFX(XU7JB) Without ABS		o	GHA232011	K
	1997.05-	MPV Engine LFX(XU7JB) Without ABS		o	GHA232012	K
1.9 D (50 kW)	1996.06-	MPV Engine DJY(XUD9A)	•		GHA425022	
	1996.06-	MPV Engine DJY(XUD9A)	•		GWB0915	
	1996.06-	MPV Engine DJY(XUD9A)		o	GHA232021	K
	1996.06-	MPV Engine DJY(XUD9A)		o	GHA232028	K
	1996.06-	MPV Engine DJY(XUD9A)		o	GHA232033	K
	1996.06-	MPV Engine DJY(XUD9A) With ABS		o	GHA232032	K
	1996.06-	MPV Engine DJY(XUD9A) Without ABS		o	GHA232011	K
	1996.06-	MPV Engine DJY(XUD9A) Without ABS		o	GHA232012	K
1.9 D (51 kW)	1996.05-1998.12	MPV Engine XUD9	•		GHA425022	
	1996.05-1998.12	MPV Engine XUD9	•		GWB0915	
	1996.05-1998.12	MPV Engine XUD9		o	GHA232028	K
	1996.05-1998.12	MPV Engine XUD9		o	GHA232033	K
	1996.05-1998.12	MPV Engine XUD9 Without ABS		o	GHA232011	K
	2001.06-2005.10	MPV Engine WJY(DW8B)/WJZ(DW8)	•		GHA425022	
	2001.06-2005.10	MPV Engine WJY(DW8B)/WJZ(DW8)	•		GWB0915	
	2001.06-2005.10	MPV Engine WJY(DW8B)/WJZ(DW8)		o	GHA232021	K
	2001.06-2005.10	MPV Engine WJY(DW8B)/WJZ(DW8)		o	GHA232028	K
	2001.06-2005.10	MPV Engine WJY(DW8B)/WJZ(DW8)		o	GHA232033	K
	2001.06-2005.10	MPV Engine WJY(DW8B)/WJZ(DW8) With ABS		o	GHA232032	K
	2001.06-2005.10	MPV Engine WJY(DW8B)/WJZ(DW8) Without ABS		o	GHA232011	K
	2001.06-2005.10	MPV Engine WJY(DW8B)/WJZ(DW8) Without ABS		o	GHA232012	K
1.9 D 4x4 (51 kW)	2004.04-2005.08	MPV Engine WJY(DW8B)	•		GHA425022	
	2004.04-2005.08	MPV Engine WJY(DW8B)	•		GWB0915	
	2004.04-2005.08	MPV Engine WJY(DW8B)		o	GHA232021	K
	2004.04-2005.08	MPV Engine WJY(DW8B)		o	GHA232028	K
	2004.04-2005.08	MPV Engine WJY(DW8B) With ABS		o	GHA232032	K
	2004.04-2005.08	MPV Engine WJY(DW8B) Without ABS		o	GHA232012	K
2.0 HDi (66 kW)	2000.02-	MPV Engine RHY(DW10TD)	•		GHA425022	
	2000.02-	MPV Engine RHY(DW10TD)	•		GWB0915	
	2000.02-	MPV Engine RHY(DW10TD)		o	GHA232021	K
	2000.02-	MPV Engine RHY(DW10TD)		o	GHA232028	K
	2000.02-	MPV Engine RHY(DW10TD) With ABS		o	GHA232032	K
	2000.02-	MPV Engine RHY(DW10TD) Without ABS		o	GHA232012	K
2.0 HDi 4x4 (66 kW)	2004.04-2005.08	MPV Engine RHY(DW10TD)	•		GHA425022	
	2004.04-2005.08	MPV Engine RHY(DW10TD)	•		GWB0915	
	2004.04-2005.08	MPV Engine RHY(DW10TD)		o	GHA232021	K
	2004.04-2005.08	MPV Engine RHY(DW10TD)		o	GHA232028	K
	2004.04-2005.08	MPV Engine RHY(DW10TD) With ABS		o	GHA232032	K
	2004.04-2005.08	MPV Engine RHY(DW10TD) Without ABS		o	GHA232012	K
PARTNER TEPEE						
1.6 (66 kW)	2008.04-	MPV Engine NFR(TU5JP4B)	•		GHA425022	
	2008.04-	MPV Engine NFR(TU5JP4B)	•		GWB3584	
	2008.04-	MPV Engine NFR(TU5JP4B)		o	GHA230148	K
	2008.04-	MPV Engine NFR(TU5JP4B)		o	GWB6549	
1.6 (72 kW)	2010.08-	MPV Engine 5FK (EP6CB)	•		GHA425022	
	2010.08-	MPV Engine 5FK (EP6CB)	•		GWB3584	
	2010.08-	MPV Engine 5FK (EP6CB)		o	GHA230148	K
	2010.08-	MPV Engine 5FK (EP6CB)		o	GWB6549	



	 YEAR		F	R	G-AP Ref.	KIT
PEUGEOT PARTNER TEPEE						
1.6 (80 kW)	2008.04-	MPV Engine NFU(TU5JP4)	•		GHA425022	
	2008.04-	MPV Engine NFU(TU5JP4)	•		GWB3584	
	2008.04-	MPV Engine NFU(TU5JP4)		◦	GHA230148	K
	2008.04-	MPV Engine NFU(TU5JP4)		◦	GWB6549	
1.6 (81 kW)	2008.09-	MPV Engine NFU(TU5JP4)	•		GHA425022	
	2008.09-	MPV Engine NFU(TU5JP4)	•		GWB3584	
	2008.09-	MPV Engine NFU(TU5JP4)		◦	GWB6549	
1.6 (88 kW)	2010.04-	MPV Engine 5FS(EP6C)	•		GHA425022	
	2010.04-	MPV Engine 5FS(EP6C)	•		GWB3584	
	2010.04-	MPV Engine 5FS(EP6C)		◦	GHA230148	K
	2010.04-	MPV Engine 5FS(EP6C)		◦	GWB6549	
1.6 BlueHDi 100 (73 kW)	2014.12-	MPV Engine BHY(DV6FD)	•		GWB3584	
	2014.12-	MPV Engine BHY(DV6FD)		◦	GWB6549	
1.6 BlueHDi 120 (88 kW)	2014.12-	MPV Engine BHZ (DV6FC)	•		GWB3584	
	2014.12-	MPV Engine BHZ (DV6FC)		◦	GWB6549	
1.6 HDi (55 kW)	2008.04-	MPV Engine 9HT(DV6BTED4)	•		GHA425022	
	2008.04-	MPV Engine 9HT(DV6BTED4)	•		GWB3584	
	2008.04-	MPV Engine 9HT(DV6BTED4)		◦	GHA230148	K
	2008.04-	MPV Engine 9HT(DV6BTED4)		◦	GWB6549	
1.6 HDi (66 kW)	2008.04-	MPV Engine 9HX(DV6ATED4)/9HV(DV6TED4)	•		GHA425022	
	2008.04-	MPV Engine 9HX(DV6ATED4)/9HV(DV6TED4)	•		GWB3584	
	2008.04-	MPV Engine 9HX(DV6ATED4)/9HV(DV6TED4)		◦	GHA230148	K
	2008.04-	MPV Engine 9HX(DV6ATED4)/9HV(DV6TED4)		◦	GWB6549	
	2013.03-	MPV Engine 9HF (DV6DTEd)	•		GWB3584	
1.6 HDi (68 kW)	2010.04-	MPV Engine 9HP(DV6TED)	•		GHA425022	
	2010.04-	MPV Engine 9HP(DV6TED)	•		GWB3584	
	2010.04-	MPV Engine 9HP(DV6TED)		◦	GHA230148	K
	2010.04-	MPV Engine 9HP(DV6TED)		◦	GWB6549	
1.6 HDi (80 kW)	2008.04-	MPV Engine 9HZ(DV6ATED4)	•		GHA425022	
	2008.04-	MPV Engine 9HZ(DV6ATED4)	•		GWB3584	
	2008.04-	MPV Engine 9HZ(DV6ATED4)		◦	GHA230148	K
	2008.04-	MPV Engine 9HZ(DV6ATED4)		◦	GWB6549	
1.6 HDi (82 kW)	2010.08-	MPV Engine 9HL(DV6C)	•		GHA425022	
	2010.08-	MPV Engine 9HL(DV6C)	•		GWB3584	
	2010.08-	MPV Engine 9HL(DV6C)		◦	GWB6549	
1.6 HDi (84 kW)	2013.03-	MPV Engine 9HL(DV6C)	•		GHA425022	
	2013.03-	MPV Engine 9HL(DV6C)	•		GWB3584	
	2013.03-	MPV Engine 9HL(DV6C)		◦	GHA230148	K
	2013.03-	MPV Engine 9HL(DV6C)		◦	GWB6549	
PARTNER VAN (5)						
1.1 (44 kW)	1996.06-	Box Engine HDZ(TU1M)	•		GHA425022	
	1996.06-	Box Engine HDZ(TU1M)	•		GWB0915	
	1996.06-	Box Engine HDZ(TU1M)		◦	GHA232021	K
	1996.06-	Box Engine HDZ(TU1M)		◦	GHA232028	K
	1996.06-	Box Engine HDZ(TU1M)		◦	GHA232033	K
	1996.06-	Box Engine HDZ(TU1M) With ABS		◦	GHA232032	K
	1996.06-	Box Engine HDZ(TU1M) Without ABS		◦	GHA232011	K
	1996.06-	Box Engine HDZ(TU1M) Without ABS		◦	GHA232012	K
1.4 (55 kW)	1996.06-	Box Engine KFX(TU3JP)/TU32	•		GHA425022	
	1996.06-	Box Engine KFX(TU3JP)/TU32	•		GWB0915	
	1996.06-	Box Engine KFX(TU3JP)/TU32		◦	GHA232021	K
	1996.06-	Box Engine KFX(TU3JP)/TU32		◦	GHA232028	K
	1996.06-	Box Engine KFX(TU3JP)/TU32		◦	GHA232033	K
	1996.06-	Box Engine KFX(TU3JP)/TU32 With ABS		◦	GHA232032	K
	1996.06-	Box Engine KFX(TU3JP)/TU32 Without ABS		◦	GHA232011	K
	1996.06-	Box Engine KFX(TU3JP)/TU32 Without ABS		◦	GHA232012	K
1.4 BiFuel (55 kW)	2003.04-	Box Engine KFW(TU3JP)	•		GHA425022	
	2003.04-	Box Engine KFW(TU3JP)	•		GWB0915	
	2003.04-	Box Engine KFW(TU3JP)		◦	GHA232021	K
	2003.04-	Box Engine KFW(TU3JP)		◦	GHA232028	K
	2003.04-	Box Engine KFW(TU3JP) With ABS		◦	GHA232032	K
2003.04-	Box Engine KFW(TU3JP) Without ABS		◦	GHA232012	K	
1.6 HDi (55 kW)	2006.02-	Box Engine 9HW(DV6BTED4)	•		GHA425022	



	 YEAR		F	R	G-AP Ref.	KIT
PEUGEOT						
PARTNER VAN (5)						
1.6 HDi (55 kW)	2006.02-	Box Engine 9HW(DV6BTED4)	•		GWB0915	
	2006.02-	Box Engine 9HW(DV6BTED4)		◦	GHA232021	K
	2006.02-	Box Engine 9HW(DV6BTED4) With ABS		◦	GHA232032	K
	2006.02-	Box Engine 9HW(DV6BTED4) Without ABS		◦	GHA232012	K
1.6 HDi (66 kW)	2006.02-	Box Engine 9HX(DV6ATED4)	•		GHA425022	
	2006.02-	Box Engine 9HX(DV6ATED4)	•		GWB0915	
	2006.02-	Box Engine 9HX(DV6ATED4)		◦	GHA232021	K
	2006.02-	Box Engine 9HX(DV6ATED4) With ABS		◦	GHA232032	K
	2006.02-	Box Engine 9HX(DV6ATED4) Without ABS		◦	GHA232012	K
1.8 (66 kW)	1997.03-2000.08	Box Engine LFX(XU7JB)	•		GHA425022	
	1997.03-2000.08	Box Engine LFX(XU7JB)	•		GWB0915	
	1997.03-2000.08	Box Engine LFX(XU7JB)		◦	GHA232028	K
	1997.03-2000.08	Box Engine LFX(XU7JB) With ABS		◦	GHA232032	K
	1997.03-2000.08	Box Engine LFX(XU7JB) Without ABS		◦	GHA232012	K
1.8 D (43 kW)	1996.06-	Box Engine A9A(XUD7)	•		GHA425022	
	1996.06-	Box Engine A9A(XUD7)	•		GWB0915	
	1996.06-	Box Engine A9A(XUD7)		◦	GHA232021	K
	1996.06-	Box Engine A9A(XUD7)		◦	GHA232028	K
	1996.06-	Box Engine A9A(XUD7)		◦	GHA232033	K
	1996.06-	Box Engine A9A(XUD7) With ABS		◦	GHA232032	K
	1996.06-	Box Engine A9A(XUD7) Without ABS		◦	GHA232011	K
	1996.06-	Box Engine A9A(XUD7) Without ABS		◦	GHA232012	K
1.8 D (44 kW)	1996.11-1998.02	Box Engine A9A(XUD7)	•		GHA425022	
	1996.11-1998.02	Box Engine A9A(XUD7)	•		GWB0915	
	1996.11-1998.02	Box Engine A9A(XUD7)		◦	GHA232028	K
	1996.11-1998.02	Box Engine A9A(XUD7)		◦	GHA232033	K
	1996.11-1998.02	Box Engine A9A(XUD7) Without ABS		◦	GHA232011	K
1.9 D (51 kW)	1996.06-	Box Engine DJY(XUD9A)	•		GHA425022	
	1996.06-	Box Engine DJY(XUD9A)	•		GWB0915	
	1996.06-	Box Engine DJY(XUD9A)		◦	GHA232021	K
	1996.06-	Box Engine DJY(XUD9A)		◦	GHA232028	K
	1996.06-	Box Engine DJY(XUD9A)		◦	GHA232033	K
	1996.06-	Box Engine DJY(XUD9A) With ABS		◦	GHA232032	K
	1996.06-	Box Engine DJY(XUD9A) Without ABS		◦	GHA232011	K
	1996.06-	Box Engine DJY(XUD9A) Without ABS		◦	GHA232012	K
	1996.06-	Box Engine WJY(DW8B)/WJZ(DW8)	•		GHA425022	
	1996.06-	Box Engine WJY(DW8B)/WJZ(DW8)	•		GWB0915	
	1996.06-	Box Engine WJY(DW8B)/WJZ(DW8)		◦	GHA232021	K
	1996.06-	Box Engine WJY(DW8B)/WJZ(DW8)		◦	GHA232028	K
	1996.06-	Box Engine WJY(DW8B)/WJZ(DW8)		◦	GHA232033	K
	1996.06-	Box Engine WJY(DW8B)/WJZ(DW8) With ABS		◦	GHA232032	K
	1996.06-	Box Engine WJY(DW8B)/WJZ(DW8) Without ABS		◦	GHA232011	K
1996.06-	Box Engine WJY(DW8B)/WJZ(DW8) Without ABS		◦	GHA232012	K	
1.9 D 4x4 (51 kW)	2004.04-	Box Engine WJY(DW8B)	•		GHA425022	
	2004.04-	Box Engine WJY(DW8B)	•		GWB0915	
	2004.04-	Box Engine WJY(DW8B)		◦	GHA232021	K
	2004.04-	Box Engine WJY(DW8B)		◦	GHA232028	K
	2004.04-	Box Engine WJY(DW8B) With ABS		◦	GHA232032	K
	2004.04-	Box Engine WJY(DW8B) Without ABS		◦	GHA232012	K
	2004.04-	Box Engine WJY(DW8B) Without ABS		◦	GHA232011	K
2.0 HDi (66 kW)	2000.04-	Box Engine RHY(DW10TD)	•		GHA425022	
	2000.04-	Box Engine RHY(DW10TD)	•		GWB0915	
	2000.04-	Box Engine RHY(DW10TD)		◦	GHA232021	K
	2000.04-	Box Engine RHY(DW10TD)		◦	GHA232028	K
	2000.04-	Box Engine RHY(DW10TD) With ABS		◦	GHA232032	K
	2000.04-	Box Engine RHY(DW10TD) Without ABS		◦	GHA232012	K
RCZ						
1.6 16V (115 kW)	2010.03-	Coupe Engine EP6CDT	•		GWB3584	
	2010.03-	Coupe Engine EP6CDT	•		GWB3683	
	2010.03-	Coupe Engine EP6CDT		◦	GHA232038	K
1.6 16V (147 kW)	2010.06-	Coupe Engine EP6CDTX	•		GWB3584	
	2010.06-	Coupe Engine EP6CDTX	•		GWB3683	
	2010.06-	Coupe Engine EP6CDTX		◦	GHA232038	K
1.6 THP (199 kW)	2013.06-	Coupe Engine 5FG(EP6CDTR)	•		GWB3584	
	2013.06-	Coupe Engine 5FG(EP6CDTR)	•		GWB3683	



	 YEAR		F	R	G-AP Ref.	KIT
PEUGEOT						
RCZ						
1.6 THP (199 kW)	2013.06-	Coupe Engine 5FG(EP6CDTR)		o	GHA232038	K
2.0 HDi (120 kW)	2010.03-	Coupe Engine RHH(DW10CTED4)	•		GWB3584	
	2010.03-	Coupe Engine RHH(DW10CTED4)	•		GWB3683	
	2010.03-	Coupe Engine RHH(DW10CTED4)		o	GHA232038	K
PLYMOUTH						
BREEZE						
2.0 16V (98 kW)	1995.12-2001.04	Saloon Engine ECB		o	GHA228011	
NEON						
2.0 16V (107 kW)	1994.06-1999.08	Saloon Engine ECC		o	GHA228073	
2.0 16V (112 kW)	1996.04-1999.08	Saloon Engine ECC		o	GHA228073	
2.0 16V (98 kW)	1994.05-1999.08	Saloon Engine ECB		o	GHA228073	
NEON II						
2.0 16V (112 kW)	1999.09-	Saloon Engine ECH	•		GWB6590	
	1999.09-	Saloon Engine ECH	•		GWB6591	
	1999.09-	Saloon Engine ECH With ABS		o	GHA228048	
	1999.09-	Saloon Engine ECH Without ABS		o	GHA228013	
2.0 16V (98 kW)	1999.08-	Saloon Engine ECB	•		GWB6590	
	1999.08-	Saloon Engine ECB	•		GWB6591	
	1999.08-	Saloon Engine ECB With ABS		o	GHA228048	
	1999.08-	Saloon Engine ECB Without ABS		o	GHA228013	
VOYAGER / GRAN VOYAGER						
3.8 i AWD (122 kW)	1995.01-2001.03	MPV Engine EGH		o	GHA326016	
PONTIAC						
BONNEVILLE						
3.8 V6 (149 kW)	1991.09-	Saloon Engine L36	•		GHA333006	
	1991.09-	Saloon Engine L36	•		GHA333083	K
GRAND AM						
-	1999-2005			o	GHA400016	
TRANS SPORT						
3.4 (134 kW)	1997.03-1998.09	MPV Engine LA1	•		GHA333083	K
	1997.03-1998.09	MPV Engine LA1		o	GHA400313	
3.4 (137 kW)	1998.09-1999.12	MPV Engine LA1	•		GHA333083	K
	1998.09-1999.12	MPV Engine LA1		o	GHA400313	
VIBE						
-	2009-2010			o	GHA400309	
PORSCHE						
CAYENNE (955)						
3.0 TDi (176 kW)	2009.02-	Closed Off-Road Vehicle Engine M05.9D	•		GWB3645	
3.2 (184 kW)	2003.08-	Closed Off-Road Vehicle Engine M02.2Y	•		GWB3645	
3.6 (213 kW)	2006.12-	Closed Off-Road Vehicle Engine M55.01	•		GWB3645	
4.5 Turbo (331 kW)	2002.09-	Closed Off-Road Vehicle Engine M48.50	•		GWB3645	
4.5 Turbo S (368 kW)	2004.01-	Closed Off-Road Vehicle Engine M48.50S	•		GWB3645	
4.5 Turbo S (383 kW)	2006.02-	Closed Off-Road Vehicle	•		GWB3645	
4.8 GTS (298 kW)	2007.12-	Closed Off-Road Vehicle Engine M48.01	•		GWB3645	
4.8 Turbo S (368 kW)	2006.12-	Closed Off-Road Vehicle Engine M48.51	•		GWB3645	
4.8 Turbo S (397 kW)	2007.02-	Closed Off-Road Vehicle	•		GWB3645	
4.8 Turbo S (404 kW)	2008.08-	Closed Off-Road Vehicle	•		GWB3645	
S 4.5 (250 kW)	2002.09-	Closed Off-Road Vehicle Engine M48.00	•		GWB3645	
S 4.8 (283 kW)	2006.12-	Closed Off-Road Vehicle Engine M48.01	•		GWB3645	
PROTON						
IMPIAN						
1.6 (76 kW)	2001.09-	Saloon Engine 4 G 18 P		o	GHA230084	K
RAM						
DAKOTA						
-	2011-		•		GHA333090	
RENAULT						
19 (D53_)						
1.7 (70 kW)	1991.07-1992.04	Convertible Engine F3N742/F3N743	•		GHA421004	A



	 YEAR		F	R	G-AP Ref.	KIT
RENAULT						
19 (D53_)						
1.7 (70 kW)	1991.07-1992.04	Convertible Engine F3N742/F3N743	•		GWB3596	
	1991.07-1992.04	Convertible Engine F3N742/F3N743		○	GWB0969	
	1991.07-1992.04	Convertible Engine F3N742/F3N743		○	GWB3525	
1.8 16V (101 kW)	1991.07-1992.04	Convertible Engine F7P704	•		GHA421004	A
	1991.07-1992.04	Convertible Engine F7P704	•		GWB3596	
	1991.07-1992.04	Convertible Engine F7P704		○	GWB0969	
	1991.07-1992.04	Convertible Engine F7P704		○	GWB3525	
19 (L53_)						
1.9 TD (68 kW)	1990.09-1992.04	Saloon Engine F8Q740	•		GHA421004	A
	1990.09-1992.04	Saloon Engine F8Q740	•		GWB3596	
	1990.09-1992.04	Saloon Engine F8Q740		○	GWB0969	
	1990.09-1992.04	Saloon Engine F8Q740		○	GWB3525	
19 I (B/C53_)						
1.4 (55 kW)	1990.09-1992.04	Hatchback Engine E7J 700	•		GHA421004	A
	1990.09-1992.04	Hatchback Engine E7J 700	•		GWB3596	
	1990.09-1992.04	Hatchback Engine E7J 700		○	GWB3525	
1.9 DT (68 kW)	1990.09-1992.04	Hatchback Engine F8Q 610	•		GHA421004	A
	1990.09-1992.04	Hatchback Engine F8Q 610	•		GWB3596	
	1990.09-1992.04	Hatchback Engine F8Q 610		○	GWB0969	
	1990.09-1992.04	Hatchback Engine F8Q 610		○	GWB3525	
19 I CABRIOLET (D53_)						
1.7 (66 kW)	1991.07-1992.04	Convertible Engine F3N 742/F3N 743	•		GHA421004	A
19 I CHAMADE (L53_)						
1.4 (55 kW)	1990.09-1992.04	Saloon Engine E7J 700	•		GHA421004	A
1.7 (69 kW)	1990.09-1992.04	Saloon Engine F2N 721	•		GHA421004	A
	1990.09-1992.04	Saloon Engine F2N 721	•		GWB3596	
	1990.09-1992.04	Saloon Engine F2N 721		○	GWB0969	
	1990.09-1992.04	Saloon Engine F2N 721		○	GWB3525	
19 II (B/C53_)						
1.2 (40 kW)	1992.04-1995.12	Hatchback Engine C1G730	•		GWB3496	
	1992.04-1995.12	Hatchback Engine C1G730	•		GWB3596	
	1992.04-1995.12	Hatchback Engine C1G730		○	GWB3525	
1.2 (44 kW)	1992.05-1994.09	Hatchback Engine E7F730	•		GHA421004	A
	1992.05-1994.09	Hatchback Engine E7F730	•		GWB3496	
	1992.05-1994.09	Hatchback Engine E7F730		○	GWB3525	
1.4 (43 kW)	1992.04-1995.12	Hatchback Engine C3J710	•		GWB3496	
	1992.04-1995.12	Hatchback Engine C3J710	•		GWB3596	
	1992.04-1995.12	Hatchback Engine C3J710		○	GWB3525	
1.4 (55 kW)	1992.01-1995.12	Hatchback Engine E7J742	•		GHA421004	A
	1992.01-1995.12	Hatchback Engine E7J742	•		GWB3596	
	1992.01-1995.12	Hatchback Engine E7J742		○	GWB0969	
	1992.01-1995.12	Hatchback Engine E7J742		○	GWB3525	
1.4 (59 kW)	1992.01-1995.12	Hatchback Engine E6J700/E7J706	•		GHA421004	A
	1992.01-1995.12	Hatchback Engine E6J700/E7J706	•		GWB3596	
	1992.01-1995.12	Hatchback Engine E6J700/E7J706		○	GWB3525	
1.4 (60 kW)	1996.10-2001.06	Hatchback Engine E6J 706	•		GHA421004	A
	1996.10-2001.06	Hatchback Engine E6J 706	•		GWB3596	
	1996.10-2001.06	Hatchback Engine E6J 706		○	GWB3525	
1.7 (54 kW)	1992.04-1995.12	Hatchback Engine F3N740/F3N741	•		GHA421004	A
	1992.04-1995.12	Hatchback Engine F3N740/F3N741	•		GWB3596	
	1992.04-1995.12	Hatchback Engine F3N740/F3N741		○	GWB0969	
	1992.04-1995.12	Hatchback Engine F3N740/F3N741		○	GWB3525	
1.7 (66 kW)	1992.04-1995.12	Hatchback Engine F3N743	•		GHA421004	A
	1992.04-1995.12	Hatchback Engine F3N743	•		GWB3596	
	1992.04-1995.12	Hatchback Engine F3N743		○	GWB0969	
	1992.04-1995.12	Hatchback Engine F3N743		○	GWB3525	
1.7 (69 kW)	1996.10-2001.06	Hatchback Engine F3N 747	•		GWB3596	
	1996.10-2001.06	Hatchback Engine F3N 747		○	GWB0969	
	1996.10-2001.06	Hatchback Engine F3N 747		○	GWB3525	
1.7 (79 kW)	1992.05-1994.09	Hatchback Engine F3N 746	•		GHA421004	A
	1992.05-1994.09	Hatchback Engine F3N 746	•		GWB3596	
	1992.05-1994.09	Hatchback Engine F3N 746		○	GWB0969	
	1992.05-1994.09	Hatchback Engine F3N 746		○	GWB3525	



	 YEAR		F	R	G-AP Ref.	KIT
RENAULT						
19 II (B/C53_)						
1.8 (65 kW)	1992.04-1995.12	Hatchback Engine F3P706/F3P707/F3P708/F3P760	•		GHA421004	A
	1992.04-1995.12	Hatchback Engine F3P706/F3P707/F3P708/F3P760	•		GWB3596	
	1992.04-1995.12	Hatchback Engine F3P706/F3P707/F3P708/F3P760		○	GWB0969	
	1992.04-1995.12	Hatchback Engine F3P706/F3P707/F3P708/F3P760		○	GWB3525	
1.8 (66 kW)	1992.04-1995.12	Hatchback Engine F3P706/F3P760	•		GHA421004	A
	1992.04-1995.12	Hatchback Engine F3P706/F3P760	•		GWB3596	
	1992.04-1995.12	Hatchback Engine F3P706/F3P760		○	GWB0969	
	1992.04-1995.12	Hatchback Engine F3P706/F3P760		○	GWB3525	
1.8 (79 kW)	1994.05-1995.12	Hatchback Engine F3P682/F3P765	•		GHA421004	A
	1994.05-1995.12	Hatchback Engine F3P682/F3P765	•		GWB3596	
	1994.05-1995.12	Hatchback Engine F3P682/F3P765		○	GWB0969	
	1994.05-1995.12	Hatchback Engine F3P682/F3P765		○	GWB3525	
1.8 (81 kW)	1992.04-1994.05	Hatchback Engine F3P700	•		GHA421004	A
	1992.04-1994.05	Hatchback Engine F3P700	•		GWB3596	
	1992.04-1994.05	Hatchback Engine F3P700		○	GWB0969	
	1992.04-1994.05	Hatchback Engine F3P700		○	GWB3525	
1.8 16V (99 kW)	1992.04-1995.12	Hatchback Engine F7P704	•		GHA421004	A
	1992.04-1995.12	Hatchback Engine F7P704	•		GWB3596	
	1992.04-1995.12	Hatchback Engine F7P704		○	GWB0969	
1.9 D (47 kW)	1992.04-1995.12	Hatchback Engine F8Q742	•		GHA421004	A
	1992.04-1995.12	Hatchback Engine F8Q742	•		GWB3596	
	1992.04-1995.12	Hatchback Engine F8Q742		○	GWB0969	
	1992.04-1995.12	Hatchback Engine F8Q742		○	GWB3525	
1.9 DT (66 kW)	1992.04-1995.12	Hatchback Engine F8Q744	•		GHA421004	A
	1992.04-1995.12	Hatchback Engine F8Q744	•		GWB3596	
	1992.04-1995.12	Hatchback Engine F8Q744		○	GWB0969	
	1992.04-1995.12	Hatchback Engine F8Q744		○	GWB3525	
19 II (D53_, 853_)						
1.7 (66 kW)	1992.04-1993.09	Convertible Engine F3N742/F3N743	•		GHA421004	A
	1992.04-1993.09	Convertible Engine F3N742/F3N743	•		GWB3596	
	1992.04-1993.09	Convertible Engine F3N742/F3N743		○	GWB0969	
	1992.04-1993.09	Convertible Engine F3N742/F3N743		○	GWB3525	
1.8 (65 kW)	1992.04-1996.06	Convertible Engine F3P704/F3P705/F3P706/F3P707/F3P708/F3P760	•		GHA421004	A
	1992.04-1996.06	Convertible Engine F3P704/F3P705/F3P706/F3P707/F3P708/F3P760	•		GWB3596	
	1992.04-1996.06	Convertible Engine F3P704/F3P705/F3P706/F3P707/F3P708/F3P760		○	GWB0969	
	1992.04-1996.06	Convertible Engine F3P704/F3P705/F3P706/F3P707/F3P708/F3P760		○	GWB3525	
1.8 (66 kW)	1993.09-1996.06	Convertible Engine F3P706/F3P760	•		GHA421004	A
	1993.09-1996.06	Convertible Engine F3P706/F3P760	•		GWB3596	
	1993.09-1996.06	Convertible Engine F3P706/F3P760		○	GWB0969	
	1993.09-1996.06	Convertible Engine F3P706/F3P760		○	GWB3525	
1.8 (79 kW)	1994.07-1996.06	Convertible Engine F3P682/F3P764/F3P765	•		GHA421004	A
	1994.07-1996.06	Convertible Engine F3P682/F3P764/F3P765	•		GWB3596	
	1994.07-1996.06	Convertible Engine F3P682/F3P764/F3P765		○	GWB0969	
	1994.07-1996.06	Convertible Engine F3P682/F3P764/F3P765		○	GWB3525	
1.8 16V (99 kW)	1992.04-1996.06	Convertible Engine F7P704	•		GHA421004	A
	1992.04-1996.06	Convertible Engine F7P704	•		GWB3596	
	1992.04-1996.06	Convertible Engine F7P704		○	GWB0969	
19 II (L53_)						
1.4 (43 kW)	1992.04-1995.12	Saloon Engine C3J710	•		GWB3496	
	1992.04-1995.12	Saloon Engine C3J710	•		GWB3596	
	1992.04-1995.12	Saloon Engine C3J710		○	GWB3525	
1.4 (55 kW)	1993.11-1995.12	Saloon Engine E7J742	•		GHA421004	A
	1993.11-1995.12	Saloon Engine E7J742	•		GWB3596	
	1993.11-1995.12	Saloon Engine E7J742		○	GWB0969	
	1993.11-1995.12	Saloon Engine E7J742		○	GWB3525	
1.4 (57 kW)	1994.10-1995.11	Saloon Engine E6J700	•		GHA421004	A
	1994.10-1995.11	Saloon Engine E6J700	•		GWB3596	
	1994.10-1995.11	Saloon Engine E6J700		○	GWB3525	
1.7 (54 kW)	1992.04-1995.12	Saloon Engine F3N740/F3N741	•		GHA421004	A
	1992.04-1995.12	Saloon Engine F3N740/F3N741	•		GWB3596	
	1992.04-1995.12	Saloon Engine F3N740/F3N741		○	GWB0969	
	1992.04-1995.12	Saloon Engine F3N740/F3N741		○	GWB3525	
1.7 (55 kW)	1992.05-1995.11	Saloon Engine F3N740/F3N741	•		GWB3596	
	1992.05-1995.11	Saloon Engine F3N740/F3N741		○	GWB0969	



	 YEAR		F	R	G-AP Ref.	KIT
RENAULT						
19 II (L53_)						
1.7 (55 kW)	1992.05-1995.11	Saloon Engine F3N740/F3N741		o	GWB3525	
1.7 (66 kW)	1992.04-1995.12	Saloon Engine F3N742/F3N743	•		GHA421004	A
	1992.04-1995.12	Saloon Engine F3N742/F3N743	•		GWB3596	
	1992.04-1995.12	Saloon Engine F3N742/F3N743		o	GWB0969	
	1992.04-1995.12	Saloon Engine F3N742/F3N743		o	GWB3525	
1.7 (68 kW)	1993.01-1995.08	Saloon Engine F2N720/F2N721	•		GHA421004	A
	1993.01-1995.08	Saloon Engine F2N720/F2N721	•		GWB3596	
	1993.01-1995.08	Saloon Engine F2N720/F2N721		o	GWB0969	
	1993.01-1995.08	Saloon Engine F2N720/F2N721		o	GWB3525	
1.8 (65 kW)	1992.04-1995.12	Saloon Engine F3P704/F3P705/F3P706/F3P707/F3P708/F3P760	•		GHA421004	A
	1992.04-1995.12	Saloon Engine F3P704/F3P705/F3P706/F3P707/F3P708/F3P760	•		GWB3596	
	1992.04-1995.12	Saloon Engine F3P704/F3P705/F3P706/F3P707/F3P708/F3P760		o	GWB0969	
	1992.04-1995.12	Saloon Engine F3P704/F3P705/F3P706/F3P707/F3P708/F3P760		o	GWB3525	
1.8 (66 kW)	1992.04-1995.12	Saloon Engine F3P706/F3P760	•		GHA421004	A
	1992.04-1995.12	Saloon Engine F3P706/F3P760	•		GWB3596	
	1992.04-1995.12	Saloon Engine F3P706/F3P760		o	GWB0969	
	1992.04-1995.12	Saloon Engine F3P706/F3P760		o	GWB3525	
1.8 (67 kW)	1992.05-1994.09	Saloon Engine F3P765	•		GHA421004	A
1.8 (79 kW)	1992.05-1995.11	Saloon Engine F3P700/F3P706	•		GWB3596	
	1992.05-1995.11	Saloon Engine F3P700/F3P706		o	GWB0969	
	1992.05-1995.11	Saloon Engine F3P700/F3P706		o	GWB3525	
	1994.05-1995.12	Saloon Engine F3P682	•		GHA421004	A
	1994.05-1995.12	Saloon Engine F3P682	•		GWB3596	
	1994.05-1995.12	Saloon Engine F3P682		o	GWB0969	
1.8 (81 kW)	1994.05-1995.12	Saloon Engine F3P682		o	GWB3525	
	1992.04-1994.05	Saloon Engine F3P700	•		GHA421004	A
	1992.04-1994.05	Saloon Engine F3P700	•		GWB3596	
	1992.04-1994.05	Saloon Engine F3P700		o	GWB0969	
	1992.04-1994.05	Saloon Engine F3P700		o	GWB3525	
1.8 16V (99 kW)	1992.04-1995.12	Saloon Engine F7P704	•		GHA421004	A
	1992.04-1995.12	Saloon Engine F7P704	•		GWB3596	
	1992.04-1995.12	Saloon Engine F7P704		o	GWB0969	
1.9 D (47 kW)	1992.04-1995.12	Saloon Engine F8Q742	•		GHA421004	A
	1992.04-1995.12	Saloon Engine F8Q742	•		GWB3596	
	1992.04-1995.12	Saloon Engine F8Q742		o	GWB0969	
	1992.04-1995.12	Saloon Engine F8Q742		o	GWB3525	
1.9 DT (66 kW)	1992.04-1995.12	Saloon Engine F8Q744	•		GWB3596	
	1992.04-1995.12	Saloon Engine F8Q744		o	GWB0969	
	1992.04-1995.12	Saloon Engine F8Q744		o	GWB3525	
19 II (S53_)						
1.2 (40 kW)	1992.03-1995.12	Box Engine C1G730	•		GWB3496	
	1992.03-1995.12	Box Engine C1G730		o	GWB3525	
1.4 (59 kW)	1992.03-1995.12	Box Engine E6J700	•		GHA421004	A
	1992.03-1995.12	Box Engine E6J700	•		GWB3596	
	1992.03-1995.12	Box Engine E6J700		o	GWB3525	
1.9 D (48 kW)	1992.03-1995.12	Box Engine F8Q706/F8Q742	•		GHA421004	A
	1992.03-1995.12	Box Engine F8Q706/F8Q742	•		GWB3596	
	1992.03-1995.12	Box Engine F8Q706/F8Q742		o	GWB3525	
1.9 DT (68 kW)	1992.03-1995.12	Box Engine F8Q740	•		GHA421004	A
	1992.03-1995.12	Box Engine F8Q740	•		GWB3596	
	1992.03-1995.12	Box Engine F8Q740		o	GWB3525	
19 II CABRIOLET (D53_, 853_)						
1.8 16V (101 kW)	1992.05-1994.04	Convertible Engine F7P 704	•		GHA421004	A
	1992.05-1994.04	Convertible Engine F7P 704	•		GWB3596	
	1992.05-1994.04	Convertible Engine F7P 704		o	GWB0969	
19 II CHAMADE (L53_)						
1.4 (59 kW)	1994.10-1995.11	Saloon Engine E7J 706	•		GHA421004	A
1.9 D (68 kW)	1992.05-1995.11	Saloon Engine F8Q744	•		GHA421004	A
	1992.05-1995.11	Saloon Engine F8Q744	•		GWB3596	
	1992.05-1995.11	Saloon Engine F8Q744		o	GWB0969	
	1992.05-1995.11	Saloon Engine F8Q744		o	GWB3525	
21 (L48_)						
2.0 (78 kW)	1991.05-1993.10	Saloon Engine J6R758	•		GWB3596	
	1991.05-1993.10	Saloon Engine J6R758		o	GWB0975	



	 YEAR		F	R	G-AP Ref.	KIT
RENAULT						
21 SAVANNA (K48_)						
2.0 (99 kW)	1990.06-1994.02	Estate Engine J7R740	•		GWB3596	
	1990.06-1994.02	Estate Engine J7R740 Without ABS		○	GHA225020	K
AVANTIME (DE0_)						
2.0 16V Turbo (120 kW)	2001.11-2003.05	MPV Engine F4R760/F4R761	•		GWB3504	
	2001.11-2003.05	MPV Engine F4R760/F4R761 With ABS		○	GHA230075	A
2.2 DCi (110 kW)	2002.05-2003.05	MPV Engine G9T712	•		GWB3504	
	2002.05-2003.05	MPV Engine G9T712 With ABS		○	GHA230075	A
3.0 V6 (152 kW)	2001.09-2003.05	MPV Engine L7X720/L7X721	•		GWB3504	
	2001.09-2003.05	MPV Engine L7X720/L7X721 With ABS		○	GHA230075	A
CAPTUR						
0.9 TCE (66 kW)	2013.06-	Hatchback	•		GWB3637	
	2013.06-	Hatchback		○	GWB6799	
1.2 TCE (88 kW)	2013.06-	Hatchback		○	GWB6799	
1.5 DCi (66 kW)	2013.06-	Hatchback		○	GWB6799	
CLIO (B/C57_, 5/357_)						
1.1 (34 kW)	1991.01-1998.09	Hatchback Engine C1E700	•		GWB3496	
	1991.01-1998.09	Hatchback Engine C1E700		○	GWB3525	
1.1 (36 kW)	1992.04-1992.08	Hatchback Engine C1E700	•		GWB3496	
	1992.04-1992.08	Hatchback Engine C1E700		○	GWB3525	
1.2 (40 kW)	1991.01-1996.06	Hatchback Engine E7F706	•		GHA421001	
	1991.01-1996.06	Hatchback Engine E7F706	•		GWB3496	
	1991.01-1996.06	Hatchback Engine E7F706	•		GWB3596	
	1991.01-1996.06	Hatchback Engine E7F706		○	GWB3525	
	1996.01-1996.12	Hatchback Engine C3G720	•		GHA421001	
	1996.01-1996.12	Hatchback Engine C3G720		○	GWB3496	
	1996.01-1996.12	Hatchback Engine C3G720		○	GWB3525	
	1996.01-1998.09	Hatchback Engine D7F730	•		GHA421001	
	1996.01-1998.09	Hatchback Engine D7F730	•		GHA421004	A
	1996.01-1998.09	Hatchback Engine D7F730	•		GWB3496	
	1996.01-1998.09	Hatchback Engine D7F730	•		GWB3596	
	1996.01-1998.09	Hatchback Engine D7F730		○	GWB0969	
	1996.01-1998.09	Hatchback Engine D7F730		○	GWB3525	
	1.2 (43 kW)	1990.05-1998.09	Hatchback Engine E7F700/E7F708/E7F750	•		GHA421001
1990.05-1998.09		Hatchback Engine E7F700/E7F708/E7F750	•		GHA421004	A
1990.05-1998.09		Hatchback Engine E7F700/E7F708/E7F750	•		GWB3496	
1990.05-1998.09		Hatchback Engine E7F700/E7F708/E7F750	•		GWB3596	
1990.05-1998.09		Hatchback Engine E7F700/E7F708/E7F750		○	GWB0969	
1990.05-1998.09		Hatchback Engine E7F700/E7F708/E7F750		○	GWB3525	
1996.01-1998.09		Hatchback Engine D7F730	•		GHA421001	
1996.01-1998.09		Hatchback Engine D7F730	•		GHA421004	A
1996.01-1998.09		Hatchback Engine D7F730	•		GWB3496	
1996.01-1998.09		Hatchback Engine D7F730	•		GWB3596	
1.2 (44 kW)	1990.05-1996.03	Hatchback Engine E5F710	•		GHA421001	
	1990.05-1996.03	Hatchback Engine E5F710	•		GWB3496	
	1990.05-1996.03	Hatchback Engine E5F710		○	GWB3525	
1.4 (55 kW)	1991.01-1998.09	Hatchback Engine E7J756/E7J757	•		GWB3496	
	1991.01-1998.09	Hatchback Engine E7J756/E7J757	•		GWB3596	
	1991.01-1998.09	Hatchback Engine E7J756/E7J757		○	GWB0969	
	1991.01-1998.09	Hatchback Engine E7J756/E7J757		○	GWB3525	
1.4 (57 kW)	1990.05-1998.02	Hatchback Engine E6J760,E6J712/E6J713	•		GHA421001	
	1990.05-1998.02	Hatchback Engine E6J760,E6J712/E6J713	•		GWB3496	
	1990.05-1998.02	Hatchback Engine E6J760,E6J712/E6J713	•		GWB3596	
	1990.05-1998.02	Hatchback Engine E6J760,E6J712/E6J713		○	GWB3525	
1.4 (58 kW)	1991.01-1998.09	Hatchback Engine E7J601	•		GHA421001	
	1991.01-1998.09	Hatchback Engine E7J601	•		GHA421004	A
	1991.01-1998.09	Hatchback Engine E7J601	•		GWB3496	
	1991.01-1998.09	Hatchback Engine E7J601	•		GWB3596	
	1991.01-1998.09	Hatchback Engine E7J601		○	GWB0969	
	1991.01-1998.09	Hatchback Engine E7J601		○	GWB3525	
1.4 (59 kW)	1991.01-1998.09	Hatchback Engine E7J710/E7J711	•		GHA421001	
	1991.01-1998.09	Hatchback Engine E7J710/E7J711	•		GHA421004	A
	1991.01-1998.09	Hatchback Engine E7J710/E7J711	•		GWB3496	



	 YEAR		F	R	G-AP Ref.	KIT
RENAULT						
CLIO (B/C57_, 5/357_)						
1.4 (59 kW)	1991.01-1998.09	Hatchback Engine E7J710/E7J711	•		GWB3596	
	1991.01-1998.09	Hatchback Engine E7J710/E7J711		◦	GWB3525	
1.8 (65 kW)	1991.01-1998.09	Hatchback Engine F3P710/F3P714	•		GHA421001	
	1991.01-1998.09	Hatchback Engine F3P710/F3P714	•		GHA421004	A
	1991.01-1998.09	Hatchback Engine F3P710/F3P714	•		GWB3496	
	1991.01-1998.09	Hatchback Engine F3P710/F3P714	•		GWB3596	
	1991.01-1998.09	Hatchback Engine F3P710/F3P714		◦	GWB0969	
	1991.01-1998.09	Hatchback Engine F3P710/F3P714		◦	GWB3525	
1.8 (66 kW)	1990.08-1996.04	Hatchback Engine F3P755	•		GHA421004	A
	1994.08-1998.09	Hatchback Engine F3P754/F3P755	•		GHA421001	
	1994.08-1998.09	Hatchback Engine F3P754/F3P755	•		GHA421004	A
	1994.08-1998.09	Hatchback Engine F3P754/F3P755	•		GWB3596	
	1994.08-1998.09	Hatchback Engine F3P754/F3P755		◦	GWB0969	
1.8 (70 kW)	1991.01-1998.09	Hatchback Engine F3P710	•		GHA421001	
	1991.01-1998.09	Hatchback Engine F3P710	•		GHA421004	A
1.8 16V (99 kW)	1991.01-1996.03	Hatchback Engine F7P722	•		GHA421004	A
	1991.01-1996.03	Hatchback Engine F7P722	•		GWB3596	
	1991.01-1996.03	Hatchback Engine F7P722		◦	GWB0969	
1.8 Rsi (79 kW)	1995.08-1998.09	Hatchback Engine F3P758	•		GHA421001	
	1995.08-1998.09	Hatchback Engine F3P758	•		GHA421004	A
	1995.08-1998.09	Hatchback Engine F3P758	•		GWB3496	
	1995.08-1998.09	Hatchback Engine F3P758	•		GWB3596	
	1995.08-1998.09	Hatchback Engine F3P758		◦	GWB0969	
1.8 Rsi (80 kW)	1993.01-1995.08	Hatchback Engine F3P712	•		GHA421001	
	1993.01-1995.08	Hatchback Engine F3P712	•		GHA421004	A
	1993.01-1995.08	Hatchback Engine F3P712	•		GWB3496	
	1993.01-1995.08	Hatchback Engine F3P712	•		GWB3596	
	1993.01-1995.08	Hatchback Engine F3P712		◦	GWB0969	
1.9 D (40 kW)	1997.01-1998.09	Hatchback Engine F8Q678	•		GHA421004	A
	1997.01-1998.09	Hatchback Engine F8Q678	•		GWB3596	
	1997.01-1998.09	Hatchback Engine F8Q678		◦	GWB0969	
	1997.01-1998.09	Hatchback Engine F8Q678		◦	GWB3525	
1.9 D (47 kW)	1991.01-1998.09	Hatchback Engine F8Q730/F8Q732	•		GHA421004	A
	1991.01-1998.09	Hatchback Engine F8Q730/F8Q732	•		GWB3596	
	1991.01-1998.09	Hatchback Engine F8Q730/F8Q732		◦	GWB0969	
	1991.01-1998.09	Hatchback Engine F8Q730/F8Q732		◦	GWB3525	
1.9 D (48 kW)	1996.05-1998.02	Hatchback Engine F8Q676/F8Q696	•		GHA421004	A
	1996.05-1998.02	Hatchback Engine F8Q676/F8Q696	•		GWB3596	
	1996.05-1998.02	Hatchback Engine F8Q676/F8Q696		◦	GWB0969	
	1996.05-1998.02	Hatchback Engine F8Q676/F8Q696		◦	GWB3525	
2.0 Williams (108 kW)	1994.01-1998.09	Hatchback Engine F7R700	•		GHA421004	A
	1994.01-1998.09	Hatchback Engine F7R700	•		GWB3596	
	1994.01-1998.09	Hatchback Engine F7R700		◦	GWB0969	
Electric (21 kW)	1996.05-1998.02	Hatchback Engine 2DB701	•		GHA421001	
	1996.05-1998.02	Hatchback Engine 2DB701	•		GHA421004	A
CLIO GRANDTOUR (KR0/1_)						
1.2 16V (55 kW)	2008.02-	Estate Engine D4F740	•		GWB3637	
	2008.02-	Estate Engine D4F740		◦	GHA225019	K
	2008.02-	Estate Engine D4F740		◦	GHA499032	K
	2008.02-	Estate Engine D4F740		◦	GWB3639	
	2008.02-	Estate Engine D4F740		◦	GWB6658	
1.2 16V (58 kW)	2008.02-	Estate Engine D4F764	•		GWB3637	
	2008.02-	Estate Engine D4F764		◦	GHA225019	K
	2008.02-	Estate Engine D4F764		◦	GHA499032	K
	2008.02-	Estate Engine D4F764		◦	GWB3639	
	2008.02-	Estate Engine D4F764		◦	GWB6658	
1.2 16V (74 kW)	2008.02-	Estate Engine D4F784	•		GWB3637	
	2008.02-	Estate Engine D4F784		◦	GHA225019	K
	2008.02-	Estate Engine D4F784		◦	GHA499032	K
	2008.02-	Estate Engine D4F784		◦	GWB3639	
	2008.02-	Estate Engine D4F784		◦	GWB6658	
1.2 16V (76 kW)	2010.09-	Estate Engine D4F786	•		GWB3637	
	2010.09-	Estate Engine D4F786		◦	GWB3639	
	2010.09-	Estate Engine D4F786		◦	GWB6658	



	 YEAR		F	R	G-AP Ref.	KIT
RENAULT						
CLIO GRANDTOUR (KR0/1_)						
1.2 16V Hi-Flex (55 kW)	2008.07-	Estate Engine D4F740	•		GWB3637	
	2008.07-	Estate Engine D4F740		○	GHA225019	K
	2008.07-	Estate Engine D4F740		○	GHA499032	K
	2008.07-	Estate Engine D4F740		○	GWB3639	
	2008.07-	Estate Engine D4F740		○	GWB6658	
1.4 16V (72 kW)	2010.02-	Estate Engine K4J780	•		GWB3637	
	2010.02-	Estate Engine K4J780		○	GHA499032	K
	2010.02-	Estate Engine K4J780		○	GWB3639	
	2010.02-	Estate Engine K4J780		○	GWB6658	
1.5 DCi (48 kW)	2010.02-	Estate Engine K9K752	•		GWB3637	
	2010.02-	Estate Engine K9K752	•		GWB3638	
	2010.02-	Estate Engine K9K752		○	GHA499032	K
	2010.02-	Estate Engine K9K752		○	GWB3639	
	2010.02-	Estate Engine K9K752		○	GWB6658	
1.5 DCi (50 kW)	2008.02-	Estate Engine K9K768/K9K714	•		GWB3637	
	2008.02-	Estate Engine K9K768/K9K714	•		GWB3638	
	2008.02-	Estate Engine K9K768/K9K714		○	GHA225019	K
	2008.02-	Estate Engine K9K768/K9K714		○	GHA499032	K
	2008.02-	Estate Engine K9K768/K9K714		○	GWB3639	
	2008.02-	Estate Engine K9K768/K9K714		○	GWB6658	
1.5 DCi (55 kW)	2010.08-	Estate Engine K9K770	•		GWB3637	
	2010.08-	Estate Engine K9K770	•		GWB3638	
	2010.08-	Estate Engine K9K770		○	GHA225019	K
	2010.08-	Estate Engine K9K770		○	GWB3639	
	2010.08-	Estate Engine K9K770		○	GWB6658	
1.5 DCi (63 kW)	2008.02-	Estate Engine K9K766	•		GWB3637	
	2008.02-	Estate Engine K9K766	•		GWB3638	
	2008.02-	Estate Engine K9K766		○	GHA225019	K
	2008.02-	Estate Engine K9K766		○	GHA499032	K
	2008.02-	Estate Engine K9K766		○	GWB3639	
	2008.02-	Estate Engine K9K766		○	GWB6658	
1.5 DCi (65 kW)	2010.08-	Estate Engine K9K772/K9K770	•		GWB3637	
	2010.08-	Estate Engine K9K772/K9K770	•		GWB3638	
	2010.08-	Estate Engine K9K772/K9K770		○	GHA225019	K
	2010.08-	Estate Engine K9K772/K9K770		○	GHA499032	K
	2010.08-	Estate Engine K9K772/K9K770		○	GWB3639	
	2010.08-	Estate Engine K9K772/K9K770		○	GWB6658	
1.5 DCi (76 kW)	2008.02-	Estate Engine K9K772	•		GWB3637	
	2008.02-	Estate Engine K9K772	•		GWB3638	
	2008.02-	Estate Engine K9K772		○	GHA225019	K
	2008.02-	Estate Engine K9K772		○	GHA499032	K
	2008.02-	Estate Engine K9K772		○	GWB3639	
	2008.02-	Estate Engine K9K772		○	GWB6658	
1.5 DCi (78 kW)	2008.02-	Estate Engine K9K764	•		GWB3637	
	2008.02-	Estate Engine K9K764	•		GWB3638	
	2008.02-	Estate Engine K9K764		○	GHA225019	K
	2008.02-	Estate Engine K9K764		○	GHA499032	K
	2008.02-	Estate Engine K9K764		○	GWB3639	
	2008.02-	Estate Engine K9K764		○	GWB6658	
1.6 16V (82 kW)	2008.02-	Estate Engine K4M800/801	•		GWB3637	
	2008.02-	Estate Engine K4M800/801		○	GHA225019	K
	2008.02-	Estate Engine K4M800/801		○	GWB3639	
	2008.02-	Estate Engine K4M800/801		○	GWB6658	
1.6 16V (94 kW)	2008.11-	Estate Engine K4M862	•		GWB3637	
	2008.11-	Estate Engine K4M862		○	GHA225019	K
	2008.11-	Estate Engine K4M862		○	GWB3639	
	2008.11-	Estate Engine K4M862		○	GWB6658	
CLIO GRANDTOUR IV						
0.9 TCE (66 kW)	2013.01-	Estate	•		GWB3637	
	2013.01-	Estate		○	GWB6658	
1.2 16V (54 kW)	2013.01-	Estate Engine D4F740	•		GWB3637	
	2013.01-	Estate Engine D4F740		○	GWB6658	
1.2 TCe (88 kW)	2013.03-	Estate	•		GWB3637	
	2013.03-	Estate		○	GWB7032	



	 YEAR		F	R	G-AP Ref.	KIT
RENAULT						
CLIO GRANDTOUR IV						
1.5 DCi (66 kW)	2013.01-	Estate Engine K9K608	•		GWB3637	
	2013.01-	Estate Engine K9K608		◦	GWB6658	
	2013.01-	Estate Engine K9K608		◦	GWB7032	
1.5 DCi 75 (55 kW)	2013.01-	Estate Engine K9K612	•		GWB3637	
	2013.01-	Estate Engine K9K612		◦	GWB6658	
	2013.01-	Estate Engine K9K612		◦	GWB7032	
CLIO I (B/C57_, 5/357_)						
1.7 (68 kW)	1991.01-1993.12	Hatchback Engine F2N770	•		GHA421001	
	1991.01-1993.12	Hatchback Engine F2N770	•		GHA421004	A
	1991.01-1993.12	Hatchback Engine F2N770	•		GWB3496	
	1991.01-1993.12	Hatchback Engine F2N770	•		GWB3596	
	1991.01-1993.12	Hatchback Engine F2N770		◦	GWB0969	
	1991.01-1993.12	Hatchback Engine F2N770		◦	GWB3525	
CLIO I (S57_)						
1.1 (34 kW)	1991.01-1998.09	Box Engine C1E700	•		GWB3496	
	1991.01-1998.09	Box Engine C1E700		◦	GWB3525	
1.2 (40 kW)	1991.01-1998.09	Box Engine E7F706	•		GHA421001	
	1991.01-1998.09	Box Engine E7F706	•		GWB3496	
	1991.01-1998.09	Box Engine E7F706		◦	GWB3525	
	1994.06-1998.02	Box Engine C3G 720	•		GHA421001	
	1994.06-1998.02	Box Engine C3G 720	•		GWB3496	
	1994.06-1998.02	Box Engine C3G 720		◦	GWB3525	
1.2 (44 kW)	1991.01-1998.09	Box Engine E7F750	•		GHA421001	
	1991.01-1998.09	Box Engine E7F750	•		GWB3496	
	1991.01-1998.09	Box Engine E7F750		◦	GWB3525	
1.9 D (48 kW)	1991.01-1998.09	Box Engine F8Q730/F8Q732	•		GHA421004	A
	1991.01-1998.09	Box Engine F8Q730/F8Q732	•		GWB3596	
	1991.01-1998.09	Box Engine F8Q730/F8Q732		◦	GWB3525	
1.9 RND (40 kW)	1996.04-1998.02	Box Engine F8Q 678	•		GHA421004	A
	1996.04-1998.02	Box Engine F8Q 678	•		GWB3596	
	1996.04-1998.02	Box Engine F8Q 678		◦	GWB3525	
CLIO II (BB0/1/2_, CB0/1/2_)						
1.0 (40 kW)	2000.02-2001.05	Hatchback Engine D7D 760	•		GHA421001	
	2000.02-2001.05	Hatchback Engine D7D 760	•		GWB3496	
	2000.02-2001.05	Hatchback Engine D7D 760		◦	GHA225040	K
	2000.02-2001.05	Hatchback Engine D7D 760		◦	GWB3525	
1.0 (52 kW)	2001.06-2005.04	Hatchback	•		GHA421001	
	2001.06-2005.04	Hatchback	•		GWB3496	
	2001.06-2005.04	Hatchback		◦	GHA225040	K
	2001.06-2005.04	Hatchback		◦	GWB3525	
1.2 (43 kW)	1998.09-	Hatchback Engine D7F720/D7F726/D7F746/D7F764/D7F766	•		GHA421001	
	1998.09-	Hatchback Engine D7F720/D7F726/D7F746/D7F764/D7F766	•		GWB3496	
	1998.09-	Hatchback Engine D7F720/D7F726/D7F746/D7F764/D7F766	•		GWB3596	
	1998.09-	Hatchback Engine D7F720/D7F726/D7F746/D7F764/D7F766		◦	GHA225039	K
	1998.09-	Hatchback Engine D7F720/D7F726/D7F746/D7F764/D7F766		◦	GHA225040	K
	1998.09-	Hatchback Engine D7F720/D7F726/D7F746/D7F764/D7F766		◦	GWB3525	
1.2 (44 kW)	1999.03-2001.05	Hatchback Engine D7F722	•		GHA421001	
	1999.03-2001.05	Hatchback Engine D7F722	•		GWB3496	
	1999.03-2001.05	Hatchback Engine D7F722		◦	GHA225040	K
	1999.03-2001.05	Hatchback Engine D7F722		◦	GWB3525	
1.2 (55 kW)	2001.06-2003.10	Hatchback	•		GHA421004	A
	2001.06-2003.10	Hatchback	•		GWB3496	
	2001.06-2003.10	Hatchback		◦	GHA225039	K
	2001.06-2003.10	Hatchback		◦	GHA225040	K
1.2 16V (55 kW)	2001.06-	Hatchback Engine D4F706/D4F712/D4F714/D4F722/D4F728	•		GHA421001	
	2001.06-	Hatchback Engine D4F706/D4F712/D4F714/D4F722/D4F728	•		GHA421004	A
	2001.06-	Hatchback Engine D4F706/D4F712/D4F714/D4F722/D4F728	•		GWB3496	
	2001.06-	Hatchback Engine D4F706/D4F712/D4F714/D4F722/D4F728	•		GWB3596	
	2001.06-	Hatchback Engine D4F706/D4F712/D4F714/D4F722/D4F728		◦	GHA225039	K
	2001.06-	Hatchback Engine D4F706/D4F712/D4F714/D4F722/D4F728		◦	GHA225040	K
	2001.06-	Hatchback Engine D4F706/D4F712/D4F714/D4F722/D4F728		◦	GHA499032	K
	2001.06-	Hatchback Engine D4F706/D4F712/D4F714/D4F722/D4F728		◦	GWB0969	
2001.06-	Hatchback Engine D4F706/D4F712/D4F714/D4F722/D4F728		◦	GWB3525		



	 YEAR		F	R	G-AP Ref.	KIT
RENAULT						
CLIO II (BB0/1/2_, CB0/1/2_)						
1.2 LPG (43 kW)	1998.09-2009.06	Hatchback Engine D7F766/D7F764	•		GHA421001	
	1998.09-2009.06	Hatchback Engine D7F766/D7F764	•		GWB3496	
	1998.09-2009.06	Hatchback Engine D7F766/D7F764	•		GWB3596	
	1998.09-2009.06	Hatchback Engine D7F766/D7F764		○	GHA225039	K
	1998.09-2009.06	Hatchback Engine D7F766/D7F764		○	GHA225040	K
	1998.09-2009.06	Hatchback Engine D7F766/D7F764		○	GWB0969	
	1998.09-2009.06	Hatchback Engine D7F766/D7F764		○	GWB3525	
1.4 (55 kW)	1998.09-2005.05	Hatchback Engine E7J780	•		GHA421004	A
	1998.09-2005.05	Hatchback Engine E7J780	•		GWB3596	
	1998.09-2005.05	Hatchback Engine E7J780		○	GHA225039	K
	1998.09-2005.05	Hatchback Engine E7J780		○	GHA225040	K
	1998.09-2005.05	Hatchback Engine E7J780		○	GWB3525	
1.4 16V (70 kW)	1999.10-2004.09	Hatchback Engine K4J712/713	•		GHA421004	A
	1999.10-2004.09	Hatchback Engine K4J712/713	•		GWB3596	
	1999.10-2004.09	Hatchback Engine K4J712/713		○	GHA225039	K
	1999.10-2004.09	Hatchback Engine K4J712/713		○	GHA225040	K
	1999.10-2004.09	Hatchback Engine K4J712/713		○	GWB3525	
1.4 16V (72 kW)	2000.08-	Hatchback Engine K4J710/K4J711/K4J712/K4J713	•		GHA421004	A
	2000.08-	Hatchback Engine K4J710/K4J711/K4J712/K4J713	•		GWB3496	
	2000.08-	Hatchback Engine K4J710/K4J711/K4J712/K4J713	•		GWB3596	
	2000.08-	Hatchback Engine K4J710/K4J711/K4J712/K4J713		○	GHA225039	K
	2000.08-	Hatchback Engine K4J710/K4J711/K4J712/K4J713		○	GHA225040	K
	2000.08-	Hatchback Engine K4J710/K4J711/K4J712/K4J713		○	GWB0969	
	2000.08-	Hatchback Engine K4J710/K4J711/K4J712/K4J713		○	GWB3525	
1.5 DCi (42 kW)	2001.06-2006.12	Hatchback Engine K9K704	•		GHA421004	A
	2001.06-2006.12	Hatchback Engine K9K704	•		GWB3596	
	2001.06-2006.12	Hatchback Engine K9K704		○	GWB0969	
	2001.06-2006.12	Hatchback Engine K9K704		○	GWB3525	
1.5 DCi (47 kW)	2005.06-	Hatchback Engine K9K740	•		GWB3596	
	2005.06-	Hatchback Engine K9K740		○	GHA499032	K
	2005.06-	Hatchback Engine K9K740		○	GWB3525	
1.5 DCi (48 kW)	2001.06-	Hatchback Engine K9K700/K9K704	•		GHA421004	A
	2001.06-	Hatchback Engine K9K700/K9K704	•		GWB3596	
	2001.06-	Hatchback Engine K9K700/K9K704		○	GHA225039	K
	2001.06-	Hatchback Engine K9K700/K9K704		○	GHA225040	K
	2001.06-	Hatchback Engine K9K700/K9K704		○	GWB0969	
	2001.06-	Hatchback Engine K9K700/K9K704		○	GWB3525	
1.5 DCi (50 kW)	2004.08-	Hatchback Engine K9K700/K9K714	•		GWB3596	
	2004.08-	Hatchback Engine K9K700/K9K714		○	GHA225039	K
	2004.08-	Hatchback Engine K9K700/K9K714		○	GHA499032	K
	2004.08-	Hatchback Engine K9K700/K9K714		○	GWB0969	
	2004.08-	Hatchback Engine K9K700/K9K714		○	GWB3525	
1.5 DCi (59 kW)	2001.06-2003.10	Hatchback Engine K9K702	•		GWB3596	
	2001.06-2003.10	Hatchback Engine K9K702		○	GHA225039	K
	2001.06-2003.10	Hatchback Engine K9K702		○	GHA225040	K
	2001.06-2003.10	Hatchback Engine K9K702		○	GWB0969	
	2001.06-2003.10	Hatchback Engine K9K702		○	GWB3525	
1.5 DCi (60 kW)	2001.06-	Hatchback Engine K9K702	•		GWB3596	
	2001.06-	Hatchback Engine K9K702		○	GHA225039	K
	2001.06-	Hatchback Engine K9K702		○	GHA225040	K
	2001.06-	Hatchback Engine K9K702		○	GWB0969	
	2001.06-	Hatchback Engine K9K702		○	GWB3525	
1.5 DCi (62 kW)	2007.02-	Hatchback Engine K9K718	•		GWB3596	
	2007.02-	Hatchback Engine K9K718		○	GHA499032	K
	2007.02-	Hatchback Engine K9K718		○	GWB3525	
1.5 DCi (74 kW)	2004.01-	Hatchback Engine K9K712	•		GWB3596	
	2004.01-	Hatchback Engine K9K712		○	GHA225039	K
	2004.01-	Hatchback Engine K9K712		○	GWB3525	
1.6 (66 kW)	1998.09-2005.05	Hatchback Engine K7M744/K7M745	•		GHA421004	A
	1998.09-2005.05	Hatchback Engine K7M744/K7M745	•		GWB3596	
	1998.09-2005.05	Hatchback Engine K7M744/K7M745		○	GHA225039	K
	1998.09-2005.05	Hatchback Engine K7M744/K7M745		○	GHA225040	K
	1998.09-2005.05	Hatchback Engine K7M744/K7M745		○	GWB3525	
1.6 16V (79 kW)	1998.09-	Hatchback Engine K4M708/K4M740/K4M742/K4M743/K4M744/K4M745/K4M748	•		GHA421004	A



	 YEAR		F	R	G-AP Ref.	KIT
RENAULT						
CLIO II (BB0/1/2_, CB0/1/2_)						
1.6 16V (79 kW)	1998.09-	Hatchback Engine K4M708/K4M740/K4M742/K4M743/K4M744/K4M745/K4M748	•		GWB3596	
	1998.09-	Hatchback Engine K4M708/K4M740/K4M742/K4M743/K4M744/K4M745/K4M748		○	GHA225039	K
	1998.09-	Hatchback Engine K4M708/K4M740/K4M742/K4M743/K4M744/K4M745/K4M748		○	GHA225040	K
	1998.09-	Hatchback Engine K4M708/K4M740/K4M742/K4M743/K4M744/K4M745/K4M748		○	GWB0969	
	1998.09-	Hatchback Engine K4M708/K4M740/K4M742/K4M743/K4M744/K4M745/K4M748		○	GWB3525	
1.6 Hi-Flex (86 kW)	2005.01-2010.02	Hatchback Engine K4M748	•		GHA421004	A
	2005.01-2010.02	Hatchback Engine K4M748	•		GWB3596	
	2005.01-2010.02	Hatchback Engine K4M748		○	GWB0969	
	2005.01-2010.02	Hatchback Engine K4M748		○	GWB3525	
1.9 D (47 kW)	1998.09-2005.05	Hatchback Engine F8Q630	•		GHA421004	A
	1998.09-2005.05	Hatchback Engine F8Q630	•		GWB3596	
	1998.09-2005.05	Hatchback Engine F8Q630		○	GHA225039	K
	1998.09-2005.05	Hatchback Engine F8Q630		○	GHA225040	K
	1998.09-2005.05	Hatchback Engine F8Q630		○	GWB3525	
1.9 D (48 kW)	2000.02-2001.05	Hatchback Engine F8Q632	•		GHA421004	A
	2000.02-2001.05	Hatchback Engine F8Q632	•		GWB3596	
	2000.02-2001.05	Hatchback Engine F8Q632		○	GHA225040	K
	2000.02-2001.05	Hatchback Engine F8Q632		○	GWB3525	
1.9 DTi (59 kW)	1999.12-2005.05	Hatchback Engine F9Q780	•		GHA421004	A
	1999.12-2005.05	Hatchback Engine F9Q780	•		GWB3596	
	1999.12-2005.05	Hatchback Engine F9Q780		○	GHA225039	K
	1999.12-2005.05	Hatchback Engine F9Q780		○	GHA225040	K
	1999.12-2005.05	Hatchback Engine F9Q780		○	GWB3525	
2.0 16V Sport (124 kW)	2000.02-	Hatchback Engine F4R730	•		GHA423003	K
	2000.02-	Hatchback Engine F4R730	•		GWB3596	
	2000.02-	Hatchback Engine F4R730	•		GWB3615	
	2000.02-	Hatchback Engine F4R730		○	GHA225039	K
	2000.02-	Hatchback Engine F4R730		○	GHA225040	K
	2000.02-	Hatchback Engine F4R730		○	GWB0969	
	2000.02-	Hatchback Engine F4R730		○	GWB3525	
2.0 16V Sport (132 kW)	2005.05-2005.11	Hatchback Engine F4R738	•		GWB3596	
	2005.05-2005.11	Hatchback Engine F4R738	•		GWB3615	
	2005.05-2005.11	Hatchback Engine F4R738		○	GHA225039	K
	2005.05-2005.11	Hatchback Engine F4R738		○	GWB0969	
	2005.05-2005.11	Hatchback Engine F4R738		○	GWB3525	
3.0 V6 Sport (166 kW)	2000.11-2002.12	Hatchback Engine L7X760	•		GHA423003	K
	2000.11-2002.12	Hatchback Engine L7X760	•		GWB3608	
	2000.11-2002.12	Hatchback Engine L7X760		○	GHA225040	K
3.0 V6 Sport (187 kW)	2002.12-	Hatchback Engine L7X762	•		GWB3608	
	2002.12-	Hatchback Engine L7X762		○	GHA225039	K
CLIO II (SB0/1/2_)						
1.1 (43 kW)	1998.09-	Box Engine D7F720/D7F726/D7F746	•		GWB3496	
	1998.09-	Box Engine D7F720/D7F726/D7F746		○	GHA225039	K
	1998.09-	Box Engine D7F720/D7F726/D7F746		○	GHA225040	K
	1998.09-	Box Engine D7F720/D7F726/D7F746		○	GWB3525	
1.2 (44 kW)	1999.03-2003.10	Box Engine D7F722/D7F726/D7F746	•		GWB3496	
	1999.03-2003.10	Box Engine D7F722/D7F726/D7F746		○	GHA225040	K
	1999.03-2003.10	Box Engine D7F722/D7F726/D7F746		○	GWB3525	
1.5 DCi (48 kW)	2001.06-	Box Engine K9K700/K9K704	•		GWB3596	
	2001.06-	Box Engine K9K700/K9K704		○	GHA225039	K
	2001.06-	Box Engine K9K700/K9K704		○	GHA225040	K
	2001.06-	Box Engine K9K700/K9K704		○	GWB3525	
1.5 DCi (50 kW)	2004.04-	Box Engine K9K714	•		GWB3596	
	2004.04-	Box Engine K9K714		○	GHA225039	K
	2004.04-	Box Engine K9K714		○	GHA499032	K
	2004.04-	Box Engine K9K714		○	GWB3525	
1.5 DCi (59 kW)	2001.06-2004.10	Box Engine K9K702	•		GWB3596	
	2001.06-2004.10	Box Engine K9K702		○	GHA225040	K
	2001.06-2004.10	Box Engine K9K702		○	GWB3525	
1.5 DCi (60 kW)	2003.11-	Box Engine K9K702/K9K710/K9K716	•		GWB3596	
	2003.11-	Box Engine K9K702/K9K710/K9K716		○	GWB3525	
1.9 D (40 kW)	1999.03-2000.01	Box Engine F8Q 662	•		GWB3596	
	1999.03-2000.01	Box Engine F8Q 662		○	GWB3525	
1.9 D (47 kW)	1998.09-	Box Engine F8Q630	•		GWB3596	



	 YEAR		F	R	G-AP Ref.	KIT
RENAULT						
CLIO II (SB0/1/2_)						
1.9 D (47 kW)	1998.09-	Box Engine F8Q630		o	GHA225039	K
	1998.09-	Box Engine F8Q630		o	GHA225040	K
	1998.09-	Box Engine F8Q630		o	GWB3525	
1.9 D (48 kW)	2000.02-2001.05	Box Engine F8Q632	•		GWB3596	
	2000.02-2001.05	Box Engine F8Q632		o	GHA225040	K
	2000.02-2001.05	Box Engine F8Q632		o	GWB3525	
1.9 DTi (59 kW)	2000.02-2001.05	Box Engine F9Q780	•		GWB3596	
	2000.02-2001.05	Box Engine F9Q780		o	GHA225040	K
	2000.02-2001.05	Box Engine F9Q780		o	GWB3525	
CLIO III (BR0/1, CR0/1)						
1.2 (BR01, BR03, BR0E, CR0E) (57 kW)	2005.10-	Hatchback Engine D4F 764	•		GWB3637	
	2005.10-	Hatchback Engine D4F 764		o	GHA225019	K
	2005.10-	Hatchback Engine D4F 764		o	GHA499032	K
	2005.10-	Hatchback Engine D4F 764		o	GWB3525	
	2005.10-	Hatchback Engine D4F 764		o	GWB3639	
1.2 16V (48 kW)	2005.06-	Hatchback Engine D4F740	•		GWB3637	
	2005.06-	Hatchback Engine D4F740		o	GHA225019	K
	2005.06-	Hatchback Engine D4F740		o	GHA499032	K
	2005.06-	Hatchback Engine D4F740		o	GWB3525	
	2005.06-	Hatchback Engine D4F740		o	GWB3639	
1.2 16V (55 kW)	2005.08-2006.04	Hatchback Engine D4F740	•		GWB3637	
	2005.08-2006.04	Hatchback Engine D4F740		o	GHA225019	K
	2005.08-2006.04	Hatchback Engine D4F740		o	GHA499032	K
	2005.08-2006.04	Hatchback Engine D4F740		o	GWB3525	
	2005.08-2006.04	Hatchback Engine D4F740		o	GWB3639	
1.2 16V (58 kW)	2006.10-	Hatchback Engine D4F764	•		GWB3637	
	2006.10-	Hatchback Engine D4F764		o	GHA225019	K
	2006.10-	Hatchback Engine D4F764		o	GHA499032	K
	2006.10-	Hatchback Engine D4F764		o	GWB3525	
	2006.10-	Hatchback Engine D4F764		o	GWB3639	
1.2 16V (74 kW)	2007.04-	Hatchback Engine D4F784	•		GWB3637	
	2007.04-	Hatchback Engine D4F784		o	GHA225019	K
	2007.04-	Hatchback Engine D4F784		o	GHA499032	K
	2007.04-	Hatchback Engine D4F784		o	GWB3525	
	2007.04-	Hatchback Engine D4F784		o	GWB3639	
1.2 16V (76 kW)	2010.09-	Hatchback Engine D4F786	•		GWB3637	
	2010.09-	Hatchback Engine D4F786		o	GHA225019	K
	2010.09-	Hatchback Engine D4F786		o	GWB3525	
	2010.09-	Hatchback Engine D4F786		o	GWB3639	
	2010.09-	Hatchback Engine D4F786		o	GWB3637	
1.2 16V Hi-Flex (55 kW)	2008.07-	Hatchback Engine D4F740/D4F742	•		GWB3637	
	2008.07-	Hatchback Engine D4F740/D4F742		o	GHA225019	K
	2008.07-	Hatchback Engine D4F740/D4F742		o	GHA499032	K
	2008.07-	Hatchback Engine D4F740/D4F742		o	GWB3525	
	2008.07-	Hatchback Engine D4F740/D4F742		o	GWB3639	
1.2 Ethanol (55 kW)	2008.07-	Hatchback	•		GWB3637	
	2008.07-	Hatchback		o	GWB3525	
	2008.07-	Hatchback		o	GWB3639	
1.4 16V (72 kW)	2005.06-	Hatchback Engine K4J780	•		GWB3637	
	2005.06-	Hatchback Engine K4J780		o	GHA225019	K
	2005.06-	Hatchback Engine K4J780		o	GHA499032	K
	2005.06-	Hatchback Engine K4J780		o	GWB3525	
	2005.06-	Hatchback Engine K4J780		o	GWB3639	
1.5 DCi (47 kW)	2005.06-	Hatchback Engine K9K752	•		GWB3637	
	2005.06-	Hatchback Engine K9K752	•		GWB3638	
	2005.06-	Hatchback Engine K9K752		o	GHA225019	K
	2005.06-	Hatchback Engine K9K752		o	GHA499032	K
	2005.06-	Hatchback Engine K9K752		o	GWB3525	
	2005.06-	Hatchback Engine K9K752		o	GWB3639	
1.5 DCi (48 kW)	2005.05-	Hatchback Engine K9K752	•		GWB3637	
	2005.05-	Hatchback Engine K9K752	•		GWB3638	
	2005.05-	Hatchback Engine K9K752		o	GHA225019	K
	2005.05-	Hatchback Engine K9K752		o	GHA499032	K
	2005.05-	Hatchback Engine K9K752		o	GWB3525	
	2005.05-	Hatchback Engine K9K752		o	GWB3639	



	 YEAR		F	R	G-AP Ref.	KIT
RENAULT						
CLIO III (BR0/1, CR0/1)						
1.5 DCi (50 kW)	2005.08-2007.04	Hatchback Engine K9K714/K9K768	•		GWB3637	
	2005.08-2007.04	Hatchback Engine K9K714/K9K768	•		GWB3638	
	2005.08-2007.04	Hatchback Engine K9K714/K9K768		○	GHA225019	K
	2005.08-2007.04	Hatchback Engine K9K714/K9K768		○	GHA499032	K
	2005.08-2007.04	Hatchback Engine K9K714/K9K768		○	GWB3525	
	2005.08-2007.04	Hatchback Engine K9K714/K9K768		○	GWB3639	
1.5 DCi (55 kW)	2010.08-	Hatchback Engine K9K770	•		GWB3637	
	2010.08-	Hatchback Engine K9K770	•		GWB3638	
	2010.08-	Hatchback Engine K9K770		○	GHA225019	K
	2010.08-	Hatchback Engine K9K770		○	GHA499032	K
	2010.08-	Hatchback Engine K9K770		○	GWB3525	
	2010.08-	Hatchback Engine K9K770		○	GWB3639	
1.5 DCi (60 kW)	2007.11-	Hatchback Engine K9K750	•		GWB3637	
	2007.11-	Hatchback Engine K9K750	•		GWB3638	
	2007.11-	Hatchback Engine K9K750		○	GHA225019	K
	2007.11-	Hatchback Engine K9K750		○	GWB3525	
	2007.11-	Hatchback Engine K9K750		○	GWB3639	
1.5 DCi (63 kW)	2005.08-2006.07	Hatchback Engine K9K766	•		GWB3637	
	2005.08-2006.07	Hatchback Engine K9K766	•		GWB3638	
	2005.08-2006.07	Hatchback Engine K9K766		○	GHA225019	K
	2005.08-2006.07	Hatchback Engine K9K766		○	GHA499032	K
	2005.08-2006.07	Hatchback Engine K9K766		○	GWB3525	
	2005.08-2006.07	Hatchback Engine K9K766		○	GWB3639	
1.5 DCi (65 kW)	2010.08-	Hatchback Engine K9K770	•		GWB3637	
	2010.08-	Hatchback Engine K9K770	•		GWB3638	
	2010.08-	Hatchback Engine K9K770		○	GHA225019	K
	2010.08-	Hatchback Engine K9K770		○	GWB3525	
	2010.08-	Hatchback Engine K9K770		○	GWB3639	
1.5 DCi (76 kW)	2005.06-	Hatchback Engine K9K772	•		GWB3637	
	2005.06-	Hatchback Engine K9K772	•		GWB3638	
	2005.06-	Hatchback Engine K9K772		○	GHA225019	K
	2005.06-	Hatchback Engine K9K772		○	GHA499032	K
	2005.06-	Hatchback Engine K9K772		○	GWB3525	
	2005.06-	Hatchback Engine K9K772		○	GWB3639	
1.5 DCi (78 kW)	2005.08-2007.04	Hatchback Engine K9K764	•		GWB3637	
	2005.08-2007.04	Hatchback Engine K9K764	•		GWB3638	
	2005.08-2007.04	Hatchback Engine K9K764		○	GHA225019	K
	2005.08-2007.04	Hatchback Engine K9K764		○	GHA499032	K
	2005.08-2007.04	Hatchback Engine K9K764		○	GWB3525	
	2005.08-2007.04	Hatchback Engine K9K764		○	GWB3639	
1.6 16V (65 kW)	2005.06-	Hatchback Engine K4M804	•		GWB3637	
	2005.06-	Hatchback Engine K4M804		○	GHA225019	K
	2005.06-	Hatchback Engine K4M804		○	GHA499032	K
	2005.06-	Hatchback Engine K4M804		○	GWB3525	
	2005.06-	Hatchback Engine K4M804		○	GWB3639	
1.6 16V (82 kW)	2005.08-2007.07	Hatchback Engine K4M800/K4M801	•		GWB3637	
	2005.08-2007.07	Hatchback Engine K4M800/K4M801		○	GHA225019	K
	2005.08-2007.07	Hatchback Engine K4M800/K4M801		○	GHA499032	K
	2005.08-2007.07	Hatchback Engine K4M800/K4M801		○	GWB3525	
	2005.08-2007.07	Hatchback Engine K4M800/K4M801		○	GWB3639	
1.6 16V GT (94 kW)	2009.06-	Hatchback Engine K4M862	•		GWB3638	
	2009.06-	Hatchback Engine K4M862		○	GHA225019	K
	2009.06-	Hatchback Engine K4M862		○	GWB3525	
	2009.06-	Hatchback Engine K4M862		○	GWB3639	
1.6 Hi-Flex (86 kW)	2005.05-2010.02	Hatchback Engine K4M748	•		GWB3637	
	2005.05-2010.02	Hatchback Engine K4M748		○	GWB3525	
	2005.05-2010.02	Hatchback Engine K4M748		○	GWB3639	
2.0 16V (102 kW)	2006.10-	Hatchback Engine M4R700/M4R701	•		GWB3638	
	2006.10-	Hatchback Engine M4R700/M4R701		○	GHA225019	K
	2006.10-	Hatchback Engine M4R700/M4R701		○	GWB3525	
	2006.10-	Hatchback Engine M4R700/M4R701		○	GWB3639	
2.0 16V Sport (145 kW)	2006.05-	Hatchback Engine F4R830		○	GWB3525	
CLIO IV						
0.9 TCE (66 kW)	2012.11-	Hatchback	•		GWB3637	



	 YEAR		F	R	G-AP Ref.	KIT
RENAULT						
CLIO IV						
0.9 TCE (66 kW)	2012.11-	Hatchback		o	GWB6658	
1.2 16V (54 kW)	2012.11-	Hatchback Engine D4F740	•		GWB3637	
	2012.11-	Hatchback Engine D4F740		o	GWB6658	
1.2 TCe (88 kW)	2013.03-	Hatchback	•		GWB3637	
	2013.03-	Hatchback		o	GWB7032	
1.5 DCi (55 kW)	2012.11-	Hatchback Engine K9K612	•		GWB3637	
	2012.11-	Hatchback Engine K9K612		o	GWB6658	
	2012.11-	Hatchback Engine K9K612		o	GWB7032	
1.5 DCi (66 kW)	2012.11-	Hatchback Engine K9K608	•		GWB3637	
	2012.11-	Hatchback Engine K9K608		o	GWB6658	
	2012.11-	Hatchback Engine K9K608		o	GWB7032	
1.6 RS (147 kW)	2013.03-	Hatchback		o	GHA230137	K
CLIO MK II (BB0/1/2_, CB0/1/2_)						
1.6 (81 kW)	2004.112009.02	Hatchback Engine K4M 748	•		GWB3596	
	2004.112009.02	Hatchback Engine K4M 748		o	GWB0969	
	2004.112009.02	Hatchback Engine K4M 748		o	GWB3525	
1.6 Flex (81 kW)	2000.052006.12	Hatchback	•		GWB3596	
	2000.052006.12	Hatchback		o	GWB0969	
	2000.052006.12	Hatchback		o	GWB3525	
DUSTER						
1.5 DCi (66 kW)	2011.06-	Closed Off-Road Vehicle Engine K9K 884		o	GWB6799	
1.6 16V (75 kW)	2012.02-	Closed Off-Road Vehicle Engine K4M616		o	GWB6799	
2.0 (98 kW)	2012.02-	Closed Off-Road Vehicle		o	GWB6799	
ESPACE II (J/S63_)						
2.0 (76 kW)	1991.01-1996.10	MPV Engine J7R768 Without ABS		o	GHA225020	K
2.1 TD (65 kW)	1991.01-1996.10	MPV Engine J8S772/J8S776/J8S778/J8S610 Without ABS		o	GHA225020	K
2.1 TD (66 kW)	1994.11-1996.10	MPV Engine J8S612 Without ABS		o	GHA225020	K
2.2 (79 kW)	1991.01-1996.10	MPV Engine J7T773/J7T776/J7T772 Without ABS		o	GHA225020	K
2.8 V6 (110 kW)	1991.01-1996.10	MPV Engine Z7W712/Z7W713/Z7W717		o	GHA230116	K
	1991.01-1996.10	MPV Engine Z7W712/Z7W713/Z7W717 With ABS		o	GHA230075	A
	1991.01-1996.10	MPV Engine Z7W712/Z7W713/Z7W717 Without ABS		o	GHA230113	K
ESPACE III (JE0_)						
1.9 DTi (72 kW)	1999.02-2002.10	MPV Engine F9Q722	•		GWB3504	
	1999.02-2002.10	MPV Engine F9Q722 With ABS		o	GHA230075	A
	1999.02-2002.10	MPV Engine F9Q722 Without ABS		o	GHA230113	K
2.0 (102 kW)	2001.09-2002.10	MPV Engine F4R700/F4R701	•		GWB3504	
	2001.09-2002.10	MPV Engine F4R700/F4R701 With ABS		o	GHA230075	A
	2001.09-2002.10	MPV Engine F4R700/F4R701 Without ABS		o	GHA230113	K
2.0 (84 kW)	1996.11-2000.10	MPV Engine F3R728/F3R729/F3R742/F3R768/F3R769	•		GWB3504	
	1996.11-2000.10	MPV Engine F3R728/F3R729/F3R742/F3R768/F3R769 With ABS		o	GHA230075	A
	1996.11-2000.10	MPV Engine F3R728/F3R729/F3R742/F3R768/F3R769 Without ABS		o	GHA230113	K
2.0 16V (103 kW)	1998.10-2002.10	MPV Engine F4R700/F4R701	•		GWB3504	
	1998.10-2002.10	MPV Engine F4R700/F4R701 With ABS		o	GHA230075	A
	1998.10-2002.10	MPV Engine F4R700/F4R701 Without ABS		o	GHA230113	K
2.2 12V TD (83 kW)	1996.11-2000.10	MPV Engine G8T714/G8T716/G8T760	•		GWB3504	
	1996.11-2000.10	MPV Engine G8T714/G8T716/G8T760 With ABS		o	GHA230075	A
	1996.11-2000.10	MPV Engine G8T714/G8T716/G8T760 Without ABS		o	GHA230113	K
2.2 D (84 kW)	1997.11-2000.01	MPV Engine G8T716	•		GWB3504	
	1997.11-2000.01	MPV Engine G8T716 With ABS		o	GHA230075	A
	1997.11-2000.01	MPV Engine G8T716 Without ABS		o	GHA230113	K
2.2 DCi (85 kW)	2000.07-2002.10	MPV Engine G9T710	•		GWB3504	
	2000.07-2002.10	MPV Engine G9T710 With ABS		o	GHA230075	A
2.2 DCi (95 kW)	2000.10-2002.10	MPV Engine G9T642/G9T710	•		GWB3504	
	2000.10-2002.10	MPV Engine G9T642/G9T710 With ABS		o	GHA230075	A
3.0 (123 kW)	1996.11-1998.10	MPV Engine Z7X775	•		GWB3504	
	1996.11-1998.10	MPV Engine Z7X775 With ABS		o	GHA230075	A
	1996.11-1998.10	MPV Engine Z7X775 Without ABS		o	GHA230113	K
3.0 V6 24V (140 kW)	1998.10-2002.10	MPV Engine L7X727	•		GWB3504	
	1998.10-2002.10	MPV Engine L7X727 With ABS		o	GHA230075	A
	1998.10-2002.10	MPV Engine L7X727 Without ABS		o	GHA230113	K
ESPACE IV (JK0/1_)						
1.9 DCi (85 kW)	2003.04-2005.02	MPV Engine F9Q820	•		GWB3648	
	2003.04-2005.02	MPV Engine F9Q820		o	GHA230142	K



	 YEAR		F	R	G-AP Ref.	KIT
RENAULT						
ESPACE IV (JK0/1_)						
1.9 DCi (88 kW)	2002.11-	MPV Engine F9Q680/F9Q820/F9Q826	•		GWB3648	
	2002.11-	MPV Engine F9Q680/F9Q820/F9Q826		◦	GHA230142	K
2.0 (100 kW)	2002.11-	MPV Engine F4R792	•		GWB3648	
	2002.11-	MPV Engine F4R792		◦	GHA230142	K
2.0 (125 kW)	2005.05-2007.01	MPV Engine F4R796/797/896/897	•		GWB3648	
	2005.05-2007.01	MPV Engine F4R796/797/896/897		◦	GHA230142	K
2.0 (98 kW)	2002.11-2005.02	MPV Engine F4R790	•		GWB3648	
2.0 DCi (110 kW)	2006.08-2007.01	MPV Engine M9R740/M9R750	•		GWB3648	
	2006.08-2007.01	MPV Engine M9R740/M9R750		◦	GHA230142	K
2.0 DCi (127 kW)	2006.02-2007.01	MPV Engine M9R760/M9R761/M9R762/M9R763	•		GWB3648	
	2006.02-2007.01	MPV Engine M9R760/M9R761/M9R762/M9R763		◦	GHA230142	K
2.0 DCi (96 kW)	2006.08-2007.01	MPV Engine M9R802	•		GWB3648	
	2006.08-2007.01	MPV Engine M9R802		◦	GHA230142	K
2.0 Turbo (120 kW)	2002.11-	MPV Engine F4R794/F4R795/F4R796/F4R797	•		GWB3648	
	2002.11-	MPV Engine F4R794/F4R795/F4R796/F4R797		◦	GHA230142	K
2.2 DCi (102 kW)	2006.08-2007.04	MPV Engine G9T645	•		GWB3648	
	2006.08-2007.04	MPV Engine G9T645		◦	GHA230142	K
2.2 DCi (110 kW)	2002.11-	MPV Engine G9T742/G9T743	•		GWB3648	
	2002.11-	MPV Engine G9T742/G9T743		◦	GHA230142	K
3.0 DCi (120 kW)	2005.09-	MPV	•		GWB3648	
3.0 DCi (130 kW)	2002.11-	MPV Engine P9X701	•		GWB3648	
	2002.11-	MPV Engine P9X701		◦	GHA230142	K
3.0 DCi (133 kW)	2006.02-2007.04	MPV Engine P9X715	•		GWB3648	
	2006.02-2007.04	MPV Engine P9X715		◦	GHA230142	K
3.5 V6 (177 kW)	2002.11-	MPV Engine V4Y711/V4Y715	•		GWB3648	
	2002.11-	MPV Engine V4Y711/V4Y715		◦	GHA230142	K
EXPRESS						
1.9 D (40 kW)	1995.07-1997.10	Pickup Engine F8Q640	•		GHA421001	
1.9 D (47 kW)	1995.07-1999.10	Pickup Engine F8Q724/F8Q776	•		GHA421001	
EXTRA (F40_, G40_)						
1.6 D (40 kW)	1993.09-1995.04	Box Engine F8M736	•		GHA421001	
	1993.09-1995.04	Box Engine F8M736	•		GHA421004	A
	1993.09-1995.04	Box Engine F8M736	•		GWB3496	
	1993.09-1995.04	Box Engine F8M736	•		GWB3596	
	1993.09-1995.04	Box Engine F8M736		◦	GWB0976	
	1993.09-1995.04	Box Engine F8M736 Without ABS		◦	GHA225020	K
EXTRA VAN (F40_, G40_)						
1.1 (35 kW)	1993.09-1995.04	Box Engine C1E762	•		GHA421001	
1.2 (40 kW)	1991.09-1993.08	Box Engine C1G726	•		GHA421001	
	1991.09-1998.03	Box Engine C3G710/C3G712	•		GHA421001	
	1991.09-1998.03	Box Engine C3G710/C3G712	•		GHA421004	A
	1991.09-1998.03	Box Engine C3G710/C3G712	•		GWB3496	
	1991.09-1998.03	Box Engine C3G710/C3G712	•		GWB3596	
	1991.09-1998.03	Box Engine C3G710/C3G712		◦	GWB0976	
1.4 (54 kW)	1991.09-1993.08	Box Engine E7J724	•		GHA421001	
	1991.09-1993.08	Box Engine E7J724	•		GHA421004	A
1.4 (55 kW)	1991.09-1998.03	Box Engine E7J720/E7J724/E7J726/E7J773	•		GHA421001	
	1991.09-1998.03	Box Engine E7J720/E7J724/E7J726/E7J773	•		GHA421004	A
	1991.09-1998.03	Box Engine E7J720/E7J724/E7J726/E7J773	•		GWB3496	
	1991.09-1998.03	Box Engine E7J720/E7J724/E7J726/E7J773	•		GWB3596	
	1991.09-1998.03	Box Engine E7J720/E7J724/E7J726/E7J773		◦	GWB0976	
	1991.09-1998.03	Box Engine E7J720/E7J724/E7J726/E7J773 Without ABS		◦	GHA225020	K
1.4 (58 kW)	1994.01-1998.03	Box Engine E7J728	•		GHA421001	
	1994.01-1998.03	Box Engine E7J728	•		GWB3496	
	1994.01-1998.03	Box Engine E7J728	•		GWB3596	
	1994.01-1998.03	Box Engine E7J728		◦	GWB0976	
	1994.01-1998.03	Box Engine E7J728 Without ABS		◦	GHA225020	K
1.4 (59 kW)	1995.05-1997.08	Box Engine E7J773	•		GHA421001	
	1995.05-1997.08	Box Engine E7J773	•		GHA421004	A
1.9 D (40 kW)	1994.09-1998.03	Box Engine F8Q640/F8Q682	•		GHA421001	
	1994.09-1998.03	Box Engine F8Q640/F8Q682	•		GWB3496	
	1994.09-1998.03	Box Engine F8Q640/F8Q682	•		GWB3596	
	1994.09-1998.03	Box Engine F8Q640/F8Q682		◦	GWB0976	
	1994.09-1998.03	Box Engine F8Q640/F8Q682 Without ABS		◦	GHA225020	K



	 YEAR		F	R	G-AP Ref.	KIT
RENAULT						
EXTRA VAN (F40_, G40_)						
1.9 D (47 kW)	1991.09-1998.03	Box Engine F8Q646/F8Q722/F8Q724/F8Q774/F8Q776	•		GHA421001	
	1991.09-1998.03	Box Engine F8Q646/F8Q722/F8Q724/F8Q774/F8Q776	•		GHA421004	A
	1991.09-1998.03	Box Engine F8Q646/F8Q722/F8Q724/F8Q774/F8Q776	•		GWB3496	
	1991.09-1998.03	Box Engine F8Q646/F8Q722/F8Q724/F8Q774/F8Q776	•		GWB3596	
	1991.09-1998.03	Box Engine F8Q646/F8Q722/F8Q724/F8Q774/F8Q776		○	GWB0976	
	1991.09-1998.03	Box Engine F8Q646/F8Q722/F8Q724/F8Q774/F8Q776 Without ABS		○	GHA225020	K
FLUENCE (L30_)						
1.5 DCi (81 kW)	2010.02-	Saloon Engine K9K836/K9K837		○	GHA225038	K
1.6 16V (81 kW)	2010.02-	Saloon Engine K4M838/K4M839		○	GHA225038	K
2.0 16V (103 kW)	2010.02-	Saloon Engine M4R714/M4R751		○	GHA225038	K
GRAND SCENIC II (JM0/1_)						
1.5 DCi (60 kW)	2004.04-	MPV Engine K9K 722	•		GWB3638	
1.5 DCi (74 kW)	2004.07-2006.10	MPV Engine K9K728	•		GWB3638	
	2004.07-2006.10	MPV Engine K9K728		○	GHA230140	K
	2004.07-2006.10	MPV Engine K9K728		○	GWB3676	
1.5 DCi (76 kW)	2006.06-2008.11	MPV Engine K9K 734	•		GWB3638	
1.5 DCi (78 kW)	2005.05-	MPV Engine K9KP732	•		GWB3638	
	2005.05-	MPV Engine K9KP732		○	GHA230140	K
	2005.05-	MPV Engine K9KP732		○	GWB3676	
1.6 (77 kW)	2006.06-	MPV Engine K4M788	•		GWB3638	
	2006.06-	MPV Engine K4M788		○	GWB3676	
1.6 (82 kW)	2006.06-2008.11	MPV Engine K4M812	•		GWB3638	
1.6 (83 kW)	2004.04-	MPV Engine K4M761/K4M782	•		GWB3638	
	2004.04-	MPV Engine K4M761/K4M782		○	GHA230140	K
	2004.04-	MPV Engine K4M761/K4M782		○	GWB3676	
1.9 DCi (81 kW)	2005.05-	MPV Engine F9QE804	•		GWB3638	
	2005.05-	MPV Engine F9QE804		○	GHA230140	K
	2005.05-	MPV Engine F9QE804		○	GWB3676	
1.9 DCi (85 kW)	2005.05-2009.01	MPV	•		GWB3638	
	2005.05-2009.01	MPV		○	GWB3676	
1.9 DCi (88 kW)	2004.04-	MPV Engine F9Q812	•		GWB3638	
	2004.04-	MPV Engine F9Q812		○	GHA230140	K
	2004.04-	MPV Engine F9Q812		○	GWB3676	
1.9 DCi (96 kW)	2005.05-2007.07	MPV Engine F9Q816/F9Q818/F9QEE804/F9QJ803	•		GWB3638	
	2005.05-2007.07	MPV Engine F9Q816/F9Q818/F9QEE804/F9QJ803		○	GHA230140	K
	2005.05-2007.07	MPV Engine F9Q816/F9Q818/F9QEE804/F9QJ803		○	GWB3676	
2.0 (120 kW)	2004.08-2006.10	MPV Engine F4R776	•		GWB3638	
	2004.08-2006.10	MPV Engine F4R776		○	GHA230140	K
	2004.08-2006.10	MPV Engine F4R776		○	GWB3676	
2.0 (99 kW)	2004.04-	MPV Engine F4R770/F4R771	•		GWB3638	
	2004.04-	MPV Engine F4R770/F4R771		○	GHA230140	K
	2004.04-	MPV Engine F4R770/F4R771		○	GWB3676	
2.0 DCi (110 kW)	2006.07-2006.10	MPV Engine M9R700/M9R721/M9R722	•		GWB3692	
	2006.07-2006.10	MPV Engine M9R700/M9R721/M9R722		○	GHA230141	K
	2006.07-2006.10	MPV Engine M9R700/M9R721/M9R722		○	GWB3676	
GRAND SCENIC III (JZ0/1_)						
1.4 16V (96 kW)	2009.02-	MPV Engine H4J700		○	GHA230138	K
1.5 DCi (63 kW)	2009.04-	MPV Engine K9K830		○	GHA230137	K
1.5 DCi (78 kW)	2009.02-	MPV Engine K9K832		○	GHA230138	K
1.5 DCi (81 kW)	2009.04-	MPV Engine K9K636/K9K836/K9K837		○	GHA230137	K
	2009.04-	MPV Engine K9K636/K9K836/K9K837		○	GHA230138	K
	2009.02-	MPV Engine K4M858		○	GHA230138	K
1.6 16V (81 kW)	2011.04-	MPV Engine R9M402/R9M404		○	GHA230138	K
1.6 DCi (96 kW)	2009.02-	MPV Engine F9Q870/F9Q872		○	GHA230138	K
1.9 DCi (96 kW)	2009.02-	MPV Engine F9Q870/F9Q872		○	GHA230138	K
2.0 16V (103 kW)	2009.02-	MPV Engine M4R711		○	GHA230138	K
KANGOO (KC0/1_)						
1.2 (43 kW)	1997.08-	MPV Engine D7F710/D7F720/D7F722/D7F726/D7F744/D7F746	•		GHA421004	A
	1997.08-	MPV Engine D7F710/D7F720/D7F722/D7F726/D7F744/D7F746	•		GWB3596	
	1997.08-	MPV Engine D7F710/D7F720/D7F722/D7F726/D7F744/D7F746		○	GHA225026	K
	1997.08-	MPV Engine D7F710/D7F720/D7F722/D7F726/D7F744/D7F746		○	GHA225030	K
	1997.08-	MPV Engine D7F710/D7F720/D7F722/D7F726/D7F744/D7F746		○	GWB0976	
1.2 16V (55 kW)	2001.06-	MPV Engine D4F712/D4F714/D4F716	•		GHA421004	A
	2001.06-	MPV Engine D4F712/D4F714/D4F716	•		GWB3596	
	2001.06-	MPV Engine D4F712/D4F714/D4F716		○	GHA225026	K



	 YEAR		F	R	G-AP Ref.	KIT
RENAULT						
KANGOO (KC0/1_)						
1.2 16V (55 kW)	2001.06-	MPV Engine D4F712/D4F714/D4F716		o	GHA225030	K
	2001.06-	MPV Engine D4F712/D4F714/D4F716		o	GWB0976	
1.4 (55 kW)	1997.08-	MPV Engine E7J634/E7J635/E7J780/K7J700/K7J701	•		GHA421004	A
	1997.08-	MPV Engine E7J634/E7J635/E7J780/K7J700/K7J701	•		GWB3596	
	1997.08-	MPV Engine E7J634/E7J635/E7J780/K7J700/K7J701		o	GHA225026	K
	1997.08-	MPV Engine E7J634/E7J635/E7J780/K7J700/K7J701		o	GHA225030	K
	1997.08-	MPV Engine E7J634/E7J635/E7J780/K7J700/K7J701		o	GWB0976	
1.5 DCi (42 kW)	2003.07-	MPV Engine K9K704	•		GWB3596	
	2003.07-	MPV Engine K9K704		o	GHA225026	K
	2003.07-	MPV Engine K9K704		o	GHA225030	K
	2003.07-	MPV Engine K9K704		o	GWB0976	
1.5 DCi (45 kW)	2005.04-2010.06	MPV	•		GHA421004	A
	2005.04-2010.06	MPV	•		GWB3596	
	2005.04-2010.06	MPV		o	GHA225026	K
	2005.04-2010.06	MPV		o	GHA225030	K
	2005.04-2010.06	MPV		o	GWB0976	
1.5 DCi (48 kW)	2001.12-	MPV Engine K9K700/K9K704	•		GWB3596	
	2001.12-	MPV Engine K9K700/K9K704		o	GHA225026	K
	2001.12-	MPV Engine K9K700/K9K704		o	GHA225030	K
	2001.12-	MPV Engine K9K700/K9K704		o	GWB0976	
1.5 DCi (50 kW)	2005.08-	MPV Engine K9K714	•		GHA421004	A
	2005.08-	MPV Engine K9K714	•		GWB3596	
	2005.08-	MPV Engine K9K714		o	GHA225026	K
	2005.08-	MPV Engine K9K714		o	GHA225030	K
	2005.08-	MPV Engine K9K714		o	GWB0976	
1.5 DCi (60 kW)	2002.07-	MPV Engine K9K702/K9K710	•		GHA421004	A
	2002.07-	MPV Engine K9K702/K9K710	•		GWB3596	
	2002.07-	MPV Engine K9K702/K9K710		o	GHA225026	K
	2002.07-	MPV Engine K9K702/K9K710		o	GHA225030	K
	2002.07-	MPV Engine K9K702/K9K710		o	GWB0976	
1.5 DCi (62 kW)	2005.08-2007.04	MPV Engine K9K718	•		GHA421004	A
	2005.08-2007.04	MPV Engine K9K718	•		GWB3596	
	2005.08-2007.04	MPV Engine K9K718		o	GHA225026	K
	2005.08-2007.04	MPV Engine K9K718		o	GHA225030	K
	2005.08-2007.04	MPV Engine K9K718		o	GWB0976	
1.6 (66 kW)	1999.09-2001.06	MPV Engine K7M746	•		GWB3596	
	1999.09-2001.06	MPV Engine K7M746		o	GHA225026	K
	1999.09-2001.06	MPV Engine K7M746		o	GHA225030	K
	1999.09-2001.06	MPV Engine K7M746		o	GWB0976	
1.6 16V (70 kW)	2001.06-	MPV Engine K4M750/K4M752/K4M753	•		GHA421004	A
	2001.06-	MPV Engine K4M750/K4M752/K4M753	•		GWB3596	
	2001.06-	MPV Engine K4M750/K4M752/K4M753		o	GHA225026	K
	2001.06-	MPV Engine K4M750/K4M752/K4M753		o	GHA225030	K
	2001.06-	MPV Engine K4M750/K4M752/K4M753		o	GWB0976	
1.6 16V 4x4 (70 kW)	2001.10-	MPV Engine K4M750/K4M752/K4M753	•		GWB3615	
1.6 16V Bivalent (60 kW)	2005.06-	MPV	•		GHA421004	A
	2005.06-	MPV	•		GWB3596	
	2005.06-	MPV		o	GHA225026	K
	2005.06-	MPV		o	GHA225030	K
	2005.06-	MPV		o	GWB0976	
1.9 DCi 4x4 (59 kW)	2001.10-	MPV Engine F9Q782/F9Q790	•		GWB3615	
1.9 DCi 4x4 (62 kW)	2003.10-	MPV Engine F9Q790	•		GWB3615	
1.9 DTi (59 kW)	2000.02-	MPV Engine F9Q780	•		GHA421004	A
	2000.02-	MPV Engine F9Q780	•		GWB3596	
	2000.02-	MPV Engine F9Q780		o	GHA225026	K
	2000.02-	MPV Engine F9Q780		o	GHA225030	K
1.9 RXED (48 kW)	1999.09-2001.06	MPV Engine F8Q632	•		GHA421004	A
	1999.09-2001.06	MPV Engine F8Q632	•		GWB3596	
	1999.09-2001.06	MPV Engine F8Q632		o	GHA225026	K
	1999.09-2001.06	MPV Engine F8Q632		o	GHA225030	K
	1999.09-2001.06	MPV Engine F8Q632		o	GWB0976	
D 55 1.9 (40 kW)	1997.08-	MPV Engine F8Q662	•		GHA421004	A
	1997.08-	MPV Engine F8Q662	•		GWB3596	
	1997.08-	MPV Engine F8Q662		o	GHA225026	K



	 YEAR		F	R	G-AP Ref.	KIT
RENAULT						
KANGOO (KC0/1_)						
D 55 1.9 (40 kW)	1997.08-	MPV Engine F8Q662		o	GHA225030	K
	1997.08-	MPV Engine F8Q662		o	GWB0976	
D 65 1.9 (47 kW)	1997.08-	MPV Engine F8Q630/F8Q632	•		GHA421004	A
	1997.08-	MPV Engine F8Q630/F8Q632	•		GWB3596	
	1997.08-	MPV Engine F8Q630/F8Q632		o	GHA225026	K
	1997.08-	MPV Engine F8Q630/F8Q632		o	GHA225030	K
	1997.08-	MPV Engine F8Q630/F8Q632		o	GWB0976	
Elect'roaD RE (22 kW)	2002.01-2004.12	MPV Engine 5DC700	•		GWB3596	
	2002.01-2004.12	MPV Engine 5DC700		o	GHA225026	K
	2002.01-2004.12	MPV Engine 5DC700		o	GHA225030	K
KANGOO / GRAND KANGOO (KW0/1_)						
1.2 TCE (84 kW)	2013.07-	MPV	•		GWB3637	
	2013.07-	MPV	•		GWB3692	
	2013.07-	MPV		o	GWB6799	
1.5 DCi (50 kW)	2008.02-	MPV Engine K9K800	•		GWB3637	
	2008.02-	MPV Engine K9K800	•		GWB3692	
	2008.02-	MPV Engine K9K800		o	GHA230144	K
	2008.02-	MPV Engine K9K800		o	GWB6799	
1.5 DCi (55 kW)	2012.11-	MPV Engine K9K802	•		GWB3637	
	2012.11-	MPV Engine K9K802	•		GWB3692	
	2012.11-	MPV Engine K9K802		o	GWB6799	
1.5 DCi (63 kW)	2008.02-	MPV Engine K9K802	•		GWB3637	
	2008.02-	MPV Engine K9K802	•		GWB3692	
	2008.02-	MPV Engine K9K802		o	GHA230144	K
	2008.02-	MPV Engine K9K802		o	GWB6799	
1.5 DCi (66 kW)	2012.11-	MPV Engine K9K808	•		GWB3637	
	2012.11-	MPV Engine K9K808	•		GWB3692	
	2012.11-	MPV Engine K9K808		o	GHA230144	K
	2012.11-	MPV Engine K9K808		o	GWB6799	
1.5 DCi (76 kW)	2008.02-	MPV Engine K9K804/K9K806	•		GWB3637	
	2008.02-	MPV Engine K9K804/K9K806	•		GWB3692	
	2008.02-	MPV Engine K9K804/K9K806		o	GHA230144	K
	2008.02-	MPV Engine K9K804/K9K806		o	GWB6799	
1.5 DCi (78 kW)	2008.02-	MPV	•		GWB3637	
	2008.02-	MPV	•		GWB3692	
	2008.02-	MPV		o	GHA230144	K
	2008.02-	MPV		o	GWB6799	
1.5 DCi (80 kW)	2010.09-	MPV Engine RHWK9K800	•		GWB3637	
	2010.09-	MPV Engine RHWK9K800	•		GWB3692	
	2010.09-	MPV Engine RHWK9K800		o	GWB6799	
1.6 (64 kW)	2008.02-	MPV Engine K7M750	•		GWB3637	
	2008.02-	MPV Engine K7M750	•		GWB3692	
	2008.02-	MPV Engine K7M750		o	GHA230144	K
	2008.02-	MPV Engine K7M750		o	GWB6799	
1.6 16V (78 kW)	2008.02-	MPV Engine K4M830/K4M831	•		GWB3637	
	2008.02-	MPV Engine K4M830/K4M831	•		GWB3692	
	2008.02-	MPV Engine K4M830/K4M831		o	GHA230144	K
	2008.02-	MPV Engine K4M830/K4M831		o	GWB6799	
1.6 16V Hi-Flex (78 kW)	2008.02-	MPV Engine K4M850	•		GWB3637	
	2008.02-	MPV Engine K4M850	•		GWB3692	
	2008.02-	MPV Engine K4M850		o	GHA230144	K
	2008.02-	MPV Engine K4M850		o	GWB6799	
KANGOO BE BOP (KW0/1_)						
1.5 DCi (55 kW)	2010.09-	MPV Engine K9K802	•		GWB3692	
	2010.09-	MPV Engine K9K802		o	GWB6799	
1.5 DCi (66 kW)	2009.06-	MPV Engine K9K808	•		GWB3692	
	2009.06-	MPV Engine K9K808		o	GHA230144	K
	2009.06-	MPV Engine K9K808		o	GWB6799	
1.5 DCi (76 kW)	2009.02-	MPV Engine K9K806	•		GWB3692	
	2009.02-	MPV Engine K9K806		o	GHA230144	K
	2009.02-	MPV Engine K9K806		o	GWB6799	
1.5 DCi (80 kW)	2009.06-	MPV Engine K9K804	•		GWB3692	
	2009.06-	MPV Engine K9K804		o	GHA230144	K
	2009.06-	MPV Engine K9K804		o	GWB6799	



	 YEAR		F	R	G-AP Ref.	KIT
RENAULT						
KANGOO BE BOP (KW0/1_)						
1.6 (78 kW)	2009.02-	MPV Engine K4M830	•		GWB3692	
	2009.02-	MPV Engine K4M830		○	GHA230144	K
	2009.02-	MPV Engine K4M830		○	GWB6799	
KANGOO EXPRESS (FC0/1_)						
1.0 (40 kW)	2003.07-	Box Engine D7D 700	•		GWB3596	
	2003.07-	Box Engine D7D 700		○	GHA225026	K
	2003.07-	Box Engine D7D 700		○	GHA225030	K
	2003.07-	Box Engine D7D 700		○	GWB0976	
1.2 (43 kW)	1997.08-	Box Engine D7F710/D7F720/D7F722/D7F726/D7F744/D7F746	•		GHA421004	A
	1997.08-	Box Engine D7F710/D7F720/D7F722/D7F726/D7F744/D7F746	•		GWB3596	
	1997.08-	Box Engine D7F710/D7F720/D7F722/D7F726/D7F744/D7F746		○	GHA225026	K
	1997.08-	Box Engine D7F710/D7F720/D7F722/D7F726/D7F744/D7F746		○	GHA225030	K
	1997.08-	Box Engine D7F710/D7F720/D7F722/D7F726/D7F744/D7F746		○	GWB0976	
1.2 (44 kW)	1998.07-2001.07	Box Engine D7F764/D7F766	•		GHA421004	A
	1998.07-2001.07	Box Engine D7F764/D7F766	•		GWB3596	
	1998.07-2001.07	Box Engine D7F764/D7F766		○	GHA225026	K
	1998.07-2001.07	Box Engine D7F764/D7F766		○	GHA225030	K
	1998.07-2001.07	Box Engine D7F764/D7F766		○	GWB0976	
1.2 16V (55 kW)	2001.10-	Box Engine D4F712/D4F714/D4F730	•		GHA421004	A
	2001.10-	Box Engine D4F712/D4F714/D4F730	•		GWB3596	
	2001.10-	Box Engine D4F712/D4F714/D4F730		○	GHA225026	K
	2001.10-	Box Engine D4F712/D4F714/D4F730		○	GHA225030	K
	2001.10-	Box Engine D4F712/D4F714/D4F730		○	GWB0976	
1.2 BiFuel (43 kW)	1998.07-2001.07	Box Engine D7F710/D7F744	•		GHA421004	A
	1998.07-2001.07	Box Engine D7F710/D7F744	•		GWB3596	
	1998.07-2001.07	Box Engine D7F710/D7F744		○	GHA225026	K
	1998.07-2001.07	Box Engine D7F710/D7F744		○	GHA225030	K
	1998.07-2001.07	Box Engine D7F710/D7F744		○	GWB0976	
1.4 (55 kW)	1997.08-	Box Engine E7J634/E7J635/E7J780/K7J701	•		GHA421004	A
	1997.08-	Box Engine E7J634/E7J635/E7J780/K7J701	•		GWB3596	
	1997.08-	Box Engine E7J634/E7J635/E7J780/K7J701		○	GHA225026	K
	1997.08-	Box Engine E7J634/E7J635/E7J780/K7J701		○	GHA225030	K
	1997.08-	Box Engine E7J634/E7J635/E7J780/K7J701		○	GWB0976	
1.5 DCi (42 kW)	2002.12-	Box Engine K9K704	•		GWB3596	
	2002.12-	Box Engine K9K704		○	GHA225026	K
	2002.12-	Box Engine K9K704		○	GHA225030	K
	2002.12-	Box Engine K9K704		○	GWB0976	
1.5 DCi (45 kW)	2005.10-	Box Engine K9K704/K9K716	•		GHA421004	A
	2005.10-	Box Engine K9K704/K9K716	•		GWB3596	
	2005.10-	Box Engine K9K704/K9K716		○	GHA225026	K
	2005.10-	Box Engine K9K704/K9K716		○	GHA225030	K
	2005.10-	Box Engine K9K704/K9K716		○	GWB0976	
1.5 DCi (48 kW)	2001.12-	Box Engine K9K700/K9K702/K9K704	•		GHA421004	A
	2001.12-	Box Engine K9K700/K9K702/K9K704	•		GWB3596	
	2001.12-	Box Engine K9K700/K9K702/K9K704		○	GHA225026	K
	2001.12-	Box Engine K9K700/K9K702/K9K704		○	GHA225030	K
	2001.12-	Box Engine K9K700/K9K702/K9K704		○	GWB0976	
1.5 DCi (50 kW)	2005.06-	Box Engine K9K714	•		GHA421004	A
	2005.06-	Box Engine K9K714	•		GWB3596	
	2005.06-	Box Engine K9K714		○	GHA225026	K
	2005.06-	Box Engine K9K714		○	GHA225030	K
	2005.06-	Box Engine K9K714		○	GWB0976	
1.5 DCi (60 kW)	2003.04-	Box Engine K9K702/K9K710	•		GHA421004	A
	2003.04-	Box Engine K9K702/K9K710	•		GWB3596	
	2003.04-	Box Engine K9K702/K9K710		○	GHA225026	K
	2003.04-	Box Engine K9K702/K9K710		○	GHA225030	K
	2003.04-	Box Engine K9K702/K9K710		○	GWB0976	
1.5 DCi (62 kW)	2005.06-	Box Engine K9K718	•		GHA421004	A
	2005.06-	Box Engine K9K718	•		GWB3596	
	2005.06-	Box Engine K9K718		○	GHA225026	K
	2005.06-	Box Engine K9K718		○	GHA225030	K
	2005.06-	Box Engine K9K718		○	GWB0976	
1.6 16V (70 kW)	2001.10-	Box Engine K4M752	•		GHA421004	A
	2001.10-	Box Engine K4M752	•		GWB3596	



	 YEAR		F	R	G-AP Ref.	KIT
RENAULT						
KANGOO EXPRESS (FC0/1_)						
1.6 16V (70 kW)	2001.10-	Box Engine K4M752		o	GHA225026	K
	2001.10-	Box Engine K4M752		o	GHA225030	K
	2001.10-	Box Engine K4M752		o	GWB0976	
1.6 16V 4x4 (70 kW)	2001.10-	Box Engine K4M750/K4M752/K4M753	•		GWB3615	
1.6 16V Bivalent (60 kW)	2005.06-	Box Engine K4M850	•		GHA421004	A
	2005.06-	Box Engine K4M850	•		GWB3596	
	2005.06-	Box Engine K4M850		o	GHA225026	K
	2005.06-	Box Engine K4M850		o	GHA225030	K
	2005.06-	Box Engine K4M850		o	GWB0976	
1.9 D (48 kW)	1999.09-2003.06	Box Engine F8Q632	•		GHA421004	A
	1999.09-2003.06	Box Engine F8Q632	•		GWB3596	
	1999.09-2003.06	Box Engine F8Q632		o	GWB0976	
1.9 DCi (62 kW)	2003.07-	Box Engine F9Q790	•		GHA421004	A
	2003.07-	Box Engine F9Q790	•		GWB3596	
	2003.07-	Box Engine F9Q790		o	GHA225026	K
	2003.07-	Box Engine F9Q790		o	GHA225030	K
	2003.07-	Box Engine F9Q790		o	GWB0976	
1.9 DCi 4x4 (59 kW)	2001.10-	Box Engine F9Q782/F9Q790	•		GWB3615	
1.9 DCi 4x4 (62 kW)	2003.07-	Box Engine F9Q790	•		GWB3615	
1.9 DTi (59 kW)	2000.02-	Box Engine F9Q780	•		GHA421004	A
	2000.02-	Box Engine F9Q780	•		GWB3596	
	2000.02-	Box Engine F9Q780		o	GHA225026	K
	2000.02-	Box Engine F9Q780		o	GHA225030	K
	2000.02-	Box Engine F9Q780		o	GWB0976	
D 55 1.9 (40 kW)	1997.08-	Box Engine F8Q662	•		GHA421004	A
	1997.08-	Box Engine F8Q662	•		GWB3596	
	1997.08-	Box Engine F8Q662		o	GHA225026	K
	1997.08-	Box Engine F8Q662		o	GHA225030	K
	1997.08-	Box Engine F8Q662		o	GWB0976	
D 65 1.9 (47 kW)	1997.08-	Box Engine F8Q630/F8Q632	•		GHA421004	A
	1997.08-	Box Engine F8Q630/F8Q632	•		GWB3596	
	1997.08-	Box Engine F8Q630/F8Q632		o	GHA225026	K
	1997.08-	Box Engine F8Q630/F8Q632		o	GHA225030	K
	1997.08-	Box Engine F8Q630/F8Q632		o	GWB0976	
KANGOO EXPRESS (FW0/1_)						
1.2 TCE (84 kW)	2013.07-	Box	•		GWB3637	
	2013.07-	Box	•		GWB3692	
	2013.07-	Box		o	GWB6799	
1.5 DCi (50 kW)	2008.02-	Box Engine K9K800	•		GWB3637	
	2008.02-	Box Engine K9K800	•		GWB3692	
	2008.02-	Box Engine K9K800		o	GHA230144	K
	2008.02-	Box Engine K9K800		o	GWB6799	
1.5 DCi (55 kW)	2010.09-	Box Engine K9K800/K9K808	•		GWB3637	
	2010.09-	Box Engine K9K800/K9K808	•		GWB3692	
	2010.09-	Box Engine K9K800/K9K808		o	GHA230144	K
	2010.09-	Box Engine K9K800/K9K808		o	GWB6799	
1.5 DCi (63 kW)	2008.02-	Box Engine K9K800/K9K802	•		GWB3637	
	2008.02-	Box Engine K9K800/K9K802	•		GWB3692	
	2008.02-	Box Engine K9K800/K9K802		o	GHA230144	K
	2008.02-	Box Engine K9K800/K9K802		o	GWB6799	
1.5 DCi (66 kW)	2009.06-	Box Engine K9K808	•		GWB3637	
	2009.06-	Box Engine K9K808	•		GWB3692	
	2009.06-	Box Engine K9K808		o	GHA230144	K
	2009.06-	Box Engine K9K808		o	GWB6799	
1.5 DCi (76 kW)	2008.02-	Box Engine K9K806	•		GWB3637	
	2008.02-	Box Engine K9K806	•		GWB3692	
	2008.02-	Box Engine K9K806		o	GHA230144	K
	2008.02-	Box Engine K9K806		o	GWB6799	
1.5 DCi (80 kW)	2010.09-	Box Engine K9K804	•		GWB3637	
	2010.09-	Box Engine K9K804	•		GWB3692	
	2010.09-	Box Engine K9K804		o	GHA230144	K
	2010.09-	Box Engine K9K804		o	GWB6799	
1.6 (64 kW)	2008.02-	Box Engine K7M750	•		GWB3637	
	2008.02-	Box Engine K7M750	•		GWB3692	



	 YEAR		F	R	G-AP Ref.	KIT
RENAULT						
KANGOO EXPRESS (FW0/1_)						
1.6 (64 kW)	2008.02-	Box Engine K7M750		o	GHA230144	K
	2008.02-	Box Engine K7M750		o	GWB6799	
1.6 16V (78 kW)	2008.02-	Box Engine K4M830	•		GWB3637	
	2008.02-	Box Engine K4M830	•		GWB3692	
	2008.02-	Box Engine K4M830		o	GHA230144	K
	2008.02-	Box Engine K4M830		o	GWB6799	
1.6 16V LPG (72 kW)	2008.02-	Box Engine K4M834	•		GWB3637	
	2008.02-	Box Engine K4M834	•		GWB3692	
	2008.02-	Box Engine K4M834		o	GWB6799	
Z.E. (44 kW)	2011.10-	Box Engine 5AM400	•		GWB3637	
	2011.10-	Box Engine 5AM400	•		GWB3692	
	2011.10-	Box Engine 5AM400		o	GHA230144	K
	2011.10-	Box Engine 5AM400		o	GWB6799	
KOLEOS (HY_)						
2.0 DCi (110 kW)	2008.09-	Closed Off-Road Vehicle Engine M9R855/M9R856/M9R862/M9R865/M9R866	•		GHA329006	K
	2008.09-	Closed Off-Road Vehicle Engine M9R855/M9R856/M9R862/M9R865/M9R866		o	GHA400161	
2.0 DCi 4x4 (110 kW)	2008.09-	Closed Off-Road Vehicle Engine M9R855/856/862/865/866	•		GHA329006	K
	2008.09-	Closed Off-Road Vehicle Engine M9R855/856/862/865/866		o	GHA325019	K
2.0 DCi 4x4 (127 kW)	2008.09-	Closed Off-Road Vehicle Engine M9R830	•		GHA329006	K
	2008.09-	Closed Off-Road Vehicle Engine M9R830		o	GHA325019	K
2.5 (126 kW)	2008.09-	Closed Off-Road Vehicle Engine 2TR700/2TR702/2TR703	•		GHA329006	K
	2008.09-	Closed Off-Road Vehicle Engine 2TR700/2TR702/2TR703		o	GHA400161	
2.5 4x4 (126 kW)	2008.09-	Closed Off-Road Vehicle Engine 2TR700/2TR702/2TR703	•		GHA329006	K
	2008.09-	Closed Off-Road Vehicle Engine 2TR700/2TR702/2TR703		o	GHA325019	K
LAGUNA I (B56_, 556_)						
1.6 16V (79 kW)	1997.11-2001.03	Hatchback Engine K4M720	•		GHA423001	
	1997.11-2001.03	Hatchback Engine K4M720	•		GWB3492	
	1997.11-2001.03	Hatchback Engine K4M720		o	GHA225027	K
	1997.11-2001.03	Hatchback Engine K4M720		o	GWB0976	
1.8 (66 kW)	1993.11-2001.03	Hatchback Engine F3P720/F3P724	•		GHA421004	A
	1993.11-2001.03	Hatchback Engine F3P720/F3P724	•		GHA423001	
	1993.11-2001.03	Hatchback Engine F3P720/F3P724	•		GWB3495	
	1993.11-2001.03	Hatchback Engine F3P720/F3P724	•		GWB3596	
	1993.11-2001.03	Hatchback Engine F3P720/F3P724		o	GHA225006	F
	1993.11-2001.03	Hatchback Engine F3P720/F3P724		o	GHA225006	K
	1993.11-2001.03	Hatchback Engine F3P720/F3P724		o	GWB0976	
	1995.08-2001.03	Hatchback Engine F3P670/F3P678	•		GHA421004	A
	1995.08-2001.03	Hatchback Engine F3P670/F3P678	•		GHA423001	
	1995.08-2001.03	Hatchback Engine F3P670/F3P678	•		GWB3492	
	1995.08-2001.03	Hatchback Engine F3P670/F3P678	•		GWB3596	
	1995.08-2001.03	Hatchback Engine F3P670/F3P678		o	GHA225006	F
	1995.08-2001.03	Hatchback Engine F3P670/F3P678		o	GHA225006	K
	1995.08-2001.03	Hatchback Engine F3P670/F3P678		o	GWB0976	
1.8 (69 kW)	1995.06-2001.02	Hatchback Engine F3P674	•		GHA421004	A
	1995.06-2001.02	Hatchback Engine F3P674	•		GHA423001	
	1995.06-2001.02	Hatchback Engine F3P674	•		GWB3495	
	1995.06-2001.02	Hatchback Engine F3P674	•		GWB3596	
	1995.06-2001.02	Hatchback Engine F3P674		o	GHA225006	F
	1995.06-2001.02	Hatchback Engine F3P674		o	GHA225006	K
	1995.06-2001.02	Hatchback Engine F3P674		o	GWB0976	
	1995.08-2001.03	Hatchback Engine F3P720/F3P724	•		GHA423001	
	1995.08-2001.03	Hatchback Engine F3P720/F3P724	•		GWB3495	
	1995.08-2001.03	Hatchback Engine F3P720/F3P724	•		GWB3596	
	1995.08-2001.03	Hatchback Engine F3P720/F3P724		o	GHA225006	F
	1995.08-2001.03	Hatchback Engine F3P720/F3P724		o	GHA225006	K
	1995.08-2001.03	Hatchback Engine F3P720/F3P724		o	GWB0976	
	1.8 (70 kW)	1995.06-1998.06	Hatchback	•		GWB3495
1995.06-1998.06		Hatchback	•		GWB3596	
1995.06-1998.06		Hatchback		o	GHA225006	F
1995.06-1998.06		Hatchback		o	GWB0976	
1995.06-1998.06		Hatchback Engine F3P676	•		GHA421004	A
1995.06-1998.06		Hatchback Engine F3P676	•		GHA423001	
1995.06-1998.06		Hatchback Engine F3P676	•		GWB3495	
1995.06-1998.06		Hatchback Engine F3P676	•		GWB3596	



	 YEAR		F	R	G-AP Ref.	KIT
RENAULT						
LAGUNA I (B56_, 556_)						
1.8 (70 kW)	1995.06-1998.06	Hatchback Engine F3P676		o	GHA225006	F
	1995.06-1998.06	Hatchback Engine F3P676		o	GWB0976	
1.8 16V (88 kW)	1998.04-2001.03	Hatchback Engine F4P760	•		GHA423001	
	1998.04-2001.03	Hatchback Engine F4P760	•		GWB3492	
	1998.04-2001.03	Hatchback Engine F4P760		o	GHA225027	K
	1998.04-2001.03	Hatchback Engine F4P760		o	GHA225035	K
	1998.04-2001.03	Hatchback Engine F4P760		o	GWB0976	
	1998.04-2001.03	Hatchback Engine F4P760		o	GWB0976	
1.9 DCi (79 kW)	1999.09-2001.03	Hatchback Engine F9Q718	•		GHA423001	
	1999.09-2001.03	Hatchback Engine F9Q718	•		GWB3492	
	1999.09-2001.03	Hatchback Engine F9Q718		o	GHA225027	K
1.9 DTi (72 kW)	1997.10-2001.03	Hatchback Engine F9Q710/F9Q716/F9Q717	•		GHA423001	
	1997.10-2001.03	Hatchback Engine F9Q710/F9Q716/F9Q717	•		GWB3492	
	1997.10-2001.03	Hatchback Engine F9Q710/F9Q716/F9Q717		o	GHA225027	K
	1997.10-2001.03	Hatchback Engine F9Q710/F9Q716/F9Q717		o	GHA225035	K
	1997.10-2001.03	Hatchback Engine F9Q710/F9Q716/F9Q717		o	GWB0976	
2.0 (102 kW)	1999.09-2001.02	Hatchback Engine F4R780	•		GWB3492	
	1999.09-2001.02	Hatchback Engine F4R780		o	GHA225027	K
2.0 (103 kW)	1995.06-2001.02	Hatchback Engine N7Q700/N7Q704	•		GHA423001	
	1995.06-2001.02	Hatchback Engine N7Q700/N7Q704	•		GWB3492	
	1995.06-2001.02	Hatchback Engine N7Q700/N7Q704	•		GWB3495	
	1995.06-2001.02	Hatchback Engine N7Q700/N7Q704		o	GHA225003	K
	1995.06-2001.02	Hatchback Engine N7Q700/N7Q704		o	GHA225035	K
2.0 (80 kW)	1999.03-2001.03	Hatchback Engine F3R611	•		GHA421004	A
	1999.03-2001.03	Hatchback Engine F3R611	•		GHA423001	
	1999.03-2001.03	Hatchback Engine F3R611	•		GWB3492	
	1999.03-2001.03	Hatchback Engine F3R611		o	GHA225035	K
	1999.03-2001.03	Hatchback Engine F3R611		o	GWB0976	
	1999.03-2001.03	Hatchback Engine F3R611		o	GWB0976	
2.0 (83 kW)	1993.11-2001.03	Hatchback Engine F3R722/F3R723	•		GHA421004	A
	1993.11-2001.03	Hatchback Engine F3R722/F3R723	•		GHA423001	
	1993.11-2001.03	Hatchback Engine F3R722/F3R723	•		GWB3492	
	1993.11-2001.03	Hatchback Engine F3R722/F3R723	•		GWB3495	
	1993.11-2001.03	Hatchback Engine F3R722/F3R723	•		GWB3596	
	1993.11-2001.03	Hatchback Engine F3R722/F3R723		o	GHA225003	K
	1993.11-2001.03	Hatchback Engine F3R722/F3R723		o	GHA225006	F
	1993.11-2001.03	Hatchback Engine F3R722/F3R723		o	GHA225006	K
	1993.11-2001.03	Hatchback Engine F3R722/F3R723		o	GHA225027	K
	1993.11-2001.03	Hatchback Engine F3R722/F3R723		o	GHA225035	K
	1993.11-2001.03	Hatchback Engine F3R722/F3R723		o	GWB0976	
	1993.11-2001.03	Hatchback Engine F3R722/F3R723		o	GWB0976	
	1993.11-2001.03	Hatchback Engine F3R722/F3R723		o	GWB0976	
2.0 (84 kW)	1995.06-2001.02	Hatchback Engine F3R768	•		GHA421004	A
	1995.06-2001.02	Hatchback Engine F3R768	•		GHA423001	
	1995.06-2001.02	Hatchback Engine F3R768	•		GWB3492	
	1995.06-2001.02	Hatchback Engine F3R768	•		GWB3495	
	1995.06-2001.02	Hatchback Engine F3R768	•		GWB3596	
	1995.06-2001.02	Hatchback Engine F3R768		o	GHA225003	K
	1995.06-2001.02	Hatchback Engine F3R768		o	GHA225027	K
	1995.06-2001.02	Hatchback Engine F3R768		o	GHA225035	K
	1995.06-2001.02	Hatchback Engine F3R768		o	GWB0976	
	1995.06-2001.02	Hatchback Engine F3R768		o	GWB0976	
2.0 16V (102 kW)	1995.06-2001.03	Hatchback Engine N7Q700/N7Q704	•		GHA423001	
	1995.06-2001.03	Hatchback Engine N7Q700/N7Q704	•		GWB3492	
	1995.06-2001.03	Hatchback Engine N7Q700/N7Q704	•		GWB3495	
	1995.06-2001.03	Hatchback Engine N7Q700/N7Q704		o	GHA225003	K
	1995.06-2001.03	Hatchback Engine N7Q700/N7Q704		o	GHA225035	K
2.0 16V (103 kW)	1999.09-2001.03	Hatchback Engine F4R780	•		GHA423001	
	1999.09-2001.03	Hatchback Engine F4R780	•		GWB3492	
	1999.09-2001.03	Hatchback Engine F4R780		o	GHA225027	K
2.2 D (61 kW)	1993.11-2001.03	Hatchback Engine G8T706/G8T752/G8T790/G8T794	•		GHA421004	A
	1993.11-2001.03	Hatchback Engine G8T706/G8T752/G8T790/G8T794	•		GHA423001	
	1993.11-2001.03	Hatchback Engine G8T706/G8T752/G8T790/G8T794	•		GWB3492	
	1993.11-2001.03	Hatchback Engine G8T706/G8T752/G8T790/G8T794	•		GWB3495	
	1993.11-2001.03	Hatchback Engine G8T706/G8T752/G8T790/G8T794		o	GHA225006	F
	1993.11-2001.03	Hatchback Engine G8T706/G8T752/G8T790/G8T794		o	GHA225006	K
2.2 DT (83 kW)	1996.03-2001.03	Hatchback Engine G8T760	•		GHA423001	
	1996.03-2001.03	Hatchback Engine G8T760	•		GWB3492	



	 YEAR		F	R	G-AP Ref.	KIT
RENAULT						
LAGUNA I (B56_, 556_)						
2.2 DT (83 kW)	1996.03-2001.03	Hatchback Engine G8T760	•		GWB3495	
	1996.03-2001.03	Hatchback Engine G8T760		◦	GHA225003	K
	1996.03-2001.03	Hatchback Engine G8T760		◦	GHA225027	K
	1996.03-2001.03	Hatchback Engine G8T760		◦	GHA225035	K
3.0 (123 kW)	1993.11-2001.03	Hatchback Engine Z7X760/Z7X765	•		GHA423001	
	1993.11-2001.03	Hatchback Engine Z7X760/Z7X765	•		GWB3492	
	1993.11-2001.03	Hatchback Engine Z7X760/Z7X765	•		GWB3495	
	1993.11-2001.03	Hatchback Engine Z7X760/Z7X765		◦	GHA225003	K
	1993.11-2001.03	Hatchback Engine Z7X760/Z7X765		◦	GHA225035	K
3.0 24V (140 kW)	1997.03-2001.03	Hatchback Engine L7X700/L7X701	•		GHA423001	
	1997.03-2001.03	Hatchback Engine L7X700/L7X701	•		GWB3492	
	1997.03-2001.03	Hatchback Engine L7X700/L7X701		◦	GHA225027	K
	1997.03-2001.03	Hatchback Engine L7X700/L7X701		◦	GHA225035	K
LAGUNA I (K56_)						
1.6 16V (79 kW)	1997.11-2001.03	Estate Engine K4M720	•		GHA423001	
	1997.11-2001.03	Estate Engine K4M720	•		GWB3492	
	1997.11-2001.03	Estate Engine K4M720		◦	GHA225022	K
	1997.11-2001.03	Estate Engine K4M720		◦	GHA225028	K
1.8 (66 kW)	1995.09-2001.03	Estate Engine F3P670/F3P678	•		GHA423001	
	1995.09-2001.03	Estate Engine F3P670/F3P678	•		GWB3492	
	1995.09-2001.03	Estate Engine F3P670/F3P678	•		GWB3495	
	1995.09-2001.03	Estate Engine F3P670/F3P678		◦	GHA225022	K
1.8 (69 kW)	1995.09-2001.03	Estate Engine F3P720/F3P724	•		GHA423001	
	1995.09-2001.03	Estate Engine F3P720/F3P724	•		GWB3495	
	1995.09-2001.03	Estate Engine F3P720/F3P724		◦	GHA225022	K
1.8 16V (88 kW)	1998.04-2001.03	Estate Engine F4P760	•		GHA423001	
	1998.04-2001.03	Estate Engine F4P760	•		GWB3492	
	1998.04-2001.03	Estate Engine F4P760		◦	GHA225022	K
	1998.04-2001.03	Estate Engine F4P760		◦	GHA225028	K
1.9 DCi (79 kW)	1999.09-2001.03	Estate Engine F9Q718	•		GHA423001	
	1999.09-2001.03	Estate Engine F9Q718	•		GWB3492	
	1999.09-2001.03	Estate Engine F9Q718		◦	GHA225028	K
1.9 DTi (72 kW)	1997.10-2001.03	Estate Engine F9Q710/F9Q716//F9Q717	•		GHA423001	
	1997.10-2001.03	Estate Engine F9Q710/F9Q716//F9Q717	•		GWB3492	
	1997.10-2001.03	Estate Engine F9Q710/F9Q716//F9Q717		◦	GHA225022	K
	1997.10-2001.03	Estate Engine F9Q710/F9Q716//F9Q717		◦	GHA225028	K
2.0 (83 kW)	1995.09-2001.03	Estate Engine F3R722/F3R723	•		GHA423001	
	1995.09-2001.03	Estate Engine F3R722/F3R723	•		GWB3492	
	1995.09-2001.03	Estate Engine F3R722/F3R723	•		GWB3495	
	1995.09-2001.03	Estate Engine F3R722/F3R723		◦	GHA225022	K
	1995.09-2001.03	Estate Engine F3R722/F3R723		◦	GHA225028	K
2.0 16V (102 kW)	1995.09-2001.03	Estate Engine N7Q700/N7Q704	•		GHA423001	
	1995.09-2001.03	Estate Engine N7Q700/N7Q704	•		GWB3492	
	1995.09-2001.03	Estate Engine N7Q700/N7Q704	•		GWB3495	
	1995.09-2001.03	Estate Engine N7Q700/N7Q704		◦	GHA225036	K
2.0 16V (103 kW)	1998.05-2000.11	Estate Engine F4R780	•		GWB3492	
	1998.05-2000.11	Estate Engine F4R780		◦	GHA225028	K
2.2 D (61 kW)	1995.09-2001.03	Estate Engine G8T706/G8T752/G8T790/G8T794	•		GHA423001	
	1995.09-2001.03	Estate Engine G8T706/G8T752/G8T790/G8T794	•		GWB3492	
	1995.09-2001.03	Estate Engine G8T706/G8T752/G8T790/G8T794	•		GWB3495	
	1995.09-2001.03	Estate Engine G8T706/G8T752/G8T790/G8T794		◦	GHA225022	K
2.2 DT (83 kW)	1996.03-2001.03	Estate Engine G8T760	•		GHA423001	
	1996.03-2001.03	Estate Engine G8T760	•		GWB3492	
	1996.03-2001.03	Estate Engine G8T760	•		GWB3495	
	1996.03-2001.03	Estate Engine G8T760		◦	GHA225028	K
	1996.03-2001.03	Estate Engine G8T760		◦	GHA225036	K
3.0 (123 kW)	1996.02-2001.03	Estate Engine Z7X765	•		GHA423001	
	1996.02-2001.03	Estate Engine Z7X765	•		GWB3492	
	1996.02-2001.03	Estate Engine Z7X765	•		GWB3495	
	1996.02-2001.03	Estate Engine Z7X765		◦	GHA225036	K
3.0 24V (140 kW)	1997.03-2001.03	Estate Engine L7X700/L7X701	•		GHA423001	
	1997.03-2001.03	Estate Engine L7X700/L7X701	•		GWB3492	
	1997.03-2001.03	Estate Engine L7X700/L7X701		◦	GHA225028	K



	 YEAR		F	R	G-AP Ref.	KIT
RENAULT						
LAGUNA II (BG0/1_)						
1.6 16V (79 kW)	2001.03-	Hatchback Engine K4M710/K4M714	•		GWB3608	
	2001.03-	Hatchback Engine K4M710/K4M714		◦	GHA230141	K
1.6 16V (82 kW)	2005.02-	Hatchback Engine K4M716	•		GWB3608	
	2005.02-	Hatchback Engine K4M716		◦	GHA230141	K
1.8 16V (85 kW)	2001.03-	Hatchback Engine F4P770/F4P771/F4P773/F4P774/F4P775	•		GWB3608	
	2001.03-	Hatchback Engine F4P770/F4P771/F4P773/F4P774/F4P775		◦	GHA230141	K
1.8 16V (86 kW)	2001.03-	Hatchback Engine F4P770/F4P774	•		GWB3608	
	2001.03-	Hatchback Engine F4P770/F4P774		◦	GHA230141	K
1.8 16V (88 kW)	2001.03-	Hatchback Engine F4P770/F4P773	•		GWB3608	
	2001.03-	Hatchback Engine F4P770/F4P773		◦	GHA230141	K
1.8 16V (89 kW)	2001.03-	Hatchback Engine F4P770/F4P772	•		GWB3608	
	2001.03-	Hatchback Engine F4P770/F4P772		◦	GHA230141	K
1.9 DCi (68 kW)	2005.02-2007.04	Hatchback Engine F9Q664	•		GWB3608	
	2005.02-2007.04	Hatchback Engine F9Q664		◦	GHA230141	K
1.9 DCi (74 kW)	2001.10-	Hatchback Engine F9Q754	•		GWB3608	
	2001.10-	Hatchback Engine F9Q754		◦	GHA230141	K
1.9 DCi (77 kW)	2001.06-	Hatchback Engine F9Q752	•		GWB3608	
	2001.06-	Hatchback Engine F9Q752		◦	GHA230141	K
1.9 DCi (79 kW)	2001.03-	Hatchback Engine F9Q718/F9Q754	•		GWB3608	
	2001.03-	Hatchback Engine F9Q718/F9Q754		◦	GHA230141	K
1.9 DCi (81 kW)	2005.01-	Hatchback Engine F9Q674/F9Q758	•		GWB3608	
	2005.01-	Hatchback Engine F9Q674/F9Q758		◦	GHA230141	K
1.9 DCi (85 kW)	2005.09-	Hatchback	•		GWB3608	
1.9 DCi (88 kW)	2001.03-	Hatchback Engine F9Q670/F9Q674/F9Q750	•		GWB3608	
	2001.03-	Hatchback Engine F9Q670/F9Q674/F9Q750		◦	GHA230141	K
1.9 DCi (92 kW)	2005.09-	Hatchback	•		GWB3608	
1.9 DCi (96 kW)	2005.02-2007.04	Hatchback Engine F9Q758/F9Q759	•		GWB3608	
	2005.02-2007.04	Hatchback Engine F9Q758/F9Q759		◦	GHA230141	K
2.0 16V (125 kW)	2005.02-2007.07	Hatchback Engine F4R784/F4R786/F4R787	•		GWB3608	
	2005.02-2007.07	Hatchback Engine F4R784/F4R786/F4R787		◦	GHA230141	K
2.0 16V (150 kW)	2005.01-	Hatchback Engine F4R886/F4R887	•		GWB3608	
	2005.01-	Hatchback Engine F4R886/F4R887		◦	GHA230141	K
2.0 16V (98 kW)	2002.08-	Hatchback Engine F4R714	•		GWB3608	
2.0 16V (99 kW)	2001.08-2007.07	Hatchback Engine F4R712/F4R713/F4R714/F4R715	•		GWB3608	
	2001.08-2007.07	Hatchback Engine F4R712/F4R713/F4R714/F4R715		◦	GHA230141	K
2.0 16V iDE (103 kW)	2001.04-	Hatchback Engine F5R700/F5R701	•		GWB3608	
	2001.04-	Hatchback Engine F5R700/F5R701		◦	GHA230141	K
2.0 16V Turbo (120 kW)	2002.11-2005.02	Hatchback Engine F4R764/F4R765/F4R786/F4R787	•		GWB3608	
	2002.11-2005.02	Hatchback Engine F4R764/F4R765/F4R786/F4R787		◦	GHA230141	K
2.0 DCi (110 kW)	2005.08-	Hatchback Engine M9R740	•		GWB3608	
	2005.08-	Hatchback Engine M9R740		◦	GHA230141	K
2.0 DCi (127 kW)	2005.11-2007.08	Hatchback Engine M9R760	•		GWB3608	
	2005.11-2007.08	Hatchback Engine M9R760		◦	GHA230141	K
2.2 DCi (102 kW)	2005.02-2007.07	Hatchback Engine G9T600/G9T605/G9T706/G9T707	•		GWB3608	
	2005.02-2007.07	Hatchback Engine G9T600/G9T605/G9T706/G9T707		◦	GHA230141	K
2.2 DCi (110 kW)	2001.10-	Hatchback Engine G9T700/G9T702	•		GWB3608	
	2001.10-	Hatchback Engine G9T700/G9T702		◦	GHA230141	K
2.2 DCi (85 kW)	2004.04-2005.10	Hatchback Engine G9T600	•		GWB3608	
3.0 V6 24V (152 kW)	2001.03-	Hatchback Engine L7X731	•		GWB3608	
	2001.03-	Hatchback Engine L7X731		◦	GHA230141	K
LAGUNA II GRANDTOUR (KG0/1_)						
1.6 FlexFuel (76 kW)	2001.06-2003.1	Estate Engine K4M 718	•		GWB3608	
	2001.06-2003.1	Estate Engine K4M 718		◦	GHA230141	K
LAGUNA II SPORT TOURER (KG0/1_)						
1.6 16V (79 kW)	2001.03-	Estate Engine K4M710/K4M714	•		GWB3608	
	2001.03-	Estate Engine K4M710/K4M714		◦	GHA230141	K
1.6 16V (82 kW)	2005.02-	Estate Engine K4M716	•		GWB3608	
	2005.02-	Estate Engine K4M716		◦	GHA230141	K
1.8 16V (85 kW)	2001.03-	Estate Engine F4P770/F4P771/F4P774/F4P775	•		GWB3608	
	2001.03-	Estate Engine F4P770/F4P771/F4P774/F4P775		◦	GHA230141	K
1.8 16V (86 kW)	2001.03-	Estate Engine F4P770	•		GWB3608	
	2001.03-	Estate Engine F4P770		◦	GHA230141	K
1.8 16V (88 kW)	2001.03-	Estate Engine F4P770/F4P773	•		GWB3608	
	2001.03-	Estate Engine F4P770/F4P773		◦	GHA230141	K



	 YEAR		F	R	G-AP Ref.	KIT
RENAULT						
LAGUNA II SPORT TOURER (KG0/1_)						
1.8 16V (89 kW)	2001.03-	Estate Engine F4P770/F4P774	•		GWB3608	
	2001.03-	Estate Engine F4P770/F4P774		◦	GHA230141	K
1.9 DCi (66 kW)	2003.08-2007.09	Estate	•		GWB3608	
1.9 DCi (68 kW)	2004.03-	Estate Engine F9Q664	•		GWB3608	
	2004.03-	Estate Engine F9Q664		◦	GHA230141	K
1.9 DCi (74 kW)	2001.10-	Estate Engine F9Q754	•		GWB3608	
	2001.10-	Estate Engine F9Q754		◦	GHA230141	K
1.9 DCi (77 kW)	2001.06-	Estate Engine F9Q752	•		GWB3608	
	2001.06-	Estate Engine F9Q752		◦	GHA230141	K
1.9 DCi (79 kW)	2001.03-	Estate Engine F9Q718/F9Q754	•		GWB3608	
	2001.03-	Estate Engine F9Q718/F9Q754		◦	GHA230141	K
1.9 DCi (81 kW)	2005.01-	Estate Engine F9Q674/F9Q758	•		GWB3608	
1.9 DCi (85 kW)	2005.08-2007.09	Estate Engine F9Q758/F9Q759	•		GWB3608	
1.9 DCi (88 kW)	2001.03-	Estate Engine F9Q670/F9Q674/F9Q750	•		GWB3608	
	2001.03-	Estate Engine F9Q670/F9Q674/F9Q750		◦	GHA230141	K
1.9 DCi (92 kW)	2005.09-	Estate	•		GWB3608	
1.9 DCi (96 kW)	2005.02-2007.04	Estate Engine F9Q758/F9Q759	•		GWB3608	
	2005.02-2007.04	Estate Engine F9Q758/F9Q759		◦	GHA230141	K
2.0 16V (125 kW)	2005.02-2007.07	Estate Engine F4R784/F4R786/F4R787	•		GWB3608	
	2005.02-2007.07	Estate Engine F4R784/F4R786/F4R787		◦	GHA230141	K
2.0 16V (150 kW)	2003.10-2007.08	Estate Engine F4R886/F4R887	•		GWB3608	
	2003.10-2007.08	Estate Engine F4R886/F4R887		◦	GHA230141	K
2.0 16V (98 kW)	2004.10-2007.09	Estate	•		GWB3608	
2.0 16V (99 kW)	2002.06-2007.07	Estate Engine F4R712/F4R713/F4R714/F4R715	•		GWB3608	
	2002.06-2007.07	Estate Engine F4R712/F4R713/F4R714/F4R715		◦	GHA230141	K
2.0 16V iDE (103 kW)	2001.04-	Estate Engine F5R700/F5R701	•		GWB3608	
	2001.04-	Estate Engine F5R700/F5R701		◦	GHA230141	K
2.0 16V Turbo (120 kW)	2002.11-2005.02	Estate Engine F4R764/F4R765/F4R786/F4R787	•		GWB3608	
	2002.11-2005.02	Estate Engine F4R764/F4R765/F4R786/F4R787		◦	GHA230141	K
2.0 DCi (110 kW)	2005.08-	Estate Engine M9R740	•		GWB3608	
	2005.08-	Estate Engine M9R740		◦	GHA230141	K
2.0 DCi (127 kW)	2005.11-2007.08	Estate Engine M9R760	•		GWB3608	
	2005.11-2007.08	Estate Engine M9R760		◦	GHA230141	K
2.2 DCi (102 kW)	2005.02-2006.02	Estate Engine G9T600/G9T706/G9T707	•		GWB3608	
	2005.02-2006.02	Estate Engine G9T600/G9T706/G9T707		◦	GHA230141	K
2.2 DCi (110 kW)	2001.10-	Estate Engine G9T702	•		GWB3608	
	2001.10-	Estate Engine G9T702		◦	GHA230141	K
2.2 DCi (85 kW)	2004.04-2005.10	Estate Engine G9T600	•		GWB3608	
3.0 V6 24V (152 kW)	2001.03-	Estate Engine L7X731	•		GWB3608	
	2001.03-	Estate Engine L7X731		◦	GHA230141	K
LAGUNA III (BT0/1)						
1.5 DCi (81 kW)	2007.10-	Hatchback Engine K9K780	•		GWB3608	
	2007.10-	Hatchback Engine K9K780		◦	GHA230143	K
1.6 16V (81 kW)	2007.10-	Hatchback Engine K4M824	•		GWB3608	
	2007.10-	Hatchback Engine K4M824		◦	GHA230143	K
2.0 16V (103 kW)	2007.10-	Hatchback Engine M4R 704		◦	GHA230143	K
2.0 16V Hi-Flex (103 kW)	2007.10-	Hatchback Engine M4R 726		◦	GHA230143	K
2.0 16V Turbo (125 kW)	2007.10-	Hatchback Engine F4R 811		◦	GHA230143	K
2.0 DCi (110 kW)	2007.10-	Hatchback Engine M9R802/M9R805/M9R814		◦	GHA230143	K
2.0 DCi (127 kW)	2008.01-	Hatchback Engine M9R 800/M9R 809/M9R 815		◦	GHA230143	K
2.0 DCi (96 kW)	2007.10-	Hatchback Engine M9R742/M9R744/M9R802		◦	GHA230143	K
2.0 DCi GT (131 kW)	2008.03-	Hatchback Engine M9R 816		◦	GHA230143	K
2.0 GT (150 kW)	2008.03-	Hatchback Engine F4R 800		◦	GHA230143	K
3.0 DCi (BT03, BT13) (173 kW)	2008.09-	Hatchback Engine V9X 791/V9X 891		◦	GHA230143	K
LAGUNA III GRANDTOUR (KT0/1)						
2.0 16V 103 kW)	2007.10-	Estate Engine M4R704		◦	GHA230143	K
2.0 16V Hi-Flex (103 kW)	2007.10-	Estate Engine M4R 704/M4R 726		◦	GHA230143	K
2.0 16V Turbo (125 kW)	2007.10-	Estate Engine F4R 811		◦	GHA230143	K
2.0 DCi (110 kW)	2007.10-	Estate Engine M9R802/M9R805/M9R814		◦	GHA230143	K
2.0 DCi (127 kW)	2008.01-	Estate Engine M9R 800/M9R 809/M9R 815		◦	GHA230143	K
2.0 DCi (96 kW)	2007.10-	Estate Engine M9R742/M9R744/M9R802		◦	GHA230143	K
2.0 DCi GT (131 kW)	2008.03-	Estate Engine M9R 816/M9R 820		◦	GHA230143	K
2.0 GT (150 kW)	2008.03-	Estate Engine F4R 800		◦	GHA230143	K
3.0 DCi (KT03, KT13) (173 kW)	2008.09-	Estate Engine V9X 791/V9X 891		◦	GHA230143	K



	 YEAR		F	R	G-AP Ref.	KIT
RENAULT						
LAGUNA III SPORT TOURER (KT0/1)						
1.5 DCi (81 kW)	2007.10-	Estate Engine K9K780	•		GWB3608	
	2007.10-	Estate Engine K9K780		◦	GHA230143	K
1.6 16V (81 kW)	2007.10-	Estate Engine K4M824	•		GWB3608	
	2007.10-	Estate Engine K4M824		◦	GHA230143	K
LATITUDE (L70_)						
1.5 DCi (L70R) (81 kW)	2010.07-	Saloon Engine K9K 782		◦	GHA230143	K
2.0 16V (L70B) (103 kW)	2011.02-	Saloon Engine M4R 746		◦	GHA230143	K
2.0 DCi (130 kW)	2011.02-	Saloon		◦	GHA230143	K
2.0 DCi 150 (L70H) (110 kW)	2011.02-	Saloon Engine M9R 824/M9R 846		◦	GHA230143	K
2.0 DCi 175 (L70Y) (127 kW)	2011.05-	Saloon Engine M9R 804/M9R 817/M9R 844		◦	GHA230143	K
3.0 DCi 240 (L70G) (177 kW)	2011.02-	Saloon Engine V9X 891		◦	GHA230143	K
LOGAN (KS_)						
1.4 (55 kW)	2007.10-	Estate Engine K7J710	•		GWB3596	
	2007.10-	Estate Engine K7J710	•		GWB3637	
	2007.10-	Estate Engine K7J710		◦	GWB3525	
	2007.10-	Estate Engine K7J710		◦	GWB6658	
1.5 DCi (50 kW)	2007.04-	Estate Engine K9K792	•		GHA423003	K
	2007.04-	Estate Engine K9K792	•		GWB3596	
	2007.04-	Estate Engine K9K792	•		GWB3637	
	2007.04-	Estate Engine K9K792		◦	GWB3525	
	2007.04-	Estate Engine K9K792		◦	GWB6658	
1.5 DCi (63 kW)	2008.02-	Estate Engine K9K796	•		GWB3596	
	2008.02-	Estate Engine K9K796	•		GWB3637	
	2008.02-	Estate Engine K9K796		◦	GWB3525	
	2008.02-	Estate Engine K9K796		◦	GWB6658	
1.6 (64 kW)	2007.04-	Estate Engine K7M710	•		GWB3596	
	2007.04-	Estate Engine K7M710	•		GWB3637	
	2007.04-	Estate Engine K7M710		◦	GWB3525	
	2007.04-	Estate Engine K7M710		◦	GWB6658	
1.6 (77 kW)	2007.04-	Estate Engine K7M697	•		GWB3596	
	2007.04-	Estate Engine K7M697	•		GWB3637	
	2007.04-	Estate Engine K7M697		◦	GWB3525	
	2007.04-	Estate Engine K7M697		◦	GWB6658	
LOGAN (LS_)						
1.4 (55 kW)	2004.09-	Saloon Engine K7J710	•		GHA421012	
	2004.09-	Saloon Engine K7J710	•		GWB3596	
	2004.09-	Saloon Engine K7J710	•		GWB3637	
	2004.09-	Saloon Engine K7J710	•		GWB6561	
	2004.09-	Saloon Engine K7J710		◦	GWB3525	
	2004.09-	Saloon Engine K7J710		◦	GWB6658	
1.5 DCi (50 kW)	2007.04-	Saloon Engine K9K792	•		GHA423003	K
	2007.04-	Saloon Engine K9K792	•		GWB3596	
	2007.04-	Saloon Engine K9K792	•		GWB3637	
	2007.04-	Saloon Engine K9K792		◦	GWB3525	
	2007.04-	Saloon Engine K9K792		◦	GWB6658	
1.5 DCi (63 kW)	2008.02-	Saloon Engine K9K796	•		GWB3596	
	2008.02-	Saloon Engine K9K796	•		GWB3637	
	2008.02-	Saloon Engine K9K796		◦	GWB3525	
	2008.02-	Saloon Engine K9K796		◦	GWB6658	
1.6 (64 kW)	2004.09-	Saloon Engine K7M710	•		GHA421012	
	2004.09-	Saloon Engine K7M710	•		GWB3596	
	2004.09-	Saloon Engine K7M710	•		GWB3637	
	2004.09-	Saloon Engine K7M710	•		GWB6561	
	2004.09-	Saloon Engine K7M710		◦	GWB3525	
	2004.09-	Saloon Engine K7M710		◦	GWB6658	
1.6 (77 kW)	2007.04-	Saloon Engine K7M690	•		GWB3596	
	2007.04-	Saloon Engine K7M690	•		GWB3637	
	2007.04-	Saloon Engine K7M690		◦	GWB3525	
	2007.04-	Saloon Engine K7M690		◦	GWB6658	
LOGAN EXPRESS						
1.5 DCi (50 kW)	2007.04-	Box	•		GWB3596	
	2007.04-	Box	•		GWB3637	
	2007.04-	Box		◦	GWB3525	
	2007.04-	Box		◦	GWB6658	



	 YEAR		F	R	G-AP Ref.	KIT
RENAULT						
LOGAN EXPRESS						
1.6 (64 kW)	2007.04-	Box	•		GWB3596	
	2007.04-	Box	•		GWB3637	
	2007.04-	Box		○	GWB3525	
	2007.04-	Box		○	GWB6658	
LOGAN I (KS_)						
1.5 DCi (48 kW)	2011.06-	Estate Engine K9K 790/K9K 794	•		GWB3596	
	2011.06-	Estate Engine K9K 790/K9K 794	•		GWB3637	
	2011.06-	Estate Engine K9K 790/K9K 794		○	GWB3525	
	2011.06-	Estate Engine K9K 790/K9K 794		○	GWB6658	
1.5 DCi (66 kW)	2011.06-	Estate	•		GWB3596	
	2011.06-	Estate	•		GWB3637	
	2011.06-	Estate		○	GWB3525	
	2011.06-	Estate		○	GWB6658	
LOGAN I (LS_)						
1.5 DCi (48 kW)	2011.06-	Saloon Engine K9K 790/K9K 794	•		GWB3596	
	2011.06-	Saloon Engine K9K 790/K9K 794	•		GWB3637	
	2011.06-	Saloon Engine K9K 790/K9K 794		○	GWB3525	
	2011.06-	Saloon Engine K9K 790/K9K 794		○	GWB6658	
LOGAN II						
1.2 (55 kW)	2013.11-	Saloon Engine D4F732	•		GWB3596	
	2013.11-	Saloon Engine D4F732	•		GWB3637	
	2013.11-	Saloon Engine D4F732		○	GWB6658	
1.2 16V (54 kW)	2013.12-	Estate	•		GWB3596	
	2013.12-	Estate	•		GWB3637	
	2013.12-	Estate		○	GWB6658	
1.2 16V LPG (53 kW)	2013.12-	Estate	•		GWB3596	
	2013.12-	Estate	•		GWB3637	
	2013.12-	Estate		○	GWB6658	
1.5 DCi (62 kW)	2013.12-	Estate Engine K9K 838	•		GWB3596	
	2013.12-	Estate Engine K9K 838	•		GWB3637	
	2013.12-	Estate Engine K9K 838		○	GWB6658	
1.6 (59 kW)	2013.12-	Estate	•		GWB3596	
	2013.12-	Estate	•		GWB3637	
	2013.12-	Estate		○	GWB6658	
1.6 (60 kW)	2014.04-	Saloon	•		GWB3596	
	2014.04-	Saloon	•		GWB3637	
	2014.04-	Saloon		○	GWB6658	
1.6 (75 kW)	2014.04-	Saloon	•		GWB3596	
	2014.04-	Saloon	•		GWB3637	
	2014.04-	Saloon		○	GWB6658	
MASTER II (ED/HD/UD)						
2.2 DCi (66 kW)	2000.09-	Platform/Chassis Engine G9T720/G9T722/G9T750	•		GWB3613	
	2000.09-	Platform/Chassis Engine G9T720/G9T722/G9T750		○	GWB3501	
	2000.09-	Platform/Chassis Engine G9T720/G9T722/G9T750		○	GWB3614	
2.5 D (59 kW)	1998.07-2001.01	Platform/Chassis Engine S8U770	•		GWB3500	
	1998.07-2001.01	Platform/Chassis Engine S8U770	•		GWB3613	
	1998.07-2001.01	Platform/Chassis Engine S8U770		○	GWB3501	
	1998.07-2001.01	Platform/Chassis Engine S8U770		○	GWB3614	
2.5 DCi (107 kW)	2006.08-	Platform/Chassis Engine G9U632	•		GWB3613	
	2006.08-	Platform/Chassis Engine G9U632		○	GWB3501	
	2006.08-	Platform/Chassis Engine G9U632		○	GWB3614	
2.5 DCi (73 kW)	2003.10-	Platform/Chassis Engine G9U754	•		GWB3613	
	2003.10-	Platform/Chassis Engine G9U754		○	GWB3501	
	2003.10-	Platform/Chassis Engine G9U754		○	GWB3614	
2.5 DCi (74 kW)	2006.08-	Platform/Chassis Engine G9U754	•		GWB3613	
	2006.08-	Platform/Chassis Engine G9U754		○	GWB3501	
	2006.08-	Platform/Chassis Engine G9U754		○	GWB3614	
2.5 DCi (84 kW)	2001.10-	Platform/Chassis Engine G9U720/G9U754	•		GWB3613	
	2001.10-	Platform/Chassis Engine G9U720/G9U754		○	GWB3501	
	2001.10-	Platform/Chassis Engine G9U720/G9U754		○	GWB3614	
	2004.01-	Platform/Chassis Engine G9U750	•		GWB3613	
	2004.01-	Platform/Chassis Engine G9U750		○	GWB3501	
	2004.01-	Platform/Chassis Engine G9U750		○	GWB3614	
2.5 DCi (88 kW)	2006.08-	Platform/Chassis Engine G9U650	•		GWB3613	



	 YEAR		F	R	G-AP Ref.	KIT
RENAULT						
MASTER II (ED/HD/UD)						
2.5 DCi (88 kW)	2006.08-	Platform/Chassis Engine G9U650		o	GWB3501	
	2006.08-	Platform/Chassis Engine G9U650		o	GWB3614	
2.8 DTi (84 kW)	1998.07-2001.10	Platform/Chassis Engine S9W702	•		GWB3500	
	1998.07-2001.10	Platform/Chassis Engine S9W702	•		GWB3613	
	1998.07-2001.10	Platform/Chassis Engine S9W702		o	GWB3501	
	1998.07-2001.10	Platform/Chassis Engine S9W702		o	GWB3614	
3.0 DCi (100 kW)	2003.10-	Platform/Chassis Engine ZD3202	•		GWB3613	
	2003.10-	Platform/Chassis Engine ZD3202		o	GWB3501	
	2003.10-	Platform/Chassis Engine ZD3202		o	GWB3614	
3.0 DCi (115 kW)	2005.06-	Platform/Chassis Engine ZD3A604	•		GWB3613	
	2005.06-	Platform/Chassis Engine ZD3A604		o	GWB3501	
	2005.06-	Platform/Chassis Engine ZD3A604		o	GWB3614	
3.0 DCi (85 kW)	2005.06-	Platform/Chassis Engine ZD3600	•		GWB3613	
	2005.06-	Platform/Chassis Engine ZD3600		o	GWB3501	
	2005.06-	Platform/Chassis Engine ZD3600		o	GWB3614	
MASTER II (JD)						
1.9 DCi (60 kW)	2001.11-	Bus Engine F9Q772/F9Q774	•		GWB3613	
	2001.11-	Bus Engine F9Q772/F9Q774		o	GWB3501	
	2001.11-	Bus Engine F9Q772/F9Q774		o	GWB3614	
1.9 DTi (59 kW)	2000.09-	Bus Engine F9Q770	•		GWB3613	
	2000.09-	Bus Engine F9Q770		o	GWB3501	
	2000.09-	Bus Engine F9Q770		o	GWB3614	
2.2 DCi (66 kW)	2000.09-	Bus Engine G9T720/G9T722/G9T750	•		GWB3613	
	2000.09-	Bus Engine G9T720/G9T722/G9T750		o	GWB3501	
	2000.09-	Bus Engine G9T720/G9T722/G9T750		o	GWB3614	
2.5 D (59 kW)	1998.07-2001.01	Bus Engine S8U770	•		GWB3500	
	1998.07-2001.01	Bus Engine S8U770	•		GWB3613	
	1998.07-2001.01	Bus Engine S8U770		o	GWB3501	
	1998.07-2001.01	Bus Engine S8U770		o	GWB3614	
2.5 DCi (107 kW)	2006.08-	Bus Engine G9U632	•		GWB3613	
	2006.08-	Bus Engine G9U632		o	GWB3501	
	2006.08-	Bus Engine G9U632		o	GWB3614	
2.5 DCi (73 kW)	2003.10-	Bus Engine G9U754	•		GWB3613	
	2003.10-	Bus Engine G9U754		o	GWB3501	
	2003.10-	Bus Engine G9U754		o	GWB3614	
2.5 DCi (74 kW)	2006.08-	Bus Engine G9U754	•		GWB3613	
	2006.08-	Bus Engine G9U754		o	GWB3501	
	2006.08-	Bus Engine G9U754		o	GWB3614	
2.5 DCi (84 kW)	2001.10-	Bus Engine G9U720/G9U754	•		GWB3613	
	2001.10-	Bus Engine G9U720/G9U754		o	GWB3501	
	2001.10-	Bus Engine G9U720/G9U754		o	GWB3614	
	2004.01-	Bus Engine G9U750	•		GWB3613	
	2004.01-	Bus Engine G9U750		o	GWB3501	
	2004.01-	Bus Engine G9U750		o	GWB3614	
2.5 DCi (88 kW)	2006.08-	Bus Engine G9U650	•		GWB3613	
	2006.08-	Bus Engine G9U650		o	GWB3501	
	2006.08-	Bus Engine G9U650		o	GWB3614	
2.8 DTi (84 kW)	1998.07-2001.10	Bus Engine S9W702	•		GWB3500	
	1998.07-2001.10	Bus Engine S9W702	•		GWB3613	
	1998.07-2001.10	Bus Engine S9W702		o	GWB3501	
	1998.07-2001.10	Bus Engine S9W702		o	GWB3614	
3.0 DCi (100 kW)	2003.10-	Bus Engine ZD3200/ZD3202	•		GWB3613	
	2003.10-	Bus Engine ZD3200/ZD3202		o	GWB3501	
	2003.10-	Bus Engine ZD3200/ZD3202		o	GWB3614	
MASTER II VAN (FD)						
1.9 DCi (60 kW)	2001.11-	Box Engine F9Q772/F9Q774	•		GWB3613	
	2001.11-	Box Engine F9Q772/F9Q774		o	GWB3501	
	2001.11-	Box Engine F9Q772/F9Q774		o	GWB3614	
1.9 DTi (59 kW)	2000.09-	Box Engine F9Q770	•		GWB3613	
	2000.09-	Box Engine F9Q770		o	GWB3501	
	2000.09-	Box Engine F9Q770		o	GWB3614	
2.2 DCi (66 kW)	2000.09-	Box Engine G9T720/G9T722/G9T750	•		GWB3613	
	2000.09-	Box Engine G9T720/G9T722/G9T750		o	GWB3501	
	2000.09-	Box Engine G9T720/G9T722/G9T750		o	GWB3614	



	 YEAR		F	R	G-AP Ref.	KIT
RENAULT						
MASTER II VAN (FD)						
2.5 D (59 kW)	1998.07-2001.01	Box Engine S8U770	•		GWB3500	
	1998.07-2001.01	Box Engine S8U770	•		GWB3613	
	1998.07-2001.01	Box Engine S8U770		○	GWB3501	
	1998.07-2001.01	Box Engine S8U770		○	GWB3614	
2.5 DCi (107 kW)	2006.08-	Box Engine G9U632	•		GWB3613	
	2006.08-	Box Engine G9U632		○	GWB3501	
	2006.08-	Box Engine G9U632		○	GWB3614	
2.5 DCi (73 kW)	2003.10-	Box Engine G9U754	•		GWB3613	
	2003.10-	Box Engine G9U754		○	GWB3501	
	2003.10-	Box Engine G9U754		○	GWB3614	
2.5 DCi (74 kW)	2006.08-	Box Engine G9U754	•		GWB3613	
	2006.08-	Box Engine G9U754		○	GWB3501	
	2006.08-	Box Engine G9U754		○	GWB3614	
2.5 DCi (84 kW)	2001.10-	Box Engine G9U720/G9U754/G9U724	•		GWB3613	
	2001.10-	Box Engine G9U720/G9U754/G9U724		○	GWB3501	
	2001.10-	Box Engine G9U720/G9U754/G9U724		○	GWB3614	
	2004.01-	Box Engine G9U750	•		GWB3613	
	2004.01-	Box Engine G9U750		○	GWB3501	
2.5 DCi (88 kW)	2006.08-	Box Engine G9U650	•		GWB3613	
	2006.08-	Box Engine G9U650		○	GWB3501	
	2006.08-	Box Engine G9U650		○	GWB3614	
2.8 DTi (84 kW)	1998.07-2001.10	Box Engine S9W702	•		GWB3500	
	1998.07-2001.10	Box Engine S9W702	•		GWB3613	
	1998.07-2001.10	Box Engine S9W702		○	GWB3501	
	1998.07-2001.10	Box Engine S9W702		○	GWB3614	
3.0 DCi (100 kW)	2003.10-	Box Engine ZD3202	•		GWB3613	
	2003.10-	Box Engine ZD3202		○	GWB3501	
	2003.10-	Box Engine ZD3202		○	GWB3614	
3.0 DCi (115 kW)	2005.06-	Box Engine ZD3A604	•		GWB3613	
	2005.06-	Box Engine ZD3A604		○	GWB3501	
	2005.06-	Box Engine ZD3A604		○	GWB3614	
3.0 DCi (85 kW)	2005.06-	Box Engine ZD3600	•		GWB3613	
	2005.06-	Box Engine ZD3600		○	GWB3501	
	2005.06-	Box Engine ZD3600		○	GWB3614	
MASTER III (EV, HV, UV)						
2.3 DCi (100 kW)	2014.07-	Platform/Chassis Engine M9T 700/M9T 702	•		GWB6721	
	2014.07-	Platform/Chassis Engine M9T 700/M9T 702		○	GWB6722	
2.3 DCi (107 kW)	2010.02-	Platform/Chassis Engine M9T678/M9T680	•		GWB6721	
	2010.02-	Platform/Chassis Engine M9T678/M9T680		○	GWB6722	
	2010.02-	Platform/Chassis Engine M9T694/M9T696/M9T698	•		GWB6721	
	2010.02-	Platform/Chassis Engine M9T694/M9T696/M9T698		○	GWB6742	
2.3 DCi (110 kW)	2013.03-	Platform/Chassis	•		GWB6721	
	2013.03-	Platform/Chassis	•		GWB6721	
	2013.03-	Platform/Chassis		○	GWB6722	
	2013.03-	Platform/Chassis		○	GWB6742	
2.3 DCi (74 kW)	2010.02-	Platform/Chassis Engine M9T670/M9T672/M9T676	•		GWB6721	
	2010.02-	Platform/Chassis Engine M9T670/M9T672/M9T676		○	GWB6722	
	2010.02-	Platform/Chassis Engine M9T690/M9T696/M9T690	•		GWB6721	
	2010.02-	Platform/Chassis Engine M9T690/M9T696/M9T690		○	GWB6742	
2.3 DCi (81 kW)	2014.09-	Platform/Chassis Engine M9T 870	•		GWB6721	
	2014.09-	Platform/Chassis Engine M9T 870		○	GWB6722	
2.3 DCi (92 kW)	2010.02-	Platform/Chassis Engine M9T670/M9T672/M9T676	•		GWB6721	
	2010.02-	Platform/Chassis Engine M9T670/M9T672/M9T676		○	GWB6722	
	2010.02-	Platform/Chassis Engine M9T686/M9T690/M9T692	•		GWB6721	
	2010.02-	Platform/Chassis Engine M9T686/M9T690/M9T692		○	GWB6742	
2.3 DCi [RWD] (120 kW)	2014.07-	Platform/Chassis Engine M9T 700/M9T 702	•		GWB6721	
	2014.07-	Platform/Chassis Engine M9T 700/M9T 702		○	GWB6722	
MASTER III (FV)						
2.3 DCi (100 kW)	2014.07-	Box Engine M9T 700/M9T 702	•		GWB6721	
	2014.07-	Box Engine M9T 700/M9T 702		○	GWB6722	
2.3 DCi (107 kW)	2010.02-	Box Engine M9T678/M9T680/M9T694/M9T696/M9T698	•		GWB6721	
	2010.02-	Box Engine M9T678/M9T680/M9T694/M9T696/M9T698		○	GWB6722	
	2010.02-	Box Engine M9T694/M9T698	•		GWB6721	



	 YEAR		F	R	G-AP Ref.	KIT
RENAULT						
MASTER III (FV)						
2.3 DCi (107 kW)	2010.02-	Box Engine M9T694/M9T698		o	GWB6742	
2.3 DCi (110 kW)	2013.03-	Box	•		GWB6721	
	2013.03-	Box	•		GWB6721	
	2013.03-	Box		o	GWB6722	
	2013.03-	Box		o	GWB6742	
2.3 DCi (120 kW)	2014.07-	Box Engine M9T 700/M9T 702	•		GWB6721	
	2014.07-	Box Engine M9T 700/M9T 702		o	GWB6722	
2.3 DCi (74 kW)	2010.02-	Box Engine M9T670/M9T672/M9T676	•		GWB6721	
	2010.02-	Box Engine M9T670/M9T672/M9T676		o	GWB6722	
	2010.02-	Box Engine M9T690/M9T692	•		GWB6721	
	2010.02-	Box Engine M9T690/M9T692		o	GWB6742	
2.3 DCi (81 kW)	2014.09-	Box Engine M9T 870	•		GWB6721	
	2014.09-	Box Engine M9T 870		o	GWB6722	
2.3 DCi (92 kW)	2010.02-	Box Engine M9T670/M9T672/M9T676	•		GWB6721	
	2010.02-	Box Engine M9T670/M9T672/M9T676		o	GWB6722	
	2010.02-	Box Engine M9T686/M9T690/M9T692/M9T696/M9T698	•		GWB6721	
	2010.02-	Box Engine M9T686/M9T690/M9T692/M9T696/M9T698		o	GWB6742	
2.3 DCi FWD (100 kW)	2014.07-	Box Engine M9T 702	•		GWB6721	
	2014.07-	Box Engine M9T 702		o	GWB6722	
2.3 DCi FWD (120 kW)	2014.07-	Box Engine M9T 702	•		GWB6721	
	2014.07-	Box Engine M9T 702		o	GWB6722	
MASTER III (JV)						
2.3 DCi (100 kW)	2014.07-	Bus Engine M9T 700/M9T 702	•		GWB6721	
	2014.07-	Bus Engine M9T 700/M9T 702		o	GWB6722	
2.3 DCi (107 kW)	2011.02-	Bus Engine M9T680	•		GWB6721	
	2011.02-	Bus Engine M9T680		o	GWB6722	
2.3 DCi (110 kW)	2012.10-	Bus	•		GWB6721	
	2012.10-	Bus		o	GWB6722	
	2012.10-	Bus		o	GWB6742	
2.3 DCi (120 kW)	2014.07-	Bus Engine M9T 700/M9T 702	•		GWB6721	
	2014.07-	Bus Engine M9T 700/M9T 702		o	GWB6722	
2.3 DCi (74 kW)	2011.02-	Bus Engine M9T670/M9T672/M9T676	•		GWB6721	
	2011.02-	Bus Engine M9T670/M9T672/M9T676		o	GWB6722	
2.3 DCi (81 kW)	2014.09-	Bus Engine M9T 870/M9T 890	•		GWB6721	
	2014.09-	Bus Engine M9T 870/M9T 890		o	GWB6722	
2.3 DCi (92 kW)	2011.02-	Bus Engine M9T670/M9T672/M9T676	•		GWB6721	
	2011.02-	Bus Engine M9T670/M9T672/M9T676		o	GWB6722	
MEGANE CC (EZ0/1_)						
1.4 TCE (96 kW)	2010.06-	Convertible Engine H4J.700		o	GHA230137	K
1.5 DCi (81 kW)	2010.06-	Convertible Engine K9K836/K9K837		o	GHA230137	K
1.6 16V (81 kW)	2010.06-	Convertible Engine K4M858		o	GHA230137	K
1.9 DCi (96 kW)	2010.06-	Convertible Engine F9Q870		o	GHA230137	K
2.0 CVT (103 kW)	2010.06-	Convertible Engine M4R711/M4R713		o	GHA230137	K
2.0 DCi (118 kW)	2010.06-	Convertible Engine M9R610		o	GHA230137	K
2.0 TCE (132 kW)	2010.06-	Convertible Engine F4R870/F4R872		o	GHA230137	K
MEGANE I (BA0/1_)						
1.4 16V (70 kW)	1999.03-2003.08	Hatchback Engine K4J714/K4J750	•		GWB3596	
	1999.03-2003.08	Hatchback Engine K4J714/K4J750		o	GHA225039	K
	1999.03-2003.08	Hatchback Engine K4J714/K4J750		o	GWB3525	
1.4 e (55 kW)	1996.01-2003.08	Hatchback Engine E7J626/E7J764	•		GHA421004	A
	1996.01-2003.08	Hatchback Engine E7J626/E7J764	•		GWB3596	
	1996.01-2003.08	Hatchback Engine E7J626/E7J764		o	GHA225039	K
	1996.01-2003.08	Hatchback Engine E7J626/E7J764		o	GWB3525	
1.4 Eco (52 kW)	1996.01-1999.03	Hatchback Engine E7J624	•		GHA421004	A
	1996.01-1999.03	Hatchback Engine E7J624	•		GWB3596	
	1996.01-1999.03	Hatchback Engine E7J624		o	GHA225039	K
	1996.01-1999.03	Hatchback Engine E7J624		o	GWB3525	
1.6 16V (79 kW)	1999.03-2003.08	Hatchback Engine K4M700/K4M701/K4M704/K4M708	•		GWB3596	
	1999.03-2003.08	Hatchback Engine K4M700/K4M701/K4M704/K4M708		o	GHA225039	K
	1999.03-2003.08	Hatchback Engine K4M700/K4M701/K4M704/K4M708		o	GWB0969	
	1999.03-2003.08	Hatchback Engine K4M700/K4M701/K4M704/K4M708		o	GWB3525	
	1999.03-2003.08	Hatchback Engine K4M700/K4M701/K4M704/K4M708		o	GWB3525	
1.6 e (66 kW)	1996.01-1999.03	Hatchback Engine K7M702/K7M703/K7M790	•		GHA421004	A
	1996.01-1999.03	Hatchback Engine K7M702/K7M703/K7M790	•		GWB3596	
	1996.01-1999.03	Hatchback Engine K7M702/K7M703/K7M790		o	GHA225039	K



	 YEAR		F	R	G-AP Ref.	KIT
RENAULT						
MEGANE I (BA0/1_)						
1.6 e (66 kW)	1996.01-1999.03	Hatchback Engine K7M702/K7M703/K7M790		o	GWB3525	
1.6 i (55 kW)	1996.01-1999.03	Hatchback Engine K7M720	•		GHA421004	A
	1996.01-1999.03	Hatchback Engine K7M720	•		GWB3596	
	1996.01-1999.03	Hatchback Engine K7M720		o	GHA225039	K
	1996.01-1999.03	Hatchback Engine K7M720		o	GWB3525	
1.6 LPG (80 kW)	2000.10-2002.08	Hatchback Engine K4M704	•		GWB3596	
	2000.10-2002.08	Hatchback Engine K4M704		o	GWB3525	
1.8 16V (85 kW)	2001.01-2003.08	Hatchback Engine F4P720/F4P722	•		GWB3596	
	2001.01-2003.08	Hatchback Engine F4P720/F4P722		o	GHA225039	K
	2001.01-2003.08	Hatchback Engine F4P720/F4P722		o	GWB0969	
1.9 D (69 kW)	1996.04-2001.02	Hatchback Engine F8Q784	•		GWB3596	
	1996.04-2001.02	Hatchback Engine F8Q784		o	GWB0969	
	1996.04-2001.02	Hatchback Engine F8Q784		o	GWB3525	
1.9 D Eco (47 kW)	1996.01-2003.08	Hatchback Engine F8Q620/F8Q624	•		GHA421004	A
	1996.01-2003.08	Hatchback Engine F8Q620/F8Q624	•		GWB3596	
	1996.01-2003.08	Hatchback Engine F8Q620/F8Q624		o	GHA225039	K
	1996.01-2003.08	Hatchback Engine F8Q620/F8Q624		o	GWB3525	
1.9 DCi (75 kW)	2001.02-2003.08	Hatchback Engine F9Q732/F9Q733	•		GHA421004	A
	2001.02-2003.08	Hatchback Engine F9Q732/F9Q733	•		GWB3596	
	2001.02-2003.08	Hatchback Engine F9Q732/F9Q733		o	GHA225039	K
	2001.02-2003.08	Hatchback Engine F9Q732/F9Q733		o	GWB0969	
	2001.02-2003.08	Hatchback Engine F9Q732/F9Q733		o	GWB3525	
1.9 DCi (77 kW)	1999.03-2003.08	Hatchback Engine F9Q732/F9Q738	•		GWB3596	
	1999.03-2003.08	Hatchback Engine F9Q732/F9Q738		o	GHA225039	K
	1999.03-2003.08	Hatchback Engine F9Q732/F9Q738		o	GWB3525	
1.9 DT (66 kW)	1996.01-2003.08	Hatchback Engine F8Q784/F8Q786	•		GHA421004	A
	1996.01-2003.08	Hatchback Engine F8Q784/F8Q786	•		GHA423001	
	1996.01-2003.08	Hatchback Engine F8Q784/F8Q786	•		GWB3596	
	1996.01-2003.08	Hatchback Engine F8Q784/F8Q786		o	GHA225039	K
	1996.01-2003.08	Hatchback Engine F8Q784/F8Q786		o	GWB3525	
1.9 DTi (59 kW)	2001.02-2003.08	Hatchback Engine F9Q744	•		GWB3596	
	2001.02-2003.08	Hatchback Engine F9Q744		o	GHA225039	K
	2001.02-2003.08	Hatchback Engine F9Q744		o	GWB3525	
1.9 DTi (60 kW)	2000.02-2000.09	Hatchback	•		GWB3596	
	2000.02-2000.09	Hatchback		o	GHA225039	K
	2000.02-2000.09	Hatchback		o	GWB0969	
	2000.02-2000.09	Hatchback		o	GWB3525	
1.9 DTi (72 kW)	1997.03-2001.02	Hatchback Engine F9Q730/F9Q731/F9Q734/F9Q736	•		GHA421004	A
	1997.03-2001.02	Hatchback Engine F9Q730/F9Q731/F9Q734/F9Q736	•		GHA423001	
	1997.03-2001.02	Hatchback Engine F9Q730/F9Q731/F9Q734/F9Q736	•		GWB3596	
	1997.03-2001.02	Hatchback Engine F9Q730/F9Q731/F9Q734/F9Q736		o	GHA225039	K
	1997.03-2001.02	Hatchback Engine F9Q730/F9Q731/F9Q734/F9Q736		o	GWB3525	
1.9 TDi (69 kW)	1996.09-2003.08	Hatchback Engine F8Q784	•		GHA421004	A
	1996.09-2003.08	Hatchback Engine F8Q784	•		GHA423001	
	1996.09-2003.08	Hatchback Engine F8Q784	•		GWB3596	
	1996.09-2003.08	Hatchback Engine F8Q784		o	GHA225039	K
	1996.09-2003.08	Hatchback Engine F8Q784		o	GWB0969	
	1996.09-2003.08	Hatchback Engine F8Q784		o	GWB3525	
2.0 (85 kW)	1998.05-2001.05	Hatchback	•		GWB3596	
	1998.05-2001.05	Hatchback		o	GHA225039	K
	1998.05-2001.05	Hatchback		o	GWB3525	
2.0 16V (108 kW)	1996.07-2003.08	Hatchback Engine F7R710/F7R714	•		GHA423001	
	1996.07-2003.08	Hatchback Engine F7R710/F7R714	•		GWB3495	
	1996.07-2003.08	Hatchback Engine F7R710/F7R714	•		GWB3596	
	1996.07-2003.08	Hatchback Engine F7R710/F7R714		o	GHA225039	K
	1996.07-2003.08	Hatchback Engine F7R710/F7R714		o	GWB0969	
2.0 i (80 kW)	1999.03-2003.08	Hatchback Engine F3R750/F3R751	•		GHA421004	A
	1999.03-2003.08	Hatchback Engine F3R750/F3R751	•		GHA423003	K
	1999.03-2003.08	Hatchback Engine F3R750/F3R751	•		GWB3596	
	1999.03-2003.08	Hatchback Engine F3R750/F3R751		o	GHA225039	K
	1999.03-2003.08	Hatchback Engine F3R750/F3R751		o	GWB3525	
2.0 i (84 kW)	1996.01-2003.08	Hatchback Engine F3R750/F3R751	•		GHA421004	A
	1996.01-2003.08	Hatchback Engine F3R750/F3R751	•		GWB3596	
	1996.01-2003.08	Hatchback Engine F3R750/F3R751		o	GHA225039	K



	 YEAR		F	R	G-AP Ref.	KIT
RENAULT						
MEGANE I (BA0/1_)						
2.0 i (84 kW)	1996.01-2003.08	Hatchback Engine F3R750/F3R751		o	GWB3525	
MEGANE I CABRIOLET (EA0/1_)						
1.4 16V (70 kW)	1999.03-2003.08	Convertible Engine K4J714/K4J750	•		GWB3596	
	1999.03-2003.08	Convertible Engine K4J714/K4J750		o	GHA225039	K
	1999.03-2003.08	Convertible Engine K4J714/K4J750		o	GWB0969	
	1999.03-2003.08	Convertible Engine K4J714/K4J750		o	GWB3525	
1.6 16V (79 kW)	1999.03-2003.08	Convertible Engine K4M700/K4M701/K4M708	•		GWB3596	
	1999.03-2003.08	Convertible Engine K4M700/K4M701/K4M708		o	GHA225039	K
	1999.03-2003.08	Convertible Engine K4M700/K4M701/K4M708		o	GWB0969	
	1999.03-2003.08	Convertible Engine K4M700/K4M701/K4M708		o	GWB3525	
1.6 e (66 kW)	1996.10-1999.03	Convertible Engine K7M702/K7M703	•		GWB3596	
	1996.10-1999.03	Convertible Engine K7M702/K7M703		o	GHA225039	K
	1996.10-1999.03	Convertible Engine K7M702/K7M703		o	GWB3525	
2.0 (84 kW)	1997.04-2003.08	Convertible Engine F3R750	•		GHA423003	K
	1997.04-2003.08	Convertible Engine F3R750	•		GWB3596	
	1997.04-2003.08	Convertible Engine F3R750		o	GHA225039	K
	1997.04-2003.08	Convertible Engine F3R750		o	GWB3525	
2.0 16V (102 kW)	2002.01-2003.08	Convertible Engine F4R746/F4R770	•		GHA423003	K
	2002.01-2003.08	Convertible Engine F4R746/F4R770	•		GWB3596	
	2002.01-2003.08	Convertible Engine F4R746/F4R770		o	GHA225039	K
	2002.01-2003.08	Convertible Engine F4R746/F4R770		o	GWB0969	
	2002.01-2003.08	Convertible Engine F4R746/F4R770		o	GWB3525	
2.0 16V (108 kW)	1996.10-1999.11	Convertible Engine F7R710/F7R714	•		GHA423003	K
	1996.10-1999.11	Convertible Engine F7R710/F7R714	•		GWB3495	
	1996.10-1999.11	Convertible Engine F7R710/F7R714	•		GWB3596	
	1996.10-1999.11	Convertible Engine F7R710/F7R714		o	GHA225039	K
	1996.10-1999.11	Convertible Engine F7R710/F7R714		o	GWB0969	
2.0 16V iDE (103 kW)	1999.11-2003.08	Convertible Engine F5R740	•		GHA423003	K
	1999.11-2003.08	Convertible Engine F5R740	•		GWB3596	
	1999.11-2003.08	Convertible Engine F5R740		o	GHA225039	K
	1999.11-2003.08	Convertible Engine F5R740		o	GWB0969	
2.0 i (80 kW)	1999.03-2003.08	Convertible Engine F3R791/F3R796	•		GHA423003	K
	1999.03-2003.08	Convertible Engine F3R791/F3R796	•		GWB3596	
	1999.03-2003.08	Convertible Engine F3R791/F3R796		o	GHA225039	K
	1999.03-2003.08	Convertible Engine F3R791/F3R796		o	GWB3525	
MEGANE I CLASSIC (LA0/1_)						
1.4 (55 kW)	1996.09-2003.08	Saloon Engine E7J626/E7J764	•		GWB3596	
	1996.09-2003.08	Saloon Engine E7J626/E7J764		o	GHA225039	K
	1996.09-2003.08	Saloon Engine E7J626/E7J764		o	GWB3525	
1.4 16V (70 kW)	1999.03-2003.08	Saloon Engine K4J714/K4J750	•		GWB3596	
	1999.03-2003.08	Saloon Engine K4J714/K4J750		o	GHA225039	K
	1999.03-2003.08	Saloon Engine K4J714/K4J750		o	GWB3525	
1.6 16V (79 kW)	1999.03-2003.08	Saloon Engine K4M700/K4M701/K4M708	•		GWB3596	
	1999.03-2003.08	Saloon Engine K4M700/K4M701/K4M708		o	GHA225039	K
	1999.03-2003.08	Saloon Engine K4M700/K4M701/K4M708		o	GWB0969	
	1999.03-2003.08	Saloon Engine K4M700/K4M701/K4M708		o	GWB3525	
1.6 e (66 kW)	1996.09-1999.03	Saloon Engine K7M702/K7M703/K7M790	•		GWB3596	
	1996.09-1999.03	Saloon Engine K7M702/K7M703/K7M790		o	GHA225039	K
	1996.09-1999.03	Saloon Engine K7M702/K7M703/K7M790		o	GWB3525	
1.6 i (55 kW)	1996.09-1999.03	Saloon Engine K7M720	•		GWB3596	
	1996.09-1999.03	Saloon Engine K7M720		o	GWB3525	
1.8 16V (85 kW)	2001.01-2003.08	Saloon Engine F4P720/F4P722	•		GWB3596	
	2001.01-2003.08	Saloon Engine F4P720/F4P722		o	GHA225039	K
	2001.01-2003.08	Saloon Engine F4P720/F4P722		o	GWB0969	
	2001.01-2003.08	Saloon Engine F4P720/F4P722		o	GWB3525	
1.9 D (47 kW)	1996.09-2003.08	Saloon Engine F8Q620/F8Q624	•		GWB3596	
	1996.09-2003.08	Saloon Engine F8Q620/F8Q624		o	GHA225039	K
	1996.09-2003.08	Saloon Engine F8Q620/F8Q624		o	GWB3525	
1.9 DCi (75 kW)	2001.02-2003.08	Saloon Engine F9Q732/F9Q733/F9Q738	•		GWB3596	
	2001.02-2003.08	Saloon Engine F9Q732/F9Q733/F9Q738		o	GHA225039	K
	2001.02-2003.08	Saloon Engine F9Q732/F9Q733/F9Q738		o	GWB0969	
	2001.02-2003.08	Saloon Engine F9Q732/F9Q733/F9Q738		o	GWB3525	
1.9 DCi (77 kW)	1999.03-2000.09	Saloon Engine F9Q733	•		GWB3596	
	1999.03-2000.09	Saloon Engine F9Q733		o	GWB0969	



	 YEAR		F	R	G-AP Ref.	KIT
RENAULT						
MEGANE I CLASSIC (LA0/1_)						
1.9 DCi (77 kW)	1999.03-2000.09	Saloon Engine F9Q733		o	GWB3525	
1.9 DT (66 kW)	1996.09-2003.08	Saloon Engine F8Q784/F8Q786	•		GWB3596	
	1996.09-2003.08	Saloon Engine F8Q784/F8Q786		o	GWB3525	
1.9 DTi (59 kW)	2001.02-2003.08	Saloon Engine F9Q744	•		GWB3596	
	2001.02-2003.08	Saloon Engine F9Q744		o	GHA225039	K
	2001.02-2003.08	Saloon Engine F9Q744		o	GWB0969	
	2001.02-2003.08	Saloon Engine F9Q744		o	GWB3525	
1.9 DTi (72 kW)	1997.03-2001.02	Saloon Engine F9Q730/F9Q731/F9Q734/F9Q736	•		GWB3596	
	1997.03-2001.02	Saloon Engine F9Q730/F9Q731/F9Q734/F9Q736		o	GHA225039	K
	1997.03-2001.02	Saloon Engine F9Q730/F9Q731/F9Q734/F9Q736		o	GWB3525	
1.9 TDi (69 kW)	1996.09-2003.08	Saloon Engine F8Q784	•		GWB3596	
	1996.09-2003.08	Saloon Engine F8Q784		o	GWB0969	
	1996.09-2003.08	Saloon Engine F8Q784		o	GWB3525	
2.0 (85 kW)	1998.05-2001.05	Saloon	•		GWB3596	
	1998.05-2001.05	Saloon		o	GWB3525	
2.0 i (80 kW)	1999.03-2003.08	Saloon Engine F3R750/F3R751/F3R752/F3R791/F3R796/F3R797/F3R798	•		GHA423003	K
	1999.03-2003.08	Saloon Engine F3R750/F3R751/F3R752/F3R791/F3R796/F3R797/F3R798	•		GWB3596	
	1999.03-2003.08	Saloon Engine F3R750/F3R751/F3R752/F3R791/F3R796/F3R797/F3R798		o	GHA225039	K
	1999.03-2003.08	Saloon Engine F3R750/F3R751/F3R752/F3R791/F3R796/F3R797/F3R798		o	GWB3525	
2.0 i (84 kW)	1996.09-2003.08	Saloon Engine F3R750/F3R751/F3R752/F3R791/F3R796/F3R797/F3R798	•		GHA423003	K
	1996.09-2003.08	Saloon Engine F3R750/F3R751/F3R752/F3R791/F3R796/F3R797/F3R798	•		GWB3596	
	1996.09-2003.08	Saloon Engine F3R750/F3R751/F3R752/F3R791/F3R796/F3R797/F3R798		o	GWB3525	
MEGANE I COACH (DA0/1_)						
1.4 16V (70 kW)	1999.03-2003.08	Coupe Engine K4J714/K4J750	•		GWB3596	
	1999.03-2003.08	Coupe Engine K4J714/K4J750		o	GHA225039	K
	1999.03-2003.08	Coupe Engine K4J714/K4J750		o	GWB0969	
	1999.03-2003.08	Coupe Engine K4J714/K4J750		o	GWB3525	
1.6 16V (79 kW)	1999.03-2003.08	Coupe Engine K4M700/K4M701/K4M708	•		GWB3596	
	1999.03-2003.08	Coupe Engine K4M700/K4M701/K4M708		o	GHA225039	K
	1999.03-2003.08	Coupe Engine K4M700/K4M701/K4M708		o	GWB0969	
	1999.03-2003.08	Coupe Engine K4M700/K4M701/K4M708		o	GWB3525	
1.6 e (66 kW)	1996.03-1999.03	Coupe Engine K7M702/K7M703	•		GHA421004	A
	1996.03-1999.03	Coupe Engine K7M702/K7M703	•		GWB3596	
	1996.03-1999.03	Coupe Engine K7M702/K7M703		o	GHA225039	K
	1996.03-1999.03	Coupe Engine K7M702/K7M703		o	GWB3525	
1.9 DCi (75 kW)	2001.02-2003.08	Coupe Engine F9Q732/F9Q733	•		GWB3596	
	2001.02-2003.08	Coupe Engine F9Q732/F9Q733		o	GHA225039	K
	2001.02-2003.08	Coupe Engine F9Q732/F9Q733		o	GWB0969	
	2001.02-2003.08	Coupe Engine F9Q732/F9Q733		o	GWB3525	
1.9 DTi (72 kW)	1997.03-2001.02	Coupe Engine F9Q731/F9Q734/F9Q736	•		GWB3596	
	1997.03-2001.02	Coupe Engine F9Q731/F9Q734/F9Q736		o	GHA225039	K
	1997.03-2001.02	Coupe Engine F9Q731/F9Q734/F9Q736		o	GWB3525	
2.0 16V (102 kW)	2002.01-2003.08	Coupe Engine F4R746	•		GWB3596	
	2002.01-2003.08	Coupe Engine F4R746		o	GHA225039	K
	2002.01-2003.08	Coupe Engine F4R746		o	GWB0969	
2.0 16V (108 kW)	1996.03-1999.11	Coupe Engine F7R710/F7R714	•		GHA423001	
	1996.03-1999.11	Coupe Engine F7R710/F7R714	•		GHA423003	K
	1996.03-1999.11	Coupe Engine F7R710/F7R714	•		GWB3495	
	1996.03-1999.11	Coupe Engine F7R710/F7R714	•		GWB3596	
	1996.03-1999.11	Coupe Engine F7R710/F7R714		o	GHA225039	K
	1996.03-1999.11	Coupe Engine F7R710/F7R714		o	GWB0969	
2.0 16V iDE (103 kW)	1999.11-2003.08	Coupe Engine F5R740	•		GHA423003	K
	1999.11-2003.08	Coupe Engine F5R740	•		GWB3596	
	1999.11-2003.08	Coupe Engine F5R740		o	GHA225039	K
	1999.11-2003.08	Coupe Engine F5R740		o	GWB0969	
2.0 i (80 kW)	1999.03-2003.08	Coupe Engine F3R791/F3R796	•		GHA421004	A
	1999.03-2003.08	Coupe Engine F3R791/F3R796	•		GHA423003	K
	1999.03-2003.08	Coupe Engine F3R791/F3R796	•		GWB3596	
	1999.03-2003.08	Coupe Engine F3R791/F3R796		o	GHA225039	K
	1999.03-2003.08	Coupe Engine F3R791/F3R796		o	GWB0969	
2.0 i (84 kW)	1996.03-2003.08	Coupe Engine F3R750/F3R751	•		GHA421004	A
	1996.03-2003.08	Coupe Engine F3R750/F3R751	•		GHA423003	K
	1996.03-2003.08	Coupe Engine F3R750/F3R751	•		GWB3596	
	1996.03-2003.08	Coupe Engine F3R750/F3R751		o	GHA225039	K



	 YEAR		F	R	G-AP Ref.	KIT
RENAULT						
MEGANE I COACH (DA0/1_)						
2.0 i (84 kW)	1996.03-2003.08	Coupe Engine F3R750/F3R751		o	GWB3525	
MEGANE I GRANDTOUR (KA0/1_)						
1.4 16V (70 kW)	1999.03-2003.08	Estate Engine K4J714/K4J750	•		GWB3596	
	1999.03-2003.08	Estate Engine K4J714/K4J750		o	GHA225018	K
	1999.03-2003.08	Estate Engine K4J714/K4J750 With ABS		o	GHA225015	K
	1999.03-2003.08	Estate Engine K4J714/K4J750 Without ABS		o	GHA225020	K
1.4 e (55 kW)	1999.03-2003.08	Estate Engine E7J626	•		GWB3596	
	1999.03-2003.08	Estate Engine E7J626		o	GHA225018	K
	1999.03-2003.08	Estate Engine E7J626 With ABS		o	GHA225015	K
	1999.03-2003.08	Estate Engine E7J626 Without ABS		o	GHA225020	K
1.6 16V (79 kW)	1999.03-2003.08	Estate Engine K4M700/K4M701/K4M704/K4M708	•		GWB3596	
	1999.03-2003.08	Estate Engine K4M700/K4M701/K4M704/K4M708		o	GHA225018	K
	1999.03-2003.08	Estate Engine K4M700/K4M701/K4M704/K4M708 With ABS		o	GHA225015	K
	1999.03-2003.08	Estate Engine K4M700/K4M701/K4M704/K4M708 Without ABS		o	GHA225020	K
1.6 e (66 kW)	1999.03-2003.08	Estate Engine K7M702/K7M703	•		GWB3596	
	1999.03-2003.08	Estate Engine K7M702/K7M703 With ABS		o	GHA225015	K
	1999.03-2003.08	Estate Engine K7M702/K7M703 Without ABS		o	GHA225020	K
1.8 16V (85 kW)	2001.01-2003.08	Estate Engine F4P720/F4P722	•		GWB3596	
	2001.01-2003.08	Estate Engine F4P720/F4P722		o	GHA225018	K
1.9 D (47 kW)	1999.04-2003.08	Estate Engine F8Q622/F8Q790	•		GWB3596	
	1999.04-2003.08	Estate Engine F8Q622/F8Q790 With ABS		o	GHA225015	K
	1999.04-2003.08	Estate Engine F8Q622/F8Q790 Without ABS		o	GHA225020	K
1.9 DCi (75 kW)	2001.02-2003.08	Estate Engine F9Q732/F9Q733/F9Q738	•		GWB3596	
	2001.02-2003.08	Estate Engine F9Q732/F9Q733/F9Q738		o	GHA225018	K
1.9 DTi (59 kW)	2001.02-2003.08	Estate Engine F9Q744	•		GWB3596	
	2001.02-2003.08	Estate Engine F9Q744		o	GHA225018	K
1.9 DTi (72 kW)	1999.03-2001.02	Estate Engine F9Q731/F9Q736	•		GWB3596	
	1999.03-2001.02	Estate Engine F9Q731/F9Q736		o	GHA225018	K
	1999.03-2001.02	Estate Engine F9Q731/F9Q736 With ABS		o	GHA225015	K
	1999.03-2001.02	Estate Engine F9Q731/F9Q736 Without ABS		o	GHA225020	K
MEGANE II SPORT TOURER (KM0/1_)						
2.0 (102 kW)	2006.122011.01	Estate	•		GWB3637	
	2006.122011.01	Estate		o	GWB3639	
	2006.122011.01	Estate		o	GWB3676	
MEGANE II (BM0/1_, CM0/1_)						
1.4 16V (60 kW)	2003.10-	Hatchback Engine K4J732	•		GWB3637	
	2003.10-	Hatchback Engine K4J732		o	GHA225019	K
	2003.10-	Hatchback Engine K4J732		o	GWB3639	
1.4 16V (72 kW)	2002.11-	Hatchback Engine K4J730/K4J740	•		GWB3637	
	2002.11-	Hatchback Engine K4J730/K4J740		o	GHA225019	K
	2002.11-	Hatchback Engine K4J730/K4J740		o	GWB3639	
1.5 DCi (60 kW)	2002.11-	Hatchback Engine K9K722	•		GWB3637	
	2002.11-	Hatchback Engine K9K722		o	GHA225019	K
	2002.11-	Hatchback Engine K9K722		o	GWB3639	
1.5 DCi (63 kW)	2005.02-2007.07	Hatchback Engine K9K724	•		GWB3637	
	2005.02-2007.07	Hatchback Engine K9K724		o	GHA225019	K
	2005.02-2007.07	Hatchback Engine K9K724		o	GWB3639	
1.5 DCi (74 kW)	2003.10-2005.11	Hatchback Engine K9K728/K9K729	•		GWB3637	
	2003.10-2005.11	Hatchback Engine K9K728/K9K729		o	GHA225019	K
	2003.10-2005.11	Hatchback Engine K9K728/K9K729		o	GWB3639	
1.5 DCi (76 kW)	2007.01-	Hatchback Engine K9K734	•		GWB3637	
	2007.01-	Hatchback Engine K9K734		o	GHA225019	K
	2007.01-	Hatchback Engine K9K734		o	GWB3639	
1.5 DCi (78 kW)	2005.02-2007.07	Hatchback Engine K9K732/K9K734	•		GWB3638	
	2005.02-2007.07	Hatchback Engine K9K732/K9K734		o	GHA225019	K
	2005.02-2007.07	Hatchback Engine K9K732/K9K734		o	GWB3639	
1.6 (77 kW)	2005.06-	Hatchback Engine K4M788	•		GWB3637	
	2005.06-	Hatchback Engine K4M788		o	GWB3639	
1.6 16V (82 kW)	2006.01-	Hatchback Engine K4M760/K4M812/K4M813	•		GWB3637	
	2006.01-	Hatchback Engine K4M760/K4M812/K4M813		o	GHA225019	K
	2006.01-	Hatchback Engine K4M760/K4M812/K4M813		o	GWB3639	
1.6 16V (83 kW)	2002.11-	Hatchback Engine K4M760	•		GWB3637	
	2002.11-	Hatchback Engine K4M760		o	GHA225019	K
	2002.11-	Hatchback Engine K4M760		o	GWB3639	



	 YEAR		F	R	G-AP Ref.	KIT
RENAULT						
MEGANE II (BM0/1_, CM0/1_)						
1.6 FlexFuel (77 kW)	2007.01-	Hatchback Engine K4M788	•		GWB3637	
	2007.01-	Hatchback Engine K4M788		◦	GHA225019	K
	2007.01-	Hatchback Engine K4M788		◦	GWB3639	
1.9 DCi (66 kW)	2002.11-2005.12	Hatchback Engine F9Q808	•		GWB3638	
	2002.11-2005.12	Hatchback Engine F9Q808		◦	GWB3639	
1.9 DCi (68 kW)	2004.03-	Hatchback Engine F9Q808	•		GWB3638	
	2004.03-	Hatchback Engine F9Q808		◦	GHA225019	K
	2004.03-	Hatchback Engine F9Q808		◦	GWB3639	
1.9 DCi (81 kW)	2005.05-	Hatchback Engine F9Q804/F9Q818	•		GWB3638	
	2005.05-	Hatchback Engine F9Q804/F9Q818		◦	GHA225019	K
	2005.05-	Hatchback Engine F9Q804/F9Q818		◦	GWB3639	
1.9 DCi (85 kW)	2002.11-	Hatchback Engine F9Q804/F9Q816/F9Q818	•		GWB3638	
	2002.11-	Hatchback Engine F9Q804/F9Q816/F9Q818		◦	GHA225019	K
	2002.11-	Hatchback Engine F9Q804/F9Q816/F9Q818		◦	GWB3639	
1.9 DCi (88 kW)	2002.11-	Hatchback Engine F9Q800	•		GWB3638	
	2002.11-	Hatchback Engine F9Q800		◦	GHA225019	K
	2002.11-	Hatchback Engine F9Q800		◦	GWB3639	
1.9 DCi (96 kW)	2005.05-2007.07	Hatchback Engine F9Q803/F9Q816	•		GWB3638	
	2005.05-2007.07	Hatchback Engine F9Q803/F9Q816		◦	GHA225019	K
	2005.05-2007.07	Hatchback Engine F9Q803/F9Q816		◦	GWB3639	
2.0 (102 kW)	2006.062010.12	Hatchback	•		GWB3638	
	2006.062010.12	Hatchback	•		GWB3648	
	2006.062010.12	Hatchback		◦	GWB3639	
2.0 (169 kW)	2006.08-	Hatchback Engine F4R774	•		GWB3638	
	2006.08-	Hatchback Engine F4R774	•		GWB3648	
	2006.08-	Hatchback Engine F4R774		◦	GWB3639	
2.0 16V (99 kW)	2002.11-	Hatchback Engine F4R770	•		GWB3637	
	2002.11-	Hatchback Engine F4R770		◦	GHA225019	K
	2002.11-	Hatchback Engine F4R770		◦	GWB3639	
2.0 16V Turbo (120 kW)	2004.02-2007.07	Hatchback Engine F4R776	•		GWB3638	
	2004.02-2007.07	Hatchback Engine F4R776		◦	GHA225019	K
	2004.02-2007.07	Hatchback Engine F4R776		◦	GWB3639	
2.0 DCi (110 kW)	2006.06-2007.07	Hatchback Engine M9R700/M9R722	•		GWB3692	
	2006.06-2007.07	Hatchback Engine M9R700/M9R722		◦	GWB3676	
2.0 DCi (127 kW)	2007.04-	Hatchback Engine M9R724	•		GWB3648	
2.0 Renault Sport (165 kW)	2005.04-2007.07	Hatchback Engine F4R774/F4Rt774	•		GWB3648	
MEGANE II (EM0/1_)						
2.0 (102 kW)	2003.09-2007.02	Convertible Engine F4R770	•		GWB3637	
	2003.09-2007.02	Convertible Engine F4R770		◦	GWB3639	
MEGANE II (KM0/1_)						
1.9 DCi (81 kW)	2005.05-	Estate Engine F9Q804/F9Q818	•		GWB3638	
	2005.05-	Estate Engine F9Q804/F9Q818		◦	GHA225041	K
	2005.05-	Estate Engine F9Q804/F9Q818		◦	GWB3676	
1.9 DCi (85 kW)	2005.05-	Estate Engine F9Q818	•		GWB3638	
	2005.05-	Estate Engine F9Q818		◦	GHA225041	K
	2005.05-	Estate Engine F9Q818		◦	GWB3676	
1.9 DCi (88 kW)	2003.08-	Estate Engine F9Q800	•		GWB3638	
	2003.08-	Estate Engine F9Q800		◦	GHA225041	K
	2003.08-	Estate Engine F9Q800		◦	GWB3676	
1.9 DCi (96 kW)	2005.05-2007.07	Estate Engine F9Q803/F9Q804	•		GWB3638	
	2005.05-2007.07	Estate Engine F9Q803/F9Q804		◦	GHA225019	K
	2005.05-2007.07	Estate Engine F9Q803/F9Q804		◦	GHA225041	K
	2005.05-2007.07	Estate Engine F9Q803/F9Q804		◦	GWB3676	
2.0 (99 kW)	2003.08-	Estate Engine F4R770/F4R771	•		GWB3637	
	2003.08-	Estate Engine F4R770/F4R771		◦	GHA225041	K
	2003.08-	Estate Engine F4R770/F4R771		◦	GWB3639	
	2003.08-	Estate Engine F4R770/F4R771		◦	GWB3676	
2.0 DCi (110 kW)	2006.06-2007.07	Estate Engine M9R700/M9R722	•		GWB3692	
	2006.06-2007.07	Estate Engine M9R700/M9R722		◦	GWB3676	
MEGANE II (LM0/1_)						
1.4 (60 kW)	2003.09-	Saloon Engine K4J732	•		GWB3637	
	2003.09-	Saloon Engine K4J732		◦	GHA225019	K
	2003.09-	Saloon Engine K4J732		◦	GWB3639	
1.4 (72 kW)	2003.09-	Saloon Engine K4J730/K4J740	•		GWB3637	



	 YEAR		F	R	G-AP Ref.	KIT
RENAULT						
MEGANE II (KM0/1_)						
1.4 (72 kW)	2003.09-	Saloon Engine K4J730/K4J740		o	GHA225019	K
	2003.09-	Saloon Engine K4J730/K4J740		o	GWB3639	
1.5 DCi (60 kW)	2003.09-	Saloon Engine K9K722	•		GWB3637	
	2003.09-	Saloon Engine K9K722		o	GHA225019	K
	2003.09-	Saloon Engine K9K722		o	GWB3639	
1.5 DCi (63 kW)	2005.02-2006.04	Saloon Engine K9K724	•		GWB3637	
	2005.02-2006.04	Saloon Engine K9K724		o	GHA225019	K
	2005.02-2006.04	Saloon Engine K9K724		o	GWB3639	
1.5 DCi (74 kW)	2003.11-2005.11	Saloon Engine K9K728/K9K729	•		GWB3637	
	2003.11-2005.11	Saloon Engine K9K728/K9K729		o	GHA225019	K
	2003.11-2005.11	Saloon Engine K9K728/K9K729		o	GWB3639	
1.5 DCi (76 kW)	2007.01-	Saloon Engine K9K734	•		GWB3637	
	2007.01-	Saloon Engine K9K734		o	GWB3639	
1.5 DCi (78 kW)	2005.02-2006.02	Saloon Engine K9K732	•		GWB3637	
	2005.02-2006.02	Saloon Engine K9K732		o	GHA225019	K
	2005.02-2006.02	Saloon Engine K9K732		o	GWB3639	
1.6 (75 kW)	2003.09-	Saloon Engine K4M 768	•		GWB3637	
	2003.09-	Saloon Engine K4M 768		o	GWB3639	
1.6 (77 kW)	2005.05-	Saloon Engine K4M762	•		GWB3637	
	2005.05-	Saloon Engine K4M762		o	GHA225019	K
	2005.05-	Saloon Engine K4M762		o	GWB3639	
1.6 (81 kW)	2003.09-2008.11	Saloon Engine K4M 760/K4M 761	•		GWB3637	
	2003.09-2008.11	Saloon Engine K4M 760/K4M 761		o	GWB3639	
1.6 (83 kW)	2003.09-	Saloon Engine K4M760/K4M761	•		GWB3637	
	2003.09-	Saloon Engine K4M760/K4M761		o	GHA225019	K
	2003.09-	Saloon Engine K4M760/K4M761		o	GWB3639	
1.6 16V (82 kW)	2006.01-	Saloon Engine K4M812/K4M813/K4MD812	•		GWB3637	
	2006.01-	Saloon Engine K4M812/K4M813/K4MD812		o	GHA225019	K
	2006.01-	Saloon Engine K4M812/K4M813/K4MD812		o	GWB3639	
1.6 Hi-Flex (85 kW)	2006.03-	Saloon Engine K4M 766	•		GWB3637	
	2006.03-	Saloon Engine K4M 766		o	GWB3639	
1.9 DCi (66 kW)	2003.09-2005.12	Saloon Engine F9Q808	•		GWB3638	
	2003.09-2005.12	Saloon Engine F9Q808		o	GWB3639	
1.9 DCi (68 kW)	2004.03-	Saloon Engine F9Q808	•		GWB3638	
	2004.03-	Saloon Engine F9Q808		o	GHA225019	K
	2004.03-	Saloon Engine F9Q808		o	GWB3639	
1.9 DCi (81 kW)	2005.05-	Saloon Engine F9Q803/F9Q804/F9Q816/F9Q818	•		GWB3638	
	2005.05-	Saloon Engine F9Q803/F9Q804/F9Q816/F9Q818		o	GHA225019	K
	2005.05-	Saloon Engine F9Q803/F9Q804/F9Q816/F9Q818		o	GWB3639	
1.9 DCi (88 kW)	2003.09-	Saloon Engine F9Q800	•		GWB3638	
	2003.09-	Saloon Engine F9Q800		o	GHA225019	K
	2003.09-	Saloon Engine F9Q800		o	GWB3639	
1.9 DCi (96 kW)	2005.05-2007.04	Saloon Engine F9Q803	•		GWB3638	
	2005.05-2007.04	Saloon Engine F9Q803		o	GHA225019	K
	2005.05-2007.04	Saloon Engine F9Q803		o	GWB3639	
2.0 (99 kW)	2003.09-	Saloon Engine F4R770/F4R771	•		GWB3637	
	2003.09-	Saloon Engine F4R770/F4R771		o	GHA225019	K
	2003.09-	Saloon Engine F4R770/F4R771		o	GWB3639	
2.0 DCi (110 kW)	2006.06-2007.04	Saloon Engine M9R700/M9R722	•		GWB3692	
	2006.06-2007.04	Saloon Engine M9R700/M9R722		o	GWB3676	
MEGANE II COUPE-CABRIOLET II (EM0/1_)						
1.5 DCi (76 kW)	2007.01-	Convertible Engine K9K734	•		GWB3638	
	2007.01-	Convertible Engine K9K734		o	GHA225019	K
	2007.01-	Convertible Engine K9K734		o	GWB3639	
1.5 DCi (78 kW)	2006.01-2007.08	Convertible Engine K9K732	•		GWB3638	
	2006.01-2007.08	Convertible Engine K9K732		o	GHA225019	K
	2006.01-2007.08	Convertible Engine K9K732		o	GWB3639	
1.6 (83 kW)	2003.09-	Convertible Engine K4M760/K4M761	•		GWB3637	
	2003.09-	Convertible Engine K4M760/K4M761		o	GHA225019	K
	2003.09-	Convertible Engine K4M760/K4M761		o	GWB3639	
1.6 16V (82 kW)	2006.01-	Convertible Engine K4M760/K4M761/K4M812/K4M813/K4MC813/K4MD812	•		GWB3637	
	2006.01-	Convertible Engine K4M760/K4M761/K4M812/K4M813/K4MC813/K4MD812		o	GHA225019	K
	2006.01-	Convertible Engine K4M760/K4M761/K4M812/K4M813/K4MC813/K4MD812		o	GWB3639	
1.9 DCi (81 kW)	2005.05-	Convertible Engine F9Q804/F9Q816/F9Q818	•		GWB3638	



	 YEAR		F	R	G-AP Ref.	KIT
RENAULT						
MEGANE II COUPE-CABRIOLET II (EM0/1_)						
1.9 DCi (81 kW)	2005.05-	Convertible Engine F9Q804/F9Q816/F9Q818		o	GHA225019	K
	2005.05-	Convertible Engine F9Q804/F9Q816/F9Q818		o	GWB3639	
1.9 DCi (85 kW)	2003.09-	Convertible Engine F9Q804/F9Q816/F9Q818	•		GWB3638	
	2003.09-	Convertible Engine F9Q804/F9Q816/F9Q818		o	GHA225019	K
	2003.09-	Convertible Engine F9Q804/F9Q816/F9Q818		o	GWB3639	
1.9 DCi (88 kW)	2003.09-	Convertible Engine F9Q800	•		GWB3638	
	2003.09-	Convertible Engine F9Q800		o	GHA225019	K
	2003.09-	Convertible Engine F9Q800		o	GWB3639	
1.9 DCi (96 kW)	2005.05-2007.08	Convertible Engine F9Q803	•		GWB3638	
	2005.05-2007.08	Convertible Engine F9Q803		o	GHA225019	K
	2005.05-2007.08	Convertible Engine F9Q803		o	GWB3639	
2.0 (99 kW)	2003.09-	Convertible Engine F4R770/F4R771	•		GWB3637	
	2003.09-	Convertible Engine F4R770/F4R771		o	GHA225019	K
	2003.09-	Convertible Engine F4R770/F4R771		o	GWB3639	
2.0 16V Turbo (120 kW)	2004.08-2007.08	Convertible Engine F4R776	•		GWB3638	
	2004.08-2007.08	Convertible Engine F4R776		o	GHA225019	K
	2004.08-2007.08	Convertible Engine F4R776		o	GWB3639	
2.0 DCi (110 kW)	2006.06-2007.08	Convertible Engine M9R700/M9R722	•		GWB3692	
	2006.06-2007.08	Convertible Engine M9R700/M9R722		o	GWB3676	
MEGANE II SPORT TOURER (KM0/1_)						
1.4 (72 kW)	2003.08-	Estate Engine K4J730/K4J740	•		GWB3637	
	2003.08-	Estate Engine K4J730/K4J740		o	GHA225041	K
	2003.08-	Estate Engine K4J730/K4J740		o	GWB3676	
1.5 DCi (60 kW)	2003.08-	Estate Engine K9K722	•		GWB3637	
	2003.08-	Estate Engine K9K722	•		GWB3638	
	2003.08-	Estate Engine K9K722		o	GHA225041	K
	2003.08-	Estate Engine K9K722		o	GWB3676	
1.5 DCi (63 kW)	2005.02-2006.02	Estate Engine K9K724	•		GWB3637	
	2005.02-2006.02	Estate Engine K9K724	•		GWB3638	
	2005.02-2006.02	Estate Engine K9K724		o	GHA225041	K
	2005.02-2006.02	Estate Engine K9K724		o	GWB3676	
1.5 DCi (74 kW)	2003.11-2005.11	Estate Engine K9K728/K9K729	•		GWB3637	
	2003.11-2005.11	Estate Engine K9K728/K9K729	•		GWB3638	
	2003.11-2005.11	Estate Engine K9K728/K9K729		o	GHA225041	K
	2003.11-2005.11	Estate Engine K9K728/K9K729		o	GWB3676	
1.5 DCi (76 kW)	2007.01-	Estate Engine K9K728	•		GWB3637	
	2007.01-	Estate Engine K9K728	•		GWB3638	
	2007.01-	Estate Engine K9K728		o	GHA225041	K
	2007.01-	Estate Engine K9K728		o	GWB3676	
1.5 DCi (78 kW)	2005.02-2007.07	Estate Engine K9K732/K9K734	•		GWB3637	
	2005.02-2007.07	Estate Engine K9K732/K9K734	•		GWB3638	
	2005.02-2007.07	Estate Engine K9K732/K9K734		o	GHA225041	K
	2005.02-2007.07	Estate Engine K9K732/K9K734		o	GWB3676	
1.6 (83 kW)	2003.08-	Estate Engine K4M760/K4M761	•		GWB3637	
	2003.08-	Estate Engine K4M760/K4M761		o	GHA225041	K
	2003.08-	Estate Engine K4M760/K4M761		o	GWB3676	
1.6 16V (77 kW)	2005.05-2009.07	Estate	•		GWB3637	
	2005.05-2009.07	Estate		o	GWB3639	
1.6 16V (82 kW)	2006.01-	Estate Engine K4M760/K4M761/K4M812/K4M813/K4MD812	•		GWB3637	
	2006.01-	Estate Engine K4M760/K4M761/K4M812/K4M813/K4MD812		o	GHA225041	K
	2006.01-	Estate Engine K4M760/K4M761/K4M812/K4M813/K4MD812		o	GWB3639	
1.6 16V Hi-Flex (77 kW)	2008.02-	Estate Engine K4M762	•		GWB3637	
	2008.02-	Estate Engine K4M762		o	GHA225041	K
	2008.02-	Estate Engine K4M762		o	GWB3676	
1.9 DCi (66 kW)	2004.04-2005.12	Estate Engine F9Q808	•		GWB3638	
	2004.04-2005.12	Estate Engine F9Q808		o	GWB3676	
1.9 DCi (68 kW)	2004.03-	Estate Engine F9Q808	•		GWB3638	
	2004.03-	Estate Engine F9Q808		o	GHA225041	K
	2004.03-	Estate Engine F9Q808		o	GWB3676	
MEGANE III (BZ0_)						
1.2 TCE (85 kW)	2012.03-	Hatchback Engine H5F400		o	GHA225038	K
1.2 TCE (97 kW)	2013.01-	Hatchback Engine H5F404		o	GHA225038	K
1.4 TCE (96 kW)	2009.04-	Hatchback Engine H4J700		o	GHA225038	K
1.5 DCi (63 kW)	2009.12-	Hatchback Engine K9K830		o	GHA225038	K



	 YEAR		F	R	G-AP Ref.	KIT
RENAULT						
MEGANE III (BZ0_)						
1.5 DCi (66 kW)	2008.11-	Hatchback Engine K9KH834		o	GHA225038	K
1.5 DCi (70 kW)	2013.11-	Hatchback		o	GHA225038	K
1.5 DCi (78 kW)	2009.02-	Hatchback Engine K9KG832		o	GHA225038	K
1.5 DCi (81 kW)	2009.02-	Hatchback Engine K9K836		o	GHA225038	K
1.6 16V (74 kW)	2008.11-	Hatchback Engine K4M848		o	GHA225038	K
1.6 16V (81 kW)	2008.11-	Hatchback Engine K4M858		o	GHA225038	K
1.6 16V Bifuel (81 kW)	2008.11-	Hatchback Engine K4M866		o	GHA225038	K
1.6 DCi (96 kW)	2011.04-	Hatchback Engine R9M402/R9M404		o	GHA225038	K
1.9 DCi (96 kW)	2008.11-	Hatchback Engine F9Q870/F9Q872		o	GHA225038	K
2.0 CVT (103 kW)	2009.02-	Hatchback Engine M4R711/M4R713		o	GHA225038	K
2.0 DCi (110 kW)	2010.10-	Hatchback Engine M9R615		o	GHA225038	K
2.0 DCi (118 kW)	2009.04-	Hatchback Engine M9R610		o	GHA225038	K
2.0 DCi (120 kW)	2012.07-	Hatchback Engine M9R610		o	GHA225038	K
2.0 TCE (132 kW)	2008.11-	Hatchback Engine F4R870		o	GHA225038	K
2.0 TCE (140 kW)	2012.06-	Hatchback		o	GHA225038	K
2.0 TCe 220 (162 kW)	2013.11-	Hatchback		o	GHA225038	K
MEGANE III (DZ0/1_)						
1.2 TCE (85 kW)	2012.03-	Coupe Engine H5F400		o	GHA225038	K
1.2 TCE (97 kW)	2013.01-	Coupe Engine H5F404		o	GHA225038	K
1.4 TCE (96 kW)	2009.04-	Coupe Engine H4J700		o	GHA225038	K
1.5 DCi (63 kW)	2008.11-	Coupe Engine K9KF830		o	GHA225038	K
1.5 DCi (66 kW)	2008.11-	Coupe Engine K9KH834		o	GHA225038	K
1.5 DCi (78 kW)	2009.02-	Coupe Engine K9KG832		o	GHA225038	K
1.5 DCi (81 kW)	2009.02-	Coupe Engine K9KJ836/K9K837		o	GHA225038	K
1.6 16V (74 kW)	2008.11-	Coupe Engine K4MP848		o	GHA225038	K
1.6 16V (81 kW)	2008.11-	Coupe Engine K4M858		o	GHA225038	K
1.6 16V Bifuel (81 kW)	2008.11-	Coupe Engine K4M866		o	GHA225038	K
1.6 DCi (96 kW)	2011.04-	Coupe Engine R9M402		o	GHA225038	K
1.9 DCi (96 kW)	2008.11-	Coupe Engine F9Q870/F9Q872		o	GHA225038	K
2.0 CVT (103 kW)	2009.05-	Coupe Engine F9QM4R711		o	GHA225038	K
2.0 DCi (110 kW)	2009.04-	Coupe Engine M9R615		o	GHA225038	K
2.0 DCi (118 kW)	2009.04-	Coupe Engine M9R610		o	GHA225038	K
2.0 DCi (120 kW)	2012.07-	Coupe Engine M9R610		o	GHA225038	K
2.0 R.S. (195 kW)	2008.11-	Coupe Engine F4R 874		o	GHA225038	K
2.0 TCE (132 kW)	2008.11-	Coupe Engine F4R870		o	GHA225038	K
2.0 TCE (140 kW)	2012.06-	Coupe		o	GHA225038	K
2.0 TCE (184 kW)	2009.05-	Coupe Engine F4R874		o	GHA225038	K
MEGANE III GRANDTOUR (KZ0/1)						
1.2 TCE (85 kW)	2012.03-	Estate Engine H5F400		o	GHA230137	K
1.2 TCE (97 kW)	2013.01-	Estate Engine H5F404		o	GHA230137	K
1.4 TCE (96 kW)	2009.05-	Estate Engine H4J700		o	GHA230137	K
1.5 DCi (63 kW)	2009.03-	Estate		o	GHA230137	K
1.5 DCi (66 kW)	2009.05-	Estate Engine K9K834		o	GHA230137	K
1.5 DCi (78 kW)	2009.02-	Estate Engine K9K836/K9K846		o	GHA230137	K
1.5 DCi (81 kW)	2009.02-	Estate Engine K9K636/K9K836/K9K837/K9K846		o	GHA230137	K
1.6 16V (74 kW)	2009.05-	Estate Engine K4M848		o	GHA230137	K
1.6 16V (81 kW)	2009.05-	Estate Engine K4M858		o	GHA230137	K
1.6 16V Bifuel (81 kW)	2008.11-	Estate Engine K4M866		o	GHA230137	K
1.6 DCi (96 kW)	2011.04-	Estate Engine K9M402/K9M404		o	GHA230137	K
1.9 DCi (96 kW)	2009.05-	Estate Engine F9Q870/F9Q872		o	GHA230137	K
2.0 CVT (103 kW)	2009.05-	Estate Engine M4R711/M4RF713		o	GHA230137	K
2.0 DCi (110 kW)	2010.10-	Estate Engine M9R615		o	GHA230137	K
2.0 DCi (118 kW)	2009.04-	Estate Engine M9R610		o	GHA230137	K
2.0 DCi (120 kW)	2012.07-	Estate Engine M9R610		o	GHA230137	K
2.0 TCE (132 kW)	2008.11-	Estate Engine F4R870/F4R872		o	GHA230137	K
2.0 TCE (140 kW)	2012.09-	Estate		o	GHA230137	K
2.0 TCE (162 kW)	2012.09-	Estate		o	GHA230137	K
MEGANE SCENIC (JA0/1_)						
1.4 i (55 kW)	1997.01-1999.09	MPV Engine E7J764	•		GHA421004	A
	1997.01-1999.09	MPV Engine E7J764	•		GWB3596	
	1997.01-1999.09	MPV Engine E7J764 With ABS		o	GHA225015	K
	1997.01-1999.09	MPV Engine E7J764 Without ABS		o	GHA225020	K
1.6 16V (79 kW)	1998.04-1999.10	MPV Engine K4M700/K4M701/K4M704/K4M708	•		GWB3495	
	1998.04-1999.10	MPV Engine K4M700/K4M701/K4M704/K4M708	•		GWB3596	



	 YEAR		F	R	G-AP Ref.	KIT
RENAULT						
MEGANE SCENIC (JA0/1_)						
1.6 16V (79 kW)	1998.04-1999.10	MPV Engine K4M700/K4M701/K4M704/K4M708		o	GHA225018	K
	1998.04-1999.10	MPV Engine K4M700/K4M701/K4M704/K4M708 With ABS		o	GHA225015	K
	1998.04-1999.10	MPV Engine K4M700/K4M701/K4M704/K4M708 Without ABS		o	GHA225020	K
1.6 e (66 kW)	1996.10-1999.10	MPV Engine K7M702/K7M703	•		GHA421004	A
	1996.10-1999.10	MPV Engine K7M702/K7M703	•		GHA423001	
	1996.10-1999.10	MPV Engine K7M702/K7M703	•		GWB3495	
	1996.10-1999.10	MPV Engine K7M702/K7M703	•		GWB3596	
	1996.10-1999.10	MPV Engine K7M702/K7M703 With ABS		o	GHA225015	K
	1996.10-1999.10	MPV Engine K7M702/K7M703 Without ABS		o	GHA225020	K
1.6 i (55 kW)	1997.01-1999.09	MPV Engine K7M720	•		GHA421004	A
	1997.01-1999.09	MPV Engine K7M720	•		GWB3596	
	1997.01-1999.09	MPV Engine K7M720 With ABS		o	GHA225015	K
	1997.01-1999.09	MPV Engine K7M720 Without ABS		o	GHA225020	K
1.9 D (47 kW)	1997.03-1999.09	MPV Engine F8Q790	•		GHA423001	
	1997.03-1999.09	MPV Engine F8Q790	•		GWB3495	
	1997.03-1999.09	MPV Engine F8Q790	•		GWB3596	
	1997.03-1999.09	MPV Engine F8Q790 With ABS		o	GHA225015	K
	1997.03-1999.09	MPV Engine F8Q790 Without ABS		o	GHA225020	K
1.9 DT (66 kW)	1997.01-1999.09	MPV Engine F8Q784/F8Q786	•		GHA423001	
	1997.01-1999.09	MPV Engine F8Q784/F8Q786	•		GWB3495	
	1997.01-1999.09	MPV Engine F8Q784/F8Q786	•		GWB3596	
	1997.01-1999.09	MPV Engine F8Q784/F8Q786 With ABS		o	GHA225015	K
	1997.01-1999.09	MPV Engine F8Q784/F8Q786 Without ABS		o	GHA225020	K
1.9 DTi (72 kW)	1997.04-1999.09	MPV Engine F9Q730/F9Q734	•		GHA423001	
	1997.04-1999.09	MPV Engine F9Q730/F9Q734	•		GWB3495	
	1997.04-1999.09	MPV Engine F9Q730/F9Q734	•		GWB3596	
	1997.04-1999.09	MPV Engine F9Q730/F9Q734		o	GWB3615	
	1997.04-1999.09	MPV Engine F9Q730/F9Q734 With ABS		o	GHA225015	K
	1997.04-1999.09	MPV Engine F9Q730/F9Q734 Without ABS		o	GHA225020	K
2.0 i (80 kW)	1999.01-1999.09	MPV Engine F3R796	•		GHA423003	K
	1999.01-1999.09	MPV Engine F3R796	•		GWB3596	
2.0 i (84 kW)	1997.01-1999.09	MPV Engine F3R750/F3R751	•		GHA423001	
	1997.01-1999.09	MPV Engine F3R750/F3R751	•		GHA423003	K
	1997.01-1999.09	MPV Engine F3R750/F3R751	•		GWB3495	
	1997.01-1999.09	MPV Engine F3R750/F3R751	•		GWB3596	
	1997.01-1999.09	MPV Engine F3R750/F3R751 With ABS		o	GHA225015	K
	1997.01-1999.09	MPV Engine F3R750/F3R751 Without ABS		o	GHA225020	K
2.0 RXE 4x4 (84 kW)	1997.05-1999.1	MPV Engine F3R 750	•		GWB3615	
MODUS / GRAND MODUS (F/JP0_)						
1.2 (48 kW)	2005.05-	Hatchback Engine D4F740	•		GWB3637	
	2005.05-	Hatchback Engine D4F740		o	GHA225019	K
	2005.05-	Hatchback Engine D4F740		o	GHA499032	K
	2005.05-	Hatchback Engine D4F740		o	GWB3525	
	2005.05-	Hatchback Engine D4F740		o	GWB3639	
	2005.05-	Hatchback Engine D4F740		o	GWB6658	
1.2 (55 kW)	2004.12-	Hatchback Engine D4F740	•		GWB3637	
	2004.12-	Hatchback Engine D4F740		o	GHA225019	K
	2004.12-	Hatchback Engine D4F740		o	GHA499032	K
	2004.12-	Hatchback Engine D4F740		o	GWB3525	
	2004.12-	Hatchback Engine D4F740		o	GWB3639	
	2004.12-	Hatchback Engine D4F740		o	GWB6658	
1.2 (58 kW)	2004.12-	Hatchback Engine D4F764	•		GWB3637	
	2004.12-	Hatchback Engine D4F764		o	GHA225019	K
	2004.12-	Hatchback Engine D4F764		o	GHA499032	K
	2004.12-	Hatchback Engine D4F764		o	GWB3525	
	2004.12-	Hatchback Engine D4F764		o	GWB3639	
	2004.12-	Hatchback Engine D4F764		o	GWB6658	
1.2 (76 kW)	2011.04-	Hatchback Engine D4F786	•		GWB3637	
	2011.04-	Hatchback Engine D4F786		o	GHA225019	K
	2011.04-	Hatchback Engine D4F786		o	GWB3525	
	2011.04-	Hatchback Engine D4F786		o	GWB3639	
1.2 16V (74 kW)	2007.04-	Hatchback Engine D4F784	•		GWB3637	
	2007.04-	Hatchback Engine D4F784		o	GHA225019	K



	 YEAR		F	R	G-AP Ref.	KIT
RENAULT						
MODUS / GRAND MODUS (F/JP0_)						
1.2 16V (74 kW)	2007.04-	Hatchback Engine D4F784		o	GHA499032	K
	2007.04-	Hatchback Engine D4F784		o	GWB3525	
	2007.04-	Hatchback Engine D4F784		o	GWB3639	
	2007.04-	Hatchback Engine D4F784		o	GWB6658	
1.2 16V Hi-Flex (55 kW)	2008.10-	Hatchback Engine D4F740	•		GWB3637	
	2008.10-	Hatchback Engine D4F740		o	GHA225019	K
	2008.10-	Hatchback Engine D4F740		o	GHA499032	K
	2008.10-	Hatchback Engine D4F740		o	GWB3525	
	2008.10-	Hatchback Engine D4F740		o	GWB3639	
	2008.10-	Hatchback Engine D4F740		o	GWB6658	
1.4 (72 kW)	2004.12-	Hatchback Engine K4J770	•		GWB3637	
	2004.12-	Hatchback Engine K4J770		o	GHA225019	K
	2004.12-	Hatchback Engine K4J770		o	GHA499032	K
	2004.12-	Hatchback Engine K4J770		o	GWB3525	
	2004.12-	Hatchback Engine K4J770		o	GWB3639	
	2004.12-	Hatchback Engine K4J770		o	GWB6658	
1.5 DCi (48 kW)	2004.12-	Hatchback Engine K9K752	•		GWB3637	
	2004.12-	Hatchback Engine K9K752	•		GWB3638	
	2004.12-	Hatchback Engine K9K752		o	GHA225019	K
	2004.12-	Hatchback Engine K9K752		o	GHA499032	K
	2004.12-	Hatchback Engine K9K752		o	GWB3525	
	2004.12-	Hatchback Engine K9K752		o	GWB3639	
	2004.12-	Hatchback Engine K9K752		o	GWB6658	
1.5 DCi (50 kW)	2004.12-	Hatchback Engine K9K762/K9K768	•		GWB3637	
	2004.12-	Hatchback Engine K9K762/K9K768	•		GWB3638	
	2004.12-	Hatchback Engine K9K762/K9K768		o	GHA225019	K
	2004.12-	Hatchback Engine K9K762/K9K768		o	GHA499032	K
	2004.12-	Hatchback Engine K9K762/K9K768		o	GWB3525	
	2004.12-	Hatchback Engine K9K762/K9K768		o	GWB3639	
	2004.12-	Hatchback Engine K9K762/K9K768		o	GWB6658	
1.5 DCi (55 kW)	2010.10-	Hatchback Engine K9K770	•		GWB3637	
	2010.10-	Hatchback Engine K9K770	•		GWB3638	
	2010.10-	Hatchback Engine K9K770		o	GHA225019	K
	2010.10-	Hatchback Engine K9K770		o	GHA499032	K
	2010.10-	Hatchback Engine K9K770		o	GWB3525	
	2010.10-	Hatchback Engine K9K770		o	GWB3639	
	2010.10-	Hatchback Engine K9K770		o	GWB6658	
1.5 DCi (60 kW)	2004.09-	Hatchback Engine K9K750	•		GWB3637	
	2004.09-	Hatchback Engine K9K750	•		GWB3638	
	2004.09-	Hatchback Engine K9K750		o	GHA225019	K
	2004.09-	Hatchback Engine K9K750		o	GHA499032	K
	2004.09-	Hatchback Engine K9K750		o	GWB3525	
	2004.09-	Hatchback Engine K9K750		o	GWB3639	
	2004.09-	Hatchback Engine K9K750		o	GWB6658	
1.5 DCi (63 kW)	2004.12-	Hatchback Engine K9K760/K9K766	•		GWB3637	
	2004.12-	Hatchback Engine K9K760/K9K766	•		GWB3638	
	2004.12-	Hatchback Engine K9K760/K9K766		o	GHA225019	K
	2004.12-	Hatchback Engine K9K760/K9K766		o	GHA499032	K
	2004.12-	Hatchback Engine K9K760/K9K766		o	GWB3525	
	2004.12-	Hatchback Engine K9K760/K9K766		o	GWB3639	
	2004.12-	Hatchback Engine K9K760/K9K766		o	GWB6658	
1.5 DCi (65 kW)	2010.10-	Hatchback Engine K9K750	•		GWB3637	
	2010.10-	Hatchback Engine K9K750	•		GWB3638	
	2010.10-	Hatchback Engine K9K750		o	GHA225019	K
	2010.10-	Hatchback Engine K9K750		o	GWB3525	
	2010.10-	Hatchback Engine K9K750		o	GWB3639	
	2010.10-	Hatchback Engine K9K750		o	GWB6658	
1.5 DCi (76 kW)	2007.05-	Hatchback Engine K9K772	•		GWB3637	
	2007.05-	Hatchback Engine K9K772	•		GWB3638	
	2007.05-	Hatchback Engine K9K772		o	GHA225019	K
	2007.05-	Hatchback Engine K9K772		o	GHA499032	K
	2007.05-	Hatchback Engine K9K772		o	GWB3525	
	2007.05-	Hatchback Engine K9K772		o	GWB3639	
	2007.05-	Hatchback Engine K9K772		o	GWB6658	



	 YEAR		F	R	G-AP Ref.	KIT
RENAULT						
MODUS / GRAND MODUS (F/JP0_)						
1.5 DCi (78 kW)	2005.04-2007.07	Hatchback Engine K9K764	•		GWB3637	
	2005.04-2007.07	Hatchback Engine K9K764	•		GWB3638	
	2005.04-2007.07	Hatchback Engine K9K764		o	GHA225019	K
	2005.04-2007.07	Hatchback Engine K9K764		o	GHA499032	K
	2005.04-2007.07	Hatchback Engine K9K764		o	GWB3525	
	2005.04-2007.07	Hatchback Engine K9K764		o	GWB3639	
	2005.04-2007.07	Hatchback Engine K9K764		o	GWB6658	
1.6 (65 kW)	2004.12-	Hatchback Engine K4M794	•		GWB3637	
	2004.12-	Hatchback Engine K4M794		o	GHA225019	K
	2004.12-	Hatchback Engine K4M794		o	GHA499032	K
	2004.12-	Hatchback Engine K4M794		o	GWB3525	
	2004.12-	Hatchback Engine K4M794		o	GWB3639	
1.6 (82 kW)	2004.12-	Hatchback Engine K4M790/K4M791/K4M800/K4M801	•		GWB3637	
	2004.12-	Hatchback Engine K4M790/K4M791/K4M800/K4M801		o	GHA225019	K
	2004.12-	Hatchback Engine K4M790/K4M791/K4M800/K4M801		o	GHA499032	K
	2004.12-	Hatchback Engine K4M790/K4M791/K4M800/K4M801		o	GWB3525	
	2004.12-	Hatchback Engine K4M790/K4M791/K4M800/K4M801		o	GWB3639	
2004.12-	Hatchback Engine K4M790/K4M791/K4M800/K4M801		o	GWB6658		
RAPID (F40_, G40_)						
1.2 (48 kW)	1995.05-1998.11	Box Engine E7F 708	•		GHA421001	
1.4 RN (44 kW)	1991.09-1993.08	Box Engine E6J 734	•		GHA421001	
	1991.09-1993.08	Box Engine E6J 734	•		GHA421004	A
SAFRANE (B54_)						
2.0 (77 kW)	1992.11-1996.07	Hatchback Engine J7R732/J7R733	•		GWB3495	
	1992.11-1996.07	Hatchback Engine J7R732/J7R733 Without ABS		o	GHA225020	K
2.0 12V (97 kW)	1992.04-1996.07	Hatchback Engine J7R734/J7R735	•		GWB3495	
	1992.04-1996.07	Hatchback Engine J7R734/J7R735		o	GHA225034	K
2.1 DT (65 kW)	1993.11-1996.07	Hatchback Engine J8S760	•		GWB3495	
	1993.11-1996.07	Hatchback Engine J8S760 Without ABS		o	GHA225020	K
2.2 (101 kW)	1992.04-1996.07	Hatchback Engine J7T760/J7T761	•		GWB3495	
	1992.04-1996.07	Hatchback Engine J7T760/J7T761		o	GHA225034	K
2.2 (79 kW)	1992.04-1996.07	Hatchback Engine J7T762	•		GWB3495	
	1992.04-1996.07	Hatchback Engine J7T762		o	GHA225034	K
2.5 DT (83 kW)	1992.04-1996.07	Hatchback Engine J7T762 Without ABS		o	GHA225020	K
	1992.12-1996.07	Hatchback Engine S8U762/S8U763	•		GWB3495	
3.0 Biturbo 4x4 (193 kW)	1992.12-1996.07	Hatchback Engine S8U762/S8U763		o	GHA225034	K
	1993.02-1996.07	Hatchback Engine Z7X726	•		GWB3495	
3.0 V6 (123 kW)	1992.12-1996.07	Hatchback Engine Z7X721/Z7X722/Z7X723	•		GWB3495	
	1992.12-1996.07	Hatchback Engine Z7X721/Z7X722/Z7X723		o	GHA225034	K
3.0 V6 4x4 (123 kW)	1992.12-1996.07	Hatchback Engine Z7X721/Z7X722/Z7X723	•		GWB3495	
SAFRANE II (B54_)						
2.0 16V (100 kW)	1996.07-2000.12	Hatchback Engine N7Q710/N7Q711	•		GWB3495	
	1996.07-2000.12	Hatchback Engine N7Q710/N7Q711		o	GHA225034	K
2.2 DT (83 kW)	1996.07-2000.12	Hatchback Engine G8T740	•		GWB3495	
	1996.07-2000.12	Hatchback Engine G8T740		o	GHA225034	K
2.5 20V (121 kW)	1996.07-2000.12	Hatchback Engine N7U700/N7U701	•		GWB3495	
	1996.07-2000.12	Hatchback Engine N7U700/N7U701		o	GHA225034	K
2.9 24V (140 kW)	1999.03-2000.12	Hatchback Engine L7X713	•		GWB3495	
	1999.03-2000.12	Hatchback Engine L7X713		o	GHA225034	K
3.0 V6 (123 kW)	1996.07-2000.12	Hatchback Engine Z7X755	•		GWB3495	
	1996.07-2000.12	Hatchback Engine Z7X755		o	GHA225034	K
SANDERO / STEPWAY						
1.4 (55 kW)	2009.02-	Hatchback Engine K7J710	•		GHA421012	
	2009.02-	Hatchback Engine K7J710	•		GWB3596	
	2009.02-	Hatchback Engine K7J710	•		GWB3637	
	2009.02-	Hatchback Engine K7J710		o	GWB3525	
	2009.02-	Hatchback Engine K7J710		o	GWB6658	
1.6 (64 kW)	2009.02-	Hatchback Engine K7M710	•		GWB3596	
	2009.02-	Hatchback Engine K7M710	•		GWB3637	
	2009.02-	Hatchback Engine K7M710		o	GWB3525	
	2009.02-	Hatchback Engine K7M710		o	GWB6658	



	 YEAR		F	R	G-AP Ref.	KIT
RENAULT						
SANDERO / STEPWAY I						
1.6 (75 kW)	2007.12-	Hatchback Engine K7M710	•		GWB3596	
	2007.12-	Hatchback Engine K7M710	•		GWB3637	
	2007.12-	Hatchback Engine K7M710		○	GWB3525	
	2007.12-	Hatchback Engine K7M710		○	GWB6658	
1.6 (76 kW)	2007.12-	Hatchback	•		GWB3596	
	2007.12-	Hatchback	•		GWB3637	
	2007.12-	Hatchback		○	GWB3525	
	2007.12-	Hatchback		○	GWB6658	
SANDERO/STEPWAY I						
1.6 (62 kW)	2010.11-	Hatchback Engine K7M718	•		GWB3596	
	2010.11-	Hatchback Engine K7M718	•		GWB3637	
	2010.11-	Hatchback Engine K7M718		○	GWB3525	
	2010.11-	Hatchback Engine K7M718		○	GWB6658	
SANDERO/STEPWAY II						
1.2 16V (54 kW)	2013.12-	Hatchback	•		GWB3596	
	2013.12-	Hatchback	•		GWB3637	
	2013.12-	Hatchback		○	GWB6658	
1.2 16V LPG (53 kW)	2013.12-	Hatchback	•		GWB3596	
	2013.12-	Hatchback	•		GWB3637	
	2013.12-	Hatchback		○	GWB6658	
1.5 DCi (62 kW)	2013.12-	Hatchback	•		GWB3596	
	2013.12-	Hatchback	•		GWB3637	
	2013.12-	Hatchback		○	GWB6658	
1.6 (59 kW)	2013.11-	Hatchback Engine K7M 812	•		GWB3596	
	2013.11-	Hatchback Engine K7M 812	•		GWB3637	
	2013.11-	Hatchback Engine K7M 812		○	GWB6658	
SCENIC I (JA0/1_)						
1.4 16V (70 kW)	1999.09-2003.08	MPV Engine K4J714/K4J750	•		GWB3596	
	1999.09-2003.08	MPV Engine K4J714/K4J750		○	GHA225018	K
1.6 (75 kW)	2001.03-2003.08	MPV Engine K4M708/K4M709	•		GWB3596	
	2001.03-2003.08	MPV Engine K4M708/K4M709		○	GHA225018	K
	2001.03-2003.08	MPV Engine K4M708/K4M709 With ABS		○	GHA225015	K
	2001.03-2003.08	MPV Engine K4M708/K4M709 Without ABS		○	GHA225020	K
1.6 (79 kW)	1999.09-2003.09	MPV Engine K4M700/K4M706	•		GWB3596	
	1999.09-2003.09	MPV Engine K4M700/K4M706		○	GHA225018	K
	1999.09-2003.09	MPV Engine K4M700/K4M706 With ABS		○	GHA225015	K
	1999.09-2003.09	MPV Engine K4M700/K4M706 Without ABS		○	GHA225020	K
1.6 (81 kW)	2001.06-2003.09	MPV	•		GWB3596	
	2001.06-2003.09	MPV With ABS		○	GHA225015	K
	2001.06-2003.09	MPV Without ABS		○	GHA225020	K
1.6 16V (85 kW)	1999.09-2003.08	MPV	•		GWB3596	
	1999.09-2003.08	MPV With ABS		○	GHA225015	K
	1999.09-2003.08	MPV Without ABS		○	GHA225020	K
1.6 BiFuel (79 kW)	1999.09-2001.04	MPV Engine K4M704	•		GWB3596	
	1999.09-2001.04	MPV Engine K4M704 With ABS		○	GHA225015	K
	1999.09-2001.04	MPV Engine K4M704 Without ABS		○	GHA225020	K
1.8 16V (85 kW)	2001.01-2003.08	MPV Engine F4P720/F4P722	•		GWB3596	
	2001.01-2003.08	MPV Engine F4P720/F4P722		○	GHA225018	K
1.8 4x4 (85 kW)	2000.07-2001.04	MPV Engine F4P722	•		GWB3596	
1.9 D (47 kW)	1999.09-2001.03	MPV Engine F8Q790	•		GWB3596	
1.9 DCi (75 kW)	1999.09-2003.08	MPV Engine F9Q732/F9Q733	•		GWB3596	
	1999.09-2003.08	MPV Engine F9Q732/F9Q733		○	GHA225018	K
1.9 DCi RX4 (74 kW)	2002.12-2003.08	MPV Engine F9Q732/F9Q748/F9Q796	•		GWB3615	
1.9 DCi RX4 (75 kW)	2000.11-2003.08	MPV Engine F9Q740	•		GWB3615	
1.9 DTi (59 kW)	2001.02-2003.08	MPV Engine F9Q744	•		GWB3596	
	2001.02-2003.08	MPV Engine F9Q744		○	GHA225018	K
1.9 DTi (72 kW)	1999.09-2003.08	MPV Engine F9Q731/F9Q734/F9Q736	•		GWB3596	
	1999.09-2003.08	MPV Engine F9Q731/F9Q734/F9Q736		○	GHA225018	K
2.0 16V (102 kW)	2000.07-2003.08	MPV Engine F4R740/F4R741/F4R746	•		GWB3596	
	2000.07-2003.08	MPV Engine F4R740/F4R741/F4R746		○	GHA225018	K
2.0 16V (103 kW)	1999.09-2003.08	MPV Engine F4R740/F4R741/F4R744	•		GWB3596	
	1999.09-2003.08	MPV Engine F4R740/F4R741/F4R744		○	GHA225018	K
2.0 16V RX4 (102 kW)	2000.06-2003.08	MPV Engine F4R744/F4R746	•		GWB3615	



	 YEAR		F	R	G-AP Ref.	KIT
RENAULT						
SCENIC II (JM0/1_)						
1.4 (72 kW)	2003.07-2007.07	MPV Engine K4J730/K4J740	•		GWB3638	
	2003.07-2007.07	MPV Engine K4J730/K4J740		◦	GHA225041	K
	2003.07-2007.07	MPV Engine K4J730/K4J740		◦	GWB3676	
1.5 DCi (60 kW)	2003.07-2005.11	MPV Engine K9K722	•		GWB3638	
	2003.07-2005.11	MPV Engine K9K722		◦	GHA225041	K
	2003.07-2005.11	MPV Engine K9K722		◦	GWB3676	
1.5 DCi (63 kW)	2005.04-2006.10	MPV Engine K9K724	•		GWB3638	
	2005.04-2006.10	MPV Engine K9K724		◦	GHA225041	K
	2005.04-2006.10	MPV Engine K9K724		◦	GWB3676	
1.5 DCi (74 kW)	2003.11-2004.03	MPV Engine K9K728/K9K729	•		GWB3638	
	2003.11-2004.03	MPV Engine K9K728/K9K729		◦	GHA225041	K
	2003.11-2004.03	MPV Engine K9K728/K9K729		◦	GWB3676	
1.5 DCi (76 kW)	2007.01-	MPV Engine K9K734	•		GWB3638	
	2007.01-	MPV Engine K9K734		◦	GWB3676	
1.5 DCi (78 kW)	2005.04-2006.10	MPV Engine K9K732	•		GWB3638	
	2005.04-2006.10	MPV Engine K9K732		◦	GHA225041	K
	2005.04-2006.10	MPV Engine K9K732		◦	GWB3676	
1.6 (77 kW)	2006.06-	MPV Engine K4M788	•		GWB3638	
	2006.06-	MPV Engine K4M788		◦	GHA225041	K
	2006.06-	MPV Engine K4M788		◦	GWB3676	
1.6 (83 kW)	2003.07-2007.07	MPV Engine K4M761/K4M782	•		GWB3638	
	2003.07-2007.07	MPV Engine K4M761/K4M782		◦	GHA225041	K
	2003.07-2007.07	MPV Engine K4M761/K4M782		◦	GWB3676	
1.6 16V (82 kW)	2007.01-	MPV Engine K4M812/K4M9766/K4MC813	•		GWB3638	
	2007.01-	MPV Engine K4M812/K4M9766/K4MC813		◦	GHA225041	K
	2007.01-	MPV Engine K4M812/K4M9766/K4MC813		◦	GWB3676	
1.9 D (85 kW)	2006.06-	MPV Engine F9Q812/F9QJ803	•		GWB3638	
	2006.06-	MPV Engine F9Q812/F9QJ803		◦	GWB3676	
1.9 DCi (81 kW)	2005.05-	MPV Engine F9Q804	•		GWB3638	
	2005.05-	MPV Engine F9Q804		◦	GHA225041	K
	2005.05-	MPV Engine F9Q804		◦	GWB3676	
1.9 DCi (88 kW)	2003.07-2005.07	MPV Engine F9Q812	•		GWB3638	
	2003.07-2005.07	MPV Engine F9Q812		◦	GHA225041	K
	2003.07-2005.07	MPV Engine F9Q812		◦	GHA230140	K
	2003.07-2005.07	MPV Engine F9Q812		◦	GWB3676	
1.9 DCi (92 kW)	2003.06-	MPV Engine F9Q804	•		GWB3638	
	2003.06-	MPV Engine F9Q804		◦	GHA225041	K
	2003.06-	MPV Engine F9Q804		◦	GWB3676	
1.9 DCi (96 kW)	2005.05-2007.07	MPV Engine F9Q804/F9Q816/F9Q818/F9QJ803	•		GWB3638	
	2005.05-2007.07	MPV Engine F9Q804/F9Q816/F9Q818/F9QJ803		◦	GHA225041	K
	2005.05-2007.07	MPV Engine F9Q804/F9Q816/F9Q818/F9QJ803		◦	GWB3676	
2.0 (101 kW)	2008.02-2009.04	MPV Engine F4R 770	•		GWB3638	
	2008.02-2009.04	MPV Engine F4R 770		◦	GWB3676	
2.0 (99 kW)	2003.07-2006.11	MPV Engine F4R770/F4R771	•		GWB3638	
	2003.07-2006.11	MPV Engine F4R770/F4R771		◦	GHA225041	K
	2003.07-2006.11	MPV Engine F4R770/F4R771		◦	GWB3676	
2.0 16V Turbo (120 kW)	2003.11-2006.10	MPV Engine F4R776	•		GWB3638	
	2003.11-2006.10	MPV Engine F4R776		◦	GHA225041	K
	2003.11-2006.10	MPV Engine F4R776		◦	GWB3676	
2.0 DCi (110 kW)	2006.07-	MPV Engine M9R700/M9R721/M9R722	•		GWB3692	
	2006.07-	MPV Engine M9R700/M9R721/M9R722		◦	GWB3676	
SCENIC III (JZ0/1_)						
1.2 TCE (85 kW)	2012.04-	MPV Engine H5F400		◦	GHA230137	K
1.2 TCE (97 kW)	2013.01-	MPV Engine H5F404		◦	GHA230137	K
1.4 16V (96 kW)	2009.02-	MPV Engine H4J700		◦	GHA230137	K
	2009.02-	MPV Engine H4J700		◦	GHA230138	K
1.5 DCi (63 kW)	2009.04-	MPV Engine K9K830		◦	GHA230137	K
1.5 DCi (70 kW)	2010.11-	MPV Engine K9K846		◦	GHA230137	K
1.5 DCi (78 kW)	2009.02-	MPV Engine K9K832		◦	GHA230137	K
1.5 DCi (81 kW)	2009.04-	MPV Engine K9K636/K9K836/K9K837		◦	GHA230137	K
	2009.04-	MPV Engine K9K636/K9K836/K9K837		◦	GHA230138	K
1.6 16V (81 kW)	2009.02-	MPV Engine K4M858		◦	GHA230137	K
	2009.02-	MPV Engine K4M858		◦	GHA230138	K
1.6 DCi (96 kW)	2011.04-	MPV Engine R9M402/R9M404		◦	GHA230137	K



	 YEAR		F	R	G-AP Ref.	KIT
RENAULT						
SCENIC III (JZ0/1_)						
1.6 E85 (81 kW)	2009.02-	MPV Engine K4M866		o	GHA230137	K
1.9 DCi (96 kW)	2009.02-	MPV Engine F9Q870		o	GHA230137	K
	2009.02-	MPV Engine F9Q870		o	GHA230138	K
2.0 16V (103 kW)	2009.02-	MPV Engine M4R710/M4R711		o	GHA230137	K
2.0 DCi (110 kW)	2009.02-	MPV Engine M9R615		o	GHA230138	K
2.0 DCi (118 kW)	2009.04-	MPV Engine M9R610		o	GHA230138	K
THALIA I (LB0/1/2_)						
1.2 16V (55 kW)	2002.04-	Saloon Engine D4F712	•		GHA421001	
	2002.04-	Saloon Engine D4F712	•		GWB3496	
	2002.04-	Saloon Engine D4F712		o	GHA225039	K
	2002.04-	Saloon Engine D4F712		o	GHA225040	K
	2002.04-	Saloon Engine D4F712		o	GWB3525	
1.4 (55 kW)	2000.08-	Saloon Engine K7J700	•		GHA421001	
	2000.08-	Saloon Engine K7J700	•		GWB3496	
	2000.08-	Saloon Engine K7J700		o	GHA225039	K
	2000.08-	Saloon Engine K7J700		o	GHA225040	K
	2000.08-	Saloon Engine K7J700		o	GWB3525	
1.4 16V (72 kW)	2000.08-	Saloon Engine K4J712	•		GWB3596	
	2000.08-	Saloon Engine K4J712		o	GHA225039	K
	2000.08-	Saloon Engine K4J712		o	GHA225040	K
	2000.08-	Saloon Engine K4J712		o	GWB3525	
1.5 DCi (47 kW)	2005.06-	Saloon Engine K9K740	•		GWB3596	
	2005.06-	Saloon Engine K9K740		o	GHA225039	K
	2005.06-	Saloon Engine K9K740		o	GWB3525	
1.5 DCi (48 kW)	2002.04-	Saloon Engine K9K700	•		GWB3596	
	2002.04-	Saloon Engine K9K700		o	GHA225039	K
	2002.04-	Saloon Engine K9K700		o	GHA225040	K
	2002.04-	Saloon Engine K9K700		o	GWB3525	
1.5 DCi (50 kW)	2003.02-	Saloon Engine K9K700/K9K714	•		GWB3596	
	2003.02-	Saloon Engine K9K700/K9K714		o	GHA225039	K
	2003.02-	Saloon Engine K9K700/K9K714		o	GWB3525	
1.5 DCi (60 kW)	2001.06-	Saloon Engine K9K702	•		GWB3596	
	2001.06-	Saloon Engine K9K702		o	GHA225039	K
	2001.06-	Saloon Engine K9K702		o	GHA225040	K
	2001.06-	Saloon Engine K9K702		o	GWB3525	
1.6 (66 kW)	1998.03-	Saloon Engine K7M746	•		GWB3596	
	1998.03-	Saloon Engine K7M746		o	GHA225040	K
	1998.03-	Saloon Engine K7M746		o	GWB3525	
1.6 16V (79 kW)	2002.04-	Saloon Engine K4M740	•		GWB3596	
	2002.04-	Saloon Engine K4M740		o	GHA225040	K
	2002.04-	Saloon Engine K4M740		o	GWB3525	
1.9 D (48 kW)	1998.02-2001.05	Saloon Engine F8Q630	•		GWB3596	
	1998.02-2001.05	Saloon Engine F8Q630		o	GHA225040	K
	1998.02-2001.05	Saloon Engine F8Q630		o	GWB3525	
THALIA II (LU1/2_)						
1.2 16V (LU2V) (55 kW)	2008.09-	Saloon Engine D4F728	•		GHA421001	
	2008.09-	Saloon Engine D4F728	•		GWB3496	
	2008.09-	Saloon Engine D4F728		o	GWB3525	
1.5 DCi (47 kW)	2008.09-	Saloon Engine K9K740	•		GWB3596	
	2008.09-	Saloon Engine K9K740		o	GWB3525	
1.5 DCi (48 kW)	2009.01-	Saloon Engine K9K700	•		GWB3596	
	2009.01-	Saloon Engine K9K700		o	GWB3525	
1.5 DCi (62 kW)	2008.09-	Saloon Engine K9K718	•		GWB3596	
	2008.09-	Saloon Engine K9K718		o	GWB3525	
1.6 16V (77 kW)	2008.09-	Saloon Engine K4M743	•		GWB3596	
	2008.09-	Saloon Engine K4M743		o	GWB3525	
TRAFIC (TXW)						
1.7 (50 kW)	1992.08-1994.08	Bus Engine F1N724	•		GWB0909	
	1992.08-1994.08	Bus Engine F1N724		o	GWB0828	
1.9 D (44 kW)	1997.06-2001.03	Bus Engine F8Q606	•		GWB0909	
	1997.06-2001.03	Bus Engine F8Q606		o	GWB0828	
2.1 D (47 kW)	1994.06-1997.10	Bus Engine J8S620/J8S758	•		GWB0909	
	1994.06-1997.10	Bus Engine J8S620/J8S758		o	GWB0828	
2.2 (74 kW)	1994.06-1997.10	Bus Engine J7T600	•		GWB0909	



	 YEAR		F	R	G-AP Ref.	KIT
RENAULT						
TRAFIC (TXW)						
2.2 (74 kW)	1994.06-1997.10	Bus Engine J7T600		○	GWB0828	
2.2 4x4 (74 kW)	1994.06-1997.10	Bus Engine J7T600	●		GWB0909	
TRAFIC (TXX)						
1.7 (50 kW)	1992.08-1994.08	Box Engine F1N720	●		GWB0909	
	1992.08-1994.08	Box Engine F1N720		○	GWB0828	
1.9 D (44 kW)	1997.06-2001.03	Box Engine F8Q606	●		GWB0909	
	1997.06-2001.03	Box Engine F8Q606		○	GWB0828	
2.1 D (47 kW)	1994.06-1997.10	Box Engine J8S620/J8S758	●		GWB0909	
	1994.06-1997.10	Box Engine J8S620/J8S758		○	GWB0828	
2.2 (74 kW)	1994.06-1997.10	Box Engine J7T600	●		GWB0909	
	1994.06-1997.10	Box Engine J7T600		○	GWB0828	
2.2 4x4 (74 kW)	1994.06-1997.10	Box Engine J7T600	●		GWB0909	
TRAFIC II (EL)						
1.9 DCi (59 kW)	2001.09-2003.07	Platform/Chassis Engine F9Q 762	●		GWB3616	
	2001.09-2003.07	Platform/Chassis Engine F9Q 762	●		GWB3618	
	2001.09-2003.07	Platform/Chassis Engine F9Q 762	●		GWB3648	
	2001.09-2003.07	Platform/Chassis Engine F9Q 762		○	GHA235025	
	2001.09-2003.07	Platform/Chassis Engine F9Q 762		○	GWB3617	
1.9 DCi (60 kW)	2001.03-	Platform/Chassis Engine F9Q762	●		GWB3616	
	2001.03-	Platform/Chassis Engine F9Q762	●		GWB3618	
	2001.03-	Platform/Chassis Engine F9Q762	●		GWB3648	
	2001.03-	Platform/Chassis Engine F9Q762		○	GHA235025	
	2001.03-	Platform/Chassis Engine F9Q762		○	GWB3617	
1.9 DCi (74 kW)	2001.03-	Platform/Chassis Engine F9Q760	●		GWB3616	
	2001.03-	Platform/Chassis Engine F9Q760	●		GWB3618	
	2001.03-	Platform/Chassis Engine F9Q760	●		GWB3648	
	2001.03-	Platform/Chassis Engine F9Q760		○	GHA235025	
	2001.03-	Platform/Chassis Engine F9Q760		○	GWB3617	
2.0 (88 kW)	2001.03-	Platform/Chassis Engine F4R720	●		GWB3616	
	2001.03-	Platform/Chassis Engine F4R720	●		GWB3618	
	2001.03-	Platform/Chassis Engine F4R720	●		GWB3648	
	2001.03-	Platform/Chassis Engine F4R720		○	GHA235025	
	2001.03-	Platform/Chassis Engine F4R720		○	GWB3617	
2.0 DCi (66 kW)	2006.08-	Platform/Chassis Engine M9R780/M9R782	●		GWB3648	
	2006.08-	Platform/Chassis Engine M9R780/M9R782		○	GHA235025	
	2006.08-	Platform/Chassis Engine M9R780/M9R782		○	GWB3617	
2.0 DCi (84 kW)	2006.08-	Platform/Chassis Engine M9R780/M9R782/M9R786	●		GWB3648	
	2006.08-	Platform/Chassis Engine M9R780/M9R782/M9R786		○	GHA235025	
	2006.08-	Platform/Chassis Engine M9R780/M9R782/M9R786		○	GWB3617	
2.5 DCi (107 kW)	2006.08-	Platform/Chassis Engine G9U630	●		GWB3648	
	2006.08-	Platform/Chassis Engine G9U630		○	GHA235025	
	2006.08-	Platform/Chassis Engine G9U630		○	GWB3617	
2.5 DCi (84 kW)	2007.08-	Platform/Chassis Engine G9U630	●		GWB3648	
	2007.08-	Platform/Chassis Engine G9U630		○	GWB3617	
2.5 DCi (99 kW)	2001.03-	Platform/Chassis Engine G9U730	●		GWB3616	
	2001.03-	Platform/Chassis Engine G9U730	●		GWB3618	
	2001.03-	Platform/Chassis Engine G9U730	●		GWB3648	
	2001.03-	Platform/Chassis Engine G9U730		○	GHA235025	
	2001.03-	Platform/Chassis Engine G9U730		○	GWB3617	
TRAFIC II (FL)						
2.5 DCi (84 kW)	2007.08-	Box	●		GWB3648	
	2007.08-	Box		○	GHA235025	
	2007.08-	Box		○	GWB3617	
TRAFIC II (JL)						
1.9 DCi (59 kW)	2001.04-2003.07	Bus Engine F9Q762	●		GWB3616	
	2001.04-2003.07	Bus Engine F9Q762	●		GWB3618	
	2001.04-2003.07	Bus Engine F9Q762	●		GWB3648	
	2001.04-2003.07	Bus Engine F9Q762		○	GHA235025	
	2001.04-2003.07	Bus Engine F9Q762		○	GWB3617	
1.9 DCi (60 kW)	2001.03-	Bus Engine F9Q762	●		GWB3616	
	2001.03-	Bus Engine F9Q762	●		GWB3618	
	2001.03-	Bus Engine F9Q762	●		GWB3648	
	2001.03-	Bus Engine F9Q762		○	GHA235025	
	2001.03-	Bus Engine F9Q762		○	GWB3617	



	 YEAR		F	R	G-AP Ref.	KIT
RENAULT						
TRAFIC II (JL)						
1.9 DCi (74 kW)	2001.03-	Bus Engine F9Q760	•		GWB3616	
	2001.03-	Bus Engine F9Q760	•		GWB3618	
	2001.03-	Bus Engine F9Q760	•		GWB3648	
	2001.03-	Bus Engine F9Q760		○	GHA235025	
	2001.03-	Bus Engine F9Q760		○	GWB3617	
2.0 (88 kW)	2001.03-	Bus Engine F4R720/F4R722	•		GWB3616	
	2001.03-	Bus Engine F4R720/F4R722	•		GWB3618	
	2001.03-	Bus Engine F4R720/F4R722	•		GWB3648	
	2001.03-	Bus Engine F4R720/F4R722		○	GHA235025	
	2001.03-	Bus Engine F4R720/F4R722		○	GWB3617	
2.0 16V (86 kW)	2006.08-	Bus Engine F4R820	•		GWB3648	
	2006.08-	Bus Engine F4R820		○	GHA235025	
	2006.08-	Bus Engine F4R820		○	GWB3617	
2.0 DCi (66 kW)	2006.08-	Bus Engine M9R782	•		GWB3648	
	2006.08-	Bus Engine M9R782		○	GHA235025	
	2006.08-	Bus Engine M9R782		○	GWB3617	
2.0 DCi (84 kW)	2006.08-	Bus Engine M9R780/M9R692/M9R786/M9R782/M9R630	•		GWB3648	
	2006.08-	Bus Engine M9R780/M9R692/M9R786/M9R782/M9R630		○	GHA235025	
	2006.08-	Bus Engine M9R780/M9R692/M9R786/M9R782/M9R630		○	GWB3617	
2.5 DCi (107 kW)	2006.08-	Bus Engine G9U630	•		GWB3648	
	2006.08-	Bus Engine G9U630		○	GHA235025	
	2006.08-	Bus Engine G9U630		○	GWB3617	
2.5 DCi (84 kW)	2008.02-	Bus Engine G9U630		○	GHA235025	
2.5 DCi (99 kW)	2003.05-	Bus Engine G9U730	•		GWB3648	
	2003.05-	Bus Engine G9U730		○	GHA235025	
	2003.05-	Bus Engine G9U730		○	GWB3617	
TRAFIC II VAN (FL)						
1.9 DCi (59 kW)	2001.04-2003.07	Box Engine F9Q762	•		GWB3616	
	2001.04-2003.07	Box Engine F9Q762	•		GWB3618	
	2001.04-2003.07	Box Engine F9Q762	•		GWB3648	
	2001.04-2003.07	Box Engine F9Q762		○	GHA235025	
	2001.04-2003.07	Box Engine F9Q762		○	GWB3617	
1.9 DCi (60 kW)	2001.03-	Box Engine F9Q760/F9Q762	•		GWB3616	
	2001.03-	Box Engine F9Q760/F9Q762	•		GWB3618	
	2001.03-	Box Engine F9Q760/F9Q762	•		GWB3648	
	2001.03-	Box Engine F9Q760/F9Q762		○	GHA235025	
	2001.03-	Box Engine F9Q760/F9Q762		○	GWB3617	
1.9 DCi (74 kW)	2001.03-	Box Engine F9Q760	•		GWB3616	
	2001.03-	Box Engine F9Q760	•		GWB3618	
	2001.03-	Box Engine F9Q760	•		GWB3648	
	2001.03-	Box Engine F9Q760		○	GHA235025	
	2001.03-	Box Engine F9Q760		○	GWB3617	
1.9 DCi (75 kW)	2001.03-	Box Engine F9Q760	•		GWB3616	
	2001.03-	Box Engine F9Q760	•		GWB3618	
	2001.03-	Box Engine F9Q760	•		GWB3648	
	2001.03-	Box Engine F9Q760		○	GWB3617	
2.0 (88 kW)	2001.03-	Box Engine F4R720/F4R722	•		GWB3616	
	2001.03-	Box Engine F4R720/F4R722	•		GWB3618	
	2001.03-	Box Engine F4R720/F4R722	•		GWB3648	
	2001.03-	Box Engine F4R720/F4R722		○	GHA235025	
	2001.03-	Box Engine F4R720/F4R722		○	GWB3617	
2.0 16V (86 kW)	2006.08-	Box Engine F4R820	•		GWB3648	
	2006.08-	Box Engine F4R820		○	GHA235025	
	2006.08-	Box Engine F4R820		○	GWB3617	
2.0 DCi (66 kW)	2006.08-	Box Engine M9R780/M9R782/M9R630	•		GWB3648	
	2006.08-	Box Engine M9R780/M9R782/M9R630		○	GHA235025	
	2006.08-	Box Engine M9R780/M9R782/M9R630		○	GWB3617	
2.0 DCi (84 kW)	2006.08-	Box Engine M9R692/M9R780/M9R782/M9R786	•		GWB3648	
	2006.08-	Box Engine M9R692/M9R780/M9R782/M9R786		○	GHA235025	
	2006.08-	Box Engine M9R692/M9R780/M9R782/M9R786		○	GWB3617	
2.5 DCi (107 kW)	2006.08-	Box Engine G9U630	•		GWB3648	
	2006.08-	Box Engine G9U630		○	GHA235025	
	2006.08-	Box Engine G9U630		○	GWB3617	
2.5 DCi (99 kW)	2003.05-	Box Engine G9U730	•		GWB3648	



	 YEAR		F	R	G-AP Ref.	KIT
RENAULT						
TRAFIC II VAN (FL)						
2.5 DCi (99 kW)	2003.05-	Box Engine G9U730		o	GHA235025	
	2003.05-	Box Engine G9U730		o	GWB3617	
2.5 DTi (99 kW)	2003.03-2003.07	Box Engine G9U730	•		GWB3648	
	2003.03-2003.07	Box Engine G9U730		o	GWB3617	
TWINGO I (C06_)						
1.2 (40 kW)	1993.03-1996.10	Hatchback Engine C3G700/C3G702	•		GHA421001	
	1993.03-1996.10	Hatchback Engine C3G700/C3G702	•		GWB3496	
	1993.03-1996.10	Hatchback Engine C3G700/C3G702		o	GWB3525	
	1996.05-	Hatchback Engine D7F700/D7F701	•		GHA421001	
	1996.05-	Hatchback Engine D7F700/D7F701	•		GWB3496	
	1996.05-	Hatchback Engine D7F700/D7F701		o	GWB3525	
1.2 (43 kW)	1996.05-	Hatchback Engine D7F700/D7F701/D7F702/D7F703/D7F704	•		GHA421001	
	1996.05-	Hatchback Engine D7F700/D7F701/D7F702/D7F703/D7F704	•		GWB3496	
	1996.05-	Hatchback Engine D7F700/D7F701/D7F702/D7F703/D7F704		o	GWB3525	
1.2 (44 kW)	1998.09-2000.08	Hatchback Engine D7F 702	•		GHA421001	
	1998.09-2000.08	Hatchback Engine D7F 702	•		GWB3496	
	1998.09-2000.08	Hatchback Engine D7F 702		o	GWB3525	
1.2 16V (44 kW)	2004.08-	Hatchback Engine D4F708	•		GHA421001	
	2004.08-	Hatchback Engine D4F708	•		GWB3496	
	2004.08-	Hatchback Engine D4F708		o	GWB3525	
1.2 16V (55 kW)	2001.01-	Hatchback Engine D4F702	•		GHA421001	
	2001.01-	Hatchback Engine D4F702	•		GWB3496	
	2001.01-	Hatchback Engine D4F702		o	GWB3525	
1.2 LPG (44 kW)	2003.10-	Hatchback Engine D7F 702/D7F 708	•		GHA421001	
	2003.10-	Hatchback Engine D7F 702/D7F 708	•		GWB3496	
	2003.10-	Hatchback Engine D7F 702/D7F 708		o	GWB3525	
TWINGO I (S06_)						
1.2 (40 kW)	1993.03-1996.05	Box Engine C3G700/C3G702	•		GHA421001	
	1993.03-1996.05	Box Engine C3G700/C3G702	•		GWB3496	
	1993.03-1996.05	Box Engine C3G700/C3G702		o	GWB3525	
1.2 (43 kW)	1996.05-	Box Engine D7F700/D7F701/D7F702/D7F703/D7F704/D7F706	•		GHA421001	
	1996.05-	Box Engine D7F700/D7F701/D7F702/D7F703/D7F704/D7F706	•		GWB3496	
	1996.05-	Box Engine D7F700/D7F701/D7F702/D7F703/D7F704/D7F706		o	GWB3525	
TWINGO II (CN0_)						
	2008.01-	Hatchback Engine D7F800	•		GWB3637	
	2008.01-	Hatchback Engine D7F800		o	GWB3525	
1.2 16V (55 kW)	2007.03-	Hatchback Engine D4F722	•		GWB3637	
	2007.03-	Hatchback Engine D4F722		o	GWB3525	
1.2 16V (56 kW)	2007.03-	Hatchback Engine D4F772	•		GWB3637	
	2007.03-	Hatchback Engine D4F772		o	GWB3525	
1.2 TCE (75 kW)	2011.02-	Hatchback Engine D4F780/D4F782	•		GWB3637	
	2011.02-	Hatchback Engine D4F780/D4F782		o	GWB3525	
1.2 Turbo (74 kW)	2007.07-	Hatchback Engine D4F780	•		GWB3637	
	2007.07-	Hatchback Engine D4F780		o	GWB3525	
1.5 DCi (47 kW)	2007.03-	Hatchback Engine K9K740	•		GWB3637	
	2007.03-	Hatchback Engine K9K740		o	GWB3525	
1.5 DCi (55 kW)	2010.10-	Hatchback Engine K9K820	•		GWB3637	
	2010.10-	Hatchback Engine K9K820		o	GWB3525	
1.5 DCi (62 kW)	2008.04-	Hatchback Engine K9K718	•		GWB3637	
	2008.04-	Hatchback Engine K9K718		o	GWB3525	
1.5 DCi (63 kW)	2010.10-	Hatchback Engine K9K830	•		GWB3637	
	2010.10-	Hatchback Engine K9K830		o	GWB3525	
1.6 RS (98 kW)	2008.05-	Hatchback Engine K4M854	•		GWB3638	
	2008.05-	Hatchback Engine K4M854		o	GHA225019	K
	2008.05-	Hatchback Engine K4M854		o	GWB3639	
TWIZY (MAM_)						
45 (4 kW)	2012.04-	Hatchback Engine 3CG400	•		GWB3525	
80 (13 kW)	2012.04-	Hatchback Engine 3CG401	•		GWB3525	
VEL SATIS (BJ0_)						
2.0 16V Turbo (120 kW)	2002.06-	MPV Engine F4R762/F4R763	•		GWB3648	
	2002.06-	MPV Engine F4R762/F4R763		o	GHA230142	K
2.0 16V Turbo (125 kW)	2004.04-	MPV Engine F4R766/F4R767	•		GWB3648	
	2004.04-	MPV Engine F4R766/F4R767		o	GHA230142	K



	 YEAR		F	R	G-AP Ref.	KIT
RENAULT						
VEL SATIS (BJ0_)						
2.0 DCi (110 kW)	2005.08-	MPV Engine M9R760	•		GWB3648	
	2005.08-	MPV Engine M9R760		◦	GHA230142	K
2.0 DCi (127 kW)	2006.01-	MPV Engine M9R760/M9R762/M9R763	•		GWB3648	
	2006.01-	MPV Engine M9R760/M9R762/M9R763		◦	GHA230142	K
2.0 Turbo (108 kW)	2005.04-	MPV Engine F4R 867	•		GWB3648	
2.2 DCi (102 kW)	2004.09-	MPV Engine G9T600/G9T606/G9T607/G9T700/G9T702	•		GWB3648	
	2004.09-	MPV Engine G9T600/G9T606/G9T607/G9T700/G9T702		◦	GHA230142	K
2.2 DCi (110 kW)	2002.06-	MPV Engine G9T702/G9T703	•		GWB3648	
	2002.06-	MPV Engine G9T702/G9T703		◦	GHA230142	K
2.2 DCi (83 kW)	2004.12-	MPV	•		GWB3648	
	2004.12-	MPV		◦	GHA230142	K
2.2 DCi (85 kW)	2004.04-	MPV Engine G9T600	•		GWB3648	
	2004.04-	MPV Engine G9T600		◦	GHA230142	K
3.0 DCi (130 kW)	2002.06-	MPV Engine P9X701	•		GWB3648	
	2002.06-	MPV Engine P9X701		◦	GHA230142	K
3.0 DCi (133 kW)	2006.06-	MPV Engine P9X715	•		GWB3648	
	2006.06-	MPV Engine P9X715		◦	GHA230142	K
3.5 (170 kW)	2004.10-	MPV Engine V4Y715	•		GWB3648	
3.5 V6 (177 kW)	2002.06-	MPV Engine V4Y701/V4Y711	•		GWB3648	
	2002.06-	MPV Engine V4Y701/V4Y711		◦	GHA230142	K
WIND (E4M_)						
1.2 (74 kW)	2010.07-	Convertible Engine D4F782	•		GWB3638	
	2010.07-	Convertible Engine D4F782		◦	GHA225019	K
	2010.07-	Convertible Engine D4F782		◦	GWB3639	
1.2 TCE (75 kW)	2011.02-	Convertible Engine D4F780	•		GWB3638	
	2011.02-	Convertible Engine D4F780		◦	GHA225019	K
	2011.02-	Convertible Engine D4F780		◦	GWB3639	
1.6 (98 kW)	2010.07-	Convertible Engine K4M854	•		GWB3638	
	2010.07-	Convertible Engine K4M854		◦	GHA225019	K
	2010.07-	Convertible Engine K4M854		◦	GWB3639	
ZOE						
ZOE (65 kW)	2012.06-	Hatchback	•		GWB3637	
	2012.06-	Hatchback		◦	GWB6799	
ROVER						
200 (RF)						
1.1 (44 kW)	1998.01-2000.03	Hatchback Engine 11K2D	•		GWB1374	
	1998.01-2000.03	Hatchback Engine 11K2D		◦	GHA230117	K
1.4 i (55 kW)	1995.11-2000.03	Hatchback Engine 14K2F	•		GWB1374	
	1995.11-2000.03	Hatchback Engine 14K2F		◦	GHA230117	K
1.4 Si (76 kW)	1995.11-2000.03	Hatchback Engine 14K4F	•		GWB1374	
	1995.11-2000.03	Hatchback Engine 14K4F		◦	GHA230117	K
	1995.11-2000.03	Hatchback Engine 14K4F		◦	GHA230151	K
1.6 Si (82 kW)	1995.11-2000.03	Hatchback Engine 16K4F	•		GWB1374	
	1995.11-2000.03	Hatchback Engine 16K4F		◦	GHA230117	K
	1995.11-2000.03	Hatchback Engine 16K4F		◦	GHA230151	K
1.8 K Vi (107 kW)	1995.11-2000.03	Hatchback Engine 18K4K	•		GWB1374	
	1995.11-2000.03	Hatchback Engine 18K4K		◦	GHA230117	K
1.8 Si (88 kW)	1999.08-2000.03	Hatchback Engine 18K4F	•		GWB1374	
	1999.08-2000.03	Hatchback Engine 18K4F		◦	GHA230117	K
2.0 D/SD (63 kW)	1995.11-2000.03	Hatchback Engine 20T2R	•		GWB1374	
	1995.11-2000.03	Hatchback Engine 20T2R		◦	GHA230117	K
	1995.11-2000.03	Hatchback Engine 20T2R		◦	GHA230151	K
2.0 SDi (77 kW)	1995.11-2000.03	Hatchback Engine 20T2N	•		GWB1374	
	1995.11-2000.03	Hatchback Engine 20T2N		◦	GHA230117	K
	1995.11-2000.03	Hatchback Engine 20T2N		◦	GHA230151	K
200 (XW)						
1.4 (55 kW)	1993.09-1995.10	Hatchback Engine 14K2A/14K2D	•		GWB1374	
	1993.09-1995.10	Hatchback Engine 14K2A/14K2D		◦	GHA230117	K
1.4 GSi/Si (70 kW)	1990.01-1995.10	Hatchback Engine 14K4C	•		GWB1374	
	1990.01-1995.10	Hatchback Engine 14K4C		◦	GHA230117	K
1.4 GSi/Si (76 kW)	1992.12-1995.10	Hatchback Engine 14K4F	•		GWB1374	
	1992.12-1995.10	Hatchback Engine 14K4F		◦	GHA230117	K
1.6 (82 kW)	1996.01-1997.12	Coupe Engine 16K4F		◦	GHA230151	K



	 YEAR		F	R	G-AP Ref.	KIT
ROVER						
200 (XW)						
1.6 (90 kW)	1992.10-1999.06	Coupe Engine D16A8	•		GWB1374	
	1992.10-1999.06	Coupe Engine D16A8		◦	GHA230117	K
	1992.10-1999.06	Coupe Engine D16A8		◦	GHA230151	K
1.6 GTi (90 kW)	1990.09-1995.10	Hatchback Engine D16A8	•		GWB1374	
	1990.09-1995.10	Hatchback Engine D16A8		◦	GHA230117	K
1.6 GTi (96 kW)	1990.09-1995.10	Hatchback Engine D16A9	•		GWB1374	
	1990.09-1995.10	Hatchback Engine D16A9		◦	GHA230117	K
1.8 TD (65 kW)	1991.09-1995.10	Hatchback Engine XUD7TE	•		GWB1374	
	1991.09-1995.10	Hatchback Engine XUD7TE		◦	GHA230117	K
1.9 D (52 kW)	1991.09-1995.10	Hatchback	•		GWB1374	
	1991.09-1995.10	Hatchback		◦	GHA230117	K
2.0 GSi (100 kW)	1994.05-1999.06	Coupe Engine 20T4H	•		GWB1374	
	1994.05-1999.06	Coupe Engine 20T4H		◦	GHA230117	K
	1994.05-1999.06	Coupe Engine 20T4H		◦	GHA230151	K
2.0 GTi (100 kW)	1993.01-1995.10	Hatchback Engine 20T4H	•		GWB1374	
	1993.01-1995.10	Hatchback Engine 20T4H		◦	GHA230117	K
2.0 GTi (103 kW)	1991.09-1995.10	Hatchback Engine 20M4F	•		GWB1374	
	1991.09-1995.10	Hatchback Engine 20M4F		◦	GHA230117	K
2.0 Turbo (147 kW)	1992.10-1999.06	Coupe Engine 20T4G	•		GWB1374	
	1992.10-1999.06	Coupe Engine 20T4G		◦	GHA230117	K
	1992.10-1999.06	Coupe Engine 20T4G		◦	GHA230151	K
	1993.01-1995.10	Hatchback Engine 20T4G	•		GWB1374	
	1993.01-1995.10	Hatchback Engine 20T4G		◦	GHA230117	K
25 (RF)						
1.1 (44 kW)	1999.11-2005.05	Hatchback	•		GWB1374	
	1999.11-2005.05	Hatchback		◦	GHA230117	K
1.1 (55 kW)	1999.09-2001.06	Hatchback Engine 11K4F	•		GWB1374	
	1999.09-2001.06	Hatchback Engine 11K4F		◦	GHA230117	K
1.1 16V (55 kW)	2004.01-2005.05	Hatchback Engine 11K4F	•		GWB1374	
	2004.01-2005.05	Hatchback Engine 11K4F		◦	GHA230117	K
1.4 16V (62 kW)	1999.10-2005.05	Hatchback Engine 14K4M	•		GWB1374	
	1999.10-2005.05	Hatchback Engine 14K4M		◦	GHA230117	K
1.4 16V (76 kW)	1999.10-2005.05	Hatchback Engine 14K4F	•		GWB1374	
	1999.10-2005.05	Hatchback Engine 14K4F		◦	GHA230117	K
1.6 16V (80 kW)	1999.10-2005.05	Hatchback Engine 16K4F	•		GWB1374	
	1999.10-2005.05	Hatchback Engine 16K4F		◦	GHA230117	K
1.8 16V (107 kW)	2000.02-2005.05	Hatchback Engine 18K4K	•		GWB1374	
	2000.02-2005.05	Hatchback Engine 18K4K		◦	GHA230117	K
	2000.02-2005.05	Hatchback Engine 18K4K		◦	GHA230151	K
1.8 16V (85 kW)	1999.10-2005.05	Hatchback Engine 18K4F	•		GWB1374	
	1999.10-2005.05	Hatchback Engine 18K4F		◦	GHA230117	K
	1999.10-2005.05	Hatchback Engine 18K4F		◦	GHA230151	K
2.0 iDT (74 kW)	1999.10-2005.05	Hatchback Engine 20T2N	•		GWB1374	
	1999.10-2005.05	Hatchback Engine 20T2N		◦	GHA230117	K
2.0 iDT (83 kW)	2002.01-2004.12	Hatchback Engine 20T2N	•		GWB1374	
	2002.01-2004.12	Hatchback Engine 20T2N		◦	GHA230117	K
	2002.01-2004.12	Hatchback Engine 20T2N		◦	GHA230151	K
400 (RT)						
1.4 (55 kW)	1996.03-1999.12	Saloon Engine 14K2F		◦	GHA230117	K
1.4 Si (76 kW)	1995.05-2000.03	Hatchback Engine 14K4F		◦	GHA230117	K
	1995.05-2000.03	Hatchback Engine 14K4F		◦	GHA230151	K
	1995.05-2000.03	Saloon Engine 14K4F		◦	GHA230117	K
	1995.05-2000.03	Saloon Engine 14K4F		◦	GHA230151	K
1.6 Si (82 kW)	1995.05-2000.03	Hatchback Engine 16K4F		◦	GHA230117	K
	1995.05-2000.03	Hatchback Engine 16K4F		◦	GHA230151	K
	1995.05-2000.03	Saloon Engine 16K4F		◦	GHA230117	K
	1995.05-2000.03	Saloon Engine 16K4F		◦	GHA230151	K
1.6 Si (83 kW)	1995.05-2000.03	Saloon Engine D16Y2		◦	GHA230117	K
	1995.05-2000.03	Saloon Engine D16Y2		◦	GHA230151	K
	1995.06-2000.03	Hatchback Engine D16Y2		◦	GHA230117	K
	1995.06-2000.03	Hatchback Engine D16Y2		◦	GHA230151	K
2.0 D (63 kW)	1995.11-2000.03	Hatchback Engine 20T2R		◦	GHA230117	K
	1995.11-2000.03	Hatchback Engine 20T2R		◦	GHA230151	K
	1995.11-2000.03	Saloon Engine 20T2R		◦	GHA230117	K



	 YEAR		F	R	G-AP Ref.	KIT
ROVER						
400 (RT)						
2.0 Di (77 kW)	1995.05-2000.03	Hatchback Engine 20T2N		o	GHA230117	K
	1995.05-2000.03	Hatchback Engine 20T2N		o	GHA230151	K
	1995.05-2000.03	Saloon Engine 20T2N		o	GHA230117	K
	1995.05-2000.03	Saloon Engine 20T2N		o	GHA230151	K
2.0 Si Lux (100 kW)	1995.12-2000.03	Hatchback Engine 20T4H		o	GHA230117	K
	1995.12-2000.03	Hatchback Engine 20T4H		o	GHA230151	K
	1995.12-2000.03	Saloon Engine 20T4H		o	GHA230117	K
	1995.12-2000.03	Saloon Engine 20T4H		o	GHA230151	K
400 (XW)						
1.4 (70 kW)	1993.01-1995.04	Saloon Engine 14K4C	•		GWB1374	
	1993.01-1995.04	Saloon Engine 14K4C		o	GHA230117	K
1.4 GSi/SI (66 kW)	1990.04-1995.04	Saloon Engine 14K4C/14K4D	•		GWB1374	
	1990.04-1995.04	Saloon Engine 14K4C/14K4D		o	GHA230117	K
1.4 GSi/SI CAT (76 kW)	1993.01-1995.04	Saloon Engine 14K4F	•		GWB1374	
	1993.01-1995.04	Saloon Engine 14K4F		o	GHA230117	K
1.6 GSi (82 kW)	1990.04-1995.04	Saloon Engine D16Z2	•		GWB1374	
	1990.04-1995.04	Saloon Engine D16Z2		o	GHA230117	K
1.6 GSi/GSE (85 kW)	1990.04-1995.04	Saloon Engine D16A7	•		GWB1374	
	1990.04-1995.04	Saloon Engine D16A7		o	GHA230117	K
1.6 GTi (90 kW)	1990.04-1995.04	Saloon Engine D16A8	•		GWB1374	
	1990.04-1995.04	Saloon Engine D16A8		o	GHA230117	K
1.6 GTi/GTE (96 kW)	1990.04-1995.04	Saloon Engine D16A9	•		GWB1374	
	1990.04-1995.04	Saloon Engine D16A9		o	GHA230117	K
1.8 TD (65 kW)	1991.09-1995.04	Saloon Engine XUD7TE	•		GWB1374	
	1991.09-1995.04	Saloon Engine XUD7TE		o	GHA230117	K
1.9 D (49 kW)	1991.09-1995.04	Saloon	•		GWB1374	
	1991.09-1995.04	Saloon		o	GHA230117	K
2.0 GSi/SLI/GTi/Vite (100 kW)	1993.01-1995.04	Saloon Engine 20T4H	•		GWB1374	
	1993.01-1995.04	Saloon Engine 20T4H		o	GHA230117	K
2.0 GTi/GSi/Vitesse (103 kW)	1992.02-1995.04	Saloon Engine 20M4F	•		GWB1374	
	1992.02-1995.04	Saloon Engine 20M4F		o	GHA230117	K
2.0 Turbo (147 kW)	1993.01-1995.04	Saloon Engine 20T4G	•		GWB1374	
	1993.01-1995.04	Saloon Engine 20T4G		o	GHA230117	K
400 TOURER (XW)						
1.6 i (82 kW)	1994.05-1998.11	Estate Engine D16Z2	•		GWB1374	
	1994.05-1998.11	Estate Engine D16Z2		o	GHA230117	K
1.6 i (90 kW)	1994.05-1998.11	Estate Engine D16A8	•		GWB1374	
	1994.05-1998.11	Estate Engine D16A8		o	GHA230117	K
1.8 i (107 kW)	1996.06-1998.11	Estate Engine 18K4K	•		GWB1374	
	1996.06-1998.11	Estate Engine 18K4K		o	GHA230117	K
	1996.06-1998.11	Estate Engine 18K4K		o	GHA230151	K
1.8 TD (65 kW)	1993.09-1998.11	Estate Engine XUD7TE	•		GWB1374	
	1993.09-1998.11	Estate Engine XUD7TE		o	GHA230117	K
2.0 i (100 kW)	1994.05-1998.11	Estate Engine 20T4H	•		GWB1374	
	1994.05-1998.11	Estate Engine 20T4H		o	GHA230117	K
45 (RT)						
1.4 (76 kW)	2000.02-2005.05	Hatchback Engine 14K4F		o	GHA230117	K
	2000.02-2005.05	Hatchback Engine 14K4F		o	GHA230151	K
	2000.02-2005.05	Saloon Engine 14K4F		o	GHA230117	K
	2000.02-2005.05	Saloon Engine 14K4F		o	GHA230151	K
1.6 (80 kW)	2000.02-2005.05	Hatchback Engine 16K4F		o	GHA230117	K
	2000.02-2005.05	Hatchback Engine 16K4F		o	GHA230151	K
	2000.02-2005.05	Saloon Engine 16K4F		o	GHA230117	K
	2000.02-2005.05	Saloon Engine 16K4F		o	GHA230151	K
1.8 (86 kW)	2000.02-2005.05	Hatchback Engine 18K4F		o	GHA230117	K
	2000.02-2005.05	Hatchback Engine 18K4F		o	GHA230151	K
	2000.02-2005.05	Saloon Engine 18K4F		o	GHA230117	K
	2000.02-2005.05	Saloon Engine 18K4F		o	GHA230151	K
2.0 iDT (74 kW)	2000.02-2005.05	Hatchback Engine 20T2N		o	GHA230117	K
	2000.02-2005.05	Hatchback Engine 20T2N		o	GHA230151	K
	2000.02-2005.05	Saloon Engine 20T2N		o	GHA230117	K
	2000.02-2005.05	Saloon Engine 20T2N		o	GHA230151	K
2.0 iDT (83 kW)	2004.01-2005.05	Hatchback Engine 20 T2N		o	GHA230151	K
	2004.01-2005.05	Saloon Engine 20 T2N		o	GHA230151	K



	 YEAR		F	R	G-AP Ref.	KIT
ROVER						
45 (RT)						
2.0 V6 (110 kW)	2000.02-2005.05	Hatchback Engine 20K4F		o	GHA230117	K
	2000.02-2005.05	Hatchback Engine 20K4F		o	GHA230151	K
	2000.02-2005.05	Saloon Engine 20K4F		o	GHA230117	K
	2000.02-2005.05	Saloon Engine 20K4F		o	GHA230151	K
600 (RH)						
1.8 i/Si (85 kW)	1996.03-1999.02	Saloon Engine F18A3	•		GHA243001	K
	1996.03-1999.02	Saloon Engine F18A3		o	GHA230029	K
	1996.03-1999.02	Saloon Engine F18A3 Without ABS		o	GHA230003	K
2.0 i (85 kW)	1993.08-1996.06	Saloon Engine F20Z2	•		GHA243001	K
	1993.08-1996.06	Saloon Engine F20Z2		o	GHA230029	K
	1993.08-1996.06	Saloon Engine F20Z2 Without ABS		o	GHA230003	K
2.0 SDi (77 kW)	1994.12-1999.02	Saloon Engine 20T2N	•		GHA243001	K
	1994.12-1999.02	Saloon Engine 20T2N Without ABS		o	GHA230003	K
2.0 Si (96 kW)	1993.08-1999.02	Saloon Engine F20Z1	•		GHA243001	K
	1993.08-1999.02	Saloon Engine F20Z1		o	GHA230029	K
	1993.08-1999.02	Saloon Engine F20Z1 Without ABS		o	GHA230003	K
2.0 Ti Vitesse (147 kW)	1994.07-1999.02	Saloon Engine 20T4G	•		GHA243001	K
	1994.07-1999.02	Saloon Engine 20T4G Without ABS		o	GHA230003	K
2.3 Si (116 kW)	1993.08-1999.02	Saloon Engine H23A3	•		GHA243001	K
	1993.08-1999.02	Saloon Engine H23A3		o	GHA230029	K
	1993.08-1999.02	Saloon Engine H23A3 Without ABS		o	GHA230003	K
75 (RJ)						
1.8 (88 kW)	1999.02-2005.05	Saloon Engine K1.8	•		GWB3603	
	1999.02-2005.05	Saloon Engine K1.8		o	GHA232023	
1.8 Turbo (110 kW)	2003.05-2005.05	Saloon Engine 18K4G	•		GWB3603	
	2003.05-2005.05	Saloon Engine 18K4G		o	GHA232023	
2.0 CDT (85 kW)	1999.02-2005.05	Saloon Engine M47R	•		GWB3603	
	1999.02-2005.05	Saloon Engine M47R		o	GHA232023	
2.0 CDTi (96 kW)	2003.02-2005.05	Saloon Engine 204D2	•		GWB3603	
	2003.02-2005.05	Saloon Engine 204D2		o	GHA232023	
2.0 V6 (110 kW)	1999.02-2005.05	Saloon Engine 20K4F	•		GWB3603	
	1999.02-2005.05	Saloon Engine 20K4F		o	GHA232023	
2.5 V6 (129 kW)	1999.02-2001.10	Saloon Engine KV6	•		GWB3603	
	1999.02-2001.10	Saloon Engine KV6		o	GHA232023	
2.5 V6 (130 kW)	2001.10-2005.05	Saloon Engine 25K4F	•		GWB3603	
	2001.10-2005.05	Saloon Engine 25K4F		o	GHA232023	
75 TOURER (RJ)						
1.8 (88 kW)	2001.08-2005.05	Estate Engine K1.8	•		GWB3603	
	2001.08-2005.05	Estate Engine K1.8		o	GHA232023	
1.8 Turbo (110 kW)	2003.05-2005.05	Estate Engine 18K4G	•		GWB3603	
	2003.05-2005.05	Estate Engine 18K4G		o	GHA232023	
2.0 CDT (85 kW)	2001.08-2005.05	Estate Engine M47R	•		GWB3603	
	2001.08-2005.05	Estate Engine M47R		o	GHA232023	
2.0 CDTi (96 kW)	2003.02-2005.05	Estate Engine 204D2	•		GWB3603	
	2003.02-2005.05	Estate Engine 204D2		o	GHA232023	
2.0 V6 (110 kW)	2001.08-2005.05	Estate Engine 20K4F	•		GWB3603	
	2001.08-2005.05	Estate Engine 20K4F		o	GHA232023	
2.5 V6 (130 kW)	2001.08-2005.05	Estate Engine KV6	•		GWB3603	
	2001.08-2005.05	Estate Engine KV6		o	GHA232023	
CABRIOLET (XW)						
1.4 (66 kW)	1992.01-1999.11	Convertible Engine 14K4C/14K4D	•		GWB1374	
	1992.01-1999.11	Convertible Engine 14K4C/14K4D		o	GHA230117	K
	1992.01-1999.11	Convertible Engine 14K4C/14K4D		o	GHA230151	K
1.4 (70 kW)	1990.04-1992.09	Convertible Engine 14K4C	•		GWB1374	
	1990.04-1992.09	Convertible Engine 14K4C		o	GHA230117	K
	1990.04-1992.09	Convertible Engine 14K4C		o	GHA230151	K
1.4 i 16V (76 kW)	1993.01-1999.11	Convertible Engine 14K4F	•		GWB1374	
	1993.01-1999.11	Convertible Engine 14K4F		o	GHA230117	K
	1993.01-1999.11	Convertible Engine 14K4F		o	GHA230151	K
1.6 i (90 kW)	1992.01-1999.11	Convertible Engine D16A8	•		GWB1374	
	1992.01-1999.11	Convertible Engine D16A8		o	GHA230117	K
	1992.01-1999.11	Convertible Engine D16A8		o	GHA230151	K
1.6 i 16V (82 kW)	1996.01-1999.11	Convertible Engine 16K4F	•		GWB1374	
	1996.01-1999.11	Convertible Engine 16K4F		o	GHA230117	K



	 YEAR		F	R	G-AP Ref.	KIT
ROVER						
CABRIOLET (XW)						
1.6 i 16V (82 kW)	1996.01-1999.11	Convertible Engine 16K4F		o	GHA230151	K
CITYROVER						
COUPE						
1.6 16V (82 kW)	1996.03-1999.11	Coupe Engine 16K4F	•		GWB1374	
	1996.03-1999.11	Coupe Engine 16K4F		o	GHA230117	K
	1996.03-1999.11	Coupe Engine 16K4F		o	GHA230151	K
1.8 16V (107 kW)	1996.03-1999.11	Coupe Engine 18K4K	•		GWB1374	
	1996.03-1999.11	Coupe Engine 18K4K		o	GHA230117	K
	1996.03-1999.11	Coupe Engine 18K4K		o	GHA230151	K
MINI						
1.0 (30 kW)	1992.01-1993.06	Hatchback Engine 99HD81	•		GWB0749	
1.3 (37 kW)	1992.04-1996.10	Hatchback Engine 12A2L	•		GWB0749	
	1992.10-2000.11	Hatchback Engine 12A2B	•		GWB0749	
1.3 (39 kW)	1992.01-1995.04	Hatchback Engine 12A2D	•		GWB0749	
	1996.05-1996.10	Hatchback Engine 12A2L	•		GWB0749	
1.3 (45 kW)	1991.01-1991.12	Hatchback Engine 12A2A	•		GWB0749	
1.3 (46 kW)	1992.01-2000.11	Hatchback Engine 12A2E/12A2L	•		GWB0749	
1.3 Cooper (45 kW)	1991.06-1994.02	Hatchback Engine 12A2A	•		GWB0749	
MINI (XN)						
1.3 (46 kW)	1992.09-1995.04	Convertible Engine 12A2E	•		GWB0749	
STREETWISE						
1.4 (62 kW)	2003.08-2005.05	Hatchback Engine 14 K4M		o	GHA230151	K
1.4 (76 kW)	2003.08-2005.05	Hatchback Engine 14 K4F		o	GHA230151	K
1.6 (80 kW)	2004.01-2005.05	Hatchback Engine 16 K4F		o	GHA230151	K
1.8 (86 kW)	2003.08-2005.05	Hatchback Engine 18K4F		o	GHA230151	K
2.0 TD (74 kW)	2003.08-2005.05	Hatchback Engine 20 T2N		o	GHA230151	K
SAAB						
900						
2.0 (107 kW)	1991.05-1993.10	Convertible Engine B202S	•		GWB3412	
	1991.05-1993.10	Convertible Engine B202S	•		GWB3543	
	1991.05-1993.10	Convertible Engine B202S		o	GHA230005	K
	1991.05-1993.10	Hatchback Engine B202S	•		GWB3412	
	1991.05-1993.10	Hatchback Engine B202S	•		GWB3543	
	1991.05-1993.10	Hatchback Engine B202S		o	GHA230005	K
	1991.05-1993.10	Hatchback Engine B202S With ABS		o	GHA400052	K
2.0 (93 kW)	1990.01-1994.06	Convertible Engine B202I	•		GWB3412	
	1990.01-1994.06	Convertible Engine B202I	•		GWB3543	
	1990.01-1994.06	Convertible Engine B202I		o	GHA230005	K
2.0 16v (98 kW)	1990.04-1990.12	Convertible Engine B202I		o	GHA230005	K
2.0 S Turbo-16 (104 kW)	1991.09-1993.07	Hatchback Engine B202S		o	GHA230005	K
	1991.09-1994.06	Convertible Engine B202S	•		GWB3412	
	1991.09-1994.06	Convertible Engine B202S	•		GWB3543	
	1991.09-1994.06	Convertible Engine B202S		o	GHA230005	K
2.0 Turbo-16 (132 kW)	1993.01-1994.06	Hatchback Engine B202L	•		GWB3412	
	1993.01-1994.06	Hatchback Engine B202L	•		GWB3543	
	1993.01-1994.06	Hatchback Engine B202L		o	GHA230005	K
	1993.01-1994.06	Hatchback Engine B202L With ABS		o	GHA400052	K
2.1 -16 (100 kW)	1990.08-1994.06	Convertible Engine B212I	•		GWB3412	
	1990.08-1994.06	Convertible Engine B212I	•		GWB3543	
	1990.08-1994.06	Convertible Engine B212I		o	GHA230005	K
	1990.09-1993.07	Hatchback Engine B212I		o	GHA230005	K
900 (AC4, AM4)						
2.0 S Turbo-16 (104 kW)	1991.07-1993.12	Saloon Engine B202S	•		GWB3412	
	1991.07-1993.12	Saloon Engine B202S	•		GWB3543	
	1991.07-1993.12	Saloon Engine B202S		o	GHA230005	K
	1991.07-1993.12	Saloon Engine B202S With ABS		o	GHA400052	K
2.0 S Turbo-16 (107 kW)	1992.01-1993.12	Saloon Engine B202S	•		GWB3412	
	1992.01-1993.12	Saloon Engine B202S	•		GWB3543	
	1992.01-1993.12	Saloon Engine B202S		o	GHA230005	K
	1992.01-1993.12	Saloon Engine B202S With ABS		o	GHA400052	K
2.1 -16 (100 kW)	1990.08-1993.12	Saloon Engine B212I	•		GWB3412	
	1990.08-1993.12	Saloon Engine B212I	•		GWB3543	
	1990.08-1993.12	Saloon Engine B212I		o	GHA230005	K



	 YEAR		F	R	G-AP Ref.	KIT
SAAB						
900 (AC4, AM4)						
2.1 -16 (100 kW)	1990.08-1993.12	Saloon Engine B212I With ABS		o	GHA400052	K
900 II						
2.0 i (96 kW)	1993.12-1998.02	Convertible Engine B204I	•		GHA433004	
	1993.12-1998.02	Convertible Engine B204I	•		GWB3412	
	1993.12-1998.02	Convertible Engine B204I	•		GWB3543	
	1993.12-1998.02	Convertible Engine B204I With ABS		o	GHA400052	K
	1994.08-1998.02	Coupe Engine B204I	•		GWB3412	
	1994.08-1998.02	Coupe Engine B204I	•		GWB3543	
	1994.08-1998.02	Coupe Engine B204I With ABS		o	GHA400052	K
	1994.08-1998.02	Hatchback Engine B204I	•		GHA433004	
	1994.08-1998.02	Hatchback Engine B204I	•		GWB3412	
	1994.08-1998.02	Hatchback Engine B204I	•		GWB3543	
	1994.08-1998.02	Hatchback Engine B204I With ABS		o	GHA400052	K
2.0 i (98 kW)	1993.07-1994.07	Hatchback Engine B206I	•		GHA433004	
	1993.07-1994.07	Hatchback Engine B206I	•		GWB3412	
	1993.07-1994.07	Hatchback Engine B206I	•		GWB3543	
	1993.07-1994.07	Hatchback Engine B206I		o	GHA230005	K
	1993.07-1994.07	Hatchback Engine B206I With ABS		o	GHA400052	K
	1993.12-1994.07	Coupe Engine B206I	•		GWB3412	
	1993.12-1994.07	Coupe Engine B206I	•		GWB3543	
	1993.12-1994.07	Coupe Engine B206I With ABS		o	GHA400052	K
2.0 Turbo (136 kW)	1993.07-1998.02	Hatchback Engine B204L	•		GHA433004	
	1993.07-1998.02	Hatchback Engine B204L	•		GWB3412	
	1993.07-1998.02	Hatchback Engine B204L	•		GWB3543	
	1993.07-1998.02	Hatchback Engine B204L		o	GHA230005	K
	1993.07-1998.02	Hatchback Engine B204L With ABS		o	GHA400052	K
	1993.12-1998.02	Convertible Engine B204L	•		GHA433004	
	1993.12-1998.02	Convertible Engine B204L	•		GWB3412	
	1993.12-1998.02	Convertible Engine B204L	•		GWB3543	
	1993.12-1998.02	Convertible Engine B204L With ABS		o	GHA400052	K
	1993.12-1998.02	Coupe Engine B204L	•		GWB3412	
	1993.12-1998.02	Coupe Engine B204L	•		GWB3543	
	1993.12-1998.02	Coupe Engine B204L With ABS		o	GHA400052	K
2.3 -16 (110 kW)	1993.07-1998.02	Hatchback Engine B234I	•		GHA433004	
	1993.07-1998.02	Hatchback Engine B234I	•		GWB3412	
	1993.07-1998.02	Hatchback Engine B234I	•		GWB3543	
	1993.07-1998.02	Hatchback Engine B234I		o	GHA230005	K
	1993.07-1998.02	Hatchback Engine B234I With ABS		o	GHA400052	K
	1993.12-1998.02	Convertible Engine B234I	•		GHA433004	
	1993.12-1998.02	Convertible Engine B234I	•		GWB3412	
	1993.12-1998.02	Convertible Engine B234I	•		GWB3543	
	1993.12-1998.02	Convertible Engine B234I With ABS		o	GHA400052	K
	1993.12-1998.02	Coupe Engine B234I	•		GWB3412	
	1993.12-1998.02	Coupe Engine B234I	•		GWB3543	
	1993.12-1998.02	Coupe Engine B234I With ABS		o	GHA400052	K
2.5 -24 V6 (125 kW)	1993.07-1998.02	Hatchback Engine B258I	•		GHA433004	
	1993.07-1998.02	Hatchback Engine B258I	•		GWB3412	
	1993.07-1998.02	Hatchback Engine B258I	•		GWB3543	
	1993.07-1998.02	Hatchback Engine B258I		o	GHA230005	K
	1993.07-1998.02	Hatchback Engine B258I With ABS		o	GHA400052	K
	1993.12-1998.02	Convertible Engine B258I	•		GHA433004	
	1993.12-1998.02	Convertible Engine B258I	•		GWB3412	
	1993.12-1998.02	Convertible Engine B258I	•		GWB3543	
	1993.12-1998.02	Convertible Engine B258I With ABS		o	GHA400052	K
	1993.12-1998.02	Coupe Engine B258I	•		GWB3412	
	1993.12-1998.02	Coupe Engine B258I	•		GWB3543	
	1993.12-1998.02	Coupe Engine B258I With ABS		o	GHA400052	K
9000						
2.0 CD (110 kW)	1993.09-1998.12	Saloon Engine B204E/B204S	•		GHA326011	K
	1993.09-1998.12	Saloon Engine B204E/B204S		o	GHA230005	K
2.0 CD (96 kW)	1993.09-1998.12	Saloon Engine B204I	•		GHA326011	K
	1993.09-1998.12	Saloon Engine B204I		o	GHA230005	K
2.0 CS (96 kW)	1993.09-1998.12	Hatchback Engine B204I	•		GHA326011	K
	1993.09-1998.12	Hatchback Engine B204I		o	GHA230005	K



	 YEAR		F	R	G-AP Ref.	KIT
SAAB						
9000						
2.0 ND Turbo (110 kW)	1993.09-1998.12	Hatchback Engine B202S/B204E/B204S	•		GHA326011	K
	1993.09-1998.12	Hatchback Engine B202S/B204E/B204S		◦	GHA230005	K
2.0 Turbo CD (108 kW)	1992.09-1998.12	Saloon Engine B202S/B204E	•		GHA326011	K
	1992.09-1998.12	Saloon Engine B202S/B204E		◦	GHA230005	K
2.3 (110 kW)	1990.01-1993.12	Hatchback Engine B234I	•		GHA326011	K
	1990.01-1993.12	Hatchback Engine B234I		◦	GHA230005	K
2.3 (165 kW)	1990.09-1998.10	Saloon Engine B234R	•		GHA326011	K
	1990.09-1998.10	Saloon Engine B234R		◦	GHA230005	K
2.3 -16 Aero CS (162 kW)	1993.02-1998.12	Hatchback Engine B234R	•		GHA326011	K
	1993.02-1998.12	Hatchback Engine B234R		◦	GHA230005	K
2.3 -16 Aero CS (165 kW)	1993.02-1998.12	Hatchback Engine B234R	•		GHA326011	K
	1993.02-1998.12	Hatchback Engine B234R		◦	GHA230005	K
2.3 -16 CD Turbo (147 kW)	1990.07-1998.12	Saloon Engine B234L	•		GHA326011	K
	1990.07-1998.12	Saloon Engine B234L		◦	GHA230005	K
2.3 -16 CDE (108 kW)	1993.09-1998.12	Saloon Engine B234I	•		GHA326011	K
	1993.09-1998.12	Saloon Engine B234I		◦	GHA230005	K
2.3 -16 CDE Eco-Power (125 kW)	1993.09-1998.12	Saloon Engine B234E	•		GHA326011	K
	1993.09-1998.12	Saloon Engine B234E		◦	GHA230005	K
2.3 -16 CSE (108 kW)	1993.09-1998.12	Hatchback Engine B234I	•		GHA326011	K
	1993.09-1998.12	Hatchback Engine B234I		◦	GHA230005	K
2.3 -16 CSE Eco Power (125 kW)	1993.09-1998.12	Hatchback Engine B234E	•		GHA326011	K
	1993.09-1998.12	Hatchback Engine B234E		◦	GHA230005	K
2.3 -16 Turbo (143 kW)	1990.09-1993.08	Saloon Engine B234L	•		GHA326011	K
	1990.09-1993.08	Saloon Engine B234L		◦	GHA230005	K
	1990.09-1998.12	Hatchback Engine B234L	•		GHA326011	K
	1990.09-1998.12	Hatchback Engine B234L		◦	GHA230005	K
2.3 -16 Turbo CSE (147 kW)	1993.09-1998.12	Hatchback Engine B234L	•		GHA326011	K
	1993.09-1998.12	Hatchback Engine B234L		◦	GHA230005	K
3.0 -24 V6 CD/CDE (155 kW)	1994.07-1998.12	Saloon Engine B308I	•		GHA326011	K
	1994.07-1998.12	Saloon Engine B308I		◦	GHA230005	K
3.0 -24 V6 CS/CSE (155 kW)	1994.07-1998.12	Hatchback Engine B308I	•		GHA326011	K
	1994.07-1998.12	Hatchback Engine B308I		◦	GHA230005	K
9-3						
1.8 i (90 kW)	2005.04-2008.01	Estate Engine Z18XE	•		GHA330011	K
	2005.04-2008.01	Estate Engine Z18XE		◦	GHA400137	K
1.8 T (110 kW)	2005.03-	Estate Engine B207E	•		GHA330011	K
	2005.03-	Estate Engine B207E		◦	GHA400137	K
1.9 TiD (110 kW)	2005.04-2008.01	Estate Engine Z19DTH	•		GHA330011	K
	2005.04-2008.01	Estate Engine Z19DTH		◦	GHA400137	K
1.9 TiD (88 kW)	2005.04-2008.01	Estate Engine Z19DTJ	•		GHA330011	K
	2005.04-2008.01	Estate Engine Z19DTJ		◦	GHA400137	K
1.9 TTiD (118 kW)	2007.12-	Estate Engine A19DTR	•		GHA330011	K
	2007.12-	Estate Engine A19DTR		◦	GHA400137	K
1.9 TTiD (132 kW)	2007.06-	Estate Engine Z19DTR	•		GHA330011	K
	2007.06-	Estate Engine Z19DTR		◦	GHA400137	K
1.9 TTiD (96 kW)	2007.12-	Estate Engine A19DTR	•		GHA330011	K
	2007.12-	Estate Engine A19DTR		◦	GHA400137	K
2.0 T (110 kW)	2005.04-2008.01	Estate Engine B207E	•		GHA330011	K
	2005.04-2008.01	Estate Engine B207E		◦	GHA400137	K
2.0 T (120 kW)	2007.01-	Estate Engine B207G	•		GHA330011	K
	2007.01-	Estate Engine B207G		◦	GHA400137	K
2.0 T (129 kW)	2005.04-2008.01	Estate Engine B207L	•		GHA330011	K
	2005.04-2008.01	Estate Engine B207L		◦	GHA400137	K
2.0 T (147 kW)	2009.02-	Estate Engine B207M	•		GHA330011	K
	2009.02-	Estate Engine B207M		◦	GHA400137	K
2.0 T (154 kW)	2005.04-2008.01	Estate Engine B207R	•		GHA330011	K
	2005.04-2008.01	Estate Engine B207R		◦	GHA400137	K
2.0 T (162 kW)	2011.01-	Estate Engine A20NFT	•		GHA330011	K
	2011.01-	Estate Engine A20NFT		◦	GHA400137	K
2.0 T (177 kW)	2009.05-	Estate	•		GHA330011	K
	2009.05-	Estate		◦	GHA400137	K
2.0 T Bio Power (147 kW)	2009.02-	Estate Engine B207M	•		GHA330011	K
	2009.02-	Estate Engine B207M		◦	GHA400137	K
2.0 T Bio Power XWD (154 kW)	2008.06-	Estate Engine B207R	•		GHA330011	K



	 YEAR		F	R	G-AP Ref.	KIT
SAAB						
9-3						
2.0 T BioPower (120 kW)	2011.01-	Estate Engine B207H	•		GHA330011	K
	2011.01-	Estate Engine B207H		◦	GHA400137	K
2.0 T BioPower (129 kW)	2007.01-	Estate Engine B207L	•		GHA330011	K
	2007.01-	Estate Engine B207L		◦	GHA400137	K
2.0 T BioPower (145 kW)	2007.06-	Estate	•		GHA330011	K
	2007.06-	Estate		◦	GHA400137	K
2.0 T BioPower (162 kW)	2011.01-	Estate Engine A20NFT	•		GHA330011	K
	2011.01-	Estate Engine A20NFT		◦	GHA400137	K
2.0 T BioPower XWD (120 kW)	2011.01-	Estate Engine B207H	•		GHA330011	K
2.0 T BioPower XWD (162 kW)	2011.01-	Estate Engine A20NFT	•		GHA330011	K
2.0 T XWD (120 kW)	2007.01-	Estate Engine B207G	•		GHA330011	K
2.0 T XWD (154 kW)	2008.06-	Estate Engine B207R	•		GHA330011	K
2.0 T XWD (162 kW)	2011.01-	Estate Engine A20NFT	•		GHA330011	K
2.8 Turbo V6 (169 kW)	2005.03-	Estate Engine LP9	•		GHA330011	K
	2005.03-	Estate Engine LP9		◦	GHA400137	K
2.8 Turbo V6 (184 kW)	2005.04-2008.01	Estate Engine LP9	•		GHA330011	K
	2005.04-2008.01	Estate Engine LP9		◦	GHA400137	K
2.8 Turbo V6 (188 kW)	2007.12-	Estate Engine B284L	•		GHA330011	K
	2007.12-	Estate Engine B284L		◦	GHA400137	K
2.8 Turbo V6 (203 kW)	2008.05-	Estate Engine B284R	•		GHA330011	K
	2008.05-	Estate Engine B284R		◦	GHA400137	K
2.8 Turbo V6 XWD (206 kW)	2008.05-	Estate Engine B284R	•		GHA330011	K
9-3 (YS3D)						
2.0 i (96 kW)	1998.02-2002.09	Hatchback Engine B204I	•		GHA433004	
	1998.02-2002.09	Hatchback Engine B204I	•		GWB3412	
	1998.02-2002.09	Hatchback Engine B204I	•		GWB3543	
	1998.02-2002.09	Hatchback Engine B204I With ABS		◦	GHA400052	K
2.0 SE Turbo (147 kW)	1998.02-2002.09	Hatchback Engine B204R	•		GHA433004	
	1998.02-2002.09	Hatchback Engine B204R	•		GWB3412	
	1998.02-2002.09	Hatchback Engine B204R	•		GWB3543	
	1998.02-2002.09	Hatchback Engine B204R With ABS		◦	GHA400052	K
2.0 Turbo (110 kW)	2001.01-2002.09	Hatchback Engine B205E	•		GHA433004	
	2001.01-2002.09	Hatchback Engine B205E	•		GWB3412	
	2001.01-2002.09	Hatchback Engine B205E	•		GWB3543	
	2001.01-2002.09	Hatchback Engine B205E With ABS		◦	GHA400052	K
2.0 Turbo (113 kW)	1998.10-2002.09	Hatchback Engine B204E	•		GHA433004	
	1998.10-2002.09	Hatchback Engine B204E	•		GWB3412	
	1998.10-2002.09	Hatchback Engine B204E	•		GWB3543	
	1998.10-2002.09	Hatchback Engine B204E With ABS		◦	GHA400052	K
2.0 Turbo (136 kW)	1998.02-2002.09	Hatchback Engine B204L/B205L	•		GHA433004	
	1998.02-2002.09	Hatchback Engine B204L/B205L	•		GWB3412	
	1998.02-2002.09	Hatchback Engine B204L/B205L	•		GWB3543	
	1998.02-2002.09	Hatchback Engine B204L/B205L With ABS		◦	GHA400052	K
2.0 Turbo (151 kW)	1999.10-2002.09	Hatchback Engine B205R	•		GHA433004	
	1999.10-2002.09	Hatchback Engine B205R	•		GWB3412	
	1999.10-2002.09	Hatchback Engine B205R	•		GWB3543	
	1999.10-2002.09	Hatchback Engine B205R With ABS		◦	GHA400052	K
2.2 TiD (85 kW)	1998.02-2000.11	Hatchback Engine D223L/X22DTH	•		GHA433004	
	1998.02-2000.11	Hatchback Engine D223L/X22DTH	•		GWB3412	
	1998.02-2000.11	Hatchback Engine D223L/X22DTH	•		GWB3543	
	1998.02-2000.11	Hatchback Engine D223L/X22DTH With ABS		◦	GHA400052	K
2.2 TiD (92 kW)	2000.11-2002.09	Hatchback Engine D223L	•		GHA433004	
	2000.11-2002.09	Hatchback Engine D223L	•		GWB3412	
	2000.11-2002.09	Hatchback Engine D223L	•		GWB3543	
	2000.11-2002.09	Hatchback Engine D223L With ABS		◦	GHA400052	K
2.3 (169 kW)	1999.09-2002.01	Hatchback Engine B235R	•		GHA433004	
	1999.09-2002.01	Hatchback Engine B235R	•		GWB3412	
	1999.09-2002.01	Hatchback Engine B235R	•		GWB3543	
	1999.09-2002.01	Hatchback Engine B235R With ABS		◦	GHA400052	K
2.3 i (110 kW)	1998.02-2002.09	Hatchback Engine B234I	•		GHA433004	
	1998.02-2002.09	Hatchback Engine B234I	•		GWB3412	
	1998.02-2002.09	Hatchback Engine B234I	•		GWB3543	
	1998.02-2002.09	Hatchback Engine B234I With ABS		◦	GHA400052	K
2.3 Turbo (165 kW)	1998.10-2002.09	Hatchback Engine B235R	•		GHA433004	



	 YEAR		F	R	G-AP Ref.	KIT
SAAB						
9-3 (YS3D)						
2.3 Turbo (165 kW)	1998.10-2002.09	Hatchback Engine B235R	•		GWB3412	
	1998.10-2002.09	Hatchback Engine B235R	•		GWB3543	
	1998.10-2002.09	Hatchback Engine B235R With ABS		◦	GHA400052	K
9-3 (YS3F)						
1,8 T (110 kW)	2002.09-	Saloon Engine B207E	•		GHA330011	K
	2002.09-	Saloon Engine B207E		◦	GHA400137	K
	2003.08-	Convertible Engine B207E	•		GHA330011	K
	2003.08-	Convertible Engine B207E		◦	GHA400137	K
1,8 T BioPower (129 kW)	2007.01-	Convertible Engine B207L	•		GHA330011	K
	2007.01-	Convertible Engine B207L		◦	GHA400137	K
	2009.05-	Saloon Engine B207L	•		GHA330011	K
	2009.05-	Saloon Engine B207L		◦	GHA400137	K
1,8t BioPower (110 kW)	2007.01-	Convertible Engine B207E	•		GHA330011	K
	2007.01-	Convertible Engine B207E		◦	GHA400137	K
	2007.01-	Saloon Engine B207E	•		GHA330011	K
	2007.01-	Saloon Engine B207E		◦	GHA400137	K
1.8 i (90 kW)	2003.11-2008.01	Saloon Engine Z18XE	•		GHA330011	K
	2003.11-2008.01	Saloon Engine Z18XE		◦	GHA400137	K
	2004.01-	Convertible Engine Z 18 XE	•		GHA330011	K
	2004.01-	Convertible Engine Z 18 XE		◦	GHA400137	K
1.9 TiD (110 kW)	2004.06-2008.01	Saloon Engine Z19DTH	•		GHA330011	K
	2004.06-2008.01	Saloon Engine Z19DTH		◦	GHA400137	K
	2006.01-2008.01	Convertible Engine Z19DTH	•		GHA330011	K
	2006.01-2008.01	Convertible Engine Z19DTH		◦	GHA400137	K
1.9 TiD (88 kW)	2004.06-2008.01	Saloon Engine Z19DT	•		GHA330011	K
	2004.06-2008.01	Saloon Engine Z19DT		◦	GHA400137	K
	2004.09-	Convertible Engine Z 19 DT	•		GHA330011	K
	2004.09-	Convertible Engine Z 19 DT		◦	GHA400137	K
1.9 TTiD (118 kW)	2007.12-	Convertible Engine A19DTR	•		GHA330011	K
	2007.12-	Convertible Engine A19DTR		◦	GHA400137	K
	2007.12-	Saloon Engine A19DTR	•		GHA330011	K
	2007.12-	Saloon Engine A19DTR		◦	GHA400137	K
1.9 TTiD (132 kW)	2007.06-	Convertible Engine A19DTR/Z19DTR	•		GHA330011	K
	2007.06-	Convertible Engine A19DTR/Z19DTR		◦	GHA400137	K
	2007.06-	Saloon Engine A19DTR/Z19DTR	•		GHA330011	K
	2007.06-	Saloon Engine A19DTR/Z19DTR		◦	GHA400137	K
1.9 TTiD (96 kW)	2007.12-	Convertible Engine A19DTR	•		GHA330011	K
	2007.12-	Convertible Engine A19DTR		◦	GHA400137	K
	2007.12-	Saloon Engine A19DTR	•		GHA330011	K
	2007.12-	Saloon Engine A19DTR		◦	GHA400137	K
2.0 T (120 kW)	2007.01-	Saloon Engine B207G	•		GHA330011	K
	2007.01-	Saloon Engine B207G		◦	GHA400137	K
	2011.01-	Convertible Engine B207G	•		GHA330011	K
	2011.01-	Convertible Engine B207G		◦	GHA400137	K
2.0 T (129 kW)	2002.09-	Saloon Engine B207L	•		GHA330011	K
	2002.09-	Saloon Engine B207L		◦	GHA400137	K
	2003.08-	Convertible Engine B207L	•		GHA330011	K
	2003.08-	Convertible Engine B207L		◦	GHA400137	K
2.0 T (154 kW)	2002.09-	Saloon Engine B207R	•		GHA330011	K
	2002.09-	Saloon Engine B207R		◦	GHA400137	K
	2003.08-	Convertible Engine B207R	•		GHA330011	K
	2003.08-	Convertible Engine B207R		◦	GHA400137	K
2.0 T (162 kW)	2011.01-	Convertible Engine A20NFT	•		GHA330011	K
	2011.01-	Convertible Engine A20NFT		◦	GHA400137	K
	2011.01-	Saloon Engine A20NFT	•		GHA330011	K
	2011.01-	Saloon Engine A20NFT		◦	GHA400137	K
2.0 T (177 kW)	2009.05-	Saloon	•		GHA330011	K
	2009.05-	Saloon		◦	GHA400137	K
2.0 T Bio Power (120 kW)	2007.01-	Saloon Engine B207H	•		GHA330011	K
	2007.01-	Saloon Engine B207H		◦	GHA400137	K
2.0 T Bio Power (162 kW)	2011.01-	Saloon Engine A20NFT	•		GHA330011	K
	2011.01-	Saloon Engine A20NFT		◦	GHA400137	K
2.0 t BioPower (110 kW)	2007.01-	Estate Engine B207E	•		GHA330011	K
	2007.01-	Estate Engine B207E		◦	GHA400137	K



	 YEAR		F	R	G-AP Ref.	KIT
SAAB						
9-3 (YS3F)						
2.0 T BioPower (120 kW)	2011.01-	Convertible Engine B207H	•		GHA330011	K
	2011.01-	Convertible Engine B207H		◦	GHA400137	K
2.0 T BioPower (129 kW)	2007.01-	Convertible Engine B207L	•		GHA330011	K
	2007.01-	Convertible Engine B207L		◦	GHA400137	K
	2007.01-	Saloon Engine B207L	•		GHA330011	K
	2007.01-	Saloon Engine B207L		◦	GHA400137	K
2.0 T BioPower (145 kW)	2007.06-	Saloon	•		GHA330011	K
	2007.06-	Saloon		◦	GHA400137	K
2.0 T BioPower (147 kW)	2007.06-	Convertible Engine Engine B207M	•		GHA330011	K
	2007.06-	Convertible Engine Engine B207M		◦	GHA400137	K
	2009.05-	Saloon Engine B207M	•		GHA330011	K
	2009.05-	Saloon Engine B207M		◦	GHA400137	K
2.0 T BioPower (154 kW)	2002.09-	Saloon Engine B207R	•		GHA330011	K
	2002.09-	Saloon Engine B207R		◦	GHA400137	K
2.0 T BioPower (162 kW)	2011.01-	Convertible Engine A20NFT	•		GHA330011	K
	2011.01-	Convertible Engine A20NFT		◦	GHA400137	K
2.0 T BioPower XWD (120 kW)	2008.01-	Saloon Engine B207H	•		GHA330011	K
2.0 T BioPower XWD (154 kW)	2008.01-	Saloon Engine B207R	•		GHA330011	K
2.0 T BioPower XWD (162 kW)	2008.01-	Saloon Engine A20NFT	•		GHA330011	K
2.0 T XWD (120 kW)	2007.01-	Saloon Engine B207G	•		GHA330011	K
2.0 T XWD (162 kW)	2008.01-	Saloon Engine A20NFT	•		GHA330011	K
2.0 t XWD (177 kW)	2009.05-	Estate Engine B207R	•		GHA330011	K
	2009.05-	Saloon Engine B207R	•		GHA330011	K
2.0 Turbo XWD (154 kW)	2008.01-	Saloon Engine B207R	•		GHA330011	K
2.2 TiD (92 kW)	2002.09-	Saloon Engine D223L	•		GHA330011	K
	2002.09-	Saloon Engine D223L		◦	GHA400137	K
2.8 Turbo V6 (169 kW)	2005.03-	Saloon Engine LP9	•		GHA330011	K
	2005.03-	Saloon Engine LP9		◦	GHA400137	K
	2006.02-	Convertible Engine LP9	•		GHA330011	K
	2006.02-	Convertible Engine LP9		◦	GHA400137	K
2.8 Turbo V6 (184 kW)	2005.07-2008.01	Convertible Engine LP9	•		GHA330011	K
	2005.07-2008.01	Convertible Engine LP9		◦	GHA400137	K
	2005.07-2008.01	Saloon Engine LP9	•		GHA330011	K
	2005.07-2008.01	Saloon Engine LP9		◦	GHA400137	K
2.8 Turbo V6 (188 kW)	2007.12-	Convertible Engine B284L	•		GHA330011	K
	2007.12-	Convertible Engine B284L		◦	GHA400137	K
	2007.12-	Saloon Engine B284L	•		GHA330011	K
	2007.12-	Saloon Engine B284L		◦	GHA400137	K
2.8 Turbo V6 (203 kW)	2008.04-	Saloon Engine B284L	•		GHA330011	K
	2008.04-	Saloon Engine B284L		◦	GHA400137	K
	2009.02-	Convertible Engine B284R	•		GHA330011	K
	2009.02-	Convertible Engine B284R		◦	GHA400137	K
2.8 Turbo V6 (206 kW)	2009.02-	Convertible Engine B284R	•		GHA330011	K
	2009.02-	Convertible Engine B284R		◦	GHA400137	K
2.8 Turbo V6 XWD (206 kW)	2008.05-	Saloon Engine B284R	•		GHA330011	K
9-3 CABRIOLET (YS3D)						
2.0 i (96 kW)	1998.02-2003.08	Convertible Engine B204I	•		GHA433004	
	1998.02-2003.08	Convertible Engine B204I	•		GWB3412	
	1998.02-2003.08	Convertible Engine B204I	•		GWB3543	
	1998.02-2003.08	Convertible Engine B204I With ABS		◦	GHA400052	K
2.0 SE Turbo (147 kW)	1998.02-2003.08	Convertible Engine B204R	•		GHA433004	
	1998.02-2003.08	Convertible Engine B204R	•		GWB3412	
	1998.02-2003.08	Convertible Engine B204R	•		GWB3543	
	1998.02-2003.08	Convertible Engine B204R With ABS		◦	GHA400052	K
2.0 Turbo (110 kW)	2001.01-2003.08	Convertible Engine B205E	•		GHA433004	
	2001.01-2003.08	Convertible Engine B205E	•		GWB3412	
	2001.01-2003.08	Convertible Engine B205E	•		GWB3543	
	2001.01-2003.08	Convertible Engine B205E With ABS		◦	GHA400052	K
2.0 Turbo (113 kW)	1998.10-2003.08	Convertible Engine B204E	•		GHA433004	
	1998.10-2003.08	Convertible Engine B204E	•		GWB3412	
	1998.10-2003.08	Convertible Engine B204E	•		GWB3543	
	1998.10-2003.08	Convertible Engine B204E With ABS		◦	GHA400052	K
2.0 Turbo (136 kW)	1998.02-2003.08	Convertible Engine B204L/B205L	•		GHA433004	
	1998.02-2003.08	Convertible Engine B204L/B205L	•		GWB3412	



	 YEAR		F	R	G-AP Ref.	KIT
SAAB						
9-3 CABRIOLET (YS3D)						
2.0 Turbo (136 kW)	1998.02-2003.08	Convertible Engine B204L/B205L	•		GWB3543	
	1998.02-2003.08	Convertible Engine B204L/B205L With ABS		◦	GHA400052	K
2.0 Turbo (151 kW)	1999.10-2003.08	Convertible Engine B205R	•		GHA433004	
	1999.10-2003.08	Convertible Engine B205R	•		GWB3412	
	1999.10-2003.08	Convertible Engine B205R	•		GWB3543	
	1999.10-2003.08	Convertible Engine B205R With ABS		◦	GHA400052	K
	1999.10-2003.08	Convertible Engine B205R With ABS	•		GHA433004	
2.3 (169 kW)	1999.09-2002.01	Convertible Engine B235R	•		GHA433004	
	1999.09-2002.01	Convertible Engine B235R	•		GWB3412	
	1999.09-2002.01	Convertible Engine B235R	•		GWB3543	
	1999.09-2002.01	Convertible Engine B235R With ABS		◦	GHA400052	K
2.3 i (110 kW)	1998.02-2003.08	Convertible Engine B234I	•		GHA433004	
	1998.02-2003.08	Convertible Engine B234I	•		GWB3412	
	1998.02-2003.08	Convertible Engine B234I	•		GWB3543	
	1998.02-2003.08	Convertible Engine B234I With ABS		◦	GHA400052	K
2.3 Turbo (165 kW)	1999.10-2003.08	Convertible Engine B235R	•		GHA433004	
	1999.10-2003.08	Convertible Engine B235R	•		GWB3412	
	1999.10-2003.08	Convertible Engine B235R	•		GWB3543	
	1999.10-2003.08	Convertible Engine B235R With ABS		◦	GHA400052	K
9-3X						
1.9 TTiD (132 kW)	2009.02-	Estate Engine A19DTR/Z19DTR	•		GHA330011	K
2.0 T BioPower XWD (154 kW)	2009.02-	Estate Engine B207R	•		GHA330011	K
2.0 T BioPower XWD (162 kW)	2011.01-	Estate Engine A20NFT	•		GHA330011	K
2.0 T XWD (154 kW)	2009.02-	Estate Engine B207R	•		GHA330011	K
9-5 (YS3E)						
1.9 TiD (110 kW)	2005.09-2008.01	Estate Engine Z19DTH	•		GHA330022	F
	2005.09-2008.01	Estate Engine Z19DTH		◦	GHA400118	K
	2005.09-2008.01	Saloon Engine Z19DTH	•		GHA330022	F
	2005.09-2008.01	Saloon Engine Z19DTH		◦	GHA400118	K
1.9 TiD (129 kW)	2007.01-2009.12	Estate Engine Z 19 DTR	•		GHA330022	F
	2007.01-2009.12	Estate Engine Z 19 DTR		◦	GHA400118	K
2.0 T (110 kW)	1997.09-	Saloon Engine B205E	•		GHA330022	F
	1997.09-	Saloon Engine B205E	•		GHA433004	
	1997.09-	Saloon Engine B205E	•		GWB3412	
	1997.09-	Saloon Engine B205E	•		GWB3543	
	1997.09-	Saloon Engine B205E		◦	GHA400118	K
	1997.09-	Saloon Engine B205E With ABS		◦	GHA400052	K
	1998.10-	Estate Engine B205E	•		GHA330022	F
	1998.10-	Estate Engine B205E	•		GHA433004	
	1998.10-	Estate Engine B205E	•		GWB3412	
	1998.10-	Estate Engine B205E	•		GWB3543	
	1998.10-	Estate Engine B205E		◦	GHA400118	K
2.0 T (136 kW)	1998.10-	Estate Engine B205E With ABS		◦	GHA400052	K
	2000.07-	Saloon Engine B205L	•		GHA330022	F
	2000.07-	Saloon Engine B205L	•		GHA433004	
	2000.07-	Saloon Engine B205L	•		GWB3412	
	2000.07-	Saloon Engine B205L	•		GWB3543	
	2000.07-	Saloon Engine B205L		◦	GHA400118	K
	2000.07-2001.07	Estate Engine B205L	•		GHA433004	
	2000.07-2001.07	Estate Engine B205L	•		GWB3412	
	2000.07-2001.07	Estate Engine B205L	•		GWB3543	
	2000.07-2001.07	Estate Engine B205L		◦	GHA400118	K
2.0 T (141 kW)	1998.10-	Estate Engine B204R	•		GHA330022	F
	1998.10-	Estate Engine B204R	•		GHA433004	
	1998.10-	Estate Engine B204R	•		GWB3412	
	1998.10-	Estate Engine B204R	•		GWB3543	
	1998.10-	Estate Engine B204R		◦	GHA400118	K
	1998.10-	Estate Engine B204R With ABS		◦	GHA400052	K
2.0 T BioPower (110 kW)	2005.01-	Saloon Engine B205E	•		GHA330022	F
	2005.01-	Saloon Engine B205E		◦	GHA400118	K
	2006.01-	Estate Engine B205E	•		GHA330022	F
	2006.01-	Estate Engine B205E		◦	GHA400118	K
2.0 T Biopower (132 kW)	2005.09-	Estate Engine B205E	•		GHA330022	F
	2005.09-	Estate Engine B205E		◦	GHA400118	K
	2007.06-	Saloon Engine B205E	•		GHA330022	F



	 YEAR		F	R	G-AP Ref.	KIT	
SAAB							
9-5 (YS3E)							
2.0 T Biopower (132 kW)	2007.06-	Saloon Engine B205E		o	GHA400118	K	
2.0 Turbo SE (141 kW)	1998.10-2000.07	Saloon Engine B205E	•		GWB3412		
	1998.10-2000.07	Saloon Engine B205E	•		GWB3543		
	1998.10-2000.07	Saloon Engine B205E		o	GHA400118	K	
	1998.10-2000.07	Saloon Engine B205E With ABS		o	GHA400052	K	
	2002.03-	Estate Engine D223L	•		GHA330022	F	
2.2 TiD (88 kW)	2002.03-	Estate Engine D223L		o	GHA400118	K	
	2002.03-	Saloon Engine D223L	•		GHA330022	F	
	2002.03-	Saloon Engine D223L		o	GHA400118	K	
	1997.09-	Saloon Engine B235E	•		GHA330022	F	
2.3 T (125 kW)	1997.09-	Saloon Engine B235E	•		GHA433004		
	1997.09-	Saloon Engine B235E	•		GWB3412		
	1997.09-	Saloon Engine B235E	•		GWB3543		
	1997.09-	Saloon Engine B235E		o	GHA400118	K	
	1997.09-	Saloon Engine B235E With ABS		o	GHA400052	K	
	1998.10-	Estate Engine B235E	•		GHA330022	F	
	1998.10-	Estate Engine B235E	•		GHA433004		
	1998.10-	Estate Engine B235E	•		GWB3412		
	1998.10-	Estate Engine B235E	•		GWB3543		
	1998.10-	Estate Engine B235E		o	GHA400118	K	
	1998.10-	Estate Engine B235E With ABS		o	GHA400052	K	
	2.3 T (136 kW)	2001.01-	Estate Engine B235E	•		GHA330022	F
		2001.01-	Estate Engine B235E	•		GWB3412	
2001.01-		Estate Engine B235E	•		GWB3543		
2001.01-		Estate Engine B235E		o	GHA400118	K	
2001.01-		Saloon Engine B235E	•		GHA330022	F	
2001.01-		Saloon Engine B235E	•		GWB3412		
2001.01-		Saloon Engine B235E	•		GWB3543		
2001.01-		Saloon Engine B235E		o	GHA400118	K	
2.3 T BioPower (136 kW)	2007.01-	Estate Engine B235E	•		GHA330022	F	
	2007.01-	Estate Engine B235E		o	GHA400118	K	
	2007.01-	Saloon Engine B235E	•		GHA330022	F	
	2007.01-	Saloon Engine B235E		o	GHA400118	K	
2.3 T BioPower (152 kW)	2006.11-	Estate Engine B235R	•		GHA330022	F	
	2006.11-	Estate Engine B235R		o	GHA400118	K	
	2006.11-	Saloon Engine B235R	•		GHA330022	F	
	2006.11-	Saloon Engine B235R		o	GHA400118	K	
2.3 T BioPower (154 kW)	2006.11-	Estate Engine B235R	•		GHA330022	F	
2006.11-	Estate Engine B235R		o	GHA400118	K		
2.3 Turbo (134 kW)	2008.04-	Saloon Engine B235E	•		GHA330022	F	
	2008.04-	Saloon Engine B235E		o	GHA400118	K	
2.3 Turbo (162 kW)	2003.06-2005.08	Estate Engine B235L	•		GHA330022	F	
	2003.06-2005.08	Estate Engine B235L		o	GHA400118	K	
	2003.06-2005.08	Saloon Engine B235L	•		GHA330022	F	
	2003.06-2005.08	Saloon Engine B235L		o	GHA400118	K	
2.3 Turbo (169 kW)	1999.10-2001.09	Estate Engine B235R	•		GHA433004		
	1999.10-2001.09	Estate Engine B235R	•		GWB3412		
	1999.10-2001.09	Estate Engine B235R	•		GWB3543		
	1999.10-2001.09	Estate Engine B235R		o	GHA400118	K	
	1999.10-2001.09	Estate Engine B235R With ABS		o	GHA400052	K	
	1999.10-2001.09	Saloon Engine B235R	•		GHA433004		
	1999.10-2001.09	Saloon Engine B235R	•		GWB3412		
	1999.10-2001.09	Saloon Engine B235R	•		GWB3543		
	1999.10-2001.09	Saloon Engine B235R		o	GHA400118	K	
2.3 Turbo (184 kW)	2001.09-	Estate Engine B235R	•		GHA330022	F	
	2001.09-	Estate Engine B235R	•		GWB3412		
	2001.09-	Estate Engine B235R	•		GWB3543		
	2001.09-	Estate Engine B235R		o	GHA400118	K	
	2001.09-	Saloon Engine B235R	•		GHA330022	F	
	2001.09-	Saloon Engine B235R	•		GWB3412		
	2001.09-	Saloon Engine B235R	•		GWB3543		
	2001.09-	Saloon Engine B235R		o	GHA400118	K	
2.3 Turbo (188 kW)	2008.04-	Estate Engine B235R	•		GHA330022	F	
	2008.04-	Estate Engine B235R		o	GHA400118	K	



	 YEAR		F	R	G-AP Ref.	KIT
SAAB						
9-5 (YS3E)						
2.3 Turbo (188 kW)	2008.04-	Saloon Engine B235R	•		GHA330022	F
	2008.04-	Saloon Engine B235R		◦	GHA400118	K
2.3 Turbo (191 kW)	2005.09-2008.01	Saloon Engine B235R	•		GHA330022	F
	2005.09-2008.01	Saloon Engine B235R		◦	GHA400118	K
	2006.10-2008.01	Estate Engine B235R	•		GHA330022	F
	2006.10-2008.01	Estate Engine B235R		◦	GHA400118	K
2.3 Turbo (224 kW)	2003.06-2005.08	Estate Engine B235R	•		GHA330022	F
	2003.06-2005.08	Estate Engine B235R		◦	GHA400118	K
	2003.06-2005.08	Saloon Engine B235R	•		GHA330022	F
	2003.06-2005.08	Saloon Engine B235R		◦	GHA400118	K
3.0 TiD (130 kW)	2001.07-	Estate Engine D308L	•		GHA330022	F
	2001.07-	Estate Engine D308L	•		GWB3412	
	2001.07-	Estate Engine D308L	•		GWB3543	
	2001.07-	Estate Engine D308L		◦	GHA400118	K
	2001.07-	Saloon Engine D308L	•		GHA330022	F
	2001.07-	Saloon Engine D308L	•		GWB3412	
	2001.07-	Saloon Engine D308L	•		GWB3543	
3.0 V6t (147 kW)	1998.01-	Saloon Engine B308E	•		GHA330022	F
	1998.01-	Saloon Engine B308E	•		GHA433004	
	1998.01-	Saloon Engine B308E	•		GWB3412	
	1998.01-	Saloon Engine B308E	•		GWB3543	
	1998.01-	Saloon Engine B308E		◦	GHA400118	K
	1998.01-	Saloon Engine B308E With ABS		◦	GHA400052	K
	1998.10-	Estate Engine B308E	•		GHA330022	F
	1998.10-	Estate Engine B308E	•		GHA433004	
	1998.10-	Estate Engine B308E	•		GWB3412	
	1998.10-	Estate Engine B308E	•		GWB3543	
	1998.10-	Estate Engine B308E		◦	GHA400118	K
1998.10-	Estate Engine B308E With ABS		◦	GHA400052	K	
9-5 (YS3G)						
1.6 Turbo (132 kW)	2010.05-	Saloon Engine A16LET Without ABS	•		GHA330024	K
	2010.05-	Saloon Engine A16LET Without ABS		◦	GHA330024	S
2.0 T BioPower (162 kW)	2010.05-	Saloon Engine A20NFT Without ABS	•		GHA330024	K
	2010.05-	Saloon Engine A20NFT Without ABS		◦	GHA330024	S
2.0 T BioPower XWD (162 kW)	2010.05-	Saloon Engine A20NHT Without ABS	•		GHA330024	K
	2010.05-	Saloon Engine A20NHT Without ABS		◦	GHA330024	F
2.0 TiD (118 kW)	2010.05-	Saloon Engine A20DTH Without ABS	•		GHA330024	K
	2010.05-	Saloon Engine A20DTH Without ABS		◦	GHA330024	S
2.0 TTiD (140 kW)	2010.05-	Saloon Engine A20DTR Without ABS	•		GHA330024	K
	2010.05-	Saloon Engine A20DTR Without ABS		◦	GHA330024	S
2.0 TTiD XWD (140 kW)	2010.05-	Saloon Engine A20DTR Without ABS	•		GHA330024	K
	2010.05-	Saloon Engine A20DTR Without ABS		◦	GHA330024	F
2.0 Turbo (162 kW)	2010.05-	Saloon Engine A20NHT Without ABS	•		GHA330024	K
	2010.05-	Saloon Engine A20NHT Without ABS		◦	GHA330024	S
2.0 Turbo XWD (162 kW)	2010.05-	Saloon Engine A20NHT Without ABS	•		GHA330024	K
	2010.05-	Saloon Engine A20NHT Without ABS		◦	GHA330024	F
2.8 Turbo V6 XWD (221 kW)	2010.05-	Saloon Engine A28NER Without ABS	•		GHA330024	K
	2010.05-	Saloon Engine A28NER Without ABS		◦	GHA330024	F
9-7X						
4.2 (213 kW)	2005.12-	Closed Off-Road Vehicle Engine LL8	•		GHA327027	
5.3 (220 kW)	2005.12-	Closed Off-Road Vehicle Engine LH6	•		GHA327027	
SEAT						
ALHAMBRA (710)						
1.4 TSi (110 kW)	2010.06-	MPV Engine CAVA/CNWB/CTHA 4 hole	•		GHA336007	K
	2010.06-	MPV Engine CAVA/CNWB/CTHA Inner Diameter [32mm]		◦	GHA232018	K
1.8 TFSi (118 kW)	2012.11-	MPV Engine CDAA 4 hole	•		GHA336007	K
	2012.11-	MPV Engine CDAA Inner Diameter [32mm]		◦	GHA232018	K
2.0 TDi (100 kW)	2010.06-2011.05	MPV Engine CFFA 4 hole	•		GHA336007	K
	2010.06-2011.05	MPV Engine CFFA Inner Diameter [32mm]		◦	GHA232018	K
2.0 TDi (103 kW)	2010.06-	MPV Engine CFFB 4 hole	•		GHA336007	K
	2010.06-	MPV Engine CFFB Inner Diameter [32mm]		◦	GHA232018	K
	2011.05-	MPV Engine CFFB 4 hole	•		GHA336007	K



	 YEAR		F	R	G-AP Ref.	KIT
SEAT						
ALHAMBRA (710)						
2.0 TDi (125 kW)	2010.06-	MPV Engine CFGB 4 hole	•		GHA336007	K
	2010.06-	MPV Engine CFGB Inner Diameter [32mm]		○	GHA232018	K
2.0 TDi (130 kW)	2012.11-	MPV Engine CFGC 4 hole	•		GHA336007	K
	2012.11-	MPV Engine CFGC Inner Diameter [32mm]		○	GHA232018	K
2.0 TDi (85 kW)	2011.05-	MPV Engine CFFE 4 hole	•		GHA336007	K
	2011.05-	MPV Engine CFFE Inner Diameter [32mm]		○	GHA232018	K
2.0 TSi (147 kW)	2010.11-	MPV Engine CCZA 4 hole	•		GHA336007	K
	2010.11-	MPV Engine CCZA Inner Diameter [32mm]		○	GHA232018	K
ALHAMBRA (7V8, 7V9)						
1.8 T 20V (110 kW)	1997.10-2010.03	MPV Engine AJH/AWC	•		GWB3449	
	1997.10-2010.03	MPV Engine AJH/AWC		○	GWB3450	
1.9 TDi (110 kW)	2005.05-2007.05	MPV Engine ARL/BTB	•		GWB3449	
	2005.05-2007.05	MPV Engine ARL/BTB		○	GWB3450	
1.9 TDi (66 kW)	1996.04-2010.03	MPV Engine 1Z/AHU/ANU	•		GWB3449	
	1996.04-2010.03	MPV Engine 1Z/AHU/ANU		○	GWB3450	
1.9 TDi (81 kW)	1996.08-2000.06	MPV Engine AFN/AVG	•		GWB3449	
	1996.08-2000.06	MPV Engine AFN/AVG		○	GWB3450	
1.9 TDi (85 kW)	2000.06-2010.03	MPV Engine AUY/BVK	•		GWB3449	
	2000.06-2010.03	MPV Engine AUY/BVK		○	GWB3450	
1.9 TDi (96 kW)	2002.11-2008.11	MPV Engine ASZ	•		GWB3449	
	2002.11-2008.11	MPV Engine ASZ		○	GWB3450	
1.9 TDi 4motion (85 kW)	2000.06-2010.03	MPV Engine AUY/BVK	•		GWB3449	
1.9 TDi 4x4 (96 kW)	2005.06-2008.11	MPV Engine ASZ	•		GWB3449	
2.0 i (85 kW)	1996.04-2010.03	MPV Engine ADY/ATM	•		GWB3449	
	1996.04-2010.03	MPV Engine ADY/ATM		○	GWB3450	
2.0 TDi (103 kW)	2005.11-2010.03	MPV Engine BRT	•		GWB3449	
	2005.11-2010.03	MPV Engine BRT		○	GWB3450	
2.8 V6 (150 kW)	2000.06-2010.03	MPV Engine AUE/AYL	•		GWB3449	
	2000.06-2010.03	MPV Engine AUE/AYL		○	GWB3450	
2.8 V6 4motion (150 kW)	2000.06-2010.03	MPV Engine AUE/AYL	•		GWB3449	
ALTEA (5P1)						
1.2 TSi (77 kW)	2010.04-	MPV Engine CBZB 3 hole	•		GHA336004	K
	2010.04-	MPV Engine CBZB 4 hole	•		GHA336007	K
	2010.04-	MPV Engine CBZB Inner Diameter [30mm]		○	GHA230082	K
	2010.04-	MPV Engine CBZB Inner Diameter [32mm]		○	GHA232018	K
1.4 16V (63 kW)	2006.05-	MPV Engine BXW/CGGB 3 hole	•		GHA336004	K
	2006.05-	MPV Engine BXW/CGGB 4 hole	•		GHA336007	K
	2006.05-	MPV Engine BXW/CGGB Inner Diameter [30mm]		○	GHA230082	K
	2006.05-	MPV Engine BXW/CGGB Inner Diameter [32mm]		○	GHA232018	K
1.4 TSi (92 kW)	2007.11-	MPV Engine CAXC 3 hole	•		GHA336004	K
	2007.11-	MPV Engine CAXC 4 hole	•		GHA336007	K
	2007.11-	MPV Engine CAXC Inner Diameter [30mm]		○	GHA230082	K
	2007.11-	MPV Engine CAXC Inner Diameter [32mm]		○	GHA232018	K
1.6 (75 kW)	2004.05-2007.07	MPV Engine CMXA/CCSA/BSF/BSE/BGU 3 hole	•		GHA336004	K
	2004.05-2007.07	MPV Engine CMXA/CCSA/BSF/BSE/BGU 4 hole	•		GHA336007	K
	2004.05-2007.07	MPV Engine CMXA/CCSA/BSF/BSE/BGU Inner Diameter [30mm]		○	GHA230082	K
	2004.05-2007.07	MPV Engine CMXA/CCSA/BSF/BSE/BGU Inner Diameter [32mm]		○	GHA232018	K
1.6 LPG (75 kW)	2009.09-	MPV Engine CHGA 3 hole	•		GHA336004	K
	2009.09-	MPV Engine CHGA 4 hole	•		GHA336007	K
	2009.09-	MPV Engine CHGA Inner Diameter [30mm]		○	GHA230082	K
	2009.09-	MPV Engine CHGA Inner Diameter [32mm]		○	GHA232018	K
1.6 TDi (66 kW)	2010.11-	MPV Engine CAYB 3 hole	•		GHA336004	K
	2010.11-	MPV Engine CAYB 4 hole	•		GHA336007	K
	2010.11-	MPV Engine CAYB Inner Diameter [30mm]		○	GHA230082	K
	2010.11-	MPV Engine CAYB Inner Diameter [32mm]		○	GHA232018	K
1.6 TDi (77 kW)	2009.10-	MPV Engine CAYC 3 hole	•		GHA336004	K
	2009.10-	MPV Engine CAYC 4 hole	•		GHA336007	K
	2009.10-	MPV Engine CAYC Inner Diameter [30mm]		○	GHA230082	K
	2009.10-	MPV Engine CAYC Inner Diameter [32mm]		○	GHA232018	K
1.8 TFSi (118 kW)	2007.01-	MPV Engine BYT/BZB/CDA 3 hole	•		GHA336004	K
	2007.01-	MPV Engine BYT/BZB/CDA 4 hole	•		GHA336007	K
	2007.01-	MPV Engine BYT/BZB/CDA Inner Diameter [30mm]		○	GHA230082	K
	2007.01-	MPV Engine BYT/BZB/CDA Inner Diameter [32mm]		○	GHA232018	K
1.9 TDi (66 kW)	2009.08-	MPV Engine BXF 3 hole	•		GHA336004	K



	 YEAR		F	R	G-AP Ref.	KIT
SEAT						
ALTEA (5P1)						
1.9 TDi (66 kW)	2009.08-	MPV Engine BXF 4 hole	•		GHA336007	K
	2009.08-	MPV Engine BXF Inner Diameter [30mm]		○	GHA230082	K
	2009.08-	MPV Engine BXF Inner Diameter [32mm]		○	GHA232018	K
1.9 TDi (77 kW)	2004.05-2007.07	MPV Engine BJB/BKC/BLS/BXE 3 hole	•		GHA336004	K
	2004.05-2007.07	MPV Engine BJB/BKC/BLS/BXE 4 hole	•		GHA336007	K
	2004.05-2007.07	MPV Engine BJB/BKC/BLS/BXE Inner Diameter [30mm]		○	GHA230082	K
	2004.05-2007.07	MPV Engine BJB/BKC/BLS/BXE Inner Diameter [32mm]		○	GHA232018	K
2.0 FSi (110 kW)	2004.05-2007.07	MPV Engine BLR/BLY/BVY/BVZ 3 hole	•		GHA336004	K
	2004.05-2007.07	MPV Engine BLR/BLY/BVY/BVZ 4 hole	•		GHA336007	K
	2004.05-2007.07	MPV Engine BLR/BLY/BVY/BVZ Inner Diameter [30mm]		○	GHA230082	K
	2004.05-2007.07	MPV Engine BLR/BLY/BVY/BVZ Inner Diameter [32mm]		○	GHA232018	K
2.0 TDi (100 kW)	2004.03-2009.05	MPV Engine AZV 3 hole	•		GHA336004	K
	2004.03-2009.05	MPV Engine AZV 4 hole	•		GHA336007	K
	2004.03-2009.05	MPV Engine AZV Inner Diameter [30mm]		○	GHA230082	K
	2004.03-2009.05	MPV Engine AZV Inner Diameter [32mm]		○	GHA232018	K
2.0 TDi (103 kW)	2005.11-	MPV Engine BMM 3 hole	•		GHA336004	K
	2005.11-	MPV Engine BMM 4 hole	•		GHA336007	K
	2005.11-	MPV Engine BMM Inner Diameter [30mm]		○	GHA230082	K
	2005.11-	MPV Engine BMM Inner Diameter [32mm]		○	GHA232018	K
2.0 TDi (125 kW)	2005.11-2007.07	MPV Engine BMN/CEGA 3 hole	•		GHA336004	K
	2005.11-2007.07	MPV Engine BMN/CEGA 4 hole	•		GHA336007	K
	2005.11-2007.07	MPV Engine BMN/CEGA Inner Diameter [30mm]		○	GHA230082	K
	2005.11-2007.07	MPV Engine BMN/CEGA Inner Diameter [32mm]		○	GHA232018	K
2.0 TDi 16V (103 kW)	2004.05-2007.07	MPV Engine BKD/CFHC 3 hole	•		GHA336004	K
	2004.05-2007.07	MPV Engine BKD/CFHC 4 hole	•		GHA336007	K
	2004.05-2007.07	MPV Engine BKD/CFHC Inner Diameter [30mm]		○	GHA230082	K
	2004.05-2007.07	MPV Engine BKD/CFHC Inner Diameter [32mm]		○	GHA232018	K
2.0 TFSi (147 kW)	2006.04-2009.05	MPV Engine BWA 3 hole	•		GHA336004	K
	2006.04-2009.05	MPV Engine BWA 4 hole	•		GHA336007	K
	2006.04-2009.05	MPV Engine BWA Inner Diameter [30mm]		○	GHA230082	K
	2006.04-2009.05	MPV Engine BWA Inner Diameter [32mm]		○	GHA232018	K
ALTEA XL (5P5, 5P8)						
1.2 TSi (77 kW)	2010.04-	MPV Engine CBZB 3 hole	•		GHA336004	K
	2010.04-	MPV Engine CBZB 4 hole	•		GHA336007	K
	2010.04-	MPV Engine CBZB Inner Diameter [30mm]		○	GHA230082	K
	2010.04-	MPV Engine CBZB Inner Diameter [32mm]		○	GHA232018	K
1.4 16V (63 kW)	2006.10-	MPV Engine BXW/CGGB 3 hole	•		GHA336004	K
	2006.10-	MPV Engine BXW/CGGB 4 hole	•		GHA336007	K
	2006.10-	MPV Engine BXW/CGGB Inner Diameter [30mm]		○	GHA230082	K
	2006.10-	MPV Engine BXW/CGGB Inner Diameter [32mm]		○	GHA232018	K
1.4 TSi (92 kW)	2007.11-	MPV Engine CAXC 3 hole	•		GHA336004	K
	2007.11-	MPV Engine CAXC 4 hole	•		GHA336007	K
	2007.11-	MPV Engine CAXC Inner Diameter [30mm]		○	GHA230082	K
	2007.11-	MPV Engine CAXC Inner Diameter [32mm]		○	GHA232018	K
1.6 (75 kW)	2006.10-	MPV Engine BSE/BSF/CCSA/CMXA 3 hole	•		GHA336004	K
	2006.10-	MPV Engine BSE/BSF/CCSA/CMXA 4 hole	•		GHA336007	K
	2006.10-	MPV Engine BSE/BSF/CCSA/CMXA Inner Diameter [30mm]		○	GHA230082	K
	2006.10-	MPV Engine BSE/BSF/CCSA/CMXA Inner Diameter [32mm]		○	GHA232018	K
1.6 LPG (75 kW)	2009.09-	MPV Engine CHGA 3 hole	•		GHA336004	K
	2009.09-	MPV Engine CHGA 4 hole	•		GHA336007	K
	2009.09-	MPV Engine CHGA Inner Diameter [30mm]		○	GHA230082	K
	2009.09-	MPV Engine CHGA Inner Diameter [32mm]		○	GHA232018	K
1.6 Multifuel (75 kW)	2006.10-	MPV Engine CCSA 3 hole	•		GHA336004	K
	2006.10-	MPV Engine CCSA 4 hole	•		GHA336007	K
	2006.10-	MPV Engine CCSA Inner Diameter [30mm]		○	GHA230082	K
	2006.10-	MPV Engine CCSA Inner Diameter [32mm]		○	GHA232018	K
1.6 TDi (66 kW)	2010.11-	MPV Engine CAYB 3 hole	•		GHA336004	K
	2010.11-	MPV Engine CAYB 4 hole	•		GHA336007	K
	2010.11-	MPV Engine CAYB Inner Diameter [30mm]		○	GHA230082	K
	2010.11-	MPV Engine CAYB Inner Diameter [32mm]		○	GHA232018	K
1.6 TDi (77 kW)	2009.10-	MPV Engine CAYC 3 hole	•		GHA336004	K
	2009.10-	MPV Engine CAYC 4 hole	•		GHA336007	K
	2009.10-	MPV Engine CAYC Inner Diameter [30mm]		○	GHA230082	K
	2009.10-	MPV Engine CAYC Inner Diameter [32mm]		○	GHA232018	K



	 YEAR		F	R	G-AP Ref.	KIT
SEAT						
ALTEA XL (5P5, 5P8)						
1.8 TFSi (118 kW)	2007.01-	MPV Engine BYT/BZB/CDAA 3 hole	•		GHA336004	K
	2007.01-	MPV Engine BYT/BZB/CDAA 4 hole	•		GHA336007	K
	2007.01-	MPV Engine BYT/BZB/CDAA Inner Diameter [30mm]		○	GHA230082	K
	2007.01-	MPV Engine BYT/BZB/CDAA Inner Diameter [32mm]		○	GHA232018	K
1.9 TDi (66 kW)	2009.08-	MPV Engine BXF 3 hole	•		GHA336004	K
	2009.08-	MPV Engine BXF 4 hole	•		GHA336007	K
	2009.08-	MPV Engine BXF Inner Diameter [30mm]		○	GHA230082	K
	2009.08-	MPV Engine BXF Inner Diameter [32mm]		○	GHA232018	K
1.9 TDi (77 kW)	2006.10-	MPV Engine BLS/BXE/BKC 3 hole	•		GHA336004	K
	2006.10-	MPV Engine BLS/BXE/BKC 4 hole	•		GHA336007	K
	2006.10-	MPV Engine BLS/BXE/BKC Inner Diameter [30mm]		○	GHA230082	K
	2006.10-	MPV Engine BLS/BXE/BKC Inner Diameter [32mm]		○	GHA232018	K
1.9 TDi 4x4 (77 kW)	2009.06-2010.12	MPV Engine BLS 3 hole	•		GHA336004	K
	2009.06-2010.12	MPV Engine BLS 4 hole	•		GHA336007	K
2.0 FSi (110 kW)	2006.10-2009.03	MPV Engine BVY/BVZ 3 hole	•		GHA336004	K
	2006.10-2009.03	MPV Engine BVY/BVZ 4 hole	•		GHA336007	K
	2006.10-2009.03	MPV Engine BVY/BVZ Inner Diameter [30mm]		○	GHA230082	K
	2006.10-2009.03	MPV Engine BVY/BVZ Inner Diameter [32mm]		○	GHA232018	K
2.0 TDi (100 kW)	2006.11-2009.03	MPV Engine AZV 3 hole	•		GHA336004	K
	2006.11-2009.03	MPV Engine AZV 4 hole	•		GHA336007	K
	2006.11-2009.03	MPV Engine AZV Inner Diameter [30mm]		○	GHA230082	K
	2006.11-2009.03	MPV Engine AZV Inner Diameter [32mm]		○	GHA232018	K
2.0 TDi (103 kW)	2006.10-	MPV Engine BMM 3 hole	•		GHA336004	K
	2006.10-	MPV Engine BMM 4 hole	•		GHA336007	K
	2006.10-	MPV Engine BMM Inner Diameter [30mm]		○	GHA230082	K
	2006.10-	MPV Engine BMM Inner Diameter [32mm]		○	GHA232018	K
2.0 TDi (125 kW)	2007.06-	MPV Engine BMN/CEGA 3 hole	•		GHA336004	K
	2007.06-	MPV Engine BMN/CEGA 4 hole	•		GHA336007	K
	2007.06-	MPV Engine BMN/CEGA Inner Diameter [30mm]		○	GHA230082	K
	2007.06-	MPV Engine BMN/CEGA Inner Diameter [32mm]		○	GHA232018	K
2.0 TDi 16V (103 kW)	2006.10-	MPV Engine BKD/CFHC 3 hole	•		GHA336004	K
	2006.10-	MPV Engine BKD/CFHC 4 hole	•		GHA336007	K
	2006.10-	MPV Engine BKD/CFHC Inner Diameter [30mm]		○	GHA230082	K
	2006.10-	MPV Engine BKD/CFHC Inner Diameter [32mm]		○	GHA232018	K
2.0 TDi 16V 4x4 (103 kW)	2010.10-	MPV Engine CFHC 3 hole	•		GHA336004	K
	2010.10-	MPV Engine CFHC 4 hole	•		GHA336007	K
2.0 TDi 4x4 (103 kW)	2007.06-	MPV Engine BMM 3 hole	•		GHA336004	K
	2007.06-	MPV Engine BMM 4 hole	•		GHA336007	K
2.0 TDi 4x4 (125 kW)	2007.06-	MPV Engine BMN/CEGA/CFJA 3 hole	•		GHA336004	K
	2007.06-	MPV Engine BMN/CEGA/CFJA 4 hole	•		GHA336007	K
2.0 TFSi (147 kW)	2006.10-2009.05	MPV Engine BWA 3 hole	•		GHA336004	K
	2006.10-2009.05	MPV Engine BWA 4 hole	•		GHA336007	K
	2006.10-2009.05	MPV Engine BWA Inner Diameter [30mm]		○	GHA230082	K
	2006.10-2009.05	MPV Engine BWA Inner Diameter [32mm]		○	GHA232018	K
2.0 TFSi 4x4 (147 kW)	2007.06-2009.05	MPV Engine BWA 3 hole	•		GHA336004	K
	2007.06-2009.05	MPV Engine BWA 4 hole	•		GHA336007	K
2.0 TFSi 4x4 (155 kW)	2009.05-	MPV Engine CCZB 3 hole	•		GHA336004	K
	2009.05-	MPV Engine CCZB 4 hole	•		GHA336007	K
AROSA (6H)						
1.0 (37 kW)	1997.05-2004.06	Hatchback Engine AER/ALD/ALL/ANV/AUC	•		GHA422022	
	1997.05-2004.06	Hatchback Engine AER/ALD/ALL/ANV/AUC	•		GWB0906	
	1997.05-2004.06	Hatchback Engine AER/ALD/ALL/ANV/AUC		○	GHA499044	
	1997.05-2004.06	Hatchback Engine AER/ALD/ALL/ANV/AUC		○	GHA499045	
	1997.05-2004.06	Hatchback Engine AER/ALD/ALL/ANV/AUC		○	GHA499046	
	1997.05-2004.06	Hatchback Engine AER/ALD/ALL/ANV/AUC		○	GWB0529	
	1997.05-2004.06	Hatchback Engine AER/ALD/ALL/ANV/AUC With ABS		○	GHA228041	K
	1998.10-2001.01	Hatchback Engine AHT	•		GHA422022	
	1998.10-2001.01	Hatchback Engine AHT	•		GWB0906	
	1998.10-2001.01	Hatchback Engine AHT		○	GHA499044	
	1998.10-2001.01	Hatchback Engine AHT		○	GHA499045	
	1998.10-2001.01	Hatchback Engine AHT		○	GHA499046	
	1998.10-2001.01	Hatchback Engine AHT		○	GWB0529	
	1998.10-2001.01	Hatchback Engine AHT With ABS		○	GHA228041	K
1.4 (44 kW)	1997.05-2004.06	Hatchback Engine AEX/AKK/AKV/ANW/APQ/AUD	•		GHA422022	



	 YEAR		F	R	G-AP Ref.	KIT
SEAT						
AROSA (6H)						
1.4 (44 kW)	1997.05-2004.06	Hatchback Engine AEX/AKK/AKV/ANW/APQ/AUD	•		GWB0906	
	1997.05-2004.06	Hatchback Engine AEX/AKK/AKV/ANW/APQ/AUD		○	GHA499044	
	1997.05-2004.06	Hatchback Engine AEX/AKK/AKV/ANW/APQ/AUD		○	GHA499045	
	1997.05-2004.06	Hatchback Engine AEX/AKK/AKV/ANW/APQ/AUD		○	GHA499046	
	1997.05-2004.06	Hatchback Engine AEX/AKK/AKV/ANW/APQ/AUD		○	GWB0529	
	1997.05-2004.06	Hatchback Engine AEX/AKK/AKV/ANW/APQ/AUD With ABS		○	GHA228041	K
1.4 16V (74 kW)	2000.01-2004.06	Hatchback Engine AFK/AQQ/AUB	•		GHA422022	
	2000.01-2004.06	Hatchback Engine AFK/AQQ/AUB	•		GWB0906	
	2000.01-2004.06	Hatchback Engine AFK/AQQ/AUB		○	GHA499044	
	2000.01-2004.06	Hatchback Engine AFK/AQQ/AUB With ABS		○	GHA228041	K
1.4 TDi (55 kW)	2000.01-2004.06	Hatchback Engine AMF	•		GHA422022	
	2000.01-2004.06	Hatchback Engine AMF	•		GWB0906	
	2000.01-2004.06	Hatchback Engine AMF		○	GHA499044	
	2000.01-2004.06	Hatchback Engine AMF With ABS		○	GHA228041	K
1.7 SDi (44 kW)	1997.08-2004.06	Hatchback Engine AKU	•		GHA422022	
	1997.08-2004.06	Hatchback Engine AKU	•		GWB0906	
	1997.08-2004.06	Hatchback Engine AKU		○	GHA499044	
	1997.08-2004.06	Hatchback Engine AKU		○	GHA499045	
	1997.08-2004.06	Hatchback Engine AKU		○	GHA499046	
	1997.08-2004.06	Hatchback Engine AKU With ABS		○	GWB0529	
					GHA228041	K
CORDOBA (6K1, 6K2)						
1.0 i (37 kW)	1996.09-1999.06	Saloon Engine AER	•		GHA422009	K
	1996.09-1999.06	Saloon Engine AER	•		GHA422036	K
	1996.09-1999.06	Saloon Engine AER	•		GWB1358	
	1996.09-1999.06	Saloon Engine AER		○	GHA499045	
	1996.09-1999.06	Saloon Engine AER		○	GHA499046	
	1996.09-1999.06	Saloon Engine AER		○	GWB0529	
	1996.09-1999.06	Saloon Engine AER With ABS		○	GHA228041	K
1.4 (40 kW)	1997.12-1999.04	Saloon Engine ANX	•		GHA422036	K
	1997.12-1999.04	Saloon Engine ANX	•		GWB1358	
	1997.12-1999.04	Saloon Engine ANX		○	GWB0529	
1.4 i (44 kW)	1994.06-1999.06	Saloon Engine ABD/AEX/AKV/APQ	•		GHA422009	K
	1994.06-1999.06	Saloon Engine ABD/AEX/AKV/APQ	•		GHA422036	K
	1994.06-1999.06	Saloon Engine ABD/AEX/AKV/APQ	•		GWB1358	
	1994.06-1999.06	Saloon Engine ABD/AEX/AKV/APQ		○	GHA499044	
	1994.06-1999.06	Saloon Engine ABD/AEX/AKV/APQ		○	GHA499045	
	1994.06-1999.06	Saloon Engine ABD/AEX/AKV/APQ		○	GHA499046	
	1994.06-1999.06	Saloon Engine ABD/AEX/AKV/APQ With ABS		○	GWB0529	
					GHA228041	K
1.4 i 16V (74 kW)	1996.09-1999.06	Saloon Engine AFH	•		GHA422009	K
	1996.09-1999.06	Saloon Engine AFH	•		GHA422036	K
	1996.09-1999.06	Saloon Engine AFH	•		GWB1358	
	1996.09-1999.06	Saloon Engine AFH		○	GHA499045	
	1996.09-1999.06	Saloon Engine AFH		○	GHA499046	
	1996.09-1999.06	Saloon Engine AFH		○	GWB0529	
	1996.09-1999.06	Saloon Engine AFH With ABS		○	GHA228041	K
1.6 i (55 kW)	1993.02-1999.06	Saloon Engine ABU/AEE/ALM	•		GHA422009	K
	1993.02-1999.06	Saloon Engine ABU/AEE/ALM	•		GHA422036	K
	1993.02-1999.06	Saloon Engine ABU/AEE/ALM	•		GWB1358	
	1993.02-1999.06	Saloon Engine ABU/AEE/ALM		○	GHA499044	
	1993.02-1999.06	Saloon Engine ABU/AEE/ALM		○	GHA499046	
	1993.02-1999.06	Saloon Engine ABU/AEE/ALM		○	GWB0529	
	1993.02-1999.06	Saloon Engine ABU/AEE/ALM With ABS		○	GHA228041	K
	1994.05-1999.06	Saloon Engine 1F	•		GHA422009	K
	1994.05-1999.06	Saloon Engine 1F	•		GHA422036	K
	1994.05-1999.06	Saloon Engine 1F	•		GWB1358	
	1994.05-1999.06	Saloon Engine 1F		○	GHA499044	
	1994.05-1999.06	Saloon Engine 1F		○	GHA499045	
	1994.05-1999.06	Saloon Engine 1F		○	GHA499046	
1994.05-1999.06	Saloon Engine 1F		○	GWB0529		
1994.05-1999.06	Saloon Engine 1F With ABS		○	GHA228041	K	
1.6 i (74 kW)	1996.07-1999.10	Saloon Engine AFT	•		GHA422009	K
	1996.07-1999.10	Saloon Engine AFT	•		GHA422036	K



	 YEAR		F	R	G-AP Ref.	KIT
SEAT						
CORDOBA (6K1, 6K2)						
1.6 i (74 kW)	1996.07-1999.10	Saloon Engine AFT	•		GWB1358	
	1996.07-1999.10	Saloon Engine AFT		○	GHA499045	
	1996.07-1999.10	Saloon Engine AFT		○	GHA499046	
	1996.07-1999.10	Saloon Engine AFT		○	GWB0529	
	1996.07-1999.10	Saloon Engine AFT With ABS		○	GHA228041	K
1.8 i (66 kW)	1993.02-1999.06	Saloon Engine ABS/ADZ/ACC	•		GHA422009	K
	1993.02-1999.06	Saloon Engine ABS/ADZ/ACC	•		GHA422036	K
	1993.02-1999.06	Saloon Engine ABS/ADZ/ACC	•		GWB1358	
	1993.02-1999.06	Saloon Engine ABS/ADZ/ACC		○	GHA499044	
	1993.02-1999.06	Saloon Engine ABS/ADZ/ACC		○	GHA499045	
	1993.02-1999.06	Saloon Engine ABS/ADZ/ACC		○	GHA499046	
	1993.02-1999.06	Saloon Engine ABS/ADZ/ACC		○	GWB0529	
	1993.02-1999.06	Saloon Engine ABS/ADZ/ACC With ABS		○	GHA228041	K
1.8 i 16V (95 kW)	1993.10-1996.08	Saloon Engine ADL	•		GHA422009	K
	1993.10-1996.08	Saloon Engine ADL	•		GHA422036	K
	1993.10-1996.08	Saloon Engine ADL	•		GWB1358	
	1993.10-1996.08	Saloon Engine ADL		○	GHA499014	
	1993.10-1996.08	Saloon Engine ADL		○	GHA499015	
	1993.10-1996.08	Saloon Engine ADL		○	GHA499045	
	1993.10-1996.08	Saloon Engine ADL		○	GWB0529	
1.9 D (47 kW)	1996.01-1996.08	Saloon Engine 1Y	•		GHA422009	K
	1996.01-1996.08	Saloon Engine 1Y	•		GHA422036	K
	1996.01-1996.08	Saloon Engine 1Y	•		GWB1358	
	1996.01-1996.08	Saloon Engine 1Y		○	GHA499044	
	1996.01-1996.08	Saloon Engine 1Y		○	GHA499045	
	1996.01-1996.08	Saloon Engine 1Y		○	GHA499046	
	1996.01-1996.08	Saloon Engine 1Y		○	GWB0529	
1.9 D (50 kW)	1993.02-1996.08	Saloon Engine 1Y	•		GHA422009	K
	1993.02-1996.08	Saloon Engine 1Y	•		GHA422036	K
	1993.02-1996.08	Saloon Engine 1Y	•		GWB1358	
	1993.02-1996.08	Saloon Engine 1Y		○	GHA499045	
	1993.02-1996.08	Saloon Engine 1Y		○	GHA499046	
1.9 SDi (47 kW)	1996.08-1999.06	Saloon Engine AEY	•		GHA422009	K
	1996.08-1999.06	Saloon Engine AEY	•		GHA422036	K
	1996.08-1999.06	Saloon Engine AEY	•		GWB1358	
	1996.08-1999.06	Saloon Engine AEY		○	GHA499044	
	1996.08-1999.06	Saloon Engine AEY		○	GHA499045	
	1996.08-1999.06	Saloon Engine AEY		○	GHA499046	
	1996.08-1999.06	Saloon Engine AEY		○	GWB0529	
1.9 TD (55 kW)	1993.02-1996.08	Saloon Engine AAZ	•		GHA422009	K
	1993.02-1996.08	Saloon Engine AAZ	•		GHA422036	K
	1993.02-1996.08	Saloon Engine AAZ	•		GWB1358	
	1993.02-1996.08	Saloon Engine AAZ		○	GHA499044	
	1993.02-1996.08	Saloon Engine AAZ		○	GHA499045	
	1993.02-1996.08	Saloon Engine AAZ		○	GHA499046	
	1993.02-1996.08	Saloon Engine AAZ		○	GWB0529	
1.9 TDi (66 kW)	1996.08-1999.06	Saloon Engine 1Z/AHU	•		GHA422009	K
	1996.08-1999.06	Saloon Engine 1Z/AHU	•		GHA422036	K
	1996.08-1999.06	Saloon Engine 1Z/AHU	•		GWB1358	
	1996.08-1999.06	Saloon Engine 1Z/AHU		○	GHA499045	
	1996.08-1999.06	Saloon Engine 1Z/AHU		○	GHA499046	
	1996.08-1999.06	Saloon Engine 1Z/AHU		○	GWB0529	
	1996.08-1999.06	Saloon Engine 1Z/AHU With ABS		○	GHA228041	K
1.9 TDi (81 kW)	1997.03-1999.06	Saloon Engine AFN	•		GHA422009	K
	1997.03-1999.06	Saloon Engine AFN	•		GHA422036	K
	1997.03-1999.06	Saloon Engine AFN	•		GWB1358	
	1997.03-1999.06	Saloon Engine AFN		○	GHA499014	
	1997.03-1999.06	Saloon Engine AFN		○	GHA499015	
	1997.03-1999.06	Saloon Engine AFN		○	GHA499046	
	1997.03-1999.06	Saloon Engine AFN		○	GWB0529	
2.0 i (85 kW)	1997.03-1999.06	Saloon Engine AFN With ABS		○	GHA228041	K
	1993.02-1999.06	Saloon Engine 2E/AGG	•		GHA422009	K



	 YEAR		F	R	G-AP Ref.	KIT
SEAT						
CORDOBA (6K1, 6K2)						
2.0 i (85 kW)	1993.02-1999.06	Saloon Engine 2E/AGG	•		GHA422036	K
	1993.02-1999.06	Saloon Engine 2E/AGG	•		GWB1358	
	1993.02-1999.06	Saloon Engine 2E/AGG		◦	GHA499014	
	1993.02-1999.06	Saloon Engine 2E/AGG		◦	GHA499015	
	1993.02-1999.06	Saloon Engine 2E/AGG		◦	GHA499045	
	1993.02-1999.06	Saloon Engine 2E/AGG		◦	GHA499046	
	1993.02-1999.06	Saloon Engine 2E/AGG		◦	GWB0529	
	1993.02-1999.06	Saloon Engine 2E/AGG With ABS		◦	GHA228041	K
2.0 i 16V (110 kW)	1996.08-1999.06	Saloon Engine ABF	•		GHA422009	K
	1996.08-1999.06	Saloon Engine ABF	•		GHA422036	K
	1996.08-1999.06	Saloon Engine ABF	•		GWB1358	
	1996.08-1999.06	Saloon Engine ABF		◦	GHA499014	
	1996.08-1999.06	Saloon Engine ABF		◦	GHA499015	
	1996.08-1999.06	Saloon Engine ABF		◦	GHA499046	
	1996.08-1999.06	Saloon Engine ABF With ABS		◦	GWB0529	
1996.08-1999.06	Saloon Engine ABF With ABS		◦	GHA228041	K	
CORDOBA (6K2)						
1.0 (37 kW)	1999.06-2002.10	Hatchback Engine ALD/ANV/AUC	•		GHA422009	K
	1999.06-2002.10	Hatchback Engine ALD/ANV/AUC	•		GHA422036	K
	1999.06-2002.10	Hatchback Engine ALD/ANV/AUC	•		GWB1358	
	1999.06-2002.10	Hatchback Engine ALD/ANV/AUC With ABS		◦	GHA228041	K
1.4 (44 kW)	1999.06-2002.10	Hatchback Engine AKK/ANW/AUD	•		GHA422009	K
	1999.06-2002.10	Hatchback Engine AKK/ANW/AUD	•		GHA422036	K
	1999.06-2002.10	Hatchback Engine AKK/ANW/AUD	•		GWB1358	
	1999.06-2002.10	Hatchback Engine AKK/ANW/AUD With ABS		◦	GHA228041	K
1.4 16V (55 kW)	2000.05-2002.10	Hatchback Engine APE/AUA	•		GHA422009	K
	2000.05-2002.10	Hatchback Engine APE/AUA	•		GHA422036	K
	2000.05-2002.10	Hatchback Engine APE/AUA	•		GWB1358	
	2000.05-2002.10	Hatchback Engine APE/AUA With ABS		◦	GHA228041	K
1.4 16V (74 kW)	2000.02-2002.10	Hatchback Engine AQQ/AUB	•		GHA422009	K
	2000.02-2002.10	Hatchback Engine AQQ/AUB	•		GHA422036	K
	2000.02-2002.10	Hatchback Engine AQQ/AUB	•		GWB1358	
	2000.02-2002.10	Hatchback Engine AQQ/AUB With ABS		◦	GHA228041	K
1.6 (55 kW)	1999.06-2002.10	Hatchback Engine ALM	•		GHA422009	K
	1999.06-2002.10	Hatchback Engine ALM	•		GHA422036	K
	1999.06-2002.10	Hatchback Engine ALM	•		GWB1358	
	1999.06-2002.10	Hatchback Engine ALM		◦	GHA499045	
	1999.06-2002.10	Hatchback Engine ALM		◦	GHA499046	
	1999.06-2002.10	Hatchback Engine ALM With ABS		◦	GHA228041	K
1.6 (74 kW)	1999.06-2002.10	Hatchback Engine AEH/AKL/APF/AUR	•		GHA422009	K
	1999.06-2002.10	Hatchback Engine AEH/AKL/APF/AUR	•		GHA422036	K
	1999.06-2002.10	Hatchback Engine AEH/AKL/APF/AUR	•		GWB1358	
	1999.06-2002.10	Hatchback Engine AEH/AKL/APF/AUR With ABS		◦	GHA228041	K
1.8 T 20V Cupra (115 kW)	2000.07-2002.10	Hatchback Engine AQX/AYP	•		GHA422009	K
	2000.07-2002.10	Hatchback Engine AQX/AYP	•		GHA422036	K
	2000.07-2002.10	Hatchback Engine AQX/AYP	•		GWB1358	
	2000.07-2002.10	Hatchback Engine AQX/AYP With ABS		◦	GHA228041	K
1.9 SDi (50 kW)	1999.06-2002.10	Hatchback Engine AGP/AQM	•		GHA422009	K
	1999.06-2002.10	Hatchback Engine AGP/AQM	•		GHA422036	K
	1999.06-2002.10	Hatchback Engine AGP/AQM	•		GWB1358	
	1999.06-2002.10	Hatchback Engine AGP/AQM With ABS		◦	GHA228041	K
1.9 TDi (66 kW)	1999.06-2002.10	Hatchback Engine AGR/ALH	•		GHA422009	K
	1999.06-2002.10	Hatchback Engine AGR/ALH	•		GHA422036	K
	1999.06-2002.10	Hatchback Engine AGR/ALH	•		GWB1358	
	1999.06-2002.10	Hatchback Engine AGR/ALH With ABS		◦	GHA228041	K
1.9 TDi (81 kW)	1999.06-2002.10	Hatchback Engine ASK/ASV	•		GHA422009	K
	1999.06-2002.10	Hatchback Engine ASK/ASV	•		GHA422036	K
	1999.06-2002.10	Hatchback Engine ASK/ASV	•		GWB1358	
	1999.06-2002.10	Hatchback Engine ASK/ASV With ABS		◦	GHA228041	K
CORDOBA (6L2)						
1.2 (47 kW)	2002.10-2006.06	Saloon Engine AZQ/BME With ABS	•		GHA336001	K
	2002.10-2006.06	Saloon Engine AZQ/BME With ABS		◦	GHA228036	K
	2002.10-2006.06	Saloon Engine AZQ/BME Without ABS	•		GHA336002	
	2002.10-2006.06	Saloon Engine AZQ/BME Without ABS		◦	GHA228037	



	 YEAR		F	R	G-AP Ref.	KIT
SEAT						
CORDOBA (6L2)						
1.2 12V (51 kW)	2006.05-2009.11	Saloon Engine BXV With ABS	•		GHA336001	K
	2006.05-2009.11	Saloon Engine BXV With ABS		◦	GHA228036	K
	2006.05-2009.11	Saloon Engine BXV Without ABS	•		GHA336002	
	2006.05-2009.11	Saloon Engine BXV Without ABS		◦	GHA228037	
1.4 16V (55 kW)	2002.09-2007.12	Saloon Engine BBY/BKY With ABS	•		GHA336001	K
	2002.09-2007.12	Saloon Engine BBY/BKY With ABS		◦	GHA228036	K
	2002.09-2007.12	Saloon Engine BBY/BKY Without ABS	•		GHA336002	
	2002.09-2007.12	Saloon Engine BBY/BKY Without ABS		◦	GHA228037	
1.4 16V (63 kW)	2006.05-2009.11	Saloon Engine BXW With ABS	•		GHA336001	K
	2006.05-2009.11	Saloon Engine BXW With ABS		◦	GHA228036	K
	2006.05-2009.11	Saloon Engine BXW Without ABS	•		GHA336002	
	2006.05-2009.11	Saloon Engine BXW Without ABS		◦	GHA228037	
1.4 16V (74 kW)	2002.10-2009.11	Saloon Engine BBZ/AUB With ABS	•		GHA336001	K
	2002.10-2009.11	Saloon Engine BBZ/AUB With ABS		◦	GHA228036	K
	2002.10-2009.11	Saloon Engine BBZ/AUB Without ABS	•		GHA336002	
	2002.10-2009.11	Saloon Engine BBZ/AUB Without ABS		◦	GHA228037	
1.4 TDi (51 kW)	2005.05-2009.11	Saloon Engine BNM With ABS	•		GHA336001	K
	2005.05-2009.11	Saloon Engine BNM With ABS		◦	GHA228036	K
	2005.05-2009.11	Saloon Engine BNM Without ABS	•		GHA336002	
	2005.05-2009.11	Saloon Engine BNM Without ABS		◦	GHA228037	
1.4 TDi (55 kW)	2002.10-2005.12	Saloon Engine AMF With ABS	•		GHA336001	K
	2002.10-2005.12	Saloon Engine AMF With ABS		◦	GHA228036	K
	2002.10-2005.12	Saloon Engine AMF Without ABS	•		GHA336002	
	2002.10-2005.12	Saloon Engine AMF Without ABS		◦	GHA228037	
1.4 TDi (59 kW)	2005.06-2009.11	Saloon Engine BMS/BNV With ABS	•		GHA336001	K
	2005.06-2009.11	Saloon Engine BMS/BNV With ABS		◦	GHA228036	K
	2005.06-2009.11	Saloon Engine BMS/BNV Without ABS	•		GHA336002	
	2005.06-2009.11	Saloon Engine BMS/BNV Without ABS		◦	GHA228037	
1.6 (74 kW)	2003.04-2009.11	Saloon Engine BAH With ABS	•		GHA336001	K
	2003.04-2009.11	Saloon Engine BAH With ABS		◦	GHA228036	K
	2003.04-2009.11	Saloon Engine BAH Without ABS	•		GHA336002	
	2003.04-2009.11	Saloon Engine BAH Without ABS		◦	GHA228037	
1.6 16V (77 kW)	2006.11-2009.11	Saloon Engine BTS With ABS	•		GHA336001	K
	2006.11-2009.11	Saloon Engine BTS With ABS		◦	GHA228036	K
	2006.11-2009.11	Saloon Engine BTS Without ABS	•		GHA336002	
	2006.11-2009.11	Saloon Engine BTS Without ABS		◦	GHA228037	
1.9 SDi (47 kW)	2002.09-2009.11	Saloon Engine ASY With ABS	•		GHA336001	K
	2002.09-2009.11	Saloon Engine ASY With ABS		◦	GHA228036	K
	2002.09-2009.11	Saloon Engine ASY Without ABS	•		GHA336002	
	2002.09-2009.11	Saloon Engine ASY Without ABS		◦	GHA228037	
1.9 TDi (74 kW)	2002.09-2009.11	Saloon Engine ATD/AXR/BMT With ABS	•		GHA336001	K
	2002.09-2009.11	Saloon Engine ATD/AXR/BMT With ABS		◦	GHA228036	K
	2002.09-2009.11	Saloon Engine ATD/AXR/BMT Without ABS	•		GHA336002	
	2002.09-2009.11	Saloon Engine ATD/AXR/BMT Without ABS		◦	GHA228037	
1.9 TDi (96 kW)	2002.10-2009.11	Saloon Engine ASZ/BLT With ABS	•		GHA336001	K
	2002.10-2009.11	Saloon Engine ASZ/BLT With ABS		◦	GHA228036	K
	2002.10-2009.11	Saloon Engine ASZ/BLT Without ABS	•		GHA336002	
	2002.10-2009.11	Saloon Engine ASZ/BLT Without ABS		◦	GHA228037	
2.0 (85 kW)	2002.09-2009.11	Saloon Engine AZL/BBX With ABS	•		GHA336001	K
	2002.09-2009.11	Saloon Engine AZL/BBX With ABS		◦	GHA228036	K
	2002.09-2009.11	Saloon Engine AZL/BBX Without ABS	•		GHA336002	
	2002.09-2009.11	Saloon Engine AZL/BBX Without ABS		◦	GHA228037	
CORDOBA VARIO (6K5)						
1.4 (44 kW)	1999.06-2002.12	Estate Engine AKK/ANW/AUD	•		GHA422009	K
	1999.06-2002.12	Estate Engine AKK/ANW/AUD	•		GHA422036	K
	1999.06-2002.12	Estate Engine AKK/ANW/AUD	•		GWB1358	
	1999.06-2002.12	Estate Engine AKK/ANW/AUD With ABS		◦	GHA228041	K
1.4 16V (55 kW)	1999.06-2002.12	Estate Engine APE/AUA	•		GHA422009	K
	1999.06-2002.12	Estate Engine APE/AUA	•		GHA422036	K
	1999.06-2002.12	Estate Engine APE/AUA	•		GWB1358	
	1999.06-2002.12	Estate Engine APE/AUA With ABS		◦	GHA228041	K
1.4 i (44 kW)	1996.09-1999.06	Estate Engine AEX/AKV/APQ	•		GHA422009	K
	1996.09-1999.06	Estate Engine AEX/AKV/APQ	•		GHA422036	K
	1996.09-1999.06	Estate Engine AEX/AKV/APQ	•		GWB1358	



	 YEAR		F	R	G-AP Ref.	KIT
SEAT						
CORDOBA VARIO (6K5)						
1.4 i (44 kW)	1996.09-1999.06	Estate Engine AEX/AKV/APQ		o	GHA499044	
	1996.09-1999.06	Estate Engine AEX/AKV/APQ		o	GHA499045	
	1996.09-1999.06	Estate Engine AEX/AKV/APQ		o	GHA499046	
	1996.09-1999.06	Estate Engine AEX/AKV/APQ		o	GWB0529	
	1996.09-1999.06	Estate Engine AEX/AKV/APQ With ABS		o	GHA228041	K
1.6 (55 kW)	1999.06-2002.12	Estate Engine ALM	•		GHA422009	K
	1999.06-2002.12	Estate Engine ALM	•		GHA422036	K
	1999.06-2002.12	Estate Engine ALM	•		GWB1358	
	1999.06-2002.12	Estate Engine ALM		o	GHA499045	
	1999.06-2002.12	Estate Engine ALM		o	GHA499046	
	1999.06-2002.12	Estate Engine ALM With ABS		o	GHA228041	K
1.6 (74 kW)	1999.06-2002.12	Estate Engine AEH/AKL/APF/AUR	•		GHA422009	K
	1999.06-2002.12	Estate Engine AEH/AKL/APF/AUR	•		GHA422036	K
	1999.06-2002.12	Estate Engine AEH/AKL/APF/AUR	•		GWB1358	
	1999.06-2002.12	Estate Engine AEH/AKL/APF/AUR With ABS		o	GHA228041	K
1.6 i (55 kW)	1996.09-1999.06	Estate Engine AEE/ALM	•		GHA422009	K
	1996.09-1999.06	Estate Engine AEE/ALM	•		GHA422036	K
	1996.09-1999.06	Estate Engine AEE/ALM	•		GWB1358	
	1996.09-1999.06	Estate Engine AEE/ALM		o	GHA499045	
	1996.09-1999.06	Estate Engine AEE/ALM		o	GHA499046	
	1996.09-1999.06	Estate Engine AEE/ALM		o	GWB0529	
	1996.09-1999.06	Estate Engine AEE/ALM With ABS		o	GHA228041	K
	1997.05-1999.06	Estate Engine 1F	•		GHA422009	K
	1997.05-1999.06	Estate Engine 1F	•		GHA422036	K
	1997.05-1999.06	Estate Engine 1F	•		GWB1358	
	1997.05-1999.06	Estate Engine 1F		o	GHA499044	
	1997.05-1999.06	Estate Engine 1F		o	GHA499045	
	1997.05-1999.06	Estate Engine 1F		o	GHA499046	
	1997.05-1999.06	Estate Engine 1F		o	GWB0529	
	1997.05-1999.06	Estate Engine 1F With ABS		o	GHA228041	K
	1.6 i (74 kW)	1996.09-1999.06	Estate Engine AFT	•		GHA422009
1996.09-1999.06		Estate Engine AFT	•		GHA422036	K
1996.09-1999.06		Estate Engine AFT	•		GWB1358	
1996.09-1999.06		Estate Engine AFT		o	GHA499045	
1996.09-1999.06		Estate Engine AFT		o	GHA499046	
1996.09-1999.06		Estate Engine AFT		o	GWB0529	
1996.09-1999.06		Estate Engine AFT With ABS		o	GHA228041	K
1.9 SDi (47 kW)	1996.09-1999.06	Estate Engine AEY	•		GHA422009	K
	1996.09-1999.06	Estate Engine AEY	•		GHA422036	K
	1996.09-1999.06	Estate Engine AEY	•		GWB1358	
	1996.09-1999.06	Estate Engine AEY		o	GHA499044	
	1996.09-1999.06	Estate Engine AEY		o	GHA499045	
	1996.09-1999.06	Estate Engine AEY		o	GHA499046	
	1996.09-1999.06	Estate Engine AEY		o	GWB0529	
	1996.09-1999.06	Estate Engine AEY With ABS		o	GHA228041	K
1.9 SDi (50 kW)	1999.06-2002.12	Estate Engine AGP/AQM	•		GHA422009	K
	1999.06-2002.12	Estate Engine AGP/AQM	•		GHA422036	K
	1999.06-2002.12	Estate Engine AGP/AQM	•		GWB1358	
	1999.06-2002.12	Estate Engine AGP/AQM With ABS		o	GHA228041	K
1.9 TDi (66 kW)	1996.08-1999.06	Estate Engine 1Z/AHU	•		GHA422009	K
	1996.08-1999.06	Estate Engine 1Z/AHU	•		GHA422036	K
	1996.08-1999.06	Estate Engine 1Z/AHU	•		GWB1358	
	1996.08-1999.06	Estate Engine 1Z/AHU		o	GHA499045	
	1996.08-1999.06	Estate Engine 1Z/AHU		o	GHA499046	
	1996.08-1999.06	Estate Engine 1Z/AHU		o	GWB0529	
	1996.08-1999.06	Estate Engine 1Z/AHU With ABS		o	GHA228041	K
	1999.06-2002.12	Estate Engine AGR/ALH	•		GHA422009	K
	1999.06-2002.12	Estate Engine AGR/ALH	•		GHA422036	K
	1999.06-2002.12	Estate Engine AGR/ALH With ABS		o	GHA228041	K
1.9 TDi (81 kW)	1997.07-1999.06	Estate Engine AFN	•		GHA422009	K
	1997.07-1999.06	Estate Engine AFN	•		GHA422036	K
	1997.07-1999.06	Estate Engine AFN	•		GWB1358	
	1997.07-1999.06	Estate Engine AFN		o	GHA499014	



	 YEAR		F	R	G-AP Ref.	KIT
SEAT						
CORDOBA VARIO (6K5)						
1.9 TDi (81 kW)	1997.07-1999.06	Estate Engine AFN		o	GHA499015	
	1997.07-1999.06	Estate Engine AFN		o	GHA499046	
	1997.07-1999.06	Estate Engine AFN		o	GWB0529	
	1997.07-1999.06	Estate Engine AFN With ABS		o	GHA228041	K
	1999.06-2002.12	Estate Engine ASK/ASV	•		GHA422009	K
	1999.06-2002.12	Estate Engine ASK/ASV	•		GHA422036	K
	1999.06-2002.12	Estate Engine ASK/ASV	•		GWB1358	
	1999.06-2002.12	Estate Engine ASK/ASV With ABS		o	GHA228041	K
EXEO (3R2)						
1.6 (75 kW)	2009.03-2010.09	Saloon Engine ALZ	•		GHA245010	K
	2009.03-2010.09	Saloon Engine ALZ		o	GHA232014	K
1.8 T (110 kW)	2008.12-2010.05	Saloon Engine CFMA	•		GHA245010	K
	2008.12-2010.05	Saloon Engine CFMA		o	GHA232014	K
1.8 TSi (118 kW)	2010.05-	Saloon Engine CDHB	•		GHA245010	K
	2010.05-	Saloon Engine CDHB		o	GHA232014	K
1.8 TSi (88 kW)	2010.09-	Saloon Engine CDHA	•		GHA245010	K
	2010.09-	Saloon Engine CDHA		o	GHA232014	K
2.0 TDi (105 kW)	2008.12-	Saloon Engine CAGA	•		GHA245010	K
	2008.12-	Saloon Engine CAGA		o	GHA232014	K
2.0 TDi (125 kW)	2009.02-	Saloon Engine CAHA	•		GHA245010	K
	2009.02-	Saloon Engine CAHA		o	GHA232014	K
2.0 TDi (88 kW)	2008.12-	Saloon Engine CAGC	•		GHA245010	K
	2008.12-	Saloon Engine CAGC		o	GHA232014	K
2.0 TFSi (147 kW)	2009.03-	Saloon Engine BWE	•		GHA245010	K
	2009.03-	Saloon Engine BWE		o	GHA232014	K
2.0 TFSi (155 kW)	2010.05-	Saloon Engine CDND	•		GHA245010	K
	2010.05-	Saloon Engine CDND		o	GHA232014	K
EXEO ST (3R5)						
1.6 (75 kW)	2009.06-2010.09	Estate Engine ALZ	•		GHA245010	K
	2009.06-2010.09	Estate Engine ALZ		o	GHA232014	K
1.8 T (110 kW)	2009.06-2010.05	Estate Engine CFMA	•		GHA245010	K
	2009.06-2010.05	Estate Engine CFMA		o	GHA232014	K
1.8 TSi (118 kW)	2010.05-	Estate Engine CDHB	•		GHA245010	K
	2010.05-	Estate Engine CDHB		o	GHA232014	K
1.8 TSi (88 kW)	2010.09-	Estate Engine CDHA	•		GHA245010	K
	2010.09-	Estate Engine CDHA		o	GHA232014	K
2.0 TDi (105 kW)	2009.05-	Estate Engine CAGA/CJCA	•		GHA245010	K
	2009.05-	Estate Engine CAGA/CJCA		o	GHA232014	K
2.0 TDi (125 kW)	2009.05-	Estate Engine CAHA/CGLB	•		GHA245010	K
	2009.05-	Estate Engine CAHA/CGLB		o	GHA232014	K
2.0 TDi (88 kW)	2009.07-	Estate Engine CAGC/CJCC	•		GHA245010	K
	2009.07-	Estate Engine CAGC/CJCC		o	GHA232014	K
2.0 TFSi (147 kW)	2009.06-	Estate Engine BWE	•		GHA245010	K
	2009.06-	Estate Engine BWE		o	GHA232014	K
2.0 TFSi (155 kW)	2010.05-	Estate Engine CDND	•		GHA245010	K
	2010.05-	Estate Engine CDND		o	GHA232014	K
IBIZA (021A)						
0.9 (29 kW)	1990.08-1993.05	Hatchback Engine 09NCA/146A000	•		GWB1410	
	1990.08-1993.05	Hatchback Engine 09NCA/146A000		o	GHA230002	F
1.7 (72 kW)	1991.01-1993.05	Hatchback Engine 021A.3000	•		GWB1410	
	1991.01-1993.05	Hatchback Engine 021A.3000		o	GHA230002	F
1.7 (76 kW)	1991.01-1993.05	Hatchback Engine 021B.3000	•		GWB1410	
	1991.01-1993.05	Hatchback Engine 021B.3000		o	GHA230002	F
1.7 D (42 kW)	1990.08-1993.05	Hatchback Engine 022A.5000	•		GWB1410	
	1990.08-1993.05	Hatchback Engine 022A.5000		o	GHA230002	F
IBIZA II (6K1)						
1.0 (33 kW)	1993.03-1996.09	Hatchback Engine AAU	•		GHA422036	K
	1993.03-1996.09	Hatchback Engine AAU	•		GWB1358	
	1993.03-1996.09	Hatchback Engine AAU		o	GHA499044	
	1993.03-1996.09	Hatchback Engine AAU		o	GHA499045	
	1993.03-1996.09	Hatchback Engine AAU		o	GWB0529	
1.0 i (37 kW)	1996.09-1999.08	Hatchback Engine AER	•		GHA422036	K
	1996.09-1999.08	Hatchback Engine AER	•		GWB1358	
	1996.09-1999.08	Hatchback Engine AER		o	GHA499045	



	 YEAR		F	R	G-AP Ref.	KIT
SEAT						
IBIZA II (6K1)						
1.0 i (37 kW)	1996.09-1999.08	Hatchback Engine AER		o	GHA499046	
	1996.09-1999.08	Hatchback Engine AER		o	GWB0529	
	1996.09-1999.08	Hatchback Engine AER With ABS		o	GHA228041	K
1.3 i (40 kW)	1993.03-1999.08	Hatchback Engine 2G/AAV	•		GHA422036	K
	1993.03-1999.08	Hatchback Engine 2G/AAV	•		GWB1358	
	1993.03-1999.08	Hatchback Engine 2G/AAV		o	GHA499044	
	1993.03-1999.08	Hatchback Engine 2G/AAV		o	GHA499045	
	1993.03-1999.08	Hatchback Engine 2G/AAV		o	GWB0529	
	1993.03-1999.08	Hatchback Engine 2G/AAV With ABS		o	GHA228041	K
1.4 (40 kW)	1997.12-1999.04	Hatchback Engine ANX	•		GHA422036	K
	1997.12-1999.04	Hatchback Engine ANX	•		GWB1358	
	1997.12-1999.04	Hatchback Engine ANX		o	GWB0529	
1.4 i (44 kW)	1993.09-1999.08	Hatchback Engine ABD/AEX/AKV/APQ	•		GHA422036	K
	1993.09-1999.08	Hatchback Engine ABD/AEX/AKV/APQ	•		GWB1358	
	1993.09-1999.08	Hatchback Engine ABD/AEX/AKV/APQ		o	GHA499044	
	1993.09-1999.08	Hatchback Engine ABD/AEX/AKV/APQ		o	GHA499045	
	1993.09-1999.08	Hatchback Engine ABD/AEX/AKV/APQ		o	GHA499046	
	1993.09-1999.08	Hatchback Engine ABD/AEX/AKV/APQ		o	GWB0529	
	1993.09-1999.08	Hatchback Engine ABD/AEX/AKV/APQ With ABS		o	GHA228041	K
1.4 i 16V (74 kW)	1997.06-1999.08	Hatchback Engine AFH	•		GHA422036	K
	1997.06-1999.08	Hatchback Engine AFH	•		GWB1358	
	1997.06-1999.08	Hatchback Engine AFH		o	GHA499045	
	1997.06-1999.08	Hatchback Engine AFH		o	GHA499046	
	1997.06-1999.08	Hatchback Engine AFH		o	GWB0529	
	1997.06-1999.08	Hatchback Engine AFH With ABS		o	GHA228041	K
1.6 i (55 kW)	1993.03-1999.08	Hatchback Engine ABU/AEE/ALM	•		GHA422036	K
	1993.03-1999.08	Hatchback Engine ABU/AEE/ALM	•		GWB1358	
	1993.03-1999.08	Hatchback Engine ABU/AEE/ALM		o	GHA499044	
	1993.03-1999.08	Hatchback Engine ABU/AEE/ALM		o	GHA499045	
	1993.03-1999.08	Hatchback Engine ABU/AEE/ALM		o	GHA499046	
	1993.03-1999.08	Hatchback Engine ABU/AEE/ALM		o	GWB0529	
	1993.03-1999.08	Hatchback Engine ABU/AEE/ALM With ABS		o	GHA228041	K
	1994.09-1999.06	Hatchback Engine 1F	•		GHA422036	K
	1994.09-1999.06	Hatchback Engine 1F	•		GWB1358	
	1994.09-1999.06	Hatchback Engine 1F		o	GHA499044	
	1994.09-1999.06	Hatchback Engine 1F		o	GHA499045	
	1994.09-1999.06	Hatchback Engine 1F		o	GHA499046	
	1994.09-1999.06	Hatchback Engine 1F		o	GWB0529	
	1994.09-1999.06	Hatchback Engine 1F With ABS		o	GHA228041	K
1.6 i (74 kW)	1996.04-1999.08	Hatchback Engine AFT	•		GHA422036	K
	1996.04-1999.08	Hatchback Engine AFT	•		GWB1358	
	1996.04-1999.08	Hatchback Engine AFT		o	GHA499045	
	1996.04-1999.08	Hatchback Engine AFT		o	GHA499046	
	1996.04-1999.08	Hatchback Engine AFT		o	GWB0529	
	1996.04-1999.08	Hatchback Engine AFT With ABS		o	GHA228041	K
1.8 i (66 kW)	1993.03-1999.08	Hatchback Engine ABS/ADZ	•		GHA422036	K
	1993.03-1999.08	Hatchback Engine ABS/ADZ	•		GWB1358	
	1993.03-1999.08	Hatchback Engine ABS/ADZ		o	GHA499044	
	1993.03-1999.08	Hatchback Engine ABS/ADZ		o	GHA499045	
	1993.03-1999.08	Hatchback Engine ABS/ADZ		o	GHA499046	
	1993.03-1999.08	Hatchback Engine ABS/ADZ		o	GWB0529	
1.8 i 16V (95 kW)	1993.11-1996.08	Hatchback Engine ADL	•		GHA422036	K
	1993.11-1996.08	Hatchback Engine ADL	•		GWB1358	
	1993.11-1996.08	Hatchback Engine ADL		o	GHA499014	
	1993.11-1996.08	Hatchback Engine ADL		o	GHA499015	
	1993.11-1996.08	Hatchback Engine ADL		o	GHA499045	
	1993.11-1996.08	Hatchback Engine ADL		o	GWB0529	
	1993.11-1996.08	Hatchback Engine ADL		o	GWB0529	
1.9 D (47 kW)	1993.04-1996.08	Hatchback Engine 1Y	•		GHA422036	K
	1993.04-1996.08	Hatchback Engine 1Y	•		GWB1358	
	1993.04-1996.08	Hatchback Engine 1Y		o	GHA499044	
	1993.04-1996.08	Hatchback Engine 1Y		o	GHA499045	
	1993.04-1996.08	Hatchback Engine 1Y		o	GHA499046	
	1993.04-1996.08	Hatchback Engine 1Y		o	GWB0529	



	 YEAR		F	R	G-AP Ref.	KIT
SEAT						
IBIZA II (6K1)						
1.9 D (50 kW)	1994.10-1996.08	Hatchback Engine 1Y	•		GWB1358	
	1994.10-1996.08	Hatchback Engine 1Y		○	GHA499046	
	1994.10-1996.08	Hatchback Engine 1Y		○	GWB0529	
1.9 SDi (47 kW)	1996.08-1999.08	Hatchback Engine AEY	•		GHA422036	K
	1996.08-1999.08	Hatchback Engine AEY	•		GWB1358	
	1996.08-1999.08	Hatchback Engine AEY		○	GHA499044	
	1996.08-1999.08	Hatchback Engine AEY		○	GHA499045	
	1996.08-1999.08	Hatchback Engine AEY		○	GHA499046	
	1996.08-1999.08	Hatchback Engine AEY		○	GWB0529	
	1996.08-1999.08	Hatchback Engine AEY With ABS		○	GHA228041	K
1.9 TD (55 kW)	1993.03-1996.08	Hatchback Engine AAZ	•		GHA422036	K
	1993.03-1996.08	Hatchback Engine AAZ	•		GWB1358	
	1993.03-1996.08	Hatchback Engine AAZ		○	GHA499044	
	1993.03-1996.08	Hatchback Engine AAZ		○	GHA499045	
	1993.03-1996.08	Hatchback Engine AAZ		○	GHA499046	
	1993.03-1996.08	Hatchback Engine AAZ		○	GWB0529	
1.9 TDi (66 kW)	1996.08-1999.08	Hatchback Engine 1Z/AHU	•		GHA422036	K
	1996.08-1999.08	Hatchback Engine 1Z/AHU	•		GWB1358	
	1996.08-1999.08	Hatchback Engine 1Z/AHU		○	GHA499045	
	1996.08-1999.08	Hatchback Engine 1Z/AHU		○	GHA499046	
	1996.08-1999.08	Hatchback Engine 1Z/AHU		○	GWB0529	
	1996.08-1999.08	Hatchback Engine 1Z/AHU With ABS		○	GHA228041	K
1.9 TDi (81 kW)	1997.02-1999.08	Hatchback Engine AFN	•		GHA422036	K
	1997.02-1999.08	Hatchback Engine AFN	•		GWB1358	
	1997.02-1999.08	Hatchback Engine AFN		○	GHA499014	
	1997.02-1999.08	Hatchback Engine AFN		○	GHA499015	
	1997.02-1999.08	Hatchback Engine AFN		○	GHA499046	
	1997.02-1999.08	Hatchback Engine AFN		○	GWB0529	
	1997.02-1999.08	Hatchback Engine AFN With ABS		○	GHA228041	K
2.0 i (85 kW)	1993.03-1999.08	Hatchback Engine 2E/AGG	•		GHA422036	K
	1993.03-1999.08	Hatchback Engine 2E/AGG	•		GWB1358	
	1993.03-1999.08	Hatchback Engine 2E/AGG		○	GHA499014	
	1993.03-1999.08	Hatchback Engine 2E/AGG		○	GHA499015	
	1993.03-1999.08	Hatchback Engine 2E/AGG		○	GHA499045	
	1993.03-1999.08	Hatchback Engine 2E/AGG		○	GHA499046	
	1993.03-1999.08	Hatchback Engine 2E/AGG		○	GWB0529	
	1993.03-1999.08	Hatchback Engine 2E/AGG With ABS		○	GHA228041	K
2.0 i 16V (110 kW)	1996.08-1999.08	Hatchback Engine ABF	•		GHA422036	K
	1996.08-1999.08	Hatchback Engine ABF	•		GWB1358	
	1996.08-1999.08	Hatchback Engine ABF		○	GHA499014	
	1996.08-1999.08	Hatchback Engine ABF		○	GHA499015	
	1996.08-1999.08	Hatchback Engine ABF		○	GHA499046	
	1996.08-1999.08	Hatchback Engine ABF		○	GWB0529	
	1996.08-1999.08	Hatchback Engine ABF With ABS		○	GHA228041	K
IBIZA III (6K1)						
1.0 (37 kW)	1999.08-2002.02	Hatchback Engine ALD/ANV/AUC	•		GHA422036	K
	1999.08-2002.02	Hatchback Engine ALD/ANV/AUC	•		GWB1358	
	1999.08-2002.02	Hatchback Engine ALD/ANV/AUC With ABS		○	GHA228041	K
1.0 16V (51 kW)	1999.10-2002.02	Hatchback Engine AST/AVZ	•		GHA422036	K
	1999.10-2002.02	Hatchback Engine AST/AVZ	•		GWB1358	
	1999.10-2002.02	Hatchback Engine AST/AVZ With ABS		○	GHA228041	K
1.4 (44 kW)	1999.08-2002.02	Hatchback Engine AKK/ANW/AUD	•		GHA422036	K
	1999.08-2002.02	Hatchback Engine AKK/ANW/AUD	•		GWB1358	
	1999.08-2002.02	Hatchback Engine AKK/ANW/AUD With ABS		○	GHA228041	K
1.4 16V (55 kW)	2000.05-2002.02	Hatchback Engine APE/AUA	•		GHA422036	K
	2000.05-2002.02	Hatchback Engine APE/AUA	•		GWB1358	
	2000.05-2002.02	Hatchback Engine APE/AUA With ABS		○	GHA228041	K
1.4 16V (74 kW)	1999.08-2002.02	Hatchback Engine AQQ/AUB	•		GHA422036	K
	1999.08-2002.02	Hatchback Engine AQQ/AUB	•		GWB1358	
	1999.08-2002.02	Hatchback Engine AQQ/AUB With ABS		○	GHA228041	K
1.6 (55 kW)	1999.08-2002.02	Hatchback Engine ALM	•		GHA422036	K
	1999.08-2002.02	Hatchback Engine ALM	•		GWB1358	
	1999.08-2002.02	Hatchback Engine ALM		○	GHA499046	
	1999.08-2002.02	Hatchback Engine ALM With ABS		○	GHA228041	K



	 YEAR		F	R	G-AP Ref.	KIT
SEAT						
IBIZA III (6K1)						
1.6 (74 kW)	1999.08-2002.02	Hatchback Engine AEH/AKL/APF/AUR	•		GHA422036	K
	1999.08-2002.02	Hatchback Engine AEH/AKL/APF/AUR	•		GWB1358	
	1999.08-2002.02	Hatchback Engine AEH/AKL/APF/AUR With ABS		◦	GHA228041	K
1.8 T 20V Cupra (115 kW)	2000.07-2002.02	Hatchback Engine AQX/AYP	•		GHA422036	K
	2000.07-2002.02	Hatchback Engine AQX/AYP	•		GWB1358	
	2000.07-2002.02	Hatchback Engine AQX/AYP With ABS		◦	GHA228041	K
1.9 SDi (50 kW)	1999.08-2002.02	Hatchback Engine AGP/AQM	•		GHA422036	K
	1999.08-2002.02	Hatchback Engine AGP/AQM	•		GWB1358	
	1999.08-2002.02	Hatchback Engine AGP/AQM With ABS		◦	GHA228041	K
1.9 TDi (66 kW)	1999.08-2002.02	Hatchback Engine AGR/ALH	•		GHA422036	K
	1999.08-2002.02	Hatchback Engine AGR/ALH	•		GWB1358	
	1999.08-2002.02	Hatchback Engine AGR/ALH With ABS		◦	GHA228041	K
1.9 TDi (81 kW)	1999.08-2002.02	Hatchback Engine ASK/ASV	•		GHA422036	K
	1999.08-2002.02	Hatchback Engine ASK/ASV	•		GWB1358	
	1999.08-2002.02	Hatchback Engine ASK/ASV With ABS		◦	GHA228041	K
IBIZA IV (6L1)						
1.2 (44 kW)	2007.06-2008.05	Hatchback Engine BBM With ABS	•		GHA336001	K
	2007.06-2008.05	Hatchback Engine BBM With ABS		◦	GHA228036	K
	2007.06-2008.05	Hatchback Engine BBM Without ABS	•		GHA336002	
	2007.06-2008.05	Hatchback Engine BBM Without ABS		◦	GHA228037	
1.2 (47 kW)	2002.02-2006.06	Hatchback Engine AZQ/BME With ABS	•		GHA336001	K
	2002.02-2006.06	Hatchback Engine AZQ/BME With ABS		◦	GHA228036	K
	2002.02-2006.06	Hatchback Engine AZQ/BME Without ABS	•		GHA336002	
1.2 12V (51 kW)	2002.02-2006.06	Hatchback Engine AZQ/BME Without ABS		◦	GHA228037	
	2006.07-2007.07	Hatchback Engine BXV With ABS	•		GHA336001	K
	2006.07-2007.07	Hatchback Engine BXV With ABS		◦	GHA228036	K
	2006.07-2007.07	Hatchback Engine BXV Without ABS	•		GHA336002	
1.4 16V (55 kW)	2006.07-2007.07	Hatchback Engine BXV Without ABS		◦	GHA228037	
	2002.02-2007.12	Hatchback Engine BBY/BKY With ABS	•		GHA336001	K
	2002.02-2007.12	Hatchback Engine BBY/BKY With ABS		◦	GHA228036	K
	2002.02-2007.12	Hatchback Engine BBY/BKY Without ABS	•		GHA336002	
1.4 16V (63 kW)	2002.02-2007.12	Hatchback Engine BBY/BKY Without ABS		◦	GHA228037	
	2006.12-2007.07	Hatchback Engine BXW With ABS	•		GHA336001	K
	2006.12-2007.07	Hatchback Engine BXW With ABS		◦	GHA228036	K
	2006.12-2007.07	Hatchback Engine BXW Without ABS	•		GHA336002	
1.4 16V (74 kW)	2006.12-2007.07	Hatchback Engine BXW Without ABS		◦	GHA228037	
	2002.02-2009.11	Hatchback Engine AUB/BBZ With ABS	•		GHA336001	K
	2002.02-2009.11	Hatchback Engine AUB/BBZ With ABS		◦	GHA228036	K
	2002.02-2009.11	Hatchback Engine AUB/BBZ Without ABS	•		GHA336002	
1.4 TDi (51 kW)	2002.02-2009.11	Hatchback Engine AUB/BBZ Without ABS		◦	GHA228037	
	2005.05-2009.11	Hatchback Engine BNM With ABS	•		GHA336001	K
	2005.05-2009.11	Hatchback Engine BNM With ABS		◦	GHA228036	K
	2005.05-2009.11	Hatchback Engine BNM Without ABS	•		GHA336002	
1.4 TDi (55 kW)	2005.05-2009.11	Hatchback Engine BNM Without ABS		◦	GHA228037	
	2002.05-2005.12	Hatchback Engine AMF With ABS	•		GHA336001	K
	2002.05-2005.12	Hatchback Engine AMF With ABS		◦	GHA228036	K
	2002.05-2005.12	Hatchback Engine AMF Without ABS	•		GHA336002	
1.4 TDi (59 kW)	2002.05-2005.12	Hatchback Engine AMF Without ABS		◦	GHA228037	
	2006.02-2007.07	Hatchback Engine BMS/BNV With ABS	•		GHA336001	K
	2006.02-2007.07	Hatchback Engine BMS/BNV With ABS		◦	GHA228036	K
	2006.02-2007.07	Hatchback Engine BMS/BNV Without ABS	•		GHA336002	
1.6 (74 kW)	2006.02-2007.07	Hatchback Engine BMS/BNV Without ABS		◦	GHA228037	
	2003.02-2009.11	Hatchback Engine BAH With ABS	•		GHA336001	K
	2003.02-2009.11	Hatchback Engine BAH With ABS		◦	GHA228036	K
	2003.02-2009.11	Hatchback Engine BAH Without ABS	•		GHA336002	
1.6 16V (77 kW)	2003.02-2009.11	Hatchback Engine BAH Without ABS		◦	GHA228037	
	2006.11-2009.11	Hatchback Engine BTS With ABS	•		GHA336001	K
	2006.11-2009.11	Hatchback Engine BTS With ABS		◦	GHA228036	K
	2006.11-2009.11	Hatchback Engine BTS Without ABS	•		GHA336002	
1.8 T Cupra R (132 kW)	2006.11-2009.11	Hatchback Engine BTS Without ABS		◦	GHA228037	
	2004.01-2008.02	Hatchback Engine BBU With ABS	•		GHA336001	K
	2004.01-2008.02	Hatchback Engine BBU With ABS		◦	GHA228036	K
	2004.01-2008.02	Hatchback Engine BBU Without ABS	•		GHA336002	
	2004.01-2008.02	Hatchback Engine BBU Without ABS		◦	GHA228037	



	 YEAR		F	R	G-AP Ref.	KIT
SEAT						
IBIZA IV (6L1)						
1.8 T FR (110 kW)	2003.12-2008.05	Hatchback Engine BJX/BKV With ABS	•		GHA336001	K
	2003.12-2008.05	Hatchback Engine BJX/BKV With ABS		◦	GHA228036	K
	2003.12-2008.05	Hatchback Engine BJX/BKV Without ABS	•		GHA336002	
	2003.12-2008.05	Hatchback Engine BJX/BKV Without ABS		◦	GHA228037	
1.9 SDi (47 kW)	2002.02-2005.12	Hatchback Engine ASY With ABS	•		GHA336001	K
	2002.02-2005.12	Hatchback Engine ASY With ABS		◦	GHA228036	K
	2002.02-2005.12	Hatchback Engine ASY Without ABS	•		GHA336002	
	2002.02-2005.12	Hatchback Engine ASY Without ABS		◦	GHA228037	
1.9 TDi (74 kW)	2002.02-2009.11	Hatchback Engine ATD/AXR/BMT With ABS	•		GHA336001	K
	2002.02-2009.11	Hatchback Engine ATD/AXR/BMT With ABS		◦	GHA228036	K
	2002.02-2009.11	Hatchback Engine ATD/AXR/BMT Without ABS	•		GHA336002	
	2002.02-2009.11	Hatchback Engine ATD/AXR/BMT Without ABS		◦	GHA228037	
1.9 TDi (96 kW)	2002.02-2009.11	Hatchback Engine ASZ/BLT With ABS	•		GHA336001	K
	2002.02-2009.11	Hatchback Engine ASZ/BLT With ABS		◦	GHA228036	K
	2002.02-2009.11	Hatchback Engine ASZ/BLT Without ABS	•		GHA336002	
	2002.02-2009.11	Hatchback Engine ASZ/BLT Without ABS		◦	GHA228037	
1.9 TDi Cupra R (118 kW)	2004.03-2008.02	Hatchback Engine BPX/BUK With ABS	•		GHA336001	K
	2004.03-2008.02	Hatchback Engine BPX/BUK With ABS		◦	GHA228036	K
	2004.03-2008.02	Hatchback Engine BPX/BUK Without ABS	•		GHA336002	
	2004.03-2008.02	Hatchback Engine BPX/BUK Without ABS		◦	GHA228037	
2.0 (85 kW)	2003.05-2004.06	Hatchback Engine AZL/BBX With ABS	•		GHA336001	K
	2003.05-2004.06	Hatchback Engine AZL/BBX With ABS		◦	GHA228036	K
	2003.05-2004.06	Hatchback Engine AZL/BBX Without ABS	•		GHA336002	
	2003.05-2004.06	Hatchback Engine AZL/BBX Without ABS		◦	GHA228037	
IBIZA V (6J5)						
1.2 (44 kW)	2009.07-	Hatchback Engine CGPB With ABS	•		GHA336001	K
	2009.07-	Hatchback Engine CGPB With ABS		◦	GHA228036	K
	2009.07-	Hatchback Engine CGPB Without ABS	•		GHA336002	
1.2 (51 kW)	2008.03-	Hatchback Engine BZG/CGPA/CJLB With ABS	•		GHA336001	K
	2008.03-	Hatchback Engine BZG/CGPA/CJLB With ABS		◦	GHA228036	K
	2008.03-	Hatchback Engine BZG/CGPA/CJLB Without ABS	•		GHA336002	
	2008.03-	Hatchback Engine BZG/CGPA/CJLB Without ABS		◦	GHA228037	
1.2 TDi (55 kW)	2010.05-	Hatchback Engine CFWA With ABS	•		GHA336001	K
	2010.05-	Hatchback Engine CFWA With ABS		◦	GHA228036	K
	2010.05-	Hatchback Engine CFWA Without ABS	•		GHA336002	
	2010.05-	Hatchback Engine CFWA Without ABS		◦	GHA228037	
1.2 TSi (63 kW)	2012.08-	Hatchback Engine CBZA With ABS	•		GHA336001	K
	2012.08-	Hatchback Engine CBZA With ABS		◦	GHA228036	K
1.2 TSi (77 kW)	2010.09-	Hatchback Engine CBZB With ABS	•		GHA336001	K
	2010.09-	Hatchback Engine CBZB With ABS		◦	GHA228036	K
	2010.09-	Hatchback Engine CBZB Without ABS	•		GHA336002	
1.4 (63 kW)	2008.03-	Hatchback Engine BXW/CGGB With ABS	•		GHA336001	K
	2008.03-	Hatchback Engine BXW/CGGB With ABS		◦	GHA228036	K
	2008.03-	Hatchback Engine BXW/CGGB Without ABS	•		GHA336002	
	2008.03-	Hatchback Engine BXW/CGGB Without ABS		◦	GHA228037	
1.4 TDi (59 kW)	2008.07-2010.06	Hatchback Engine BMS With ABS	•		GHA336001	K
	2008.07-2010.06	Hatchback Engine BMS With ABS		◦	GHA228036	K
	2008.07-2010.06	Hatchback Engine BMS Without ABS	•		GHA336002	
	2008.07-2010.06	Hatchback Engine BMS Without ABS		◦	GHA228037	
1.4 TSi (103 kW)	2013.10-	Hatchback Engine CPTA With ABS	•		GHA336001	K
	2013.10-	Hatchback Engine CPTA With ABS		◦	GHA228036	K
1.4 TSi (110 kW)	2009.06-	Hatchback Engine CAVF/CNUB/CTHF/CTJB With ABS	•		GHA336001	K
	2009.06-	Hatchback Engine CAVF/CNUB/CTHF/CTJB With ABS		◦	GHA228036	K
	2009.06-	Hatchback Engine CAVF/CNUB/CTHF/CTJB Without ABS	•		GHA336002	
	2009.06-	Hatchback Engine CAVF/CNUB/CTHF/CTJB Without ABS		◦	GHA228037	
1.6 (77 kW)	2008.05-	Hatchback Engine BTS With ABS	•		GHA336001	K
	2008.05-	Hatchback Engine BTS With ABS		◦	GHA228036	K
	2008.05-	Hatchback Engine BTS Without ABS	•		GHA336002	
	2008.05-	Hatchback Engine BTS Without ABS		◦	GHA228037	
1.6 LPG (60 kW)	2011.05-	Hatchback Engine CNKA With ABS	•		GHA336001	K
	2011.05-	Hatchback Engine CNKA With ABS		◦	GHA228036	K
	2011.05-	Hatchback Engine CNKA Without ABS	•		GHA336002	
1.6 TDi (55 kW)	2010.05-2010.06	Hatchback Engine CAYA Without ABS	•		GHA336002	
1.6 TDi (66 kW)	2009.05-	Hatchback Engine CAYB With ABS	•		GHA336001	K



	 YEAR		F	R	G-AP Ref.	KIT
SEAT						
IBIZA V (6J5)						
1.6 TDi (66 kW)	2009.05-	Hatchback Engine CAYB With ABS		o	GHA228036	K
	2009.05-	Hatchback Engine CAYB Without ABS	•		GHA336002	
	2009.05-	Hatchback Engine CAYB Without ABS		o	GHA228037	
1.6 TDi (77 kW)	2009.05-	Hatchback Engine CAYC With ABS	•		GHA336001	K
	2009.05-	Hatchback Engine CAYC With ABS		o	GHA228036	K
	2009.05-	Hatchback Engine CAYC Without ABS	•		GHA336002	
	2009.05-	Hatchback Engine CAYC Without ABS		o	GHA228037	
1.9 TDi (66 kW)	2008.07-2010.06	Hatchback Engine BXJ With ABS	•		GHA336001	K
	2008.07-2010.06	Hatchback Engine BXJ With ABS		o	GHA228036	K
	2008.07-2010.06	Hatchback Engine BXJ Without ABS	•		GHA336002	
	2008.07-2010.06	Hatchback Engine BXJ Without ABS		o	GHA228037	
1.9 TDi (77 kW)	2008.03-2010.06	Hatchback Engine BLS With ABS	•		GHA336001	K
	2008.03-2010.06	Hatchback Engine BLS With ABS		o	GHA228036	K
	2008.03-2010.06	Hatchback Engine BLS Without ABS	•		GHA336002	
	2008.03-2010.06	Hatchback Engine BLS Without ABS		o	GHA228037	
2.0 (85 kW)	2008.10-	Hatchback Engine CEKA With ABS	•		GHA336001	K
	2008.10-	Hatchback Engine CEKA With ABS		o	GHA228036	K
	2008.10-	Hatchback Engine CEKA Without ABS	•		GHA336002	
2.0 TDi (105 kW)	2010.01-	Hatchback Engine CFHD With ABS	•		GHA336001	K
	2010.01-	Hatchback Engine CFHD With ABS		o	GHA228036	K
	2010.01-	Hatchback Engine CFHD Without ABS	•		GHA336002	
	2010.01-	Hatchback Engine CFHD Without ABS		o	GHA228037	
IBIZA V (6J5, 6P1)						
1.0 (55 kW)	2015.05-	Hatchback Engine CHYB With ABS	•		GHA336001	K
	2015.05-	Hatchback Engine CHYB With ABS		o	GHA228036	K
1.0 TSi (70 kW)	2015.05-	Hatchback Engine CHZB With ABS	•		GHA336001	K
	2015.05-	Hatchback Engine CHZB With ABS		o	GHA228036	K
1.0 TSi (81 kW)	2015.05-	Hatchback Engine CHZC With ABS	•		GHA336001	K
	2015.05-	Hatchback Engine CHZC With ABS		o	GHA228036	K
1.2 TSi (66 kW)	2015.05-	Hatchback Engine CJZC With ABS	•		GHA336001	K
	2015.05-	Hatchback Engine CJZC With ABS		o	GHA228036	K
1.2 TSi (81 kW)	2015.09-	Hatchback Engine CJZD With ABS	•		GHA336001	K
	2015.09-	Hatchback Engine CJZD With ABS		o	GHA228036	K
1.4 TDi (55 kW)	2015.05-	Hatchback Engine CUSA With ABS	•		GHA336001	K
	2015.05-	Hatchback Engine CUSA With ABS		o	GHA228036	K
1.4 TDi (66 kW)	2015.05-	Hatchback Engine CUSB With ABS	•		GHA336001	K
	2015.05-	Hatchback Engine CUSB With ABS		o	GHA228036	K
1.4 TDi (77 kW)	2015.05-	Hatchback Engine CUTA With ABS	•		GHA336001	K
	2015.05-	Hatchback Engine CUTA With ABS		o	GHA228036	K
IBIZA V SPORTCOUPE (6J1)						
1.2 (44 kW)	2009.07-	Coupe Engine CGPB With ABS	•		GHA336001	K
	2009.07-	Coupe Engine CGPB With ABS		o	GHA228036	K
	2009.07-	Coupe Engine CGPB Without ABS	•		GHA336002	
	2009.07-	Coupe Engine CGPB Without ABS		o	GHA228037	
1.2 (51 kW)	2008.07-	Coupe Engine BZG/CGPA/CJLB With ABS	•		GHA336001	K
	2008.07-	Coupe Engine BZG/CGPA/CJLB With ABS		o	GHA228036	K
	2008.07-	Coupe Engine BZG/CGPA/CJLB Without ABS	•		GHA336002	
	2008.07-	Coupe Engine BZG/CGPA/CJLB Without ABS		o	GHA228037	
1.2 TDi (55 kW)	2010.05-	Coupe Engine CFWA With ABS	•		GHA336001	K
	2010.05-	Coupe Engine CFWA With ABS		o	GHA228036	K
	2010.05-	Coupe Engine CFWA Without ABS	•		GHA336002	
1.2 TSi (63 kW)	2012.08-	Coupe Engine CBZA With ABS	•		GHA336001	K
	2012.08-	Coupe Engine CBZA With ABS		o	GHA228036	K
1.2 TSi (77 kW)	2010.09-	Coupe Engine CBZB With ABS	•		GHA336001	K
	2010.09-	Coupe Engine CBZB With ABS		o	GHA228036	K
1.4 (63 kW)	2008.07-	Coupe Engine BXW/CGGB With ABS	•		GHA336001	K
	2008.07-	Coupe Engine BXW/CGGB With ABS		o	GHA228036	K
	2008.07-	Coupe Engine BXW/CGGB Without ABS	•		GHA336002	
	2008.07-	Coupe Engine BXW/CGGB Without ABS		o	GHA228037	
1.4 TDi (59 kW)	2008.07-2010.06	Coupe Engine BMS With ABS	•		GHA336001	K
	2008.07-2010.06	Coupe Engine BMS With ABS		o	GHA228036	K
	2008.07-2010.06	Coupe Engine BMS Without ABS	•		GHA336002	
	2008.07-2010.06	Coupe Engine BMS Without ABS		o	GHA228037	
1.4 TSi (103 kW)	2013.10-	Coupe Engine CPTA With ABS	•		GHA336001	K



	 YEAR		F	R	G-AP Ref.	KIT
SEAT						
IBIZA V SPORTCOUPE (6J1)						
1.4 TSi (103 kW)	2013.10-	Coupe Engine CPTA With ABS		o	GHA228036	K
1.4 TSi (110 kW)	2009.06-	Coupe Engine CAVF/CNUB/CTHF/CTJB With ABS	•		GHA336001	K
	2009.06-	Coupe Engine CAVF/CNUB/CTHF/CTJB With ABS		o	GHA228036	K
	2009.06-	Coupe Engine CAVF/CNUB/CTHF/CTJB Without ABS	•		GHA336002	
	2009.06-	Coupe Engine CAVF/CNUB/CTHF/CTJB Without ABS		o	GHA228037	
1.4 TSi Cupra (132 kW)	2009.06-	Coupe Engine CAVE/CTHE/CTJC With ABS	•		GHA336001	K
	2009.06-	Coupe Engine CAVE/CTHE/CTJC With ABS		o	GHA228036	K
	2009.06-	Coupe Engine CAVE/CTHE/CTJC Without ABS	•		GHA336002	
	2009.06-	Coupe Engine CAVE/CTHE/CTJC Without ABS		o	GHA228037	
1.6 (77 kW)	2008.07-	Coupe Engine BTS With ABS	•		GHA336001	K
	2008.07-	Coupe Engine BTS With ABS		o	GHA228036	K
	2008.07-	Coupe Engine BTS Without ABS	•		GHA336002	
	2008.07-	Coupe Engine BTS Without ABS		o	GHA228037	
1.6 LPG (60 kW)	2011.05-	Coupe Engine CNKA With ABS	•		GHA336001	K
	2011.05-	Coupe Engine CNKA With ABS		o	GHA228036	K
	2011.05-	Coupe Engine CNKA Without ABS	•		GHA336002	
1.6 TDi (55 kW)	2010.05-2010.06	Coupe Engine CAYA Without ABS	•		GHA336002	
1.6 TDi (66 kW)	2009.05-	Coupe Engine CAYB With ABS	•		GHA336001	K
	2009.05-	Coupe Engine CAYB With ABS		o	GHA228036	K
	2009.05-	Coupe Engine CAYB Without ABS	•		GHA336002	
	2009.05-	Coupe Engine CAYB Without ABS		o	GHA228037	
1.6 TDi (77 kW)	2009.05-	Coupe Engine CAYC/CLNA With ABS	•		GHA336001	K
	2009.05-	Coupe Engine CAYC/CLNA With ABS		o	GHA228036	K
	2009.05-	Coupe Engine CAYC/CLNA Without ABS	•		GHA336002	
	2009.05-	Coupe Engine CAYC/CLNA Without ABS		o	GHA228037	
1.9 TDi (66 kW)	2008.07-2010.06	Coupe Engine BXJ With ABS	•		GHA336001	K
	2008.07-2010.06	Coupe Engine BXJ With ABS		o	GHA228036	K
	2008.07-2010.06	Coupe Engine BXJ Without ABS	•		GHA336002	
	2008.07-2010.06	Coupe Engine BXJ Without ABS		o	GHA228037	
1.9 TDi (77 kW)	2008.07-2010.06	Coupe Engine BLS With ABS	•		GHA336001	K
	2008.07-2010.06	Coupe Engine BLS With ABS		o	GHA228036	K
	2008.07-2010.06	Coupe Engine BLS Without ABS	•		GHA336002	
	2008.07-2010.06	Coupe Engine BLS Without ABS		o	GHA228037	
2.0 (85 kW)	2008.10-	Coupe Engine CEKA With ABS	•		GHA336001	K
	2008.10-	Coupe Engine CEKA With ABS		o	GHA228036	K
	2008.10-	Coupe Engine CEKA Without ABS	•		GHA336002	
2.0 TDi (105 kW)	2010.01-	Coupe Engine CFHD With ABS	•		GHA336001	K
	2010.01-	Coupe Engine CFHD With ABS		o	GHA228036	K
	2010.01-	Coupe Engine CFHD Without ABS	•		GHA336002	
	2010.01-	Coupe Engine CFHD Without ABS		o	GHA228037	
IBIZA V SPORTCOUPE (6J1, 6P5)						
1.0 (55 kW)	2015.05-	Coupe Engine CHYB With ABS	•		GHA336001	K
	2015.05-	Coupe Engine CHYB With ABS		o	GHA228036	K
1.0 TSi (70 kW)	2015.05-	Coupe Engine CHZB With ABS	•		GHA336001	K
	2015.05-	Coupe Engine CHZB With ABS		o	GHA228036	K
1.0 TSi (81 kW)	2015.05-	Coupe Engine CHZC With ABS	•		GHA336001	K
	2015.05-	Coupe Engine CHZC With ABS		o	GHA228036	K
1.2 TSi (66 kW)	2015.05-	Coupe Engine CJZC With ABS	•		GHA336001	K
	2015.05-	Coupe Engine CJZC With ABS		o	GHA228036	K
1.2 TSi (81 kW)	2015.09-	Coupe Engine CJZD With ABS	•		GHA336001	K
	2015.09-	Coupe Engine CJZD With ABS		o	GHA228036	K
1.4 TDi (55 kW)	2015.05-	Coupe Engine CUSA With ABS	•		GHA336001	K
	2015.05-	Coupe Engine CUSA With ABS		o	GHA228036	K
1.4 TDi (66 kW)	2015.05-	Coupe Engine CUSB With ABS	•		GHA336001	K
	2015.05-	Coupe Engine CUSB With ABS		o	GHA228036	K
1.4 TDi (77 kW)	2015.05-	Coupe Engine CUTA With ABS	•		GHA336001	K
	2015.05-	Coupe Engine CUTA With ABS		o	GHA228036	K
IBIZA V ST (6J8)						
1.2 (44 kW)	2010.05-	Estate Engine CGPB With ABS	•		GHA336001	K
	2010.05-	Estate Engine CGPB With ABS		o	GHA228036	K
	2010.05-	Estate Engine CGPB Without ABS	•		GHA336002	
	2010.05-	Estate Engine CGPB Without ABS		o	GHA228037	
1.2 (51 kW)	2010.05-	Estate Engine CGPA/BZG/CJLB With ABS	•		GHA336001	K
	2010.05-	Estate Engine CGPA/BZG/CJLB With ABS		o	GHA228036	K



	 YEAR		F	R	G-AP Ref.	KIT
SEAT						
IBIZA V ST (6J8)						
1.2 (51 kW)	2010.05-	Estate Engine CGPA/BZG/CJLB Without ABS	•		GHA336002	
	2010.05-	Estate Engine CGPA/BZG/CJLB Without ABS		◦	GHA228037	
1.2 TDi (55 kW)	2010.04-	Estate Engine CFWA With ABS	•		GHA336001	K
	2010.04-	Estate Engine CFWA With ABS		◦	GHA228036	K
	2010.04-	Estate Engine CFWA Without ABS	•		GHA336002	
	2010.04-	Estate Engine CFWA Without ABS		◦	GHA228037	
1.2 TSi (63 kW)	2012.09-	Estate Engine CBZA With ABS	•		GHA336001	K
	2012.09-	Estate Engine CBZA With ABS		◦	GHA228036	K
1.2 TSi (77 kW)	2010.09-	Estate Engine CBZB With ABS	•		GHA336001	K
	2010.09-	Estate Engine CBZB With ABS		◦	GHA228036	K
	2010.09-	Estate Engine CBZB Without ABS	•		GHA336002	
	2010.09-	Estate Engine CBZB Without ABS		◦	GHA228037	
1.4 (63 kW)	2010.03-	Estate Engine CGGB With ABS	•		GHA336001	K
	2010.03-	Estate Engine CGGB With ABS		◦	GHA228036	K
	2010.03-	Estate Engine CGGB Without ABS	•		GHA336002	
	2010.03-	Estate Engine CGGB Without ABS		◦	GHA228037	
1.4 TSi (103 kW)	2013.10-	Estate Engine CPTA With ABS	•		GHA336001	K
	2013.10-	Estate Engine CPTA With ABS		◦	GHA228036	K
1.4 TSi (110 kW)	2012.02-	Estate Engine CAVF/CNUB/CTHF/CTJB With ABS	•		GHA336001	K
	2012.02-	Estate Engine CAVF/CNUB/CTHF/CTJB With ABS		◦	GHA228036	K
	2012.02-	Estate Engine CAVF/CNUB/CTHF/CTJB Without ABS	•		GHA336002	
1.6 (77 kW)	2012.02-	Estate Engine BTS Without ABS	•		GHA336002	
1.6 TDi (66 kW)	2010.03-	Estate Engine CAYB With ABS	•		GHA336001	K
	2010.03-	Estate Engine CAYB With ABS		◦	GHA228036	K
	2010.03-	Estate Engine CAYB Without ABS	•		GHA336002	
	2010.03-	Estate Engine CAYB Without ABS		◦	GHA228037	
1.6 TDi (77 kW)	2010.03-	Estate Engine CLNA/CAYC With ABS	•		GHA336001	K
	2010.03-	Estate Engine CLNA/CAYC With ABS		◦	GHA228036	K
	2010.03-	Estate Engine CLNA/CAYC Without ABS	•		GHA336002	
	2010.03-	Estate Engine CLNA/CAYC Without ABS		◦	GHA228037	
IBIZA V ST (6J8, 6P8)						
1.0 (55 kW)	2015.05-	Estate Engine CHYB With ABS	•		GHA336001	K
	2015.05-	Estate Engine CHYB With ABS		◦	GHA228036	K
1.0 TSi (70 kW)	2015.05-	Estate Engine CHZB With ABS	•		GHA336001	K
	2015.05-	Estate Engine CHZB With ABS		◦	GHA228036	K
1.0 TSi (81 kW)	2015.05-	Estate Engine CHZC With ABS	•		GHA336001	K
	2015.05-	Estate Engine CHZC With ABS		◦	GHA228036	K
1.2 TSi (66 kW)	2015.05-	Estate Engine CJZC With ABS	•		GHA336001	K
	2015.05-	Estate Engine CJZC With ABS		◦	GHA228036	K
1.2 TSi (81 kW)	2015.09-	Estate Engine CJZD With ABS	•		GHA336001	K
	2015.09-	Estate Engine CJZD With ABS		◦	GHA228036	K
1.4 TDi (55 kW)	2015.05-	Estate Engine CUSA With ABS	•		GHA336001	K
	2015.05-	Estate Engine CUSA With ABS		◦	GHA228036	K
1.4 TDi (66 kW)	2015.05-	Estate Engine CUSB With ABS	•		GHA336001	K
	2015.05-	Estate Engine CUSB With ABS		◦	GHA228036	K
1.4 TDi (77 kW)	2015.05-	Estate Engine CUTA With ABS	•		GHA336001	K
	2015.05-	Estate Engine CUTA With ABS		◦	GHA228036	K
INCA (6K9)						
1.4 16V (55 kW)	2000.04-2003.06	Box Engine AUA	•		GHA422036	K
	2000.04-2003.06	Box Engine AUA	•		GWB1358	
	2000.04-2003.06	Box Engine AUA		◦	GHA230057	K
	2000.04-2003.06	Box Engine AUA		◦	GHA499047	
1.4 i (44 kW)	1995.11-2003.06	Box Engine AEX/AKV/APQ/AUD	•		GHA422036	K
	1995.11-2003.06	Box Engine AEX/AKV/APQ/AUD	•		GWB1358	
	1995.11-2003.06	Box Engine AEX/AKV/APQ/AUD		◦	GHA230057	K
	1995.11-2003.06	Box Engine AEX/AKV/APQ/AUD		◦	GHA499047	
	1995.11-2003.06	Box Engine AEX/AKV/APQ/AUD		◦	GWB0542	
	1995.11-2003.06	Box Engine AEX/AKV/APQ/AUD		◦	GWB3519	
1.6 i (55 kW)	1995.11-1998.05	Box Engine 1F	•		GHA422036	K
	1995.11-1998.05	Box Engine 1F	•		GWB1358	
	1995.11-1998.05	Box Engine 1F		◦	GHA499047	
	1995.11-1998.05	Box Engine 1F		◦	GWB0542	
	1995.11-1998.05	Box Engine 1F		◦	GWB3519	
	1997.06-2000.09	Box Engine AEE/ALM	•		GHA422036	K



	 YEAR		F	R	G-AP Ref.	KIT
SEAT						
INCA (6K9)						
1.6 i (55 kW)	1997.06-2000.09	Box Engine AEE/ALM	•		GWB1358	
	1997.06-2000.09	Box Engine AEE/ALM		○	GHA230057	K
	1997.06-2000.09	Box Engine AEE/ALM		○	GHA499047	
	1997.06-2000.09	Box Engine AEE/ALM		○	GWB0542	
	1997.06-2000.09	Box Engine AEE/ALM		○	GWB3519	
1.7 D (42 kW)	1996.09-2003.06	Box Engine AHB	•		GHA422036	K
	1996.09-2003.06	Box Engine AHB	•		GWB1358	
	1996.09-2003.06	Box Engine AHB		○	GHA230057	K
	1996.09-2003.06	Box Engine AHB		○	GHA499047	
	1996.09-2003.06	Box Engine AHB		○	GWB0542	
	1996.09-2003.06	Box Engine AHB		○	GWB3519	
1.9 D (47 kW)	1995.11-2003.06	Box Engine 1Y	•		GHA422036	K
	1995.11-2003.06	Box Engine 1Y	•		GWB1358	
	1995.11-2003.06	Box Engine 1Y		○	GHA230057	K
	1995.11-2003.06	Box Engine 1Y		○	GHA499047	
	1995.11-2003.06	Box Engine 1Y		○	GWB0542	
	1995.11-2003.06	Box Engine 1Y		○	GWB3519	
1.9 SDi (47 kW)	1995.11-2003.06	Box Engine AEY/AYQ	•		GHA422036	K
	1995.11-2003.06	Box Engine AEY/AYQ	•		GWB1358	
	1995.11-2003.06	Box Engine AEY/AYQ		○	GHA230057	K
	1995.11-2003.06	Box Engine AEY/AYQ		○	GHA499047	
	1995.11-2003.06	Box Engine AEY/AYQ		○	GWB0542	
	1995.11-2003.06	Box Engine AEY/AYQ		○	GWB3519	
1.9 TDi (66 kW)	1996.09-2003.06	Box Engine ALH	•		GHA422036	K
	1996.09-2003.06	Box Engine ALH	•		GWB1358	
	1996.09-2003.06	Box Engine ALH		○	GHA230057	K
	1996.09-2003.06	Box Engine ALH		○	GWB0542	
	1996.09-2003.06	Box Engine ALH		○	GWB3519	
LEON (1M1)						
1.4 16V (55 kW)	1999.11-2006.06	Hatchback Engine AHW/APE/AUA/AXP/BCA	•		GHA436002	K
	1999.11-2006.06	Hatchback Engine AHW/APE/AUA/AXP/BCA	•		GWB3455	
	1999.11-2006.06	Hatchback Engine AHW/APE/AUA/AXP/BCA With ABS		○	GHA230051	K
1.6 (74 kW)	1999.11-2006.06	Hatchback Engine AEH/AKL/APF	•		GHA436002	K
	1999.11-2006.06	Hatchback Engine AEH/AKL/APF	•		GWB3455	
	1999.11-2006.06	Hatchback Engine AEH/AKL/APF With ABS		○	GHA230051	K
1.6 (75 kW)	2005.10-2006.06	Hatchback Engine BFQ/BGU	•		GWB3455	
	2005.10-2006.06	Hatchback Engine BFQ/BGU With ABS		○	GHA230051	K
1.6 16V (77 kW)	2000.09-2006.06	Hatchback Engine ATN/AUS/AZD/BCB	•		GHA436002	K
	2000.09-2006.06	Hatchback Engine ATN/AUS/AZD/BCB	•		GWB3455	
	2000.09-2006.06	Hatchback Engine ATN/AUS/AZD/BCB With ABS		○	GHA230051	K
1.8 20V (92 kW)	1999.11-2006.06	Hatchback Engine AGN/APG	•		GHA436002	K
	1999.11-2006.06	Hatchback Engine AGN/APG	•		GWB3455	
	1999.11-2006.06	Hatchback Engine AGN/APG With ABS		○	GHA230051	K
1.8 20V T (132 kW)	1999.11-2006.06	Hatchback Engine APP/AUQ	•		GHA436002	K
	1999.11-2006.06	Hatchback Engine APP/AUQ	•		GWB3455	
	1999.11-2006.06	Hatchback Engine APP/AUQ With ABS		○	GHA230051	K
1.8 20V T 4 (132 kW)	1999.11-2006.06	Hatchback Engine AJQ/ARY	•		GWB3455	
	1999.11-2006.06	Hatchback Engine AJQ/ARY		○	GHA436002	K
1.8 T Cupra R (154 kW)	2002.02-2006.06	Hatchback Engine AMK	•		GWB3455	
	2002.02-2006.06	Hatchback Engine AMK With ABS		○	GHA230051	K
1.8 T Cupra R (165 kW)	2003.07-2006.06	Hatchback Engine BAM	•		GWB3607	
	2003.07-2006.06	Hatchback Engine BAM With ABS		○	GHA230051	K
1.9 SDi (50 kW)	1999.11-2006.06	Hatchback Engine AQM	•		GHA436002	K
	1999.11-2006.06	Hatchback Engine AQM	•		GWB3455	
	1999.11-2006.06	Hatchback Engine AQM With ABS		○	GHA230051	K
1.9 TDi (110 kW)	2001.02-2006.06	Hatchback Engine ARL	•		GHA436002	K
	2001.02-2006.06	Hatchback Engine ARL	•		GWB3455	
	2001.02-2006.06	Hatchback Engine ARL With ABS		○	GHA230051	K
1.9 TDi (66 kW)	1999.11-2006.06	Hatchback Engine AGR/ALH	•		GHA436002	K
	1999.11-2006.06	Hatchback Engine AGR/ALH	•		GWB3455	
	1999.11-2006.06	Hatchback Engine AGR/ALH With ABS		○	GHA230051	K
1.9 TDi (74 kW)	2005.10-2006.06	Hatchback Engine AXR	•		GWB3455	
	2005.10-2006.06	Hatchback Engine AXR With ABS		○	GHA230051	K
1.9 TDi (81 kW)	1999.11-2006.06	Hatchback Engine AHF/ASV	•		GHA436002	K



	 YEAR		F	R	G-AP Ref.	KIT
SEAT						
LEON (1M1)						
1.9 TDi (81 kW)	1999.11-2006.06	Hatchback Engine AHF/ASV	•		GWB3455	
	1999.11-2006.06	Hatchback Engine AHF/ASV With ABS		◦	GHA230051	K
1.9 TDi (96 kW)	2003.05-2006.06	Hatchback Engine ASZ	•		GWB3455	
	2003.05-2006.06	Hatchback Engine ASZ With ABS		◦	GHA230051	K
1.9 TDi Syncro (110 kW)	2002.05-2006.06	Hatchback Engine ARL	•		GWB3455	
	2002.05-2006.06	Hatchback Engine ARL		◦	GHA436002	K
2.8 (150 kW)	2002.05-2004.06	Hatchback Engine BDE	•		GHA436002	K
	2002.05-2004.06	Hatchback Engine BDE	•		GWB3455	
	2002.05-2004.06	Hatchback Engine BDE With ABS		◦	GHA230051	K
2.8 Cupra 4 (150 kW)	2001.02-2006.06	Hatchback Engine AUE	•		GWB3455	
	2001.02-2006.06	Hatchback Engine AUE		◦	GHA436002	K
LEON (1P1)						
1.2 TSi (77 kW)	2010.02-	Hatchback Engine CBZB 3 hole	•		GHA336004	K
	2010.02-	Hatchback Engine CBZB 4 hole	•		GHA336007	K
	2010.02-	Hatchback Engine CBZB Inner Diameter [30mm]		◦	GHA230082	K
	2010.02-	Hatchback Engine CBZB Inner Diameter [32mm]		◦	GHA232018	K
1.4 16V (63 kW)	2006.06-	Hatchback Engine BXW/CGGB 3 hole	•		GHA336004	K
	2006.06-	Hatchback Engine BXW/CGGB 4 hole	•		GHA336007	K
	2006.06-	Hatchback Engine BXW/CGGB Inner Diameter [30mm]		◦	GHA230082	K
	2006.06-	Hatchback Engine BXW/CGGB Inner Diameter [32mm]		◦	GHA232018	K
1.4 TSi (92 kW)	2007.11-	Hatchback Engine CAXC 3 hole	•		GHA336004	K
	2007.11-	Hatchback Engine CAXC 4 hole	•		GHA336007	K
	2007.11-	Hatchback Engine CAXC Inner Diameter [30mm]		◦	GHA230082	K
	2007.11-	Hatchback Engine CAXC Inner Diameter [32mm]		◦	GHA232018	K
1.6 (75 kW)	2005.07-	Hatchback Engine BSE/BSF/CCSA/CMXA 3 hole	•		GHA336004	K
	2005.07-	Hatchback Engine BSE/BSF/CCSA/CMXA 4 hole	•		GHA336007	K
	2005.07-	Hatchback Engine BSE/BSF/CCSA/CMXA Inner Diameter [30mm]		◦	GHA230082	K
	2005.07-	Hatchback Engine BSE/BSF/CCSA/CMXA Inner Diameter [32mm]		◦	GHA232018	K
1.6 LPG (75 kW)	2009.12-	Hatchback Engine CHGA 3 hole	•		GHA336004	K
	2009.12-	Hatchback Engine CHGA 4 hole	•		GHA336007	K
	2009.12-	Hatchback Engine CHGA Inner Diameter [30mm]		◦	GHA230082	K
	2009.12-	Hatchback Engine CHGA Inner Diameter [32mm]		◦	GHA232018	K
1.6 MultiFuel (75 kW)	2010.11-	Hatchback Engine CMXA 3 hole	•		GHA336004	K
	2010.11-	Hatchback Engine CMXA 4 hole	•		GHA336007	K
	2010.11-	Hatchback Engine CMXA Inner Diameter [30mm]		◦	GHA230082	K
	2010.11-	Hatchback Engine CMXA Inner Diameter [32mm]		◦	GHA232018	K
1.6 TDi (66 kW)	2010.11-	Hatchback Engine CAYB 3 hole	•		GHA336004	K
	2010.11-	Hatchback Engine CAYB 4 hole	•		GHA336007	K
	2010.11-	Hatchback Engine CAYB Inner Diameter [30mm]		◦	GHA230082	K
	2010.11-	Hatchback Engine CAYB Inner Diameter [32mm]		◦	GHA232018	K
1.6 TDi (77 kW)	2010.02-	Hatchback Engine CAYC 3 hole	•		GHA336004	K
	2010.02-	Hatchback Engine CAYC 4 hole	•		GHA336007	K
	2010.02-	Hatchback Engine CAYC Inner Diameter [30mm]		◦	GHA230082	K
	2010.02-	Hatchback Engine CAYC Inner Diameter [32mm]		◦	GHA232018	K
1.8 TSi (118 kW)	2007.06-	Hatchback Engine BZB/CDAA 3 hole	•		GHA336004	K
	2007.06-	Hatchback Engine BZB/CDAA 4 hole	•		GHA336007	K
	2007.06-	Hatchback Engine BZB/CDAA Inner Diameter [30mm]		◦	GHA230082	K
	2007.06-	Hatchback Engine BZB/CDAA Inner Diameter [32mm]		◦	GHA232018	K
1.9 TDi (66 kW)	2007.06-	Hatchback Engine BXF 3 hole	•		GHA336004	K
	2007.06-	Hatchback Engine BXF 4 hole	•		GHA336007	K
	2007.06-	Hatchback Engine BXF Inner Diameter [30mm]		◦	GHA230082	K
	2007.06-	Hatchback Engine BXF Inner Diameter [32mm]		◦	GHA232018	K
1.9 TDi (77 kW)	2005.07-	Hatchback Engine BKC/BLS/BXE 3 hole	•		GHA336004	K
	2005.07-	Hatchback Engine BKC/BLS/BXE 4 hole	•		GHA336007	K
	2005.07-	Hatchback Engine BKC/BLS/BXE Inner Diameter [30mm]		◦	GHA230082	K
	2005.07-	Hatchback Engine BKC/BLS/BXE Inner Diameter [32mm]		◦	GHA232018	K
1.9 TDi (81 kW)	2005.10-2012.12	Hatchback Engine ASV 3 hole	•		GHA336004	K
	2005.10-2012.12	Hatchback Engine ASV 4 hole	•		GHA336007	K
	2005.10-2012.12	Hatchback Engine ASV Inner Diameter [30mm]		◦	GHA230082	K
	2005.10-2012.12	Hatchback Engine ASV Inner Diameter [32mm]		◦	GHA232018	K
2.0 Cupra R (195 kW)	2009.09-	Hatchback Engine CDLA 3 hole	•		GHA336004	K
	2009.09-	Hatchback Engine CDLA 4 hole	•		GHA336007	K
	2009.09-	Hatchback Engine CDLA Inner Diameter [30mm]		◦	GHA230082	K
	2009.09-	Hatchback Engine CDLA Inner Diameter [32mm]		◦	GHA232018	K



	 YEAR		F	R	G-AP Ref.	KIT
SEAT						
LEON (1P1)						
2.0 FSi (110 kW)	2005.07-2010.05	Hatchback Engine BLR/BLY/BVY/BVZ 3 hole	•		GHA336004	K
	2005.07-2010.05	Hatchback Engine BLR/BLY/BVY/BVZ 4 hole	•		GHA336007	K
	2005.07-2010.05	Hatchback Engine BLR/BLY/BVY/BVZ Inner Diameter [30mm]		○	GHA230082	K
	2005.07-2010.05	Hatchback Engine BLR/BLY/BVY/BVZ Inner Diameter [32mm]		○	GHA232018	K
2.0 TDi (100 kW)	2005.07-2010.05	Hatchback Engine AZV 3 hole	•		GHA336004	K
	2005.07-2010.05	Hatchback Engine AZV 4 hole	•		GHA336007	K
	2005.07-2010.05	Hatchback Engine AZV Inner Diameter [30mm]		○	GHA230082	K
	2005.07-2010.05	Hatchback Engine AZV Inner Diameter [32mm]		○	GHA232018	K
2.0 TDi (103 kW)	2005.10-	Hatchback Engine BMM 3 hole	•		GHA336004	K
	2005.10-	Hatchback Engine BMM 4 hole	•		GHA336007	K
	2005.10-	Hatchback Engine BMM Inner Diameter [30mm]		○	GHA230082	K
	2005.10-	Hatchback Engine BMM Inner Diameter [32mm]		○	GHA232018	K
2.0 TDi (125 kW)	2006.06-2007.07	Hatchback Engine BMN/CEGA/CFJA 3 hole	•		GHA336004	K
	2006.06-2007.07	Hatchback Engine BMN/CEGA/CFJA 4 hole	•		GHA336007	K
	2006.06-2007.07	Hatchback Engine BMN/CEGA/CFJA Inner Diameter [30mm]		○	GHA230082	K
	2006.06-2007.07	Hatchback Engine BMN/CEGA/CFJA Inner Diameter [32mm]		○	GHA232018	K
2.0 TDi 16V (103 kW)	2005.07-	Hatchback Engine BKD/CFHC/CLCB 3 hole	•		GHA336004	K
	2005.07-	Hatchback Engine BKD/CFHC/CLCB 4 hole	•		GHA336007	K
	2005.07-	Hatchback Engine BKD/CFHC/CLCB Inner Diameter [30mm]		○	GHA230082	K
	2005.07-	Hatchback Engine BKD/CFHC/CLCB Inner Diameter [32mm]		○	GHA232018	K
2.0 TFSi (136 kW)	2005.10-2006.05	Hatchback Engine BWA1 3 hole	•		GHA336004	K
	2005.10-2006.05	Hatchback Engine BWA1 4 hole	•		GHA336007	K
	2005.10-2006.05	Hatchback Engine BWA1 Inner Diameter [30mm]		○	GHA230082	K
2.0 TFSi (147 kW)	2005.05-2009.03	Hatchback Engine BWA 3 hole	•		GHA336004	K
	2005.05-2009.03	Hatchback Engine BWA 4 hole	•		GHA336007	K
	2005.05-2009.03	Hatchback Engine BWA Inner Diameter [30mm]		○	GHA230082	K
	2005.05-2009.03	Hatchback Engine BWA Inner Diameter [32mm]		○	GHA232018	K
2.0 TFSi (155 kW)	2009.06-	Hatchback Engine CCZB 3 hole	•		GHA336004	K
	2009.06-	Hatchback Engine CCZB 4 hole	•		GHA336007	K
	2009.06-	Hatchback Engine CCZB Inner Diameter [30mm]		○	GHA230082	K
	2009.06-	Hatchback Engine CCZB Inner Diameter [32mm]		○	GHA232018	K
2.0 TFSi (177 kW)	2006.11-2007.07	Hatchback Engine BWJ/CDLD 3 hole	•		GHA336004	K
	2006.11-2007.07	Hatchback Engine BWJ/CDLD 4 hole	•		GHA336007	K
	2006.11-2007.07	Hatchback Engine BWJ/CDLD Inner Diameter [30mm]		○	GHA230082	K
	2006.11-2007.07	Hatchback Engine BWJ/CDLD Inner Diameter [32mm]		○	GHA232018	K
LEON (5F1)						
1.2 TSi (63 kW)	2012.12-	Hatchback Engine CJZB 3 hole	•		GHA336004	K
	2012.12-	Hatchback Engine CJZB Inner Diameter [30mm]		○	GHA230082	K
1.2 TSi (77 kW)	2013.01-	Hatchback Engine CJZA 3 hole	•		GHA336004	K
	2013.01-	Hatchback Engine CJZA Inner Diameter [30mm]		○	GHA230082	K
1.2 TSi (81 kW)	2014.04-	Hatchback Engine CYVB 3 hole	•		GHA336004	K
	2014.04-	Hatchback Engine CYVB Inner Diameter [30mm]		○	GHA230082	K
1.4 TGI (81 kW)	2013.02-	Hatchback Engine CPWA 3 hole	•		GHA336004	K
	2013.02-	Hatchback Engine CPWA Inner Diameter [30mm]		○	GHA230082	K
1.4 TSi (103 kW)	2012.09-	Hatchback Engine CHPA/CPTA 3 hole	•		GHA336004	K
	2012.09-	Hatchback Engine CHPA/CPTA Inner Diameter [30mm]		○	GHA230082	K
1.4 TSi (110 kW)	2014.05-	Hatchback Engine CZEA 3 hole	•		GHA336004	K
	2014.05-	Hatchback Engine CZEA Inner Diameter [30mm]		○	GHA230082	K
1.4 TSi (90 kW)	2012.11-	Hatchback Engine CMBA/CXSA 3 hole	•		GHA336004	K
	2012.11-	Hatchback Engine CMBA/CXSA Inner Diameter [30mm]		○	GHA230082	K
1.4 TSi (92 kW)	2014.05-	Hatchback Engine CZCA 3 hole	•		GHA336004	K
	2014.05-	Hatchback Engine CZCA Inner Diameter [30mm]		○	GHA230082	K
1.6 TDi (66 kW)	2012.11-	Hatchback Engine CLHB 3 hole	•		GHA336004	K
	2012.11-	Hatchback Engine CLHB Inner Diameter [30mm]		○	GHA230082	K
1.6 TDi (77 kW)	2012.11-	Hatchback Engine CLHA 3 hole	•		GHA336004	K
	2012.11-	Hatchback Engine CLHA Inner Diameter [30mm]		○	GHA230082	K
1.6 TDi (81 kW)	2013.09-	Hatchback Engine CRKB 3 hole	•		GHA336004	K
	2013.09-	Hatchback Engine CRKB Inner Diameter [30mm]		○	GHA230082	K
1.8 TSi (132 kW)	2013.02-	Hatchback Engine CJSA 3 hole	•		GHA336004	K
	2013.02-	Hatchback Engine CJSA Inner Diameter [30mm]		○	GHA230082	K
2.0 Cupra (195 kW)	2013.10-	Hatchback Engine CJXE 3 hole	•		GHA336004	K
	2013.10-	Hatchback Engine CJXE Inner Diameter [30mm]		○	GHA230082	K
2.0 Cupra (206 kW)	2013.10-	Hatchback Engine CJXA 3 hole	•		GHA336004	K
	2013.10-	Hatchback Engine CJXA Inner Diameter [30mm]		○	GHA230082	K



	 YEAR		F	R	G-AP Ref.	KIT
SEAT						
LEON (5F1)						
2.0 TDi (105 kW)	2013.05-	Hatchback Engine CRVC 3 hole	•		GHA336004	K
	2013.05-	Hatchback Engine CRVC Inner Diameter [30mm]		○	GHA230082	K
2.0 TDi (110 kW)	2012.10-	Hatchback Engine CKFC/CRMB 3 hole	•		GHA336004	K
	2012.10-	Hatchback Engine CKFC/CRMB Inner Diameter [30mm]		○	GHA230082	K
2.0 TDi (135 kW)	2012.09-	Hatchback Engine CUNA/CUPA 3 hole	•		GHA336004	K
	2012.09-	Hatchback Engine CUNA/CUPA Inner Diameter [30mm]		○	GHA230082	K
2.0 TDi (81 kW)	2013.05-	Hatchback Engine CRVA 3 hole	•		GHA336004	K
	2013.05-	Hatchback Engine CRVA Inner Diameter [30mm]		○	GHA230082	K
LEON SC (5F5)						
1.2 TSi (63 kW)	2013.01-	Coupe Engine CJZB 3 hole	•		GHA336004	K
	2013.01-	Coupe Engine CJZB Inner Diameter [30mm]		○	GHA230082	K
1.2 TSi (77 kW)	2013.02-	Coupe Engine CJZA 3 hole	•		GHA336004	K
	2013.02-	Coupe Engine CJZA Inner Diameter [30mm]		○	GHA230082	K
1.2 TSi (81 kW)	2014.05-	Coupe Engine CYVB 3 hole	•		GHA336004	K
	2014.05-	Coupe Engine CYVB Inner Diameter [30mm]		○	GHA230082	K
1.4 TSi (103 kW)	2013.02-	Coupe Engine CHPA/CPTA 3 hole	•		GHA336004	K
	2013.02-	Coupe Engine CHPA/CPTA Inner Diameter [30mm]		○	GHA230082	K
1.4 TSi (110 kW)	2014.05-	Coupe Engine CZEA 3 hole	•		GHA336004	K
	2014.05-	Coupe Engine CZEA Inner Diameter [30mm]		○	GHA230082	K
1.4 TSi (90 kW)	2013.02-	Coupe Engine CMBA/CXSA 3 hole	•		GHA336004	K
	2013.02-	Coupe Engine CMBA/CXSA Inner Diameter [30mm]		○	GHA230082	K
1.4 TSi (92 kW)	2014.05-	Coupe Engine CZCA 3 hole	•		GHA336004	K
	2014.05-	Coupe Engine CZCA Inner Diameter [30mm]		○	GHA230082	K
1.6 TDi (66 kW)	2013.02-	Coupe Engine CLHB 3 hole	•		GHA336004	K
	2013.02-	Coupe Engine CLHB Inner Diameter [30mm]		○	GHA230082	K
1.6 TDi (77 kW)	2013.02-	Coupe Engine CLHA 3 hole	•		GHA336004	K
	2013.02-	Coupe Engine CLHA Inner Diameter [30mm]		○	GHA230082	K
1.6 TDi (81 kW)	2013.09-	Coupe Engine CRKB 3 hole	•		GHA336004	K
	2013.09-	Coupe Engine CRKB Inner Diameter [30mm]		○	GHA230082	K
1.8 TSi (132 kW)	2013.02-	Coupe Engine CJSA 3 hole	•		GHA336004	K
	2013.02-	Coupe Engine CJSA Inner Diameter [30mm]		○	GHA230082	K
2.0 Cupra (195 kW)	2013.10-	Coupe Engine CJXE 3 hole	•		GHA336004	K
	2013.10-	Coupe Engine CJXE Inner Diameter [30mm]		○	GHA230082	K
2.0 Cupra (206 kW)	2013.10-	Coupe Engine CJXA 3 hole	•		GHA336004	K
	2013.10-	Coupe Engine CJXA Inner Diameter [30mm]		○	GHA230082	K
2.0 TDi (105 kW)	2013.05-	Coupe Engine CRVC 3 hole	•		GHA336004	K
	2013.05-	Coupe Engine CRVC Inner Diameter [30mm]		○	GHA230082	K
2.0 TDi (110 kW)	2013.02-	Coupe Engine CKJC/CRMB 3 hole	•		GHA336004	K
	2013.02-	Coupe Engine CKJC/CRMB Inner Diameter [30mm]		○	GHA230082	K
2.0 TDi (135 kW)	2013.03-	Coupe Engine CUNA/CUPA 3 hole	•		GHA336004	K
	2013.03-	Coupe Engine CUNA/CUPA Inner Diameter [30mm]		○	GHA230082	K
2.0 TDi (81 kW)	2013.02-	Coupe Engine CRVA 3 hole	•		GHA336004	K
	2013.02-	Coupe Engine CRVA Inner Diameter [30mm]		○	GHA230082	K
LEON ST (5F8)						
1.2 TSi (63 kW)	2013.11-	Estate Engine CJZB 3 hole	•		GHA336004	K
	2013.11-	Estate Engine CJZB Inner Diameter [30mm]		○	GHA230082	K
1.2 TSi (77 kW)	2013.08-	Estate Engine CJZA 3 hole	•		GHA336004	K
	2013.08-	Estate Engine CJZA Inner Diameter [30mm]		○	GHA230082	K
1.2 TSi (81 kW)	2014.05-	Estate Engine CYVB 3 hole	•		GHA336004	K
	2014.05-	Estate Engine CYVB Inner Diameter [30mm]		○	GHA230082	K
1.4 TGI (81 kW)	2013.10-	Estate Engine CPWA 3 hole	•		GHA336004	K
	2013.10-	Estate Engine CPWA Inner Diameter [30mm]		○	GHA230082	K
1.4 TSi (103 kW)	2013.10-	Estate Engine CHPA/CPTA 3 hole	•		GHA336004	K
	2013.10-	Estate Engine CHPA/CPTA Inner Diameter [30mm]		○	GHA230082	K
1.4 TSi (110 kW)	2014.05-	Estate Engine CZEA 3 hole	•		GHA336004	K
	2014.05-	Estate Engine CZEA Inner Diameter [30mm]		○	GHA230082	K
1.4 TSi (90 kW)	2013.10-	Estate Engine CMBA/CXSA 3 hole	•		GHA336004	K
	2013.10-	Estate Engine CMBA/CXSA Inner Diameter [30mm]		○	GHA230082	K
1.4 TSi (92 kW)	2014.05-	Estate Engine CZCA 3 hole	•		GHA336004	K
	2014.05-	Estate Engine CZCA Inner Diameter [30mm]		○	GHA230082	K
1.6 TDi (66 kW)	2013.11-	Estate Engine CLHB 3 hole	•		GHA336004	K
	2013.11-	Estate Engine CLHB Inner Diameter [30mm]		○	GHA230082	K
1.6 TDi (77 kW)	2013.10-	Estate Engine CLHA 3 hole	•		GHA336004	K
	2013.10-	Estate Engine CLHA Inner Diameter [30mm]		○	GHA230082	K



	 YEAR		F	R	G-AP Ref.	KIT
SEAT						
LEON ST (5F8)						
1.6 TDi (81 kW)	2013.09-	Estate Engine CRKB 3 hole	•		GHA336004	K
	2013.09-	Estate Engine CRKB Inner Diameter [30mm]		○	GHA230082	K
1.6 TDi 4Drive (77 kW)	2014.04-	Estate Engine CLHA 3 hole	•		GHA336004	K
1.6 TDi 4Drive (81 kW)	2014.11-	Estate Engine CRKB 3 hole	•		GHA336004	K
1.8 TSi (132 kW)	2013.10-	Estate Engine CJSA 3 hole	•		GHA336004	K
	2013.10-	Estate Engine CJSA Inner Diameter [30mm]		○	GHA230082	K
1.8 TSi 4Drive (132 kW)	2014.11-	Estate Engine CJSA 3 hole	•		GHA336004	K
2.0 Cupra (195 kW)	2013.10-	Estate Engine CJXE 3 hole	•		GHA336004	K
	2013.10-	Estate Engine CJXE Inner Diameter [30mm]		○	GHA230082	K
2.0 Cupra (206 kW)	2013.10-	Estate Engine CJXA 3 hole	•		GHA336004	K
	2013.10-	Estate Engine CJXA Inner Diameter [30mm]		○	GHA230082	K
2.0 TDi (105 kW)	2013.10-	Estate Engine CRVC 3 hole	•		GHA336004	K
	2013.10-	Estate Engine CRVC Inner Diameter [30mm]		○	GHA230082	K
2.0 TDi (110 kW)	2013.10-	Estate Engine CRBC/CRLB/CRMB/CKFC 3 hole	•		GHA336004	K
	2013.10-	Estate Engine CRBC/CRLB/CRMB/CKFC Inner Diameter [30mm]		○	GHA230082	K
2.0 TDi (135 kW)	2013.08-	Estate Engine CUNA/CUPA 3 hole	•		GHA336004	K
	2013.08-	Estate Engine CUNA/CUPA Inner Diameter [30mm]		○	GHA230082	K
2.0 TDi (81 kW)	2013.11-	Estate Engine CRVA 3 hole	•		GHA336004	K
	2013.11-	Estate Engine CRVA Inner Diameter [30mm]		○	GHA230082	K
2.0 TDi 4Drive (110 kW)	2014.04-	Estate Engine CRBC/CRLB/CRMB 3 hole	•		GHA336004	K
2.0 TDi 4Drive (135 kW)	2014.11-	Estate Engine CUNA 3 hole	•		GHA336004	K
MALAGA (023A)						
1.7 D (42 kW)	1990.05-1993.12	Saloon Engine 022A.5000	•		GWB1410	
	1990.05-1993.12	Saloon Engine 022A.5000		○	GHA230002	F
MARBELLA (28)						
0.9 (32 kW)	1997.07-1998.10	Hatchback Engine 08NCB	•		GHA320001	K
0.9 CAT (29 kW)	1990.01-1996.11	Hatchback Engine 09NCB/100GL7000	•		GHA320001	K
0.9 CAT (30 kW)	1996.11-1998.10	Hatchback Engine 08NCB	•		GHA320001	K
MII (KF1_)						
1.0 (44 kW)	2011.10-	Hatchback Engine CHYA		○	GHA228061	K
1.0 (55 kW)	2011.10-	Hatchback Engine CHYB		○	GHA228061	K
1.0 EcoFuel (50 kW)	2012.11-	Hatchback Engine CPGA		○	GHA228061	K
TOLEDO (1L)						
1.6 i (52 kW)	1991.05-1993.12	Hatchback Engine 1F	•		GHA422036	K
	1991.05-1993.12	Hatchback Engine 1F	•		GHA436001	
	1991.05-1993.12	Hatchback Engine 1F	•		GWB1358	
	1991.05-1993.12	Hatchback Engine 1F		○	GHA499014	
	1991.05-1993.12	Hatchback Engine 1F		○	GHA499015	
	1991.05-1993.12	Hatchback Engine 1F		○	GHA499044	
	1991.05-1993.12	Hatchback Engine 1F		○	GHA499045	
	1991.05-1993.12	Hatchback Engine 1F		○	GHA499046	
	1991.05-1993.12	Hatchback Engine 1F		○	GWB0529	
1.6 i (54 kW)	1991.05-1999.03	Hatchback Engine 1F/ABN/EZ	•		GHA422036	K
	1991.05-1999.03	Hatchback Engine 1F/ABN/EZ	•		GHA436001	
	1991.05-1999.03	Hatchback Engine 1F/ABN/EZ	•		GWB1358	
	1991.05-1999.03	Hatchback Engine 1F/ABN/EZ		○	GHA499014	
	1991.05-1999.03	Hatchback Engine 1F/ABN/EZ		○	GHA499015	
	1991.05-1999.03	Hatchback Engine 1F/ABN/EZ		○	GHA499044	
	1991.05-1999.03	Hatchback Engine 1F/ABN/EZ		○	GHA499045	
	1991.05-1999.03	Hatchback Engine 1F/ABN/EZ		○	GWB0529	
1.6 i (55 kW)	1993.01-1999.03	Hatchback Engine 1F	•		GHA422036	K
	1993.01-1999.03	Hatchback Engine 1F	•		GHA436001	
	1993.01-1999.03	Hatchback Engine 1F	•		GWB1358	
	1993.01-1999.03	Hatchback Engine 1F		○	GHA499014	
	1993.01-1999.03	Hatchback Engine 1F		○	GHA499015	
	1993.01-1999.03	Hatchback Engine 1F		○	GHA499044	
	1993.01-1999.03	Hatchback Engine 1F		○	GHA499045	
	1993.01-1999.03	Hatchback Engine 1F		○	GHA499046	
	1993.01-1999.03	Hatchback Engine 1F		○	GWB0529	
1.6 i (74 kW)	1996.11-1999.03	Hatchback Engine AFT	•		GHA422036	K
	1996.11-1999.03	Hatchback Engine AFT	•		GHA436001	
	1996.11-1999.03	Hatchback Engine AFT	•		GWB1358	
	1996.11-1999.03	Hatchback Engine AFT		○	GHA499014	
	1996.11-1999.03	Hatchback Engine AFT		○	GHA499015	



	 YEAR		F	R	G-AP Ref.	KIT
SEAT						
TOLEDO (1L)						
1.6 i (74 kW)	1996.11-1999.03	Hatchback Engine AFT		o	GHA499044	
	1996.11-1999.03	Hatchback Engine AFT		o	GHA499045	
	1996.11-1999.03	Hatchback Engine AFT		o	GHA499046	
	1996.11-1999.03	Hatchback Engine AFT		o	GWB0529	
1.8 16V (92 kW)	1991.05-1999.03	Hatchback Engine PL	•		GHA422036	K
	1991.05-1999.03	Hatchback Engine PL	•		GHA436001	
	1991.05-1999.03	Hatchback Engine PL	•		GWB1358	
	1991.05-1999.03	Hatchback Engine PL		o	GHA499014	
	1991.05-1999.03	Hatchback Engine PL		o	GHA499015	
	1991.05-1999.03	Hatchback Engine PL		o	GWB0529	
1.8 16V (98 kW)	1991.05-1999.03	Hatchback Engine KR	•		GWB1358	
	1991.05-1999.03	Hatchback Engine KR		o	GWB0529	
1.8 i (65 kW)	1991.05-1996.12	Hatchback Engine RP	•		GHA422036	K
	1991.05-1996.12	Hatchback Engine RP	•		GHA436001	
	1991.05-1996.12	Hatchback Engine RP	•		GWB1358	
	1991.05-1996.12	Hatchback Engine RP		o	GHA499014	
	1991.05-1996.12	Hatchback Engine RP		o	GHA499015	
	1991.05-1996.12	Hatchback Engine RP		o	GHA499044	
	1991.05-1996.12	Hatchback Engine RP		o	GHA499045	
	1991.05-1996.12	Hatchback Engine RP		o	GHA499046	
	1991.05-1996.12	Hatchback Engine RP		o	GWB0529	
1.8 i (66 kW)	1993.11-1996.12	Hatchback Engine ADZ/ABS	•		GHA422036	K
	1993.11-1996.12	Hatchback Engine ADZ/ABS	•		GHA436001	
	1993.11-1996.12	Hatchback Engine ADZ/ABS	•		GWB1358	
	1993.11-1996.12	Hatchback Engine ADZ/ABS		o	GHA499014	
	1993.11-1996.12	Hatchback Engine ADZ/ABS		o	GHA499015	
	1993.11-1996.12	Hatchback Engine ADZ/ABS		o	GHA499044	
	1993.11-1996.12	Hatchback Engine ADZ/ABS		o	GHA499045	
	1993.11-1996.12	Hatchback Engine ADZ/ABS		o	GHA499046	
1.9 D (47 kW)	1995.12-1999.03	Hatchback Engine 1Y	•		GHA422036	K
	1995.12-1999.03	Hatchback Engine 1Y	•		GHA436001	
	1995.12-1999.03	Hatchback Engine 1Y	•		GWB1358	
	1995.12-1999.03	Hatchback Engine 1Y		o	GHA499014	
	1995.12-1999.03	Hatchback Engine 1Y		o	GHA499015	
	1995.12-1999.03	Hatchback Engine 1Y		o	GHA499044	
	1995.12-1999.03	Hatchback Engine 1Y		o	GHA499045	
	1995.12-1999.03	Hatchback Engine 1Y		o	GHA499046	
	1995.12-1999.03	Hatchback Engine 1Y		o	GWB0529	
1.9 D (50 kW)	1991.05-1999.03	Hatchback Engine 1Y	•		GWB1358	
	1991.05-1999.03	Hatchback Engine 1Y		o	GWB0529	
1.9 TD (55 kW)	1991.05-1999.03	Hatchback Engine AAZ	•		GHA422036	K
	1991.05-1999.03	Hatchback Engine AAZ	•		GHA436001	
	1991.05-1999.03	Hatchback Engine AAZ	•		GWB1358	
	1991.05-1999.03	Hatchback Engine AAZ		o	GHA499014	
	1991.05-1999.03	Hatchback Engine AAZ		o	GHA499015	
	1991.05-1999.03	Hatchback Engine AAZ		o	GHA499044	
	1991.05-1999.03	Hatchback Engine AAZ		o	GHA499045	
	1991.05-1999.03	Hatchback Engine AAZ		o	GHA499046	
1.9 TDi (66 kW)	1995.08-1999.03	Hatchback Engine 1Z/AHU	•		GHA422036	K
	1995.08-1999.03	Hatchback Engine 1Z/AHU	•		GHA436001	
	1995.08-1999.03	Hatchback Engine 1Z/AHU	•		GWB1358	
	1995.08-1999.03	Hatchback Engine 1Z/AHU		o	GHA499014	
	1995.08-1999.03	Hatchback Engine 1Z/AHU		o	GHA499015	
	1995.08-1999.03	Hatchback Engine 1Z/AHU		o	GHA499044	
	1995.08-1999.03	Hatchback Engine 1Z/AHU		o	GHA499045	
	1995.08-1999.03	Hatchback Engine 1Z/AHU		o	GHA499046	
	1995.08-1999.03	Hatchback Engine 1Z/AHU		o	GWB0529	
1.9 TDi (81 kW)	1996.11-1999.03	Hatchback Engine AFN	•		GHA422036	K
	1996.11-1999.03	Hatchback Engine AFN	•		GHA436001	
	1996.11-1999.03	Hatchback Engine AFN	•		GWB1358	
	1996.11-1999.03	Hatchback Engine AFN		o	GHA499014	
	1996.11-1999.03	Hatchback Engine AFN		o	GHA499015	



	 YEAR		F	R	G-AP Ref.	KIT
SEAT						
TOLEDO (1L)						
1.9 TDi (81 kW)	1996.11-1999.03	Hatchback Engine AFN		o	GHA499046	
	1996.11-1999.03	Hatchback Engine AFN		o	GWB0529	
2.0 i (85 kW)	1991.05-1999.03	Hatchback Engine 2E/AGG	•		GHA422036	K
	1991.05-1999.03	Hatchback Engine 2E/AGG	•		GHA436001	
	1991.05-1999.03	Hatchback Engine 2E/AGG	•		GWB1358	
	1991.05-1999.03	Hatchback Engine 2E/AGG		o	GHA499014	
	1991.05-1999.03	Hatchback Engine 2E/AGG		o	GHA499015	
	1991.05-1999.03	Hatchback Engine 2E/AGG		o	GWB0529	
2.0 i 16V (110 kW)	1993.11-1999.03	Hatchback Engine ABF	•		GHA422036	K
	1993.11-1999.03	Hatchback Engine ABF	•		GHA436001	
	1993.11-1999.03	Hatchback Engine ABF	•		GWB1491	
	1993.11-1999.03	Hatchback Engine ABF		o	GHA499014	
	1993.11-1999.03	Hatchback Engine ABF		o	GHA499015	
	1993.11-1999.03	Hatchback Engine ABF		o	GHA499046	
	1993.11-1999.03	Hatchback Engine ABF		o	GWB0529	
TOLEDO I (1L)						
1.8 GT (102 kW)	1991.05-1992.11	Hatchback Engine KR	•		GHA422036	K
	1991.05-1992.11	Hatchback Engine KR	•		GHA436001	
	1991.05-1992.11	Hatchback Engine KR	•		GWB1358	
	1991.05-1992.11	Hatchback Engine KR		o	GWB0529	
TOLEDO II (1M2)						
1.4 16V (55 kW)	1999.07-2006.05	Saloon Engine AHW/APE/AUA/AXP/BCA	•		GHA436002	K
	1999.07-2006.05	Saloon Engine AHW/APE/AUA/AXP/BCA	•		GWB3455	
	1999.07-2006.05	Saloon Engine AHW/APE/AUA/AXP/BCA With ABS		o	GHA230051	K
1.6 (74 kW)	1999.04-2000.09	Saloon Engine AEH/AKL/APE	•		GHA436002	K
	1999.04-2000.09	Saloon Engine AEH/AKL/APE	•		GWB3455	
	1999.04-2000.09	Saloon Engine AEH/AKL/APE With ABS		o	GHA230051	K
1.6 (75 kW)	2005.08-2006.05	Saloon Engine BFQ 4 hole	•		GHA336007	K
	2005.08-2006.05	Saloon Engine BFQ Inner Diameter [32mm]		o	GHA232018	K
1.6 16V (77 kW)	2000.09-2006.05	Saloon Engine AUS/AZD/BCB	•		GHA436002	K
	2000.09-2006.05	Saloon Engine AUS/AZD/BCB	•		GWB3455	
	2000.09-2006.05	Saloon Engine AUS/AZD/BCB With ABS		o	GHA230051	K
1.8 20V (92 kW)	1999.04-2006.05	Saloon Engine AGN/APG	•		GHA436002	K
	1999.04-2006.05	Saloon Engine AGN/APG	•		GWB3455	
	1999.04-2006.05	Saloon Engine AGN/APG With ABS		o	GHA230051	K
1.8 20VT (132 kW)	2001.05-2006.05	Saloon Engine APP/AUQ	•		GHA436002	K
	2001.05-2006.05	Saloon Engine APP/AUQ	•		GWB3455	
	2001.05-2006.05	Saloon Engine APP/AUQ With ABS		o	GHA230051	K
1.9 TDi (110 kW)	2000.10-2006.05	Saloon Engine ARL	•		GHA436002	K
	2000.10-2006.05	Saloon Engine ARL	•		GWB3455	
	2000.10-2006.05	Saloon Engine ARL With ABS		o	GHA230051	K
1.9 TDi (66 kW)	1999.04-2006.05	Saloon Engine AGR/ALH	•		GHA436002	K
	1999.04-2006.05	Saloon Engine AGR/ALH	•		GWB3455	
	1999.04-2006.05	Saloon Engine AGR/ALH With ABS		o	GHA230051	K
1.9 TDi (81 kW)	1999.04-2006.05	Saloon Engine AHF/ASV	•		GHA436002	K
	1999.04-2006.05	Saloon Engine AHF/ASV	•		GWB3455	
	1999.04-2006.05	Saloon Engine AHF/ASV With ABS		o	GHA230051	K
1.9 TDi (96 kW)	2003.05-2004.12	Saloon Engine ASZ	•		GWB3455	
	2003.05-2004.12	Saloon Engine ASZ With ABS		o	GHA230051	K
2.3 V5 (110 kW)	1999.04-2001.05	Saloon Engine AGZ	•		GHA436002	K
	1999.04-2001.05	Saloon Engine AGZ	•		GWB3455	
	1999.04-2001.05	Saloon Engine AGZ With ABS		o	GHA230051	K
2.3 V5 20V (125 kW)	2001.05-2006.05	Saloon Engine AQN	•		GHA436002	K
	2001.05-2006.05	Saloon Engine AQN	•		GWB3455	
	2001.05-2006.05	Saloon Engine AQN With ABS		o	GHA230051	K
TOLEDO III (5P2)						
1.6 (75 kW)	2004.10-2009.05	MPV Engine BGU/BSE/BSF/CCSA 3 hole	•		GHA336004	K
	2004.10-2009.05	MPV Engine BGU/BSE/BSF/CCSA 4 hole	•		GHA336007	K
	2004.10-2009.05	MPV Engine BGU/BSE/BSF/CCSA Inner Diameter [32mm]		o	GHA232018	K
1.8 TFSi (118 kW)	2007.01-2009.05	MPV Engine BYT/BZB/CDA 3 hole	•		GHA336004	K
	2007.01-2009.05	MPV Engine BYT/BZB/CDA 4 hole	•		GHA336007	K
	2007.01-2009.05	MPV Engine BYT/BZB/CDA Inner Diameter [32mm]		o	GHA232018	K
1.9 TDi (77 kW)	2005.01-2007.07	MPV Engine BJB/BKC/BLS/BXE 3 hole	•		GHA336004	K
	2005.01-2007.07	MPV Engine BJB/BKC/BLS/BXE 4 hole	•		GHA336007	K



	 YEAR		F	R	G-AP Ref.	KIT
SEAT						
TOLEDO III (5P2)						
1.9 TDi (77 kW)	2005.01-2007.07	MPV Engine BJB/BKC/BLS/BXE Inner Diameter [32mm]		o	GHA232018	K
2.0 FSi (110 kW)	2005.01-2006.05	MPV Engine BLR/BLY/BVY/BVZ 3 hole	•		GHA336004	K
	2005.01-2006.05	MPV Engine BLR/BLY/BVY/BVZ 4 hole	•		GHA336007	K
2.0 TDi (100 kW)	2005.01-2006.05	MPV Engine BLR/BLY/BVY/BVZ Inner Diameter [32mm]		o	GHA232018	K
	2004.09-2009.05	MPV Engine AZV 3 hole	•		GHA336004	K
	2004.09-2009.05	MPV Engine AZV 4 hole	•		GHA336007	K
2.0 TDi (103 kW)	2004.09-2009.05	MPV Engine AZV Inner Diameter [32mm]		o	GHA232018	K
	2005.11-2009.05	MPV Engine BMM 3 hole	•		GHA336004	K
	2005.11-2009.05	MPV Engine BMM 4 hole	•		GHA336007	K
2.0 TDi (125 kW)	2005.11-2009.05	MPV Engine BMM Inner Diameter [32mm]		o	GHA232018	K
	2006.01-2009.05	MPV Engine BMN/CEGA 3 hole	•		GHA336004	K
	2006.01-2009.05	MPV Engine BMN/CEGA 4 hole	•		GHA336007	K
2.0 TDi 16V (103 kW)	2006.01-2009.05	MPV Engine BMN/CEGA Inner Diameter [32mm]		o	GHA232018	K
	2004.04-2009.05	MPV Engine BKD 3 hole	•		GHA336004	K
	2004.04-2009.05	MPV Engine BKD 4 hole	•		GHA336007	K
2.0 TFSi (147 kW)	2004.04-2009.05	MPV Engine BKD Inner Diameter [32mm]		o	GHA232018	K
	2005.11-2009.05	MPV Engine BWA 3 hole	•		GHA336004	K
	2005.11-2009.05	MPV Engine BWA 4 hole	•		GHA336007	K
	2005.11-2009.05	MPV Engine BWA Inner Diameter [32mm]		o	GHA232018	K
TOLEDO IV (KG3)						
1.2 (55 kW)	2012.07-	Hatchback Engine CGPC With ABS	•		GHA336001	K
1.2 TSi (63 kW)	2012.07-	Hatchback Engine CBZA With ABS	•		GHA336001	K
1.2 TSi (77 kW)	2012.07-	Hatchback Engine CBZB With ABS	•		GHA336001	K
1.4 TSi (90 kW)	2012.07-	Hatchback Engine CAXA With ABS	•		GHA336001	K
1.6 (77 kW)	2013.07-	Hatchback Engine CFNA With ABS	•		GHA336001	K
1.6 TDi (66 kW)	2013.06-	Hatchback Engine CAYB With ABS	•		GHA336001	K
1.6 TDi (77 kW)	2012.07-	Hatchback Engine CLNA/CAYC With ABS	•		GHA336001	K
SKODA						
CITIGO						
1.0 (44 kW)	2011.10-	Hatchback Engine CHYA		o	GHA228061	K
1.0 (55 kW)	2011.10-	Hatchback Engine CHYB		o	GHA228061	K
1.0 CNG (50 kW)	2012.11-	Hatchback Engine CPGA		o	GHA228061	K
FABIA						
1.2 (44 kW)	2007.05-	Hatchback Engine BBM/CHFA	•		GHA320002	K
	2007.05-	Hatchback Engine BBM/CHFA	•		GHA336013	K
	2007.05-	Hatchback Engine BBM/CHFA With ABS	•		GHA336001	K
	2007.05-	Hatchback Engine BBM/CHFA With ABS		o	GHA228036	K
	2007.05-	Hatchback Engine BBM/CHFA Without ABS	•		GHA336002	
	2007.05-	Hatchback Engine BBM/CHFA Without ABS		o	GHA228037	
	2007.05-	Hatchback Engine BZG/CEVA/CGPA/CHTA	•		GHA336013	K
1.2 (51 kW)	2007.05-	Hatchback Engine BZG/CEVA/CGPA/CHTA With ABS	•		GHA336001	K
	2007.05-	Hatchback Engine BZG/CEVA/CGPA/CHTA With ABS		o	GHA228036	K
	2007.05-	Hatchback Engine BZG/CEVA/CGPA/CHTA Without ABS	•		GHA336002	
	2007.05-	Hatchback Engine BZG/CEVA/CGPA/CHTA Without ABS		o	GHA228037	
1.2 12V (44 kW)	2011.11-	Hatchback Engine CGPB With ABS	•		GHA336001	K
	2011.11-	Hatchback Engine CGPB With ABS		o	GHA228036	K
	2011.11-	Hatchback Engine CGPB Without ABS	•		GHA336002	
1.2 TDi (55 kW)	2010.05-	Hatchback Engine CFWA With ABS	•		GHA336001	K
	2010.05-	Hatchback Engine CFWA With ABS		o	GHA228036	K
	2010.05-	Hatchback Engine CFWA Without ABS	•		GHA336002	
1.2 TSi (63 kW)	2010.03-	Hatchback Engine CBZA With ABS	•		GHA336001	K
	2010.03-	Hatchback Engine CBZA With ABS		o	GHA228036	K
	2010.03-	Hatchback Engine CBZA Without ABS	•		GHA336002	
	2010.03-	Hatchback Engine CBZA Without ABS		o	GHA228037	
1.2 TSi (77 kW)	2010.03-	Hatchback Engine CBZB With ABS	•		GHA336001	K
	2010.03-	Hatchback Engine CBZB With ABS		o	GHA228036	K
	2010.03-	Hatchback Engine CBZB Without ABS	•		GHA336002	
	2010.03-	Hatchback Engine CBZB Without ABS		o	GHA228037	
1.4 (63 kW)	2007.05-	Hatchback Engine BXW/CGGB	•		GHA336013	K
	2007.05-	Hatchback Engine BXW/CGGB With ABS	•		GHA336001	K
	2007.05-	Hatchback Engine BXW/CGGB With ABS		o	GHA228036	K
	2007.05-	Hatchback Engine BXW/CGGB Without ABS	•		GHA336002	
	2007.05-	Hatchback Engine BXW/CGGB Without ABS		o	GHA228037	



	 YEAR		F	R	G-AP Ref.	KIT
SKODA						
FABIA						
1.4 TDi (51 kW)	2007.05-	Hatchback Engine BNM	•		GHA336013	K
	2007.05-	Hatchback Engine BNM With ABS	•		GHA336001	K
	2007.05-	Hatchback Engine BNM With ABS		○	GHA228036	K
	2007.05-	Hatchback Engine BNM Without ABS	•		GHA336002	
	2007.05-	Hatchback Engine BNM Without ABS		○	GHA228037	
1.4 TDi (59 kW)	2007.05-	Hatchback Engine BMS/BNV	•		GHA336013	K
	2007.05-	Hatchback Engine BMS/BNV With ABS	•		GHA336001	K
	2007.05-	Hatchback Engine BMS/BNV With ABS		○	GHA228036	K
	2007.05-	Hatchback Engine BMS/BNV Without ABS	•		GHA336002	
	2007.05-	Hatchback Engine BMS/BNV Without ABS		○	GHA228037	
1.4 TSi RS (132 kW)	2010.05-	Hatchback Engine CAVE With ABS	•		GHA336001	K
	2010.05-	Hatchback Engine CAVE With ABS		○	GHA228036	K
	2010.05-	Hatchback Engine CAVE Without ABS	•		GHA336002	
	2010.05-	Hatchback Engine CAVE Without ABS		○	GHA228037	
1.6 (77 kW)	2007.05-	Hatchback Engine BTS/CFNA	•		GHA336013	K
	2007.05-	Hatchback Engine BTS/CFNA With ABS	•		GHA336001	K
	2007.05-	Hatchback Engine BTS/CFNA With ABS		○	GHA228036	K
	2007.05-	Hatchback Engine BTS/CFNA Without ABS	•		GHA336002	
	2007.05-	Hatchback Engine BTS/CFNA Without ABS		○	GHA228037	
1.6 TDi (55 kW)	2010.04-	Hatchback Engine CAYC With ABS	•		GHA336001	K
	2010.04-	Hatchback Engine CAYC With ABS		○	GHA228036	K
	2010.04-	Hatchback Engine CAYC Without ABS	•		GHA336002	
	2010.04-	Hatchback Engine CAYC Without ABS		○	GHA228037	
1.6 TDi (66 kW)	2010.03-	Hatchback Engine CAYB With ABS	•		GHA336001	K
	2010.03-	Hatchback Engine CAYB With ABS		○	GHA228036	K
	2010.03-	Hatchback Engine CAYB Without ABS	•		GHA336002	
	2010.03-	Hatchback Engine CAYB Without ABS		○	GHA228037	
1.6 TDi (77 kW)	2010.03-	Hatchback Engine CAYC With ABS	•		GHA336001	K
	2010.03-	Hatchback Engine CAYC With ABS		○	GHA228036	K
	2010.03-	Hatchback Engine CAYC Without ABS	•		GHA336002	
	2010.03-	Hatchback Engine CAYC Without ABS		○	GHA228037	
1.9 TDi (77 kW)	2007.05-	Hatchback Engine BLS/BSW	•		GHA336013	K
	2007.05-	Hatchback Engine BLS/BSW With ABS	•		GHA336001	K
	2007.05-	Hatchback Engine BLS/BSW With ABS		○	GHA228036	K
	2007.05-	Hatchback Engine BLS/BSW Without ABS	•		GHA336002	
	2007.05-	Hatchback Engine BLS/BSW Without ABS		○	GHA228037	
FABIA (6Y2)						
1.0 (37 kW)	1999.12-2002.08	Hatchback Engine AQV/ARV	•		GHA320002	K
	1999.12-2002.08	Hatchback Engine AQV/ARV With ABS	•		GHA336001	K
	1999.12-2002.08	Hatchback Engine AQV/ARV With ABS		○	GHA228036	K
	1999.12-2002.08	Hatchback Engine AQV/ARV Without ABS	•		GHA336002	
	1999.12-2002.08	Hatchback Engine AQV/ARV Without ABS		○	GHA228037	
1.2 (40 kW)	2002.08-2008.03	Hatchback Engine AWY/BMD	•		GHA320002	K
	2002.08-2008.03	Hatchback Engine AWY/BMD	•		GHA336013	K
	2002.08-2008.03	Hatchback Engine AWY/BMD With ABS	•		GHA336001	K
	2002.08-2008.03	Hatchback Engine AWY/BMD With ABS		○	GHA228036	K
	2002.08-2008.03	Hatchback Engine AWY/BMD Without ABS	•		GHA336002	
	2002.08-2008.03	Hatchback Engine AWY/BMD Without ABS		○	GHA228037	
1.2 (47 kW)	2003.01-2008.03	Hatchback Engine AZQ/BME	•		GHA320002	K
	2003.01-2008.03	Hatchback Engine AZQ/BME	•		GHA336013	K
	2003.01-2008.03	Hatchback Engine AZQ/BME With ABS	•		GHA336001	K
	2003.01-2008.03	Hatchback Engine AZQ/BME With ABS		○	GHA228036	K
	2003.01-2008.03	Hatchback Engine AZQ/BME Without ABS	•		GHA336002	
	2003.01-2008.03	Hatchback Engine AZQ/BME Without ABS		○	GHA228037	
1.4 (44 kW)	2000.08-2002.08	Hatchback Engine AZE/AZF	•		GHA320002	K
	2000.08-2002.08	Hatchback Engine AZE/AZF With ABS	•		GHA336001	K
	2000.08-2002.08	Hatchback Engine AZE/AZF With ABS		○	GHA228036	K
	2000.08-2002.08	Hatchback Engine AZE/AZF Without ABS	•		GHA336002	
	2000.08-2002.08	Hatchback Engine AZE/AZF Without ABS		○	GHA228037	
1.4 (50 kW)	1999.08-2003.05	Hatchback Engine AME/AQW/ATZ	•		GHA320002	K
	1999.08-2003.05	Hatchback Engine AME/AQW/ATZ With ABS	•		GHA336001	K
	1999.08-2003.05	Hatchback Engine AME/AQW/ATZ With ABS		○	GHA228036	K
	1999.08-2003.05	Hatchback Engine AME/AQW/ATZ Without ABS	•		GHA336002	
	1999.08-2003.05	Hatchback Engine AME/AQW/ATZ Without ABS		○	GHA228037	



	 YEAR		F	R	G-AP Ref.	KIT
SKODA						
FABIA (6Y2)						
1.4 16V (55 kW)	1999.12-2008.03	Hatchback Engine AUA/BBY/BKY	•		GHA320002	K
	1999.12-2008.03	Hatchback Engine AUA/BBY/BKY	•		GHA336013	K
	1999.12-2008.03	Hatchback Engine AUA/BBY/BKY With ABS	•		GHA336001	K
	1999.12-2008.03	Hatchback Engine AUA/BBY/BKY With ABS		○	GHA228036	K
	1999.12-2008.03	Hatchback Engine AUA/BBY/BKY Without ABS	•		GHA336002	
	1999.12-2008.03	Hatchback Engine AUA/BBY/BKY Without ABS		○	GHA228037	
1.4 16V (74 kW)	1999.12-2008.03	Hatchback Engine AUB/BBZ	•		GHA320002	K
	1999.12-2008.03	Hatchback Engine AUB/BBZ	•		GHA336013	K
	1999.12-2008.03	Hatchback Engine AUB/BBZ With ABS	•		GHA336001	K
	1999.12-2008.03	Hatchback Engine AUB/BBZ With ABS		○	GHA228036	K
	1999.12-2008.03	Hatchback Engine AUB/BBZ Without ABS	•		GHA336002	
	1999.12-2008.03	Hatchback Engine AUB/BBZ Without ABS		○	GHA228037	
1.4 TDi (51 kW)	2005.10-2008.03	Hatchback Engine BNM	•		GHA320002	K
	2005.10-2008.03	Hatchback Engine BNM	•		GHA336013	K
	2005.10-2008.03	Hatchback Engine BNM With ABS	•		GHA336001	K
	2005.10-2008.03	Hatchback Engine BNM With ABS		○	GHA228036	K
	2005.10-2008.03	Hatchback Engine BNM Without ABS	•		GHA336002	
	2005.10-2008.03	Hatchback Engine BNM Without ABS		○	GHA228037	
1.4 TDi (55 kW)	2003.04-2008.03	Hatchback Engine AMF	•		GHA320002	K
	2003.04-2008.03	Hatchback Engine AMF	•		GHA336013	K
	2003.04-2008.03	Hatchback Engine AMF With ABS	•		GHA336001	K
	2003.04-2008.03	Hatchback Engine AMF With ABS		○	GHA228036	K
	2003.04-2008.03	Hatchback Engine AMF Without ABS	•		GHA336002	
	2003.04-2008.03	Hatchback Engine AMF Without ABS		○	GHA228037	
1.4 TDi (59 kW)	2005.10-2008.03	Hatchback Engine BNV	•		GHA320002	K
	2005.10-2008.03	Hatchback Engine BNV	•		GHA336013	K
	2005.10-2008.03	Hatchback Engine BNV With ABS	•		GHA336001	K
	2005.10-2008.03	Hatchback Engine BNV With ABS		○	GHA228036	K
	2005.10-2008.03	Hatchback Engine BNV Without ABS	•		GHA336002	
	2005.10-2008.03	Hatchback Engine BNV Without ABS		○	GHA228037	
1.9 SDi (47 kW)	1999.12-2008.03	Hatchback Engine ASY	•		GHA320002	K
	1999.12-2008.03	Hatchback Engine ASY	•		GHA336013	K
	1999.12-2008.03	Hatchback Engine ASY With ABS	•		GHA336001	K
	1999.12-2008.03	Hatchback Engine ASY With ABS		○	GHA228036	K
	1999.12-2008.03	Hatchback Engine ASY Without ABS	•		GHA336002	
	1999.12-2008.03	Hatchback Engine ASY Without ABS		○	GHA228037	
1.9 TDi (74 kW)	2000.01-2008.03	Hatchback Engine ATD/AXR	•		GHA320002	K
	2000.01-2008.03	Hatchback Engine ATD/AXR	•		GHA336013	K
	2000.01-2008.03	Hatchback Engine ATD/AXR With ABS	•		GHA336001	K
	2000.01-2008.03	Hatchback Engine ATD/AXR With ABS		○	GHA228036	K
	2000.01-2008.03	Hatchback Engine ATD/AXR Without ABS	•		GHA336002	
	2000.01-2008.03	Hatchback Engine ATD/AXR Without ABS		○	GHA228037	
1.9 TDi RS (96 kW)	2003.06-2008.03	Hatchback Engine ASZ/BLT	•		GHA320002	K
	2003.06-2008.03	Hatchback Engine ASZ/BLT	•		GHA336013	K
	2003.06-2008.03	Hatchback Engine ASZ/BLT With ABS	•		GHA336001	K
	2003.06-2008.03	Hatchback Engine ASZ/BLT With ABS		○	GHA228036	K
	2003.06-2008.03	Hatchback Engine ASZ/BLT Without ABS	•		GHA336002	
	2003.06-2008.03	Hatchback Engine ASZ/BLT Without ABS		○	GHA228037	
2.0 (85 kW)	1999.12-2008.03	Hatchback Engine AZL	•		GHA320002	K
	1999.12-2008.03	Hatchback Engine AZL	•		GHA336013	K
	1999.12-2008.03	Hatchback Engine AZL With ABS	•		GHA336001	K
	1999.12-2008.03	Hatchback Engine AZL With ABS		○	GHA228036	K
	1999.12-2008.03	Hatchback Engine AZL Without ABS	•		GHA336002	
	1999.12-2008.03	Hatchback Engine AZL Without ABS		○	GHA228037	
FABIA (6Y3)						
1.2 (40 kW)	2001.07-2007.12	Saloon Engine AWY/BMD	•		GHA320002	K
	2001.07-2007.12	Saloon Engine AWY/BMD	•		GHA336013	K
	2001.07-2007.12	Saloon Engine AWY/BMD With ABS	•		GHA336001	K
	2001.07-2007.12	Saloon Engine AWY/BMD With ABS		○	GHA228036	K
	2001.07-2007.12	Saloon Engine AWY/BMD Without ABS	•		GHA336002	
	2001.07-2007.12	Saloon Engine AWY/BMD Without ABS		○	GHA228037	
1.2 (47 kW)	2003.01-2007.12	Saloon Engine AZQ/BME	•		GHA320002	K
	2003.01-2007.12	Saloon Engine AZQ/BME	•		GHA336013	K
	2003.01-2007.12	Saloon Engine AZQ/BME With ABS	•		GHA336001	K



	 YEAR		F	R	G-AP Ref.	KIT
SKODA						
FABIA (6Y3)						
1.2 (47 kW)	2003.01-2007.12	Saloon Engine AZQ/BME With ABS		o	GHA228036	K
	2003.01-2007.12	Saloon Engine AZQ/BME Without ABS	•		GHA336002	
	2003.01-2007.12	Saloon Engine AZQ/BME Without ABS		o	GHA228037	
1.4 (44 kW)	2000.04-2002.08	Saloon Engine AZE/AZF	•		GHA320002	K
	2000.04-2002.08	Saloon Engine AZE/AZF With ABS	•		GHA336001	K
	2000.04-2002.08	Saloon Engine AZE/AZF With ABS		o	GHA228036	K
	2000.04-2002.08	Saloon Engine AZE/AZF Without ABS	•		GHA336002	
	2000.04-2002.08	Saloon Engine AZE/AZF Without ABS		o	GHA228037	
1.4 (50 kW)	2001.07-2003.05	Saloon Engine AME/AQW/ATZ	•		GHA320002	K
	2001.07-2003.05	Saloon Engine AME/AQW/ATZ With ABS	•		GHA336001	K
	2001.07-2003.05	Saloon Engine AME/AQW/ATZ With ABS		o	GHA228036	K
	2001.07-2003.05	Saloon Engine AME/AQW/ATZ Without ABS	•		GHA336002	
	2001.07-2003.05	Saloon Engine AME/AQW/ATZ Without ABS		o	GHA228037	
1.4 16V (55 kW)	1999.10-2007.12	Saloon Engine AUA/BBY/BKY	•		GHA320002	K
	1999.10-2007.12	Saloon Engine AUA/BBY/BKY	•		GHA336013	K
	1999.10-2007.12	Saloon Engine AUA/BBY/BKY With ABS	•		GHA336001	K
	1999.10-2007.12	Saloon Engine AUA/BBY/BKY With ABS		o	GHA228036	K
	1999.10-2007.12	Saloon Engine AUA/BBY/BKY Without ABS	•		GHA336002	
	1999.10-2007.12	Saloon Engine AUA/BBY/BKY Without ABS		o	GHA228037	
1.4 16V (59 kW)	2006.04-2007.12	Saloon Engine BUD	•		GHA320002	K
	2006.04-2007.12	Saloon Engine BUD	•		GHA336013	K
	2006.04-2007.12	Saloon Engine BUD With ABS	•		GHA336001	K
	2006.04-2007.12	Saloon Engine BUD With ABS		o	GHA228036	K
	2006.04-2007.12	Saloon Engine BUD Without ABS	•		GHA336002	
	2006.04-2007.12	Saloon Engine BUD Without ABS		o	GHA228037	
1.4 16V (74 kW)	1999.12-2007.12	Saloon Engine AUB/BBZ	•		GHA320002	K
	1999.12-2007.12	Saloon Engine AUB/BBZ	•		GHA336013	K
	1999.12-2007.12	Saloon Engine AUB/BBZ With ABS	•		GHA336001	K
	1999.12-2007.12	Saloon Engine AUB/BBZ With ABS		o	GHA228036	K
	1999.12-2007.12	Saloon Engine AUB/BBZ Without ABS	•		GHA336002	
	1999.12-2007.12	Saloon Engine AUB/BBZ Without ABS		o	GHA228037	
1.4 TDi (51 kW)	2005.10-2007.12	Saloon Engine BNM	•		GHA320002	K
	2005.10-2007.12	Saloon Engine BNM	•		GHA336013	K
	2005.10-2007.12	Saloon Engine BNM With ABS	•		GHA336001	K
	2005.10-2007.12	Saloon Engine BNM With ABS		o	GHA228036	K
	2005.10-2007.12	Saloon Engine BNM Without ABS	•		GHA336002	
	2005.10-2007.12	Saloon Engine BNM Without ABS		o	GHA228037	
1.4 TDi (55 kW)	2003.04-2007.12	Saloon Engine AMF	•		GHA320002	K
	2003.04-2007.12	Saloon Engine AMF	•		GHA336013	K
	2003.04-2007.12	Saloon Engine AMF With ABS	•		GHA336001	K
	2003.04-2007.12	Saloon Engine AMF With ABS		o	GHA228036	K
	2003.04-2007.12	Saloon Engine AMF Without ABS	•		GHA336002	
	2003.04-2007.12	Saloon Engine AMF Without ABS		o	GHA228037	
1.4 TDi (59 kW)	2005.10-2007.12	Saloon Engine BNV	•		GHA320002	K
	2005.10-2007.12	Saloon Engine BNV	•		GHA336013	K
	2005.10-2007.12	Saloon Engine BNV With ABS	•		GHA336001	K
	2005.10-2007.12	Saloon Engine BNV With ABS		o	GHA228036	K
	2005.10-2007.12	Saloon Engine BNV Without ABS	•		GHA336002	
	2005.10-2007.12	Saloon Engine BNV Without ABS		o	GHA228037	
1.9 SDi (47 kW)	1999.11-2007.12	Saloon Engine ASY	•		GHA320002	K
	1999.11-2007.12	Saloon Engine ASY	•		GHA336013	K
	1999.11-2007.12	Saloon Engine ASY With ABS	•		GHA336001	K
	1999.11-2007.12	Saloon Engine ASY With ABS		o	GHA228036	K
	1999.11-2007.12	Saloon Engine ASY Without ABS	•		GHA336002	
	1999.11-2007.12	Saloon Engine ASY Without ABS		o	GHA228037	
1.9 TDi (74 kW)	2000.01-2007.12	Saloon Engine ATD/AXR	•		GHA320002	K
	2000.01-2007.12	Saloon Engine ATD/AXR	•		GHA336013	K
	2000.01-2007.12	Saloon Engine ATD/AXR With ABS	•		GHA336001	K
	2000.01-2007.12	Saloon Engine ATD/AXR With ABS		o	GHA228036	K
	2000.01-2007.12	Saloon Engine ATD/AXR Without ABS	•		GHA336002	
	2000.01-2007.12	Saloon Engine ATD/AXR Without ABS		o	GHA228037	
2.0 (85 kW)	1999.12-2007.12	Saloon Engine AZL	•		GHA320002	K
	1999.12-2007.12	Saloon Engine AZL	•		GHA336013	K
	1999.12-2007.12	Saloon Engine AZL With ABS	•		GHA336001	K



	 YEAR		F	R	G-AP Ref.	KIT
SKODA						
FABIA (6Y3)						
2.0 (85 kW)	1999.12-2007.12	Saloon Engine AZL With ABS		o	GHA228036	K
	1999.12-2007.12	Saloon Engine AZL Without ABS	•		GHA336002	
	1999.12-2007.12	Saloon Engine AZL Without ABS		o	GHA228037	
FABIA (6Y5)						
1.2 (40 kW)	2001.07-2007.12	Estate Engine AWY/BMD	•		GHA320002	K
	2001.07-2007.12	Estate Engine AWY/BMD	•		GHA336013	K
	2001.07-2007.12	Estate Engine AWY/BMD With ABS	•		GHA336001	K
	2001.07-2007.12	Estate Engine AWY/BMD With ABS		o	GHA228036	K
	2001.07-2007.12	Estate Engine AWY/BMD Without ABS	•		GHA336002	
	2001.07-2007.12	Estate Engine AWY/BMD Without ABS		o	GHA228037	
1.2 (47 kW)	2003.01-2007.12	Estate Engine AZQ/BME	•		GHA320002	K
	2003.01-2007.12	Estate Engine AZQ/BME	•		GHA336013	K
	2003.01-2007.12	Estate Engine AZQ/BME With ABS	•		GHA336001	K
	2003.01-2007.12	Estate Engine AZQ/BME With ABS		o	GHA228036	K
	2003.01-2007.12	Estate Engine AZQ/BME Without ABS	•		GHA336002	
	2003.01-2007.12	Estate Engine AZQ/BME Without ABS		o	GHA228037	
1.4 (44 kW)	2000.04-2003.03	Estate Engine AZE/AZF	•		GHA320002	K
	2000.04-2003.03	Estate Engine AZE/AZF With ABS	•		GHA336001	K
	2000.04-2003.03	Estate Engine AZE/AZF With ABS		o	GHA228036	K
	2000.04-2003.03	Estate Engine AZE/AZF Without ABS	•		GHA336002	
	2000.04-2003.03	Estate Engine AZE/AZF Without ABS		o	GHA228037	
1.4 (50 kW)	2000.04-2003.05	Estate Engine AME/AQW/ATZ	•		GHA320002	K
	2000.04-2003.05	Estate Engine AME/AQW/ATZ With ABS	•		GHA336001	K
	2000.04-2003.05	Estate Engine AME/AQW/ATZ With ABS		o	GHA228036	K
	2000.04-2003.05	Estate Engine AME/AQW/ATZ Without ABS	•		GHA336002	
	2000.04-2003.05	Estate Engine AME/AQW/ATZ Without ABS		o	GHA228037	
1.4 16V (55 kW)	2000.05-2007.12	Estate Engine AUA/BBY/BKY	•		GHA320002	K
	2000.05-2007.12	Estate Engine AUA/BBY/BKY	•		GHA336013	K
	2000.05-2007.12	Estate Engine AUA/BBY/BKY With ABS	•		GHA336001	K
	2000.05-2007.12	Estate Engine AUA/BBY/BKY With ABS		o	GHA228036	K
	2000.05-2007.12	Estate Engine AUA/BBY/BKY Without ABS	•		GHA336002	
	2000.05-2007.12	Estate Engine AUA/BBY/BKY Without ABS		o	GHA228037	
1.4 16V (59 kW)	2006.04-2007.12	Estate Engine BUD	•		GHA320002	K
	2006.04-2007.12	Estate Engine BUD	•		GHA336013	K
	2006.04-2007.12	Estate Engine BUD With ABS	•		GHA336001	K
	2006.04-2007.12	Estate Engine BUD With ABS		o	GHA228036	K
	2006.04-2007.12	Estate Engine BUD Without ABS	•		GHA336002	
	2006.04-2007.12	Estate Engine BUD Without ABS		o	GHA228037	
1.4 16V (74 kW)	2000.04-2007.12	Estate Engine AUB/BBZ	•		GHA320002	K
	2000.04-2007.12	Estate Engine AUB/BBZ	•		GHA336013	K
	2000.04-2007.12	Estate Engine AUB/BBZ With ABS	•		GHA336001	K
	2000.04-2007.12	Estate Engine AUB/BBZ With ABS		o	GHA228036	K
	2000.04-2007.12	Estate Engine AUB/BBZ Without ABS	•		GHA336002	
	2000.04-2007.12	Estate Engine AUB/BBZ Without ABS		o	GHA228037	
1.4 TDi (51 kW)	2005.10-2007.12	Estate Engine BNM	•		GHA320002	K
	2005.10-2007.12	Estate Engine BNM	•		GHA336013	K
	2005.10-2007.12	Estate Engine BNM With ABS	•		GHA336001	K
	2005.10-2007.12	Estate Engine BNM With ABS		o	GHA228036	K
	2005.10-2007.12	Estate Engine BNM Without ABS	•		GHA336002	
	2005.10-2007.12	Estate Engine BNM Without ABS		o	GHA228037	
1.4 TDi (55 kW)	2003.04-2007.12	Estate Engine AMF	•		GHA320002	K
	2003.04-2007.12	Estate Engine AMF	•		GHA336013	K
	2003.04-2007.12	Estate Engine AMF With ABS	•		GHA336001	K
	2003.04-2007.12	Estate Engine AMF With ABS		o	GHA228036	K
	2003.04-2007.12	Estate Engine AMF Without ABS	•		GHA336002	
	2003.04-2007.12	Estate Engine AMF Without ABS		o	GHA228037	
1.4 TDi (59 kW)	2005.10-2007.12	Estate Engine BNV	•		GHA320002	K
	2005.10-2007.12	Estate Engine BNV	•		GHA336013	K
	2005.10-2007.12	Estate Engine BNV With ABS	•		GHA336001	K
	2005.10-2007.12	Estate Engine BNV With ABS		o	GHA228036	K
	2005.10-2007.12	Estate Engine BNV Without ABS	•		GHA336002	
	2005.10-2007.12	Estate Engine BNV Without ABS		o	GHA228037	
1.9 SDi (47 kW)	2000.04-2007.12	Estate Engine ASY	•		GHA320002	K
	2000.04-2007.12	Estate Engine ASY	•		GHA336013	K



	 YEAR		F	R	G-AP Ref.	KIT
SKODA						
FABIA (6Y5)						
1.9 SDi (47 kW)	2000.04-2007.12	Estate Engine ASY With ABS	•		GHA336001	K
	2000.04-2007.12	Estate Engine ASY With ABS		◦	GHA228036	K
	2000.04-2007.12	Estate Engine ASY Without ABS	•		GHA336002	
	2000.04-2007.12	Estate Engine ASY Without ABS		◦	GHA228037	
1.9 TDi (74 kW)	2000.04-2007.12	Estate Engine ATD/AXR	•		GHA320002	K
	2000.04-2007.12	Estate Engine ATD/AXR	•		GHA336013	K
	2000.04-2007.12	Estate Engine ATD/AXR With ABS	•		GHA336001	K
	2000.04-2007.12	Estate Engine ATD/AXR With ABS		◦	GHA228036	K
	2000.04-2007.12	Estate Engine ATD/AXR Without ABS	•		GHA336002	
	2000.04-2007.12	Estate Engine ATD/AXR Without ABS		◦	GHA228037	
2.0 (85 kW)	2000.04-2007.12	Estate Engine AZL	•		GHA320002	K
	2000.04-2007.12	Estate Engine AZL	•		GHA336013	K
	2000.04-2007.12	Estate Engine AZL With ABS	•		GHA336001	K
	2000.04-2007.12	Estate Engine AZL With ABS		◦	GHA228036	K
	2000.04-2007.12	Estate Engine AZL Without ABS	•		GHA336002	
	2000.04-2007.12	Estate Engine AZL Without ABS		◦	GHA228037	
FABIA (NJ3)						
1.0 (44 kW)	2014.08-	Hatchback Engine CHYA With ABS	•		GHA336001	K
	2014.08-	Hatchback Engine CHYA With ABS		◦	GHA228036	K
1.0 (55 kW)	2014.08-	Hatchback Engine CHYB With ABS	•		GHA336001	K
	2014.08-	Hatchback Engine CHYB With ABS		◦	GHA228036	K
1.2 TSi (66 kW)	2014.08-	Hatchback Engine CJZC With ABS	•		GHA336001	K
	2014.08-	Hatchback Engine CJZC With ABS		◦	GHA228036	K
1.2 TSi (81 kW)	2014.08-	Hatchback Engine CJZD With ABS	•		GHA336001	K
	2014.08-	Hatchback Engine CJZD With ABS		◦	GHA228036	K
1.4 TDi (66 kW)	2014.08-	Hatchback Engine CUSB With ABS	•		GHA336001	K
	2014.08-	Hatchback Engine CUSB With ABS		◦	GHA228036	K
1.4 TDi (77 kW)	2014.08-	Hatchback Engine CUTA With ABS	•		GHA336001	K
	2014.08-	Hatchback Engine CUTA With ABS		◦	GHA228036	K
FABIA (NJ5)						
1.0 (44 kW)	2014.10-	Estate Engine CHYA With ABS	•		GHA336001	K
	2014.10-	Estate Engine CHYA With ABS		◦	GHA228036	K
1.0 (55 kW)	2014.10-	Estate Engine CHYB With ABS	•		GHA336001	K
	2014.10-	Estate Engine CHYB With ABS		◦	GHA228036	K
1.2 TSi (66 kW)	2014.10-	Estate Engine CJZC With ABS	•		GHA336001	K
	2014.10-	Estate Engine CJZC With ABS		◦	GHA228036	K
1.2 TSi (81 kW)	2014.10-	Estate Engine CJZD With ABS	•		GHA336001	K
	2014.10-	Estate Engine CJZD With ABS		◦	GHA228036	K
1.4 TDi (66 kW)	2014.10-	Estate Engine CUSB With ABS	•		GHA336001	K
	2014.10-	Estate Engine CUSB With ABS		◦	GHA228036	K
1.4 TDi (77 kW)	2014.10-	Estate Engine CUTA With ABS	•		GHA336001	K
	2014.10-	Estate Engine CUTA With ABS		◦	GHA228036	K
FABIA COMBI						
1.2 (44 kW)	2007.10-	Estate Engine BBM/CHFA	•		GHA336013	K
	2007.10-	Estate Engine BBM/CHFA With ABS	•		GHA336001	K
	2007.10-	Estate Engine BBM/CHFA With ABS		◦	GHA228036	K
	2007.10-	Estate Engine BBM/CHFA Without ABS	•		GHA336002	
	2007.10-	Estate Engine BBM/CHFA Without ABS		◦	GHA228037	
1.2 (51 kW)	2007.11-	Estate Engine BZG/CEVA/CGPA/CHTA	•		GHA336013	K
	2007.11-	Estate Engine BZG/CEVA/CGPA/CHTA With ABS	•		GHA336001	K
	2007.11-	Estate Engine BZG/CEVA/CGPA/CHTA With ABS		◦	GHA228036	K
	2007.11-	Estate Engine BZG/CEVA/CGPA/CHTA Without ABS	•		GHA336002	
	2007.11-	Estate Engine BZG/CEVA/CGPA/CHTA Without ABS		◦	GHA228037	
1.2 12V (44 kW)	2011.11-	Estate Engine CGPB With ABS	•		GHA336001	K
	2011.11-	Estate Engine CGPB With ABS		◦	GHA228036	K
	2011.11-	Estate Engine CGPB Without ABS	•		GHA336002	
1.2 TDi (55 kW)	2010.05-	Estate Engine CFWA With ABS	•		GHA336001	K
	2010.05-	Estate Engine CFWA With ABS		◦	GHA228036	K
	2010.05-	Estate Engine CFWA Without ABS	•		GHA336002	
1.2 TSi (63 kW)	2010.03-	Estate Engine CBZA With ABS	•		GHA336001	K
	2010.03-	Estate Engine CBZA With ABS		◦	GHA228036	K
	2010.03-	Estate Engine CBZA Without ABS	•		GHA336002	
	2010.03-	Estate Engine CBZA Without ABS		◦	GHA228037	
1.2 TSi (77 kW)	2010.03-	Estate Engine CBZB With ABS	•		GHA336001	K



	 YEAR		F	R	G-AP Ref.	KIT
SKODA						
FABIA COMBI						
1.2 TSi (77 kW)	2010.03-	Estate Engine CBZB With ABS		o	GHA228036	K
	2010.03-	Estate Engine CBZB Without ABS	•		GHA336002	
	2010.03-	Estate Engine CBZB Without ABS		o	GHA228037	
1.4 (63 kW)	2007.11-	Estate Engine BXW/CGGB	•		GHA336013	K
	2007.11-	Estate Engine BXW/CGGB With ABS	•		GHA336001	K
	2007.11-	Estate Engine BXW/CGGB With ABS		o	GHA228036	K
	2007.11-	Estate Engine BXW/CGGB Without ABS	•		GHA336002	
	2007.11-	Estate Engine BXW/CGGB Without ABS		o	GHA228037	
1.4 TDi (51 kW)	2007.11-	Estate Engine BNM	•		GHA336013	K
	2007.11-	Estate Engine BNM With ABS	•		GHA336001	K
	2007.11-	Estate Engine BNM With ABS		o	GHA228036	K
	2007.11-	Estate Engine BNM Without ABS	•		GHA336002	
	2007.11-	Estate Engine BNM Without ABS		o	GHA228037	
1.4 TDi (59 kW)	2007.11-	Estate Engine BMS/BNV	•		GHA336013	K
	2007.11-	Estate Engine BMS/BNV With ABS	•		GHA336001	K
	2007.11-	Estate Engine BMS/BNV With ABS		o	GHA228036	K
	2007.11-	Estate Engine BMS/BNV Without ABS	•		GHA336002	
	2007.11-	Estate Engine BMS/BNV Without ABS		o	GHA228037	
1.4 TSi RS (132 kW)	2010.05-	Estate Engine CAVE/CTHE With ABS	•		GHA336001	K
	2010.05-	Estate Engine CAVE/CTHE With ABS		o	GHA228036	K
	2010.05-	Estate Engine CAVE/CTHE Without ABS	•		GHA336002	
	2010.05-	Estate Engine CAVE/CTHE Without ABS		o	GHA228037	
1.6 (77 kW)	2007.11-	Estate Engine BTS/CFNA	•		GHA336013	K
	2007.11-	Estate Engine BTS/CFNA With ABS	•		GHA336001	K
	2007.11-	Estate Engine BTS/CFNA With ABS		o	GHA228036	K
	2007.11-	Estate Engine BTS/CFNA Without ABS	•		GHA336002	
	2007.11-	Estate Engine BTS/CFNA Without ABS		o	GHA228037	
1.6 TDi (55 kW)	2010.04-	Estate Engine CAYA With ABS	•		GHA336001	K
	2010.04-	Estate Engine CAYA With ABS		o	GHA228036	K
	2010.04-	Estate Engine CAYA Without ABS	•		GHA336002	
	2010.04-	Estate Engine CAYA Without ABS		o	GHA228037	
1.6 TDi (66 kW)	2010.03-	Estate Engine CAYB With ABS	•		GHA336001	K
	2010.03-	Estate Engine CAYB With ABS		o	GHA228036	K
	2010.03-	Estate Engine CAYB Without ABS	•		GHA336002	
	2010.03-	Estate Engine CAYB Without ABS		o	GHA228037	
1.6 TDi (77 kW)	2010.03-	Estate Engine CAYC With ABS	•		GHA336001	K
	2010.03-	Estate Engine CAYC With ABS		o	GHA228036	K
	2010.03-	Estate Engine CAYC Without ABS	•		GHA336002	
	2010.03-	Estate Engine CAYC Without ABS		o	GHA228037	
1.9 TDi (77 kW)	2007.11-	Estate Engine BLS/BSW	•		GHA336013	K
	2007.11-	Estate Engine BLS/BSW With ABS	•		GHA336001	K
	2007.11-	Estate Engine BLS/BSW With ABS		o	GHA228036	K
	2007.11-	Estate Engine BLS/BSW Without ABS	•		GHA336002	
	2007.11-	Estate Engine BLS/BSW Without ABS		o	GHA228037	
FABIA PRAKTIK						
1.2 (40 kW)	2001.07-2007.12	Box Engine AWY/BMD	•		GHA320002	K
	2001.07-2007.12	Box Engine AWY/BMD	•		GHA336013	K
	2001.07-2007.12	Box Engine AWY/BMD With ABS	•		GHA336001	K
	2001.07-2007.12	Box Engine AWY/BMD With ABS		o	GHA228036	K
	2001.07-2007.12	Box Engine AWY/BMD Without ABS	•		GHA336002	
	2001.07-2007.12	Box Engine AWY/BMD Without ABS		o	GHA228037	
1.2 (47 kW)	2003.01-2007.12	Box Engine AZQ/BME	•		GHA320002	K
	2003.01-2007.12	Box Engine AZQ/BME	•		GHA336013	K
	2003.01-2007.12	Box Engine AZQ/BME With ABS	•		GHA336001	K
	2003.01-2007.12	Box Engine AZQ/BME With ABS		o	GHA228036	K
	2003.01-2007.12	Box Engine AZQ/BME Without ABS	•		GHA336002	
	2003.01-2007.12	Box Engine AZQ/BME Without ABS		o	GHA228037	
1.4 (50 kW)	2001.07-2003.05	Box Engine AME/AQW/ATZ	•		GHA320002	K
	2001.07-2003.05	Box Engine AME/AQW/ATZ With ABS	•		GHA336001	K
	2001.07-2003.05	Box Engine AME/AQW/ATZ With ABS		o	GHA228036	K
	2001.07-2003.05	Box Engine AME/AQW/ATZ Without ABS	•		GHA336002	
	2001.07-2003.05	Box Engine AME/AQW/ATZ Without ABS		o	GHA228037	
1.4 TDi (51 kW)	2005.10-2007.12	Box Engine BNM	•		GHA320002	K
	2005.10-2007.12	Box Engine BNM	•		GHA336013	K



	 YEAR		F	R	G-AP Ref.	KIT
SKODA						
FABIA PRAKTIK						
1.4 TDi (51 kW)	2005.10-2007.12	Box Engine BNM With ABS	•		GHA336001	K
	2005.10-2007.12	Box Engine BNM With ABS		◦	GHA228036	K
	2005.10-2007.12	Box Engine BNM Without ABS	•		GHA336002	
	2005.10-2007.12	Box Engine BNM Without ABS		◦	GHA228037	
1.9 SDi (47 kW)	2001.07-2007.12	Box Engine ASY	•		GHA320002	K
	2001.07-2007.12	Box Engine ASY	•		GHA336013	K
	2001.07-2007.12	Box Engine ASY With ABS	•		GHA336001	K
	2001.07-2007.12	Box Engine ASY Without ABS	•		GHA336002	
	2001.07-2007.12	Box Engine ASY Without ABS		◦	GHA228037	
FAVORIT (781)						
1.3 (50 kW)	1994.01-1994.09	Hatchback Engine 136B	•		GWB3441	
	1994.01-1994.09	Hatchback Engine 136B		◦	GWB0529	
1.3 135 (42 kW)	1991.12-1994.09	Hatchback Engine 781.135	•		GWB3441	
	1991.12-1994.09	Hatchback Engine 781.135		◦	GWB0529	
	1991.12-1994.09	Hatchback Engine 781.135		◦	GWB1430	
1.3 135 (43 kW)	1991.12-1994.09	Hatchback Engine 781.135	•		GWB3441	
	1991.12-1994.09	Hatchback Engine 781.135		◦	GWB0529	
	1991.12-1994.09	Hatchback Engine 781.135		◦	GWB1430	
1.3 135 (44 kW)	1990.10-1994.09	Hatchback Engine 781.135	•		GWB3441	
	1990.10-1994.09	Hatchback Engine 781.135		◦	GWB0529	
	1990.10-1994.09	Hatchback Engine 781.135		◦	GWB1430	
1.3 135 X,LX,GLX (40 kW)	1990.01-1994.09	Hatchback Engine 781.135E	•		GWB3441	
	1990.01-1994.09	Hatchback Engine 781.135E		◦	GWB0529	
	1990.01-1994.09	Hatchback Engine 781.135E		◦	GWB1430	
1.3 136 (45 kW)	1990.10-1994.09	Hatchback Engine 136L	•		GWB3441	
	1990.10-1994.09	Hatchback Engine 136L		◦	GWB0529	
	1990.10-1994.09	Hatchback Engine 136L		◦	GWB1430	
FAVORIT (787)						
1.3 (40 kW)	1992.12-1997.06	Pickup Engine 135B	•		GWB3441	
	1992.12-1997.06	Pickup Engine 135B		◦	GWB0529	
	1992.12-1997.06	Pickup Engine 135B		◦	GWB1430	
1.3 (42 kW)	1992.12-1997.06	Pickup Engine 781.135	•		GWB3441	
	1992.12-1997.06	Pickup Engine 781.135		◦	GWB0529	
	1992.12-1997.06	Pickup Engine 781.135		◦	GWB1430	
1.3 (50 kW)	1992.12-1997.06	Pickup Engine 136B	•		GWB3441	
	1992.12-1997.06	Pickup Engine 136B		◦	GWB0529	
	1992.12-1997.06	Pickup Engine 136B		◦	GWB1430	
FAVORIT FORMAN (785)						
1.3 (40 kW)	1991.09-1995.06	Estate Engine 781.135E	•		GWB3441	
	1991.09-1995.06	Estate Engine 781.135E		◦	GWB0529	
	1991.09-1995.06	Estate Engine 781.135E		◦	GWB1430	
1.3 (43 kW)	1993.01-1993.12	Estate	•		GWB3441	
	1993.01-1993.12	Estate		◦	GWB0529	
1.3 (44 kW)	1991.12-1995.06	Estate Engine 781.135	•		GWB3441	
	1991.12-1995.06	Estate Engine 781.135		◦	GWB0529	
	1991.12-1995.06	Estate Engine 781.135		◦	GWB1430	
1.3 (45 kW)	1991.08-1995.06	Estate Engine OHC	•		GWB3441	
	1991.08-1995.06	Estate Engine OHC		◦	GWB0529	
	1991.08-1995.06	Estate Engine OHC		◦	GWB1430	
1.3 (50 kW)	1994.01-1995.06	Estate Engine 136B	•		GWB3441	
	1994.01-1995.06	Estate Engine 136B		◦	GWB0529	
FELICIA (6U1)						
1.3 (40 kW)	1994.10-1998.03	Hatchback Engine 135B/AMG	•		GWB3441	
	1994.10-1998.03	Hatchback Engine 135B/AMG		◦	GWB0529	
1.3 (43 kW)	1994.10-1998.03	Hatchback Engine 135L/AMJ	•		GWB3441	
	1994.10-1998.03	Hatchback Engine 135L/AMJ		◦	GWB0529	
1.3 (50 kW)	1994.10-1998.03	Hatchback Engine 136B/AMH	•		GWB3441	
	1994.10-1998.03	Hatchback Engine 136B/AMH		◦	GWB0529	
1.6 LX (55 kW)	1995.08-1998.03	Hatchback Engine AEE/EA111	•		GWB3441	
	1995.08-1998.03	Hatchback Engine AEE/EA111		◦	GWB0529	
1.9 D (47 kW)	1995.10-1998.03	Hatchback Engine AEF	•		GWB3441	
	1995.10-1998.03	Hatchback Engine AEF		◦	GWB0529	



	 YEAR		F	R	G-AP Ref.	KIT
SKODA						
FELICIA (6U5)						
1.3 (43 kW)	1995.08-1998.03	Estate Engine 135L/AMJ	•		GWB3441	
	1995.08-1998.03	Estate Engine 135L/AMJ		○	GWB0529	
1.3 LX (40 kW)	1995.08-1998.03	Estate Engine 135B/AMG	•		GWB3441	
	1995.08-1998.03	Estate Engine 135B/AMG		○	GWB0529	
1.3 LXI (50 kW)	1995.08-1998.03	Estate Engine 136B/AMH	•		GWB3441	
	1995.08-1998.03	Estate Engine 136B/AMH		○	GWB0529	
1.6 GLX (55 kW)	1995.08-1998.03	Estate Engine AEE	•		GWB3441	
	1995.08-1998.03	Estate Engine AEE		○	GWB0529	
1.9 D (47 kW)	1995.10-1998.03	Estate Engine AEF	•		GWB3441	
	1995.10-1998.03	Estate Engine AEF		○	GWB0529	
FELICIA I FUN (797)						
1.3 (40 kW)	1997.06-2002.04	Pickup Engine 135B/135M/AMG	•		GWB3441	
	1997.06-2002.04	Pickup Engine 135B/135M/AMG		○	GWB0529	
1.3 (50 kW)	1997.06-2002.04	Pickup Engine 136B/136M/AMH	•		GWB3441	
	1997.06-2002.04	Pickup Engine 136B/136M/AMH		○	GWB0529	
1.6 (55 kW)	1997.06-2002.04	Pickup Engine AEE	•		GWB3441	
	1997.06-2002.04	Pickup Engine AEE		○	GWB0529	
1.9 D (47 kW)	1997.06-2002.04	Pickup Engine AEF	•		GWB3441	
	1997.06-2002.04	Pickup Engine AEF		○	GWB0529	
FELICIA II (6U1)						
1.3 (40 kW)	1998.01-2001.06	Hatchback Engine AMG	•		GWB3441	
	1998.01-2001.06	Hatchback Engine AMG		○	GWB0529	
1.3 (43 kW)	1998.01-2001.06	Hatchback Engine AMJ	•		GWB3441	
	1998.01-2001.06	Hatchback Engine AMJ		○	GWB0529	
1.3 (50 kW)	1998.01-2001.06	Hatchback Engine AMH	•		GWB3441	
	1998.01-2001.06	Hatchback Engine AMH		○	GWB0529	
1.6 (55 kW)	1998.01-2001.06	Estate Engine AEE	•		GWB3441	
	1998.01-2001.06	Estate Engine AEE		○	GWB0529	
	1998.01-2001.06	Hatchback Engine AEE	•		GWB3441	
	1998.01-2001.06	Hatchback Engine AEE		○	GWB0529	
1.9 D (47 kW)	1998.01-2001.06	Hatchback Engine AEF	•		GWB3441	
	1998.01-2001.06	Hatchback Engine AEF		○	GWB0529	
FELICIA II (6U5)						
1.3 (50 kW)	1998.01-2001.06	Estate Engine AMH	•		GWB3441	
	1998.01-2001.06	Estate Engine AMH		○	GWB0529	
1.9 D (47 kW)	1998.01-2001.06	Estate Engine AEF	•		GWB3441	
	1998.01-2001.06	Estate Engine AEF		○	GWB0529	
OCTAVIA (1U2)						
1.4 (44 kW)	1999.04-2001.03	Hatchback Engine AMD	•		GHA436002	K
	1999.04-2001.03	Hatchback Engine AMD	•		GWB3455	
	1999.04-2001.03	Hatchback Engine AMD With ABS		○	GHA230051	K
1.4 16V (55 kW)	2000.09-2010.12	Hatchback Engine AXP/BCA	•		GHA436002	K
	2000.09-2010.12	Hatchback Engine AXP/BCA	•		GWB3455	
	2000.09-2010.12	Hatchback Engine AXP/BCA With ABS		○	GHA230051	K
1.6 (55 kW)	1996.09-2004.09	Hatchback Engine AEE	•		GHA436002	K
	1996.09-2004.09	Hatchback Engine AEE	•		GWB3455	
	1996.09-2004.09	Hatchback Engine AEE With ABS		○	GHA230051	K
1.6 (74 kW)	1997.02-2007.12	Hatchback Engine AEH/AKL	•		GHA436002	K
	1997.02-2007.12	Hatchback Engine AEH/AKL	•		GWB3455	
	1997.02-2007.12	Hatchback Engine AEH/AKL With ABS		○	GHA230051	K
1.6 (75 kW)	2000.11-2010.12	Hatchback Engine AVU/BFQ	•		GHA436002	K
	2000.11-2010.12	Hatchback Engine AVU/BFQ	•		GWB3455	
	2000.11-2010.12	Hatchback Engine AVU/BFQ With ABS		○	GHA230051	K
1.8 (92 kW)	1996.09-2000.07	Hatchback Engine AGN	•		GWB3455	
	1996.09-2000.07	Hatchback Engine AGN With ABS		○	GHA230051	K
1.8 T (110 kW)	1997.08-2010.12	Hatchback Engine AGU/ARX/ARZ/AUM	•		GHA436002	K
	1997.08-2010.12	Hatchback Engine AGU/ARX/ARZ/AUM	•		GWB3455	
	1997.08-2010.12	Hatchback Engine AGU/ARX/ARZ/AUM With ABS		○	GHA230051	K
1.8 T 4x4 (110 kW)	2001.05-2006.05	Hatchback Engine ARX	•		GHA436002	K
	2001.05-2006.05	Hatchback Engine ARX	•		GWB3455	
1.9 SDi (50 kW)	1997.06-2003.12	Hatchback Engine AGP/AQM	•		GHA436002	K
	1997.06-2003.12	Hatchback Engine AGP/AQM	•		GWB3455	
	1997.06-2003.12	Hatchback Engine AGP/AQM With ABS		○	GHA230051	K
1.9 TDi (66 kW)	1996.09-2010.03	Hatchback Engine AGR/ALH	•		GHA436002	K



	 YEAR		F	R	G-AP Ref.	KIT
SKODA						
OCTAVIA (1U2)						
1.9 TDi (66 kW)	1996.09-2010.03	Hatchback Engine AGR/ALH	•		GWB3455	
	1996.09-2010.03	Hatchback Engine AGR/ALH With ABS		◦	GHA230051	K
1.9 TDi (74 kW)	2005.10-2010.12	Hatchback Engine AXR	•		GHA436002	K
	2005.10-2010.12	Hatchback Engine AXR	•		GWB3455	
	2005.10-2010.12	Hatchback Engine AXR With ABS		◦	GHA230051	K
1.9 TDi (81 kW)	1997.08-2006.01	Hatchback Engine AHF/ASV	•		GHA436002	K
	1997.08-2006.01	Hatchback Engine AHF/ASV	•		GWB3455	
	1997.08-2006.01	Hatchback Engine AHF/ASV With ABS		◦	GHA230051	K
1.9 TDi (96 kW)	2003.05-2004.05	Hatchback Engine ASZ	•		GWB3455	
	2003.05-2004.05	Hatchback Engine ASZ With ABS		◦	GHA230051	K
2.0 (85 kW)	1999.04-2007.05	Hatchback Engine AEG/APK/AQY/AZH/AZJ	•		GHA436002	K
	1999.04-2007.05	Hatchback Engine AEG/APK/AQY/AZH/AZJ	•		GWB3455	
	1999.04-2007.05	Hatchback Engine AEG/APK/AQY/AZH/AZJ With ABS		◦	GHA230051	K
RS 1.8 T (132 kW)	2001.05-2006.01	Hatchback Engine AUQ	•		GHA436002	K
	2001.05-2006.01	Hatchback Engine AUQ	•		GWB3455	
	2001.05-2006.01	Hatchback Engine AUQ With ABS		◦	GHA230051	K
OCTAVIA (1U5)						
1.4 16V (55 kW)	2000.08-2010.12	Estate Engine AXP/BCA	•		GHA436002	K
	2000.08-2010.12	Estate Engine AXP/BCA	•		GWB3455	
	2000.08-2010.12	Estate Engine AXP/BCA With ABS		◦	GHA230051	K
1.6 (55 kW)	1998.07-2004.09	Estate Engine AEE	•		GHA436002	K
	1998.07-2004.09	Estate Engine AEE	•		GWB3455	
	1998.07-2004.09	Estate Engine AEE With ABS		◦	GHA230051	K
1.6 (74 kW)	1998.07-2007.12	Estate Engine AEH/AKL	•		GHA436002	K
	1998.07-2007.12	Estate Engine AEH/AKL	•		GWB3455	
	1998.07-2007.12	Estate Engine AEH/AKL With ABS		◦	GHA230051	K
1.6 (75 kW)	2000.09-2010.12	Estate Engine AVU/BFQ	•		GHA436002	K
	2000.09-2010.12	Estate Engine AVU/BFQ	•		GWB3455	
	2000.09-2010.12	Estate Engine AVU/BFQ With ABS		◦	GHA230051	K
1.8 20V (92 kW)	1998.07-2000.07	Estate Engine AGN	•		GWB3455	
	1998.07-2000.07	Estate Engine AGN With ABS		◦	GHA230051	K
1.8 T (110 kW)	1998.07-2010.12	Estate Engine AGU/ARX/ARZ/AUM	•		GHA436002	K
	1998.07-2010.12	Estate Engine AGU/ARX/ARZ/AUM	•		GWB3455	
	1998.07-2010.12	Estate Engine AGU/ARX/ARZ/AUM With ABS		◦	GHA230051	K
1.8 T 4x4 (110 kW)	2001.05-2006.05	Estate Engine ARX	•		GWB3455	
	2001.05-2006.05	Estate Engine ARX		◦	GHA436002	K
1.9 SDi (50 kW)	1998.07-2003.12	Estate Engine AGP/AQM	•		GHA436002	K
	1998.07-2003.12	Estate Engine AGP/AQM	•		GWB3455	
	1998.07-2003.12	Estate Engine AGP/AQM With ABS		◦	GHA230051	K
1.9 TDi (66 kW)	1998.07-2010.03	Estate Engine AGR/ALH	•		GHA436002	K
	1998.07-2010.03	Estate Engine AGR/ALH	•		GWB3455	
	1998.07-2010.03	Estate Engine AGR/ALH With ABS		◦	GHA230051	K
1.9 TDi (74 kW)	2000.08-2010.12	Estate Engine ATD/AXR	•		GHA436002	K
	2000.08-2010.12	Estate Engine ATD/AXR	•		GWB3455	
	2000.08-2010.12	Estate Engine ATD/AXR With ABS		◦	GHA230051	K
1.9 TDi (81 kW)	1998.07-2006.01	Estate Engine AHF/ASV	•		GHA436002	K
	1998.07-2006.01	Estate Engine AHF/ASV	•		GWB3455	
	1998.07-2006.01	Estate Engine AHF/ASV With ABS		◦	GHA230051	K
1.9 TDi (96 kW)	2003.05-2005.05	Estate Engine ASZ	•		GWB3455	
	2003.05-2005.05	Estate Engine ASZ With ABS		◦	GHA230051	K
1.9 TDi 4x4 (66 kW)	1999.11-2006.02	Estate Engine AGR	•		GWB3455	
	1999.11-2006.02	Estate Engine AGR		◦	GHA436002	K
1.9 TDi 4x4 (74 kW)	2000.09-2006.01	Estate Engine ATD	•		GWB3455	
	2000.09-2006.01	Estate Engine ATD		◦	GHA436002	K
2.0 (85 kW)	1999.04-2007.05	Estate Engine AEG/APK/AQY/AZH/AZJ	•		GHA436002	K
	1999.04-2007.05	Estate Engine AEG/APK/AQY/AZH/AZJ	•		GWB3455	
	1999.04-2007.05	Estate Engine AEG/APK/AQY/AZH/AZJ With ABS		◦	GHA230051	K
2.0 4x4 (85 kW)	2000.08-2004.09	Estate Engine AZJ/AZH	•		GWB3455	
	2000.08-2004.09	Estate Engine AZJ/AZH		◦	GHA436002	K
2.0 4x4 (88 kW)	2000.01-2010.12	Estate Engine ATF	•		GWB3455	
RS 1.8 T (132 kW)	2002.08-2006.01	Estate Engine AUQ	•		GHA436002	K
	2002.08-2006.01	Estate Engine AUQ	•		GWB3455	
	2002.08-2006.01	Estate Engine AUQ With ABS		◦	GHA230051	K



	 YEAR		F	R	G-AP Ref.	KIT
SKODA						
OCTAVIA (1Z3)						
1.2 TSi (77 kW)	2010.02-	Hatchback Engine CBZB 3 hole	•		GHA336004	K
	2010.02-	Hatchback Engine CBZB 4 hole	•		GHA336007	K
	2010.02-	Hatchback Engine CBZB Inner Diameter [32mm]		○	GHA232018	K
1.4 (55 kW)	2004.05-2006.05	Hatchback Engine BCA 3 hole	•		GHA336004	K
	2004.05-2006.05	Hatchback Engine BCA 4 hole	•		GHA336007	K
	2004.05-2006.05	Hatchback Engine BCA Inner Diameter [32mm]		○	GHA232018	K
1.4 (59 kW)	2006.07-	Hatchback Engine BUD/CGGA 3 hole	•		GHA336004	K
	2006.07-	Hatchback Engine BUD/CGGA 4 hole	•		GHA336007	K
	2006.07-	Hatchback Engine BUD/CGGA Inner Diameter [32mm]		○	GHA232018	K
1.4 TSi (90 kW)	2008.11-	Hatchback Engine CAXA 3 hole	•		GHA336004	K
	2008.11-	Hatchback Engine CAXA 4 hole	•		GHA336007	K
	2008.11-	Hatchback Engine CAXA Inner Diameter [32mm]		○	GHA232018	K
1.6 (75 kW)	2004.06-	Hatchback Engine BGU/BSE/BSF/CCSA/CMXA 3 hole	•		GHA336004	K
	2004.06-	Hatchback Engine BGU/BSE/BSF/CCSA/CMXA 4 hole	•		GHA336007	K
	2004.06-	Hatchback Engine BGU/BSE/BSF/CCSA/CMXA Inner Diameter [32mm]		○	GHA232018	K
1.6 FSi (85 kW)	2004.02-2008.10	Hatchback Engine BLF 3 hole	•		GHA336004	K
	2004.02-2008.10	Hatchback Engine BLF 4 hole	•		GHA336007	K
	2004.02-2008.10	Hatchback Engine BLF Inner Diameter [32mm]		○	GHA232018	K
1.6 LPG (75 kW)	2009.08-	Hatchback Engine CHGA 3 hole	•		GHA336004	K
	2009.08-	Hatchback Engine CHGA 4 hole	•		GHA336007	K
	2009.08-	Hatchback Engine CHGA Inner Diameter [32mm]		○	GHA232018	K
1.6 MultiFuel (75 kW)	2008.01-	Hatchback Engine CCSA/CMXA 3 hole	•		GHA336004	K
	2008.01-	Hatchback Engine CCSA/CMXA 4 hole	•		GHA336007	K
	2008.01-	Hatchback Engine CCSA/CMXA Inner Diameter [32mm]		○	GHA232018	K
1.6 TDi (77 kW)	2009.06-	Hatchback Engine CAYC 3 hole	•		GHA336004	K
	2009.06-	Hatchback Engine CAYC 4 hole	•		GHA336007	K
	2009.06-	Hatchback Engine CAYC Inner Diameter [32mm]		○	GHA232018	K
1.8 TSi (112 kW)	2009.03-	Hatchback Engine CDAB 3 hole	•		GHA336004	K
	2009.03-	Hatchback Engine CDAB 4 hole	•		GHA336007	K
	2009.03-	Hatchback Engine CDAB Inner Diameter [32mm]		○	GHA232018	K
1.8 TSi (118 kW)	2007.06-	Hatchback Engine BZB/CDAA 3 hole	•		GHA336004	K
	2007.06-	Hatchback Engine BZB/CDAA 4 hole	•		GHA336007	K
	2007.06-	Hatchback Engine BZB/CDAA Inner Diameter [32mm]		○	GHA232018	K
1.9 TDi (77 kW)	2004.06-2010.12	Hatchback Engine BJB/BKC/BLS/BXE 3 hole	•		GHA336004	K
	2004.06-2010.12	Hatchback Engine BJB/BKC/BLS/BXE 4 hole	•		GHA336007	K
	2004.06-2010.12	Hatchback Engine BJB/BKC/BLS/BXE Inner Diameter [32mm]		○	GHA232018	K
2.0 FSi (110 kW)	2004.11-	Hatchback Engine BLR/BLY/BVY/BVZ 3 hole	•		GHA336004	K
	2004.11-	Hatchback Engine BLR/BLY/BVY/BVZ 4 hole	•		GHA336007	K
	2004.11-	Hatchback Engine BLR/BLY/BVY/BVZ Inner Diameter [32mm]		○	GHA232018	K
2.0 RS (147 kW)	2005.10-	Hatchback Engine BWA/CCZA 3 hole	•		GHA336004	K
	2005.10-	Hatchback Engine BWA/CCZA 4 hole	•		GHA336007	K
	2005.10-	Hatchback Engine BWA/CCZA Inner Diameter [32mm]		○	GHA232018	K
2.0 TDi (100 kW)	2004.02-2010.05	Hatchback Engine AZV 3 hole	•		GHA336004	K
	2004.02-2010.05	Hatchback Engine AZV 4 hole	•		GHA336007	K
	2004.02-2010.05	Hatchback Engine AZV Inner Diameter [32mm]		○	GHA232018	K
2.0 TDi (103 kW)	2007.01-	Hatchback Engine BMM 3 hole	•		GHA336004	K
	2007.01-	Hatchback Engine BMM 4 hole	•		GHA336007	K
	2007.01-	Hatchback Engine BMM Inner Diameter [32mm]		○	GHA232018	K
2.0 TDi (81 kW)	2010.03-	Hatchback Engine CFHF/CLCA 3 hole	•		GHA336004	K
	2010.03-	Hatchback Engine CFHF/CLCA 4 hole	•		GHA336007	K
	2010.03-	Hatchback Engine CFHF/CLCA Inner Diameter [32mm]		○	GHA232018	K
2.0 TDi 16V (103 kW)	2004.02-	Hatchback Engine BKD/CFHC/CLCB 3 hole	•		GHA336004	K
	2004.02-	Hatchback Engine BKD/CFHC/CLCB 4 hole	•		GHA336007	K
	2004.02-	Hatchback Engine BKD/CFHC/CLCB Inner Diameter [32mm]		○	GHA232018	K
2.0 TDi RS (125 kW)	2006.04-	Hatchback Engine BMN/CEGA 3 hole	•		GHA336004	K
	2006.04-	Hatchback Engine BMN/CEGA 4 hole	•		GHA336007	K
	2006.04-	Hatchback Engine BMN/CEGA Inner Diameter [32mm]		○	GHA232018	K
OCTAVIA (1Z5)						
1.2 TSi (77 kW)	2010.02-	Estate Engine CBZB 3 hole	•		GHA336004	K
	2010.02-	Estate Engine CBZB 4 hole	•		GHA336007	K
	2010.02-	Estate Engine CBZB Inner Diameter [32mm]		○	GHA232018	K
1.4 (55 kW)	2004.05-2006.05	Estate Engine BCA 3 hole	•		GHA336004	K
	2004.05-2006.05	Estate Engine BCA 4 hole	•		GHA336007	K
	2004.05-2006.05	Estate Engine BCA Inner Diameter [32mm]		○	GHA232018	K



	 YEAR		F	R	G-AP Ref.	KIT
SKODA						
OCTAVIA (1Z5)						
1.4 (59 kW)	2006.05-	Estate Engine BUD/CGGA 3 hole	•		GHA336004	K
	2006.05-	Estate Engine BUD/CGGA 4 hole	•		GHA336007	K
	2006.05-	Estate Engine BUD/CGGA Inner Diameter [32mm]		○	GHA232018	K
1.4 TSi (90 kW)	2008.11-	Estate Engine CAXA 3 hole	•		GHA336004	K
	2008.11-	Estate Engine CAXA 4 hole	•		GHA336007	K
	2008.11-	Estate Engine CAXA Inner Diameter [32mm]		○	GHA232018	K
1.6 (75 kW)	2004.11-2005.12	Estate Engine BGU/BSE/BSF/CCSA/CMXA 3 hole	•		GHA336004	K
	2004.11-2005.12	Estate Engine BGU/BSE/BSF/CCSA/CMXA 4 hole	•		GHA336007	K
	2004.11-2005.12	Estate Engine BGU/BSE/BSF/CCSA/CMXA Inner Diameter [32mm]		○	GHA232018	K
1.6 FSi (85 kW)	2004.11-2007.03	Estate Engine BLF 3 hole	•		GHA336004	K
	2004.11-2007.03	Estate Engine BLF 4 hole	•		GHA336007	K
	2004.11-2007.03	Estate Engine BLF Inner Diameter [32mm]		○	GHA232018	K
1.6 LPG (75 kW)	2009.08-	Estate Engine CHGA 3 hole	•		GHA336004	K
	2009.08-	Estate Engine CHGA 4 hole	•		GHA336007	K
	2009.08-	Estate Engine CHGA Inner Diameter [32mm]		○	GHA232018	K
1.6 MultiFuel (75 kW)	2008.01-	Estate Engine CCSA/CMXA 3 hole	•		GHA336004	K
	2008.01-	Estate Engine CCSA/CMXA 4 hole	•		GHA336007	K
	2008.01-	Estate Engine CCSA/CMXA Inner Diameter [32mm]		○	GHA232018	K
1.6 TDi (77 kW)	2009.06-	Estate Engine CAYC 3 hole	•		GHA336004	K
	2009.06-	Estate Engine CAYC 4 hole	•		GHA336007	K
	2009.06-	Estate Engine CAYC Inner Diameter [32mm]		○	GHA232018	K
1.6 TDi 4x4 (77 kW)	2009.06-	Estate Engine CAYC 3 hole	•		GHA336004	K
	2009.06-	Estate Engine CAYC 4 hole	•		GHA336007	K
1.8 TSi (112 kW)	2009.03-	Estate Engine CDAB 3 hole	•		GHA336004	K
	2009.03-	Estate Engine CDAB 4 hole	•		GHA336007	K
	2009.03-	Estate Engine CDAB Inner Diameter [32mm]		○	GHA232018	K
1.8 TSi (118 kW)	2007.06-	Estate Engine BZB/CDA 3 hole	•		GHA336004	K
	2007.06-	Estate Engine BZB/CDA 4 hole	•		GHA336007	K
	2007.06-	Estate Engine BZB/CDA Inner Diameter [32mm]		○	GHA232018	K
1.8 TSi 4x4 (112 kW)	2009.03-	Estate Engine CDAB 3 hole	•		GHA336004	K
	2009.03-	Estate Engine CDAB 4 hole	•		GHA336007	K
1.8 TSi 4x4 (118 kW)	2008.11-	Estate Engine CDA 3 hole	•		GHA336004	K
	2008.11-	Estate Engine CDA 4 hole	•		GHA336007	K
1.9 TDi (77 kW)	2004.11-2006.12	Estate Engine BJB/BKC/BLS/BXE 3 hole	•		GHA336004	K
	2004.11-2006.12	Estate Engine BJB/BKC/BLS/BXE 4 hole	•		GHA336007	K
	2004.11-2006.12	Estate Engine BJB/BKC/BLS/BXE Inner Diameter [32mm]		○	GHA232018	K
1.9 TDi 4x4 (77 kW)	2005.01-2010.12	Estate Engine BKC/BLS/BXE 3 hole	•		GHA336004	K
	2005.01-2010.12	Estate Engine BKC/BLS/BXE 4 hole	•		GHA336007	K
2.0 FSi (110 kW)	2004.11-2007.03	Estate Engine BLR/BLY/BVY/BVZ 3 hole	•		GHA336004	K
	2004.11-2007.03	Estate Engine BLR/BLY/BVY/BVZ 4 hole	•		GHA336007	K
	2004.11-2007.03	Estate Engine BLR/BLY/BVY/BVZ Inner Diameter [32mm]		○	GHA232018	K
2.0 FSi 4x4 (110 kW)	2005.01-2006.12	Estate Engine BLX/BVX 3 hole	•		GHA336004	K
	2005.01-2006.12	Estate Engine BLX/BVX 4 hole	•		GHA336007	K
2.0 RS (147 kW)	2005.10-	Estate Engine BWA/CCZA 4 hole	•		GHA336007	K
	2005.10-	Estate Engine BWA/CCZA Inner Diameter [32mm]		○	GHA232018	K
2.0 TDi (103 kW)	2007.01-	Estate Engine BMM 3 hole	•		GHA336004	K
	2007.01-	Estate Engine BMM 4 hole	•		GHA336007	K
	2007.01-	Estate Engine BMM Inner Diameter [32mm]		○	GHA232018	K
2.0 TDi (81 kW)	2010.03-	Estate Engine CFHF/CLCA 3 hole	•		GHA336004	K
	2010.03-	Estate Engine CFHF/CLCA 4 hole	•		GHA336007	K
	2010.03-	Estate Engine CFHF/CLCA Inner Diameter [32mm]		○	GHA232018	K
2.0 TDi 16V (100 kW)	2004.02-2010.05	Estate Engine AZV 3 hole	•		GHA336004	K
	2004.02-2010.05	Estate Engine AZV 4 hole	•		GHA336007	K
	2004.02-2010.05	Estate Engine AZV Inner Diameter [32mm]		○	GHA232018	K
2.0 TDi 16V (103 kW)	2004.11-2007.03	Estate Engine BKD/CFHC/CLCB 3 hole	•		GHA336004	K
	2004.11-2007.03	Estate Engine BKD/CFHC/CLCB 4 hole	•		GHA336007	K
	2004.11-2007.03	Estate Engine BKD/CFHC/CLCB Inner Diameter [32mm]		○	GHA232018	K
2.0 TDi 16V 4x4 (103 kW)	2010.05-	Estate Engine CFHC 3 hole	•		GHA336004	K
	2010.05-	Estate Engine CFHC 4 hole	•		GHA336007	K
2.0 TDi 4x4 (103 kW)	2006.08-	Estate Engine BMM 3 hole	•		GHA336004	K
	2006.08-	Estate Engine BMM 4 hole	•		GHA336007	K
2.0 TDi 4x4 (81 kW)	2011.05-	Estate Engine CFHF 3 hole	•		GHA336004	K
	2011.05-	Estate Engine CFHF 4 hole	•		GHA336007	K
2.0 TDi RS (125 kW)	2006.04-	Estate Engine BMN/CEGA 3 hole	•		GHA336004	K



	 YEAR		F	R	G-AP Ref.	KIT
SKODA						
OCTAVIA (1Z5)						
2.0 TDi RS (125 kW)	2006.04-	Estate Engine BMN/CEGA 4 hole	•		GHA336007	K
	2006.04-	Estate Engine BMN/CEGA Inner Diameter [32mm]		◦	GHA232018	K
OCTAVIA (5E3)						
1.2 TSi (63 kW)	2012.11-	Hatchback Engine CJZB 3 hole	•		GHA336004	K
	2012.11-	Hatchback Engine CJZB Inner Diameter [30mm]		◦	GHA230082	K
1.2 TSi (77 kW)	2012.11-	Hatchback Engine CJZA 3 hole	•		GHA336004	K
	2012.11-	Hatchback Engine CJZA Inner Diameter [30mm]		◦	GHA230082	K
1.4 TSi (103 kW)	2012.11-	Hatchback Engine CHPA 3 hole	•		GHA336004	K
	2012.11-	Hatchback Engine CHPA Inner Diameter [30mm]		◦	GHA230082	K
1.4 TSi G-TEC (81 kW)	2013.11-	Hatchback Engine CPWA 3 hole	•		GHA336004	K
	2013.11-	Hatchback Engine CPWA Inner Diameter [30mm]		◦	GHA230082	K
1.6 (81 kW)	2014.01-	Hatchback Engine CWVA 3 hole	•		GHA336004	K
	2014.01-	Hatchback Engine CWVA Inner Diameter [30mm]		◦	GHA230082	K
1.6 TDi (66 kW)	2012.11-	Hatchback Engine CLHB 3 hole	•		GHA336004	K
	2012.11-	Hatchback Engine CLHB Inner Diameter [30mm]		◦	GHA230082	K
1.6 TDi (77 kW)	2012.11-	Hatchback Engine CLHA 3 hole	•		GHA336004	K
	2012.11-	Hatchback Engine CLHA Inner Diameter [30mm]		◦	GHA230082	K
1.6 TDi (81 kW)	2013.05-	Hatchback Engine CRKB 3 hole	•		GHA336004	K
	2013.05-	Hatchback Engine CRKB Inner Diameter [30mm]		◦	GHA230082	K
1.6 TDi 4x4 (77 kW)	2014.09-	Hatchback Engine CLHA 3 hole	•		GHA336004	K
1.8 TSi (132 kW)	2012.11-	Hatchback Engine CJSA 3 hole	•		GHA336004	K
	2012.11-	Hatchback Engine CJSA Inner Diameter [30mm]		◦	GHA230082	K
1.8 TSi 4x4 (132 kW)	2014.09-	Hatchback Engine CJSA 3 hole	•		GHA336004	K
2.0 TDi (105 kW)	2012.11-	Hatchback Engine CRVC/CKFB 3 hole	•		GHA336004	K
	2012.11-	Hatchback Engine CRVC/CKFB Inner Diameter [30mm]		◦	GHA230082	K
2.0 TDi (110 kW)	2012.11-	Hatchback Engine CKFC/CRMB 3 hole	•		GHA336004	K
	2012.11-	Hatchback Engine CKFC/CRMB Inner Diameter [30mm]		◦	GHA230082	K
2.0 TDi 4x4 (110 kW)	2014.09-	Hatchback Engine CKFC 3 hole	•		GHA336004	K
2.0 TDi 4x4 (135 kW)	2014.09-	Hatchback Engine CUNA/CUPA 3 hole	•		GHA336004	K
2.0 TDi RS (135 kW)	2013.05-	Hatchback Engine CUNA/CUPA 3 hole	•		GHA336004	K
	2013.05-	Hatchback Engine CUNA/CUPA Inner Diameter [30mm]		◦	GHA230082	K
2.0 TSi RS (162 kW)	2013.05-	Hatchback Engine CHHB 3 hole	•		GHA336004	K
	2013.05-	Hatchback Engine CHHB Inner Diameter [30mm]		◦	GHA230082	K
OCTAVIA COMBI (5E5)						
1.2 TSi (63 kW)	2012.11-	Estate Engine CJZB 3 hole	•		GHA336004	K
	2012.11-	Estate Engine CJZB Inner Diameter [30mm]		◦	GHA230082	K
1.2 TSi (77 kW)	2012.11-	Estate Engine CJZA 3 hole	•		GHA336004	K
	2012.11-	Estate Engine CJZA Inner Diameter [30mm]		◦	GHA230082	K
1.4 TSi (103 kW)	2012.11-	Estate Engine CHPA 3 hole	•		GHA336004	K
	2012.11-	Estate Engine CHPA Inner Diameter [30mm]		◦	GHA230082	K
1.4 TSi G-TEC (81 kW)	2013.11-	Estate Engine CPWA 3 hole	•		GHA336004	K
	2013.11-	Estate Engine CPWA Inner Diameter [30mm]		◦	GHA230082	K
1.6 (81 kW)	2014.01-	Estate Engine CWVA 3 hole	•		GHA336004	K
	2014.01-	Estate Engine CWVA Inner Diameter [30mm]		◦	GHA230082	K
1.6 TDi (66 kW)	2012.11-	Estate Engine CLHB 3 hole	•		GHA336004	K
	2012.11-	Estate Engine CLHB Inner Diameter [30mm]		◦	GHA230082	K
1.6 TDi (77 kW)	2012.11-	Estate Engine CLHA 3 hole	•		GHA336004	K
	2012.11-	Estate Engine CLHA Inner Diameter [30mm]		◦	GHA230082	K
1.6 TDi (81 kW)	2013.05-	Estate Engine CRKB 3 hole	•		GHA336004	K
	2013.05-	Estate Engine CRKB Inner Diameter [30mm]		◦	GHA230082	K
1.6 TDi 4x4 (77 kW)	2012.11-	Estate Engine CLHA 3 hole	•		GHA336004	K
1.8 TSi (132 kW)	2012.11-	Estate Engine CJSA/CJSB 3 hole		◦	GHA336004	K
	2012.11-	Estate Engine CJSA/CJSB Inner Diameter [30mm]		◦	GHA230082	K
1.8 TSi 4x4 (132 kW)	2012.11-	Estate Engine CJSB 3 hole	•		GHA336004	K
2.0 TDi (105 kW)	2012.11-	Estate Engine CRVC/CKFB 3 hole	•		GHA336004	K
	2012.11-	Estate Engine CRVC/CKFB Inner Diameter [30mm]		◦	GHA230082	K
2.0 TDi (110 kW)	2012.11-	Estate Engine CKFC/CRMB 3 hole	•		GHA336004	K
	2012.11-	Estate Engine CKFC/CRMB Inner Diameter [30mm]		◦	GHA230082	K
2.0 TDi 4x4 (110 kW)	2012.11-	Estate Engine CKFC 3 hole	•		GHA336004	K
2.0 TDi 4x4 (135 kW)	2014.09-	Estate Engine CUNA/CUPA 3 hole	•		GHA336004	K
2.0 TDi RS (135 kW)	2013.05-	Estate Engine CUNA/CUPA 3 hole	•		GHA336004	K
	2013.05-	Estate Engine CUNA/CUPA Inner Diameter [30mm]		◦	GHA230082	K
2.0 TSi RS (162 kW)	2012.11-	Estate Engine CHHB 3 hole	•		GHA336004	K
	2012.11-	Estate Engine CHHB Inner Diameter [30mm]		◦	GHA230082	K



	 YEAR		F	R	G-AP Ref.	KIT
SKODA						
RAPID (NH1)						
1.2 (55 kW)	2012.07-	Saloon Engine CGPC With ABS	•		GHA336001	K
	2012.07-	Saloon Engine CGPC With ABS		◦	GHA230051	K
	2012.07-	Saloon Engine CGPC Without ABS	•		GHA336002	
1.2 TSi (63 kW)	2012.07-	Saloon Engine CBZA With ABS	•		GHA336001	K
	2012.07-	Saloon Engine CBZA With ABS		◦	GHA230051	K
	2012.07-	Saloon Engine CBZA Without ABS	•		GHA336002	
1.2 TSi (77 kW)	2012.07-	Saloon Engine CBZB With ABS	•		GHA336001	K
	2012.07-	Saloon Engine CBZB With ABS		◦	GHA230051	K
	2012.07-	Saloon Engine CBZB Without ABS	•		GHA336002	
1.4 TSi (90 kW)	2012.07-	Saloon Engine CAXA With ABS	•		GHA336001	K
	2012.07-	Saloon Engine CAXA With ABS		◦	GHA230051	K
	2012.07-	Saloon Engine CAXA Without ABS	•		GHA336002	
1.6 (77 kW)	2012.07-	Hatchback Engine CFNA With ABS	•		GHA336001	K
	2012.07-	Hatchback Engine CFNA With ABS		◦	GHA230051	K
1.6 TDi (66 kW)	2013.08-	Hatchback Engine CAYB With ABS	•		GHA336001	K
1.6 TDi (77 kW)	2012.07-	Saloon Engine CAYC With ABS	•		GHA336001	K
	2012.07-	Saloon Engine CAYC With ABS		◦	GHA230051	K
	2012.07-	Saloon Engine CAYC Without ABS	•		GHA336002	
RAPID SPACEBACK (NH1)						
1.2 (55 kW)	2012.07-	Hatchback Engine CGPC With ABS	•		GHA336001	K
1.2 TSi (63 kW)	2012.07-	Hatchback Engine CBZA With ABS	•		GHA336001	K
1.2 TSi (77 kW)	2012.07-	Hatchback Engine CBZB With ABS	•		GHA336001	K
1.4 TSi (90 kW)	2012.07-	Hatchback Engine CAXA With ABS	•		GHA336001	K
1.6 (77 kW)	2012.07-	Hatchback Engine CFNA With ABS	•		GHA336001	K
1.6 TDi (66 kW)	2013.08-	Hatchback Engine CAYB With ABS	•		GHA336001	K
1.6 TDi (77 kW)	2012.07-	Hatchback Engine CAYC/CLNA With ABS	•		GHA336001	K
ROOMSTER (5J)						
1.2 (47 kW)	2006.05-2007.01	MPV Engine BME With ABS	•		GHA336001	K
	2006.05-2007.01	MPV Engine BME With ABS		◦	GHA230051	K
	2006.05-2007.01	MPV Engine BME Without ABS	•		GHA336002	
1.2 (51 kW)	2007.01-	MPV Engine BZG/CGPA	•		GHA336013	K
	2007.01-	MPV Engine BZG/CGPA With ABS	•		GHA336001	K
	2007.01-	MPV Engine BZG/CGPA With ABS		◦	GHA230051	K
	2007.01-	MPV Engine BZG/CGPA Without ABS	•		GHA336002	
1.2 TDi (55 kW)	2010.03-	MPV Engine CFWA	•		GHA336013	K
	2010.03-	MPV Engine CFWA With ABS	•		GHA336001	K
	2010.03-	MPV Engine CFWA With ABS		◦	GHA230051	K
	2010.03-	MPV Engine CFWA Without ABS	•		GHA336002	
1.2 TSi (63 kW)	2010.03-	MPV Engine CBZA	•		GHA336013	K
	2010.03-	MPV Engine CBZA With ABS	•		GHA336001	K
	2010.03-	MPV Engine CBZA With ABS		◦	GHA230051	K
	2010.03-	MPV Engine CBZA Without ABS	•		GHA336002	
1.2 TSi (77 kW)	2010.03-	MPV Engine CBZB	•		GHA336013	K
	2010.03-	MPV Engine CBZB With ABS	•		GHA336001	K
	2010.03-	MPV Engine CBZB With ABS		◦	GHA230051	K
	2010.03-	MPV Engine CBZB Without ABS	•		GHA336002	
1.4 (63 kW)	2006.09-	MPV Engine BXW/CGGB	•		GHA336013	K
	2006.09-	MPV Engine BXW/CGGB With ABS	•		GHA336001	K
	2006.09-	MPV Engine BXW/CGGB With ABS		◦	GHA230051	K
	2006.09-	MPV Engine BXW/CGGB Without ABS	•		GHA336002	
1.4 TDi (51 kW)	2006.07-2010.03	MPV Engine BNM	•		GHA336013	K
	2006.07-2010.03	MPV Engine BNM With ABS	•		GHA336001	K
	2006.07-2010.03	MPV Engine BNM With ABS		◦	GHA230051	K
	2006.07-2010.03	MPV Engine BNM Without ABS	•		GHA336002	
1.4 TDi (59 kW)	2006.09-2010.03	MPV Engine BMS/BNV	•		GHA336013	K
	2006.09-2010.03	MPV Engine BMS/BNV With ABS	•		GHA336001	K
	2006.09-2010.03	MPV Engine BMS/BNV With ABS		◦	GHA230051	K
	2006.09-2010.03	MPV Engine BMS/BNV Without ABS	•		GHA336002	
1.6 (77 kW)	2006.09-	MPV Engine BTS/CFNA	•		GHA336013	K
	2006.09-	MPV Engine BTS/CFNA With ABS	•		GHA336001	K
	2006.09-	MPV Engine BTS/CFNA With ABS		◦	GHA230051	K
	2006.09-	MPV Engine BTS/CFNA Without ABS	•		GHA336002	
1.6 TDi (66 kW)	2010.03-	MPV Engine CAYB	•		GHA336013	K
	2010.03-	MPV Engine CAYB With ABS	•		GHA336001	K



	 YEAR		F	R	G-AP Ref.	KIT
SKODA						
ROOMSTER (5J)						
1.6 TDi (66 kW)	2010.03-	MPV Engine CAYB With ABS		o	GHA230051	K
	2010.03-	MPV Engine CAYB Without ABS	•		GHA336002	
1.6 TDi (77 kW)	2010.03-	MPV Engine CAYC	•		GHA336013	K
	2010.03-	MPV Engine CAYC With ABS	•		GHA336001	K
	2010.03-	MPV Engine CAYC With ABS		o	GHA230051	K
	2010.03-	MPV Engine CAYC Without ABS	•		GHA336002	
1.9 TDi (74 kW)	2006.03-2006.05	MPV Engine AXR With ABS	•		GHA336001	K
	2006.03-2006.05	MPV Engine AXR With ABS		o	GHA230051	K
	2006.03-2006.05	MPV Engine AXR Without ABS	•		GHA336002	
1.9 TDi (77 kW)	2006.09-2010.03	MPV Engine BLS/BSW	•		GHA336013	K
	2006.09-2010.03	MPV Engine BLS/BSW With ABS	•		GHA336001	K
	2006.09-2010.03	MPV Engine BLS/BSW With ABS		o	GHA230051	K
	2006.09-2010.03	MPV Engine BLS/BSW Without ABS	•		GHA336002	
ROOMSTER PRAKTIK (5J)						
1.2 (51 kW)	2007.03-	Box Engine BZG/CGPA	•		GHA336013	K
	2007.03-	Box Engine BZG/CGPA With ABS	•		GHA336001	K
	2007.03-	Box Engine BZG/CGPA With ABS		o	GHA230051	K
	2007.03-	Box Engine BZG/CGPA Without ABS	•		GHA336002	
1.2 TDi (55 kW)	2010.03-	Box Engine CFWA	•		GHA336013	K
	2010.03-	Box Engine CFWA With ABS	•		GHA336001	K
	2010.03-	Box Engine CFWA With ABS		o	GHA230051	K
	2010.03-	Box Engine CFWA Without ABS	•		GHA336002	
1.2 TSi (63 kW)	2010.03-	Box Engine CBZA	•		GHA336013	K
	2010.03-	Box Engine CBZA With ABS	•		GHA336001	K
	2010.03-	Box Engine CBZA With ABS		o	GHA230051	K
	2010.03-	Box Engine CBZA Without ABS	•		GHA336002	
1.4 (63 kW)	2007.03-	Box Engine BXW/CGGB	•		GHA336013	K
	2007.03-	Box Engine BXW/CGGB With ABS	•		GHA336001	K
	2007.03-	Box Engine BXW/CGGB With ABS		o	GHA230051	K
	2007.03-	Box Engine BXW/CGGB Without ABS	•		GHA336002	
1.4 TDi (51 kW)	2007.03-2010.03	Box Engine BNM	•		GHA336013	K
	2007.03-2010.03	Box Engine BNM With ABS	•		GHA336001	K
	2007.03-2010.03	Box Engine BNM With ABS		o	GHA230051	K
	2007.03-2010.03	Box Engine BNM Without ABS	•		GHA336002	
1.4 TDi (59 kW)	2007.03-2010.03	Box Engine BMS/BNV	•		GHA336013	K
	2007.03-2010.03	Box Engine BMS/BNV With ABS	•		GHA336001	K
	2007.03-2010.03	Box Engine BMS/BNV With ABS		o	GHA230051	K
	2007.03-2010.03	Box Engine BMS/BNV Without ABS	•		GHA336002	
1.6 TDi (66 kW)	2010.03-	Box Engine CAYB	•		GHA336013	K
	2010.03-	Box Engine CAYB With ABS	•		GHA336001	K
	2010.03-	Box Engine CAYB With ABS		o	GHA230051	K
	2010.03-	Box Engine CAYB Without ABS	•		GHA336002	
SUPERB (3T4)						
1.4 TSi (92 kW)	2008.07-	Hatchback Engine CAXC 4 hole	•		GHA336007	K
	2008.07-	Hatchback Engine CAXC Inner Diameter [32mm]		o	GHA232018	K
1.6 TDi (77 kW)	2010.09-	Hatchback Engine CAYC 4 hole	•		GHA336007	K
	2010.09-	Hatchback Engine CAYC Inner Diameter [32mm]		o	GHA232018	K
1.8 TSi (112 kW)	2009.03-	Hatchback Engine CDAB 4 hole	•		GHA336007	K
	2009.03-	Hatchback Engine CDAB Inner Diameter [32mm]		o	GHA232018	K
1.8 TSi (118 kW)	2008.03-	Hatchback Engine BZB/CDA 4 hole	•		GHA336007	K
	2008.03-	Hatchback Engine BZB/CDA Inner Diameter [32mm]		o	GHA232018	K
1.8 TSi 4x4 (112 kW)	2009.03-	Hatchback Engine CDAB 4 hole	•		GHA336007	K
1.8 TSi 4x4 (118 kW)	2008.11-	Hatchback Engine CDAA 4 hole	•		GHA336007	K
1.9 TDi (77 kW)	2008.03-	Hatchback Engine BLS/BXE 4 hole	•		GHA336007	K
	2008.03-	Hatchback Engine BLS/BXE Inner Diameter [32mm]		o	GHA232018	K
2.0 TDi (103 kW)	2008.03-	Hatchback Engine BMP 4 hole	•		GHA336007	K
	2008.03-	Hatchback Engine BMP Inner Diameter [32mm]		o	GHA232018	K
2.0 TDi (125 kW)	2008.07-	Hatchback Engine CBBB/CFGB 4 hole	•		GHA336007	K
	2008.07-	Hatchback Engine CBBB/CFGB Inner Diameter [32mm]		o	GHA232018	K
2.0 TDi 16V (103 kW)	2009.01-	Hatchback Engine CLJA/BKD/CFFB 4 hole	•		GHA336007	K
	2009.01-	Hatchback Engine CLJA/BKD/CFFB Inner Diameter [32mm]		o	GHA232018	K
2.0 TDi 16V 4x4 (103 kW)	2010.11-	Hatchback Engine CFFB 4 hole	•		GHA336007	K
2.0 TDi 4x4 (125 kW)	2008.09-	Hatchback Engine CBBB/CFGB 4 hole	•		GHA336007	K
2.0 TSi (147 kW)	2010.05-	Hatchback Engine CCZA 4 hole	•		GHA336007	K



	 YEAR		F	R	G-AP Ref.	KIT
SKODA						
SUPERB (3T4)						
2.0 TSi (147 kW)	2010.05-	Hatchback Engine CCZA Inner Diameter [32mm]		○	GHA232018	K
3.6 FSi 4x4 (191 kW)	2009.04-	Hatchback 4 hole	●		GHA336007	K
3.6 V6 4x4 (191 kW)	2008.11-	Hatchback Engine CDVA 4 hole	●		GHA336007	K
SUPERB (3T5)						
1.4 TSi (92 kW)	2009.10-	Estate Engine CAXC 4 hole	●		GHA336007	K
	2009.10-	Estate Engine CAXC Inner Diameter [32mm]		○	GHA232018	K
1.6 TDi (77 kW)	2010.09-	Estate Engine CAYC 4 hole	●		GHA336007	K
	2010.09-	Estate Engine CAYC Inner Diameter [32mm]		○	GHA232018	K
1.8 TSi (112 kW)	2009.10-	Estate Engine CDAB 4 hole	●		GHA336007	K
	2009.10-	Estate Engine CDAB Inner Diameter [32mm]		○	GHA232018	K
1.8 TSi (118 kW)	2009.10-	Estate Engine CDAA 4 hole	●		GHA336007	K
	2009.10-	Estate Engine CDAA Inner Diameter [32mm]		○	GHA232018	K
1.8 TSi 4x4 (112 kW)	2009.10-	Estate Engine CDAB 4 hole	●		GHA336007	K
1.8 TSi 4x4 (118 kW)	2009.10-	Estate Engine CDAA 4 hole	●		GHA336007	K
1.9 TDi (77 kW)	2009.10-2010.11	Estate Engine BLS/BXE 4 hole	●		GHA336007	K
	2009.10-2010.11	Estate Engine BLS/BXE Inner Diameter [32mm]		○	GHA232018	K
2.0 TDi (103 kW)	2009.10-2010.03	Estate Engine BMP 4 hole	●		GHA336007	K
	2009.10-2010.03	Estate Engine BMP Inner Diameter [32mm]		○	GHA232018	K
2.0 TDi (125 kW)	2009.10-	Estate Engine CBBB/CFGB 4 hole	●		GHA336007	K
	2009.10-	Estate Engine CBBB/CFGB Inner Diameter [32mm]		○	GHA232018	K
2.0 TDi 16V (103 kW)	2009.10-	Estate Engine BKD/CFFB/CLJA 4 hole	●		GHA336007	K
	2009.10-	Estate Engine BKD/CFFB/CLJA Inner Diameter [32mm]		○	GHA232018	K
2.0 TDi 16V 4x4 (103 kW)	2010.11-	Estate Engine CFFB 4 hole	●		GHA336007	K
2.0 TDi 4x4 (125 kW)	2009.10-	Estate Engine CBBB/CFGB 4 hole	●		GHA336007	K
2.0 TSi (147 kW)	2010.05-	Estate Engine CCZA 4 hole	●		GHA336007	K
	2010.05-	Estate Engine CCZA Inner Diameter [32mm]		○	GHA232018	K
3.6 V6 4x4 (191 kW)	2009.10-	Estate Engine CDVA 4 hole	●		GHA336007	K
SUPERB (3U4)						
1.8 T (110 kW)	2001.12-2008.03	Saloon Engine AWT	●		GHA433002	
	2001.12-2008.03	Saloon Engine AWT	●		GWB1355	
	2001.12-2008.03	Saloon Engine AWT	●		GWB1356	
	2001.12-2008.03	Saloon Engine AWT		○	GHA400003	
1.9 TDi (74 kW)	2002.08-2005.10	Saloon Engine AVB	●		GHA433002	
	2002.08-2005.10	Saloon Engine AVB	●		GWB1355	
	2002.08-2005.10	Saloon Engine AVB		○	GHA400003	
1.9 TDi (77 kW)	2005.10-2007.05	Saloon Engine BSV	●		GWB1355	
	2005.10-2007.05	Saloon Engine BSV		○	GHA400003	
1.9 TDi (85 kW)	2006.09-2008.03	Saloon Engine BPZ	●		GWB1355	
	2006.09-2008.03	Saloon Engine BPZ		○	GHA400003	
1.9 TDi (96 kW)	2001.12-2008.03	Saloon Engine AVF/AWX	●		GWB1355	
	2001.12-2008.03	Saloon Engine AVF/AWX	●		GWB1356	
	2001.12-2008.03	Saloon Engine AVF/AWX		○	GHA400003	
2.0 (85 kW)	2001.12-2008.03	Saloon Engine AZM	●		GHA433002	
	2001.12-2008.03	Saloon Engine AZM	●		GWB1355	
	2001.12-2008.03	Saloon Engine AZM		○	GHA400003	
2.0 TDi (103 kW)	2005.10-2008.03	Saloon Engine BSS	●		GHA433002	
	2005.10-2008.03	Saloon Engine BSS	●		GWB1356	
	2005.10-2008.03	Saloon Engine BSS		○	GHA400003	
2.5 TDi (114 kW)	2001.12-2003.08	Saloon Engine AYM	●		GWB1356	
	2001.12-2003.08	Saloon Engine AYM		○	GHA400003	
2.5 TDi (120 kW)	2002.04-2007.12	Saloon Engine BDG	●		GWB1356	
	2002.04-2007.12	Saloon Engine BDG		○	GHA400003	
2.8 V6 (142 kW)	2001.12-2008.03	Saloon Engine AMX	●		GWB1356	
	2001.12-2008.03	Saloon Engine AMX		○	GHA400003	
2.8 V6 (45 kW)	2002.06-2008.03	Saloon Engine BBG	●		GWB1356	
	2002.06-2008.03	Saloon Engine BBG		○	GHA400003	
YETI (5L)						
1.2 TSi (77 kW)	2009.09-	Closed Off-Road Vehicle Engine CBZB 3 hole	●		GHA336004	K
	2009.09-	Closed Off-Road Vehicle Engine CBZB 4 hole	●		GHA336007	K
	2009.09-	Closed Off-Road Vehicle Engine CBZB Inner Diameter [32mm]		○	GHA232018	K
1.4 TSi (90 kW)	2010.06-	Closed Off-Road Vehicle Engine CAXA 3 hole	●		GHA336004	K
	2010.06-	Closed Off-Road Vehicle Engine CAXA 4 hole	●		GHA336007	K
	2010.06-	Closed Off-Road Vehicle Engine CAXA Inner Diameter [32mm]		○	GHA232018	K
1.6 (81 kW)	2014.04-	Closed Off-Road Vehicle Engine CWVA 3 hole	●		GHA336004	K



	 YEAR		F	R	G-AP Ref.	KIT
SKODA						
YETI (5L)						
1.6 (81 kW)	2014.04-	Closed Off-Road Vehicle Engine CWVA 4 hole	•		GHA336007	K
	2014.04-	Closed Off-Road Vehicle Engine CWVA Inner Diameter [32mm]		◦	GHA232018	K
1.6 TDi (77 kW)	2010.11-	Closed Off-Road Vehicle Engine CAYC 3 hole	•		GHA336004	K
	2010.11-	Closed Off-Road Vehicle Engine CAYC 4 hole	•		GHA336007	K
	2010.11-	Closed Off-Road Vehicle Engine CAYC Inner Diameter [32mm]		◦	GHA232018	K
1.8 TSi 4x4 (112 kW)	2009.11-	Closed Off-Road Vehicle Engine CDAB 3 hole	•		GHA336004	K
	2009.11-	Closed Off-Road Vehicle Engine CDAB 4 hole	•		GHA336007	K
1.8 TSi 4x4 (118 kW)	2009.05-	Closed Off-Road Vehicle Engine CDAA 3 hole	•		GHA336004	K
	2009.05-	Closed Off-Road Vehicle Engine CDAA 4 hole	•		GHA336007	K
2.0 TDi (103 kW)	2011.11-	Closed Off-Road Vehicle Engine CFHC 3 hole	•		GHA336004	K
	2011.11-	Closed Off-Road Vehicle Engine CFHC 4 hole	•		GHA336007	K
	2011.11-	Closed Off-Road Vehicle Engine CFHC Inner Diameter [32mm]		◦	GHA232018	K
2.0 TDi (81 kW)	2009.11-	Closed Off-Road Vehicle Engine CFHA/CLCA 3 hole	•		GHA336004	K
	2009.11-	Closed Off-Road Vehicle Engine CFHA/CLCA 4 hole	•		GHA336007	K
	2009.11-	Closed Off-Road Vehicle Engine CFHA/CLCA Inner Diameter [32mm]		◦	GHA232018	K
2.0 TDi 4x4 (103 kW)	2009.05-	Closed Off-Road Vehicle Engine CBDB/CFHC/CLCB 3 hole	•		GHA336004	K
	2009.05-	Closed Off-Road Vehicle Engine CBDB/CFHC/CLCB 4 hole	•		GHA336007	K
2.0 TDi 4x4 (125 kW)	2009.11-	Closed Off-Road Vehicle Engine CEGA/CFJA 3 hole	•		GHA336004	K
	2009.11-	Closed Off-Road Vehicle Engine CEGA/CFJA 4 hole	•		GHA336007	K
2.0 TDi 4x4 (81 kW)	2009.11-	Closed Off-Road Vehicle Engine CFHF 3 hole	•		GHA336004	K
	2009.11-	Closed Off-Road Vehicle Engine CFHF 4 hole	•		GHA336007	K
SMART						
CABRIO (450)						
0.6 (40 kW)	2000.03-2004.01	Convertible Engine M160E6ALB03/M160.920	•		GHA228058	K
	2000.03-2004.01	Convertible Engine M160E6ALB03/M160.920		◦	GHA324002	K
0.6 (45 kW)	2001.01-2004.01	Convertible Engine M160E6ALB05/M160.920	•		GHA228058	K
	2001.01-2004.01	Convertible Engine M160E6ALB05/M160.920		◦	GHA324002	K
0.6 (52 kW)	2002.06-2004.01	Convertible Engine M160.920	•		GHA228058	K
	2002.06-2004.01	Convertible Engine M160.920		◦	GHA324002	K
0.7 (45 kW)	2003.01-2004.01	Convertible Engine M160.910	•		GHA228058	K
	2003.01-2004.01	Convertible Engine M160.910		◦	GHA324002	K
0.7 (55 kW)	2003.01-2004.01	Convertible Engine M160.910	•		GHA228058	K
	2003.01-2004.01	Convertible Engine M160.910		◦	GHA324002	K
0.8 CDi (30 kW)	2001.03-2004.01	Convertible Engine OM660DE8LA/OM660.940	•		GHA228058	K
	2001.03-2004.01	Convertible Engine OM660DE8LA/OM660.940		◦	GHA324002	K
CITY-COUPÉ (450)						
0.6 (33 kW)	1998.07-2004.01	Coupe Engine M160E6ALB04/M160.920	•		GHA228058	K
	1998.07-2004.01	Coupe Engine M160E6ALB04/M160.920		◦	GHA324002	K
0.6 (40 kW)	1998.07-2004.01	Coupe Engine M160E6ALB03/M160.920	•		GHA228058	K
	1998.07-2004.01	Coupe Engine M160E6ALB03/M160.920		◦	GHA324002	K
0.6 (45 kW)	2001.01-2004.01	Coupe Engine M160E6ALB05/M160.920	•		GHA228058	K
	2001.01-2004.01	Coupe Engine M160E6ALB05/M160.920		◦	GHA324002	K
0.6 (52 kW)	2002.06-2004.01	Coupe Engine M160.920	•		GHA228058	K
	2002.06-2004.01	Coupe Engine M160.920		◦	GHA324002	K
0.7 (37 kW)	2003.01-2004.01	Coupe Engine M160.910	•		GHA228058	K
	2003.01-2004.01	Coupe Engine M160.910		◦	GHA324002	K
0.7 (45 kW)	2003.01-2004.01	Coupe Engine M160.910	•		GHA228058	K
	2003.01-2004.01	Coupe Engine M160.910		◦	GHA324002	K
0.7 (55 kW)	2003.01-2004.01	Coupe Engine M160.910	•		GHA228058	K
	2003.01-2004.01	Coupe Engine M160.910		◦	GHA324002	K
0.8 CDi (30 kW)	1999.11-2004.01	Coupe Engine OM660DE8LA/OM660.940	•		GHA228058	K
	1999.11-2004.01	Coupe Engine OM660DE8LA/OM660.940		◦	GHA324002	K
CROSSBLADE (450)						
0.6 (52 kW)	2002.06-2003.12	Convertible Engine M160.920	•		GHA228058	K
	2002.06-2003.12	Convertible Engine M160.920		◦	GHA324002	K
FORFOUR (454)						
1.1 (47 kW)	2005.06-2006.06	Hatchback Engine M134.911	•		GHA325026	K
	2005.06-2006.06	Hatchback Engine M134.911		◦	GHA400135	K
1.1 (55 kW)	2004.07-2005.04	Hatchback Engine M134.910	•		GHA325026	K
	2004.07-2005.04	Hatchback Engine M134.910		◦	GHA400135	K
1.3 (70 kW)	2004.07-2006.06	Hatchback Engine M135.930	•		GHA325026	K
	2004.07-2006.06	Hatchback Engine M135.930		◦	GHA400135	K
1.5 (80 kW)	2004.07-2006.06	Hatchback Engine M135.950	•		GHA325026	K



	 YEAR		F	R	G-AP Ref.	KIT
SMART						
FORFOUR (454)						
1.5 (80 kW)	2004.07-2006.06	Hatchback Engine M135.950		o	GHA400135	K
1.5 (90 kW)	2004.01-2006.06	Hatchback Engine M135.950	•		GHA325026	K
	2004.01-2006.06	Hatchback Engine M135.950		o	GHA400135	K
1.5 BRABUS (130 kW)	2005.06-2006.06	Hatchback Engine M122.950		o	GHA400135	K
1.5 CDi (50 kW)	2004.09-2006.06	Hatchback Engine OM639.939	•		GHA325026	K
	2004.09-2006.06	Hatchback Engine OM639.939		o	GHA400135	K
1.5 CDi (70 kW)	2004.07-2006.06	Hatchback Engine OM639.939	•		GHA325026	K
	2004.07-2006.06	Hatchback Engine OM639.939		o	GHA400135	K
FORTWO (450)						
0.7 (37 kW)	2004.01-2007.06	Coupe Engine M160.910	•		GHA228058	K
	2004.01-2007.06	Coupe Engine M160.910		o	GHA324002	K
0.7 (40 kW)	2004.01-2007.01	Coupe Engine M 160.910	•		GHA228058	K
	2004.01-2007.01	Coupe Engine M 160.910		o	GHA324002	K
0.7 (45 kW)	2004.01-2007.01	Coupe Engine M160.910	•		GHA228058	K
	2004.01-2007.01	Coupe Engine M160.910		o	GHA324002	K
0.7 (55 kW)	2004.01-2007.06	Coupe Engine M160.910	•		GHA228058	K
	2004.01-2007.06	Coupe Engine M160.910		o	GHA324002	K
0.8 CDi (30 kW)	2004.01-2007.01	Coupe Engine OM660DE8LA/OM660.940	•		GHA228058	K
	2004.01-2007.01	Coupe Engine OM660DE8LA/OM660.940		o	GHA324002	K
FORTWO (451)						
0.8 CDi (33 kW)	2007.01-	Coupe Engine OM660.950	•		GHA400254	
	2007.01-	Coupe Engine OM660.950		o	GHA333076	K
0.8 CDi (40 kW)	2009.08-	Coupe Engine OM660.951	•		GHA400254	
	2009.08-	Coupe Engine OM660.951		o	GHA333076	K
1.0 (45 kW)	2007.07-	Coupe Engine M132.910	•		GHA400254	
	2007.07-	Coupe Engine M132.910		o	GHA333076	K
1.0 (52 kW)	2007.07-	Coupe Engine M132.910	•		GHA400254	
	2007.07-	Coupe Engine M132.910		o	GHA333076	K
1.0 Brabus (72 kW)	2007.07-	Coupe Engine M132.930	•		GHA400254	
	2007.07-	Coupe Engine M132.930		o	GHA333076	K
1.0 Turbo (62 kW)	2007.07-	Coupe Engine M132.930	•		GHA400254	
	2007.07-	Coupe Engine M132.930		o	GHA333076	K
1.0 Turbo Brabus (75 kW)	2010.07-	Coupe Engine M132.930	•		GHA400254	
	2010.07-	Coupe Engine M132.930		o	GHA333076	K
electric Drive (20 kW)	2010.12-2012.12	Coupe	•		GHA400254	
	2010.12-2012.12	Coupe		o	GHA333076	K
FORTWO CABRIO (450)						
0.7 (45 kW)	2004.01-2007.06	Convertible Engine M160.910	•		GHA228058	K
	2004.01-2007.06	Convertible Engine M160.910		o	GHA324002	K
0.7 (55 kW)	2004.01-2007.06	Convertible Engine M160.910	•		GHA228058	K
	2004.01-2007.06	Convertible Engine M160.910		o	GHA324002	K
0.8 CDi (30 kW)	2004.01-2007.01	Convertible Engine OM660DE8LA/OM660.940	•		GHA228058	K
	2004.01-2007.01	Convertible Engine OM660DE8LA/OM660.940		o	GHA324002	K
FORTWO CABRIO (451)						
0.8 CDi (33 kW)	2007.01-	Convertible Engine OM660.950	•		GHA400254	
	2007.01-	Convertible Engine OM660.950		o	GHA333076	K
0.8 CDi (40 kW)	2009.08-	Convertible Engine OM660.951	•		GHA400254	
	2009.08-	Convertible Engine OM660.951		o	GHA333076	K
1.0 (52 kW)	2007.07-	Convertible Engine M132.910	•		GHA400254	
	2007.07-	Convertible Engine M132.910		o	GHA333076	K
1.0 Brabus (72 kW)	2008.01-	Convertible Engine M132.930	•		GHA400254	
	2008.01-	Convertible Engine M132.930		o	GHA333076	K
1.0 Brabus (88 kW)	2012.04-	Convertible	•		GHA400254	
	2012.04-	Convertible		o	GHA333076	K
1.0 Turbo (62 kW)	2007.07-	Convertible Engine M132.930	•		GHA400254	
	2007.07-	Convertible Engine M132.930		o	GHA333076	K
1.0 Turbo Brabus (75 kW)	2010.07-	Convertible Engine M132.930	•		GHA400254	
	2010.07-	Convertible Engine M132.930		o	GHA333076	K
electric Drive (20 kW)	2010.12-2012.12	Convertible	•		GHA400254	
	2010.12-2012.12	Convertible		o	GHA333076	K
ROADSTER (452)						
0.7 (45 kW)	2003.04-2005.11	Convertible Engine M160.921	•		GHA228058	K
	2003.04-2005.11	Convertible Engine M160.921		o	GHA324002	K



	 YEAR		F	R	G-AP Ref.	KIT
SMART						
ROADSTER (452)						
0.7 (45 kW)	2003.06-2005.11	Coupe	•		GHA228058	K
	2003.06-2005.11	Coupe		◦	GHA324002	K
0.7 (60 kW)	2003.04-2005.11	Convertible Engine M160.922	•		GHA228058	K
	2003.04-2005.11	Convertible Engine M160.922		◦	GHA324002	K
	2003.04-2005.11	Coupe	•		GHA228058	K
	2003.04-2005.11	Coupe		◦	GHA324002	K
0.7 Brabus (74 kW)	2003.12-2005.11	Coupe Engine M160.923	•		GHA228058	K
	2003.12-2005.11	Coupe Engine M160.923		◦	GHA324002	K
	2004.04-2006.03	Convertible Engine M160.923	•		GHA228058	K
	2004.04-2006.03	Convertible Engine M160.923		◦	GHA324002	K
SSANGYONG						
ACTYON I						
200 XDi 4WD (100 kW)	2007.07-	MPV Engine D20DT	•		GHA400169	K
200 XDi 4WD (104 kW)	2006.10-	MPV Engine D20DT	•		GHA400169	K
ACTYON SPORTS I (QJ)						
2.0 XDi 4WD (104 kW)	2007.04-	Pickup Engine D20DT	•		GHA400169	K
KYRON						
2.0 XDi 4x4 (100 kW)	2010.01-	Closed Off-Road Vehicle Engine D20DT	•		GHA400169	K
2.0 XDi 4x4 (101 kW)	2005.05-	Closed Off-Road Vehicle Engine D20DT	•		GHA400169	K
2.0 XDi 4x4 (104 kW)	2005.05-	Closed Off-Road Vehicle Engine D20DT	•		GHA400169	K
2.7 XDi (120 kW)	2006.03-	Closed Off-Road Vehicle Engine D27DT	•		GHA400169	K
2.7 XDi (121 kW)	2005.05-	Closed Off-Road Vehicle Engine D27DT	•		GHA400169	K
REXTON (GAB_)						
2.7 D 4x4 (137 kW)	2006.05-	Closed Off-Road Vehicle Engine D27DTP	•		GHA328005	K
	2006.05-	Closed Off-Road Vehicle Engine D27DTP	•		GHA400169	K
2.7 XDi (120 kW)	2004.05-2007.03	Closed Off-Road Vehicle Engine D27DT	•		GHA245021	
	2004.05-2007.03	Closed Off-Road Vehicle Engine D27DT	•		GHA328005	K
	2004.05-2007.03	Closed Off-Road Vehicle Engine D27DT	•		GHA400169	K
3.2 (162 kW)	2003.09-2005.12	Closed Off-Road Vehicle Engine G32D	•		GHA245021	
SUBARU						
BAJA						
-	2003-2006				GHA325003	
FORESTER (SF)						
2.0 (90 kW)	1997.08-2002.09	Closed Off-Road Vehicle Engine EJ20	•		GHA427023	
	1997.08-2002.09	Closed Off-Road Vehicle Engine EJ20	•		GWB3235	
	1997.08-2002.09	Closed Off-Road Vehicle Engine EJ20		◦	GWB3236	
2.0 (92 kW)	1998.06-2002.09	Closed Off-Road Vehicle Engine EJ20	•		GHA427023	
	1998.06-2002.09	Closed Off-Road Vehicle Engine EJ20	•		GWB3235	
	1998.06-2002.09	Closed Off-Road Vehicle Engine EJ20		◦	GWB3236	
2.0 S Turbo (125 kW)	1998.06-2001.04	Closed Off-Road Vehicle Engine EJ20	•		GHA427023	
	1998.06-2001.04	Closed Off-Road Vehicle Engine EJ20	•		GWB3235	
	1998.06-2001.04	Closed Off-Road Vehicle Engine EJ20		◦	GWB3236	
2.0 S Turbo (130 kW)	2001.04-2002.09	Closed Off-Road Vehicle Engine EJ205	•		GHA427023	
	2001.04-2002.09	Closed Off-Road Vehicle Engine EJ205	•		GWB3235	
	2001.04-2002.09	Closed Off-Road Vehicle Engine EJ205		◦	GWB3236	
FORESTER (SG)						
2.0 (92 kW)	2002.09-	Closed Off-Road Vehicle Engine EJ20	•		GHA427024	
	2002.09-	Closed Off-Road Vehicle Engine EJ20	•		GWB3235	
	2002.09-	Closed Off-Road Vehicle Engine EJ20		◦	GWB3236	
2.0 S Turbo (130 kW)	2002.09-	Closed Off-Road Vehicle Engine EJ20	•		GHA427024	
	2002.09-	Closed Off-Road Vehicle Engine EJ20	•		GWB3235	
	2002.09-	Closed Off-Road Vehicle Engine EJ20		◦	GWB3236	
2.0 X (116 kW)	2005.09-	Closed Off-Road Vehicle Engine EJ204	•		GHA327039	K
	2005.09-	Closed Off-Road Vehicle Engine EJ204	•		GHA427024	
	2005.09-	Closed Off-Road Vehicle Engine EJ204	•		GWB3235	
	2005.09-	Closed Off-Road Vehicle Engine EJ204		◦	GHA327038	K
	2005.09-	Closed Off-Road Vehicle Engine EJ204		◦	GWB3236	
2.5 (155 kW)	2003.12-	Closed Off-Road Vehicle Engine EJ25	•		GHA427024	
	2003.12-	Closed Off-Road Vehicle Engine EJ25	•		GWB3235	
	2003.12-	Closed Off-Road Vehicle Engine EJ25		◦	GWB3236	
2.5 AWD (121 kW)	2005.07-	Closed Off-Road Vehicle Engine EJ25D	•		GWB3235	
	2005.07-	Closed Off-Road Vehicle Engine EJ25D		◦	GWB3236	



	 YEAR		F	R	G-AP Ref.	KIT
SUBARU						
FORESTER (SG)						
2.5 RX Nato AWD (115 kW)	2002.11-2005.08	Closed Off-Road Vehicle Engine EJ25	•		GWB3235	
	2002.11-2005.08	Closed Off-Road Vehicle Engine EJ25		◦	GWB3236	
2.5 XT (169 kW)	2004.09-2006.11	Closed Off-Road Vehicle Engine EJ255	•		GHA427024	
	2004.09-2006.11	Closed Off-Road Vehicle Engine EJ255	•		GWB3235	
	2004.09-2006.11	Closed Off-Road Vehicle Engine EJ255		◦	GWB3236	
FORESTER (SH)						
2.0 AWD (110 kW)	2008.01-	Closed Off-Road Vehicle Engine EJ20	•		GHA327039	K
	2008.01-	Closed Off-Road Vehicle Engine EJ20		◦	GHA327038	K
	2010.01-	Closed Off-Road Vehicle Engine FB20	•		GHA327039	K
	2010.01-	Closed Off-Road Vehicle Engine FB20		◦	GHA327038	K
2.0 D AWD (108 kW)	2008.09-	Closed Off-Road Vehicle	•		GHA327039	K
	2008.09-	Closed Off-Road Vehicle		◦	GHA327038	K
2.5 AWD (126 kW)	2009.01-	Closed Off-Road Vehicle Engine EJ25	•		GHA327039	K
	2009.01-	Closed Off-Road Vehicle Engine EJ25		◦	GHA327038	K
2.5 AWD (169 kW)	2008.06-	Closed Off-Road Vehicle Engine EJ255	•		GHA327039	K
	2008.06-	Closed Off-Road Vehicle Engine EJ255		◦	GHA327038	K
T (193 kW)	2011.02-	Closed Off-Road Vehicle Engine EJ255	•		GHA327039	K
	2011.02-	Closed Off-Road Vehicle Engine EJ255		◦	GHA327038	K
FORESTER (SJ)						
2.0 X AWD (110 kW)	2013.03-	Closed Off-Road Vehicle Engine FB20	•		GHA327039	K
2.0 XT AWD (177 kW)	2013.03-	Closed Off-Road Vehicle Engine FA20	•		GHA327039	K
IMPREZA						
2.0 i All-wheel Drive (92 kW)	2002.12-2007.12	Hatchback Engine EJ201	•		GWB3235	
	2002.12-2007.12	Hatchback Engine EJ201		◦	GWB3236	
2.0 i AWD (118 kW)	2005.10-2007.12	Hatchback Engine EJ204	•		GWB3235	
	2005.10-2007.12	Hatchback Engine EJ204		◦	GWB3236	
2.5 WRX (169 kW)	2005.09-	Hatchback Engine EJ255	•		GWB3235	
	2005.09-	Hatchback Engine EJ255		◦	GWB3236	
IMPREZA (GC)						
1.6 i (66 kW)	1992.08-2000.12	Saloon Engine EJ16	•		GWB3235	
	1992.08-2000.12	Saloon Engine EJ16		◦	GHA230114	
1.6 i (70 kW)	1998.06-2000.12	Saloon Engine EJ161	•		GWB3235	
	1998.06-2000.12	Saloon Engine EJ161		◦	GHA230114	
1.6 i AWD (66 kW)	1992.08-2000.12	Saloon Engine EJ16	•		GWB3235	
	1992.08-2000.12	Saloon Engine EJ16		◦	GWB3236	
1.6 i AWD (70 kW)	1998.06-2000.12	Saloon Engine EJ161	•		GWB3235	
	1998.06-2000.12	Saloon Engine EJ161		◦	GWB3236	
1.8 i AWD (76 kW)	1992.08-2000.12	Saloon Engine EJ18/EJ18E	•		GWB3235	
	1992.08-2000.12	Saloon Engine EJ18/EJ18E		◦	GWB3236	
2.0 AWD (206 kW)	1998.09-2000.09	Saloon Engine EJ205P	•		GWB3235	
	1998.09-2000.09	Saloon Engine EJ205P		◦	GWB3236	
2.0 i (85 kW)	1996.07-1998.08	Saloon Engine EJ20E	•		GWB3235	
2.0 i (92 kW)	1998.09-2000.09	Saloon Engine EJ201	•		GWB3235	
2.0 i AWD (85 kW)	1995.10-2000.12	Saloon Engine EJ20	•		GWB3235	
	1995.10-2000.12	Saloon Engine EJ20		◦	GHA230114	
	1995.10-2000.12	Saloon Engine EJ20		◦	GWB3236	
2.0 i AWD (92 kW)	1998.06-2000.12	Saloon Engine EJ20	•		GWB3235	
	1998.06-2000.12	Saloon Engine EJ20		◦	GHA230114	
	1998.06-2000.12	Saloon Engine EJ20		◦	GWB3236	
2.0 Turbo GT AWD (155 kW)	1994.03-2000.12	Saloon Engine EJ20	•		GWB3235	
	1994.03-2000.12	Saloon Engine EJ20		◦	GWB3236	
2.0 Turbo GT AWD (160 kW)	1998.06-2000.12	Saloon Engine EJ205	•		GWB3235	
	1998.06-2000.12	Saloon Engine EJ205		◦	GWB3236	
IMPREZA (GD)						
2.5 AWD (130 kW)	2001.03-2005.09	Saloon Engine EJ251	•		GWB3235	
	2001.03-2005.09	Saloon Engine EJ251		◦	GWB3236	
2.5 AWD (221 kW)	2005.10-	Saloon Engine EJ257	•		GHA327056	
2.5 i AWD (112 kW)	2002.12-2005.09	Saloon Engine EJ251	•		GWB3235	
	2002.12-2005.09	Saloon Engine EJ251		◦	GWB3236	
IMPREZA (GD, GG)						
1.5 AWD (77 kW)	2006.10-2008.03	Saloon Engine EL15	•		GWB3235	
	2006.10-2008.03	Saloon Engine EL15		◦	GHA230114	
	2006.10-2008.03	Saloon Engine EL15		◦	GWB3236	



	 YEAR		F	R	G-AP Ref.	KIT
SUBARU						
IMPREZA (GD, GG)						
1.5 AWD (77 kW)	2007.05-	Estate Engine EL15	•		GWB3235	
	2007.05-	Estate Engine EL15		○	GWB3236	
1.6 AWD (70 kW)	2000.12-	Estate Engine EJ16	•		GWB3235	
	2000.12-	Estate Engine EJ16		○	GWB3236	
	2000.12-	Saloon Engine EJ16	•		GWB3235	
	2000.12-	Saloon Engine EJ16		○	GWB3236	
	2000.12-	Saloon Engine EJ16		○	GWB3236	
2.0 AWD (92 kW)	2000.12-	Estate Engine EJ20	•		GWB3235	
	2000.12-	Estate Engine EJ20		○	GWB3236	
2.0 i AWD (92 kW)	2000.12-	Saloon Engine EJ20	•		GWB3235	
	2000.12-	Saloon Engine EJ20		○	GWB3236	
2.0 i R AWD (118 kW)	2005.09-	Estate Engine EJ204/EJ20	•		GWB3235	
	2005.09-	Estate Engine EJ204/EJ20		○	GWB3236	
	2005.09-2008.03	Saloon Engine EJ204	•		GWB3235	
	2005.09-2008.03	Saloon Engine EJ204		○	GWB3236	
2.0 i WRX AWD (168 kW)	2002.12-2005.09	Saloon Engine EJ205	•		GWB3235	
	2002.12-2005.09	Saloon Engine EJ205		○	GWB3236	
2.0 Turbo AWD (160 kW)	2000.12-	Estate Engine EJ205	•		GWB3235	
	2000.12-	Estate Engine EJ205		○	GWB3236	
2.0 WRX STi AWD (195 kW)	2001.11-	Saloon Engine EJ207	•		GHA327056	
	2001.11-	Saloon Engine EJ207	•		GWB3235	
2.0 WRX STi AWD (235 kW)	2004.01-2005.03	Saloon Engine EJ207	•		GHA327056	
	2004.01-2005.03	Saloon Engine EJ207	•		GWB3235	
2.0 WRX Turbo AWD (160 kW)	2000.12-	Saloon Engine EJ205	•		GWB3235	
	2000.12-	Saloon Engine EJ205		○	GWB3236	
2.0 WRX Turbo AWD (165 kW)	2002.12-	Estate Engine EJ205	•		GWB3235	
	2002.12-	Estate Engine EJ205		○	GWB3236	
	2003.01-2006.11	Saloon Engine EJ205	•		GWB3235	
	2003.01-2006.11	Saloon Engine EJ205		○	GWB3236	
2.5 AWD (221 kW)	2005.10-	Estate Engine EJ257	•		GHA327056	
2.5 i WRX AWD (169 kW)	2005.09-2008.03	Saloon Engine EJ255	•		GWB3235	
	2005.09-2008.03	Saloon Engine EJ255		○	GWB3236	
2.5 WRX AWD (169 kW)	2005.09-	Estate Engine EJ255	•		GWB3235	
	2005.09-	Estate Engine EJ255		○	GWB3236	
2.5 WRX STi AWD (206 kW)	2005.09-2008.03	Saloon Engine EJ257	•		GHA327056	
IMPREZA (GF)						
1.6 (66 kW)	1993.01-1998.08	Estate Engine EJ16E	•		GWB3235	
1.6 i (70 kW)	1998.06-2000.12	Estate Engine EJ161	•		GWB3235	
	1998.06-2000.12	Estate Engine EJ161		○	GHA230114	
1.6 i AWD (66 kW)	1992.08-2000.12	Estate Engine EJ16	•		GWB3235	
	1992.08-2000.12	Estate Engine EJ16		○	GWB3236	
1.6 i AWD (70 kW)	1998.06-2000.12	Estate Engine EJ161	•		GWB3235	
	1998.06-2000.12	Estate Engine EJ161		○	GHA230114	
	1998.06-2000.12	Estate Engine EJ161		○	GWB3236	
1.8 i (76 kW)	1995.11-1996.06	Estate Engine EJ18E	•		GWB3235	
1.8 i AWD (76 kW)	1992.08-2000.12	Estate Engine EJ18	•		GWB3235	
	1992.08-2000.12	Estate Engine EJ18		○	GWB3236	
2.0 (85 kW)	1996.09-1998.08	Estate Engine EJ20E	•		GWB3235	
2.0 i (92 kW)	1998.09-2000.09	Estate Engine EJ201	•		GWB3235	
2.0 i 16V AWD (92 kW)	1998.06-2000.12	Estate Engine EJ20	•		GWB3235	
	1998.06-2000.12	Estate Engine EJ20		○	GWB3236	
2.0 i AWD (85 kW)	1995.12-2000.12	Estate Engine EJ20	•		GWB3235	
	1995.12-2000.12	Estate Engine EJ20		○	GWB3236	
2.0 i Turbo AWD (155 kW)	1994.03-2000.12	Estate Engine EJ20	•		GWB3235	
	1994.03-2000.12	Estate Engine EJ20		○	GWB3236	
2.0 Turbo GT AWD (160 kW)	1998.06-2000.12	Estate Engine EJ205	•		GWB3235	
	1998.06-2000.12	Estate Engine EJ205		○	GWB3236	
IMPREZA (GFC)						
1.6 (66 kW)	1996.12-2000.12	Coupe Engine EJ16E	•		GWB3235	
1.6 AWD (66 kW)	1996.12-2000.12	Coupe Engine EJ161	•		GWB3235	
	1996.12-2000.12	Coupe Engine EJ161		○	GWB3236	
2.0 (92 kW)	1998.09-2000.09	Coupe	•		GWB3235	
2.0 AWD (206 kW)	1998.09-2000.09	Coupe Engine EJ205P	•		GWB3235	
	1998.09-2000.09	Coupe Engine EJ205P		○	GWB3236	
2.0 AWD (85 kW)	1995.12-2000.12	Coupe Engine EJ20	•		GWB3235	



	 YEAR		F	R	G-AP Ref.	KIT
SUBARU						
IMPREZA (GFC)						
2.0 AWD (85 kW)	1995.12-2000.12	Coupe Engine EJ20		o	GWB3236	
2.0 i (85 kW)	1995.11-2000.09	Coupe Engine EJ20E	•		GWB3235	
2.0 Turbo AWD (155 kW)	1996.12-2000.12	Coupe Engine EJ20G	•		GWB3235	
	1996.12-2000.12	Coupe Engine EJ20G		o	GWB3236	
IMPREZA (GR)						
1.5 (79 kW)	2008.02-	Saloon Engine EL15	•		GHA327039	K
1.5 AWD (79 kW)	2008.02-	Saloon Engine EL15	•		GHA327039	K
	2008.02-	Saloon Engine EL15		o	GHA327038	K
2.5 WRX STI AWD (221 kW)	2011.01-	Saloon Engine EJ257	•		GHA327056	
IMPREZA (GR, GH, G3)						
1.5 (79 kW)	2008.02-	Hatchback Engine EL15	•		GHA327039	K
	2008.02-	Hatchback Engine EL15		o	GHA327038	K
1.5 F (79 kW)	2008.02-	Hatchback Engine EL15	•		GHA327039	K
2.0 D (110 kW)	2009.01-	Hatchback	•		GHA327039	K
	2009.01-	Hatchback		o	GHA327038	K
2.0 i (110 kW)	2008.01-	Hatchback Engine EJ204	•		GHA327039	K
	2008.01-	Hatchback Engine EJ204		o	GHA327038	K
2.5 (169 kW)	2008.01-	Hatchback Engine EJ255	•		GHA327039	K
	2008.01-	Hatchback Engine EJ255		o	GHA327038	K
2.5 (221 kW)	2008.01-	Hatchback Engine EJ257	•		GHA327056	
	2008.01-	Hatchback Engine EJ257		o	GHA327054	
2.5 WRX S AWD (188 kW)	2009.02-2010.12	Hatchback Engine EJ255	•		GHA327039	K
	2009.02-2010.12	Hatchback Engine EJ255		o	GHA327038	K
JUSTY III (G3X)						
1.3 (69 kW)	2003.09-	Hatchback Engine M13A	•		GWB6819	
1.5 (73 kW)	2003.09-	Hatchback Engine M15A	•		GWB6819	
LEGACY (BC)						
2.0 (85 kW)	1991.08-1993.12	Saloon Engine EJ20E		o	GHA230114	
LEGACY (BC, BJF)						
	1991.09-1993.12	Estate Engine EJ20EMPI		o	GHA230114	
LEGACY II (BD, BG)						
2.0 i (85 kW)	1994.09-1998.11	Estate Engine EJ20EMPI	•		GWB3235	
	1994.09-1998.11	Estate Engine EJ20EMPI		o	GHA230114	
	1994.09-1999.03	Saloon Engine EJ20E	•		GWB3235	
	1994.09-1999.03	Saloon Engine EJ20E		o	GHA230114	
2.0 i 4WD (85 kW)	1994.09-1998.11	Estate Engine EJ20	•		GWB3235	
	1994.09-1998.11	Estate Engine EJ20		o	GWB3236	
	1994.09-1999.03	Saloon Engine EJ20	•		GWB3235	
	1994.09-1999.03	Saloon Engine EJ20		o	GWB3236	
2.2 (94 kW)	1994.07-1998.11	Saloon Engine EJ22		o	GHA230114	
2.2 i 4WD (94 kW)	1994.02-1998.12	Estate Engine EJ22EMPI	•		GWB3235	
	1994.02-1998.12	Estate Engine EJ22EMPI		o	GWB3236	
	1994.09-1999.03	Saloon Engine EJ22EMPI	•		GWB3235	
	1994.09-1999.03	Saloon Engine EJ22EMPI		o	GWB3236	
2.2 i 4WD (96 kW)	1996.06-1998.11	Estate Engine EJ22EMPI	•		GWB3235	
	1996.06-1998.11	Estate Engine EJ22EMPI		o	GWB3236	
	1996.06-1999.03	Saloon Engine EJ22EMPI	•		GWB3235	
	1996.06-1999.03	Saloon Engine EJ22EMPI		o	GWB3236	
2.5 i 4WD (110 kW)	1996.06-1998.11	Estate Engine EJ25D	•		GWB3235	
	1996.06-1998.11	Estate Engine EJ25D		o	GWB3236	
	1996.06-1999.03	Saloon Engine EJ25D	•		GWB3235	
	1996.06-1999.03	Saloon Engine EJ25D		o	GWB3236	
LEGACY III (BE, BH)						
2.0 (92 kW)	1999.04-2003.08	Saloon Engine EJ20	•		GWB3235	
	1999.04-2003.08	Saloon Engine EJ20		o	GHA240008	K
2.0 AWD (206 kW)	2002.06-2003.08	Estate Engine EJ205P	•		GWB3235	
	2002.06-2003.08	Estate Engine EJ205P		o	GHA240008	K
	2002.06-2003.08	Saloon Engine EJ205P	•		GWB3235	
	2002.06-2003.08	Saloon Engine EJ205P		o	GHA240008	K
2.0 AWD (92 kW)	1998.12-2003.08	Estate Engine EJ20	•		GWB3235	
	1998.12-2003.08	Estate Engine EJ20		o	GHA240008	K
2.0 RSK AWD (191 kW)	2000.08-2003.08	Estate Engine EJ206	•		GWB3235	
	2000.08-2003.08	Estate Engine EJ206		o	GHA240008	K



	 YEAR		F	R	G-AP Ref.	KIT
SUBARU						
LEGACY III (BE, BH)						
2.0 RSK AWD (191 kW)	2000.08-2003.08	Saloon Engine EJ206	•		GWB3235	
	2000.08-2003.08	Saloon Engine EJ206		○	GHA240008	K
2.5 (115 kW)	1998.10-2003.08	Saloon Engine EJ25	•		GWB3235	
	1998.10-2003.08	Saloon Engine EJ25		○	GHA240008	K
2.5 AWD (115 kW)	1998.12-2003.08	Estate Engine EJ25	•		GWB3235	
	1998.12-2003.08	Estate Engine EJ25		○	GHA240008	K
3.0 H6 AWD (154 kW)	2000.08-2003.08	Estate Engine EZ30	•		GWB3235	
	2000.08-2003.08	Estate Engine EZ30		○	GHA240008	K
	2000.08-2003.08	Saloon Engine EZ30	•		GWB3235	
	2000.08-2003.08	Saloon Engine EZ30		○	GHA240008	K
LEGACY IV						
2.0 (101 kW)	2003.10-2005.07	Saloon Engine EJ20	•		GHA327039	K
	2003.10-2005.07	Saloon Engine EJ20		○	GHA325025	K
2.0 (121 kW)	2005.06-	Saloon Engine EJ20	•		GHA327039	K
	2005.06-	Saloon Engine EJ20		○	GHA325025	K
2.0 (132 kW)	2005.06-	Saloon	•		GHA327039	K
	2005.06-	Saloon		○	GHA325025	K
2.0 (140 kW)	2005.06-	Saloon	•		GHA327039	K
	2005.06-	Saloon		○	GHA325025	K
2.0 D (110 kW)	2008.02-	Saloon Engine EE20Z	•		GHA327039	K
	2008.02-	Saloon Engine EE20Z		○	GHA325025	K
2.0 R (110 kW)	2007.09-	Saloon Engine EJ204	•		GHA327039	K
	2007.09-	Saloon Engine EJ204		○	GHA325025	K
2.5 (121 kW)	2003.10-2005.07	Saloon Engine EJ25	•		GHA327039	K
	2003.10-2005.07	Saloon Engine EJ25		○	GHA325025	K
2.5 i (127 kW)	2007.09-	Saloon Engine EJ25	•		GHA327039	K
	2007.09-	Saloon Engine EJ25		○	GHA325025	K
3.0 R (180 kW)	2003.10-2006.11	Saloon Engine EZ30	•		GHA327039	K
	2003.10-2006.11	Saloon Engine EZ30		○	GHA325025	K
LEGACY IV (B13_)						
2.0 AWD (101 kW)	2003.10-2005.07	Estate Engine EJ20	•		GHA327039	K
	2003.10-2005.07	Estate Engine EJ20		○	GHA325025	K
2.0 AWD (121 kW)	2005.08-2008.03	Estate Engine EJ20	•		GHA327039	K
	2005.08-2008.03	Estate Engine EJ20		○	GHA325025	K
2.0 AWD (132 kW)	2005.06-	Estate	•		GHA327039	K
	2005.06-	Estate		○	GHA325025	K
2.0 AWD (140 kW)	2005.06-	Estate	•		GHA327039	K
	2005.06-	Estate		○	GHA325025	K
2.0 D AWD (110 kW)	2008.02-	Estate Engine EE20Z	•		GHA327039	K
	2008.02-	Estate Engine EE20Z		○	GHA325025	K
2.0 R AWD (110 kW)	2007.09-	Estate Engine EJ204	•		GHA327039	K
	2007.09-	Estate Engine EJ204		○	GHA325025	K
2.5 AWD (121 kW)	2003.09-	Estate Engine EJ25	•		GHA327039	K
	2003.09-	Estate Engine EJ25		○	GHA325025	K
2.5 i AWD (127 kW)	2008.01-	Estate Engine EJ25	•		GHA327039	K
	2008.01-	Estate Engine EJ25		○	GHA325025	K
3.0 R AWD (180 kW)	2003.10-2006.11	Estate Engine EZ30	•		GHA327039	K
	2003.10-2006.11	Estate Engine EZ30		○	GHA325025	K
LEGACY OUTBACK (BG)						
2.5 (110 kW)	1996.01-1999.12	Estate Engine EJ25D	•		GWB3235	
	1996.01-1999.12	Estate Engine EJ25D		○	GWB3236	
LEGACY V						
2.0 D (110 kW)	2009.09-	Estate	•		GHA327039	K
	2009.09-	Estate		○	GHA327038	K
2.0 D AWD (110 kW)	2009.09-	Saloon	•		GHA327039	K
	2009.09-	Saloon		○	GHA327038	K
2.0 i (110 kW)	2009.09-	Estate Engine EJ204	•		GHA327039	K
	2009.09-	Estate Engine EJ204		○	GHA327038	K
2.0 i AWD (110 kW)	2009.09-	Saloon Engine EJ204	•		GHA327039	K
	2009.09-	Saloon Engine EJ204		○	GHA327038	K
2.5 i (123 kW)	2009.09-	Estate Engine EJ253	•		GHA327039	K
	2009.09-	Estate Engine EJ253		○	GHA327038	K
2.5 i AWD (123 kW)	2009.09-	Saloon Engine EJ253	•		GHA327039	K
	2009.09-	Saloon Engine EJ253		○	GHA327038	K



	 YEAR		F	R	G-AP Ref.	KIT
SUBARU						
LEGACY V (BM, BR)						
2.5 GT AWD (195 kW)	2010.07-	Estate Engine EJ255	•		GHA327039	K
	2010.07-	Estate Engine EJ255		◦	GHA327038	K
	2010.07-	Saloon Engine EJ255	•		GHA327039	K
	2010.07-	Saloon Engine EJ255		◦	GHA327038	K
OUTBACK (BE, BH)						
2.5 (115 kW)	2000.10-2003.08	Estate Engine EJ25	•		GWB3235	
	2000.10-2003.08	Estate Engine EJ25		◦	GHA240008	K
3.0 H6 (154 kW)	2000.10-2003.08	Estate Engine EZ30	•		GWB3235	
	2000.10-2003.08	Estate Engine EZ30		◦	GHA240008	K
OUTBACK (BL, BP)						
2.0 D (110 kW)	2008.09-2009.09	Estate	•		GHA327039	K
	2008.09-2009.09	Estate		◦	GHA325025	K
2.5 (121 kW)	2003.10-2008.03	Estate Engine EJ25D	•		GHA327039	K
	2003.10-2008.03	Estate Engine EJ25D		◦	GHA325025	K
3.0 (180 kW)	2003.10-2008.03	Estate Engine EZ30	•		GHA327039	K
	2003.10-2008.03	Estate Engine EZ30		◦	GHA325025	K
OUTBACK (BM, BR)						
2.0 D (110 kW)	2009.09-	Estate Engine EE20Z	•		GHA327039	K
	2009.09-	Estate Engine EE20Z		◦	GHA327038	K
2.5 i (123 kW)	2009.09-	Estate Engine EJ253	•		GHA327039	K
	2009.09-	Estate Engine EJ253		◦	GHA327038	K
3.6 R (191 kW)	2009.09-	Estate Engine EZ36D	•		GHA327039	K
	2009.09-	Estate Engine EZ36D		◦	GHA327038	K
TREZIA						
1.3 (73 kW)	2011.03-	Hatchback Engine 1NR-FE/1NR-FKE		◦	GHA400233	
TRIBECA (B9)						
3.0 (180 kW)	2006.08-2006.11	Closed Off-Road Vehicle Engine EZ30	•		GHA327052	
	2006.08-2006.11	Closed Off-Road Vehicle Engine EZ30	•		GHA327056	
	2006.08-2006.11	Closed Off-Road Vehicle Engine EZ30		◦	GHA327057	
3.0 (184 kW)	2005.01-	Closed Off-Road Vehicle Engine EZ30	•		GHA327052	
	2005.01-	Closed Off-Road Vehicle Engine EZ30	•		GHA327056	
	2005.01-	Closed Off-Road Vehicle Engine EZ30		◦	GHA327057	
3.6 (188 kW)	2009.09-	Closed Off-Road Vehicle Engine EZ36D	•		GHA327052	
	2009.09-	Closed Off-Road Vehicle Engine EZ36D		◦	GHA327057	
3.6 (190 kW)	2007.09-	Closed Off-Road Vehicle Engine EZ36D	•		GHA327052	
	2007.09-	Closed Off-Road Vehicle Engine EZ36D	•		GHA327056	
	2007.09-	Closed Off-Road Vehicle Engine EZ36D		◦	GHA327057	
SUZUKI						
ALTO (HA25, HA35)						
1.0 (50 kW)	2009.01-	Hatchback Engine K10B	•		GWB3965	
	2009.01-	Hatchback Engine K10B		◦	GWB7606	
ALTO III (EF)						
1.0 (39 kW)	1994.09-2002.06	Hatchback Engine G10BB		◦	GWB1931	
ALTO IV (FF)						
1.1 (46 kW)	2002.06-2008.12	Hatchback Engine F10D/F10DN	•		GWB3965	
	2002.06-2008.12	Hatchback Engine F10D/F10DN		◦	GWB7456	
	2002.06-2008.12	Hatchback Engine F10D/F10DN		◦	GWB7458	
BALENO (EG)						
1.3 (52 kW)	1996.09-2002.05	Hatchback Engine G13BA With ABS		◦	GHA228026	K
	1996.09-2002.05	Hatchback Engine G13BA Without ABS		◦	GHA228027	K
	1996.09-2002.05	Saloon Engine G13BA With ABS		◦	GHA228026	K
	1996.09-2002.05	Saloon Engine G13BA Without ABS		◦	GHA228027	K
1.3 16V (63 kW)	1997.03-2002.05	Estate Engine G13BB With ABS		◦	GHA228026	K
	1997.03-2002.05	Estate Engine G13BB Without ABS		◦	GHA228027	K
1.3 i 16V (63 kW)	1995.07-2002.05	Hatchback Engine G13BB With ABS		◦	GHA228026	K
	1995.07-2002.05	Hatchback Engine G13BB Without ABS		◦	GHA228027	K
	1995.07-2002.05	Saloon Engine G13B With ABS		◦	GHA228026	K
	1995.07-2002.05	Saloon Engine G13B Without ABS		◦	GHA228027	K
1.6 i 16V (72 kW)	1995.07-2002.05	Hatchback Engine G16B With ABS		◦	GHA228026	K
	1995.07-2002.05	Hatchback Engine G16B Without ABS		◦	GHA228027	K
	1995.07-2002.05	Saloon Engine G16B With ABS		◦	GHA228026	K
	1995.07-2002.05	Saloon Engine G16B Without ABS		◦	GHA228027	K



	 YEAR		F	R	G-AP Ref.	KIT
SUZUKI						
BALENO (EG)						
1.6 i 16V (72 kW)	1996.08-2002.05	Estate Engine G16B With ABS		o	GHA228026	K
	1996.08-2002.05	Estate Engine G16B Without ABS		o	GHA228027	K
1.6 i 16V (73 kW)	1996.08-2002.05	Estate Engine G16B With ABS		o	GHA228026	K
	1996.08-2002.05	Estate Engine G16B Without ABS		o	GHA228027	K
1.6 i 16V 4x4 (72 kW)	1995.07-2002.05	Hatchback Engine G16B		o	GWB3713	
	1995.07-2002.05	Saloon Engine G16B		o	GWB3713	
	1996.08-2002.05	Estate Engine G16B		o	GWB3713	
1.6 i 16V 4x4 (73 kW)	1996.08-2002.05	Estate Engine G16B		o	GWB3713	
1.8 GTX (89 kW)	1996.03-2002.05	Hatchback Engine J18A With ABS		o	GHA228026	K
	1996.03-2002.05	Hatchback Engine J18A Without ABS		o	GHA228027	K
	1996.03-2002.05	Saloon Engine J18A With ABS		o	GHA228026	K
	1996.03-2002.05	Saloon Engine J18A Without ABS		o	GHA228027	K
1.8 i 16V (89 kW)	1996.08-2002.05	Estate Engine J18A With ABS		o	GHA228026	K
	1996.08-2002.05	Estate Engine J18A Without ABS		o	GHA228027	K
1.9 TD (55 kW)	1998.04-2002.05	Estate With ABS		o	GHA228026	K
	1998.04-2002.05	Estate Without ABS		o	GHA228027	K
	1998.04-2002.05	Hatchback With ABS		o	GHA228026	K
	1998.04-2002.05	Hatchback Without ABS		o	GHA228027	K
	1998.04-2002.05	Saloon With ABS		o	GHA228026	K
	1998.04-2002.05	Saloon Without ABS		o	GHA228027	K
CAPPUCINO (EA)						
0.7 (47 kW)	1992.02-1995.08	Convertible Engine F6A		o	GWB3713	
CARRY (FD)						
1.3 (58 kW)	1999.03-	Box Engine G13BB Without ABS	•		GHA228051	K
1.3 16V (58 kW)	2000.03-	Box Engine G13BB Without ABS	•		GHA228051	K
GRAND VITARA I (FT, GT)						
1.6 (69 kW)	2001.01-2005.12	Closed Off-Road Vehicle Engine G16B	•		GWB3922	
	2001.01-2005.12	Closed Off-Road Vehicle Engine G16B		o	GWB7455	
	2001.01-2005.12	Closed Off-Road Vehicle Engine G16B With ABS	•		GHA241002	
	2001.01-2005.12	Closed Off-Road Vehicle Engine G16B Without ABS	•		GHA241001	
2.0 4x4 (94 kW)	1999.05-2005.09	Closed Off-Road Vehicle Engine J20A	•		GWB3922	
	1999.05-2005.09	Closed Off-Road Vehicle Engine J20A		o	GWB7455	
	1999.05-2005.09	Closed Off-Road Vehicle Engine J20A With ABS	•		GHA241002	
	1999.05-2005.09	Closed Off-Road Vehicle Engine J20A Without ABS	•		GHA241001	
2.0 HDi (80 kW)	2001.07-2005.09	Closed Off-Road Vehicle Engine RHZ		o	GWB7455	
	2001.07-2005.09	Closed Off-Road Vehicle Engine RHZ With ABS	•		GHA241002	
	2001.07-2005.09	Closed Off-Road Vehicle Engine RHZ Without ABS	•		GHA241001	
2.0 HDi 16V (80 kW)	2001.07-2005.09	Closed Off-Road Vehicle Engine RHW		o	GWB7455	
	2001.07-2005.09	Closed Off-Road Vehicle Engine RHW With ABS	•		GHA241002	
	2001.07-2005.09	Closed Off-Road Vehicle Engine RHW Without ABS	•		GHA241001	
2.0 TD (64 kW)	1998.03-2003.07	Closed Off-Road Vehicle Engine RF	•		GWB3922	
	1998.03-2003.07	Closed Off-Road Vehicle Engine RF		o	GWB7455	
	1998.03-2003.07	Closed Off-Road Vehicle Engine RF With ABS	•		GHA241002	
	1998.03-2003.07	Closed Off-Road Vehicle Engine RF Without ABS	•		GHA241001	
2.5 V6 24V (106 kW)	1998.04-2003.07	Closed Off-Road Vehicle Engine H25A	•		GWB3922	
	1998.04-2003.07	Closed Off-Road Vehicle Engine H25A		o	GWB7455	
	1998.04-2003.07	Closed Off-Road Vehicle Engine H25A With ABS	•		GHA241002	
	1998.04-2003.07	Closed Off-Road Vehicle Engine H25A Without ABS	•		GHA241001	
2.5 V6 24V (116 kW)	2004.08-2005.12	Closed Off-Road Vehicle Engine H25A		o	GWB7455	
	2004.08-2005.12	Closed Off-Road Vehicle Engine H25A With ABS	•		GHA241002	
	2004.08-2005.12	Closed Off-Road Vehicle Engine H25A Without ABS	•		GHA241001	
2.7 4x4 (127 kW)	2001.09-2003.07	Closed Off-Road Vehicle Engine H27A With ABS	•		GHA241002	
	2001.09-2003.07	Closed Off-Road Vehicle Engine H27A Without ABS	•		GHA241001	
2.7 4x4 (135 kW)	2004.01-2005.12	Closed Off-Road Vehicle Engine H27A With ABS	•		GHA241002	
	2004.01-2005.12	Closed Off-Road Vehicle Engine H27A Without ABS	•		GHA241001	
GRAND VITARA II (JT)						
1.6 (78 kW)	2005.09-	Closed Off-Road Vehicle Engine M16A	•		GHA328007	K
1.9 DDiS (95 kW)	2005.12-	Closed Off-Road Vehicle Engine F9QB	•		GHA328007	K
2.0 (103 kW)	2005.09-	Closed Off-Road Vehicle Engine J20A	•		GHA328007	K
2.4 (122 kW)	2009.01-	Closed Off-Road Vehicle Engine J24B	•		GHA328007	K
2.4 (124 kW)	2009.01-	Closed Off-Road Vehicle Engine J24B	•		GHA328007	K
3.2 (171 kW)	2009.01-	Closed Off-Road Vehicle Engine N32A	•		GHA328007	K



	 YEAR		F	R	G-AP Ref.	KIT
SUZUKI						
IGNIS (FH)						
1.3 (61 kW)	2000.10-2003.09	Closed Off-Road Vehicle Engine M13A	•		GWB3965	
	2000.10-2003.09	Closed Off-Road Vehicle Engine M13A		○	GWB6820	
1.3 4WD (61 kW)	2000.10-2003.09	Closed Off-Road Vehicle Engine M13A	•		GWB3965	
	2000.10-2003.09	Closed Off-Road Vehicle Engine M13A		○	GWB3967	
	2000.10-2003.09	Closed Off-Road Vehicle Engine M13A		○	GWB3968	
IGNIS II						
1.3 (69 kW)	2003.09-2005.12	Closed Off-Road Vehicle Engine M13A	•		GWB3965	
	2003.09-2005.12	Closed Off-Road Vehicle Engine M13A	•		GWB6819	
	2003.09-2005.12	Closed Off-Road Vehicle Engine M13A		○	GWB3966	
	2003.09-2005.12	Closed Off-Road Vehicle Engine M13A		○	GWB6820	
1.3 4x4 (69 kW)	2003.09-	Closed Off-Road Vehicle Engine M13A	•		GWB3965	
	2003.09-	Closed Off-Road Vehicle Engine M13A	•		GWB6819	
1.3 DDiS (51 kW)	2003.09-	Closed Off-Road Vehicle Engine Z13DT	•		GWB6819	
	2003.09-	Closed Off-Road Vehicle Engine Z13DT		○	GWB3966	
1.5 (73 kW)	2003.09-2005.12	Closed Off-Road Vehicle Engine M15A	•		GWB6819	
	2003.09-2005.12	Closed Off-Road Vehicle Engine M15A		○	GWB3966	
	2003.09-2005.12	Closed Off-Road Vehicle Engine M15A With ABS		○	GHA228057	K
1.5 4x4 (73 kW)	2004.04-	Closed Off-Road Vehicle Engine M15A	•		GWB6819	
1.5 Sport (80 kW)	2003.09-2005.12	Closed Off-Road Vehicle Engine M15A	•		GWB6819	
	2003.09-2005.12	Closed Off-Road Vehicle Engine M15A		○	GWB3966	
	2003.09-2005.12	Closed Off-Road Vehicle Engine M15A With ABS		○	GHA228057	K
JIMNY (FJ)						
1.3 16V (59 kW)	1998.09-	Closed Off-Road Vehicle Engine G13BB		○	GWB1971	
	1998.09-	Closed Off-Road Vehicle Engine G13BB		○	GWB3970	
1.3 16V (60 kW)	2001.02-	Closed Off-Road Vehicle Engine M13A		○	GWB1971	
1.3 16V 4WD (59 kW)	1998.09-	Closed Off-Road Vehicle Engine G13BB		○	GWB1971	
	1998.09-	Closed Off-Road Vehicle Engine G13BB		○	GWB3970	
1.3 16V 4WD (60 kW)	2001.02-	Closed Off-Road Vehicle Engine M13A		○	GWB1971	
1.3 16V 4x4 (63 kW)	2005.08-	Closed Off-Road Vehicle Engine M13A		○	GWB1971	
1.3 4x4 (63 kW)	1998.09-2000.08	Closed Off-Road Vehicle Engine G13BB		○	GWB1971	
	1998.09-2000.08	Closed Off-Road Vehicle Engine G13BB		○	GWB3970	
1.5 DDiS 4WD (48 kW)	2003.12-	Closed Off-Road Vehicle Engine K9K700		○	GWB1971	
1.5 DDiS 4x4 (63 kW)	2005.08-	Closed Off-Road Vehicle Engine K9K266		○	GWB1971	
LIANA (ER)						
1.3 (66 kW)	2001.07-2007.12	Estate Engine M13A	•		GWB6819	
	2001.07-2007.12	Estate Engine M13A With ABS		○	GHA228026	K
	2001.07-2007.12	Estate Engine M13A Without ABS		○	GHA228027	K
	2002.03-	Saloon Engine M13A	•		GWB6819	
	2002.03-	Saloon Engine M13A With ABS		○	GHA228026	K
	2002.03-	Saloon Engine M13A Without ABS		○	GHA228027	K
1.4 DDiS (66 kW)	2004.04-	Saloon Engine 8HY	•		GWB6819	
	2004.04-	Saloon Engine 8HY With ABS		○	GHA228026	K
	2004.04-	Saloon Engine 8HY Without ABS		○	GHA228027	K
	2004.04-2007.12	Estate Engine 8HY	•		GWB6819	
	2004.04-2007.12	Estate Engine 8HY With ABS		○	GHA228026	K
	2004.04-2007.12	Estate Engine 8HY Without ABS		○	GHA228027	K
1.6 (76 kW)	2001.07-2007.12	Estate Engine M16A	•		GWB6819	
	2001.07-2007.12	Estate Engine M16A With ABS		○	GHA228026	K
	2001.07-2007.12	Estate Engine M16A Without ABS		○	GHA228027	K
	2002.03-	Saloon Engine M16A	•		GWB6819	
	2002.03-	Saloon Engine M16A With ABS		○	GHA228026	K
	2002.03-	Saloon Engine M16A Without ABS		○	GHA228027	K
1.6 (79 kW)	2005.01-	Saloon Engine M16A	•		GWB6819	
	2005.01-	Saloon Engine M16A With ABS		○	GHA228026	K
	2005.01-	Saloon Engine M16A Without ABS		○	GHA228027	K
	2005.01-2007.12	Estate Engine M16A	•		GWB6819	
	2005.01-2007.12	Estate Engine M16A With ABS		○	GHA228026	K
	2005.01-2007.12	Estate Engine M16A Without ABS		○	GHA228027	K
1.6 4WD (76 kW)	2001.07-2007.12	Estate Engine M16A	•		GWB6819	
	2001.07-2007.12	Estate Engine M16A		○	GWB3713	
	2002.03-	Saloon Engine M16A	•		GWB6819	
	2002.03-	Saloon Engine M16A		○	GWB3713	
1.6 4WD (78 kW)	2002.04-	Saloon Engine M16A	•		GWB6819	
	2002.04-	Saloon Engine M16A		○	GWB3713	



	 YEAR		F	R	G-AP Ref.	KIT
SUZUKI						
LIANA (ER)						
1.6 4WD (78 kW)	2002.04-2007.12	Estate Engine M16A	•		GWB6819	
	2002.04-2007.12	Estate Engine M16A		◦	GWB3713	
1.6 4WD (79 kW)	2005.01-2007.12	Estate Engine M16A	•		GWB6819	
	2005.01-2007.12	Estate Engine M16A		◦	GWB3713	
	2005.01-2007.12	Saloon Engine M16A	•		GWB6819	
	2005.01-2007.12	Saloon Engine M16A		◦	GWB3713	
1.6 i (78 kW)	2002.04-2007.12	Estate Engine M16A	•		GWB6819	
	2002.04-2007.12	Estate Engine M16A With ABS		◦	GHA228026	K
	2002.04-2007.12	Estate Engine M16A Without ABS		◦	GHA228027	K
	2002.08-2007.10	Saloon Engine M16A	•		GWB6819	
	2002.08-2007.10	Saloon Engine M16A With ABS		◦	GHA228026	K
	2002.08-2007.10	Saloon Engine M16A Without ABS		◦	GHA228027	K
SAMURAI (SJ)						
1.9 TD (46 kW)	1998.11-2004.12	Closed Off-Road Vehicle Engine XUD9		◦	GWB1971	
1.9 TD (47 kW)	1998.11-2004.12	Closed Off-Road Vehicle		◦	GWB1971	
SPLASH						
1.0 (48 kW)	2008.01-	Hatchback Engine K10B	•		GWB7526	
	2008.01-	Hatchback Engine K10B		◦	GWB6975	
1.2 (63 kW)	2008.01-	Hatchback Engine K12B	•		GWB7526	
	2008.01-	Hatchback Engine K12B		◦	GWB6975	
1.3 CDTi (55 kW)	2008.01-	Hatchback Engine D13A/Z13DTJ	•		GWB7526	
	2008.01-	Hatchback Engine D13A/Z13DTJ		◦	GWB6975	
SWIFT (SF413)						
1.3 i (50 kW)	1991.09-1996.10	Convertible Engine G13BA		◦	GWB3716	
	1991.09-1996.10	Convertible Engine G13BA		◦	GWB3717	
SWIFT II (AH, AJ)						
1.6 i (68 kW)	1990.01-2001.05	Saloon Engine G16B	•		GWB3718	
	1990.01-2001.05	Saloon Engine G16B		◦	GHA228033	K
	1990.01-2001.05	Saloon Engine G16B		◦	GWB3717	
1.6 i 4WD (68 kW)	1990.01-2001.05	Saloon Engine G16B	•		GWB3718	
	1990.01-2001.05	Saloon Engine G16B		◦	GWB3713	
SWIFT II (EA, MA)						
1.0 i (39 kW)	1991.09-2001.05	Hatchback Engine G10A		◦	GWB3716	
	1991.09-2001.05	Hatchback Engine G10A		◦	GWB3717	
SWIFT II (EA, MA)						
1.3 (63 kW)	2001.6-2003.12	Hatchback Engine G13BB		◦	GHA228033	K
	2001.6-2003.12	Hatchback Engine G13BB		◦	GWB3716	
SWIFT III (MZ, EZ)						
1.3 (68 kW)	2005.02-	Hatchback Engine M13A	•		GWB7526	
	2005.02-	Hatchback Engine M13A		◦	GWB6975	
1.3 4x4 (66 kW)	2006.01-	Hatchback Engine M13A	•		GWB7526	
	2006.01-	Hatchback Engine M13A		◦	GWB3965	
1.3 4x4 (68 kW)	2005.02-	Hatchback Engine M13A	•		GWB7526	
	2005.02-	Hatchback Engine M13A		◦	GWB3965	
1.3 DDiS (51 kW)	2005.08-	Hatchback Engine Z13DT	•		GWB7526	
	2005.08-	Hatchback Engine Z13DT		◦	GWB6975	
1.3 DDiS (55 kW)	2005.08-	Hatchback Engine D13A/Z13DTJ	•		GWB7526	
	2005.08-	Hatchback Engine D13A/Z13DTJ		◦	GWB6975	
1.5 (75 kW)	2005.02-	Hatchback Engine M15A	•		GWB7526	
	2005.02-	Hatchback Engine M15A		◦	GWB6975	
1.5 4x4 (74 kW)	2005.02-	Hatchback Engine M15A	•		GWB7526	
	2005.02-	Hatchback Engine M15A		◦	GWB3965	
1.6 (92 kW)	2006.10-	Hatchback Engine M16A	•		GWB6578	
	2006.10-	Hatchback Engine M16A		◦	GHA228074	K
SWIFT IV (FZ, NZ)						
1.2 (66 kW)	2010.10-	Hatchback Engine K12B	•		GWB7526	
	2010.10-	Hatchback Engine K12B		◦	GHA400198	
	2010.10-	Hatchback Engine K12B		◦	GHA400199	
1.2 (67 kW)	2012.08-	Hatchback Engine K12B	•		GWB7526	
1.2 (69 kW)	2010.10-	Hatchback Engine K12B	•		GWB7526	
	2010.10-	Hatchback Engine K12B		◦	GHA400198	
	2010.10-	Hatchback Engine K12B		◦	GHA400199	
1.2 4WD (67 kW)	2012.08-	Hatchback Engine K12B		◦	GHA324004	K



	 YEAR		F	R	G-AP Ref.	KIT
SUZUKI						
SWIFT III (MZ, EZ)						
1.2 4x4 (66 kW)	2010.10-	Hatchback Engine K12B	•		GWB7526	
1.2 4x4 (69 kW)	2010.10-	Hatchback Engine K12B	•		GWB7526	
1.3 DDiS (55 kW)	2010.10-	Hatchback Engine D13A	•		GWB7526	
	2010.10-	Hatchback Engine D13A		○	GHA400198	
	2010.10-	Hatchback Engine D13A		○	GHA400199	
SX4 (EY, GY)						
1.6 (74 kW)	2006.06-	Hatchback Engine M16A	•		GWB6578	
	2006.06-	Hatchback Engine M16A		○	GHA400187	
	2006.06-	Hatchback Engine M16A		○	GHA400188	K
2.0 4x4 (107 kW)	2006.06-	Hatchback Engine J20A	•		GWB6578	
SX4 (GY)						
1.5 (73 kW)	2006.06-	Hatchback Engine M15A	•		GWB6578	
	2006.06-	Hatchback Engine M15A		○	GHA400187	
	2006.06-	Hatchback Engine M15A		○	GHA400188	K
1.5 VVT (82 kW)	2010.07-	Hatchback Engine M15A	•		GWB6578	
	2010.07-	Hatchback Engine M15A		○	GHA400187	
	2010.07-	Hatchback Engine M15A		○	GHA400188	K
1.6 (79 kW)	2007.10-	Saloon Engine M16A	•		GWB6578	
	2007.10-	Saloon Engine M16A		○	GHA400187	
	2007.10-	Saloon Engine M16A		○	GHA400188	K
1.6 (88 kW)	2007.10-	Saloon Engine M16A	•		GWB6578	
	2007.10-	Saloon Engine M16A		○	GHA400187	
	2007.10-	Saloon Engine M16A		○	GHA400188	K
1.6 DDiS (66 kW)	2007.04-	Hatchback Engine 9HX	•		GWB6578	
	2007.04-	Hatchback Engine 9HX		○	GHA400188	K
1.6 VVT (79 kW)	2006.06-	Hatchback Engine M16A	•		GWB6578	
	2006.06-	Hatchback Engine M16A		○	GHA400187	
	2006.06-	Hatchback Engine M16A		○	GHA400188	K
1.6 VVT (88 kW)	2009.07-	Hatchback Engine M16A	•		GWB6578	
	2009.07-	Hatchback Engine M16A		○	GHA400187	
	2009.07-	Hatchback Engine M16A		○	GHA400188	K
1.6 VVT 4x4 (79 kW)	2006.10-	Hatchback Engine M16A	•		GWB6578	
	2006.10-	Hatchback Engine M16A		○	GHA324003	
1.6 VVT 4x4 (82 kW)	2009.07-	Hatchback Engine M16A	•		GWB6578	
	2009.07-	Hatchback Engine M16A		○	GHA324003	
1.6 VVT 4x4 (88 kW)	2009.07-	Hatchback Engine M16A	•		GWB6578	
	2009.07-	Hatchback Engine M16A		○	GHA324003	
1.9 DDiS (88 kW)	2006.10-	Hatchback Engine D19AA	•		GWB6578	
	2006.10-	Hatchback Engine D19AA		○	GHA400188	K
1.9 DDiS 4x4 (88 kW)	2006.06-	Hatchback Engine D19AA	•		GWB6578	
2.0 (107 kW)	2006.06-	Hatchback Engine J20A	•		GWB6578	
	2006.06-	Hatchback Engine J20A		○	GHA400187	
2.0 DDiS (99 kW)	2009.07-	Hatchback Engine D20AA	•		GWB6578	
	2009.07-	Hatchback Engine D20AA		○	GHA400188	K
2.0 DDiS 4x4 (99 kW)	2009.07-	Hatchback Engine D20AA	•		GWB6578	
	2009.07-	Hatchback Engine D20AA		○	GHA324003	
VITARA (ET, TA)						
1.6 i 16V (71 kW)	1990.07-1998.03	Closed Off-Road Vehicle Engine G16B	•		GWB3219	
	1990.07-1998.03	Closed Off-Road Vehicle Engine G16B		○	GWB3220	
1.9 D (50 kW)	1995.01-1998.03	Closed Off-Road Vehicle Engine XUD9A	•		GWB3219	
	1995.01-1998.03	Closed Off-Road Vehicle Engine XUD9A		○	GWB3220	
1.9 D (55 kW)	1996.08-1998.03	Closed Off-Road Vehicle Engine XUD9SD	•		GWB3219	
	1996.08-1998.03	Closed Off-Road Vehicle Engine XUD9SD		○	GWB3220	
2.0 TD (52 kW)	1994.12-1998.03	Closed Off-Road Vehicle Engine RF	•		GWB3922	
	1994.12-1998.03	Closed Off-Road Vehicle Engine RF		○	GWB3220	
2.0 TD Intercooler (64 kW)	1995.12-1998.03	Closed Off-Road Vehicle Engine RF	•		GWB3922	
	1995.12-1998.03	Closed Off-Road Vehicle Engine RF		○	GWB3220	
2.0 V6 24V (100 kW)	1994.12-1998.03	Closed Off-Road Vehicle Engine H20A	•		GWB3219	
	1994.12-1998.03	Closed Off-Road Vehicle Engine H20A		○	GWB3220	
VITARA CABRIO (ET, TA)						
1.6 i 16V (71 kW)	1990.07-1999.03	Open Off-Road Vehicle Engine G16B	•		GWB3219	
	1990.07-1999.03	Open Off-Road Vehicle Engine G16B		○	GWB3220	
1.9 D (50 kW)	1995.01-1998.03	Open Off-Road Vehicle Engine XUD9A	•		GWB3219	



	 YEAR		F	R	G-AP Ref.	KIT
SUZUKI						
VITARA CABRIO (ET, TA)						
1.9 D (50 kW)	1995.01-1998.03	Open Off-Road Vehicle Engine XUD9A		o	GWB3220	
1.9 D (55 kW)	1996.08-1999.03	Open Off-Road Vehicle Engine XUD9SD	•		GWB3219	
	1996.08-1999.03	Open Off-Road Vehicle Engine XUD9SD		o	GWB3220	
WAGON R						
1.0 (39 kW)	2003.07-2005.08	MPV Engine G10A	•		GWB3965	
WAGON R+ (EM)						
1.0 (48 kW)	1998.02-2000.05	MPV Engine K10A	•		GWB3965	
	1998.02-2000.05	MPV Engine K10A		o	GWB3716	
	1998.02-2000.05	MPV Engine K10A		o	GWB3966	
1.2 (51 kW)	1998.02-2000.05	MPV Engine K12A	•		GWB3965	
	1998.02-2000.05	MPV Engine K12A		o	GWB3716	
1.2 4WD (51 kW)	1998.02-2000.05	MPV Engine K12A	•		GWB3965	
	1998.02-2000.05	MPV Engine K12A		o	GWB3967	
WAGON R+ (MM)						
1.0 (40 kW)	2000.08-2003.07	MPV Engine K10A	•		GWB3965	
1.3 (56 kW)	2000.05-2004.12	MPV Engine G13BB	•		GWB3965	
	2000.05-2004.12	MPV Engine G13BB		o	GWB3966	
1.3 (69 kW)	2003.10-2005.12	MPV Engine M13A	•		GWB3965	
	2003.10-2005.12	MPV Engine M13A		o	GWB3966	
1.3 4WD (56 kW)	2001.10-	MPV Engine G13BB	•		GWB3965	
	2001.10-	MPV Engine G13BB		o	GWB3967	
	2001.10-	MPV Engine G13BB		o	GWB3968	
1.3 4WD (69 kW)	2003.09-	MPV Engine M13A	•		GWB3965	
1.3 DDiS (51 kW)	2003.09-	MPV Engine Z13DT	•		GWB6819	
	2003.09-	MPV Engine Z13DT		o	GWB3966	
X-90 (EL)						
1.6 i 16V (71 kW)	1995.09-1997.12	Open Off-Road Vehicle Engine G16B	•		GWB3219	
	1995.09-1997.12	Open Off-Road Vehicle Engine G16B		o	GWB3220	
1.6 i 16V 4x4 (71 kW)	1995.09-1997.12	Open Off-Road Vehicle Engine G16B	•		GWB3922	
	1995.09-1997.12	Open Off-Road Vehicle Engine G16B		o	GWB3220	
TOYOTA						
4 RUNNER (KZN18_, VZN18_, RZN18_)						
3.0 Turbo-D (92 kW)	1995.11-2002.11	Closed Off-Road Vehicle Engine 1KZ-T	•		GWB3974	
4 RUNNER (RN10_, VZN13_, VZN10_, RN13_)						
2.7 i (112 kW)	1995.11-1996.03	Closed Off-Road Vehicle Engine 3RZ-FE	•		GWB3974	
3.0 Turbo-D (92 kW)	1993.10-1996.03	Closed Off-Road Vehicle Engine 1KZ-T	•		GWB1951	
	1993.10-1996.03	Closed Off-Road Vehicle Engine 1KZ-T		o	GHA499045	
3.4 i (136 kW)	1995.11-1996.03	Closed Off-Road Vehicle Engine 5VZ-FE	•		GWB3974	
4 RUNNER (UZ21_, KZN21_, GRN21_)						
4.0 4WD (183 kW)	2002.11-2009.07	Closed Off-Road Vehicle Engine 1GR-FE	•		GHA430008	
4.7 4WD (175 kW)	2002.11-2006.12	Closed Off-Road Vehicle Engine 2UZ-FE	•		GHA430008	
4.7 4WD (194 kW)	2006.09-2009.07	Closed Off-Road Vehicle Engine 2UZ-FE	•		GHA430008	
ALLION I (ZZT24_, NZT24_, AZT24_)						
1.5 (80 kW)	2001.06-2005.04	Saloon Engine 1NZ-FE	•		GHA426030	K
2.0 (114 kW)	2001.06-2005.04	Saloon Engine 1AZ-FSE	•		GHA426030	K
ALLION II (NZT26_, ZRT26_)						
1.5 (81 kW)	2007.07-	Saloon Engine 1NZ-FE	•		GHA426030	K
1.8 (106 kW)	2007.07-	Saloon Engine 2ZR-FAE	•		GHA426030	K
1.8 4WD (98 kW)	2007.07-	Saloon Engine 2ZR-FAE	•		GHA426030	K
	2007.07-	Saloon Engine 2ZR-FAE		o	GHA326057	
2.0 (116 kW)	2007.07-	Saloon Engine 3ZR-FAE	•		GHA426030	K
ALPHARD (ATH1_, MNH1_, ANH1_)						
2.4 (117 kW)	2003.09-2008.04	MPV Engine 2AZ-FE	•		GHA426026	
	2003.09-2008.04	MPV Engine 2AZ-FE		o	GHA400167	K
2.4 4WD (117 kW)	2003.09-2008.04	MPV Engine 2AZ-FE	•		GHA426026	
2.4 HybriD 4WD (117 kW)	2003.09-2008.04	MPV Engine 2AZ-FXE	•		GHA426026	
3.0 (162 kW)	2003.04-2008.04	MPV Engine 1MZ-FE	•		GHA430005	K
3.0 4WD (162 kW)	2003.04-2008.04	MPV Engine 1MZ-FE	•		GHA426026	
ALPHARD / VELLFIRE (GGH2_, ANH2_, ATH2_)						
2.4 (123 kW)	2008.04-2014.12	MPV Engine 2AZ-FE		o	GHA400310	
2.4 (125 kW)	2008.04-2014.12	MPV Engine 2AZ-FE		o	GHA400310	
3.5 (202 kW)	2008.04-2014.12	MPV Engine 2GR-FE		o	GHA400310	



	 YEAR		F	R	G-AP Ref.	KIT
TOYOTA						
ALPHARD / VELLFIRE (GGH2_, ANH2_, ATH2_)						
3.5 (206 kW)	2008.04-2014.12	MPV Engine 2GR-FE		o	GHA400310	
ALTEZZA (SXE1_, JCE1_, GXE1_)						
2.0 (114 kW)	1999.01-2005.07	Saloon Engine 1G-FE/1G-GE	•		GHA499084	
2.0 VVTi (118 kW)	1999.01-2005.07	Saloon Engine 1G-FE	•		GHA499084	
2.0 VVTi (147 kW)	1999.02-2005.07	Saloon Engine 3S-GE	•		GHA499084	
3.0 (157 kW)	2001.07-2005.07	Saloon Engine 2JZ-GE	•		GHA499084	
ALTEZZA GITA (SXE1_, GXE1_)						
2.0 (114 kW)	1999.01-2001.06	Estate Engine 1G-FE/1G-GE	•		GHA499084	
2.0 VVTi (147 kW)	1999.02-2005.06	Estate Engine 3S-GE	•		GHA499084	
ALTIS						
-	2008.01-	With ABS		o	GHA400094	
-	2008.01-	Without ABS		o	GHA400093	
AURION (GSV4_, ACV4_)						
3.5 (200 kW)	2006.03-2011.09	Saloon Engine 2GR-FE	•		GHA430005	K
AURIS (NRE15_, ZZE15_, ADE15_, ZRE15_, NDE15_)						
1.33 Dual-VVTi (73 kW)	2010.01-	Hatchback Engine 1NR-FE		o	GHA400079	
	2010.01-	Hatchback Engine 1NR-FE Inner Spline 26T	•		GHA326024	K
1.33 Dual-VVTi (74 kW)	2009.05-	Hatchback Engine 1NR-FE		o	GHA400079	
	2009.05-	Hatchback Engine 1NR-FE		o	GHA400090	
	2009.05-	Hatchback Engine 1NR-FE Inner Spline 26T	•		GHA326024	K
1.4 D-4D (66 kW)	2007.02-	Hatchback Engine 1ND-TV		o	GHA400079	
	2007.02-	Hatchback Engine 1ND-TV Inner Spline 26T	•		GHA326024	K
1.4 VVT-i (71 kW)	2007.02-	Hatchback Engine 4ZZ-FE		o	GHA400079	
	2007.02-	Hatchback Engine 4ZZ-FE		o	GHA400090	
	2007.02-	Hatchback Engine 4ZZ-FE Inner Spline 26T	•		GHA326024	K
1.6 (97 kW)	2009.05-	Hatchback Engine 1ZR-FAE		o	GHA400079	
	2009.05-	Hatchback Engine 1ZR-FAE		o	GHA400090	
	2009.05-	Hatchback Engine 1ZR-FAE Inner Spline 26T	•		GHA326024	K
1.6 VVT-i (91 kW)	2007.02-	Hatchback Engine 1ZR-FE		o	GHA400079	
	2007.02-	Hatchback Engine 1ZR-FE		o	GHA400090	
	2007.02-	Hatchback Engine 1ZR-FE Inner Spline 26T	•		GHA326024	K
1.8 (106 kW)	2009.02-	Hatchback Engine 2ZR-FAE		o	GHA400079	
	2009.02-	Hatchback Engine 2ZR-FAE		o	GHA400090	
	2009.02-	Hatchback Engine 2ZR-FAE Inner Spline 26T	•		GHA326024	K
1.8 (108 kW)	2009.02-	Hatchback Engine 2ZR-FAE		o	GHA400079	
	2009.02-	Hatchback Engine 2ZR-FAE		o	GHA400090	
	2009.02-	Hatchback Engine 2ZR-FAE Inner Spline 26T	•		GHA326024	K
1.8 HybriD (73 kW)	2010.09-	Hatchback Engine 2ZR-FXE		o	GHA400090	
	2010.09-	Hatchback Engine 2ZR-FXE Inner Spline 26T	•		GHA326024	K
2.0 D-4D (93 kW)	2007.02-	Hatchback Engine 1AD-FTV		o	GHA400079	
	2007.02-	Hatchback Engine 1AD-FTV Inner Spline 30T	•		GHA330014	K
2.2 D (130 kW)	2007.02-	Hatchback Engine 2AD-FHV		o	GHA400269	
	2007.02-	Hatchback Engine 2AD-FHV Inner Spline 30T	•		GHA330014	K
AURIS (NZE18_, ZRE18_)						
1.3 (73 kW)	2012.10-	Hatchback Engine 1NR-FE		o	GHA400079	
	2012.10-	Hatchback Engine 1NR-FE Inner Spline 26T	•		GHA326024	K
1.4 D-4D (66 kW)	2012.10-	Hatchback Engine 1ND-TV		o	GHA400079	
	2012.10-	Hatchback Engine 1ND-TV Inner Spline 26T	•		GHA326024	K
1.6 (97 kW)	2012.10-	Hatchback Engine 1ZR-FAE		o	GHA400269	
	2012.10-	Hatchback Engine 1ZR-FAE Inner Spline 26T	•		GHA326024	K
1.8 HybriD (73 kW)	2012.10-	Hatchback Engine 2ZR-FXE		o	GHA400269	
	2012.10-	Hatchback Engine 2ZR-FXE Inner Spline 26T	•		GHA326024	K
2.0 D-4D (91 kW)	2012.10-	Hatchback Engine 1AD-FTV		o	GHA400269	
	2012.10-	Hatchback Engine 1AD-FTV Inner Spline 30T	•		GHA330014	K
AURIS TOURING SPORTS (ADE18_, ZWE18_, ZRE18_)						
1.3 (73 kW)	2013.07-	Estate Engine 1NR-FE		o	GHA400079	
	2013.07-	Estate Engine 1NR-FE Inner Spline 26T	•		GHA326024	K
1.4 D-4D (66 kW)	2013.07-	Estate Engine 1ND-TV		o	GHA400079	
	2013.07-	Estate Engine 1ND-TV Inner Spline 26T	•		GHA326024	K
1.6 (97 kW)	2013.07-	Estate Engine 1ZR-FAE		o	GHA400269	
	2013.07-	Estate Engine 1ZR-FAE Inner Spline 26T	•		GHA326024	K
1.8 HybriD (73 kW)	2013.07-	Estate Engine 2ZR-FXE		o	GHA400269	
	2013.07-	Estate Engine 2ZR-FXE Inner Spline 26T	•		GHA326024	K



	 YEAR		F	R	G-AP Ref.	KIT
TOYOTA						
AURIS TOURING SPORTS (ADE18_ , ZWE18_ , ZRE18_)						
2.0 D-4D (91 kW)	2013.07-	Estate Engine 1AD-FTV		o	GHA400269	
	2013.07-	Estate Engine 1AD-FTV Inner Spline 30T	•		GHA330014	K
AVALON (GSX3_)						
3.5 VVTi (206 kW)	2005.01-	Saloon Engine 2GR-FE	•		GHA430005	K
AVALON (MCX1_)						
3.0 (140 kW)	1995.03-2005.05	Saloon Engine 1MZ-FE Without ABS		o	GHA400024	
AVALON (MCX2_)						
3.0 (137 kW)	2001.08-2005.04	Saloon Engine 1MZ-FE	•		GHA430001	K
	2001.08-2005.04	Saloon Engine 1MZ-FE Without ABS		o	GHA400024	
3.0 (145 kW)	2000.04-2005.06	Saloon Engine 1MZ-FE	•		GHA430001	K
	2000.04-2005.06	Saloon Engine 1MZ-FE Without ABS		o	GHA400024	
3.0 (157 kW)	1999.09-2004.12	Saloon Engine 1MZ-FE	•		GHA430001	K
	1999.09-2004.12	Saloon Engine 1MZ-FE Without ABS		o	GHA400024	
AVENSIS (_T22_)						
1.6 (74 kW)	1997.09-2000.10	Saloon Engine 4A-FE	•		GHA426030	K
	1997.09-2000.10	Saloon Engine 4A-FE	•		GWB3979	
1.6 (81 kW)	1997.09-2000.10	Saloon Engine 4A-FE	•		GHA426030	K
	1997.09-2000.10	Saloon Engine 4A-FE	•		GWB3979	
1.6 VVT-i (81 kW)	2000.10-2003.02	Saloon Engine 3ZZ-FE	•		GWB3979	
1.8 (81 kW)	1997.09-2000.10	Saloon Engine 7A-FE	•		GHA426030	K
	1997.09-2000.10	Saloon Engine 7A-FE	•		GWB3979	
1.8 VVT-i (95 kW)	2000.10-2003.02	Saloon Engine 1ZZ-FE	•		GWB3979	
2.0 (94 kW)	1997.09-2000.10	Saloon Engine 3S-FE	•		GHA426030	K
	1997.09-2000.10	Saloon Engine 3S-FE	•		GWB3979	
2.0 D (61 kW)	1997.10-1998.05	Saloon Engine 2C-T	•		GHA426030	K
	2.0 D-4D (81 kW)	1999.10-2003.02	Saloon Engine 1CD-FTV	•		GHA426030
1999.10-2003.02		Saloon Engine 1CD-FTV	•		GWB3979	
2.0 TD (66 kW)	1997.09-2003.02	Saloon Engine 2C-TE	•		GHA426030	K
	1997.09-2003.02	Saloon Engine 2C-TE	•		GWB3979	
2.0 VVT-i (110 kW)	2000.10-2003.02	Saloon Engine 1AZ-FSE	•		GWB3979	
AVENSIS (T25)						
1.6 VVT-i (81 kW)	2003.04-2008.11	Estate Engine 3ZZ-FE	•		GWB6831	
	2003.04-2008.11	Estate Engine 3ZZ-FE With ABS		o	GHA400095	
	2003.04-2008.11	Saloon Engine 3ZZ-FE	•		GWB6831	
	2003.04-2008.11	Saloon Engine 3ZZ-FE With ABS		o	GHA400095	
	2003.04-2008.11	Estate Engine 1ZZ-FE	•		GWB6831	
1.8 (95 kW)	2003.04-2008.11	Estate Engine 1ZZ-FE With ABS		o	GHA400095	
	2003.04-2008.11	Saloon Engine 1ZZ-FE	•		GWB6831	
	2003.04-2008.11	Saloon Engine 1ZZ-FE With ABS		o	GHA400095	
2.0 (108 kW)	2003.04-2008.11	Estate Engine 1AZ-FSE	•		GWB6831	
	2003.04-2008.11	Estate Engine 1AZ-FSE With ABS		o	GHA400095	
	2003.04-2008.11	Saloon Engine 1AZ-FSE	•		GWB6831	
	2003.04-2008.11	Saloon Engine 1AZ-FSE With ABS		o	GHA400095	
2.0 D-4D (85 kW)	2003.04-2008.11	Estate Engine 1CD-FTV	•		GWB6831	
	2003.04-2008.11	Estate Engine 1CD-FTV With ABS		o	GHA400095	
	2003.04-2008.11	Saloon Engine 1CD-FTV	•		GWB6831	
	2003.04-2008.11	Saloon Engine 1CD-FTV With ABS		o	GHA400095	
2.0 D-4D (93 kW)	2006.03-2008.11	Saloon Engine 1AD-FTV	•		GWB6831	
	2006.03-2008.11	Saloon Engine 1AD-FTV With ABS		o	GHA400095	
	2006.07-2008.11	Estate Engine 1AD-FTV	•		GWB6831	
	2006.07-2008.11	Estate Engine 1AD-FTV With ABS		o	GHA400095	
2.0 VVTi (114 kW)	2003.04-2008.11	Estate Engine 1AE-FE	•		GWB6831	
	2003.04-2008.11	Estate Engine 1AE-FE With ABS		o	GHA400095	
2.0 VVT-i (114 kW)	2003.04-2008.11	Saloon Engine 1AZ-FE	•		GWB6831	
	2003.04-2008.11	Saloon Engine 1AZ-FE With ABS		o	GHA400095	
2.2 D-4D (110 kW)	2005.07-2006.06	Estate Engine 2AD-FTV	•		GWB3946	
	2005.07-2006.06	Estate Engine 2AD-FTV		o	GHA400241	
	2005.07-2006.06	Saloon Engine 2AD-FTV	•		GWB3946	
	2005.07-2006.06	Saloon Engine 2AD-FTV		o	GHA400241	
2.2 D-CAT (130 kW)	2006.07-2008.11	Estate Engine 2AD-FHV	•		GWB3946	
	2006.07-2008.11	Estate Engine 2AD-FHV		o	GHA400241	
	2006.07-2008.11	Saloon Engine 2AD-FHV	•		GWB3946	
	2006.07-2008.11	Saloon Engine 2AD-FHV		o	GHA400241	



	 YEAR		F	R	G-AP Ref.	KIT
TOYOTA						
AVENSIS (T25)						
2.4 (120 kW)	2003.10-2006.05	Saloon Engine 2AZ-FSE	•		GWB6831	
	2003.10-2006.05	Saloon Engine 2AZ-FSE With ABS		○	GHA400095	
	2003.10-2008.11	Estate Engine 2AZ-FSE	•		GWB6831	
	2003.10-2008.11	Estate Engine 2AZ-FSE With ABS		○	GHA400095	
2.4 (125 kW)	2003.09-2008.11	Estate Engine 2AZ-FSE	•		GWB6831	
	2003.09-2008.11	Estate Engine 2AZ-FSE With ABS		○	GHA400095	
	2003.09-2008.11	Saloon Engine 2AZ-FSE	•		GWB6831	
	2003.09-2008.11	Saloon Engine 2AZ-FSE With ABS		○	GHA400095	
AVENSIS (T25_)						
1.6 VVT-i (81 kW)	2003.04-2008.11	Hatchback Engine 3ZZ-FE	•		GWB6831	
	2003.04-2008.11	Hatchback Engine 3ZZ-FE With ABS		○	GHA400095	
1.8 (95 kW)	2003.04-2008.11	Hatchback Engine 1ZZ-FE	•		GWB6831	
	2003.04-2008.11	Hatchback Engine 1ZZ-FE With ABS		○	GHA400095	
2.0 (108 kW)	2003.04-2008.11	Hatchback Engine 1AZ-FSE	•		GWB6831	
	2003.04-2008.11	Hatchback Engine 1AZ-FSE With ABS		○	GHA400095	
2.0 D-4D (85 kW)	2003.04-2008.11	Hatchback Engine 1CD-FTV	•		GWB6831	
	2003.04-2008.11	Hatchback Engine 1CD-FTV With ABS		○	GHA400095	
2.0 D-4D (93 kW)	2006.07-2007.05	Hatchback Engine 1AD-FTV	•		GWB6831	
	2006.07-2007.05	Hatchback Engine 1AD-FTV With ABS		○	GHA400095	
2.2 D-4D (110 kW)	2005.07-2006.06	Hatchback Engine 2AD-FTV	•		GWB3946	
	2005.07-2006.06	Hatchback Engine 2AD-FTV		○	GHA400241	
2.2 D-CAT (130 kW)	2006.07-2008.11	Hatchback Engine 2AD-FHV	•		GWB3946	
	2006.07-2008.11	Hatchback Engine 2AD-FHV		○	GHA400241	
2.4 (120 kW)	2003.10-2006.05	Hatchback Engine 2AZ-FSE	•		GWB6831	
	2003.10-2006.05	Hatchback Engine 2AZ-FSE With ABS		○	GHA400095	
2.4 (125 kW)	2003.09-2008.11	Hatchback Engine 2AZ-FSE	•		GWB6831	
	2003.09-2008.11	Hatchback Engine 2AZ-FSE With ABS		○	GHA400095	
AVENSIS (ZRT27, ADT27)						
1.6 (97 kW)	2009.02-	Estate Engine 1ZR-FAE		○	GHA400269	
	2009.02-	Estate Engine 1ZR-FAE Inner Spline 26T	•		GHA326024	K
	2009.02-	Saloon Engine 1ZR-FAE		○	GHA400269	
	2009.02-	Saloon Engine 1ZR-FAE Inner Spline 26T	•		GHA326024	K
1.6 D4-D (82 kW)	2015.04-	Estate Engine 1WW		○	GHA400269	
	2015.04-	Estate Engine 1WW Inner Spline 30T	•		GHA330014	K
	2015.04-	Saloon Engine 1WW		○	GHA400269	
	2015.04-	Saloon Engine 1WW Inner Spline 30T	•		GHA330014	K
1.8 (108 kW)	2009.02-	Estate Engine 2ZR-FAE		○	GHA400269	
	2009.02-	Estate Engine 2ZR-FAE Inner Spline 26T	•		GHA326024	K
	2009.02-	Saloon Engine 2ZR-FAE		○	GHA400269	
	2009.02-	Saloon Engine 2ZR-FAE Inner Spline 26T	•		GHA326024	K
2.0 (112 kW)	2009.02-	Estate Engine 3ZR-FAE		○	GHA400269	
	2009.02-	Estate Engine 3ZR-FAE Inner Spline 26T	•		GHA326024	K
	2009.02-	Saloon Engine 3ZR-FAE		○	GHA400269	
	2009.02-	Saloon Engine 3ZR-FAE Inner Spline 26T	•		GHA326024	K
2.0 D-4D (105 kW)	2015.04-	Estate Engine 2WW		○	GHA400269	
	2015.04-	Estate Engine 2WW Inner Spline 30T	•		GHA330014	K
	2015.04-	Saloon Engine 2WW		○	GHA400269	
	2015.04-	Saloon Engine 2WW Inner Spline 30T	•		GHA330014	K
2.0 D-4D (91 kW)	2011.11-	Estate Engine 1AD-FTV		○	GHA400269	
	2011.11-	Estate Engine 1AD-FTV Inner Spline 30T	•		GHA330014	K
	2011.11-	Saloon Engine 1AD-FTV		○	GHA400269	
	2011.11-	Saloon Engine 1AD-FTV Inner Spline 30T	•		GHA330014	K
2.0 D-4D (93 kW)	2009.02-	Estate Engine 1AD-FTV		○	GHA400269	
	2009.02-	Estate Engine 1AD-FTV Inner Spline 30T	•		GHA330014	K
	2009.02-	Saloon Engine 1AD-FTV		○	GHA400269	
	2009.02-	Saloon Engine 1AD-FTV Inner Spline 30T	•		GHA330014	K
2.2 D-4D (110 kW)	2009.02-	Estate Engine 2AD-FTV/2AD-FHV		○	GHA400269	
	2009.02-	Estate Engine 2AD-FTV/2AD-FHV Inner Spline 30T	•		GHA330014	K
	2009.02-	Saloon Engine 2AD-FTV		○	GHA400269	
	2009.02-	Saloon Engine 2AD-FTV Inner Spline 30T	•		GHA330014	K
2.2 D-4D (130 kW)	2009.02-	Estate Engine 2AD-FHV		○	GHA400269	
	2009.02-	Estate Engine 2AD-FHV Inner Spline 30T	•		GHA330014	K
	2009.02-	Saloon Engine 2AD-FHV		○	GHA400269	
	2009.02-	Saloon Engine 2AD-FHV Inner Spline 30T	•		GHA330014	K



	 YEAR		F	R	G-AP Ref.	KIT
TOYOTA						
AVENSIS LIFTBACK (_T22_)						
1.6 (74 kW)	1997.09-2000.10	Hatchback Engine 4A-FE	•		GHA426030	K
	1997.09-2000.10	Hatchback Engine 4A-FE	•		GWB3979	
1.6 (81 kW)	1997.09-2000.10	Hatchback Engine 4A-FE	•		GHA426030	K
	1997.09-2000.10	Hatchback Engine 4A-FE	•		GWB3979	
1.6 VVT-i (81 kW)	2000.10-2003.02	Hatchback Engine 3ZZ-FE	•		GWB3979	
1.8 (81 kW)	1997.09-2000.10	Hatchback Engine 7A-FE	•		GHA426030	K
	1997.09-2000.10	Hatchback Engine 7A-FE	•		GWB3979	
1.8 VVT-i (95 kW)	2000.10-2003.02	Hatchback Engine 1ZZ-FE	•		GWB3979	
2.0 (94 kW)	1997.09-2000.10	Hatchback Engine 3S-FE	•		GHA426030	K
	1997.09-2000.10	Hatchback Engine 3S-FE	•		GWB3979	
2.0 D (85 kW)	2002.09-2003.02	Hatchback Engine 1CD-FTV	•		GWB3979	
2.0 D-4D (81 kW)	1999.10-2003.02	Hatchback Engine 1CD-FTV	•		GHA426030	K
	1999.10-2003.02	Hatchback Engine 1CD-FTV	•		GWB3979	
2.0 TD (66 kW)	1997.09-2003.02	Hatchback Engine 2C-TE	•		GHA426030	K
	1997.09-2003.02	Hatchback Engine 2C-TE	•		GWB3979	
2.0 VVT-i (110 kW)	2000.10-2003.02	Hatchback Engine 1AZ-FSE	•		GWB3979	
AVENSIS STATION WAGON (_T22_)						
1.6 (74 kW)	1997.09-2000.10	Estate Engine 4A-FE	•		GHA426030	K
	1997.09-2000.10	Estate Engine 4A-FE	•		GWB3979	
1.6 (81 kW)	1997.09-2000.10	Estate Engine 4A-FE	•		GHA426030	K
	1997.09-2000.10	Estate Engine 4A-FE	•		GWB3979	
1.6 VVT-i (81 kW)	2000.10-2003.02	Estate Engine 3ZZ-FE	•		GWB3979	
1.8 (81 kW)	1997.09-2000.10	Estate Engine 7A-FE	•		GHA426030	K
	1997.09-2000.10	Estate Engine 7A-FE	•		GWB3979	
1.8 VVT-i (95 kW)	2000.10-2003.02	Estate Engine 1ZZ-FE	•		GWB3979	
1.9 D (61 kW)	1997.10-1998.05	Estate Engine 2C-T	•		GHA426030	K
2.0 (94 kW)	1997.09-2000.10	Estate Engine 3S-FE	•		GHA426030	K
	1997.09-2000.10	Estate Engine 3S-FE	•		GWB3979	
2.0 D-4D (81 kW)	1999.10-2003.02	Estate Engine 1CD-FTV	•		GHA426030	K
	1999.10-2003.02	Estate Engine 1CD-FTV	•		GWB3979	
2.0 TD (66 kW)	1997.09-2003.02	Estate Engine 2C-TE	•		GHA426030	K
	1997.09-2003.02	Estate Engine 2C-TE	•		GWB3979	
2.0 VVT-i (110 kW)	2000.10-2003.02	Estate Engine 1AZ-FSE	•		GWB3979	
AVENSIS VERSO (_CLM2_ , _ACM2_)						
2.0 D-4D (85 kW)	2001.08-2005.08	MPV Engine 1CD-FTV	•		GWB3945	
	2001.08-2005.08	MPV Engine 1CD-FTV With ABS		◦	GHA400121	
2.0 VVT-i (110 kW)	2001.08-2009.11	MPV Engine 1AZ-FE	•		GHA426049	K
	2001.08-2009.11	MPV Engine 1AZ-FE	•		GWB3945	
	2001.08-2009.11	MPV Engine 1AZ-FE With ABS		◦	GHA400121	
2.4 VVT-i 4WD (115 kW)	2003.11-2006.08	MPV Engine 2AZ-FE	•		GHA426049	K
2.4 VVT-i GLS (115 kW)	2003.10-2009.11	MPV Engine 2AZ-FE	•		GHA426049	K
	2003.10-2009.11	MPV Engine 2AZ-FE	•		GWB3945	
	2003.10-2009.11	MPV Engine 2AZ-FE With ABS		◦	GHA400121	
AYGO (PAB4_ , KGB4_)						
1.0 (51 kW)	2014.05-	Hatchback Engine 1KR-FE	•		GWB3684	
	2014.05-	Hatchback Engine 1KR-FE		◦	GHA400149	
AYGO (WNB1_ , KGB1_)						
1.0 (50 kW)	2005.07-	Hatchback Engine 1KR-FE	•		GWB3684	
	2005.07-	Hatchback Engine 1KR-FE		◦	GHA400149	
1.0 GPL (50 kW)	2005.07-	Hatchback Engine 1KR-FE	•		GWB3684	
	2005.07-	Hatchback Engine 1KR-FE		◦	GHA400149	
1.4 HDi (40 kW)	2006.01-2007.08	Hatchback Engine 2WZ-TV	•		GWB3684	
	2006.01-2007.08	Hatchback Engine 2WZ-TV		◦	GHA400149	
BREVIS (JCG1_)						
3.0 (162 kW)	1999.10-2007.06	Saloon Engine 2JZ-FSE	•		GHA499084	
CALDINA (ZZT24_ , ST24_ , AZT24_)						
2.0 (121 kW)	2002.09-2007.06	Estate Engine 1AZ-FSE	•		GHA426030	K
CAMRY (_CV1_ , _XV1_ , _V1_)						
2.2 (100 kW)	1991.06-1996.08	Saloon Engine 5S-FE	•		GHA426015	K
	1991.06-1996.08	Saloon Engine 5S-FE	•		GWB3237	
	1991.06-1996.08	Saloon Engine 5S-FE		◦	GHA230026	K
	1991.06-1996.08	Saloon Engine 5S-FE With ABS		◦	GHA400086	K
	1991.06-1996.08	Saloon Engine 5S-FE Without ABS		◦	GHA400024	



	 YEAR		F	R	G-AP Ref.	KIT
TOYOTA						
CAMRY (_CV1_, _XV1_, _V1_)						
2.2 (93 kW)	1993.02-1995.04	Saloon Engine 5S-FE	•		GHA426015	K
	1993.02-1995.04	Saloon Engine 5S-FE	•		GWB3237	
	1993.02-1995.04	Saloon Engine 5S-FE		◦	GHA230026	K
	1993.02-1995.04	Saloon Engine 5S-FE With ABS		◦	GHA400086	K
	1993.02-1995.04	Saloon Engine 5S-FE Without ABS		◦	GHA400024	
2000ZX 4WD (100 kW)	1991.06-1997.09	Saloon Engine 3S-FE		◦	GHA426052	
3.0 (135 kW)	1993.09-1996.07	Saloon Engine 1MZ-FE	•		GWB3237	
	1993.09-1996.07	Saloon Engine 1MZ-FE		◦	GHA230026	K
	1993.09-1996.07	Saloon Engine 1MZ-FE With ABS		◦	GHA400086	K
	1993.09-1996.07	Saloon Engine 1MZ-FE Without ABS		◦	GHA400024	
3.0 (136 kW)	1993.02-1995.09	Saloon Engine 3VZ-FE	•		GWB3237	
	1993.02-1995.09	Saloon Engine 3VZ-FE		◦	GHA230026	K
	1993.02-1995.09	Saloon Engine 3VZ-FE With ABS		◦	GHA400086	K
3.0 (138 kW)	1993.02-1995.09	Saloon Engine 3VZ-FE Without ABS		◦	GHA400024	
	1991.06-1996.08	Saloon Engine 3VZ-FE	•		GWB3237	
	1991.06-1996.08	Saloon Engine 3VZ-FE		◦	GHA230026	K
3.0 (138 kW)	1991.06-1996.08	Saloon Engine 3VZ-FE With ABS		◦	GHA400086	K
	1991.06-1996.08	Saloon Engine 3VZ-FE Without ABS		◦	GHA400024	
CAMRY (_CV2_, _XV2_)						
2.2 (93 kW)	2000.11-2001.11	Saloon Engine 5S-FE	•		GHA426015	K
	2000.11-2001.11	Saloon Engine 5S-FE	•		GWB3237	
	2000.11-2001.11	Saloon Engine 5S-FE With ABS		◦	GHA400086	K
2.2 (96 kW)	1996.08-2001.11	Saloon Engine 5S-FE	•		GHA426015	K
	1996.08-2001.11	Saloon Engine 5S-FE	•		GWB3237	
	1996.08-2001.11	Saloon Engine 5S-FE With ABS		◦	GHA400086	K
3.0 24V (140 kW)	1996.08-2001.11	Saloon Engine 1MZ-FE	•		GHA430001	K
	1996.08-2001.11	Saloon Engine 1MZ-FE	•		GWB3237	
	1996.08-2001.11	Saloon Engine 1MZ-FE With ABS		◦	GHA400086	K
3.0 V6 (135 kW)	1996.08-2001.11	Saloon Engine 1MZ-FE	•		GWB3237	
	1996.08-2001.11	Saloon Engine 1MZ-FE With ABS		◦	GHA400086	K
CAMRY (_XV4_)						
2.4 VVTi (116 kW)	2006.01-2011.09	Saloon Engine 2AZ-FE	•		GWB3946	
	2006.01-2011.09	Saloon Engine 2AZ-FE Left With ABS		◦	GHA400061	
	2006.01-2011.09	Saloon Engine 2AZ-FE Right With ABS		◦	GHA400060	
2.4 VVTi (123 kW)	2006.01-2011.09	Saloon Engine 2AZ-FE	•		GWB3946	
	2006.01-2011.09	Saloon Engine 2AZ-FE Left With ABS		◦	GHA400061	
	2006.01-2011.09	Saloon Engine 2AZ-FE Right With ABS		◦	GHA400060	
3.5 (204 kW)	2008.01-2011.09	Saloon Engine 2GR-FE	•		GWB3946	
	2008.01-2011.09	Saloon Engine 2GR-FE Left With ABS		◦	GHA400061	
	2008.01-2011.09	Saloon Engine 2GR-FE Right With ABS		◦	GHA400060	
CAMRY (AVV5_, XV5_)						
2.5 (133 kW)	2011.09-	Saloon Engine 2AR-FE	•		GHA426026	
	2011.09-	Saloon Engine 2AR-FE	•		GWB3946	
	2011.09-	Saloon Engine 2AR-FE		◦	GHA400343	
	2011.09-	Saloon Engine 2AR-FE		◦	GHA400344	
3.5 (204 kW)	2011.09-	Saloon Engine 2GR-FE	•		GWB3946	
CAMRY (MCV3_, ACV3_, XV3_)						
2.0 VVTi (110 kW)	2001.08-2006.11	Saloon Engine 1AZ-FE	•		GHA426026	
	2001.08-2006.11	Saloon Engine 1AZ-FE	•		GWB3945	
	2001.08-2006.11	Saloon Engine 1AZ-FE	•		GWB3946	
	2001.08-2006.11	Saloon Engine 1AZ-FE Left With ABS		◦	GHA400061	
	2001.08-2006.11	Saloon Engine 1AZ-FE Right With ABS		◦	GHA400060	
2.4 VVT-i (112 kW)	2001.11-2006.11	Saloon Engine 2AZ-FE	•		GHA426026	
	2001.11-2006.11	Saloon Engine 2AZ-FE	•		GWB3945	
	2001.11-2006.11	Saloon Engine 2AZ-FE	•		GWB3946	
	2001.11-2006.11	Saloon Engine 2AZ-FE Left With ABS		◦	GHA400061	
	2001.11-2006.11	Saloon Engine 2AZ-FE Right With ABS		◦	GHA400060	
	2001.11-2006.11	Saloon Engine 2AZ-FE Without ABS		◦	GHA400024	
2.4 VVTi (120 kW)	2002.01-2006.11	Saloon Engine 2AZ-FE	•		GHA426026	
	2002.01-2006.11	Saloon Engine 2AZ-FE Without ABS		◦	GHA400024	
3.0 (141 kW)	2002.09-2006.11	Saloon Engine 1MZ-FE	•		GHA430001	K
	2002.09-2006.11	Saloon Engine 1MZ-FE	•		GHA430005	K
	2002.09-2006.11	Saloon Engine 1MZ-FE	•		GWB3945	
	2002.09-2006.11	Saloon Engine 1MZ-FE	•		GWB3946	



	 YEAR		F	R	G-AP Ref.	KIT	
TOYOTA							
CAMRY (MCV3_, ACV3_, XV3_)							
3.0 (141 kW)	2002.09-2006.11	Saloon Engine 1MZ-FE Left With ABS		o	GHA400061		
	2002.09-2006.11	Saloon Engine 1MZ-FE Right With ABS		o	GHA400060		
	2002.09-2006.11	Saloon Engine 1MZ-FE Without ABS		o	GHA400024		
3.0 V6 (137 kW)	2001.11-2006.11	Saloon Engine 1MZ-FE	•		GHA430001	K	
	2001.11-2006.11	Saloon Engine 1MZ-FE	•		GHA430005	K	
	2001.11-2006.11	Saloon Engine 1MZ-FE	•		GWB3945		
	2001.11-2006.11	Saloon Engine 1MZ-FE	•		GWB3946		
	2001.11-2006.11	Saloon Engine 1MZ-FE Left With ABS		o	GHA400061		
	2001.11-2006.11	Saloon Engine 1MZ-FE Right With ABS		o	GHA400060		
	2001.11-2006.11	Saloon Engine 1MZ-FE Without ABS		o	GHA400024		
3.3 VVTi (165 kW)	2002.08-2005.12	Saloon Engine 3MZ-FE	•		GHA430005	K	
3.5 VVTi XLE (197 kW)	2006.01-2006.11	Saloon Engine 2GR-FE	•		GWB3946		
	2006.01-2006.11	Saloon Engine 2GR-FE Left With ABS		o	GHA400061		
	2006.01-2006.11	Saloon Engine 2GR-FE Right With ABS		o	GHA400060		
CAMRY SOLARA (MCV3_, ACV3_)							
2.4 (117 kW)	2003.07-2008.07	Coupe Engine 2AZ-FE	•		GHA426026		
	2003.07-2008.07	Coupe Engine 2AZ-FE	•		GWB3945		
	2003.07-2008.07	Coupe Engine 2AZ-FE	•		GWB3946		
	2003.07-2008.07	Coupe Engine 2AZ-FE Left With ABS		o	GHA400061		
	2003.07-2008.07	Coupe Engine 2AZ-FE Right With ABS		o	GHA400060		
	2003.07-2008.07	Coupe Engine 2AZ-FE Without ABS		o	GHA400024		
	2004.02-2008.11	Convertible Engine 2AZ-FE	•		GHA426026		
	2004.02-2008.11	Convertible Engine 2AZ-FE	•		GWB3946		
	2004.02-2008.11	Convertible Engine 2AZ-FE Left With ABS		o	GHA400061		
	2004.02-2008.11	Convertible Engine 2AZ-FE Right With ABS		o	GHA400060		
	2004.02-2008.11	Convertible Engine 2AZ-FE Without ABS		o	GHA400024		
	3.0 (137 kW)	2003.07-2008.07	Coupe Engine 1MZ-FE	•		GHA430001	K
		2003.07-2008.07	Coupe Engine 1MZ-FE	•		GHA430005	K
2003.07-2008.07		Coupe Engine 1MZ-FE	•		GWB3945		
2003.07-2008.07		Coupe Engine 1MZ-FE	•		GWB3946		
2003.07-2008.07		Coupe Engine 1MZ-FE Left With ABS		o	GHA400061		
2003.07-2008.07		Coupe Engine 1MZ-FE Right With ABS		o	GHA400060		
2003.07-2008.07		Coupe Engine 1MZ-FE Without ABS		o	GHA400024		
2004.02-2008.11		Convertible Engine 1MZ-FE	•		GHA430001	K	
2004.02-2008.11		Convertible Engine 1MZ-FE	•		GHA430005	K	
2004.02-2008.11		Convertible Engine 1MZ-FE	•		GWB3946		
2004.02-2008.11		Convertible Engine 1MZ-FE Left With ABS		o	GHA400061		
2004.02-2008.11		Convertible Engine 1MZ-FE Right With ABS		o	GHA400060		
2004.02-2008.11		Convertible Engine 1MZ-FE Without ABS		o	GHA400024		
3.3 (155 kW)	2003.07-2008.07	Coupe Engine 3MZ-FE	•		GHA430005	K	
3.3 (165 kW)	2004.02-2008.11	Convertible Engine 3MZ-FE	•		GHA430005	K	
	2003.07-2008.07	Coupe Engine 3MZ-FE	•		GHA430005	K	
3.3 (165 kW)	2004.02-2008.11	Convertible Engine 3MZ-FE	•		GHA430005	K	
	2003.07-2008.07	Coupe Engine 3MZ-FE	•		GHA430005	K	
CAMRY STATION WAGON (_V2_)							
2.5 (118 kW)	1990.01-1991.05	Estate Engine 2VZ-FE	•		GWB1340		
	1990.01-1991.05	Estate Engine 2VZ-FE		o	GHA230026	K	
CAMRY STATION WAGON (_XV1_, _CV1_, _V10)							
2.2 (100 kW)	1992.03-1996.07	Estate Engine 5S-FE	•		GHA426015	K	
	1992.03-1996.07	Estate Engine 5S-FE	•		GWB3237		
	1992.03-1996.07	Estate Engine 5S-FE With ABS		o	GHA400086	K	
	1992.03-1996.07	Estate Engine 5S-FE Without ABS		o	GHA400024		
3.0 (136 kW)	1993.02-1995.09	Estate Engine 3VZ-FE	•		GWB3237		
	1993.02-1995.09	Estate Engine 3VZ-FE With ABS		o	GHA400086	K	
	1993.02-1995.09	Estate Engine 3VZ-FE Without ABS		o	GHA400024		
3.0 (138 kW)	1992.03-1996.07	Estate Engine 3VZ-FE	•		GWB3237		
	1992.03-1996.07	Estate Engine 3VZ-FE With ABS		o	GHA400086	K	
	1992.03-1996.07	Estate Engine 3VZ-FE Without ABS		o	GHA400024		
CARINA E (_T19_)							
1.6 (73 kW)	1993.12-1997.09	Hatchback Engine 4A-FE	•		GWB1340		
	1993.12-1997.09	Hatchback Engine 4A-FE	•		GWB3308		
	1993.12-1997.09	Hatchback Engine 4A-FE		o	GHA230038	K	
	1993.12-1997.09	Hatchback Engine 4A-FE With ABS		o	GHA400067		
	1995.01-1997.09	Saloon Engine 4A-FE	•		GWB1340		
	1995.01-1997.09	Saloon Engine 4A-FE	•		GWB3308		



	 YEAR		F	R	G-AP Ref.	KIT
TOYOTA						
CARINA E (T19)						
1.6 (73 kW)	1995.01-1997.09	Saloon Engine 4A-FE		o	GHA230038	K
	1995.01-1997.09	Saloon Engine 4A-FE With ABS		o	GHA400067	
1.6 (78 kW)	1995.10-1997.09	Saloon Engine 4A-FE	•		GWB1340	
	1995.10-1997.09	Saloon Engine 4A-FE	•		GWB3308	
	1995.10-1997.09	Saloon Engine 4A-FE		o	GHA230038	K
	1995.10-1997.09	Saloon Engine 4A-FE With ABS		o	GHA400067	
1.6 (79 kW)	1993.01-1997.09	Saloon Engine 4A-FE	•		GWB1340	
	1993.01-1997.09	Saloon Engine 4A-FE	•		GWB3308	
	1993.01-1997.09	Saloon Engine 4A-FE		o	GHA230038	K
	1993.01-1997.09	Saloon Engine 4A-FE With ABS		o	GHA400067	
1.6 (85 kW)	1992.04-1997.09	Estate Engine 4A-FE	•		GWB1340	
	1992.04-1997.09	Estate Engine 4A-FE	•		GWB3308	
	1992.04-1997.09	Estate Engine 4A-FE		o	GHA230038	K
	1993.12-1997.09	Hatchback Engine 4A-FE	•		GWB1340	
	1993.12-1997.09	Hatchback Engine 4A-FE	•		GWB3308	
	1993.12-1997.09	Hatchback Engine 4A-FE		o	GHA230038	K
	1993.12-1997.09	Hatchback Engine 4A-FE With ABS		o	GHA400067	
1.6 16V (78 kW)	1995.10-1997.09	Hatchback Engine 4A-FE	•		GWB1340	
	1995.10-1997.09	Hatchback Engine 4A-FE	•		GWB3308	
	1995.10-1997.09	Hatchback Engine 4A-FE		o	GHA230038	K
1.6 16V (85 kW)	1994.12-1997.09	Saloon Engine 4A-FE	•		GWB1340	
	1994.12-1997.09	Saloon Engine 4A-FE	•		GWB3308	
	1994.12-1997.09	Saloon Engine 4A-FE		o	GHA230038	K
	1994.12-1997.09	Saloon Engine 4A-FE With ABS		o	GHA400067	
1.6 GLi (79 kW)	1992.04-1997.09	Hatchback Engine 4A-FE	•		GWB1340	
	1992.04-1997.09	Hatchback Engine 4A-FE	•		GWB3308	
	1992.04-1997.09	Hatchback Engine 4A-FE		o	GHA230038	K
	1992.04-1997.09	Hatchback Engine 4A-FE With ABS		o	GHA400067	
	1993.01-1997.09	Estate Engine 4A-FE	•		GWB1340	
	1993.01-1997.09	Estate Engine 4A-FE	•		GWB3308	
	1993.01-1997.09	Estate Engine 4A-FE		o	GHA230038	K
	1993.01-1997.09	Estate Engine 4A-FE With ABS		o	GHA400067	
1.6 i (73 kW)	1995.02-1997.09	Estate Engine 4A-FE	•		GWB1340	
	1995.02-1997.09	Estate Engine 4A-FE	•		GWB3308	
	1995.02-1997.09	Estate Engine 4A-FE		o	GHA230038	K
	1995.02-1997.09	Estate Engine 4A-FE With ABS		o	GHA400067	
1.8 (79 kW)	1995.01-1997.09	Hatchback Engine 7A-FE	•		GWB1340	
	1995.01-1997.09	Hatchback Engine 7A-FE	•		GWB3308	
	1995.01-1997.09	Hatchback Engine 7A-FE		o	GHA230038	K
	1995.01-1997.09	Hatchback Engine 7A-FE With ABS		o	GHA400067	
1.8 i (79 kW)	1995.02-1997.09	Estate Engine 7A-FE	•		GWB1340	
	1995.02-1997.09	Estate Engine 7A-FE	•		GWB3308	
	1995.02-1997.09	Estate Engine 7A-FE		o	GHA230038	K
	1995.02-1997.09	Estate Engine 7A-FE With ABS		o	GHA400067	
1.8 i 16V (79 kW)	1995.01-1997.09	Saloon Engine 7A-FE	•		GWB1340	
	1995.01-1997.09	Saloon Engine 7A-FE	•		GWB3308	
	1995.01-1997.09	Saloon Engine 7A-FE		o	GHA230038	K
	1995.01-1997.09	Saloon Engine 7A-FE With ABS		o	GHA400067	
2.0 (98 kW)	1993.01-1997.09	Saloon Engine 3S-FE	•		GWB1340	
	1993.01-1997.09	Saloon Engine 3S-FE	•		GWB3308	
	1993.01-1997.09	Saloon Engine 3S-FE		o	GHA230038	K
	1993.01-1997.09	Saloon Engine 3S-FE With ABS		o	GHA400067	
2.0 D (54 kW)	1992.04-1996.01	Hatchback Engine 2C	•		GWB1340	
	1992.04-1996.01	Hatchback Engine 2C	•		GWB3308	
	1992.04-1996.01	Hatchback Engine 2C		o	GHA230038	K
	1992.04-1996.01	Hatchback Engine 2C With ABS		o	GHA400067	
	1992.08-1996.01	Saloon Engine 2C	•		GWB1340	
	1992.08-1996.01	Saloon Engine 2C	•		GWB3308	
	1992.08-1996.01	Saloon Engine 2C		o	GHA230038	K
	1992.08-1996.01	Saloon Engine 2C With ABS		o	GHA400067	
	1993.01-1996.01	Estate Engine 2C	•		GWB1340	
	1993.01-1996.01	Estate Engine 2C	•		GWB3308	
	1993.01-1996.01	Estate Engine 2C		o	GHA230038	K
	1993.01-1996.01	Estate Engine 2C With ABS		o	GHA400067	



	 YEAR		F	R	G-AP Ref.	KIT
TOYOTA						
CARINA E (T19)						
2.0 GLi (98 kW)	1992.04-1997.09	Hatchback Engine 3S-FE	•		GWB1340	
	1992.04-1997.09	Hatchback Engine 3S-FE	•		GWB3308	
	1992.04-1997.09	Hatchback Engine 3S-FE		◦	GHA230038	K
	1992.04-1997.09	Hatchback Engine 3S-FE With ABS		◦	GHA400067	
	1993.01-1997.09	Estate Engine 3S-FE	•		GWB1340	
	1993.01-1997.09	Estate Engine 3S-FE	•		GWB3308	
	1993.01-1997.09	Estate Engine 3S-FE		◦	GHA230038	K
	1993.01-1997.09	Estate Engine 3S-FE With ABS		◦	GHA400067	
2.0 GTi (116 kW)	1992.04-1994.02	Hatchback Engine 3S-GE	•		GWB1340	
	1992.04-1994.02	Hatchback Engine 3S-GE	•		GWB3308	
	1992.04-1994.02	Hatchback Engine 3S-GE		◦	GHA230038	K
	1992.04-1994.02	Hatchback Engine 3S-GE With ABS		◦	GHA400067	
	1992.04-1994.02	Saloon Engine 3S-GE	•		GWB1340	
	1992.04-1994.02	Saloon Engine 3S-GE	•		GWB3308	
	1992.04-1994.02	Saloon Engine 3S-GE		◦	GHA230038	K
2.0 GTi 16V (129 kW)	1992.04-1994.02	Saloon Engine 3S-GE With ABS		◦	GHA400067	
	1994.03-1997.09	Hatchback Engine 3S-GE	•		GWB1340	
	1994.03-1997.09	Hatchback Engine 3S-GE	•		GWB3308	
	1994.03-1997.09	Hatchback Engine 3S-GE		◦	GHA230038	K
	1994.03-1997.09	Hatchback Engine 3S-GE With ABS		◦	GHA400067	
	1994.03-1997.09	Saloon Engine 3S-GE	•		GWB1340	
	1994.03-1997.09	Saloon Engine 3S-GE	•		GWB3308	
2.0 i (93 kW)	1994.03-1997.09	Saloon Engine 3S-GE		◦	GHA230038	K
	1994.03-1997.09	Saloon Engine 3S-GE With ABS		◦	GHA400067	
	1992.12-1997.09	Saloon Engine 3S-FE	•		GWB1340	
	1992.12-1997.09	Saloon Engine 3S-FE	•		GWB3308	
	1992.12-1997.09	Saloon Engine 3S-FE		◦	GHA230038	K
	1992.12-1997.09	Saloon Engine 3S-FE With ABS		◦	GHA400067	
	1993.12-1997.09	Hatchback Engine 3S-FE	•		GWB1340	
2.0 TD (61 kW)	1993.12-1997.09	Hatchback Engine 3S-FE	•		GWB3308	
	1993.12-1997.09	Hatchback Engine 3S-FE		◦	GHA230038	K
	1993.12-1997.09	Hatchback Engine 3S-FE With ABS		◦	GHA400067	
	1995.05-1997.09	Estate Engine 3S-FE	•		GWB1340	
	1995.05-1997.09	Estate Engine 3S-FE	•		GWB3308	
	1995.05-1997.09	Estate Engine 3S-FE		◦	GHA230038	K
	1995.05-1997.09	Estate Engine 3S-FE With ABS		◦	GHA400067	
	1996.01-1997.09	Estate Engine 2C-T	•		GWB1340	
	1996.01-1997.09	Estate Engine 2C-T	•		GWB3308	
	1996.01-1997.09	Estate Engine 2C-T		◦	GHA230038	K
CELICA (AT20_, ST20_)	1996.01-1997.09	Hatchback Engine 2C-T	•		GWB1340	
	1996.01-1997.09	Hatchback Engine 2C-T	•		GWB3308	
	1996.01-1997.09	Hatchback Engine 2C-T		◦	GHA230038	K
	1996.01-1997.09	Saloon Engine 2C-T	•		GWB1340	
	1996.01-1997.09	Saloon Engine 2C-T	•		GWB3308	
	1996.01-1997.09	Saloon Engine 2C-T		◦	GHA230038	K
	1996.01-1997.09	Saloon Engine 2C-T		◦	GHA400067	
	1996.01-1997.09	Saloon Engine 2C-T		◦	GHA230038	K
CELICA (ST20_, AT20_)						
2.0 GTi (129 kW)	1994.08-1999.08	Convertible Engine 3S-GE		◦	GHA230038	K
2.0 i 16V (125 kW)	1993.11-1999.08	Convertible Engine 3S-GE		◦	GHA230038	K
CELICA (ST20_, AT20_)						
1.8 i 16V (85 kW)	1993.11-1999.11	Coupe Engine 7A-FE	•		GWB3308	
	1993.11-1999.11	Coupe Engine 7A-FE		◦	GHA230038	K
2.0 i 16V (125 kW)	1996.04-1999.11	Coupe Engine 3S-GE		◦	GHA230038	K
2.0 i 16V (129 kW)	1993.11-1999.11	Coupe Engine 3S-GE	•		GWB3308	
	1993.11-1999.11	Coupe Engine 3S-GE		◦	GHA230038	K
CELICA (ZZT23_)						
1.8 16V TS (141 kW)	1999.08-2005.09	Coupe Engine 2ZZ-GE	•		GHA426030	K
	1999.08-2005.09	Coupe Engine 2ZZ-GE	•		GWB6831	
	1999.08-2005.09	Coupe Engine 2ZZ-GE With ABS		◦	GHA400095	
	1999.08-2005.09	Coupe Engine 2ZZ-GE Without ABS		◦	GHA400077	
	1999.08-2005.09	Coupe Engine 2ZZ-GE Without ABS		◦	GHA400077	
1.8 16V VT-i (105 kW)	1999.08-2005.07	Coupe Engine 1ZZ-FE	•		GHA426030	K
	1999.08-2005.07	Coupe Engine 1ZZ-FE	•		GWB6831	
	1999.08-2005.07	Coupe Engine 1ZZ-FE With ABS		◦	GHA400095	
	1999.08-2005.07	Coupe Engine 1ZZ-FE Without ABS		◦	GHA400077	



	 YEAR		F	R	G-AP Ref.	KIT
TOYOTA						
CELICA (ZZT23_)						
1.8 16V VT-i (105 kW)	1999.08-2005.07	Coupe Engine 1ZZ-FE Without ABS		o	GHA400077	
CELSIOR (UCF3_)						
4.3 VVTi (208 kW)	2000.09-2006.08	Saloon Engine 3UZ-FE	•		GHA400292	
CHASER (X9_)						
2.5 (132 kW)	1992.10-1996.08	Saloon Engine 1JZ-GE	•		GHA499084	
COROLLA						
-	2009-2016			o	GHA400309	
COROLLA (E10_)						
1.3 12V (53 kW)	1992.07-1997.04	Saloon Engine 2E	•		GHA426021	
	1992.07-1997.04	Saloon Engine 2E	•		GWB3729	
	1992.07-1997.04	Saloon Engine 2E	•		GWB3730	
	1992.07-1997.04	Saloon Engine 2E		o	GHA228006	K
	1992.07-1997.04	Saloon Engine 2E		o	GHA400054	
	1992.07-1997.04	Saloon Engine 2E With ABS		o	GHA400036	K
1.3 XLi (55 kW)	1995.09-1997.04	Saloon Engine 4E-FE	•		GWB3729	
	1995.09-1997.04	Saloon Engine 4E-FE	•		GWB3730	
	1995.09-1997.04	Saloon Engine 4E-FE		o	GHA228006	K
	1995.09-1997.04	Saloon Engine 4E-FE		o	GHA400054	
	1995.09-1997.04	Saloon Engine 4E-FE With ABS		o	GHA400036	K
1.3 XLi 16V (65 kW)	1992.07-1995.09	Saloon Engine 4E-FE	•		GWB3729	
	1992.07-1995.09	Saloon Engine 4E-FE	•		GWB3730	
	1992.07-1995.09	Saloon Engine 4E-FE		o	GHA228006	K
	1992.07-1995.09	Saloon Engine 4E-FE		o	GHA400054	
	1992.07-1995.09	Saloon Engine 4E-FE With ABS		o	GHA400036	K
1.6 (85 kW)	1992.05-1995.07	Saloon Engine 4A-FE	•		GHA426021	
	1992.05-1995.07	Saloon Engine 4A-FE	•		GWB3729	
	1992.05-1995.07	Saloon Engine 4A-FE	•		GWB3730	
	1992.05-1995.07	Saloon Engine 4A-FE		o	GHA228006	K
	1992.05-1995.07	Saloon Engine 4A-FE		o	GHA400054	
	1992.05-1995.07	Saloon Engine 4A-FE With ABS		o	GHA400036	K
1.6 Si (84 kW)	1995.09-1997.04	Saloon Engine 4A-FE	•		GHA426021	
	1995.09-1997.04	Saloon Engine 4A-FE	•		GWB3729	
	1995.09-1997.04	Saloon Engine 4A-FE	•		GWB3730	
	1995.09-1997.04	Saloon Engine 4A-FE		o	GHA228006	K
	1995.09-1997.04	Saloon Engine 4A-FE		o	GHA400054	
	1995.09-1997.04	Saloon Engine 4A-FE		o	GHA400092	
	1995.09-1997.04	Saloon Engine 4A-FE With ABS		o	GHA400036	K
2.0 D (53 kW)	1992.07-1997.04	Saloon Engine 2C	•		GHA426021	
	1992.07-1997.04	Saloon Engine 2C	•		GWB3729	
	1992.07-1997.04	Saloon Engine 2C	•		GWB3730	
	1992.07-1997.04	Saloon Engine 2C		o	GHA228006	K
	1992.07-1997.04	Saloon Engine 2C		o	GHA400054	
	1992.07-1997.04	Saloon Engine 2C With ABS		o	GHA400036	K
COROLLA (E11_)						
1.3 (55 kW)	1997.05-2001.10	Saloon Engine 2E	•		GHA426021	
1.4 (63 kW)	1997.04-2000.02	Saloon Engine 4E-FE	•		GHA426021	
	1997.04-2000.02	Saloon Engine 4E-FE	•		GWB3729	
	1997.04-2000.02	Saloon Engine 4E-FE	•		GWB3730	
	1997.04-2000.02	Saloon Engine 4E-FE	•		GWB3979	
	1997.04-2000.02	Saloon Engine 4E-FE		o	GHA228006	K
	1997.04-2000.02	Saloon Engine 4E-FE		o	GHA400092	
	1997.04-2000.02	Saloon Engine 4E-FE With ABS		o	GHA400036	K
1.4 16V (71 kW)	2000.02-2001.11	Saloon Engine 4ZZ-FE	•		GWB3729	
	2000.02-2001.11	Saloon Engine 4ZZ-FE	•		GWB3730	
	2000.02-2001.11	Saloon Engine 4ZZ-FE	•		GWB3979	
	2000.02-2001.11	Saloon Engine 4ZZ-FE		o	GHA228006	K
	2000.02-2001.11	Saloon Engine 4ZZ-FE		o	GHA400092	
	2000.02-2001.11	Saloon Engine 4ZZ-FE With ABS		o	GHA400036	K
1.6 16V (81 kW)	2000.02-2001.11	Saloon Engine 3ZZ-FE	•		GWB3729	
	2000.02-2001.11	Saloon Engine 3ZZ-FE	•		GWB3730	
	2000.02-2001.11	Saloon Engine 3ZZ-FE	•		GWB3979	
	2000.02-2001.11	Saloon Engine 3ZZ-FE		o	GHA228006	K
	2000.02-2001.11	Saloon Engine 3ZZ-FE		o	GHA400092	



	 YEAR		F	R	G-AP Ref.	KIT
TOYOTA						
COROLLA (_E11_)						
1.6 16V (81 kW)	2000.02-2001.11	Saloon Engine 3ZZ-FE With ABS		o	GHA400036	K
1.6 Aut. (79 kW)	1997.04-2000.02	Saloon Engine 4A-FE	•		GHA426021	
	1997.04-2000.02	Saloon Engine 4A-FE	•		GWB3729	
	1997.04-2000.02	Saloon Engine 4A-FE	•		GWB3730	
	1997.04-2000.02	Saloon Engine 4A-FE	•		GWB3959	
	1997.04-2000.02	Saloon Engine 4A-FE	•		GWB3979	
	1997.04-2000.02	Saloon Engine 4A-FE		o	GHA228006	K
	1997.04-2000.02	Saloon Engine 4A-FE		o	GHA400092	
	1997.04-2000.02	Saloon Engine 4A-FE With ABS		o	GHA400036	K
1.8 (85 kW)	1998.08-2002.06	Saloon Engine 7A-FE	•		GHA426021	
1.9 D (51 kW)	2000.02-2001.11	Saloon Engine 1WZ	•		GWB3729	
	2000.02-2001.11	Saloon Engine 1WZ	•		GWB3730	
	2000.02-2001.11	Saloon Engine 1WZ	•		GWB3979	
	2000.02-2001.11	Saloon Engine 1WZ		o	GHA228006	K
	2000.02-2001.11	Saloon Engine 1WZ With ABS		o	GHA400036	K
2.0 D (53 kW)	1997.04-2000.02	Saloon Engine 2C-E	•		GHA426021	
	1997.04-2000.02	Saloon Engine 2C-E	•		GWB3729	
	1997.04-2000.02	Saloon Engine 2C-E	•		GWB3730	
	1997.04-2000.02	Saloon Engine 2C-E	•		GWB3959	
	1997.04-2000.02	Saloon Engine 2C-E		o	GHA228006	K
	1997.04-2000.02	Saloon Engine 2C-E		o	GHA400092	
	1997.04-2000.02	Saloon Engine 2C-E With ABS		o	GHA400036	K
2.0 D-4D (66 kW)	2000.09-2001.11	Saloon Engine 1CD-FTV	•		GHA426021	
	2000.09-2001.11	Saloon Engine 1CD-FTV	•		GWB3729	
	2000.09-2001.11	Saloon Engine 1CD-FTV	•		GWB3730	
	2000.09-2001.11	Saloon Engine 1CD-FTV		o	GHA228006	K
	2000.09-2001.11	Saloon Engine 1CD-FTV		o	GHA400092	
COROLLA (_E12J_, _E12T_)						
1.4 D4-D (66 kW)	2004.07-2007.02	Estate Engine 1ND-TV	•		GWB6831	
	2004.07-2007.02	Estate Engine 1ND-TV		o	GHA400010	
	2004.07-2007.02	Estate Engine 1ND-TV With ABS		o	GHA400062	
1.4 D-4D (66 kW)	2004.07-2007.07	Saloon Engine 1ND-TV	•		GWB6831	
	2004.07-2007.07	Saloon Engine 1ND-TV		o	GHA400010	
	2004.07-2007.07	Saloon Engine 1ND-TV With ABS		o	GHA400062	
1.4 VVT-i (71 kW)	2002.01-2007.02	Estate Engine 4ZZ-FE	•		GWB6831	
	2002.01-2007.02	Estate Engine 4ZZ-FE		o	GHA400010	
	2002.01-2007.02	Estate Engine 4ZZ-FE With ABS		o	GHA400062	
	2002.08-2007.07	Saloon Engine 4ZZ-FE	•		GWB6831	
	2002.08-2007.07	Saloon Engine 4ZZ-FE		o	GHA400010	
	2002.08-2007.07	Saloon Engine 4ZZ-FE With ABS		o	GHA400062	
1.6 VVT-i (81 kW)	2002.01-2007.02	Estate Engine 3ZZ-FE	•		GWB6831	
	2002.01-2007.02	Estate Engine 3ZZ-FE		o	GHA400010	
	2002.01-2007.02	Estate Engine 3ZZ-FE With ABS		o	GHA400062	
	2002.01-2007.02	Estate Engine 3ZZ-FE Without ABS		o	GHA400059	
	2002.08-2007.07	Saloon Engine 3ZZ-FE	•		GWB6831	
	2002.08-2007.07	Saloon Engine 3ZZ-FE		o	GHA400010	
	2002.08-2007.07	Saloon Engine 3ZZ-FE With ABS		o	GHA400062	
	2002.08-2007.07	Saloon Engine 3ZZ-FE Without ABS		o	GHA400059	
2.0 D-4D (66 kW)	2002.01-2007.02	Estate Engine 1CD-FTV	•		GWB6831	
	2002.01-2007.02	Estate Engine 1CD-FTV		o	GHA400010	
	2002.01-2007.02	Estate Engine 1CD-FTV With ABS		o	GHA400062	
	2002.09-2004.06	Saloon Engine 1CD-FTV	•		GWB6831	
	2002.09-2004.06	Saloon Engine 1CD-FTV With ABS		o	GHA400062	
2.0 D-4D (85 kW)	2004.06-2007.07	Saloon Engine 1CD-FTV	•		GWB6831	
	2004.06-2007.07	Saloon Engine 1CD-FTV		o	GHA400010	
	2004.06-2007.07	Saloon Engine 1CD-FTV With ABS		o	GHA400062	
	2004.06-2007.08	Estate Engine 1CD-FTV	•		GWB6831	
	2004.06-2007.08	Estate Engine 1CD-FTV		o	GHA400010	
	2004.06-2007.08	Estate Engine 1CD-FTV With ABS		o	GHA400062	
COROLLA (E15_)						
1.33 (74 kW)	2007.01-	Saloon Engine 1NR-FE		o	GHA400079	
	2007.01-	Saloon Engine 1NR-FE		o	GHA400090	
	2007.01-	Saloon Engine 1NR-FE Inner Spline 26T	•		GHA326024	K
1.4 D-4D (66 kW)	2007.01-	Saloon Engine 1ND-TV		o	GHA400079	



	 YEAR		F	R	G-AP Ref.	KIT
TOYOTA						
COROLLA (E15_)						
1.4 D-4D (66 kW)	2007.01-	Saloon Engine 1ND-TV Inner Spline 26T	•		GHA326024	K
1.4 VVT-i (71 kW)	2007.01-	Saloon Engine 4ZZ-FE		◦	GHA400079	
	2007.01-	Saloon Engine 4ZZ-FE		◦	GHA400090	
	2007.01-	Saloon Engine 4ZZ-FE Inner Spline 26T	•		GHA326024	K
1.6 (97 kW)	2009.01-	Saloon Engine 1NR-FAE/1ZR-FE		◦	GHA400079	
	2009.01-	Saloon Engine 1NR-FAE/1ZR-FE		◦	GHA400090	
	2009.01-	Saloon Engine 1NR-FAE/1ZR-FE Inner Spline 26T	•		GHA326024	K
1.6 Dual VVTi (91 kW)	2007.01-	Saloon Engine 1ZR-FE		◦	GHA400079	
	2007.01-	Saloon Engine 1ZR-FE		◦	GHA400090	
	2007.01-	Saloon Engine 1ZR-FE Inner Spline 26T	•		GHA326024	K
1.6 VVTi (90 kW)	2012.10-	Saloon Engine 1ZR-FE		◦	GHA400079	
	2012.10-	Saloon Engine 1ZR-FE		◦	GHA400090	
	2012.10-	Saloon Engine 1ZR-FE Inner Spline 26T	•		GHA326024	K
2.0 D-4D (93 kW)	2007.01-	Saloon Engine 1AD-FTV		◦	GHA400079	
	2007.01-	Saloon Engine 1AD-FTV Inner Spline 30T	•		GHA330014	K
COROLLA (NRE18_, ZRE17_, ZRE18_, NDE18_)						
1.3 (73 kW)	2013.06-	Saloon Engine 1NR-FE		◦	GHA400079	
	2013.06-	Saloon Engine 1NR-FE Inner Spline 26T	•		GHA326024	K
1.4 D-4D (66 kW)	2013.06-	Saloon Engine 1ND-TV		◦	GHA400079	
	2013.06-	Saloon Engine 1ND-TV Inner Spline 26T	•		GHA326024	K
1.6 (97 kW)	2013.06-	Saloon Engine 1ZR-FAE		◦	GHA400079	
	2013.06-	Saloon Engine 1ZR-FAE		◦	GHA400090	
	2013.06-	Saloon Engine 1ZR-FAE Inner Spline 26T	•		GHA326024	K
1.8 VVTi (103 kW)	2013.06-	Saloon Engine 2ZR-FBE/2ZR-FE		◦	GHA400079	
	2013.06-	Saloon Engine 2ZR-FBE/2ZR-FE		◦	GHA400090	
	2013.06-	Saloon Engine 2ZR-FBE/2ZR-FE Inner Spline 26T	•		GHA326024	K
COROLLA (ZZE12_, NDE12_, ZDE12_)						
1.4 D (66 kW)	2004.06-2007.08	Hatchback Engine 1ND-TV	•		GHA426022	
	2004.06-2007.08	Hatchback Engine 1ND-TV	•		GWB6831	
	2004.06-2007.08	Hatchback Engine 1ND-TV		◦	GHA400010	
	2004.06-2007.08	Hatchback Engine 1ND-TV With ABS		◦	GHA400062	
1.4 VVT-i (71 kW)	2002.01-2006.12	Hatchback Engine 4ZZ-FE	•		GHA426022	
	2002.01-2006.12	Hatchback Engine 4ZZ-FE	•		GWB6831	
	2002.01-2006.12	Hatchback Engine 4ZZ-FE		◦	GHA400010	
	2002.01-2006.12	Hatchback Engine 4ZZ-FE With ABS		◦	GHA400062	
1.6 VVT-i (81 kW)	2002.01-2006.12	Hatchback Engine 3ZZ-FE	•		GHA426022	
	2002.01-2006.12	Hatchback Engine 3ZZ-FE	•		GWB6831	
	2002.01-2006.12	Hatchback Engine 3ZZ-FE		◦	GHA400010	
	2002.01-2006.12	Hatchback Engine 3ZZ-FE With ABS		◦	GHA400062	
	2002.01-2006.12	Hatchback Engine 3ZZ-FE Without ABS		◦	GHA400059	
	2002.01-2006.12	Hatchback Engine 3ZZ-FE		◦	GHA400010	
1.8 4WD (100 kW)	2001.12-2007.02	Hatchback Engine 1ZZ-FE	•		GHA426022	
	2001.12-2007.02	Hatchback Engine 1ZZ-FE	•		GHA426030	K
	2001.12-2007.02	Hatchback Engine 1ZZ-FE		◦	GHA326043	
	2001.12-2007.02	Hatchback Engine 1ZZ-FE		◦	GHA326057	
1.8 VVTi (100 kW)	2004.06-2007.02	Hatchback Engine 1ZZ-FE	•		GHA426022	
1.8 VVTL-i TS (141 kW)	2002.01-2007.02	Hatchback Engine 2ZZ-GE	•		GHA426022	
	2002.01-2007.02	Hatchback Engine 2ZZ-GE	•		GHA426030	K
	2002.01-2007.02	Hatchback Engine 2ZZ-GE	•		GWB6831	
	2002.01-2007.02	Hatchback Engine 2ZZ-GE		◦	GHA400010	
	2002.01-2007.02	Hatchback Engine 2ZZ-GE With ABS		◦	GHA400062	
	2002.01-2007.02	Hatchback Engine 2ZZ-GE		◦	GHA400010	
1.8 VVTL-i TS (160 kW)	2005.10-2006.12	Hatchback Engine 2ZZ-GE	•		GHA426022	
	2005.10-2006.12	Hatchback Engine 2ZZ-GE	•		GWB6831	
	2005.10-2006.12	Hatchback Engine 2ZZ-GE With ABS		◦	GHA400062	
1.8 VVTL-i TS (165 kW)	2005.11-2007.08	Hatchback Engine 2ZZ-GE	•		GHA426022	
	2005.11-2007.08	Hatchback Engine 2ZZ-GE	•		GWB6831	
	2005.11-2007.08	Hatchback Engine 2ZZ-GE With ABS		◦	GHA400062	
2.0 D-4D (66 kW)	2002.01-2006.12	Hatchback Engine 1CD-FTV	•		GWB6831	
	2002.01-2006.12	Hatchback Engine 1CD-FTV		◦	GHA400010	
	2002.01-2006.12	Hatchback Engine 1CD-FTV With ABS		◦	GHA400062	
2.0 D-4D (81 kW)	2002.01-2006.12	Hatchback Engine 1CD-FTV	•		GWB6831	
	2002.01-2006.12	Hatchback Engine 1CD-FTV		◦	GHA400010	
	2002.01-2006.12	Hatchback Engine 1CD-FTV With ABS		◦	GHA400062	
2.0 D-4D (85 kW)	2003.05-2007.02	Hatchback Engine 1CD-FTV	•		GWB6831	
	2003.05-2007.02	Hatchback Engine 1CD-FTV		◦	GHA400010	



	 YEAR		F	R	G-AP Ref.	KIT
TOYOTA						
COROLLA (ZZE12_, NDE12_, ZDE12_)						
2.0 D-4D (85 kW)	2003.05-2007.02	Hatchback Engine 1CD-FTV With ABS		o	GHA400062	
COROLLA COMPACT (_E10_)						
1.3 12V (53 kW)	1992.07-1995.05	Hatchback Engine 2E	•		GHA426021	
	1992.07-1995.05	Hatchback Engine 2E	•		GWB3729	
	1992.07-1995.05	Hatchback Engine 2E	•		GWB3730	
	1992.07-1995.05	Hatchback Engine 2E		o	GHA228006	K
	1992.07-1995.05	Hatchback Engine 2E		o	GHA400054	
	1992.07-1995.05	Hatchback Engine 2E With ABS		o	GHA400036	K
1.3 XLi (55 kW)	1995.09-1997.04	Hatchback Engine 4E-FE	•		GWB3729	
	1995.09-1997.04	Hatchback Engine 4E-FE	•		GWB3730	
	1995.09-1997.04	Hatchback Engine 4E-FE		o	GHA228006	K
	1995.09-1997.04	Hatchback Engine 4E-FE		o	GHA400054	
	1995.09-1997.04	Hatchback Engine 4E-FE With ABS		o	GHA400036	K
1.3 XLi 16V (65 kW)	1992.07-1995.09	Hatchback Engine 4E-FE	•		GWB3729	
	1992.07-1995.09	Hatchback Engine 4E-FE	•		GWB3730	
	1992.07-1995.09	Hatchback Engine 4E-FE		o	GHA228006	K
	1992.07-1995.09	Hatchback Engine 4E-FE		o	GHA400054	
	1992.07-1995.09	Hatchback Engine 4E-FE With ABS		o	GHA400036	K
1.6 Si (84 kW)	1992.07-1997.04	Hatchback Engine 4A-FE	•		GHA426021	
	1992.07-1997.04	Hatchback Engine 4A-FE	•		GWB3729	
	1992.07-1997.04	Hatchback Engine 4A-FE	•		GWB3730	
	1992.07-1997.04	Hatchback Engine 4A-FE		o	GHA228006	K
	1992.07-1997.04	Hatchback Engine 4A-FE		o	GHA400054	
	1992.07-1997.04	Hatchback Engine 4A-FE		o	GHA400092	
	1992.07-1997.04	Hatchback Engine 4A-FE With ABS		o	GHA400036	K
1.8 GT (86 kW)	1992.11-1995.05	Hatchback Engine 7A-FE	•		GHA426021	
	1992.11-1995.05	Hatchback Engine 7A-FE	•		GWB3729	
	1992.11-1995.05	Hatchback Engine 7A-FE	•		GWB3730	
	1992.11-1995.05	Hatchback Engine 7A-FE		o	GHA228006	K
	1992.11-1995.05	Hatchback Engine 7A-FE		o	GHA400054	
	1992.11-1995.05	Hatchback Engine 7A-FE With ABS		o	GHA400036	K
1.8 GTi 4WD (92 kW)	1992.05-1995.07	Hatchback Engine 7A-FE	•		GHA426021	
2.0 D (53 kW)	1992.07-1997.04	Hatchback Engine 2C	•		GHA426021	
	1992.07-1997.04	Hatchback Engine 2C	•		GWB3729	
	1992.07-1997.04	Hatchback Engine 2C	•		GWB3730	
	1992.07-1997.04	Hatchback Engine 2C		o	GHA228006	K
	1992.07-1997.04	Hatchback Engine 2C		o	GHA400054	
	1992.07-1997.04	Hatchback Engine 2C With ABS		o	GHA400036	K
COROLLA COMPACT (_E11_)						
1.4 (63 kW)	1997.04-2000.02	Hatchback Engine 4E-FE	•		GHA426021	
	1997.04-2000.02	Hatchback Engine 4E-FE	•		GWB3729	
	1997.04-2000.02	Hatchback Engine 4E-FE	•		GWB3730	
	1997.04-2000.02	Hatchback Engine 4E-FE	•		GWB3979	
	1997.04-2000.02	Hatchback Engine 4E-FE		o	GHA228006	K
	1997.04-2000.02	Hatchback Engine 4E-FE		o	GHA400092	
	1997.04-2000.02	Hatchback Engine 4E-FE With ABS		o	GHA400036	K
1.4 (71 kW)	2000.02-2002.01	Hatchback Engine 4ZZ-FE	•		GWB3729	
	2000.02-2002.01	Hatchback Engine 4ZZ-FE	•		GWB3730	
	2000.02-2002.01	Hatchback Engine 4ZZ-FE	•		GWB3979	
	2000.02-2002.01	Hatchback Engine 4ZZ-FE		o	GHA228006	K
	2000.02-2002.01	Hatchback Engine 4ZZ-FE		o	GHA400092	
	2000.02-2002.01	Hatchback Engine 4ZZ-FE With ABS		o	GHA400036	K
1.6 (81 kW)	1997.04-2000.02	Hatchback Engine 4A-FE	•		GHA426021	
	1997.04-2000.02	Hatchback Engine 4A-FE	•		GWB3729	
	1997.04-2000.02	Hatchback Engine 4A-FE	•		GWB3730	
	1997.04-2000.02	Hatchback Engine 4A-FE	•		GWB3959	
	1997.04-2000.02	Hatchback Engine 4A-FE	•		GWB3979	
	1997.04-2000.02	Hatchback Engine 4A-FE		o	GHA228006	K
	1997.04-2000.02	Hatchback Engine 4A-FE		o	GHA400092	
	1997.04-2000.02	Hatchback Engine 4A-FE With ABS		o	GHA400036	K
	2000.02-2002.01	Hatchback Engine 3ZZ-FE	•		GWB3729	
	2000.02-2002.01	Hatchback Engine 3ZZ-FE	•		GWB3730	
	2000.02-2002.01	Hatchback Engine 3ZZ-FE	•		GWB3979	
	2000.02-2002.01	Hatchback Engine 3ZZ-FE		o	GHA228006	K



	 YEAR		F	R	G-AP Ref.	KIT
TOYOTA						
COROLLA COMPACT (_E11_)						
1.6 (81 kW)	2000.02-2002.01	Hatchback Engine 3ZZ-FE		o	GHA400092	
	2000.02-2002.01	Hatchback Engine 3ZZ-FE With ABS		o	GHA400036	K
1.6 Aut. (79 kW)	1997.04-2000.02	Hatchback Engine 4A-FE	•		GHA426021	
	1997.04-2000.02	Hatchback Engine 4A-FE	•		GWB3729	
	1997.04-2000.02	Hatchback Engine 4A-FE	•		GWB3730	
	1997.04-2000.02	Hatchback Engine 4A-FE	•		GWB3979	
	1997.04-2000.02	Hatchback Engine 4A-FE		o	GHA228006	K
	1997.04-2000.02	Hatchback Engine 4A-FE		o	GHA400092	
	1997.04-2000.02	Hatchback Engine 4A-FE With ABS		o	GHA400036	K
1.9 D (51 kW)	2000.02-2002.01	Hatchback Engine 1WZ	•		GWB3729	
	2000.02-2002.01	Hatchback Engine 1WZ	•		GWB3730	
	2000.02-2002.01	Hatchback Engine 1WZ	•		GWB3979	
	2000.02-2002.01	Hatchback Engine 1WZ		o	GHA228006	K
	2000.02-2002.01	Hatchback Engine 1WZ With ABS		o	GHA400036	K
2.0 D (53 kW)	1997.04-2000.02	Hatchback Engine 2C-E	•		GHA426021	
	1997.04-2000.02	Hatchback Engine 2C-E	•		GWB3729	
	1997.04-2000.02	Hatchback Engine 2C-E	•		GWB3730	
	1997.04-2000.02	Hatchback Engine 2C-E	•		GWB3959	
	1997.04-2000.02	Hatchback Engine 2C-E		o	GHA228006	K
	1997.04-2000.02	Hatchback Engine 2C-E		o	GHA400092	
	1997.04-2000.02	Hatchback Engine 2C-E With ABS		o	GHA400036	K
2.0 D-4D (66 kW)	2000.09-2002.01	Hatchback Engine 1CD-FTV	•		GHA426021	
	2000.09-2002.01	Hatchback Engine 1CD-FTV	•		GWB3729	
	2000.09-2002.01	Hatchback Engine 1CD-FTV	•		GWB3730	
	2000.09-2002.01	Hatchback Engine 1CD-FTV		o	GHA228006	K
	2000.09-2002.01	Hatchback Engine 1CD-FTV		o	GHA400092	
COROLLA LEVIN (AE10_)						
1.6 GT (85 kW)	1991.06-1997.08	Coupe Engine 4A-FE	•		GHA426021	
COROLLA LIFTBACK (_E10_)						
1.3 12V (53 kW)	1992.07-1995.05	Hatchback Engine 2E	•		GWB3729	
	1992.07-1995.05	Hatchback Engine 2E	•		GWB3730	
	1992.07-1995.05	Hatchback Engine 2E		o	GHA228006	K
	1992.07-1995.05	Hatchback Engine 2E		o	GHA400054	
	1992.07-1995.05	Hatchback Engine 2E With ABS		o	GHA400036	K
1.3 XLi (65 kW)	1992.07-1997.04	Hatchback Engine 4E-FE	•		GWB3729	
	1992.07-1997.04	Hatchback Engine 4E-FE	•		GWB3730	
	1992.07-1997.04	Hatchback Engine 4E-FE		o	GHA228006	K
	1992.07-1997.04	Hatchback Engine 4E-FE		o	GHA400054	
	1992.07-1997.04	Hatchback Engine 4E-FE With ABS		o	GHA400036	K
1.6 GLi (84 kW)	1992.07-1997.04	Hatchback Engine 4A-FE	•		GHA426021	
	1992.07-1997.04	Hatchback Engine 4A-FE	•		GWB3729	
	1992.07-1997.04	Hatchback Engine 4A-FE	•		GWB3730	
	1992.07-1997.04	Hatchback Engine 4A-FE		o	GHA228006	K
	1992.07-1997.04	Hatchback Engine 4A-FE		o	GHA400054	
	1992.07-1997.04	Hatchback Engine 4A-FE		o	GHA400092	
	1992.07-1997.04	Hatchback Engine 4A-FE With ABS		o	GHA400036	K
1.8 GT (86 kW)	1992.11-1995.05	Hatchback Engine 7A-FE	•		GWB3729	
	1992.11-1995.05	Hatchback Engine 7A-FE	•		GWB3730	
	1992.11-1995.05	Hatchback Engine 7A-FE		o	GHA228006	K
	1992.11-1995.05	Hatchback Engine 7A-FE		o	GHA400054	
	1992.11-1995.05	Hatchback Engine 7A-FE With ABS		o	GHA400036	K
2.0 D (53 kW)	1992.07-1997.04	Hatchback Engine 2C	•		GHA426021	
	1992.07-1997.04	Hatchback Engine 2C	•		GWB3729	
	1992.07-1997.04	Hatchback Engine 2C	•		GWB3730	
	1992.07-1997.04	Hatchback Engine 2C		o	GHA228006	K
	1992.07-1997.04	Hatchback Engine 2C		o	GHA400054	
	1992.07-1997.04	Hatchback Engine 2C With ABS		o	GHA400036	K
COROLLA LIFTBACK (_E11_)						
1.4 (63 kW)	1997.04-2000.02	Hatchback Engine 4E-FE	•		GHA426021	
	1997.04-2000.02	Hatchback Engine 4E-FE	•		GWB3729	
	1997.04-2000.02	Hatchback Engine 4E-FE	•		GWB3730	
	1997.04-2000.02	Hatchback Engine 4E-FE	•		GWB3979	
	1997.04-2000.02	Hatchback Engine 4E-FE		o	GHA228006	K
	1997.04-2000.02	Hatchback Engine 4E-FE		o	GHA400092	



	 YEAR		F	R	G-AP Ref.	KIT
TOYOTA						
COROLLA LIFTBACK (_E11_)						
1.4 (63 kW)	1997.04-2000.02	Hatchback Engine 4E-FE With ABS		o	GHA400036	K
1.4 (71 kW)	2000.02-2002.01	Hatchback Engine 4Z-FE	•		GWB3729	
	2000.02-2002.01	Hatchback Engine 4Z-FE	•		GWB3730	
	2000.02-2002.01	Hatchback Engine 4Z-FE	•		GWB3979	
	2000.02-2002.01	Hatchback Engine 4Z-FE		o	GHA228006	K
	2000.02-2002.01	Hatchback Engine 4Z-FE		o	GHA400092	
	2000.02-2002.01	Hatchback Engine 4Z-FE With ABS		o	GHA400036	K
1.6 (81 kW)	1997.04-2000.02	Hatchback Engine 4A-FE	•		GHA426021	
	1997.04-2000.02	Hatchback Engine 4A-FE	•		GWB3729	
	1997.04-2000.02	Hatchback Engine 4A-FE	•		GWB3730	
	1997.04-2000.02	Hatchback Engine 4A-FE	•		GWB3959	
	1997.04-2000.02	Hatchback Engine 4A-FE	•		GWB3979	
	1997.04-2000.02	Hatchback Engine 4A-FE		o	GHA228006	K
	1997.04-2000.02	Hatchback Engine 4A-FE		o	GHA400092	
	1997.04-2000.02	Hatchback Engine 4A-FE With ABS		o	GHA400036	K
	2000.02-2002.01	Hatchback Engine 3Z-FE	•		GWB3729	
	2000.02-2002.01	Hatchback Engine 3Z-FE	•		GWB3730	
	2000.02-2002.01	Hatchback Engine 3Z-FE	•		GWB3979	
	2000.02-2002.01	Hatchback Engine 3Z-FE		o	GHA228006	K
	2000.02-2002.01	Hatchback Engine 3Z-FE		o	GHA400092	
	2000.02-2002.01	Hatchback Engine 3Z-FE With ABS		o	GHA400036	K
1.6 Aut. (79 kW)	1997.04-2000.02	Hatchback Engine 4A-FE	•		GHA426021	
	1997.04-2000.02	Hatchback Engine 4A-FE	•		GWB3729	
	1997.04-2000.02	Hatchback Engine 4A-FE	•		GWB3730	
	1997.04-2000.02	Hatchback Engine 4A-FE	•		GWB3959	
	1997.04-2000.02	Hatchback Engine 4A-FE	•		GWB3979	
	1997.04-2000.02	Hatchback Engine 4A-FE		o	GHA228006	K
	1997.04-2000.02	Hatchback Engine 4A-FE		o	GHA400092	
	1997.04-2000.02	Hatchback Engine 4A-FE With ABS		o	GHA400036	K
1.9 D (51 kW)	2000.02-2002.01	Hatchback Engine 1WZ	•		GWB3729	
	2000.02-2002.01	Hatchback Engine 1WZ	•		GWB3730	
	2000.02-2002.01	Hatchback Engine 1WZ	•		GWB3979	
	2000.02-2002.01	Hatchback Engine 1WZ		o	GHA228006	K
	2000.02-2002.01	Hatchback Engine 1WZ With ABS		o	GHA400036	K
2.0 D (53 kW)	1997.04-2000.02	Hatchback Engine 2C-E	•		GHA426021	
	1997.04-2000.02	Hatchback Engine 2C-E	•		GWB3729	
	1997.04-2000.02	Hatchback Engine 2C-E	•		GWB3730	
	1997.04-2000.02	Hatchback Engine 2C-E	•		GWB3959	
	1997.04-2000.02	Hatchback Engine 2C-E		o	GHA228006	K
	1997.04-2000.02	Hatchback Engine 2C-E		o	GHA400092	
	1997.04-2000.02	Hatchback Engine 2C-E With ABS		o	GHA400036	K
2.0 D-4D (66 kW)	2000.09-2002.01	Hatchback Engine 1CD-FTV	•		GWB3729	
	2000.09-2002.01	Hatchback Engine 1CD-FTV	•		GWB3730	
	2000.09-2002.01	Hatchback Engine 1CD-FTV		o	GHA228006	K
	2000.09-2002.01	Hatchback Engine 1CD-FTV		o	GHA400092	
COROLLA VERSO (ZDE12_, CDE12_)						
1.6 VVT-i (81 kW)	2002.01-2004.05	MPV Engine 3ZZ-FE	•		GWB6831	
	2002.01-2004.05	MPV Engine 3ZZ-FE		o	GHA400010	
	2002.01-2004.05	MPV Engine 3ZZ-FE With ABS		o	GHA400062	
	2002.01-2004.05	MPV Engine 3ZZ-FE Without ABS		o	GHA400059	
	2002.01-2004.05	MPV Engine 3ZZ-FE	•		GWB6831	
1.8 VVT-i (99 kW)	2002.01-2004.05	MPV Engine 1ZZ-FE		o	GHA400010	
	2002.01-2004.05	MPV Engine 1ZZ-FE With ABS		o	GHA400062	
	2002.01-2004.05	MPV Engine 1CD-FTV	•		GHA426022	
2.0 D-4D (66 kW)	2002.01-2004.05	MPV Engine 1CD-FTV	•		GWB6831	
	2002.01-2004.05	MPV Engine 1CD-FTV		o	GHA400010	
	2002.01-2004.05	MPV Engine 1CD-FTV With ABS		o	GHA400062	
	2001.09-2004.05	MPV Engine 1CD-FTV	•		GHA426022	
2.0 D-4D (85 kW)	2001.09-2004.05	MPV Engine 1CD-FTV	•		GWB6831	
	2001.09-2004.05	MPV Engine 1CD-FTV		o	GHA400010	
	2001.09-2004.05	MPV Engine 1CD-FTV With ABS		o	GHA400062	
	2001.09-2004.05	MPV Engine 1CD-FTV	•		GWB6831	
COROLLA VERSO (ZER_, ZZE_, R1_)						
1.6 (81 kW)	2004.05-2007.08	MPV Engine 3ZZ-FE	•		GHA426022	
	2004.05-2007.08	MPV Engine 3ZZ-FE	•		GWB3946	



	 YEAR		F	R	G-AP Ref.	KIT
TOYOTA						
COROLLA VERSO (ZER_, ZZE_, R1_)						
1.6 (81 kW)	2004.05-2007.08	MPV Engine 3ZZ-FE		o	GHA400242	
1.8 (95 kW)	2004.05-2007.08	MPV Engine 1ZZ-FE	•		GHA426022	
	2004.05-2007.08	MPV Engine 1ZZ-FE	•		GHA426030	K
	2004.05-2007.08	MPV Engine 1ZZ-FE	•		GWB3946	
	2004.05-2007.08	MPV Engine 1ZZ-FE		o	GHA400242	
2.0 D-4D (85 kW)	2004.05-2005.11	MPV Engine 1CD-FTV	•		GWB3946	
	2004.05-2005.11	MPV Engine 1CD-FTV		o	GHA400242	
2.2 D-4D (100 kW)	2005.11-2007.08	MPV Engine 2AD-FTV	•		GWB3946	
	2005.11-2007.08	MPV Engine 2AD-FTV		o	GHA400242	
2.2 D-4D (130 kW)	2005.11-2007.08	MPV Engine 2AD-FHV	•		GWB3946	
	2005.11-2007.08	MPV Engine 2AD-FHV		o	GHA400242	
COROLLA WAGON (_E11_)						
1.4 (63 kW)	1997.04-2000.02	Estate Engine 4E-FE	•		GHA426021	
	1997.04-2000.02	Estate Engine 4E-FE	•		GWB3729	
	1997.04-2000.02	Estate Engine 4E-FE	•		GWB3730	
	1997.04-2000.02	Estate Engine 4E-FE	•		GWB3979	
	1997.04-2000.02	Estate Engine 4E-FE		o	GHA228006	K
	1997.04-2000.02	Estate Engine 4E-FE		o	GHA400092	
	1997.04-2000.02	Estate Engine 4E-FE With ABS		o	GHA400036	K
1.4 16V (71 kW)	2000.02-2001.10	Estate Engine 4ZZ-FE	•		GWB3729	
	2000.02-2001.10	Estate Engine 4ZZ-FE	•		GWB3730	
	2000.02-2001.10	Estate Engine 4ZZ-FE	•		GWB3979	
	2000.02-2001.10	Estate Engine 4ZZ-FE		o	GHA228006	K
	2000.02-2001.10	Estate Engine 4ZZ-FE		o	GHA400092	
1.6 (81 kW)	1997.04-2000.02	Estate Engine 4A-FE	•		GHA426021	
	1997.04-2000.02	Estate Engine 4A-FE	•		GWB3729	
	1997.04-2000.02	Estate Engine 4A-FE	•		GWB3730	
	1997.04-2000.02	Estate Engine 4A-FE	•		GWB3959	
	1997.04-2000.02	Estate Engine 4A-FE	•		GWB3979	
	1997.04-2000.02	Estate Engine 4A-FE		o	GHA228006	K
	1997.04-2000.02	Estate Engine 4A-FE		o	GHA400092	
1.6 16V (81 kW)	1997.04-2000.02	Estate Engine 4A-FE With ABS		o	GHA400036	K
	2000.02-2001.10	Estate Engine 3ZZ-FE	•		GWB3729	
	2000.02-2001.10	Estate Engine 3ZZ-FE	•		GWB3730	
	2000.02-2001.10	Estate Engine 3ZZ-FE	•		GWB3979	
	2000.02-2001.10	Estate Engine 3ZZ-FE		o	GHA228006	K
1.6 Aut. (79 kW)	2000.02-2001.10	Estate Engine 3ZZ-FE With ABS		o	GHA400036	K
	1997.04-2000.02	Estate Engine 4A-FE	•		GHA426021	
	1997.04-2000.02	Estate Engine 4A-FE	•		GWB3729	
	1997.04-2000.02	Estate Engine 4A-FE	•		GWB3730	
	1997.04-2000.02	Estate Engine 4A-FE	•		GWB3959	
	1997.04-2000.02	Estate Engine 4A-FE	•		GWB3979	
	1997.04-2000.02	Estate Engine 4A-FE		o	GHA228006	K
	1997.04-2000.02	Estate Engine 4A-FE		o	GHA400092	
1997.04-2000.02	Estate Engine 4A-FE With ABS		o	GHA400036	K	
1.8 (81 kW)	1997.10-2001.1	Estate Engine 7A-FE	•		GHA426021	
1.8 4WD (81 kW)	1997.04-2001.10	Estate Engine 7A-FE	•		GWB3729	
	1997.04-2001.10	Estate Engine 7A-FE	•		GWB3730	
1.9 D (51 kW)	2000.02-2001.10	Estate Engine 1WZ	•		GWB3729	
	2000.02-2001.10	Estate Engine 1WZ	•		GWB3730	
	2000.02-2001.10	Estate Engine 1WZ	•		GWB3979	
	2000.02-2001.10	Estate Engine 1WZ		o	GHA228006	K
	2000.02-2001.10	Estate Engine 1WZ With ABS		o	GHA400036	K
2.0 D (53 kW)	1997.04-2000.02	Estate Engine 2C-E	•		GHA426021	
	1997.04-2000.02	Estate Engine 2C-E	•		GWB3729	
	1997.04-2000.02	Estate Engine 2C-E	•		GWB3730	
	1997.04-2000.02	Estate Engine 2C-E	•		GWB3959	
	1997.04-2000.02	Estate Engine 2C-E		o	GHA228006	K
	1997.04-2000.02	Estate Engine 2C-E		o	GHA400092	
	1997.04-2000.02	Estate Engine 2C-E With ABS		o	GHA400036	K
2.0 D-4D (66 kW)	2000.09-2001.10	Estate Engine 1CD-FTV	•		GHA426021	
	2000.09-2001.10	Estate Engine 1CD-FTV	•		GWB3729	
	2000.09-2001.10	Estate Engine 1CD-FTV	•		GWB3730	



	 YEAR		F	R	G-AP Ref.	KIT
TOYOTA						
COROLLA WAGON (_E11_)						
2.0 D-4D (66 kW)	2000.09-2001.10	Estate Engine 1CD-FTV		o	GHA228006	K
	2000.09-2001.10	Estate Engine 1CD-FTV		o	GHA400092	
2.0 D-4D (85 kW)	1997.04-2001.1	Estate Engine 1CD-FTV	•		GWB3729	
	1997.04-2001.1	Estate Engine 1CD-FTV	•		GWB3730	
	1997.04-2001.1	Estate Engine 1CD-FTV		o	GHA228006	K
COROLLA WAGON (_E10_)						
1.3 12V (53 kW)	1992.07-1995.05	Estate Engine 2E	•		GHA426021	
	1992.07-1995.05	Estate Engine 2E	•		GWB3729	
	1992.07-1995.05	Estate Engine 2E	•		GWB3730	
	1992.07-1995.05	Estate Engine 2E		o	GHA228006	K
	1992.07-1995.05	Estate Engine 2E		o	GHA400054	
	1992.07-1995.05	Estate Engine 2E With ABS		o	GHA400036	K
1.3 XLi (55 kW)	1995.09-1997.04	Estate Engine 4E-FE	•		GWB3729	
	1995.09-1997.04	Estate Engine 4E-FE	•		GWB3730	
	1995.09-1997.04	Estate Engine 4E-FE		o	GHA228006	K
	1995.09-1997.04	Estate Engine 4E-FE		o	GHA400054	
	1995.09-1997.04	Estate Engine 4E-FE		o	GHA400092	
	1995.09-1997.04	Estate Engine 4E-FE With ABS		o	GHA400036	K
1.3 XLi 16V (65 kW)	1992.07-1995.09	Estate Engine 4E-FE	•		GWB3729	
	1992.07-1995.09	Estate Engine 4E-FE	•		GWB3730	
	1992.07-1995.09	Estate Engine 4E-FE		o	GHA228006	K
	1992.07-1995.09	Estate Engine 4E-FE		o	GHA400054	
	1992.07-1995.09	Estate Engine 4E-FE With ABS		o	GHA400036	K
1.6 Si (84 kW)	1992.07-1997.04	Estate Engine 4A-FE	•		GHA426021	
	1992.07-1997.04	Estate Engine 4A-FE	•		GWB3729	
	1992.07-1997.04	Estate Engine 4A-FE	•		GWB3730	
	1992.07-1997.04	Estate Engine 4A-FE		o	GHA228006	K
	1992.07-1997.04	Estate Engine 4A-FE		o	GHA400054	
	1992.07-1997.04	Estate Engine 4A-FE With ABS		o	GHA400036	K
1.8 (81 kW)	1992.09-1997.04	Estate Engine 7A-FE	•		GHA426021	
1.8 16V 4WD (81 kW)	1995.09-1997.04	Estate Engine 7A-FE	•		GWB3729	
	1995.09-1997.04	Estate Engine 7A-FE	•		GWB3730	
1.8 XL (88 kW)	1992.09-1993.11	Estate Engine 7A-FE	•		GHA426021	
2.0 D (53 kW)	1992.07-1997.04	Estate Engine 2C	•		GHA426021	
	1992.07-1997.04	Estate Engine 2C	•		GWB3729	
	1992.07-1997.04	Estate Engine 2C	•		GWB3730	
	1992.07-1997.04	Estate Engine 2C		o	GHA228006	K
	1992.07-1997.04	Estate Engine 2C		o	GHA400054	
	1992.07-1997.04	Estate Engine 2C With ABS		o	GHA400036	K
CROWN (CRS_ , JZS_ , GRS18_ , UZS_)						
4.3 4WD (206 kW)	2003.09-2008.02	Saloon Engine 3UZ-FE	•		GHA330044	
	2003.09-2008.02	Saloon Engine 3UZ-FE	•		GHA330045	
CROWN Saloon (CRS_ , JZS_ , GRS18_ , UZS_)						
3.0 4WD (188 kW)	2003.09-2008.02		•		GHA330044	
	2003.09-2008.02		•		GHA330045	
CYNOS (EL44_)						
1.5 (74 kW)	1991.04-1995.08	Coupe Engine 5E-FE		o	GWB3217	
CYNOS (EL54)						
1.5 (81 kW)	1995.08-2000.04	Coupe Engine 5E-FE		o	GWB3217	
1.5 (85 kW)	1995.08-1999.07	Coupe Engine 5E-FE		o	GWB3217	
1.5 16V (66 kW)	1995.08-1999.07	Coupe Engine 5E-FE		o	GWB3217	
ECHO						
1.5 VVTi (78 kW)	1999.04-2005.08	Saloon Engine 1NZ-FE	•		GHA424016	K
	1999.04-2005.08	Saloon Engine 1NZ-FE	•		GWB3929	
	1999.04-2005.08	Saloon Engine 1NZ-FE Without ABS		o	GHA400007	
ECHO (NCP13_ , NCP12_)						
	2003.04-2005.08	Hatchback Engine 1NZ-FE	•		GHA424016	K
	2003.04-2005.08	Hatchback Engine 1NZ-FE	•		GWB3929	
	2003.04-2005.08	Hatchback Engine 1NZ-FE Without ABS		o	GHA400007	
ECHO (NCP13_ , NCP12_)						
1.0 VVTi (50 kW)	2003.04-2005.08	Hatchback Engine 1SZ-FE	•		GWB3929	
	2003.04-2005.08	Hatchback Engine 1SZ-FE Without ABS		o	GHA400007	
1.3 VVTi (63 kW)	1999.08-2003.03	Hatchback Engine 2NZ-FE	•		GWB3929	



	 YEAR		F	R	G-AP Ref.	KIT
TOYOTA						
ECHO (NCP13_, NCP12_)						
1.3 VVTi (63 kW)	1999.08-2003.03	Hatchback Engine 2NZ-FE Without ABS		o	GHA400007	
FJ CRUISER (GSJ1_)						
4.0 i V6 (200 kW)	2010.12-	Closed Off-Road Vehicle Engine 1GR-FE	•		GHA430008	
4.0 i V6 (203 kW)	2011.01-	Closed Off-Road Vehicle Engine 1GR-FE	•		GHA430008	
4.0 i V6 4WD (193 kW)	2010.12-	Closed Off-Road Vehicle Engine 1GR-FE	•		GHA430008	
4.0 VVTi 4WD (178 kW)	2006.01-2011.12	Closed Off-Road Vehicle Engine 1GR-FE	•		GHA430008	
FORTUNER (TGN6_, KUN6_, GGN6_, TGN5_)						
2.5 D-4D 4WD (106 kW)	2009.01-	Closed Off-Road Vehicle Engine 2KD-FTV Without ABS	•		GHA254002	K
2.7 VVT-i 4WD (118 kW)	2004.06-	Closed Off-Road Vehicle Engine 2TR-FE Without ABS	•		GHA254002	K
3.0 D 4WD (125 kW)	2009.08-	Closed Off-Road Vehicle Engine 1KD-FTV Without ABS	•		GHA254002	K
4.0 VVT-i 4WD (175 kW)	2010.01-	Closed Off-Road Vehicle Engine 1GR-FE Without ABS	•		GHA254002	K
FORTUNER (TGN6_, KUN6_, GGN6_, TGN5_, LAN5_, KUN5_, GGN5_)						
2.5 D-4D 4WD (75 kW)	2009.01-2015.05	Closed Off-Road Vehicle Engine 2KD-FTV Without ABS	•		GHA254002	K
3.0 D 4WD (120 kW)	2004.06-2015.05	Closed Off-Road Vehicle Engine 1KD-FTV Without ABS	•		GHA254002	K
GAIA (CXM1_, SXM1_, ACM1_)						
2.0 VVTi (112 kW)	1998.05-2003.1	MPV Engine 1AZ-FSE		o	GHA400184	
2.2 TD (69 kW)	1998.10-2003.1	MPV Engine 3C-TE		o	GHA400184	
HARRIER (MCU3_, MHU3_, ACU3_, GSU3_)						
2.4 VVTi (118 kW)	2003.10-	MPV Engine 2AZ-FE	•		GHA426026	
3.0 VVTi 4WD (150 kW)	2003.10-2008.12	MPV Engine 1MZ-FE	•		GHA426026	
3.3 Hybrid (155 kW)	2005.04-2008.12	MPV Engine 3MZ-FE	•		GHA430005	K
3.3 VVTi 4WD (171 kW)	2003.10-2008.12	MPV Engine 3MZ-FE	•		GHA430005	K
3.5 VVTi 4WD (206 kW)	2005.04-2008.12	MPV Engine 2GR-FE	•		GHA430005	K
HARRIER (SXU1_, MCU1_, ACU1_)						
2.2 4WD (103 kW)	1998.03-2003.01	MPV Engine 5S-FE		o	GHA426052	
2.4 4WD (118 kW)	2000.06-2003.01	MPV Engine 2AZ-FE		o	GHA426052	
3.0 4WD (164 kW)	1998.03-2003.01	MPV Engine 1MZ-FE		o	GHA426052	
HIACE / COMMUTER IV (TRH2_, KDH2_)						
2.5 D-4D (75 kW)	2006.9-	Bus Engine 2KD-FTV	•		GHA254001	K
HIACE / COMMUTER V (TRH2_, KDH2_)						
2.7 VVTi (111 kW)	2005.01-	Bus Engine 2TR-FE	•		GHA254001	K
	2005.01-	Bus Engine 2TR-FE	•		GHA254901	
3.0 D (100 kW)	2005.01-	Bus Engine 1KD-FTV	•		GHA254001	K
	2005.01-	Bus Engine 1KD-FTV	•		GHA254901	
HIACE III (YH7_, LH6_, LH7_, LH5_, YH5_, YH6_)						
2.0 (74 kW)	1990.02-1995.08	Box Engine 1RZ	•		GWB0826	
	1990.02-1995.08	Box Engine 1RZ		o	GWB3740	
2.4 D (55 kW)	1990.02-1995.08	Box Engine 2L	•		GWB0826	
	1990.02-1995.08	Box Engine 2L		o	GWB3740	
3.0 D (65 kW)	1998.08-2004.08	Box Engine 5L	•		GWB0826	
	1998.08-2004.08	Box Engine 5L	•		GWB1951	
	1998.08-2004.08	Box Engine 5L		o	GWB3740	
	1998.08-2004.08	Box Engine 5L		o	GWB6901	
HIACE III WAGON (LH1_, RZH1_)						
2.4 (85 kW)	1996.11-2004.08	Bus Engine 2RZ-E	•		GWB0826	
	1996.11-2004.08	Bus Engine 2RZ-E		o	GWB3740	
3.0 D (65 kW)	1998.08-2004.08	Bus Engine 5L	•		GWB0826	
	1998.08-2004.08	Bus Engine 5L	•		GWB1951	
	1998.08-2004.08	Bus Engine 5L		o	GWB3740	
	1998.08-2004.08	Bus Engine 5L		o	GWB6901	
HIACE IV (LH1_)						
2.4 (85 kW)	1995.08-1998.04	Bus Engine 2RZ-E	•		GWB0826	
	1995.08-1998.04	Bus Engine 2RZ-E		o	GWB3985	
	1995.08-2005.02	Box Engine 2RZ-E	•		GWB0826	
	1995.08-2005.02	Box Engine 2RZ-E		o	GWB3985	
2.4 4WD (85 kW)	1995.08-1998.04	Box Engine 2RZ-E	•		GWB1951	
	1995.08-1998.04	Box Engine 2RZ-E		o	GWB3985	
	1995.08-1998.04	Bus Engine 2RZ-E	•		GWB1951	
	1995.08-1998.04	Bus Engine 2RZ-E		o	GWB3985	
2.4 D (55 kW)	1999.07-2006.08	Bus Engine 2L	•		GWB0826	
	1999.07-2006.08	Bus Engine 2L		o	GWB3985	
2.4 D (58 kW)	1995.08-2006.08	Box Engine 2L	•		GWB0826	



	 YEAR		F	R	G-AP Ref.	KIT
TOYOTA						
HIACE IV (LH1_)						
2.4 D (58 kW)	1995.08-2006.08	Box Engine 2L		o	GWB3985	
	1995.08-2006.08	Bus Engine 2L	•		GWB0826	
	1995.08-2006.08	Bus Engine 2L		o	GWB3985	
2.4 D (61 kW)	1995.8-2006.8	Bus Engine 2L	•		GWB0826	
	1995.8-2006.8	Bus Engine 2L		o	GWB3985	
2.4 TD (66 kW)	1995.08-2006.08	Box Engine 2L-T	•		GWB0826	
	1995.08-2006.08	Box Engine 2L-T		o	GWB3985	
	1995.08-2006.08	Bus Engine 2L-T	•		GWB0826	
	1995.08-2006.08	Bus Engine 2L-T		o	GWB3985	
2.4 TD 4WD (66 kW)	1995.08-2006.08	Box Engine 2L-T	•		GWB1951	
	1995.08-2006.08	Box Engine 2L-T		o	GWB3985	
	1995.08-2006.08	Bus Engine 2L-T	•		GWB1951	
	1995.08-2006.08	Bus Engine 2L-T		o	GWB3985	
2.5 D-4D (65 kW)	2001.11-2006.08	Box Engine 2KD-FTV	•		GWB0826	
	2001.11-2006.08	Box Engine 2KD-FTV		o	GWB3985	
	2001.11-2006.08	Bus Engine 2KD-FTV	•		GWB0826	
	2001.11-2006.08	Bus Engine 2KD-FTV		o	GWB3985	
2.5 D-4D (70 kW)	2006.08-	Bus Engine 2KD-FTV	•		GWB0826	
	2006.08-	Bus Engine 2KD-FTV		o	GWB3985	
	2006.09-	Box Engine 2KD-FTV	•		GHA254901	
	2006.09-	Box Engine 2KD-FTV	•		GWB0826	
	2006.09-	Box Engine 2KD-FTV		o	GWB3985	
2.5 D-4D (75 kW)	2001.11-2006.08	Box Engine 2KD-FTV	•		GWB0826	
	2001.11-2006.08	Box Engine 2KD-FTV		o	GWB3985	
	2001.11-2006.08	Bus Engine 2KD-FTV	•		GHA254901	
	2001.11-2006.08	Bus Engine 2KD-FTV	•		GWB0826	
	2001.11-2006.08	Bus Engine 2KD-FTV		o	GWB3985	
2.5 D-4D (86 kW)	2006.08-	Bus Engine 2KD-FTV	•		GWB0826	
	2006.08-	Bus Engine 2KD-FTV		o	GWB3985	
	2006.09-	Box Engine 2KD-FTV	•		GHA254901	
	2006.09-	Box Engine 2KD-FTV	•		GWB0826	
	2006.09-	Box Engine 2KD-FTV		o	GWB3985	
2.5 D-4D 4WD (75 kW)	2001.11-2006.08	Box Engine 2KD-FTV	•		GWB1951	
	2001.11-2006.08	Box Engine 2KD-FTV		o	GWB3985	
	2001.11-2006.08	Bus Engine 2KD-FTV	•		GWB1951	
	2001.11-2006.08	Bus Engine 2KD-FTV		o	GWB3985	
2.5 D-4D 4WD (86 kW)	2006.09-	Box Engine 2KD-FTV	•		GWB1951	
	2006.09-	Box Engine 2KD-FTV		o	GWB3985	
	2006.10-	Bus Engine 2KD-FTV	•		GWB1951	
	2006.10-	Bus Engine 2KD-FTV		o	GWB3985	
2.7 (105 kW)	1998.04-2001.11	Bus Engine 3RZ-FE	•		GWB0826	
	1998.04-2001.11	Bus Engine 3RZ-FE		o	GWB3985	
	1998.04-2006.08	Box Engine 3RZ-FE	•		GWB0826	
	1998.04-2006.08	Box Engine 3RZ-FE		o	GWB3985	
2.7 (106 kW)	2001.11-2006.08	Bus Engine 3RZ-FE	•		GWB0826	
	2001.11-2006.08	Bus Engine 3RZ-FE		o	GWB3985	
2.7 4WD (105 kW)	1998.04-2006.08	Bus Engine 3RZ-FE	•		GWB1951	
	1998.04-2006.08	Bus Engine 3RZ-FE		o	GWB3985	
2.7 4WD (106 kW)	1998.04-	Box Engine 3RZ-FE	•		GWB1951	
	1998.04-	Box Engine 3RZ-FE		o	GWB3985	
	2001.11-	Bus Engine 3RZ-FE	•		GWB1951	
	2001.11-	Bus Engine 3RZ-FE		o	GWB3985	
HIACE IV (LXH1_, RCH1_, KLH1_)						
2.4 D (55 kW)	1999.07-2006.08	Platform/Chassis Engine 2L	•		GWB0826	
	1999.07-2006.08	Platform/Chassis Engine 2L		o	GWB3985	
2.4 D (61 kW)	1995.08-2006.08	Platform/Chassis Engine 2L	•		GWB0826	
	1995.08-2006.08	Platform/Chassis Engine 2L		o	GWB3985	
HIACE IV (LXH1_, RZH1_, LH1_)						
2.4 D (55 kW)	1995.9-2001.8	Box Engine 2L	•		GWB0826	
	1995.9-2001.8	Box Engine 2L		o	GWB3985	
2.4 D (61 kW)	1995.8-2006.8	Box Engine 2L	•		GWB0826	
	1995.8-2006.8	Box Engine 2L		o	GWB3985	
HIACE IV (TRH2_, KDH2_)						
2.5 D-4D (70 kW)	2006.09-	Box Engine 2KD-FTV	•		GHA254001	K



	 YEAR		F	R	G-AP Ref.	KIT
TOYOTA						
HIACE IV (TRH2_, KDH2_)						
2.5 D-4D (86 kW)	2006.09-	Box Engine 2KD-FTV	•		GHA254001	K
HIACE V (TRH2_, KDH2_)						
2.5 D-4D (75 kW)	2006.09-	Box Engine 2KD-FTV	•		GHA254001	K
	2006.09-	Box Engine 2KD-FTV	•		GHA254901	
2.7 VVTi (111 kW)	2005.01-	Box Engine 2TR-FE	•		GHA254001	K
	2005.01-	Box Engine 2TR-FE	•		GHA254901	
3.0 D (75 kW)	2005.01-	Box Engine 1KD-FTV	•		GHA254001	K
	2005.01-	Box Engine 1KD-FTV	•		GHA254901	
HIGHLANDER						
-	2008-2013			○	GHA400236	
	2008-2013			○	GHA400321	
HILUX II (RN6_, RN5_, LN6_, YN6_, YN5_, LN5_)						
2.4 D (55 kW)	1998.07-2002.01	Pickup Engine 2L	•		GWB0826	
	1998.07-2002.01	Pickup Engine 2L		○	GWB3740	
2.4 D (58 kW)	1995.03-2005.07	Pickup Engine 2L	•		GWB0826	
	1995.03-2005.07	Pickup Engine 2L		○	GWB3740	
2.4 D (59 kW)	1992.01-2005.07	Pickup Engine 2L	•		GWB0826	
	1992.01-2005.07	Pickup Engine 2L		○	GWB3740	
2.4 D 4WD (58 kW)	1994.01-2005.07	Pickup Engine 2L	•		GWB0826	
	1994.01-2005.07	Pickup Engine 2L		○	GWB3740	
2.4 i 4WD (103 kW)	1997.08-2005.07	Pickup Engine 2RZ-FE	•		GWB1951	
2.4 TD 4WD (66 kW)	1998.08-2002.01	Pickup Engine 2L-T	•		GWB1951	
2.5 D-4D (65 kW)	2001.11-2005.07	Pickup Engine 2KD-FTV	•		GWB0826	
	2001.11-2005.07	Pickup Engine 2KD-FTV		○	GWB6901	
2.5 D-4D 4WD (75 kW)	2001.11-2005.07	Pickup Engine 2KD-FTV	•		GWB1951	
3.0 D (67 kW)	2002.01-2005.02	Pickup Engine 5L	•		GWB0826	
3.0 D 4WD (67 kW)	2002.01-2005.07	Pickup Engine 5L	•		GWB0826	
HILUX III (KUN_, TGN_, LAN_, GGN_)						
2.0 (98 kW)	2005.02-	Pickup Engine 1TR-FE		○	GWB6901	
2.7 (118 kW)	2005.08-	Pickup Engine 2TR-FE		○	GWB6901	
3.0 D (120 kW)	2005.08-2006.09	Pickup Engine 1KD-FTV		○	GWB6901	
3.0 D (126 kW)	2006.10-	Pickup Engine 1KD-FTV		○	GWB6901	
4.0 (175 kW)	2005.08-	Pickup Engine 1GR-FE		○	GWB6901	
HILUX III (KUN1_, TGN3_, TGN2_, TGN1_, KUN2)						
2.7 (118 kW)	2005.02-	Platform/Chassis Engine 2TR-FE		○	GWB6901	
HILUX III (TGN1_, GGN2_, GGN1_, KUN2_, KUN1_)						
2.5 D 4WD (75 kW)	2005.08-	Pickup Engine 2KD-FTV Without ABS	•		GHA254002	K
2.5 D-4D (75 kW)	2006.06-	Pickup Engine 2KD-FTV		○	GWB6901	
2.5 D-4D (88 kW)	2007.12-	Pickup Engine 2KD-FTV		○	GWB6901	
2.5 D-4D 4WD (106 kW)	2007.12-	Pickup Engine 2KD-FTV Without ABS	•		GHA254002	K
2.5 D-4D 4WD (88 kW)	2007.12-	Pickup Engine 2KD-FTV Without ABS	•		GHA254002	K
2.7 4WD (118 kW)	2005.08-	Pickup Engine 2TR-FE Without ABS	•		GHA254002	K
3.0 D-4D 4WD (126 kW)	2007.12-	Pickup Engine 1KD-FTV Without ABS	•		GHA254002	K
HILUX III PICKUP (TGN1_, GGN2_, GGN1_, KUN2_, KUN1_)						
3.0 4WD (120 kW)	2005.08-	Pickup Engine 1KD-FTV Without ABS	•		GHA254002	K
4.0 4WD (175 kW)	2005.08-	Pickup Engine 1GR-FE Without ABS	•		GHA254002	K
IQ (KPJ1_, KGJ1_, NGJ1_, NUJ1_)						
1.0 (50 kW)	2009.01-	Hatchback Engine 1KR-FE	•		GHA424016	K
1.33 (72 kW)	2009.01-	Hatchback Engine 1NR-FE	•		GHA426024	
	2009.01-	Hatchback Engine 1NR-FE	•		GWB6878	
1.4 D-4D (66 kW)	2009.01-	Hatchback Engine 1ND-TV	•		GHA426024	
	2009.01-	Hatchback Engine 1ND-TV	•		GWB6878	
IQ (KPJ1_, NGJ1_, KGJ1_, NUJ1_)						
EV (47 kW)	2012.09-	Hatchback Engine EM	•		GWB6878	
	2012.09-	Hatchback Engine EM With ABS		○	GHA400087	K
ISIS (ZNM1_, ANM1_, ZGM1_)						
1.8 VVTi (106 kW)	2007.04-	MPV Engine 2ZR-FAE	•		GHA426049	K
1.8 VVTi (97 kW)	2004.07-	MPV Engine 1ZZ-FE	•		GHA426049	K
1.8 VVTi 4WD (98 kW)	2007.04-	MPV Engine 2ZR-FAE	•		GHA426049	K
2.0 VVTi (114 kW)	2004.07-	MPV Engine 1AZ-FSE	•		GHA426049	K
2.0 VVTi (116 kW)	2007.04-	MPV Engine 3ZR-FAE	•		GHA426049	K
2.0 VVTi 4WD (114 kW)	2004.07-	MPV Engine 1AZ-FSE	•		GHA426049	K



	 YEAR		F	R	G-AP Ref.	KIT
TOYOTA						
KIJANG INNOVA (_TGN4_ , _KUN4_)						
2.7 VVTi (118 kW)	2004.08-	MPV Engine 2TR-FE		o	GWB6901	
KLUGER (_MCU2_ , _ACU2_)						
2.4 (115 kW)	2000.06-2007.05	MPV Engine 2AZ-FE	•		GHA426026	
2.4 4WD (115 kW)	2000.06-2003.09	MPV Engine 2AZ-FE	•		GHA426026	
	2000.06-2003.09	MPV Engine 2AZ-FE		o	GHA426052	
3.0 (164 kW)	2000.06-2007.05	MPV Engine 1MZ-FE	•		GHA430005	K
3.0 4WD (164 kW)	2000.06-2007.05	MPV Engine 1MZ-FE	•		GHA426026	
	2000.06-2007.05	MPV Engine 1MZ-FE		o	GHA426052	
3.3 (171 kW)	2003.10-2007.05	MPV Engine 3MZ-FE	•		GHA430005	K
	2003.10-2007.05	MPV Engine 3MZ-FE	•		GWB3946	
	2003.10-2007.05	MPV Engine 3MZ-FE		o	GHA326036	
3.3 4WD (171 kW)	2003.10-2007.05	MPV Engine 3MZ-FE	•		GHA426026	
3.3 Hybrid (200 kW)	2005.03-2007.05	MPV Engine 3MZ-FE	•		GHA430005	K
3.3 Hybrid 4WD (200 kW)	2005.03-2007.05	MPV Engine 3MZ-FE	•		GHA426026	
KLUGER (_MHU4_ , _GSU4_ , _ASU4_)						
2.7 VVTi (140 kW)	2007.05-	MPV Engine 1AR-FE	•		GHA430005	K
3.5 (201 kW)	2007.05-	MPV Engine 2GR-FE	•		GHA430005	K
3.5 4WD (201 kW)	2007.05-	MPV Engine 2GR-FE	•		GHA426026	
	2007.05-	MPV Engine 2GR-FE		o	GHA326036	
LAND CRUISER (KDJ12_ , GRJ12_)						
2.7 (112 kW)	2002.09-2004.08	Closed Off-Road Vehicle Engine 3RZ-FE	•		GHA430008	
3.0 D-4D (120 kW)	2002.12-2005.12	Closed Off-Road Vehicle Engine 1KD-FTV	•		GHA430008	
	2002.12-2005.12	Closed Off-Road Vehicle Engine 1KD-FTV		o	GHA244003	K
	2002.12-2005.12	Closed Off-Road Vehicle Engine 1KD-FTV		o	GHA244006	
	2002.12-2005.12	Closed Off-Road Vehicle Engine 1KD-FTV With ABS	•		GHA254003	K
	2002.12-2005.12	Closed Off-Road Vehicle Engine 1KD-FTV With ABS		o	GHA244004	K
	2002.12-2005.12	Closed Off-Road Vehicle Engine 1KD-FTV Without ABS	•		GHA254002	K
	2002.12-2005.12	Closed Off-Road Vehicle Engine 1KD-FTV Without ABS		o	GHA244005	
3.0 D-4D (122 kW)	2006.01-2007.03	Closed Off-Road Vehicle Engine 1KD-FTV	•		GHA430008	
	2006.01-2007.03	Closed Off-Road Vehicle Engine 1KD-FTV		o	GHA244003	K
	2006.01-2007.03	Closed Off-Road Vehicle Engine 1KD-FTV		o	GHA244006	
	2006.01-2007.03	Closed Off-Road Vehicle Engine 1KD-FTV With ABS	•		GHA254003	K
	2006.01-2007.03	Closed Off-Road Vehicle Engine 1KD-FTV With ABS		o	GHA244004	K
	2006.01-2007.03	Closed Off-Road Vehicle Engine 1KD-FTV Without ABS	•		GHA254002	K
	2006.01-2007.03	Closed Off-Road Vehicle Engine 1KD-FTV Without ABS		o	GHA244005	
3.0 D-4D (127 kW)	2006.11-2008.03	Closed Off-Road Vehicle Engine 1KD-FTV	•		GHA430008	
	2006.11-2008.03	Closed Off-Road Vehicle Engine 1KD-FTV		o	GHA244003	K
	2006.11-2008.03	Closed Off-Road Vehicle Engine 1KD-FTV		o	GHA244006	
	2006.11-2008.03	Closed Off-Road Vehicle Engine 1KD-FTV With ABS	•		GHA254003	K
	2006.11-2008.03	Closed Off-Road Vehicle Engine 1KD-FTV With ABS		o	GHA244004	K
	2006.11-2008.03	Closed Off-Road Vehicle Engine 1KD-FTV Without ABS	•		GHA254002	K
	2006.11-2008.03	Closed Off-Road Vehicle Engine 1KD-FTV Without ABS		o	GHA244005	
3.0 D-4D (92 kW)	2002.09-2010.02	Closed Off-Road Vehicle Engine 1KZ-TE	•		GHA430008	
4.0 (179 kW)	2002.09-2004.08	Closed Off-Road Vehicle Engine 1GR-FE	•		GHA430008	
	2002.09-2004.08	Closed Off-Road Vehicle Engine 1GR-FE		o	GHA244003	K
	2002.09-2004.08	Closed Off-Road Vehicle Engine 1GR-FE		o	GHA244006	
	2002.09-2004.08	Closed Off-Road Vehicle Engine 1GR-FE With ABS	•		GHA254003	K
	2002.09-2004.08	Closed Off-Road Vehicle Engine 1GR-FE With ABS		o	GHA244004	K
	2002.09-2004.08	Closed Off-Road Vehicle Engine 1GR-FE Without ABS	•		GHA254002	K
	2002.09-2004.08	Closed Off-Road Vehicle Engine 1GR-FE Without ABS		o	GHA244005	
4.0 (183 kW)	2003.01-2008.03	Closed Off-Road Vehicle Engine 1GR-FE	•		GHA430008	
	2003.01-2008.03	Closed Off-Road Vehicle Engine 1GR-FE		o	GHA244003	K
	2003.01-2008.03	Closed Off-Road Vehicle Engine 1GR-FE		o	GHA244006	
	2003.01-2008.03	Closed Off-Road Vehicle Engine 1GR-FE With ABS	•		GHA254003	K
	2003.01-2008.03	Closed Off-Road Vehicle Engine 1GR-FE With ABS		o	GHA244004	K
	2003.01-2008.03	Closed Off-Road Vehicle Engine 1GR-FE Without ABS	•		GHA254002	K
	2003.01-2008.03	Closed Off-Road Vehicle Engine 1GR-FE Without ABS		o	GHA244005	
LAND CRUISER (KDJ15_ , GRJ15_)						
3.0 D-4D (127 kW)	2010.03-	Closed Off-Road Vehicle Engine 1KD-FTV	•		GHA430008	
	2010.03-	Closed Off-Road Vehicle Engine 1KD-FTV		o	GHA244003	K
	2010.03-	Closed Off-Road Vehicle Engine 1KD-FTV With ABS	•		GHA254003	K
	2010.03-	Closed Off-Road Vehicle Engine 1KD-FTV With ABS		o	GHA244004	K
3.0 D-4D (140 kW)	2010.01-	Closed Off-Road Vehicle Engine 1KD-FTV	•		GHA430008	
	2010.01-	Closed Off-Road Vehicle Engine 1KD-FTV		o	GHA244003	K



	 YEAR		F	R	G-AP Ref.	KIT
TOYOTA						
LAND CRUISER (KDJ15_, GRJ15_)						
3.0 D-4D (140 kW)	2010.01-	Closed Off-Road Vehicle Engine 1KD-FTV With ABS	•		GHA254003	K
	2010.01-	Closed Off-Road Vehicle Engine 1KD-FTV With ABS		◦	GHA244004	K
4.0 V6 Dual VVT-i (205 kW)	2010.01-	Closed Off-Road Vehicle Engine 1GR-FE	•		GHA430008	
	2010.01-	Closed Off-Road Vehicle Engine 1GR-FE		◦	GHA244003	K
	2010.01-	Closed Off-Road Vehicle Engine 1GR-FE With ABS	•		GHA254003	K
	2010.01-	Closed Off-Road Vehicle Engine 1GR-FE With ABS		◦	GHA244004	K
4.0 V6 VVT-i (183 kW)	2010.01-	Closed Off-Road Vehicle Engine 1GR-FE	•		GHA430008	
	2010.01-	Closed Off-Road Vehicle Engine 1GR-FE		◦	GHA244003	K
	2010.01-	Closed Off-Road Vehicle Engine 1GR-FE With ABS	•		GHA254003	K
	2010.01-	Closed Off-Road Vehicle Engine 1GR-FE With ABS		◦	GHA244004	K
4.0 V6 VVT-i (203 kW)	2010.01-	Closed Off-Road Vehicle Engine 1GR-FE	•		GHA430008	
	2010.01-	Closed Off-Road Vehicle Engine 1GR-FE		◦	GHA244003	K
	2010.01-	Closed Off-Road Vehicle Engine 1GR-FE With ABS	•		GHA254003	K
	2010.01-	Closed Off-Road Vehicle Engine 1GR-FE With ABS		◦	GHA244004	K
4.0 V6 VVT-i (207 kW)	2010.01-	Closed Off-Road Vehicle Engine 1GR-FE	•		GHA430008	
	2010.01-	Closed Off-Road Vehicle Engine 1GR-FE		◦	GHA244003	K
	2010.01-	Closed Off-Road Vehicle Engine 1GR-FE With ABS	•		GHA254003	K
	2010.01-	Closed Off-Road Vehicle Engine 1GR-FE With ABS		◦	GHA244004	K
LAND CRUISER (PZJ7_, KZJ7_, HZJ7_, BJ7_, LJ7_, RJ7_)						
2.4 TD (66 kW)	1990.01-1993.05	Closed Off-Road Vehicle Engine 2L-T	•		GWB3727	
	1990.01-1993.05	Closed Off-Road Vehicle Engine 2L-T		◦	GWB0827	
	1990.01-1993.05	Closed Off-Road Vehicle Engine 2L-T		◦	GWB3765	
3.0 TD (92 kW)	1993.05-1996.05	Closed Off-Road Vehicle Engine 1KZ-T	•		GWB3727	
	1993.05-1996.05	Closed Off-Road Vehicle Engine 1KZ-T		◦	GWB0827	
	1993.05-1996.05	Closed Off-Road Vehicle Engine 1KZ-T		◦	GWB3765	
3.5 D 4x4 (85 kW)	1990.01-1992.08	Closed Off-Road Vehicle Engine 1PZ		◦	GWB1905	
4.2 TD (96 kW)	1990.01-	Closed Off-Road Vehicle Engine 1H-Z	•		GWB3727	
	1990.01-	Closed Off-Road Vehicle Engine 1H-Z		◦	GWB1905	
LAND CRUISER 200 (VDJ2_, UZJ2_)						
4.5 D V8 (VDJ200) (210 kW)	2008.01-	Closed Off-Road Vehicle Engine 1VD-FTV	•		GHA258001	
	2008.01-	Closed Off-Road Vehicle Engine 1VD-FTV	•		GHA436007	
	2008.01-	Closed Off-Road Vehicle Engine 1VD-FTV		◦	GHA249003	
	2008.01-	Closed Off-Road Vehicle Engine 1VD-FTV		◦	GHA249004	
4.5 D-4D (195 kW)	2008.01-	Closed Off-Road Vehicle Engine 1VD-FTV	•		GHA258001	
	2008.01-	Closed Off-Road Vehicle Engine 1VD-FTV	•		GHA436007	
	2008.01-	Closed Off-Road Vehicle Engine 1VD-FTV		◦	GHA249003	
	2008.01-	Closed Off-Road Vehicle Engine 1VD-FTV		◦	GHA249004	
4.6 V8 (234 kW)	2012.01-	Closed Off-Road Vehicle Engine 1UR-FE	•		GHA258001	
	2012.01-	Closed Off-Road Vehicle Engine 1UR-FE	•		GHA436007	
	2012.01-	Closed Off-Road Vehicle Engine 1UR-FE		◦	GHA249003	
	2012.01-	Closed Off-Road Vehicle Engine 1UR-FE		◦	GHA249004	
4.7 V8 (202 kW)	2007.08-	Closed Off-Road Vehicle Engine 2UZ-FE	•		GHA258001	
	2007.08-	Closed Off-Road Vehicle Engine 2UZ-FE	•		GHA436007	
	2007.08-	Closed Off-Road Vehicle Engine 2UZ-FE		◦	GHA249003	
	2007.08-	Closed Off-Road Vehicle Engine 2UZ-FE		◦	GHA249004	
4.7 V8 (212 kW)	2008.01-	Closed Off-Road Vehicle Engine 2UZ-FE	•		GHA258001	
	2008.01-	Closed Off-Road Vehicle Engine 2UZ-FE	•		GHA436007	
	2008.01-	Closed Off-Road Vehicle Engine 2UZ-FE		◦	GHA249003	
	2008.01-	Closed Off-Road Vehicle Engine 2UZ-FE		◦	GHA249004	
LAND CRUISER 80 (_J8_)						
4.0 (115 kW)	1990.01-1992.08	Closed Off-Road Vehicle Engine 3F-E		◦	GWB1905	
4.2 D (99 kW)	1990.01-1997.12	Closed Off-Road Vehicle Engine 1H-Z		◦	GWB1905	
4.2 TD (123 kW)	1990.01-1997.12	Closed Off-Road Vehicle Engine 1HD-T		◦	GWB1905	
LAND CRUISER 90 (_J9_)						
3.0 D-4D (120 kW)	2000.10-	Closed Off-Road Vehicle Engine 1KD-FTV	•		GWB3974	
	2000.10-	Closed Off-Road Vehicle Engine 1KD-FTV		◦	GWB3765	
3.0 TD (92 kW)	1996.04-	Closed Off-Road Vehicle Engine 1KZ-TE	•		GWB3974	
	1996.04-	Closed Off-Road Vehicle Engine 1KZ-TE		◦	GWB3765	
3.4 i 24V (131 kW)	1996.04-	Closed Off-Road Vehicle Engine 5VZ-FE	•		GWB3974	
	1996.04-	Closed Off-Road Vehicle Engine 5VZ-FE		◦	GWB3765	
LAND CRUISER HARDTOP (_J7_)						
2.4 TD (66 kW)	1990.07-1996.05	Open Off-Road Vehicle Engine 2L-T	•		GWB3727	
	1990.07-1996.05	Open Off-Road Vehicle Engine 2L-T		◦	GWB0827	



	 YEAR		F	R	G-AP Ref.	KIT
TOYOTA						
LAND CRUISER HARDTOP (_J7_)						
2.4 TD (66 kW)	1990.07-1996.05	Open Off-Road Vehicle Engine 2L-T		o	GWB3765	
3.0 TD (92 kW)	1993.05-1996.05	Open Off-Road Vehicle Engine 1KZ-T	•		GWB3727	
	1993.05-1996.05	Open Off-Road Vehicle Engine 1KZ-T		o	GWB0827	
	1993.05-1996.05	Open Off-Road Vehicle Engine 1KZ-T		o	GWB3765	
LAND CRUISER PRADO (KDJ15_, GRJ15_)						
2.8 D-4D (130 kW)	2015.06-	Closed Off-Road Vehicle Engine 1GD-FTV		o	GHA244003	K
	2015.06-	Closed Off-Road Vehicle Engine 1GD-FTV With ABS	•		GHA254003	K
	2015.06-	Closed Off-Road Vehicle Engine 1GD-FTV With ABS		o	GHA244004	K
LAND CRUISER PRADO (LJ12_, KZJ12_, TRJ12_, KDJ12_, GRJ12_)						
4.0 (203 kW)	2005.08-2009.07	Closed Off-Road Vehicle Engine 1GR-FE	•		GHA430008	
MATRIX						
-	2009-2013			o	GHA400309	
	2014-			o	GHA400309	
MATRIX (ZRE14_, AZE14_)						
1.8 (97 kW)	2008.01-	Hatchback Engine 2ZR-FE	•		GHA426022	
	2008.01-	Hatchback Engine 2ZR-FE	•		GHA426030	K
MATRIX (ZZE13_)						
1.8 (130 kW)	2002.09-2006.12	MPV Engine 2ZZ-GE	•		GHA426030	K
1.8 VVTi (96 kW)	2001.09-2004.02	MPV Engine 1ZZ-FE	•		GHA426030	K
1.8 VVTi 4WD (91 kW)	2001.09-2004.02	MPV Engine 1ZZ-FE	•		GHA426030	K
	2001.09-2004.02	MPV Engine 1ZZ-FE		o	GHA326053	
MR 2 III (ZZW3_)						
1.8 16V VT-i (103 kW)	1999.10-2007.06	Convertible Engine 1ZZ-FE	•		GHA400295	
	1999.10-2007.06	Convertible Engine 1ZZ-FE		o	GWB6831	
NOAH/VOXY (_AZR6_)						
2.0 (121 kW)	2001.12-2007.06	MPV Engine 1AZ-FSE	•		GHA426049	K
OPA (ZCT1_, ACT1_)						
1.8 (100 kW)	2000.04-2003.08	Estate Engine 1ZZ-FE	•		GHA426030	K
1.8 4WD (92 kW)	2000.04-2003.08	Estate Engine 1ZZ-FE	•		GHA426030	K
	2000.04-2003.08	Estate Engine 1ZZ-FE		o	GHA326057	
2.0 (112 kW)	2000.08-2005.04	Estate Engine 1AZ-FSE	•		GHA426030	K
PASEO (EL54)						
1.5 (66 kW)	1996.10-1999.03	Convertible Engine 5E-FE		o	GWB3217	
1.5 (81 kW)	1997.10-2000.04	Convertible Engine 5E-FE		o	GWB3217	
PICNIC (_XM10)						
2.0 (90 kW)	2001.01-2001.12	MPV Engine 3S-FE	•		GWB3237	
2.0 16V (94 kW)	1996.05-2001.12	MPV Engine 3S-FE	•		GWB3237	
	1996.05-2001.12	MPV Engine 3S-FE		o	GHA400184	
2.2 D (66 kW)	1997.08-2001.12	MPV Engine 3C-TE	•		GWB3237	
PREMIO (NZT26_, ZRT26_)						
1.5 (81 kW)	2007.07-	Saloon Engine 1NZ-FE	•		GHA426030	K
PREVIA (MCR3_, ACR3_, CLR3_)						
2.0 D-4D (85 kW)	2001.03-2006.01	MPV Engine 1CD-FTV	•		GHA430005	K
	2001.03-2006.01	MPV Engine 1CD-FTV	•		GWB3946	
	2001.03-2006.01	MPV Engine 1CD-FTV		o	GHA400167	K
2.4 (115 kW)	2000.08-2006.01	MPV Engine 2AZ-FE	•		GHA426026	
	2000.08-2006.01	MPV Engine 2AZ-FE	•		GHA430005	K
	2000.08-2006.01	MPV Engine 2AZ-FE	•		GWB3946	
	2000.08-2006.01	MPV Engine 2AZ-FE		o	GHA400167	K
3.0 VVTi (162 kW)	2000.08-2005.12	MPV Engine 1MZ-FE	•		GHA430005	K
PREVIA III (AHR5_, GSR5_, ACR5_)						
2.4 (125 kW)	2005.10-	MPV Engine 2AZ-FE		o	GHA400310	
3.5 (200 kW)	2006.01-	MPV Engine 2GR-FE		o	GHA400310	
PRIUS (NHW11_)						
1.5 (53 kW)	2000.05-2004.01	Saloon Engine 1NZ-FXE	•		GHA426022	
	2000.05-2004.01	Saloon Engine 1NZ-FXE	•		GWB6831	
	2000.05-2004.01	Saloon Engine 1NZ-FXE With ABS		o	GHA400062	
PRIUS (NHW20_)						
1.5 (57 kW)	2003.11-2006.02	Hatchback Engine 1NZ-FXE	•		GHA326028	K
	2003.11-2006.02	Hatchback Engine 1NZ-FXE With ABS		o	GHA400095	
	2003.11-2006.02	Hatchback Engine 1NZ-FXE With ABS		o	GHA400114	



	 YEAR		F	R	G-AP Ref.	KIT
TOYOTA						
PRIUS (ZVW3_)						
1.8 HybrID (73 kW)	2009.04-	Hatchback Engine 2ZR-FXE	•		GHA326039	
	2009.04-	Hatchback Engine 2ZR-FXE		○	GHA400166	
PRIUS C (NHP10_)						
1.5 HybrID (54 kW)	2011.12-	Hatchback Engine 1NZ-FXE	•		GHA426024	
PRIUS PLUS (ZVW4_)						
1.8 HybrID (73 kW)	2011.05-	MPV Engine 2ZR-FXE		○	GHA400234	
	2011.05-	MPV Engine 2ZR-FXE Inner Spline 26T	•		GHA326024	K
PROGRES (JCG1_)						
2.5 (147 kW)	1998.05-2007.05	Saloon Engine 1JZ-FSE	•		GHA499084	
3.0 (162 kW)	1998.05-2007.05	Saloon Engine 2JZ-FSE	•		GHA499084	
RACTIS (SCP10_, NCP10_)						
1.3 (64 kW)	2005.09-2010.08	MPV Engine 2SZ-FE	•		GHA426024	
1.5 VVTi (80 kW)	2005.09-2010.08	MPV Engine 1NZ-FE	•		GHA426024	
1.5 VVTi 4WD (76 kW)	2005.09-2010.08	MPV Engine 1NZ-FE	•		GHA426024	
RAV 4 (SXA1_)						
2.0 16V 4WD (94 kW)	1997.12-2000.06	Open Off-Road Vehicle Engine 3S-FE	•		GHA426041	
	1997.12-2000.06	Open Off-Road Vehicle Engine 3S-FE	•		GWB1340	
	1997.12-2000.06	Open Off-Road Vehicle Engine 3S-FE	•		GWB3308	
	1997.12-2000.06	Open Off-Road Vehicle Engine 3S-FE		○	GHA238001	K
2.0 4WD (95 kW)	1994.06-2000.06	Closed Off-Road Vehicle Engine 3S-FE	•		GHA426041	
	1994.06-2000.06	Closed Off-Road Vehicle Engine 3S-FE	•		GWB1340	
	1994.06-2000.06	Closed Off-Road Vehicle Engine 3S-FE	•		GWB3308	
	1994.06-2000.06	Closed Off-Road Vehicle Engine 3S-FE		○	GHA238001	K
RAV 4 I (SXA1_)						
2.0 (99 kW)	1997.06-1999.09	Closed Off-Road Vehicle Engine 3S-FE	•		GHA426041	
	1997.06-1999.09	Closed Off-Road Vehicle Engine 3S-FE	•		GWB1340	
	1997.06-1999.09	Closed Off-Road Vehicle Engine 3S-FE	•		GWB3308	
RAV 4 II (CLA2_, XA2_, ZCA2_, ACA2_)						
1.8 VVT-i (92 kW)	2000.08-2005.11	Closed Off-Road Vehicle Engine 1ZZ-FE	•		GHA426049	K
	2000.08-2005.11	Closed Off-Road Vehicle Engine 1ZZ-FE	•		GWB3945	
	2000.08-2005.11	Closed Off-Road Vehicle Engine 1ZZ-FE With ABS		○	GHA400121	
	2000.08-2005.11	Closed Off-Road Vehicle Engine 1ZZ-FE Without ABS		○	GHA400129	K
2.0 D-4D 4WD (85 kW)	2001.09-2005.11	Closed Off-Road Vehicle Engine 1CD-FTV	•		GHA426049	K
	2001.09-2005.11	Closed Off-Road Vehicle Engine 1CD-FTV	•		GWB3945	
	2001.09-2005.11	Closed Off-Road Vehicle Engine 1CD-FTV		○	GHA326027	K
2.0 VVT-i 4WD (110 kW)	2000.06-2005.11	Closed Off-Road Vehicle Engine 1AZ-FE	•		GHA426049	K
	2000.06-2005.11	Closed Off-Road Vehicle Engine 1AZ-FE	•		GWB3945	
	2000.06-2005.11	Closed Off-Road Vehicle Engine 1AZ-FE		○	GHA326027	K
	2000.06-2005.11	Closed Off-Road Vehicle Engine 1AZ-FE With ABS		○	GHA400121	
	2000.06-2005.11	Closed Off-Road Vehicle Engine 1AZ-FE Without ABS		○	GHA400129	K
2.4 VVT-i 4WD (112 kW)	2003.08-2005.11	Closed Off-Road Vehicle Engine 2AZ-FE	•		GHA426049	K
	2003.08-2005.11	Closed Off-Road Vehicle Engine 2AZ-FE	•		GWB3945	
	2003.08-2005.11	Closed Off-Road Vehicle Engine 2AZ-FE		○	GHA326027	K
	2003.08-2005.11	Closed Off-Road Vehicle Engine 2AZ-FE With ABS		○	GHA400121	
	2003.08-2005.11	Closed Off-Road Vehicle Engine 2AZ-FE Without ABS		○	GHA400129	K
RAV 4 III (ACA3_, ACE_, ALA3_, GSA3_, ZSA3_)						
2.0 (116 kW)	2008.12-	Closed Off-Road Vehicle Engine 3ZR-FAE		○	GHA400238	
	2008.12-	Closed Off-Road Vehicle Engine 3ZR-FAE Inner Spline 26T	•		GHA326024	K
	2008.12-	Closed Off-Road Vehicle Engine 3ZR-FAE Inner Spline 30T	•		GHA330014	K
2.0 4WD (116 kW)	2008.12-	Closed Off-Road Vehicle Engine 3ZR-FAE		○	GHA326030	K
	2008.12-	Closed Off-Road Vehicle Engine 3ZR-FAE Inner Spline 26T	•		GHA326024	K
	2008.12-	Closed Off-Road Vehicle Engine 3ZR-FAE Inner Spline 30T	•		GHA330014	K
2.0 VVT-i (109 kW)	2009.03-	Closed Off-Road Vehicle Engine 3ZR-FAE		○	GHA400238	
	2009.03-	Closed Off-Road Vehicle Engine 3ZR-FAE Inner Spline 26T	•		GHA326024	K
	2009.03-	Closed Off-Road Vehicle Engine 3ZR-FAE Inner Spline 30T	•		GHA330014	K
2.0 VVT-i 4WD (109 kW)	2009.03-	Closed Off-Road Vehicle Engine 3ZR-FAE		○	GHA326030	K
	2009.03-	Closed Off-Road Vehicle Engine 3ZR-FAE Inner Spline 26T	•		GHA326024	K
	2009.03-	Closed Off-Road Vehicle Engine 3ZR-FAE Inner Spline 30T	•		GHA330014	K
2.0 VVT-i 4WD (112 kW)	2006.02-2007.03	Closed Off-Road Vehicle Engine 1AZ-FE		○	GHA326030	K
	2006.02-2007.03	Closed Off-Road Vehicle Engine 1AZ-FE Inner Spline 26T	•		GHA326024	K
	2006.02-2007.03	Closed Off-Road Vehicle Engine 1AZ-FE Inner Spline 30T	•		GHA330014	K
2.2 D-4D (110 kW)	2008.12-	Closed Off-Road Vehicle Engine 2AD-FHV/2AD-FTV		○	GHA400238	
	2008.12-	Closed Off-Road Vehicle Engine 2AD-FHV/2AD-FTV Inner Spline 30T	•		GHA330014	K



	 YEAR		F	R	G-AP Ref.	KIT
TOYOTA						
RAV 4 III (ACA3_, ACE_, ALA3_, GSA3_, ZSA3_)						
2.2 D-4D 4WD (100 kW)	2006.02-2007.03	Closed Off-Road Vehicle Engine 2AD-FTV		o	GHA326030	K
	2006.02-2007.03	Closed Off-Road Vehicle Engine 2AD-FTV Inner Spline 30T	•		GHA330014	K
2.2 D-4D 4WD (110 kW)	2008.12-	Closed Off-Road Vehicle Engine 2AD-FTV/2AD-FHV		o	GHA326030	K
	2008.12-	Closed Off-Road Vehicle Engine 2AD-FTV/2AD-FHV Inner Spline 30T	•		GHA330014	K
2.2 D-CAT 4WD (130 kW)	2006.02-2007.03	Closed Off-Road Vehicle Engine 2AD-FHV		o	GHA326030	K
	2006.02-2007.03	Closed Off-Road Vehicle Engine 2AD-FHV Inner Spline 30T	•		GHA330014	K
2.4 VVT-i (125 kW)	2005.11-	Closed Off-Road Vehicle Engine 2AZ-FE		o	GHA400238	
	2005.11-	Closed Off-Road Vehicle Engine 2AZ-FE Inner Spline 26T	•		GHA326024	K
	2005.11-	Closed Off-Road Vehicle Engine 2AZ-FE Inner Spline 30T	•		GHA330014	K
2.4 VVTi 4WD (125 kW)	2005.11-	Closed Off-Road Vehicle Engine 2AZ-FE		o	GHA326030	K
	2005.11-	Closed Off-Road Vehicle Engine 2AZ-FE Inner Spline 26T	•		GHA326024	K
	2005.11-	Closed Off-Road Vehicle Engine 2AZ-FE Inner Spline 30T	•		GHA330014	K
3.5 VVT-i 4WD (201 kW)	2005.11-	Closed Off-Road Vehicle Engine 2GR-FE		o	GHA326030	K
	2005.11-	Closed Off-Road Vehicle Engine 2GR-FE Inner Spline 30T	•		GHA330014	K
RAV 4 IV (WWA4_, AVA4_, ZSA4_, ALA4_)						
2.0 D4-D (91 kW)	2012.12-	Closed Off-Road Vehicle Engine 1AD-FTV		o	GHA400238	
	2012.12-	Closed Off-Road Vehicle Engine 1AD-FTV Inner Spline 30T	•		GHA330014	K
2.0 D4-D 4WD (91 kW)	2013.11-	Closed Off-Road Vehicle Engine 1AD-FTV		o	GHA326030	K
	2013.11-	Closed Off-Road Vehicle Engine 1AD-FTV Inner Spline 30T	•		GHA330014	K
2.0 VVT-i (107 kW)	2012.12-	Closed Off-Road Vehicle Engine 3ZR-FE		o	GHA400238	
	2012.12-	Closed Off-Road Vehicle Engine 3ZR-FE Inner Spline 26T	•		GHA326024	K
	2012.12-	Closed Off-Road Vehicle Engine 3ZR-FE Inner Spline 30T	•		GHA330014	K
2.0 VVT-i 4WD (112 kW)	2015.04-	Closed Off-Road Vehicle Engine 3ZR-FAE		o	GHA326030	K
	2015.04-	Closed Off-Road Vehicle Engine 3ZR-FAE Inner Spline 26T	•		GHA326024	K
	2015.04-	Closed Off-Road Vehicle Engine 3ZR-FAE Inner Spline 30T	•		GHA330014	K
2.2 D4-D 4WD (110 kW)	2012.12-	Closed Off-Road Vehicle Engine 2AD-FHV/2AD-FTV		o	GHA326030	K
	2012.12-	Closed Off-Road Vehicle Engine 2AD-FHV/2AD-FTV Inner Spline 30T	•		GHA330014	K
2.5 VVT-i 4WD (132 kW)	2012.12-	Closed Off-Road Vehicle Engine 2AR-FE		o	GHA326030	K
	2012.12-	Closed Off-Road Vehicle Engine 2AR-FE Inner Spline 30T	•		GHA330014	K
RAV 4 IV (ZSA4_, ALA4_)						
2.0 VVT-i 4WD (111 kW)	2012.12-	Closed Off-Road Vehicle Engine 3ZR-FAE		o	GHA326030	K
	2012.12-	Closed Off-Road Vehicle Engine 3ZR-FAE Inner Spline 26T	•		GHA326024	K
	2012.12-	Closed Off-Road Vehicle Engine 3ZR-FAE Inner Spline 30T	•		GHA330014	K
ROYAL (JZS17_)						
2.5 (206 kW)	1999.09-2003.08	Saloon Engine 1JZ-GTE	•		GHA499084	
RUSH (F700_)						
1.5 (80 kW)	2006.03-	Closed Off-Road Vehicle Engine 3SZ-VE	•		GWB6967	
1.5 4WD (80 kW)	2006.03-	Closed Off-Road Vehicle Engine 3SZ-VE	•		GWB6967	
SEQUOIA						
-	2001-2007			o	GHA248001	
SEQUOIA (UCK6_, UPK6_, USK6_)						
4.7 (206 kW)	2007.11-	MPV Engine 2UZ-FE	•		GHA258001	
	2007.11-	MPV Engine 2UZ-FE		o	GHA258002	
4.7 4WD (206 kW)	2007.11-	MPV Engine 2UZ-FE	•		GHA258001	
	2007.11-	MPV Engine 2UZ-FE		o	GHA258002	
5.7 (280 kW)	2007.11-	MPV Engine 3UR-FE	•		GHA258001	
	2007.11-	MPV Engine 3UR-FE		o	GHA258002	
5.7 4WD (284 kW)	2007.11-	MPV Engine 3UR-FE	•		GHA258001	
	2007.11-	MPV Engine 3UR-FE		o	GHA258002	
SIENNA						
-	1998-2003			o	GHA400141	
SIENNA (MCL2_, GSL2_)						
3.3 4WD (169 kW)	2003.05-2009.11	MPV Engine 3MZ-FE	•		GHA430005	K
SIERRA						
-	2004-2010			o	GHA326046	
STARLET (EP91)						
1.3 (55 kW)	1996.04-1999.03	Hatchback Engine 4E-FE	•		GWB3916	
	1996.04-1999.03	Hatchback Engine 4E-FE	•		GWB3917	
	1996.04-1999.03	Hatchback Engine 4E-FE		o	GWB3217	
TACOMA						
-	2012-2005			o	GHA244001	
	2012-2005			o	GHA244002	



	 YEAR		F	R	G-AP Ref.	KIT
TOYOTA						
URBAN CRUISER (NSP1_, NLP1_, ZSP1_, NCP11_)						
1.33 (73 kW)	2010.04-	Hatchback Engine 1NR-FE	•		GHA426024	
	2010.04-	Hatchback Engine 1NR-FE	•		GWB6878	
	2010.04-	Hatchback Engine 1NR-FE		○	GHA400350	
1.33 (74 kW)	2009.04-	Hatchback Engine 1NR-FE	•		GHA426024	
	2009.04-	Hatchback Engine 1NR-FE	•		GWB6878	
1.4 D-4D (66 kW)	2009.04-	Hatchback Engine 1ND-TV	•		GHA426024	
	2009.04-	Hatchback Engine 1ND-TV	•		GWB6878	
1.4 D-4D 4WD (66 kW)	2009.04-	Hatchback Engine 1ND-TV	•		GWB6878	
	2009.04-	Hatchback Engine 1ND-TV		○	GHA326054	K
VENZA (GGV1_, AGV1_)						
2.7 (136 kW)	2008.11-	Estate Engine 1AR-FE	•		GHA430005	K
2.7 4WD (136 kW)	2008.11-	Estate Engine 1AR-FE	•		GHA430005	K
3.5 (200 kW)	2008.11-	Estate Engine 2GR-FE	•		GHA430005	K
3.5 4WD (200 kW)	2008.11-	Estate Engine 2GR-FE	•		GHA430005	K
VEROSSA (JZX11_, GX11_)						
2.0 VVTi (118 kW)	2000.10-2003.11	Saloon Engine 1G-FE	•		GHA499084	
2.5 VVTi (147 kW)	2000.10-2003.11	Saloon Engine 1JZ-FSE	•		GHA499084	
2.5 VVTi (206 kW)	2000.10-2003.11	Saloon Engine 1JZ-GTE	•		GHA499084	
VERSO (_AUR2_, _ZGR2_)						
1.6 (97 kW)	2009.04-	MPV Engine 1ZR-FAE Inner Spline 26T	•		GHA326024	K
1.6 D4-D (82 kW)	2013.11-	MPV Engine 1WW Inner Spline 30T	•		GHA330014	K
1.8 (108 kW)	2009.04-	MPV Engine 2ZR-FAE Inner Spline 26T	•		GHA326024	K
2.0 D-4D (91 kW)	2012.11-	MPV Engine 1AD-FTV Inner Spline 30T	•		GHA330014	K
2.0 D-4D (93 kW)	2009.04-	MPV Engine 1AD-FTV Inner Spline 30T	•		GHA330014	K
2.2 D-4D (110 kW)	2009.04-	MPV Engine 2AD-FHV Inner Spline 30T	•		GHA330014	K
2.2 D-CAT (130 kW)	2009.04-	MPV Engine 2AD-FHV Inner Spline 30T	•		GHA330014	K
VERSO S (NLP12_, NCP12_, NSP12_)						
1.33 (73 kW)	2010.11-	MPV Engine 1NR-FE	•		GWB6878	
	2010.11-	MPV Engine 1NR-FE		○	GHA400233	
	2010.11-	MPV Engine 1NR-FE Without ABS		○	GHA400098	
1.4 D4-D (66 kW)	2010.11-	MPV Engine 1ND-TV	•		GWB6878	
	2010.11-	MPV Engine 1ND-TV		○	GHA400233	
	2010.11-	MPV Engine 1ND-TV Without ABS		○	GHA400098	
VIOS (SCP4_, NCP4_, AXP4_)						
1.5 (68 kW)	2002.07-2008.01	Saloon Engine 1NZ-FE/5A-FE	•		GWB3929	
	2002.07-2008.01	Saloon Engine 1NZ-FE/5A-FE With ABS		○	GHA400008	
	2002.07-2008.01	Saloon Engine 1NZ-FE/5A-FE Without ABS		○	GHA400007	
1.5 VVTi (78 kW)	2002.07-2008.01	Saloon Engine 1NZ-FE/5A-FE	•		GWB3929	
	2002.07-2008.01	Saloon Engine 1NZ-FE/5A-FE With ABS		○	GHA400008	
	2002.07-2008.01	Saloon Engine 1NZ-FE/5A-FE Without ABS		○	GHA400007	
VIOS/YARIS (ZSP9_, NCP9_)						
1.3 (64 kW)	2007.08-	Saloon Engine 2NZ-FE/2SZ-FE	•		GHA426024	
	2007.08-	Saloon Engine 2NZ-FE/2SZ-FE	•		GWB6878	
	2007.08-	Saloon Engine 2NZ-FE/2SZ-FE With ABS		○	GHA400087	K
1.3 4WD (64 kW)	2007.08-	Saloon Engine 2NZ-FE	•		GHA426024	
1.5 (80 kW)	2007.08-	Saloon Engine 1NZ-FE	•		GHA426024	
	2007.08-	Saloon Engine 1NZ-FE	•		GWB6878	
	2007.08-	Saloon Engine 1NZ-FE With ABS		○	GHA400087	K
VISTA (SV5_, ZV5_)						
2.0 (107 kW)	1998.06-2003.08	Saloon Engine 3S-FSE	•		GHA426030	K
WILL VS (ZZE12_, NZE12_)						
1.5 VVTi 4WD (81 kW)	2001.03-2004.04	Hatchback Engine 1NZ-FE	•		GHA426022	
	2001.03-2004.04	Hatchback Engine 1NZ-FE		○	GHA326043	
WINDOM (MCV3_)						
3.0 VVTi G (158 kW)	2001.08-2004.07	Saloon Engine 1MZ-FE	•		GHA430005	K
	2001.08-2004.07	Saloon Engine 1MZ-FE Without ABS		○	GHA400024	
WINDOM (VCV1_)						
3.0 (138 kW)	1991.07-1996.09	Saloon Engine 3VZ-FE Without ABS		○	GHA400024	
WISH (ZGE2_)						
1.8 (106 kW)	2009.04-	MPV Engine 2ZR-FAE	•		GHA426030	K
2.0 (116 kW)	2009.04-	MPV Engine 3ZR-FAE	•		GHA426030	K



	 YEAR		F	R	G-AP Ref.	KIT
TOYOTA						
WISH (ZNE1_, ANE1_)						
1.8 Hi (97 kW)	2003.04-2009.03	MPV Engine 1ZZ-FE	•		GHA426030	K
WISH MPV (ZGE2_)						
1.8 4WD (98 kW)	2009.04-	MPV Engine 2ZR-FAX	•		GHA426030	K
	2009.04-	MPV Engine 2ZR-FAX		○	GHA326057	
WISH MPV (ZNE1_, ANE1_)						
1.8 Hi 4WD (92 kW)	2003.04-2009.03	MPV Engine 1ZZ-FE	•		GHA426030	K
	2003.04-2009.03	MPV Engine 1ZZ-FE		○	GHA326057	
2.0 Zi (114 kW)	2003.04-2009.03	MPV Engine 1AZ-FSE	•		GHA426030	K
	2003.04-2009.03	MPV Engine 1AZ-FSE	•		GWB6831	
	2003.04-2009.03	MPV Engine 1AZ-FSE With ABS		○	GHA400095	
YARIS (NHP13_, NSP13_, NCP13_, KSP13_, NLP13_)						
1.3 VVT-i (63 kW)	2010.12-	Hatchback Engine 2NZ-FE	•		GHA426024	
YARIS (SCP9_, NSP9_, KSP9_, NCP9_, ZSP9_)						
1.0 GPL (51 kW)	2006.01-	Hatchback Engine 1KR-FE	•		GHA426024	
	2006.01-	Hatchback Engine 1KR-FE	•		GWB6878	
	2006.01-	Hatchback Engine 1KR-FE With ABS		○	GHA400087	K
1.5 (80 kW)	2005.11-	Hatchback Engine 1NZ-FE	•		GHA426024	
	2005.11-	Hatchback Engine 1NZ-FE	•		GWB6878	
	2005.11-	Hatchback Engine 1NZ-FE With ABS		○	GHA400087	K
YARIS / VITZ (NLP13_, NSP13_, NCP13_, KSP13_)						
1.0 (51 kW)	2011.09-	Hatchback Engine 1KR-FE	•		GHA426024	
	2011.09-	Hatchback Engine 1KR-FE	•		GWB6878	
	2011.09-	Hatchback Engine 1KR-FE With ABS		○	GHA400087	K
1.3 (70 kW)	2011.09-	Hatchback Engine 1NR-FE	•		GHA426024	
	2011.09-	Hatchback Engine 1NR-FE	•		GWB6878	
	2011.09-	Hatchback Engine 1NR-FE With ABS		○	GHA400087	K
1.3 (73 kW)	2011.09-	Hatchback Engine 1NR-FE	•		GHA426024	
	2011.09-	Hatchback Engine 1NR-FE	•		GWB6878	
	2011.09-	Hatchback Engine 1NR-FE With ABS		○	GHA400087	K
1.4 D-4D (66 kW)	2011.09-	Hatchback Engine 1ND-TV	•		GHA426024	
	2011.09-	Hatchback Engine 1ND-TV	•		GWB6878	
	2011.09-	Hatchback Engine 1ND-TV With ABS		○	GHA400087	K
1.5 HybriD (55 kW)	2012.03-	Hatchback Engine 1NZ-FXE	•		GHA426024	
	2012.03-	Hatchback Engine 1NZ-FXE	•		GWB6878	
	2012.03-	Hatchback Engine 1NZ-FXE		○	GHA400276	
YARIS / VITZ (SCP1_, NLP1_, NCP1_)						
1.0 16V (48 kW)	2002.01-2005.11	Hatchback Engine 1SZ-FE	•		GHA424016	K
	2002.01-2005.11	Hatchback Engine 1SZ-FE	•		GWB3929	
	2002.01-2005.11	Hatchback Engine 1SZ-FE With ABS		○	GHA400008	
	2002.01-2005.11	Hatchback Engine 1SZ-FE Without ABS		○	GHA400007	
1.0 16V (50 kW)	1999.04-2005.09	Hatchback Engine 1SZ-FE	•		GHA424016	K
	1999.04-2005.09	Hatchback Engine 1SZ-FE	•		GWB3929	
	1999.04-2005.09	Hatchback Engine 1SZ-FE With ABS		○	GHA400008	
	1999.04-2005.09	Hatchback Engine 1SZ-FE Without ABS		○	GHA400007	
1.3 (64 kW)	2002.04-2005.09	Hatchback Engine 2SZ-FE	•		GHA426024	
	2002.04-2005.09	Hatchback Engine 2SZ-FE	•		GWB3929	
	2002.04-2005.09	Hatchback Engine 2SZ-FE With ABS		○	GHA400008	
	2002.04-2005.09	Hatchback Engine 2SZ-FE Without ABS		○	GHA400007	
1.3 16V (63 kW)	1999.11-2005.09	Hatchback Engine 2NZ-FE	•		GHA424016	K
	1999.11-2005.09	Hatchback Engine 2NZ-FE	•		GWB3929	
	1999.11-2005.09	Hatchback Engine 2NZ-FE With ABS		○	GHA400008	
	1999.11-2005.09	Hatchback Engine 2NZ-FE Without ABS		○	GHA400007	
1.4 D-4D (55 kW)	2001.12-2005.09	Hatchback Engine 1ND-TV	•		GHA424016	K
	2001.12-2005.09	Hatchback Engine 1ND-TV	•		GWB3929	
	2001.12-2005.09	Hatchback Engine 1ND-TV With ABS		○	GHA400008	
	2001.12-2005.09	Hatchback Engine 1ND-TV Without ABS		○	GHA400007	
1.5 TS (77 kW)	2003.01-2005.09	Hatchback Engine 1NZ-FE	•		GHA426024	
	2003.01-2005.09	Hatchback Engine 1NZ-FE	•		GWB3929	
	2003.01-2005.09	Hatchback Engine 1NZ-FE With ABS		○	GHA400008	
1.5 VVT-i TS (110 kW)	2003.03-2005.07	Hatchback Engine 1NZ-FE	•		GWB3929	
	2003.03-2005.07	Hatchback Engine 1NZ-FE With ABS		○	GHA400008	
1.5 VVT-i TS (78 kW)	2001.04-2005.09	Hatchback Engine 1NZ-FE	•		GWB3929	
	2001.04-2005.09	Hatchback Engine 1NZ-FE With ABS		○	GHA400008	



	 YEAR		F	R	G-AP Ref.	KIT
TOYOTA						
YARIS / VITZ (SCP9_, NSP9_, KSP9_, NCP9_, ZSP9_)						
1.0 VVT-i (51 kW)	2005.08-	Hatchback Engine 1KR-FE	•		GHA426024	
	2005.08-	Hatchback Engine 1KR-FE	•		GWB6878	
	2005.08-	Hatchback Engine 1KR-FE With ABS		◦	GHA400087	K
	2005.08-	Hatchback Engine 1KR-FE Without ABS		◦	GHA400098	
1.3 4WD (64 kW)	2007.08-	Hatchback Engine 2NZ-FE	•		GHA426024	
1.3 VVT-i (63 kW)	2005.11-	Hatchback Engine 2NZ-FE	•		GHA426024	
	2005.11-	Hatchback Engine 2NZ-FE	•		GWB6878	
	2005.11-	Hatchback Engine 2NZ-FE With ABS		◦	GHA400087	K
1.3 VVT-i (64 kW)	2005.08-	Hatchback Engine 2SZ-FE	•		GHA426024	
	2005.08-	Hatchback Engine 2SZ-FE	•		GWB6878	
	2005.08-	Hatchback Engine 2SZ-FE With ABS		◦	GHA400087	K
	2005.08-	Hatchback Engine 2SZ-FE Without ABS		◦	GHA400098	
1.33 VVT-i (73 kW)	2010.07-	Hatchback Engine 1NR-FE	•		GHA426024	
	2010.07-	Hatchback Engine 1NR-FE	•		GWB6878	
	2010.07-	Hatchback Engine 1NR-FE With ABS		◦	GHA400087	K
1.33 VVT-i (74 kW)	2009.03-	Hatchback Engine 2NR-FE	•		GHA426024	
	2009.03-	Hatchback Engine 2NR-FE	•		GWB6878	
	2009.03-	Hatchback Engine 2NR-FE With ABS		◦	GHA400087	K
	2009.03-	Hatchback Engine 2NR-FE Without ABS		◦	GHA400098	
1.4 D-4D (66 kW)	2008.02-	Hatchback Engine 1ND-TV	•		GWB6878	
	2008.02-	Hatchback Engine 1ND-TV With ABS		◦	GHA400087	K
	2008.02-	Hatchback Engine 1ND-TV Without ABS		◦	GHA400098	
1.8 VVT-i (98 kW)	2007.04-	Hatchback Engine 2ZR-FE	•		GHA426024	
	2007.04-	Hatchback Engine 2ZR-FE	•		GWB6878	
	2007.04-	Hatchback Engine 2ZR-FE With ABS		◦	GHA400087	K
	2007.04-	Hatchback Engine 2ZR-FE Without ABS		◦	GHA400098	
YARIS VERSO (_NLP2_, _NCP2_)						
1.3 (62 kW)	2003.01-2006.02	MPV Engine 2NZ-FE	•		GHA424016	K
	2003.01-2006.02	MPV Engine 2NZ-FE	•		GWB3929	
	2003.01-2006.02	MPV Engine 2NZ-FE With ABS		◦	GHA400008	
	2003.01-2006.02	MPV Engine 2NZ-FE Without ABS		◦	GHA400007	
1.3 (63 kW)	1999.08-2005.09	MPV Engine 2NZ-FE	•		GHA424016	K
	1999.08-2005.09	MPV Engine 2NZ-FE	•		GWB3929	
	1999.08-2005.09	MPV Engine 2NZ-FE With ABS		◦	GHA400008	
	1999.08-2005.09	MPV Engine 2NZ-FE Without ABS		◦	GHA400007	
1.4 D-4D (55 kW)	2001.12-2005.09	MPV Engine 1ND-TV	•		GHA424016	K
	2001.12-2005.09	MPV Engine 1ND-TV	•		GWB3929	
	2001.12-2005.09	MPV Engine 1ND-TV With ABS		◦	GHA400008	
	2001.12-2005.09	MPV Engine 1ND-TV Without ABS		◦	GHA400007	
1.5 (77 kW)	2003.05-2005.09	MPV Engine 1NZ-FE	•		GWB3929	
	2003.05-2005.09	MPV Engine 1NZ-FE With ABS		◦	GHA400008	
	2003.05-2005.09	MPV Engine 1NZ-FE Without ABS		◦	GHA400007	
1.5 (78 kW)	2000.03-2005.09	MPV Engine 1NZ-FE	•		GWB3929	
	2000.03-2005.09	MPV Engine 1NZ-FE With ABS		◦	GHA400008	
	2000.03-2005.09	MPV Engine 1NZ-FE Without ABS		◦	GHA400007	
ZELAS (AGT20)						
2.5 VVT-i (131 kW)	2010.08-	Coupe Engine 2AR-FE		◦	GHA400238	
VAUXHALL						
ADAM						
1.0 (85 kW)	2014.07-	Hatchback Engine B 10 XFT	•		GWB6550	
	2014.07-	Hatchback Engine B 10 XFT		◦	GHA230092	S
1.2 (51 kW)	2012.10-	Hatchback Engine A12XEL	•		GWB6550	
	2012.10-	Hatchback Engine A12XEL		◦	GHA230092	S
1.4 (64 kW)	2012.10-	Hatchback Engine A14XEL	•		GWB6550	
	2012.10-	Hatchback Engine A14XEL		◦	GHA230092	S
1.4 (74 kW)	2012.10-	Hatchback Engine A14XER	•		GWB6550	
	2012.10-	Hatchback Engine A14XER		◦	GHA230092	S
1.4 LPG (64 kW)	2013.07-	Hatchback Engine A14XEL	•		GWB6550	
	2013.07-	Hatchback Engine A14XEL		◦	GHA230092	S
1.4 S (110 kW)	2014.11-	Hatchback Engine B 14 NEH	•		GWB6550	
	2014.11-	Hatchback Engine B 14 NEH		◦	GHA230092	S
AGILA I (A)						
1.0 12V (43 kW)	2000.09-2005.08	Hatchback Engine Z10XE	•		GWB3571	



	 YEAR		F	R	G-AP Ref.	KIT
TOYOTA						
AGILA I (A)						
1.0 12V (43 kW)	2000.09-2005.08	Hatchback Engine Z10XE		o	GWB3572	
	2000.09-2005.08	Hatchback Engine Z10XE		o	GWB6640	
	2000.09-2005.08	Hatchback Engine Z10XE		o	GWB6642	
1.0 12V (44 kW)	2000.02-2006.11	Hatchback Engine Z10XEP	•		GWB3571	
	2000.02-2006.11	Hatchback Engine Z10XEP		o	GWB3572	
	2000.02-2006.11	Hatchback Engine Z10XEP		o	GWB6640	
	2000.02-2006.11	Hatchback Engine Z10XEP		o	GWB6642	
1.2 16V (55 kW)	2000.09-2008.03	Hatchback Engine Z12XE	•		GWB3571	
	2000.09-2008.03	Hatchback Engine Z12XE		o	GWB3572	
	2000.09-2008.03	Hatchback Engine Z12XE		o	GWB6640	
	2000.09-2008.03	Hatchback Engine Z12XE		o	GWB6642	
1.2 16V Twinport (59 kW)	2004.07-2006.11	Hatchback Engine Z12XEP	•		GWB3571	
	2004.07-2006.11	Hatchback Engine Z12XEP		o	GWB6640	
	2004.07-2006.11	Hatchback Engine Z12XEP		o	GWB6642	
AGILA II (B)						
1.0 12V (48 kW)	2008.01-	Hatchback Engine K10B	•		GWB7526	
	2008.01-	Hatchback Engine K10B		o	GWB6639	
	2008.01-	Hatchback Engine K10B		o	GWB7525	
1.0 i (50 kW)	2011.08-	Hatchback Engine K10B	•		GWB7526	
	2011.08-	Hatchback Engine K10B		o	GWB6639	
	2011.08-	Hatchback Engine K10B		o	GWB7525	
1.2 i 16V (63 kW)	2008.01-	Hatchback Engine K12B	•		GWB7526	
	2008.01-	Hatchback Engine K12B		o	GWB6639	
	2008.01-	Hatchback Engine K12B		o	GWB7525	
1.2 i 16V (69 kW)	2008.01-	Hatchback Engine K12B	•		GWB7526	
	2008.01-	Hatchback Engine K12B		o	GWB6639	
	2008.01-	Hatchback Engine K12B		o	GWB7525	
1.3 CDTi (55 kW)	2008.01-	Hatchback Engine Z13DTJ/D13A	•		GWB7526	
	2008.01-	Hatchback Engine Z13DTJ/D13A		o	GWB6639	
	2008.01-	Hatchback Engine Z13DTJ/D13A		o	GWB7525	
ANTARA (J26, H26)						
2.0 CDTi (110 kW)	2006.08-	Closed Off-Road Vehicle Engine Z20DMH	•		GHA330010	K
	2006.08-	Closed Off-Road Vehicle Engine Z20DMH	•		GHA330032	
	2006.08-	Closed Off-Road Vehicle Engine Z20DMH		o	GHA330008	K
2.0 CDTi (93 kW)	2006.08-	Closed Off-Road Vehicle Engine Z20DM	•		GHA330010	K
	2006.08-	Closed Off-Road Vehicle Engine Z20DM		o	GHA330008	K
2.2 CDTi (120 kW)	2010.12-	Closed Off-Road Vehicle Engine A22DM		o	GHA330008	K
	2010.12-	Closed Off-Road Vehicle Engine A22DM		o	GHA330008	K
2.2 CDTi (135 kW)	2010.12-	Closed Off-Road Vehicle Engine A22DMH		o	GHA330008	K
2.4 (103 kW)	2006.08-	Closed Off-Road Vehicle Engine Z24XED	•		GHA330010	K
	2006.08-	Closed Off-Road Vehicle Engine Z24XED		o	GHA330008	K
2.4 (123 kW)	2010.12-	Closed Off-Road Vehicle Engine A24XE		o	GHA330008	K
	2010.12-	Closed Off-Road Vehicle Engine A24XE		o	GHA330008	K
2.4 (126 kW)	2010.11-	Closed Off-Road Vehicle Engine A24XE		o	GHA330008	K
	2010.11-	Closed Off-Road Vehicle Engine A24XE		o	GHA330008	K
3.0 (188 kW)	2010.11-	Closed Off-Road Vehicle Engine A30XH		o	GHA330008	K
3.2 V6 (167 kW)	2006.11-	Closed Off-Road Vehicle Engine 10HM/Z32SED	•		GHA330010	K
	2006.11-	Closed Off-Road Vehicle Engine 10HM/Z32SED		o	GHA330008	K
ASTRA GTC MK VI (J)						
1.6 SiDi (125 kW)	2012.12-	Hatchback Engine A16XHT	•		GHA330019	K
ASTRA GTC VI (J)						
1.4 (103 kW)	2011.10-	Hatchback Engine A14NET Fits Rim Size 15(Inch)	•		GHA333080	K
	2011.10-	Hatchback Engine A14NET Fits Rim Size 15(Inch)		o	GHA400164	K
1.4 (74 kW)	2011.10-	Hatchback Engine A14XER Fits Rim Size 15(Inch)	•		GHA333080	K
	2011.10-	Hatchback Engine A14XER Fits Rim Size 15(Inch)		o	GHA400164	K
1.4 (88 kW)	2011.10-	Hatchback Engine A14NEL Fits Rim Size 15(Inch)	•		GHA333080	K
	2011.10-	Hatchback Engine A14NEL Fits Rim Size 15(Inch)		o	GHA400164	K
1.6 (132 kW)	2011.10-	Hatchback Engine A16LET Fits Rim Size 15(Inch)	•		GHA333080	K
	2011.10-	Hatchback Engine A16LET Fits Rim Size 15(Inch)		o	GHA400164	K
1.7 CDTi (81 kW)	2011.10-	Hatchback Engine A17DTC/A17DTE/A17DTJ	•		GHA330019	K
	2011.10-	Hatchback Engine A17DTC/A17DTE/A17DTJ		o	GHA400193	K
1.7 CDTi (96 kW)	2011.10-	Hatchback Engine A17DTF/A17DTS	•		GHA330019	K
	2011.10-	Hatchback Engine A17DTF/A17DTS		o	GHA400193	K
2.0 BiTurbo CDTi (143 kW)	2012.12-	Hatchback Engine A20DTR	•		GHA330019	K



	 YEAR		F	R	G-AP Ref.	KIT
VAUXHALL						
ASTRA GTC VI (J)						
2.0 BiTurbo CDTi (143 kW)	2012.12-	Hatchback Engine A20DTR		o	GHA400193	K
2.0 CDTi (121 kW)	2011.10-	Hatchback Engine A20DTH	•		GHA330019	K
	2011.10-	Hatchback Engine A20DTH		o	GHA400193	K
2.0 VXR (206 kW)	2012.04-	Hatchback Engine A20NFT	•		GHA330019	K
	2012.04-	Hatchback Engine A20NFT		o	GHA400193	K
ASTRA II						
1.4 i (44 kW)	1990.01-1991.08	Hatchback Engine C14NZ	•		GHA422006	K
	1990.01-1991.08	Hatchback Engine C14NZ	•		GHA433013	
	1990.01-1991.08	Hatchback Engine C14NZ	•		GWB3256	
	1990.01-1991.08	Hatchback Engine C14NZ	•		GWB3403	
	1990.01-1991.08	Hatchback Engine C14NZ		o	GWB0944	
	1990.01-1991.08	Hatchback Engine C14NZ			GWB0663	
1.4 S (55 kW)	1990.01-1991.08	Hatchback Engine 14NV	•		GHA422006	K
	1990.01-1991.08	Hatchback Engine 14NV	•		GHA433013	
	1990.01-1991.08	Hatchback Engine 14NV	•		GWB3256	
	1990.01-1991.08	Hatchback Engine 14NV	•		GWB3403	
	1990.01-1991.08	Hatchback Engine 14NV		o	GWB0944	
	1990.01-1991.08	Hatchback Engine 14NV			GWB0663	
1.6 i (55 kW)	1991.01-1993.08	Convertible Engine E16NZ	•		GHA422023	
	1991.01-1993.08	Convertible Engine E16NZ	•		GHA433013	
	1991.01-1993.08	Convertible Engine E16NZ	•		GWB3256	
	1991.01-1993.08	Convertible Engine E16NZ	•		GWB3403	
	1991.01-1993.08	Convertible Engine E16NZ		o	GWB0944	
	1991.01-1993.08	Convertible Engine E16NZ			GWB0663	
1.8 i (83 kW)	1990.01-1991.08	Estate Engine 18E	•		GHA433013	
	1990.01-1991.08	Estate Engine 18E	•		GWB0736	
	1990.01-1991.08	Estate Engine 18E		o	GWB0944	
2.0 i CAT (85 kW)	1991.01-1993.08	Convertible Engine C20NE	•		GHA422023	
	1991.01-1993.08	Convertible Engine C20NE	•		GHA433007	
	1991.01-1993.08	Convertible Engine C20NE	•		GHA433013	
	1991.01-1993.08	Convertible Engine C20NE	•		GHA433019	
	1991.01-1993.08	Convertible Engine C20NE	•		GWB0736	
	1991.01-1993.08	Convertible Engine C20NE		o	GWB0944	
ASTRA II BELMONT						
1.4 i (44 kW)	1990.01-1991.12	Saloon Engine C14NZ	•		GHA422006	K
	1990.01-1991.12	Saloon Engine C14NZ	•		GHA433013	
	1990.01-1991.12	Saloon Engine C14NZ	•		GWB3256	
	1990.01-1991.12	Saloon Engine C14NZ	•		GWB3403	
	1990.01-1991.12	Saloon Engine C14NZ		o	GWB0944	
	1990.01-1991.12	Saloon Engine C14NZ			GWB0663	
ASTRA III (F)						
	1991.09-1998.02	Estate Engine C14NZ	•		GHA422006	K
	1991.09-1998.02	Estate Engine C14NZ	•		GHA422023	
	1991.09-1998.02	Estate Engine C14NZ	•		GWB3256	
	1991.09-1998.02	Estate Engine C14NZ	•		GWB3403	
	1991.09-1998.02	Estate Engine C14NZ			GWB0663	
	1991.09-1998.02	Estate Engine C14NZ With ABS		o	GHA400064	K
	1991.09-1998.02	Estate Engine C14NZ Without ABS		o	GHA400058	K
	1991.09-1998.02	Hatchback Engine C14NZ	•		GHA422006	K
	1991.09-1998.02	Hatchback Engine C14NZ	•		GHA422023	
	1991.09-1998.02	Hatchback Engine C14NZ	•		GWB3256	
	1991.09-1998.02	Hatchback Engine C14NZ	•		GWB3403	
	1991.09-1998.02	Hatchback Engine C14NZ			GWB0663	
	1991.09-1998.02	Hatchback Engine C14NZ With ABS		o	GHA400064	K
	1991.09-1998.02	Hatchback Engine C14NZ Without ABS		o	GHA400058	K
	1992.04-1998.09	Saloon Engine C14NZ	•		GHA422006	K
	1992.04-1998.09	Saloon Engine C14NZ	•		GHA422023	
	1992.04-1998.09	Saloon Engine C14NZ	•		GWB3256	
	1992.04-1998.09	Saloon Engine C14NZ	•		GWB3403	
	1992.04-1998.09	Saloon Engine C14NZ			GWB0663	
	1992.04-1998.09	Saloon Engine C14NZ With ABS		o	GHA400064	K
	1992.04-1998.09	Saloon Engine C14NZ Without ABS		o	GHA400058	K
1.4 i (60 kW)	1991.03-1998.02	Estate Engine C14SE	•		GHA422006	K
	1991.03-1998.02	Estate Engine C14SE	•		GHA422023	



	 YEAR		F	R	G-AP Ref.	KIT
VAUXHALL						
ASTRA III (F)						
1.4 i (60 kW)	1991.03-1998.02	Estate Engine C14SE	•		GWB0736	
	1991.03-1998.02	Estate Engine C14SE	•		GWB3256	
	1991.03-1998.02	Estate Engine C14SE	•		GWB3403	
	1991.03-1998.02	Estate Engine C14SE			GWB0663	
	1991.03-1998.02	Estate Engine C14SE With ABS		○	GHA400064	K
	1991.03-1998.02	Estate Engine C14SE Without ABS		○	GHA400058	K
	1992.03-1998.02	Hatchback Engine C14SE	•		GHA422006	K
	1992.03-1998.02	Hatchback Engine C14SE	•		GHA422023	
	1992.03-1998.02	Hatchback Engine C14SE	•		GWB0736	
	1992.03-1998.02	Hatchback Engine C14SE	•		GWB3256	
	1992.03-1998.02	Hatchback Engine C14SE	•		GWB3403	
	1992.03-1998.02	Hatchback Engine C14SE			GWB0663	
	1992.03-1998.02	Hatchback Engine C14SE With ABS		○	GHA400064	K
	1992.03-1998.02	Hatchback Engine C14SE Without ABS		○	GHA400058	K
	1992.04-1998.09	Saloon Engine C14SE	•		GHA422006	K
	1992.04-1998.09	Saloon Engine C14SE	•		GHA422023	
	1992.04-1998.09	Saloon Engine C14SE	•		GWB0736	
	1992.04-1998.09	Saloon Engine C14SE	•		GWB3256	
	1992.04-1998.09	Saloon Engine C14SE	•		GWB3403	
	1992.04-1998.09	Saloon Engine C14SE			GWB0663	
	1992.04-1998.09	Saloon Engine C14SE With ABS		○	GHA400064	K
	1992.04-1998.09	Saloon Engine C14SE Without ABS		○	GHA400058	K
	1993.05-2001.03	Convertible Engine C14SE	•		GHA422006	K
	1993.05-2001.03	Convertible Engine C14SE	•		GHA422023	
	1993.05-2001.03	Convertible Engine C14SE	•		GWB0736	
	1993.05-2001.03	Convertible Engine C14SE	•		GWB3256	
	1993.05-2001.03	Convertible Engine C14SE	•		GWB3403	
	1993.05-2001.03	Convertible Engine C14SE			GWB0663	
	1993.05-2001.03	Convertible Engine C14SE With ABS		○	GHA400064	K
	1993.05-2001.03	Convertible Engine C14SE Without ABS		○	GHA400058	K
1.4 i 16V (66 kW)	1996.01-2001.03	Convertible Engine X14XE	•		GHA422006	K
	1996.01-2001.03	Convertible Engine X14XE	•		GWB3403	
	1996.01-2001.03	Convertible Engine X14XE With ABS		○	GHA400064	K
	1996.01-2001.03	Convertible Engine X14XE Without ABS		○	GHA400058	K
	1996.02-1998.01	Estate Engine X14XE	•		GHA422006	K
	1996.02-1998.01	Estate Engine X14XE	•		GHA422023	
	1996.02-1998.01	Estate Engine X14XE	•		GWB3403	
	1996.02-1998.01	Estate Engine X14XE With ABS		○	GHA400064	K
	1996.02-1998.01	Estate Engine X14XE Without ABS		○	GHA400058	K
	1996.02-1998.02	Hatchback Engine X14XE	•		GHA422006	K
	1996.02-1998.02	Hatchback Engine X14XE	•		GHA422023	
	1996.02-1998.02	Hatchback Engine X14XE	•		GWB3403	
	1996.02-1998.02	Hatchback Engine X14XE With ABS		○	GHA400064	K
	1996.02-1998.02	Hatchback Engine X14XE Without ABS		○	GHA400058	K
	1996.02-1998.09	Saloon Engine X14XE	•		GHA422006	K
	1996.02-1998.09	Saloon Engine X14XE	•		GWB3403	
	1996.02-1998.09	Saloon Engine X14XE With ABS		○	GHA400064	K
	1996.02-1998.09	Saloon Engine X14XE Without ABS		○	GHA400058	K
1.4 S (55 kW)	1991.09-1998.02	Estate Engine 14NV	•		GHA422006	K
	1991.09-1998.02	Estate Engine 14NV	•		GWB3256	
	1991.09-1998.02	Estate Engine 14NV	•		GWB3403	
	1991.09-1998.02	Estate Engine 14NV			GWB0663	
	1991.09-1998.02	Estate Engine 14NV With ABS		○	GHA400064	K
	1991.09-1998.02	Estate Engine 14NV Without ABS		○	GHA400058	K
	1991.09-1998.02	Hatchback Engine 14NV	•		GHA422006	K
	1991.09-1998.02	Hatchback Engine 14NV	•		GWB3256	
	1991.09-1998.02	Hatchback Engine 14NV	•		GWB3403	
	1991.09-1998.02	Hatchback Engine 14NV			GWB0663	
	1991.09-1998.02	Hatchback Engine 14NV With ABS		○	GHA400064	K
	1991.09-1998.02	Hatchback Engine 14NV Without ABS		○	GHA400058	K
1.6 (74 kW)	1994.03-1995.08	Convertible Engine C16SE	•		GHA422006	K
	1994.03-1995.08	Convertible Engine C16SE	•		GHA422023	
	1994.03-1995.08	Convertible Engine C16SE	•		GWB0736	
	1994.03-1995.08	Convertible Engine C16SE	•		GWB3410	



	 YEAR		F	R	G-AP Ref.	KIT
VAUXHALL						
ASTRA III (F)						
1.6 (74 kW)	1994.03-1995.08	Convertible Engine C16SE With ABS		o	GHA400064	K
	1994.03-1995.08	Convertible Engine C16SE Without ABS		o	GHA400058	K
1.6 i (52 kW)	1993.03-1996.08	Convertible Engine X16SZ	•		GHA422006	K
	1993.03-1996.08	Convertible Engine X16SZ	•		GHA422023	
	1993.03-1996.08	Convertible Engine X16SZ	•		GWB0736	
	1993.03-1996.08	Convertible Engine X16SZ	•		GWB3403	
	1993.03-1996.08	Convertible Engine X16SZ With ABS		o	GHA400064	K
	1993.03-1996.08	Convertible Engine X16SZ Without ABS		o	GHA400058	K
	1994.07-1998.02	Estate Engine X16SZ	•		GHA422006	K
	1994.07-1998.02	Estate Engine X16SZ	•		GHA422023	
	1994.07-1998.02	Estate Engine X16SZ	•		GWB0736	
	1994.07-1998.02	Estate Engine X16SZ	•		GWB3403	
	1994.07-1998.02	Estate Engine X16SZ With ABS		o	GHA400064	K
	1994.07-1998.02	Estate Engine X16SZ Without ABS		o	GHA400058	K
	1994.07-1998.02	Hatchback Engine X16SZ	•		GHA422006	K
	1994.07-1998.02	Hatchback Engine X16SZ	•		GHA422023	
	1994.07-1998.02	Hatchback Engine X16SZ	•		GWB0736	
	1994.07-1998.02	Hatchback Engine X16SZ	•		GWB3403	
	1994.07-1998.02	Hatchback Engine X16SZ With ABS		o	GHA400064	K
	1994.07-1998.02	Hatchback Engine X16SZ Without ABS		o	GHA400058	K
	1994.08-1996.07	Saloon Engine X16SZ	•		GHA422006	K
	1994.08-1996.07	Saloon Engine X16SZ	•		GHA422023	
	1994.08-1996.07	Saloon Engine X16SZ	•		GWB0736	
	1994.08-1996.07	Saloon Engine X16SZ	•		GWB3403	
	1994.08-1996.07	Saloon Engine X16SZ With ABS		o	GHA400064	K
	1994.08-1996.07	Saloon Engine X16SZ Without ABS		o	GHA400058	K
1.6 i (55 kW)	1991.09-1998.02	Estate Engine C16NZ/E16NZ	•		GHA422006	K
	1991.09-1998.02	Estate Engine C16NZ/E16NZ	•		GWB0736	
	1991.09-1998.02	Estate Engine C16NZ/E16NZ	•		GWB3256	
	1991.09-1998.02	Estate Engine C16NZ/E16NZ	•		GWB3403	
	1991.09-1998.02	Estate Engine C16NZ/E16NZ	•		GWB3410	
	1991.09-1998.02	Estate Engine C16NZ/E16NZ			GWB0663	
	1991.09-1998.02	Estate Engine C16NZ/E16NZ With ABS		o	GHA400064	K
	1991.09-1998.02	Estate Engine C16NZ/E16NZ Without ABS		o	GHA400058	K
	1991.09-1998.02	Hatchback Engine C16NZ/E16NZ	•		GHA422006	K
	1991.09-1998.02	Hatchback Engine C16NZ/E16NZ	•		GHA422023	
	1991.09-1998.02	Hatchback Engine C16NZ/E16NZ	•		GWB0736	
	1991.09-1998.02	Hatchback Engine C16NZ/E16NZ	•		GWB3256	
	1991.09-1998.02	Hatchback Engine C16NZ/E16NZ	•		GWB3403	
	1991.09-1998.02	Hatchback Engine C16NZ/E16NZ	•		GWB3410	
	1991.09-1998.02	Hatchback Engine C16NZ/E16NZ			GWB0663	
	1991.09-1998.02	Hatchback Engine C16NZ/E16NZ With ABS		o	GHA400064	K
	1991.09-1998.02	Hatchback Engine C16NZ/E16NZ Without ABS		o	GHA400058	K
	1992.03-1998.09	Saloon Engine C16NZ/X16SZR	•		GHA422006	K
	1992.03-1998.09	Saloon Engine C16NZ/X16SZR	•		GHA422023	
	1992.03-1998.09	Saloon Engine C16NZ/X16SZR	•		GWB0736	
	1992.03-1998.09	Saloon Engine C16NZ/X16SZR	•		GWB3256	
	1992.03-1998.09	Saloon Engine C16NZ/X16SZR	•		GWB3403	
	1992.03-1998.09	Saloon Engine C16NZ/X16SZR	•		GWB3410	
	1992.03-1998.09	Saloon Engine C16NZ/X16SZR			GWB0663	
	1992.03-1998.09	Saloon Engine C16NZ/X16SZR With ABS		o	GHA400064	K
	1992.03-1998.09	Saloon Engine C16NZ/X16SZR Without ABS		o	GHA400058	K
	1996.01-2001.03	Convertible Engine X16SZR	•		GHA422023	
	1996.01-2001.03	Convertible Engine X16SZR	•		GWB0736	
	1996.01-2001.03	Convertible Engine X16SZR	•		GWB3403	
	1996.01-2001.03	Convertible Engine X16SZR With ABS		o	GHA400064	K
	1996.01-2001.03	Convertible Engine X16SZR Without ABS		o	GHA400058	K
1.6 i (74 kW)	1992.03-1998.02	Hatchback Engine C16SE	•		GHA422006	K
	1992.03-1998.02	Hatchback Engine C16SE	•		GWB0736	
	1992.03-1998.02	Hatchback Engine C16SE	•		GWB3256	
	1992.03-1998.02	Hatchback Engine C16SE	•		GWB3403	
	1992.03-1998.02	Hatchback Engine C16SE			GWB0663	
	1992.03-1998.02	Hatchback Engine C16SE With ABS		o	GHA400064	K
	1992.03-1998.02	Hatchback Engine C16SE Without ABS		o	GHA400058	K



	 YEAR		F	R	G-AP Ref.	KIT
VAUXHALL						
ASTRA III (F)						
1.6 i (74 kW)	1992.05-1994.12	Saloon Engine C16SE	•		GHA422006	K
	1992.05-1994.12	Saloon Engine C16SE	•		GWB0736	
	1992.05-1994.12	Saloon Engine C16SE	•		GWB3256	
	1992.05-1994.12	Saloon Engine C16SE	•		GWB3403	
	1992.05-1994.12	Saloon Engine C16SE			GWB0663	
	1992.05-1994.12	Saloon Engine C16SE With ABS		○	GHA400064	K
	1992.05-1994.12	Saloon Engine C16SE Without ABS		○	GHA400058	K
1.6 i 16V (74 kW)	1994.01-1998.02	Estate Engine X16XEL	•		GHA422006	K
	1994.01-1998.02	Estate Engine X16XEL	•		GHA422023	
	1994.01-1998.02	Estate Engine X16XEL	•		GWB3403	
	1994.01-1998.02	Estate Engine X16XEL	•		GWB3410	
	1994.01-1998.02	Estate Engine X16XEL With ABS		○	GHA400064	K
	1994.01-1998.02	Estate Engine X16XEL Without ABS		○	GHA400058	K
	1994.01-1998.02	Hatchback Engine X16XEL	•		GHA422006	K
	1994.01-1998.02	Hatchback Engine X16XEL	•		GHA422023	
	1994.01-1998.02	Hatchback Engine X16XEL	•		GWB3403	
	1994.01-1998.02	Hatchback Engine X16XEL	•		GWB3410	
	1994.01-1998.02	Hatchback Engine X16XEL With ABS		○	GHA400064	K
	1994.01-1998.02	Hatchback Engine X16XEL Without ABS		○	GHA400058	K
	1994.08-1998.09	Saloon Engine X16XEL	•		GHA422006	K
	1994.08-1998.09	Saloon Engine X16XEL	•		GHA422023	
	1994.08-1998.09	Saloon Engine X16XEL	•		GWB3403	
	1994.08-1998.09	Saloon Engine X16XEL	•		GWB3410	
	1994.08-1998.09	Saloon Engine X16XEL With ABS		○	GHA400064	K
	1994.08-1998.09	Saloon Engine X16XEL Without ABS		○	GHA400058	K
1.6 Si (74 kW)	1991.03-1994.12	Estate Engine C16SE	•		GHA422006	K
	1991.03-1994.12	Estate Engine C16SE	•		GHA422023	
	1991.03-1994.12	Estate Engine C16SE	•		GWB0736	
	1991.03-1994.12	Estate Engine C16SE	•		GWB3256	
	1991.03-1994.12	Estate Engine C16SE	•		GWB3403	
	1991.03-1994.12	Estate Engine C16SE			GWB0663	
	1991.03-1994.12	Estate Engine C16SE With ABS		○	GHA400064	K
	1991.03-1994.12	Estate Engine C16SE Without ABS		○	GHA400058	K
1.7 D (42 kW)	1991.12-1998.02	Estate Engine 17D	•		GHA422023	
	1991.12-1998.02	Estate Engine 17D	•		GHA433007	
	1991.12-1998.02	Estate Engine 17D	•		GWB0736	
	1991.12-1998.02	Estate Engine 17D	•		GWB3410	
	1991.12-1998.02	Estate Engine 17D With ABS		○	GHA400064	K
	1991.12-1998.02	Estate Engine 17D Without ABS		○	GHA400058	K
	1991.12-1998.02	Hatchback Engine 17D	•		GHA422023	
	1991.12-1998.02	Hatchback Engine 17D	•		GHA433007	
	1991.12-1998.02	Hatchback Engine 17D	•		GWB0736	
	1991.12-1998.02	Hatchback Engine 17D	•		GWB3410	
	1991.12-1998.02	Hatchback Engine 17D With ABS		○	GHA400064	K
	1991.12-1998.02	Hatchback Engine 17D Without ABS		○	GHA400058	K
	1992.03-1992.09	Saloon Engine 17D	•		GHA422023	
	1992.03-1992.09	Saloon Engine 17D	•		GHA433007	
	1992.03-1992.09	Saloon Engine 17D	•		GWB0736	
	1992.03-1992.09	Saloon Engine 17D	•		GWB3410	
	1992.03-1992.09	Saloon Engine 17D With ABS		○	GHA400064	K
	1992.03-1992.09	Saloon Engine 17D Without ABS		○	GHA400058	K
1.7 D (44 kW)	1991.03-1994.12	Estate Engine 17DR	•		GHA422023	
	1991.03-1994.12	Estate Engine 17DR	•		GHA433007	
	1991.03-1994.12	Estate Engine 17DR	•		GWB0736	
	1991.03-1994.12	Estate Engine 17DR	•		GWB3410	
	1991.03-1994.12	Estate Engine 17DR With ABS		○	GHA400064	K
	1991.03-1994.12	Estate Engine 17DR Without ABS		○	GHA400058	K
	1991.09-1994.12	Hatchback Engine 17DR	•		GHA422023	
	1991.09-1994.12	Hatchback Engine 17DR	•		GHA433007	
	1991.09-1994.12	Hatchback Engine 17DR	•		GWB0736	
	1991.09-1994.12	Hatchback Engine 17DR	•		GWB3410	
	1991.09-1994.12	Hatchback Engine 17DR With ABS		○	GHA400064	K
	1991.09-1994.12	Hatchback Engine 17DR Without ABS		○	GHA400058	K
	1992.07-1998.09	Saloon Engine 17DR	•		GHA422023	



	 YEAR		F	R	G-AP Ref.	KIT
VAUXHALL ASTRA III (F)						
	1992.07-1998.09	Saloon Engine 17DR	•		GHA433007	
	1992.07-1998.09	Saloon Engine 17DR	•		GWB0736	
	1992.07-1998.09	Saloon Engine 17DR	•		GWB3410	
	1992.07-1998.09	Saloon Engine 17DR With ABS		○	GHA400064	K
	1992.07-1998.09	Saloon Engine 17DR Without ABS		○	GHA400058	K
1.7 TD (50 kW)	1994.01-1998.02	Estate Engine X17DTL	•		GHA422023	
	1994.01-1998.02	Estate Engine X17DTL	•		GWB0736	
	1994.01-1998.02	Estate Engine X17DTL	•		GWB3410	
	1994.01-1998.02	Estate Engine X17DTL With ABS		○	GHA400064	K
	1994.01-1998.02	Estate Engine X17DTL Without ABS		○	GHA400058	K
	1994.08-1998.02	Hatchback Engine X17DTL	•		GHA422023	
	1994.08-1998.02	Hatchback Engine X17DTL	•		GWB0736	
	1994.08-1998.02	Hatchback Engine X17DTL	•		GWB3410	
	1994.08-1998.02	Hatchback Engine X17DTL With ABS		○	GHA400064	K
	1994.08-1998.02	Hatchback Engine X17DTL Without ABS		○	GHA400058	K
	1994.08-1998.09	Saloon Engine X17DTL	•		GHA422023	
	1994.08-1998.09	Saloon Engine X17DTL	•		GWB0736	
	1994.08-1998.09	Saloon Engine X17DTL	•		GWB3410	
	1994.08-1998.09	Saloon Engine X17DTL With ABS		○	GHA400064	K
	1994.08-1998.09	Saloon Engine X17DTL Without ABS		○	GHA400058	K
1.7 TD (60 kW)	1991.12-1998.02	Estate Engine 17DT(TC4EE1)	•		GHA422023	
	1991.12-1998.02	Estate Engine 17DT(TC4EE1)	•		GHA433007	
	1991.12-1998.02	Estate Engine 17DT(TC4EE1)	•		GHA433013	
	1991.12-1998.02	Estate Engine 17DT(TC4EE1)	•		GWB0736	
	1991.12-1998.02	Estate Engine 17DT(TC4EE1)	•		GWB3410	
	1991.12-1998.02	Estate Engine 17DT(TC4EE1) With ABS		○	GHA400064	K
	1991.12-1998.02	Estate Engine 17DT(TC4EE1) Without ABS		○	GHA400058	K
	1991.12-1998.02	Hatchback Engine 17DT(TC4EE1)	•		GHA422023	
	1991.12-1998.02	Hatchback Engine 17DT(TC4EE1)	•		GHA433007	
	1991.12-1998.02	Hatchback Engine 17DT(TC4EE1)	•		GWB0736	
	1991.12-1998.02	Hatchback Engine 17DT(TC4EE1)	•		GWB3410	
	1991.12-1998.02	Hatchback Engine 17DT(TC4EE1) With ABS		○	GHA400064	K
	1991.12-1998.02	Hatchback Engine 17DT(TC4EE1) Without ABS		○	GHA400058	K
	1991.12-1998.09	Saloon Engine 17DT(TC4EE1)	•		GHA422023	
	1991.12-1998.09	Saloon Engine 17DT(TC4EE1)	•		GHA433007	
	1991.12-1998.09	Saloon Engine 17DT(TC4EE1)	•		GWB0736	
	1991.12-1998.09	Saloon Engine 17DT(TC4EE1)	•		GWB3410	
	1991.12-1998.09	Saloon Engine 17DT(TC4EE1) With ABS		○	GHA400064	K
	1991.12-1998.09	Saloon Engine 17DT(TC4EE1) Without ABS		○	GHA400058	K
1.8 (92 kW)	1994.09-1996.08	Convertible Engine C18XE	•		GHA422023	
	1994.09-1996.08	Convertible Engine C18XE	•		GHA433007	
	1994.09-1996.08	Convertible Engine C18XE	•		GHA433019	
	1994.09-1996.08	Convertible Engine C18XE	•		GWB0736	
	1994.09-1996.08	Convertible Engine C18XE	•		GWB3410	
	1994.09-1996.08	Convertible Engine C18XE With ABS		○	GHA400064	K
	1994.09-1996.08	Convertible Engine C18XE Without ABS		○	GHA400058	K
1.8 16V (85 kW)	1994.11-2001.03	Convertible Engine C18XEL/X18XE	•		GHA422023	
	1994.11-2001.03	Convertible Engine C18XEL/X18XE	•		GHA433007	
	1994.11-2001.03	Convertible Engine C18XEL/X18XE	•		GHA433019	
	1994.11-2001.03	Convertible Engine C18XEL/X18XE	•		GWB0736	
	1994.11-2001.03	Convertible Engine C18XEL/X18XE	•		GWB3410	
	1994.11-2001.03	Convertible Engine C18XEL/X18XE With ABS		○	GHA400064	K
	1994.11-2001.03	Convertible Engine C18XEL/X18XE Without ABS		○	GHA400058	K
1.8 i (66 kW)	1991.09-1998.02	Estate Engine C18NZ	•		GHA422023	
	1991.09-1998.02	Estate Engine C18NZ	•		GHA433007	
	1991.09-1998.02	Estate Engine C18NZ	•		GWB0736	
	1991.09-1998.02	Estate Engine C18NZ	•		GWB3410	
	1991.09-1998.02	Estate Engine C18NZ With ABS		○	GHA400064	K
	1991.09-1998.02	Estate Engine C18NZ Without ABS		○	GHA400058	K
	1991.09-1998.02	Hatchback Engine C18NZ	•		GHA422023	
	1991.09-1998.02	Hatchback Engine C18NZ	•		GHA433007	
	1991.09-1998.02	Hatchback Engine C18NZ	•		GWB0736	
	1991.09-1998.02	Hatchback Engine C18NZ	•		GWB3410	
	1991.09-1998.02	Hatchback Engine C18NZ With ABS		○	GHA400064	K



	 YEAR		F	R	G-AP Ref.	KIT	
VAUXHALL							
ASTRA III (F)							
1.8 i (66 kW)	1991.09-1998.02	Hatchback Engine C18NZ Without ABS		o	GHA400058	K	
	1992.03-1998.09	Saloon Engine C18NZ	•		GHA422023		
	1992.03-1998.09	Saloon Engine C18NZ	•		GHA433007		
	1992.03-1998.09	Saloon Engine C18NZ	•		GWB0736		
	1992.03-1998.09	Saloon Engine C18NZ	•		GWB3410		
	1992.03-1998.09	Saloon Engine C18NZ With ABS		o	GHA400064	K	
	1992.03-1998.09	Saloon Engine C18NZ Without ABS		o	GHA400058	K	
1.8 i 16V (82 kW)	1995.09-1998.02	Saloon Engine 18SE	•		GWB0736		
	1995.09-1998.02	Saloon Engine 18SE	•		GWB3410		
	1995.09-1998.02	Saloon Engine 18SE With ABS		o	GHA400064	K	
	1995.09-1998.02	Saloon Engine 18SE Without ABS		o	GHA400058	K	
	1994.01-1996.12	Saloon Engine C18XEL	•		GHA422023		
1.8 i 16V (85 kW)	1994.01-1996.12	Saloon Engine C18XEL	•		GHA433007		
	1994.01-1996.12	Saloon Engine C18XEL	•		GWB0736		
	1994.01-1996.12	Saloon Engine C18XEL	•		GWB3410		
	1994.01-1996.12	Saloon Engine C18XEL With ABS		o	GHA400064	K	
	1994.01-1996.12	Saloon Engine C18XEL Without ABS		o	GHA400058	K	
	1994.09-1998.02	Estate Engine C18XEL/X18XE	•		GHA422023		
	1994.09-1998.02	Estate Engine C18XEL/X18XE	•		GHA433007		
	1994.09-1998.02	Estate Engine C18XEL/X18XE	•		GWB0736		
	1994.09-1998.02	Estate Engine C18XEL/X18XE	•		GWB3410		
	1994.09-1998.02	Estate Engine C18XEL/X18XE With ABS		o	GHA400064	K	
	1994.09-1998.02	Estate Engine C18XEL/X18XE Without ABS		o	GHA400058	K	
	1994.09-1998.02	Hatchback Engine C18XEL	•		GHA422023		
	1994.09-1998.02	Hatchback Engine C18XEL	•		GHA433007		
	1994.09-1998.02	Hatchback Engine C18XEL	•		GWB0736		
	1994.09-1998.02	Hatchback Engine C18XEL	•		GWB3410		
	1994.09-1998.02	Hatchback Engine C18XEL With ABS		o	GHA400064	K	
	1994.09-1998.02	Hatchback Engine C18XEL Without ABS		o	GHA400058	K	
	1.8 i 16V (92 kW)	1993.06-1994.10	Saloon Engine C18XE	•		GHA422023	
		1993.06-1994.10	Saloon Engine C18XE	•		GHA433007	
		1993.06-1994.10	Saloon Engine C18XE	•		GHA433019	
1993.06-1994.10		Saloon Engine C18XE	•		GWB0736		
1993.06-1994.10		Saloon Engine C18XE	•		GWB3410		
1993.06-1994.10		Saloon Engine C18XE With ABS		o	GHA400064	K	
1993.06-1994.10		Saloon Engine C18XE Without ABS		o	GHA400058	K	
1994.09-1998.02		Estate Engine C18XE	•		GHA422023		
1994.09-1998.02		Estate Engine C18XE	•		GHA433007		
1994.09-1998.02		Estate Engine C18XE	•		GHA433019		
1994.09-1998.02		Estate Engine C18XE	•		GWB0736		
1994.09-1998.02		Estate Engine C18XE	•		GWB3410		
1994.09-1998.02		Estate Engine C18XE With ABS		o	GHA400064	K	
1994.09-1998.02		Estate Engine C18XE Without ABS		o	GHA400058	K	
1994.09-1998.02		Hatchback Engine C18XE	•		GHA422023		
1994.09-1998.02		Hatchback Engine C18XE	•		GHA433007		
1994.09-1998.02		Hatchback Engine C18XE	•		GHA433019		
1994.09-1998.02		Hatchback Engine C18XE	•		GWB0736		
1994.09-1998.02		Hatchback Engine C18XE	•		GWB3410		
1994.09-1998.02		Hatchback Engine C18XE With ABS		o	GHA400064	K	
1994.09-1998.02	Hatchback Engine C18XE Without ABS		o	GHA400058	K		
2.0 i (85 kW)	1991.09-1998.02	Estate Engine C20NE	•		GHA422023		
	1991.09-1998.02	Estate Engine C20NE	•		GHA433007		
	1991.09-1998.02	Estate Engine C20NE	•		GHA433019		
	1991.09-1998.02	Estate Engine C20NE	•		GWB0736		
	1991.09-1998.02	Estate Engine C20NE	•		GWB3410		
	1991.09-1998.02	Estate Engine C20NE With ABS		o	GHA400064	K	
	1991.09-1998.02	Estate Engine C20NE Without ABS		o	GHA400058	K	
	1991.09-1998.02	Hatchback Engine C20NE	•		GHA422023		
	1991.09-1998.02	Hatchback Engine C20NE	•		GHA433007		
	1991.09-1998.02	Hatchback Engine C20NE	•		GHA433019		
	1991.09-1998.02	Hatchback Engine C20NE	•		GWB0736		
	1991.09-1998.02	Hatchback Engine C20NE	•		GWB3410		
	1991.09-1998.02	Hatchback Engine C20NE With ABS		o	GHA400064	K	
	1991.09-1998.02	Hatchback Engine C20NE Without ABS		o	GHA400058	K	



	 YEAR		F	R	G-AP Ref.	KIT
VAUXHALL						
ASTRA III (F)						
2.0 i (85 kW)	1992.03-1998.09	Saloon Engine C20NE	•		GHA422023	
	1992.03-1998.09	Saloon Engine C20NE	•		GHA433007	
	1992.03-1998.09	Saloon Engine C20NE	•		GHA433019	
	1992.03-1998.09	Saloon Engine C20NE	•		GWB0736	
	1992.03-1998.09	Saloon Engine C20NE	•		GWB3410	
	1992.03-1998.09	Saloon Engine C20NE With ABS		◦	GHA400064	K
	1992.03-1998.09	Saloon Engine C20NE Without ABS		◦	GHA400058	K
	1993.03-1994.10	Convertible Engine C20NE	•		GHA422023	
	1993.03-1994.10	Convertible Engine C20NE	•		GHA433007	
	1993.03-1994.10	Convertible Engine C20NE	•		GHA433019	
	1993.03-1994.10	Convertible Engine C20NE	•		GWB0736	
	1993.03-1994.10	Convertible Engine C20NE	•		GWB3410	
	1993.03-1994.10	Convertible Engine C20NE With ABS		◦	GHA400064	K
	1993.03-1994.10	Convertible Engine C20NE Without ABS		◦	GHA400058	K
2.0 i 16V (100 kW)	1994.01-1998.02	Convertible Engine X20XEV	•		GWB0736	
	1994.01-1998.02	Convertible Engine X20XEV	•		GWB3410	
	1994.01-1998.02	Convertible Engine X20XEV With ABS		◦	GHA400064	K
	1994.01-1998.02	Convertible Engine X20XEV Without ABS		◦	GHA400058	K
	1994.01-1998.02	Estate Engine X20XEV	•		GHA422023	
	1994.01-1998.02	Estate Engine X20XEV	•		GHA433007	
	1994.01-1998.02	Estate Engine X20XEV	•		GWB0736	
	1994.01-1998.02	Estate Engine X20XEV	•		GWB3410	
	1994.01-1998.02	Estate Engine X20XEV With ABS		◦	GHA400064	K
	1994.01-1998.02	Estate Engine X20XEV Without ABS		◦	GHA400058	K
	1994.01-1998.02	Hatchback Engine X20XEV	•		GHA422023	
	1994.01-1998.02	Hatchback Engine X20XEV	•		GHA433007	
	1994.01-1998.02	Hatchback Engine X20XEV	•		GWB0736	
	1994.01-1998.02	Hatchback Engine X20XEV	•		GWB3410	
	1994.01-1998.02	Hatchback Engine X20XEV With ABS		◦	GHA400064	K
	1994.01-1998.02	Hatchback Engine X20XEV Without ABS		◦	GHA400058	K
	1995.02-1998.09	Saloon Engine X20XEV	•		GHA422023	
	1995.02-1998.09	Saloon Engine X20XEV	•		GHA433007	
	1995.02-1998.09	Saloon Engine X20XEV	•		GWB0736	
	1995.02-1998.09	Saloon Engine X20XEV	•		GWB3410	
1995.02-1998.09	Saloon Engine X20XEV With ABS		◦	GHA400064	K	
1995.02-1998.09	Saloon Engine X20XEV Without ABS		◦	GHA400058	K	
2.0 i 16V (110 kW)	1991.09-1998.02	Hatchback Engine C20XE	•		GHA422023	
	1991.09-1998.02	Hatchback Engine C20XE	•		GHA433007	
	1991.09-1998.02	Hatchback Engine C20XE	•		GHA433019	
	1991.09-1998.02	Hatchback Engine C20XE	•		GWB0736	
	1991.09-1998.02	Hatchback Engine C20XE	•		GWB3410	
	1991.09-1998.02	Hatchback Engine C20XE With ABS		◦	GHA400064	K
1991.09-1998.02	Hatchback Engine C20XE Without ABS		◦	GHA400058	K	
ASTRA IV (G)						
1.2 16V (48 kW)	1998.02-2000.09	Estate Engine X12XE With ABS	•		GHA333033	K
	1998.02-2000.09	Estate Engine X12XE With ABS		◦	GHA400064	K
	1998.02-2000.09	Estate Engine X12XE Without ABS	•		GHA333036	K
	1998.02-2000.09	Estate Engine X12XE Without ABS		◦	GHA400058	K
	1998.02-2000.09	Hatchback Engine X12XE With ABS	•		GHA333033	K
	1998.02-2000.09	Hatchback Engine X12XE With ABS		◦	GHA400064	K
	1998.02-2000.09	Hatchback Engine X12XE Without ABS	•		GHA333036	K
	1998.02-2000.09	Hatchback Engine X12XE Without ABS		◦	GHA400058	K
	1998.09-2000.09	Saloon Engine X12XE With ABS	•		GHA333033	K
	1998.09-2000.09	Saloon Engine X12XE With ABS		◦	GHA400064	K
	1998.09-2000.09	Saloon Engine X12XE Without ABS	•		GHA333036	K
	1998.09-2000.09	Saloon Engine X12XE Without ABS		◦	GHA400058	K
1.2 16V (55 kW)	2000.09-2005.05	Estate Engine Z12XE With ABS	•		GHA333033	K
	2000.09-2005.05	Estate Engine Z12XE With ABS		◦	GHA400064	K
	2000.09-2005.05	Estate Engine Z12XE Without ABS	•		GHA333036	K
	2000.09-2005.05	Estate Engine Z12XE Without ABS		◦	GHA400058	K
	2000.09-2005.05	Hatchback Engine Z12XE With ABS	•		GHA333033	K
	2000.09-2005.05	Hatchback Engine Z12XE With ABS		◦	GHA400064	K
	2000.09-2005.05	Hatchback Engine Z12XE Without ABS	•		GHA333036	K
	2000.09-2005.05	Hatchback Engine Z12XE Without ABS		◦	GHA400058	K



	 YEAR		F	R	G-AP Ref.	KIT
VAUXHALL						
ASTRA IV (G)						
1.2 16V (55 kW)	2000.09-2005.05	Saloon Engine Z12XE With ABS	•		GHA333033	K
	2000.09-2005.05	Saloon Engine Z12XE With ABS		◦	GHA400064	K
	2000.09-2005.05	Saloon Engine Z12XE Without ABS	•		GHA333036	K
	2000.09-2005.05	Saloon Engine Z12XE Without ABS		◦	GHA400058	K
1.4 16V (66 kW)	1998.02-2005.05	Estate Engine X14XE/Z14XE With ABS	•		GHA333033	K
	1998.02-2005.05	Estate Engine X14XE/Z14XE With ABS		◦	GHA400064	K
	1998.02-2005.05	Estate Engine X14XE/Z14XE Without ABS	•		GHA333036	K
	1998.02-2005.05	Estate Engine X14XE/Z14XE Without ABS		◦	GHA400058	K
	1998.02-2005.05	Hatchback Engine X14XE/Z14XE With ABS	•		GHA333033	K
	1998.02-2005.05	Hatchback Engine X14XE/Z14XE With ABS		◦	GHA400064	K
	1998.02-2005.05	Hatchback Engine X14XE/Z14XE Without ABS	•		GHA333036	K
	1998.02-2005.05	Hatchback Engine X14XE/Z14XE Without ABS		◦	GHA400058	K
	1998.09-2005.05	Saloon Engine X14XE/Z14XE With ABS	•		GHA333033	K
	1998.09-2005.05	Saloon Engine X14XE/Z14XE With ABS		◦	GHA400064	K
	1998.09-2005.05	Saloon Engine X14XE/Z14XE Without ABS	•		GHA333036	K
	1998.09-2005.05	Saloon Engine X14XE/Z14XE Without ABS		◦	GHA400058	K
1.6 (55 kW)	1998.02-2000.09	Hatchback Engine X16SZR	•		GHA333102	K
	1998.02-2000.09	Hatchback Engine X16SZR With ABS	•		GHA333029	K
	1998.02-2000.09	Hatchback Engine X16SZR With ABS		◦	GHA400064	K
	1998.02-2000.09	Hatchback Engine X16SZR Without ABS		◦	GHA400058	K
	1998.03-2004.04	Estate Engine X16SZR With ABS	•		GHA333033	K
	1998.03-2004.04	Estate Engine X16SZR With ABS		◦	GHA400064	K
	1998.03-2004.04	Estate Engine X16SZR Without ABS	•		GHA333036	K
	1998.03-2004.04	Estate Engine X16SZR Without ABS		◦	GHA400058	K
	1998.09-2000.09	Saloon Engine X16SZR With ABS	•		GHA333033	K
	1998.09-2000.09	Saloon Engine X16SZR With ABS		◦	GHA400064	K
	1998.09-2000.09	Saloon Engine X16SZR Without ABS	•		GHA333036	K
	1998.09-2000.09	Saloon Engine X16SZR Without ABS		◦	GHA400058	K
1.6 (62 kW)	1998.03-2004.04	Estate Engine Z16SE With ABS	•		GHA333033	K
	1998.03-2004.04	Estate Engine Z16SE With ABS		◦	GHA400064	K
	1998.03-2004.04	Estate Engine Z16SE Without ABS	•		GHA333036	K
	1998.03-2004.04	Estate Engine Z16SE Without ABS		◦	GHA400058	K
	2000.09-2005.05	Hatchback Engine Z16SE With ABS	•		GHA333033	K
	2000.09-2005.05	Hatchback Engine Z16SE With ABS		◦	GHA400064	K
	2000.09-2005.05	Hatchback Engine Z16SE Without ABS	•		GHA333036	K
	2000.09-2005.05	Hatchback Engine Z16SE Without ABS		◦	GHA400058	K
	2000.09-2005.05	Saloon Engine Z16SE With ABS	•		GHA333033	K
	2000.09-2005.05	Saloon Engine Z16SE With ABS		◦	GHA400064	K
	2000.09-2005.05	Saloon Engine Z16SE Without ABS	•		GHA333036	K
	2000.09-2005.05	Saloon Engine Z16SE Without ABS		◦	GHA400058	K
1.6 (76 kW)	2002.12-2005.05	Estate Engine Z16XEP With ABS	•		GHA333033	K
	2002.12-2005.05	Estate Engine Z16XEP With ABS		◦	GHA400064	K
	2002.12-2005.05	Estate Engine Z16XEP Without ABS	•		GHA333036	K
	2002.12-2005.05	Estate Engine Z16XEP Without ABS		◦	GHA400058	K
1.6 16V (74 kW)	1998.02-2005.05	Hatchback Engine X16XEL/Z16XE With ABS	•		GHA333033	K
	1998.02-2005.05	Hatchback Engine X16XEL/Z16XE With ABS		◦	GHA400064	K
	1998.02-2005.05	Hatchback Engine X16XEL/Z16XE Without ABS	•		GHA333036	K
	1998.02-2005.05	Hatchback Engine X16XEL/Z16XE Without ABS		◦	GHA400058	K
	1998.03-2004.04	Estate Engine X16XEL/Z16XE With ABS	•		GHA333033	K
	1998.03-2004.04	Estate Engine X16XEL/Z16XE With ABS		◦	GHA400064	K
	1998.03-2004.04	Estate Engine X16XEL/Z16XE Without ABS	•		GHA333036	K
	1998.03-2004.04	Estate Engine X16XEL/Z16XE Without ABS		◦	GHA400058	K
	1998.09-2005.05	Saloon Engine C16SEL/X16XEL/Z16XE/Z16XEP With ABS	•		GHA333033	K
	1998.09-2005.05	Saloon Engine C16SEL/X16XEL/Z16XE/Z16XEP With ABS		◦	GHA400064	K
	1998.09-2005.05	Saloon Engine C16SEL/X16XEL/Z16XE/Z16XEP Without ABS	•		GHA333036	K
	1998.09-2005.05	Saloon Engine C16SEL/X16XEL/Z16XE/Z16XEP Without ABS		◦	GHA400058	K
	2001.03-2005.10	Convertible Engine Z16XE With ABS	•		GHA333033	K
	2001.03-2005.10	Convertible Engine Z16XE With ABS		◦	GHA400064	K
	2001.03-2005.10	Convertible Engine Z16XE Without ABS	•		GHA333036	K
	2001.03-2005.10	Convertible Engine Z16XE Without ABS		◦	GHA400058	K
1.6 16V (76 kW)	2003.03-2005.10	Convertible Engine Z16XEP With ABS	•		GHA333033	K
	2003.03-2005.10	Convertible Engine Z16XEP With ABS		◦	GHA400064	K
	2003.03-2005.10	Convertible Engine Z16XEP Without ABS	•		GHA333036	K
	2003.03-2005.10	Convertible Engine Z16XEP Without ABS		◦	GHA400058	K



	 YEAR		F	R	G-AP Ref.	KIT
VAUXHALL						
ASTRA IV (G)						
1.6 Dualfuel (62 kW)	2000.07-2005.05	Estate Engine Z16SE With ABS	•		GHA333033	K
	2000.07-2005.05	Estate Engine Z16SE With ABS		◦	GHA400064	K
	2000.07-2005.05	Estate Engine Z16SE Without ABS	•		GHA333036	K
	2000.07-2005.05	Estate Engine Z16SE Without ABS		◦	GHA400058	K
	2000.07-2005.05	Hatchback Engine Z16SE With ABS	•		GHA333033	K
	2000.07-2005.05	Hatchback Engine Z16SE With ABS		◦	GHA400064	K
	2000.07-2005.05	Hatchback Engine Z16SE Without ABS	•		GHA333036	K
	2000.07-2005.05	Hatchback Engine Z16SE Without ABS		◦	GHA400058	K
	2000.07-2005.05	Saloon Engine Z16SE With ABS	•		GHA333033	K
	2000.07-2005.05	Saloon Engine Z16SE With ABS		◦	GHA400064	K
	2000.07-2005.05	Saloon Engine Z16SE Without ABS	•		GHA333036	K
	2000.07-2005.05	Saloon Engine Z16SE Without ABS		◦	GHA400058	K
1.6 Dualfuel (63 kW)	1998.03-2004.04	Estate Engine Z16XE With ABS	•		GHA333033	K
	1998.03-2004.04	Estate Engine Z16XE With ABS		◦	GHA400064	K
	1998.03-2004.04	Estate Engine Z16XE Without ABS	•		GHA333036	K
	1998.03-2004.04	Estate Engine Z16XE Without ABS		◦	GHA400058	K
	2002.09-2005.05	Hatchback Engine Z16XE With ABS	•		GHA333033	K
	2002.09-2005.05	Hatchback Engine Z16XE With ABS		◦	GHA400064	K
	2002.09-2005.05	Hatchback Engine Z16XE Without ABS	•		GHA333036	K
	2002.09-2005.05	Hatchback Engine Z16XE Without ABS		◦	GHA400058	K
	2002.09-2005.05	Saloon Engine Z16XE With ABS	•		GHA333033	K
	2002.09-2005.05	Saloon Engine Z16XE With ABS		◦	GHA400064	K
	2002.09-2005.05	Saloon Engine Z16XE Without ABS	•		GHA333036	K
	2002.09-2005.05	Saloon Engine Z16XE Without ABS		◦	GHA400058	K
1.7 CDTi 16V (59 kW)	2003.04-2005.05	Estate Engine Z17DTL With ABS	•		GHA333033	K
	2003.04-2005.05	Estate Engine Z17DTL With ABS		◦	GHA400064	K
	2003.04-2005.05	Estate Engine Z17DTL Without ABS	•		GHA333036	K
	2003.04-2005.05	Estate Engine Z17DTL Without ABS		◦	GHA400058	K
	2003.04-2005.05	Hatchback Engine Z17DTL With ABS	•		GHA333033	K
	2003.04-2005.05	Hatchback Engine Z17DTL With ABS		◦	GHA400064	K
	2003.04-2005.05	Hatchback Engine Z17DTL Without ABS	•		GHA333036	K
	2003.04-2005.05	Hatchback Engine Z17DTL Without ABS		◦	GHA400058	K
	2003.04-2005.05	Saloon Engine Z17DTL With ABS	•		GHA333033	K
	2003.04-2005.05	Saloon Engine Z17DTL With ABS		◦	GHA400064	K
	2003.04-2005.05	Saloon Engine Z17DTL Without ABS	•		GHA333036	K
	2003.04-2005.05	Saloon Engine Z17DTL Without ABS		◦	GHA400058	K
1.7 DTi 16V (55 kW)	2000.02-2005.05	Estate Engine Y17DT With ABS	•		GHA333033	K
	2000.02-2005.05	Estate Engine Y17DT With ABS		◦	GHA400064	K
	2000.02-2005.05	Estate Engine Y17DT Without ABS	•		GHA333036	K
	2000.02-2005.05	Estate Engine Y17DT Without ABS		◦	GHA400058	K
	2000.02-2005.05	Hatchback Engine Y17DT With ABS	•		GHA333033	K
	2000.02-2005.05	Hatchback Engine Y17DT With ABS		◦	GHA400064	K
	2000.02-2005.05	Hatchback Engine Y17DT Without ABS	•		GHA333036	K
	2000.02-2005.05	Hatchback Engine Y17DT Without ABS		◦	GHA400058	K
	2000.02-2005.05	Saloon Engine Y17DT With ABS	•		GHA333033	K
	2000.02-2005.05	Saloon Engine Y17DT With ABS		◦	GHA400064	K
	2000.02-2005.05	Saloon Engine Y17DT Without ABS	•		GHA333036	K
	2000.02-2005.05	Saloon Engine Y17DT Without ABS		◦	GHA400058	K
1.7 TD (50 kW)	1998.02-2000.08	Estate Engine X17DTL With ABS	•		GHA333033	K
	1998.02-2000.08	Estate Engine X17DTL With ABS		◦	GHA400064	K
	1998.02-2000.08	Estate Engine X17DTL Without ABS	•		GHA333036	K
	1998.02-2000.08	Estate Engine X17DTL Without ABS		◦	GHA400058	K
	1998.02-2000.08	Hatchback Engine X17DTL With ABS	•		GHA333033	K
	1998.02-2000.08	Hatchback Engine X17DTL With ABS		◦	GHA400064	K
	1998.02-2000.08	Hatchback Engine X17DTL Without ABS	•		GHA333036	K
	1998.02-2000.08	Hatchback Engine X17DTL Without ABS		◦	GHA400058	K
	1998.09-2000.08	Saloon Engine X17DTL With ABS	•		GHA333033	K
	1998.09-2000.08	Saloon Engine X17DTL With ABS		◦	GHA400064	K
	1998.09-2000.08	Saloon Engine X17DTL Without ABS	•		GHA333036	K
	1998.09-2000.08	Saloon Engine X17DTL Without ABS		◦	GHA400058	K
1.8 16V (85 kW)	1998.02-2000.08	Estate Engine X18XE1 With ABS	•		GHA333029	K
	1998.02-2000.08	Estate Engine X18XE1 With ABS		◦	GHA400052	K
	1998.02-2000.08	Estate Engine X18XE1 Without ABS	•		GHA333036	K
	1998.02-2000.08	Estate Engine X18XE1 Without ABS		◦	GHA400058	K



	 YEAR		F	R	G-AP Ref.	KIT
VAUXHALL						
ASTRA IV (G)						
1.8 16V (85 kW)	1998.02-2000.09	Hatchback Engine X18XE1 With ABS	•		GHA333029	K
	1998.02-2000.09	Hatchback Engine X18XE1 With ABS		◦	GHA400052	K
	1998.02-2000.09	Hatchback Engine X18XE1 Without ABS	•		GHA333036	K
	1998.02-2000.09	Hatchback Engine X18XE1 Without ABS		◦	GHA400058	K
	1998.02-2004.07	Saloon Engine X18XE1 With ABS	•		GHA333029	K
	1998.02-2004.07	Saloon Engine X18XE1 With ABS		◦	GHA400052	K
	1998.02-2004.07	Saloon Engine X18XE1 Without ABS	•		GHA333036	K
	1998.02-2004.07	Saloon Engine X18XE1 Without ABS		◦	GHA400058	K
1.8 16V (92 kW)	1998.02-2004.07	Saloon Engine Z18XE With ABS	•		GHA333029	K
	1998.02-2004.07	Saloon Engine Z18XE With ABS		◦	GHA400052	K
	1998.02-2004.07	Saloon Engine Z18XE Without ABS	•		GHA333036	K
	1998.02-2004.07	Saloon Engine Z18XE Without ABS		◦	GHA400058	K
	2000.09-2005.05	Estate Engine Z18XE With ABS	•		GHA333029	K
	2000.09-2005.05	Estate Engine Z18XE With ABS		◦	GHA400052	K
	2000.09-2005.05	Estate Engine Z18XE Without ABS	•		GHA333036	K
	2000.09-2005.05	Estate Engine Z18XE Without ABS		◦	GHA400058	K
	2000.09-2005.05	Hatchback Engine Z18XE With ABS	•		GHA333029	K
	2000.09-2005.05	Hatchback Engine Z18XE With ABS		◦	GHA400052	K
	2000.09-2005.05	Hatchback Engine Z18XE Without ABS	•		GHA333036	K
	2000.09-2005.05	Hatchback Engine Z18XE Without ABS		◦	GHA400058	K
	2001.03-2005.10	Convertible Engine Z18XE	•		GHA333102	K
	2001.03-2005.10	Convertible Engine Z18XE With ABS	•		GHA333029	K
	2001.03-2005.10	Convertible Engine Z18XE With ABS		◦	GHA400052	K
	2001.03-2005.10	Convertible Engine Z18XE Without ABS		◦	GHA400053	K
1.8 16V Dualfuel (87 kW)	1998.02-2004.07	Saloon Engine Z18XE With ABS	•		GHA333029	K
	1998.02-2004.07	Saloon Engine Z18XE With ABS		◦	GHA400052	K
	1998.02-2004.07	Saloon Engine Z18XE Without ABS	•		GHA333036	K
	1998.02-2004.07	Saloon Engine Z18XE Without ABS		◦	GHA400058	K
	2002.09-2005.05	Estate Engine Z18XE With ABS	•		GHA333029	K
	2002.09-2005.05	Estate Engine Z18XE With ABS		◦	GHA400052	K
	2002.09-2005.05	Estate Engine Z18XE Without ABS	•		GHA333036	K
	2002.09-2005.05	Estate Engine Z18XE Without ABS		◦	GHA400058	K
	2002.09-2005.05	Hatchback Engine Z18XE With ABS	•		GHA333029	K
	2002.09-2005.05	Hatchback Engine Z18XE With ABS		◦	GHA400052	K
	2002.09-2005.05	Hatchback Engine Z18XE Without ABS	•		GHA333036	K
	2002.09-2005.05	Hatchback Engine Z18XE Without ABS		◦	GHA400058	K
2.0 (118 kW)	1999.10-2000.08	Hatchback Engine X20XER With ABS	•		GHA333029	K
	1999.10-2000.08	Hatchback Engine X20XER With ABS		◦	GHA400052	K
2.0 (147 kW)	2002.09-2006.07	Convertible Engine Z20LET With ABS	•		GHA333029	K
	2002.09-2006.07	Convertible Engine Z20LET With ABS		◦	GHA400052	K
2.0 16V (100 kW)	1998.02-2005.05	Estate Engine X20XEV	•		GHA333102	K
	1998.02-2005.05	Estate Engine X20XEV With ABS	•		GHA333029	K
	1998.02-2005.05	Estate Engine X20XEV With ABS		◦	GHA400052	K
	1998.02-2005.05	Estate Engine X20XEV Without ABS		◦	GHA400053	K
	1998.02-2005.05	Hatchback Engine X20XEV	•		GHA333102	K
	1998.02-2005.05	Hatchback Engine X20XEV With ABS	•		GHA333029	K
	1998.02-2005.05	Hatchback Engine X20XEV With ABS		◦	GHA400052	K
	1998.02-2005.05	Hatchback Engine X20XEV Without ABS		◦	GHA400053	K
	1998.09-2005.05	Saloon Engine X20XEV	•		GHA333102	K
	1998.09-2005.05	Saloon Engine X20XEV With ABS	•		GHA333029	K
	1998.09-2005.05	Saloon Engine X20XEV With ABS		◦	GHA400052	K
	1998.09-2005.05	Saloon Engine X20XEV Without ABS		◦	GHA400053	K
2.0 16V (118 kW)	1999.10-2005.05	Estate Engine X20XER With ABS	•		GHA333029	K
	1999.10-2005.05	Estate Engine X20XER With ABS		◦	GHA400052	K
	1999.10-2005.05	Saloon Engine X20XER With ABS	•		GHA333029	K
	1999.10-2005.05	Saloon Engine X20XER With ABS		◦	GHA400052	K
2.0 Di (60 kW)	1998.02-2004.07	Saloon Engine X20DTL/Y20DTL With ABS	•		GHA333029	K
	1998.02-2004.07	Saloon Engine X20DTL/Y20DTL With ABS		◦	GHA400052	K
	1998.02-2004.07	Saloon Engine X20DTL/Y20DTL Without ABS	•		GHA333036	K
	1998.02-2004.07	Saloon Engine X20DTL/Y20DTL Without ABS		◦	GHA400058	K
	1998.02-2005.05	Hatchback Engine X20DTL/Y20DTL With ABS	•		GHA333029	K
	1998.02-2005.05	Hatchback Engine X20DTL/Y20DTL With ABS		◦	GHA400052	K
	1998.02-2005.05	Hatchback Engine X20DTL/Y20DTL Without ABS	•		GHA333036	K
	1998.02-2005.05	Hatchback Engine X20DTL/Y20DTL Without ABS		◦	GHA400058	K



	 YEAR		F	R	G-AP Ref.	KIT
VAUXHALL						
ASTRA IV (G)						
2.0 Di (60 kW)	1998.03-2004.04	Estate Engine X20DTL/Y20DTL With ABS	•		GHA333029	K
	1998.03-2004.04	Estate Engine X20DTL/Y20DTL With ABS		◦	GHA400052	K
	1998.03-2004.04	Estate Engine X20DTL/Y20DTL Without ABS	•		GHA333036	K
	1998.03-2004.04	Estate Engine X20DTL/Y20DTL Without ABS		◦	GHA400058	K
2.0 DTi 16V (74 kW)	1998.02-2004.07	Saloon Engine X20DTH/Y20DTH	•		GHA333102	K
	1998.02-2004.07	Saloon Engine X20DTH/Y20DTH With ABS	•		GHA333029	K
	1998.02-2004.07	Saloon Engine X20DTH/Y20DTH With ABS		◦	GHA400052	K
	1998.02-2004.07	Saloon Engine X20DTH/Y20DTH Without ABS		◦	GHA400053	K
	1998.03-2004.04	Estate Engine X20DTH/Y20DTH	•		GHA333102	K
	1998.03-2004.04	Estate Engine X20DTH/Y20DTH With ABS	•		GHA333029	K
	1998.03-2004.04	Estate Engine X20DTH/Y20DTH With ABS		◦	GHA400052	K
	1998.03-2004.04	Estate Engine X20DTH/Y20DTH Without ABS		◦	GHA400053	K
	1999.08-2005.05	Hatchback Engine X20DTH/Y20DTH	•		GHA333102	K
	1999.08-2005.05	Hatchback Engine X20DTH/Y20DTH With ABS	•		GHA333029	K
	1999.08-2005.05	Hatchback Engine X20DTH/Y20DTH With ABS		◦	GHA400052	K
	1999.08-2005.05	Hatchback Engine X20DTH/Y20DTH Without ABS		◦	GHA400053	K
2.0 SRI Turbo (141 kW)	2002.07-2005.05	Hatchback Engine Z20LET	•		GHA333102	K
	2002.07-2005.05	Hatchback Engine Z20LET With ABS	•		GHA333029	K
	2002.07-2005.05	Hatchback Engine Z20LET With ABS		◦	GHA400052	K
	2002.07-2005.05	Hatchback Engine Z20LET Without ABS		◦	GHA400053	K
2.0 Turbo (141 kW)	2002.03-2005.10	Convertible Engine Z20LET With ABS	•		GHA333029	K
	2002.03-2005.10	Convertible Engine Z20LET With ABS		◦	GHA400052	K
2.2 16V (108 kW)	2001.03-2005.05	Estate Engine Z22SE	•		GHA333102	K
	2001.03-2005.05	Estate Engine Z22SE With ABS	•		GHA333029	K
	2001.03-2005.05	Estate Engine Z22SE With ABS		◦	GHA400052	K
	2001.03-2005.05	Estate Engine Z22SE Without ABS		◦	GHA400053	K
	2001.03-2005.05	Hatchback Engine Z22SE	•		GHA333102	K
	2001.03-2005.05	Hatchback Engine Z22SE With ABS	•		GHA333029	K
	2001.03-2005.05	Hatchback Engine Z22SE With ABS		◦	GHA400052	K
	2001.03-2005.05	Hatchback Engine Z22SE Without ABS		◦	GHA400053	K
	2001.03-2005.05	Saloon Engine Z22SE	•		GHA333102	K
	2001.03-2005.05	Saloon Engine Z22SE With ABS	•		GHA333029	K
	2001.03-2005.05	Saloon Engine Z22SE With ABS		◦	GHA400052	K
	2001.03-2005.05	Saloon Engine Z22SE Without ABS		◦	GHA400053	K
	2001.03-2005.10	Convertible Engine Z22SE With ABS	•		GHA333029	K
	2001.03-2005.10	Convertible Engine Z22SE With ABS		◦	GHA400052	K
2.2 DTi (92 kW)	2002.09-2005.05	Saloon Engine Y22DTR With ABS	•		GHA333029	K
	2002.09-2005.05	Saloon Engine Y22DTR With ABS		◦	GHA400052	K
ASTRA IV (G) (F67)						
1.6 16V (76 kW)	2000.03-2005.08	Coupe Engine Z16XEP With ABS	•		GHA333033	K
	2000.03-2005.08	Coupe Engine Z16XEP With ABS		◦	GHA400064	K
	2000.03-2005.08	Coupe Engine Z16XEP Without ABS	•		GHA333036	K
	2000.03-2005.08	Coupe Engine Z16XEP Without ABS		◦	GHA400058	K
1.8 16V (85 kW)	2000.03-2005.08	Coupe Engine X18XE1/Z18XEL	•		GHA333102	K
	2000.03-2005.08	Coupe Engine X18XE1/Z18XEL With ABS	•		GHA333029	K
	2000.03-2005.08	Coupe Engine X18XE1/Z18XEL With ABS		◦	GHA400052	K
	2000.03-2005.08	Coupe Engine X18XE1/Z18XEL Without ABS		◦	GHA400053	K
1.8 16V (92 kW)	2000.09-2005.08	Coupe Engine Z18XE	•		GHA333102	K
	2000.09-2005.08	Coupe Engine Z18XE With ABS	•		GHA333029	K
	2000.09-2005.08	Coupe Engine Z18XE With ABS		◦	GHA400052	K
	2000.09-2005.08	Coupe Engine Z18XE Without ABS		◦	GHA400053	K
1.8 16V Dualfuel (87 kW)	2002.09-2005.08	Coupe Engine Z18XE	•		GHA333102	K
	2002.09-2005.08	Coupe Engine Z18XE With ABS	•		GHA333029	K
	2002.09-2005.08	Coupe Engine Z18XE With ABS		◦	GHA400052	K
	2002.09-2005.08	Coupe Engine Z18XE Without ABS		◦	GHA400053	K
2.0 (147 kW)	2002.08-2005.05	Coupe Engine Z20LET With ABS	•		GHA333029	K
	2002.08-2005.05	Coupe Engine Z20LET With ABS		◦	GHA400052	K
2.0 16V Turbo (140 kW)	2000.09-2005.08	Coupe Engine Z20LET With ABS	•		GHA333029	K
	2000.09-2005.08	Coupe Engine Z20LET With ABS		◦	GHA400052	K
2.2 16V (108 kW)	2000.03-2005.08	Coupe Engine Z22SE	•		GHA333102	K
	2000.03-2005.08	Coupe Engine Z22SE With ABS	•		GHA333029	K
	2000.03-2005.08	Coupe Engine Z22SE With ABS		◦	GHA400052	K
	2000.03-2005.08	Coupe Engine Z22SE Without ABS		◦	GHA400053	K



	 YEAR		F	R	G-AP Ref.	KIT
VAUXHALL						
ASTRA MK VI (J)						
1.4 Turbo (88 kW)	2010.10-	Estate Engine A 14 NEL Fits Rim Size 15(Inch)	•		GHA333080	K
	2010.10-	Estate Engine A 14 NEL Fits Rim Size 15(Inch)		◦	GHA400164	K
1.6 SiDi (125 kW)	2012.12-	Estate Engine A16XHT	•		GHA3330019	K
	2012.12-	Hatchback Engine A16XHT	•		GHA3330019	K
	2012.12-	Saloon Engine A16XHT	•		GHA3330019	K
2.0 BiTurbo CDTi (143 kW)	2012.12-	Estate Engine A 20 DTR	•		GHA3330019	K
	2012.12-	Saloon Engine A 20 DTR	•		GHA3330019	K
ASTRA TWINTOP V (H)						
1.6 (132 kW)	2006.10-2010.11	Convertible Engine Z16LET	•		GHA333069	K
	2006.10-2010.11	Convertible Engine Z16LET	•		GHA333070	K
	2006.10-2010.11	Convertible Engine Z16LET		◦	GHA400133	K
	2006.10-2010.11	Convertible Engine Z16LET		◦	GHA400153	K
1.6 (77 kW)	2005.09-2010.11	Convertible Engine Z16XEP	•		GHA333069	K
	2005.09-2010.11	Convertible Engine Z16XEP	•		GHA333070	K
	2005.09-2010.11	Convertible Engine Z16XEP		◦	GHA400133	K
	2005.09-2010.11	Convertible Engine Z16XEP		◦	GHA400153	K
1.6 i 16V (85 kW)	2006.10-2010.11	Convertible Engine Z16XER	•		GHA333069	K
	2006.10-2010.11	Convertible Engine Z16XER	•		GHA333070	K
	2006.10-2010.11	Convertible Engine Z16XER		◦	GHA400133	K
	2006.10-2010.11	Convertible Engine Z16XER		◦	GHA400153	K
1.8 (103 kW)	2008.05-2010.11	Convertible Engine Z18XER	•		GHA333069	K
	2008.05-2010.11	Convertible Engine Z18XER	•		GHA333070	K
	2008.05-2010.11	Convertible Engine Z18XER		◦	GHA400133	K
	2008.05-2010.11	Convertible Engine Z18XER		◦	GHA400153	K
1.9 CDTi (110 kW)	2006.01-2010.11	Convertible Engine Z19DTH	•		GHA3330013	K
	2006.01-2010.11	Convertible Engine Z19DTH	•		GHA333069	K
	2006.01-2010.11	Convertible Engine Z19DTH		◦	GHA400133	K
	2006.01-2010.11	Convertible Engine Z19DTH		◦	GHA400153	K
2.0 (125 kW)	2006.02-2010.11	Convertible Engine Z20LEL	•		GHA333069	K
	2006.02-2010.11	Convertible Engine Z20LEL	•		GHA333070	K
	2006.02-2010.11	Convertible Engine Z20LEL	•		GHA333097	K
	2006.02-2010.11	Convertible Engine Z20LEL		◦	GHA400133	K
	2006.02-2010.11	Convertible Engine Z20LEL		◦	GHA400153	K
2.0 Turbo (147 kW)	2006.01-2010.11	Convertible Engine Z20LER	•		GHA333069	K
	2006.01-2010.11	Convertible Engine Z20LER	•		GHA333070	K
	2006.01-2010.11	Convertible Engine Z20LER	•		GHA333097	K
	2006.01-2010.11	Convertible Engine Z20LER		◦	GHA400133	K
	2006.01-2010.11	Convertible Engine Z20LER		◦	GHA400153	K
ASTRA V (H)						
1.3 CDTi (66 kW)	2004.01-2009.05	Hatchback Engine Z13DTH	•		GHA333069	K
	2004.01-2009.05	Hatchback Engine Z13DTH	•		GHA333070	K
	2004.01-2009.05	Hatchback Engine Z13DTH		◦	GHA400133	K
	2004.01-2009.05	Hatchback Engine Z13DTH		◦	GHA400153	K
	2004.08-2009.03	Estate Engine Z13DTH	•		GHA333069	K
	2004.08-2009.03	Estate Engine Z13DTH	•		GHA333070	K
	2004.08-2009.03	Estate Engine Z13DTH		◦	GHA400133	K
	2004.08-2009.03	Estate Engine Z13DTH		◦	GHA400153	K
1.4 (55 kW)	2004.04-2005.12	Hatchback Engine Z14XEL	•		GHA333069	K
	2004.04-2005.12	Hatchback Engine Z14XEL	•		GHA333070	K
	2004.04-2005.12	Hatchback Engine Z14XEL		◦	GHA400133	K
	2004.04-2005.12	Hatchback Engine Z14XEL		◦	GHA400153	K
	2004.08-2010.10	Estate Engine Z14XEL	•		GHA333069	K
	2004.08-2010.10	Estate Engine Z14XEL	•		GHA333070	K
	2004.08-2010.10	Estate Engine Z14XEL		◦	GHA400133	K
	2004.08-2010.10	Estate Engine Z14XEL		◦	GHA400153	K
1.4 (66 kW)	2004.01-2009.05	Hatchback Engine Z14XEP	•		GHA333069	K
	2004.01-2009.05	Hatchback Engine Z14XEP	•		GHA333070	K
	2004.01-2009.05	Hatchback Engine Z14XEP		◦	GHA400133	K
	2004.01-2009.05	Hatchback Engine Z14XEP		◦	GHA400153	K
	2004.08-2009.03	Estate Engine Z14XEP	•		GHA333069	K
	2004.08-2009.03	Estate Engine Z14XEP	•		GHA333070	K
	2004.08-2009.03	Estate Engine Z14XEP		◦	GHA400133	K
	2004.08-2009.03	Estate Engine Z14XEP		◦	GHA400153	K
	2004.08-2009.03	Estate Engine Z14XEP		◦	GHA400153	K
1.6 (132 kW)	2004.08-2009.03	Estate Engine Z16LET	•		GHA333069	K



	 YEAR		F	R	G-AP Ref.	KIT
VAUXHALL						
ASTRA V (H)						
1.6 (132 kW)	2004.08-2009.03	Estate Engine Z16LET	•		GHA333070	K
	2004.08-2009.03	Estate Engine Z16LET		◦	GHA400133	K
	2004.08-2009.03	Estate Engine Z16LET		◦	GHA400153	K
1.6 (77 kW)	2004.01-2009.05	Hatchback Engine Z16XEP	•		GHA333069	K
	2004.01-2009.05	Hatchback Engine Z16XEP	•		GHA333070	K
	2004.01-2009.05	Hatchback Engine Z16XEP		◦	GHA400133	K
	2004.01-2009.05	Hatchback Engine Z16XEP		◦	GHA400153	K
	2004.08-2009.03	Estate Engine Z16XEP	•		GHA333069	K
	2004.08-2009.03	Estate Engine Z16XEP	•		GHA333070	K
	2004.08-2009.03	Estate Engine Z16XEP		◦	GHA400133	K
	2004.08-2009.03	Estate Engine Z16XEP		◦	GHA400153	K
1.6 (85 kW)	2004.01-2009.05	Hatchback Engine Z16XER	•		GHA333069	K
	2004.01-2009.05	Hatchback Engine Z16XER	•		GHA333070	K
	2004.01-2009.05	Hatchback Engine Z16XER		◦	GHA400133	K
	2004.01-2009.05	Hatchback Engine Z16XER		◦	GHA400153	K
	2004.08-2009.03	Estate Engine A16XER/Z16XER	•		GHA333069	K
	2004.08-2009.03	Estate Engine A16XER/Z16XER	•		GHA333070	K
	2004.08-2009.03	Estate Engine A16XER/Z16XER		◦	GHA400133	K
	2004.08-2009.03	Estate Engine A16XER/Z16XER		◦	GHA400153	K
1.6 Turbo (132 kW)	2006.09-	Hatchback Engine Z16LET	•		GHA333069	K
	2006.09-	Hatchback Engine Z16LET	•		GHA333070	K
	2006.09-	Hatchback Engine Z16LET		◦	GHA400133	K
	2006.09-	Hatchback Engine Z16LET		◦	GHA400153	K
1.7 CDTi (59 kW)	2004.01-2009.05	Hatchback Engine Z17DTL	•		GHA333069	K
	2004.01-2009.05	Hatchback Engine Z17DTL	•		GHA333070	K
	2004.01-2009.05	Hatchback Engine Z17DTL		◦	GHA400133	K
	2004.01-2009.05	Hatchback Engine Z17DTL		◦	GHA400153	K
	2004.08-2009.05	Estate Engine Z17DTL	•		GHA333069	K
	2004.08-2009.05	Estate Engine Z17DTL	•		GHA333070	K
	2004.08-2009.05	Estate Engine Z17DTL		◦	GHA400133	K
1.7 CDTi (74 kW)	2004.01-2009.05	Hatchback Engine Z17DTH	•		GHA333069	K
	2004.01-2009.05	Hatchback Engine Z17DTH	•		GHA333070	K
	2004.01-2009.05	Hatchback Engine Z17DTH		◦	GHA400133	K
	2004.01-2009.05	Hatchback Engine Z17DTH		◦	GHA400153	K
	2004.08-2009.03	Estate Engine Z17DTH	•		GHA333069	K
	2004.08-2009.03	Estate Engine Z17DTH	•		GHA333070	K
	2004.08-2009.03	Estate Engine Z17DTH		◦	GHA400133	K
1.7 CDTi (81 kW)	2004.01-2009.05	Hatchback Engine A17DTJ/Z17DTJ	•		GHA333069	K
	2004.01-2009.05	Hatchback Engine A17DTJ/Z17DTJ	•		GHA333070	K
	2004.01-2009.05	Hatchback Engine A17DTJ/Z17DTJ		◦	GHA400133	K
	2004.01-2009.05	Hatchback Engine A17DTJ/Z17DTJ		◦	GHA400153	K
	2004.08-2009.03	Estate Engine A17DTJ/Z17DTJ	•		GHA333069	K
	2004.08-2009.03	Estate Engine A17DTJ/Z17DTJ	•		GHA333070	K
	2004.08-2009.03	Estate Engine A17DTJ/Z17DTJ		◦	GHA400133	K
	2004.08-2009.03	Estate Engine A17DTJ/Z17DTJ		◦	GHA400153	K
1.7 CDTi (92 kW)	2007.02-2009.09	Hatchback Engine A17DTR/Z17DTR	•		GHA333069	K
	2007.02-2009.09	Hatchback Engine A17DTR/Z17DTR	•		GHA333097	K
	2007.02-2009.09	Hatchback Engine A17DTR/Z17DTR		◦	GHA400133	K
	2007.02-2009.09	Hatchback Engine A17DTR/Z17DTR		◦	GHA400153	K
	2007.02-2010.10	Estate Engine A17DTR/Z17DTR	•		GHA333069	K
	2007.02-2010.10	Estate Engine A17DTR/Z17DTR	•		GHA333097	K
	2007.02-2010.10	Estate Engine A17DTR/Z17DTR		◦	GHA400133	K
1.7 TD (79 kW)	2004.01-2009.05	Hatchback	•		GHA333069	K
	2004.01-2009.05	Hatchback	•		GHA333070	K
	2004.01-2009.05	Hatchback		◦	GHA400133	K
	2004.01-2009.05	Hatchback		◦	GHA400153	K
	2004.08-2009.03	Estate	•		GHA333069	K
	2004.08-2009.03	Estate	•		GHA333070	K
	2004.08-2009.03	Estate		◦	GHA400133	K
1.8 (103 kW)	2004.01-2009.05	Hatchback Engine A18XER/Z18XER	•		GHA333069	K



	 YEAR		F	R	G-AP Ref.	KIT
VAUXHALL						
ASTRA V (H)						
1.8 (103 kW)	2004.01-2009.05	Hatchback Engine A18XER/Z18XER	•		GHA333070	K
	2004.01-2009.05	Hatchback Engine A18XER/Z18XER		◦	GHA400133	K
	2004.01-2009.05	Hatchback Engine A18XER/Z18XER		◦	GHA400153	K
	2004.10-2009.03	Estate Engine A18XER/Z18XER	•		GHA333069	K
	2004.10-2009.03	Estate Engine A18XER/Z18XER	•		GHA333070	K
	2004.10-2009.03	Estate Engine A18XER/Z18XER		◦	GHA400133	K
	2004.10-2009.03	Estate Engine A18XER/Z18XER		◦	GHA400153	K
1.8 (92 kW)	2004.01-2009.05	Hatchback Engine Z18XE	•		GHA333069	K
	2004.01-2009.05	Hatchback Engine Z18XE	•		GHA333070	K
	2004.01-2009.05	Hatchback Engine Z18XE		◦	GHA400133	K
	2004.01-2009.05	Hatchback Engine Z18XE		◦	GHA400153	K
	2004.10-2009.03	Estate Engine Z18XE	•		GHA333069	K
	2004.10-2009.03	Estate Engine Z18XE	•		GHA333070	K
	2004.10-2009.03	Estate Engine Z18XE		◦	GHA400133	K
1.9 CDTi (110 kW)	2004.01-2009.05	Hatchback Engine Z19DTH	•		GHA330013	K
	2004.01-2009.05	Hatchback Engine Z19DTH	•		GHA333069	K
	2004.01-2009.05	Hatchback Engine Z19DTH		◦	GHA400133	K
	2004.01-2009.05	Hatchback Engine Z19DTH		◦	GHA400153	K
	2004.08-2009.03	Estate Engine Z19DTH	•		GHA330013	K
	2004.08-2009.03	Estate Engine Z19DTH	•		GHA333069	K
	2004.08-2009.03	Estate Engine Z19DTH		◦	GHA400133	K
1.9 CDTi (74 kW)	2004.08-2009.03	Estate Engine Z19DTL	•		GHA333069	K
	2004.08-2009.03	Estate Engine Z19DTL	•		GHA333070	K
	2004.08-2009.03	Estate Engine Z19DTL	•		GHA333097	K
	2004.08-2009.03	Estate Engine Z19DTL		◦	GHA400133	K
	2004.08-2009.03	Estate Engine Z19DTL		◦	GHA400153	K
1.9 CDTi (88 kW)	2004.01-2009.05	Hatchback Engine Z19DT	•		GHA333069	K
	2004.01-2009.05	Hatchback Engine Z19DT	•		GHA333070	K
	2004.01-2009.05	Hatchback Engine Z19DT	•		GHA333097	K
	2004.01-2009.05	Hatchback Engine Z19DT		◦	GHA400133	K
	2004.01-2009.05	Hatchback Engine Z19DT		◦	GHA400153	K
	2004.08-2009.03	Estate Engine Z19DT	•		GHA333069	K
	2004.08-2009.03	Estate Engine Z19DT	•		GHA333070	K
	2004.08-2009.03	Estate Engine Z19DT	•		GHA333097	K
	2004.08-2009.03	Estate Engine Z19DT		◦	GHA400133	K
	2004.08-2009.03	Estate Engine Z19DT		◦	GHA400153	K
1.9 CDTi 16V (88 kW)	2004.01-2009.05	Hatchback Engine Z19DTJ	•		GHA333069	K
	2004.01-2009.05	Hatchback Engine Z19DTJ	•		GHA333070	K
	2004.01-2009.05	Hatchback Engine Z19DTJ	•		GHA333097	K
	2004.01-2009.05	Hatchback Engine Z19DTJ		◦	GHA400133	K
	2004.01-2009.05	Hatchback Engine Z19DTJ		◦	GHA400153	K
2.0 Turbo (125 kW)	2004.01-2009.05	Hatchback Engine Z20LEL	•		GHA333069	K
	2004.01-2009.05	Hatchback Engine Z20LEL	•		GHA333070	K
	2004.01-2009.05	Hatchback Engine Z20LEL	•		GHA333097	K
	2004.01-2009.05	Hatchback Engine Z20LEL		◦	GHA400133	K
	2004.01-2009.05	Hatchback Engine Z20LEL		◦	GHA400153	K
	2004.08-2010.10	Estate Engine Z20LEL	•		GHA333069	K
	2004.08-2010.10	Estate Engine Z20LEL	•		GHA333070	K
	2004.08-2010.10	Estate Engine Z20LEL	•		GHA333097	K
	2004.08-2010.10	Estate Engine Z20LEL		◦	GHA400133	K
	2004.08-2010.10	Estate Engine Z20LEL		◦	GHA400153	K
2.0 Turbo (147 kW)	2004.01-2009.05	Hatchback Engine Z20LER	•		GHA333069	K
	2004.01-2009.05	Hatchback Engine Z20LER	•		GHA333070	K
	2004.01-2009.05	Hatchback Engine Z20LER	•		GHA333097	K
	2004.01-2009.05	Hatchback Engine Z20LER		◦	GHA400133	K
	2004.01-2009.05	Hatchback Engine Z20LER		◦	GHA400153	K
	2004.08-2010.10	Estate Engine Z20LER	•		GHA333069	K
	2004.08-2010.10	Estate Engine Z20LER	•		GHA333070	K
	2004.08-2010.10	Estate Engine Z20LER	•		GHA333097	K
	2004.08-2010.10	Estate Engine Z20LER		◦	GHA400133	K
	2004.08-2010.10	Estate Engine Z20LER		◦	GHA400153	K
2.0 Turbo (177 kW)	2004.01-2009.05	Hatchback Engine Z20LEH	•		GHA330013	K



	 YEAR		F	R	G-AP Ref.	KIT
VAUXHALL						
ASTRA V (H)						
2.0 Turbo (177 kW)	2004.01-2009.05	Hatchback Engine Z20LEH	•		GHA333069	K
	2004.01-2009.05	Hatchback Engine Z20LEH		◦	GHA400133	K
	2004.01-2009.05	Hatchback Engine Z20LEH		◦	GHA400153	K
ASTRA V (H) SPORT HATCH						
1.3 CDTi (66 kW)	2005.04-2010.11	Hatchback Engine Z13DTH	•		GHA333069	K
	2005.04-2010.11	Hatchback Engine Z13DTH	•		GHA333070	K
	2005.04-2010.11	Hatchback Engine Z13DTH		◦	GHA400133	K
	2005.04-2010.11	Hatchback Engine Z13DTH		◦	GHA400153	K
1.4 (55 kW)	2005.02-2010.11	Hatchback Engine Z14XEL	•		GHA333069	K
	2005.02-2010.11	Hatchback Engine Z14XEL	•		GHA333070	K
	2005.02-2010.11	Hatchback Engine Z14XEL		◦	GHA400133	K
	2005.02-2010.11	Hatchback Engine Z14XEL		◦	GHA400153	K
1.4 i 16V (66 kW)	2005.03-2010.11	Hatchback Engine Z14XEP	•		GHA333069	K
	2005.03-2010.11	Hatchback Engine Z14XEP	•		GHA333070	K
	2005.03-2010.11	Hatchback Engine Z14XEP		◦	GHA400133	K
	2005.03-2010.11	Hatchback Engine Z14XEP		◦	GHA400153	K
1.6 (132 kW)	2006.10-2010.11	Hatchback Engine Z16LET	•		GHA333069	K
	2006.10-2010.11	Hatchback Engine Z16LET	•		GHA333070	K
	2006.10-2010.11	Hatchback Engine Z16LET		◦	GHA400133	K
	2006.10-2010.11	Hatchback Engine Z16LET		◦	GHA400153	K
1.6 (77 kW)	2005.02-2010.11	Hatchback Engine Z16XEP	•		GHA333069	K
	2005.02-2010.11	Hatchback Engine Z16XEP	•		GHA333070	K
	2005.02-2010.11	Hatchback Engine Z16XEP		◦	GHA400133	K
	2005.02-2010.11	Hatchback Engine Z16XEP		◦	GHA400153	K
1.6 i 16V (85 kW)	2006.12-2010.11	Hatchback Engine Z16XER	•		GHA333069	K
	2006.12-2010.11	Hatchback Engine Z16XER	•		GHA333070	K
	2006.12-2010.11	Hatchback Engine Z16XER		◦	GHA400133	K
	2006.12-2010.11	Hatchback Engine Z16XER		◦	GHA400153	K
1.7 CDTi (74 kW)	2005.02-2010.11	Hatchback Engine Z17DTH	•		GHA333069	K
	2005.02-2010.11	Hatchback Engine Z17DTH	•		GHA333070	K
	2005.02-2010.11	Hatchback Engine Z17DTH		◦	GHA400133	K
	2005.02-2010.11	Hatchback Engine Z17DTH		◦	GHA400153	K
1.7 CDTi (81 kW)	2007.02-2010.11	Hatchback Engine A17DTJ	•		GHA333069	K
	2007.02-2010.11	Hatchback Engine A17DTJ	•		GHA333097	K
	2007.02-2010.11	Hatchback Engine A17DTJ		◦	GHA400133	K
	2007.02-2010.11	Hatchback Engine A17DTJ		◦	GHA400153	K
1.7 CDTi (92 kW)	2007.02-	Hatchback Engine Z17DTR	•		GHA333069	K
	2007.02-	Hatchback Engine Z17DTR	•		GHA333097	K
	2007.02-	Hatchback Engine Z17DTR		◦	GHA400133	K
	2007.02-	Hatchback Engine Z17DTR		◦	GHA400153	K
1.8 (92 kW)	2005.02-2010.11	Hatchback Engine Z18XE	•		GHA333069	K
	2005.02-2010.11	Hatchback Engine Z18XE	•		GHA333070	K
	2005.02-2010.11	Hatchback Engine Z18XE		◦	GHA400133	K
	2005.02-2010.11	Hatchback Engine Z18XE		◦	GHA400153	K
1.8 i 16V (103 kW)	2007.03-2010.11	Hatchback Engine A18XER/Z18XER	•		GHA333069	K
	2007.03-2010.11	Hatchback Engine A18XER/Z18XER	•		GHA333070	K
	2007.03-2010.11	Hatchback Engine A18XER/Z18XER		◦	GHA400133	K
	2007.03-2010.11	Hatchback Engine A18XER/Z18XER		◦	GHA400153	K
1.9 CDTi (110 kW)	2005.02-2010.11	Hatchback Engine Z19DTH	•		GHA330013	K
	2005.02-2010.11	Hatchback Engine Z19DTH	•		GHA333069	K
	2005.02-2010.11	Hatchback Engine Z19DTH		◦	GHA400133	K
	2005.02-2010.11	Hatchback Engine Z19DTH		◦	GHA400153	K
1.9 CDTi (74 kW)	2005.08-2010.11	Hatchback Engine Z19DTL	•		GHA333069	K
	2005.08-2010.11	Hatchback Engine Z19DTL	•		GHA333070	K
	2005.08-2010.11	Hatchback Engine Z19DTL	•		GHA333097	K
	2005.08-2010.11	Hatchback Engine Z19DTL		◦	GHA400133	K
	2005.08-2010.11	Hatchback Engine Z19DTL		◦	GHA400153	K
1.9 CDTi (88 kW)	2005.02-2010.11	Hatchback Engine Z19DT	•		GHA333069	K
	2005.02-2010.11	Hatchback Engine Z19DT	•		GHA333070	K
	2005.02-2010.11	Hatchback Engine Z19DT	•		GHA333097	K
	2005.02-2010.11	Hatchback Engine Z19DT		◦	GHA400133	K
	2005.02-2010.11	Hatchback Engine Z19DT		◦	GHA400153	K
2.0 Turbo (125 kW)	2005.02-2010.11	Hatchback Engine Z20LEL	•		GHA333069	K
	2005.02-2010.11	Hatchback Engine Z20LEL	•		GHA333070	K



	 YEAR		F	R	G-AP Ref.	KIT
VAUXHALL						
ASTRA V (H) SPORT HATCH						
2.0 Turbo (125 kW)	2005.02-2010.11	Hatchback Engine Z20LEL	•		GHA333097	K
	2005.02-2010.11	Hatchback Engine Z20LEL		◦	GHA400133	K
	2005.02-2010.11	Hatchback Engine Z20LEL		◦	GHA400153	K
2.0 VXR (176 kW)	2009.02-2010.11	Hatchback Engine Z20LEH	•		GHA330013	K
	2009.02-2010.11	Hatchback Engine Z20LEH		◦	GHA400133	K
ASTRA VI (J)						
1.3 CDTi (70 kW)	2009.12-	Hatchback Engine A13DTE Fits Rim Size 15(Inch)	•		GHA333080	K
	2009.12-	Hatchback Engine A13DTE Fits Rim Size 15(Inch)		◦	GHA400164	K
	2012.06-	Saloon Engine A13DTE Fits Rim Size 15(Inch)	•		GHA333080	K
	2012.06-	Saloon Engine A13DTE Fits Rim Size 15(Inch)		◦	GHA400164	K
1.4 (64 kW)	2009.12-	Hatchback Engine A14XEL Fits Rim Size 15(Inch)	•		GHA333080	K
	2009.12-	Hatchback Engine A14XEL Fits Rim Size 15(Inch)		◦	GHA400164	K
1.4 (74 kW)	2009.12-	Hatchback Engine A14XER Fits Rim Size 15(Inch)	•		GHA333080	K
	2009.12-	Hatchback Engine A14XER Fits Rim Size 15(Inch)		◦	GHA400164	K
	2012.06-	Saloon Engine A14XER Fits Rim Size 15(Inch)	•		GHA333080	K
	2012.06-	Saloon Engine A14XER Fits Rim Size 15(Inch)		◦	GHA400164	K
1.4 Turbo (103 kW)	2009.12-	Hatchback Engine A14NET Fits Rim Size 15(Inch)	•		GHA333080	K
	2009.12-	Hatchback Engine A14NET Fits Rim Size 15(Inch)		◦	GHA400164	K
	2012.06-	Saloon Engine A14NET Fits Rim Size 15(Inch)	•		GHA333080	K
	2012.06-	Saloon Engine A14NET Fits Rim Size 15(Inch)		◦	GHA400164	K
1.4 Turbo (88 kW)	2011.08-	Hatchback Engine A14NEL Fits Rim Size 15(Inch)	•		GHA333080	K
	2011.08-	Hatchback Engine A14NEL Fits Rim Size 15(Inch)		◦	GHA400164	K
1.6 (85 kW)	2009.12-	Hatchback Engine A16XER Fits Rim Size 15(Inch)	•		GHA333080	K
	2009.12-	Hatchback Engine A16XER Fits Rim Size 15(Inch)		◦	GHA400164	K
	2012.06-	Saloon Engine A16XER Fits Rim Size 15(Inch)	•		GHA333080	K
	2012.06-	Saloon Engine A16XER Fits Rim Size 15(Inch)		◦	GHA400164	K
1.6 Turbo (132 kW)	2009.12-	Hatchback Engine A16LET	•		GHA330019	K
	2009.12-	Hatchback Engine A16LET		◦	GHA400193	K
	2012.06-	Saloon Engine A16LET	•		GHA330019	K
	2012.06-	Saloon Engine A16LET		◦	GHA400193	K
1.7 CDTi (81 kW)	2009.12-	Hatchback Engine A17DTC/A17DTE/A17DTJ	•		GHA330019	K
	2009.12-	Hatchback Engine A17DTC/A17DTE/A17DTJ		◦	GHA400193	K
	2012.06-	Saloon Engine A17DTC/A17DTE/A17DTJ	•		GHA330019	K
	2012.06-	Saloon Engine A17DTC/A17DTE/A17DTJ		◦	GHA400193	K
1.7 CDTi (92 kW)	2009.12-	Hatchback Engine A17DTR	•		GHA330019	K
	2009.12-	Hatchback Engine A17DTR		◦	GHA400193	K
1.7 CDTi (96 kW)	2011.06-	Hatchback Engine A17DTF/A17DTS	•		GHA330019	K
	2011.06-	Hatchback Engine A17DTF/A17DTS		◦	GHA400193	K
	2012.06-	Saloon Engine A17DTF/A17DTS	•		GHA330019	K
	2012.06-	Saloon Engine A17DTF/A17DTS		◦	GHA400193	K
2.0 BiTurbo CDTi (143 kW)	2012.12-	Hatchback Engine A20DTR	•		GHA330019	K
	2012.12-	Hatchback Engine A20DTR		◦	GHA400193	K
2.0 CDTi (118 kW)	2009.12-	Hatchback Engine A20DTH	•		GHA330019	K
	2009.12-	Hatchback Engine A20DTH		◦	GHA400193	K
2.0 CDTi (121 kW)	2011.08-	Hatchback Engine A20DTH	•		GHA330019	K
	2011.08-	Hatchback Engine A20DTH		◦	GHA400193	K
ASTRA VI (J) SPORTS TOURER						
1.3 CDTi (70 kW)	2010.10-	Estate Engine A13DTE Fits Rim Size 15(Inch)	•		GHA333080	K
	2010.10-	Estate Engine A13DTE Fits Rim Size 15(Inch)		◦	GHA400164	K
1.4 (74 kW)	2010.10-	Estate Engine A14XER Fits Rim Size 15(Inch)	•		GHA333080	K
	2010.10-	Estate Engine A14XER Fits Rim Size 15(Inch)		◦	GHA400164	K
1.4 Turbo (103 kW)	2010.10-	Estate Engine A14NET Fits Rim Size 15(Inch)	•		GHA333080	K
	2010.10-	Estate Engine A14NET Fits Rim Size 15(Inch)		◦	GHA400164	K
1.6 (85 kW)	2010.10-	Estate Engine A16XER Fits Rim Size 15(Inch)	•		GHA333080	K
	2010.10-	Estate Engine A16XER Fits Rim Size 15(Inch)		◦	GHA400164	K
1.6 Turbo (132 kW)	2010.10-	Estate Engine A16LET	•		GHA330019	K
	2010.10-	Estate Engine A16LET		◦	GHA400193	K
1.7 CDTi (81 kW)	2010.10-	Estate Engine A17DTC/A17DTE/A17DTJ	•		GHA330019	K
	2010.10-	Estate Engine A17DTC/A17DTE/A17DTJ		◦	GHA400193	K
1.7 CDTi (92 kW)	2010.10-	Estate Engine A17DTR	•		GHA330019	K
	2010.10-	Estate Engine A17DTR		◦	GHA400193	K
1.7 CDTi (96 kW)	2011.06-	Estate Engine A17DTF/A17DTS	•		GHA330019	K
	2011.06-	Estate Engine A17DTF/A17DTS		◦	GHA400193	K
2.0 CDTi (118 kW)	2010.10-	Estate Engine A20DTH	•		GHA330019	K



	 YEAR		F	R	G-AP Ref.	KIT
VAUXHALL						
ASTRA VI (J) SPORTS TOURER						
2.0 CDTi (118 kW)	2010.10-	Estate Engine A20DTH		o	GHA400193	K
2.0 CDTi (121 kW)	2011.08-	Estate Engine A20DTH	•		GHA330019	K
	2011.08-	Estate Engine A20DTH		o	GHA400193	K
ASTRAMAX						
1.4 i (44 kW)	1991.08-1994.07	Box Engine C14NZ	•		GWB3256	
	1991.08-1994.07	Box Engine C14NZ	•		GWB3403	
	1991.08-1994.07	Box Engine C14NZ		o	GWB0526	
1.6 i (55 kW)	1991.08-1994.07	Box Engine C14NZ			GWB0663	
	1991.08-1994.10	Box Engine C16NZ	•		GWB3256	
	1991.08-1994.10	Box Engine C16NZ	•		GWB3403	
	1991.08-1994.10	Box Engine C16NZ		o	GWB0526	
	1991.08-1994.10	Box Engine C16NZ			GWB0663	
ASTRAVAN III (F)						
1.4 i (44 kW)	1991.01-1994.10	Box Engine C14NZ	•		GHA422006	K
	1991.01-1994.10	Box Engine C14NZ	•		GHA422023	
	1991.01-1994.10	Box Engine C14NZ	•		GWB3256	
	1991.01-1994.10	Box Engine C14NZ	•		GWB3403	
	1991.01-1994.10	Box Engine C14NZ			GWB0663	
	1991.01-1994.10	Box Engine C14NZ With ABS		o	GHA400064	K
	1991.01-1994.10	Box Engine C14NZ Without ABS		o	GHA400058	K
1.6 i (52 kW)	1994.02-1996.10	Box Engine X16SZ	•		GHA422006	K
	1994.02-1996.10	Box Engine X16SZ	•		GHA422023	
	1994.02-1996.10	Box Engine X16SZ	•		GWB0736	
	1994.02-1996.10	Box Engine X16SZ	•		GWB3403	
	1994.02-1996.10	Box Engine X16SZ With ABS		o	GHA400064	K
	1994.02-1996.10	Box Engine X16SZ Without ABS		o	GHA400058	K
1.6 i (55 kW)	1991.01-1998.08	Box Engine C16NZ	•		GHA422006	K
	1991.01-1998.08	Box Engine C16NZ	•		GHA422023	
	1991.01-1998.08	Box Engine C16NZ	•		GWB0736	
	1991.01-1998.08	Box Engine C16NZ	•		GWB3256	
	1991.01-1998.08	Box Engine C16NZ	•		GWB3403	
	1991.01-1998.08	Box Engine C16NZ	•		GWB3410	
	1991.01-1998.08	Box Engine C16NZ			GWB0663	
	1991.01-1998.08	Box Engine C16NZ With ABS		o	GHA400064	K
	1991.01-1998.08	Box Engine C16NZ Without ABS		o	GHA400058	K
1.7 D (44 kW)	1991.01-1994.08	Box Engine 17DR	•		GHA422023	
	1991.01-1994.08	Box Engine 17DR	•		GHA433007	
	1991.01-1994.08	Box Engine 17DR	•		GWB0736	
	1991.01-1994.08	Box Engine 17DR	•		GWB3410	
	1991.01-1994.08	Box Engine 17DR With ABS		o	GHA400064	K
	1991.01-1994.08	Box Engine 17DR Without ABS		o	GHA400058	K
1.7 TD (50 kW)	1994.01-1998.08	Box Engine X17DTL	•		GHA422023	
	1994.01-1998.08	Box Engine X17DTL	•		GWB0736	
	1994.01-1998.08	Box Engine X17DTL	•		GWB3410	
	1994.01-1998.08	Box Engine X17DTL With ABS		o	GHA400064	K
	1994.01-1998.08	Box Engine X17DTL Without ABS		o	GHA400058	K
ASTRAVAN IV (G)						
1.6 i (55 kW)	1998.08-2000.09	Box Engine X16SZR With ABS	•		GHA333033	K
	1998.08-2000.09	Box Engine X16SZR With ABS		o	GHA400064	K
	1998.08-2000.09	Box Engine X16SZR Without ABS	•		GHA333036	K
	1998.08-2000.09	Box Engine X16SZR Without ABS		o	GHA400058	K
1.6 i (62 kW)	2000.09-2006.08	Box Engine Z16SE With ABS	•		GHA333033	K
	2000.09-2006.08	Box Engine Z16SE With ABS		o	GHA400064	K
	2000.09-2006.08	Box Engine Z16SE Without ABS	•		GHA333036	K
	2000.09-2006.08	Box Engine Z16SE Without ABS		o	GHA400058	K
1.7 CDTi (59 kW)	2004.04-2006.08	Box Engine Z17DTL With ABS	•		GHA333033	K
	2004.04-2006.08	Box Engine Z17DTL With ABS		o	GHA400064	K
	2004.04-2006.08	Box Engine Z17DTL Without ABS	•		GHA333036	K
	2004.04-2006.08	Box Engine Z17DTL Without ABS		o	GHA400058	K
1.7 DTi 16V (55 kW)	2001.04-2006.08	Box Engine Y17DT With ABS	•		GHA333033	K
	2001.04-2006.08	Box Engine Y17DT With ABS		o	GHA400064	K
	2001.04-2006.08	Box Engine Y17DT Without ABS	•		GHA333036	K
	2001.04-2006.08	Box Engine Y17DT Without ABS		o	GHA400058	K
1.7 TD (50 kW)	1998.08-2006.08	Box Engine X17DTL With ABS	•		GHA333033	K



	 YEAR		F	R	G-AP Ref.	KIT
VAUXHALL						
ASTRAVAN IV (G)						
1.7 TD (50 kW)	1998.08-2006.08	Box Engine X17DTL With ABS		o	GHA400064	K
	1998.08-2006.08	Box Engine X17DTL Without ABS	•		GHA333036	K
	1998.08-2006.08	Box Engine X17DTL Without ABS		o	GHA400058	K
2.0 Di (60 kW)	1998.08-2006.08	Box Engine X20DTL With ABS	•		GHA333029	K
	1998.08-2006.08	Box Engine X20DTL With ABS		o	GHA400052	K
	1998.08-2006.08	Box Engine X20DTL Without ABS	•		GHA333036	K
	1998.08-2006.08	Box Engine X20DTL Without ABS		o	GHA400058	K
2.0 DTi (74 kW)	2004.04-2006.08	Box Engine Y20DTH	•		GHA333102	K
	2004.04-2006.08	Box Engine Y20DTH With ABS	•		GHA333029	K
	2004.04-2006.08	Box Engine Y20DTH With ABS		o	GHA400052	K
	2004.04-2006.08	Box Engine Y20DTH Without ABS		o	GHA400053	K
ASTRAVAN V (H)						
1.3 CDTi (66 kW)	2005.08-	Box Engine Z13DTH	•		GHA333069	K
	2005.08-	Box Engine Z13DTH	•		GHA333070	K
	2005.08-	Box Engine Z13DTH		o	GHA400133	K
	2005.08-	Box Engine Z13DTH		o	GHA400153	K
1.4 i (66 kW)	2005.03-	Box Engine Z14XEP	•		GHA333069	K
	2005.03-	Box Engine Z14XEP	•		GHA333070	K
	2005.03-	Box Engine Z14XEP		o	GHA400133	K
	2005.03-	Box Engine Z14XEP		o	GHA400153	K
1.6 (76 kW)	2005.03-	Box Engine Z16XE1/Z16XEP	•		GHA333069	K
	2005.03-	Box Engine Z16XE1/Z16XEP	•		GHA333070	K
	2005.03-	Box Engine Z16XE1/Z16XEP		o	GHA400133	K
	2005.03-	Box Engine Z16XE1/Z16XEP		o	GHA400153	K
1.7 CDTi (59 kW)	2005.03-2006.07	Box Engine Z17DTL	•		GHA333069	K
	2005.03-2006.07	Box Engine Z17DTL	•		GHA333070	K
	2005.03-2006.07	Box Engine Z17DTL		o	GHA400133	K
	2005.03-2006.07	Box Engine Z17DTL		o	GHA400153	K
1.7 CDTi (74 kW)	2005.03-2011.11	Box Engine Z17DTH	•		GHA333069	K
	2005.03-2011.11	Box Engine Z17DTH	•		GHA333070	K
	2005.03-2011.11	Box Engine Z17DTH		o	GHA400133	K
	2005.03-2011.11	Box Engine Z17DTH		o	GHA400153	K
1.7 CDTi (81 kW)	2011.11-	Box Engine A17DTJ/Z17DTJ	•		GHA333069	K
	2011.11-	Box Engine A17DTJ/Z17DTJ		o	GHA400133	K
	2011.11-	Box Engine A17DTJ/Z17DTJ		o	GHA400153	K
1.7 CDTi (92 kW)	2011.11-	Box Engine A17DTR/Z17DTR	•		GHA333069	K
	2011.11-	Box Engine A17DTR/Z17DTR	•		GHA333097	K
	2011.11-	Box Engine A17DTR/Z17DTR		o	GHA400133	K
	2011.11-	Box Engine A17DTR/Z17DTR		o	GHA400153	K
1.9 CDTi (110 kW)	2005.03-2011.11	Box Engine Z19DTH	•		GHA330013	K
	2005.03-2011.11	Box Engine Z19DTH	•		GHA333069	K
	2005.03-2011.11	Box Engine Z19DTH		o	GHA400133	K
	2005.03-2011.11	Box Engine Z19DTH		o	GHA400153	K
1.9 CDTi (88 kW)	2005.03-2011.11	Box Engine Z19DT	•		GHA333069	K
	2005.03-2011.11	Box Engine Z19DT	•		GHA333070	K
	2005.03-2011.11	Box Engine Z19DT	•		GHA333097	K
	2005.03-2011.11	Box Engine Z19DT		o	GHA400133	K
	2005.03-2011.11	Box Engine Z19DT		o	GHA400153	K
CALIBRA						
2.0 i (85 kW)	1990.06-1997.07	Coupe Engine C20NE	•		GHA433007	
	1990.06-1997.07	Coupe Engine C20NE	•		GHA433019	
	1990.06-1997.07	Coupe Engine C20NE	•		GWB0736	
	1990.06-1997.07	Coupe Engine C20NE	•		GWB3410	
	1990.06-1997.07	Coupe Engine C20NE		o	GWB1326	
2.0 i 16V (100 kW)	1990.06-1997.07	Coupe Engine X20XEV	•		GHA433007	
	1990.06-1997.07	Coupe Engine X20XEV	•		GHA433019	
	1990.06-1997.07	Coupe Engine X20XEV	•		GWB0736	
	1990.06-1997.07	Coupe Engine X20XEV	•		GWB3410	
	1990.06-1997.07	Coupe Engine X20XEV		o	GWB1326	
2.0 i 16V (110 kW)	1990.06-1994.02	Coupe Engine C20XE	•		GHA433007	
	1990.06-1994.02	Coupe Engine C20XE	•		GHA433019	
	1990.06-1994.02	Coupe Engine C20XE	•		GWB0736	
	1990.06-1994.02	Coupe Engine C20XE		o	GWB1326	
2.0 i 16V 4x4 (100 kW)	1994.02-1997.07	Coupe Engine X20XEV	•		GHA433007	



	 YEAR		F	R	G-AP Ref.	KIT
VAUXHALL						
CALIBRA						
2.0 i 16V 4x4 (100 kW)	1994.02-1997.07	Coupe Engine X20XE	•		GHA433019	
	1994.02-1997.07	Coupe Engine X20XE	•		GWB0736	
	1994.02-1997.07	Coupe Engine X20XE	•		GWB3410	
	1994.02-1997.07	Coupe Engine X20XE		○	GWB1326	
2.0 i 16V 4x4 (110 kW)	1990.06-1994.02	Coupe Engine C20XE	•		GHA433007	
	1990.06-1994.02	Coupe Engine C20XE	•		GHA433019	
	1990.06-1994.02	Coupe Engine C20XE	•		GWB0736	
	1990.06-1994.02	Coupe Engine C20XE		○	GWB1326	
2.0 i 4x4 (85 kW)	1990.06-1997.07	Coupe Engine C20NE	•		GHA433007	
	1990.06-1997.07	Coupe Engine C20NE	•		GHA433019	
	1990.06-1997.07	Coupe Engine C20NE	•		GWB0736	
	1990.06-1997.07	Coupe Engine C20NE	•		GWB3410	
	1990.06-1997.07	Coupe Engine C20NE		○	GWB1326	
2.0 i Turbo 4x4 (150 kW)	1992.03-1997.07	Coupe Engine C20LET	•		GHA433004	
	1992.03-1997.07	Coupe Engine C20LET	•		GWB0736	
	1992.03-1997.07	Coupe Engine C20LET	•		GWB3410	
	1992.03-1997.07	Coupe Engine C20LET		○	GWB1326	
2.5 i V6 (125 kW)	1993.04-1997.07	Coupe Engine C25XE/X25XE	•		GHA433004	
	1993.04-1997.07	Coupe Engine C25XE/X25XE	•		GWB3410	
	1993.04-1997.07	Coupe Engine C25XE/X25XE		○	GWB1326	
CARLTON III						
2.0 (73 kW)	1990.09-1994.03	Saloon Engine C20NEJ		○	GWB0754	
	1990.09-1994.03	Saloon Engine C20NEJ With ABS	•		GHA235001	K
	1990.09-1994.03	Saloon Engine C20NEJ With ABS	•		GHA235001	K
	1990.09-1994.03	Saloon Engine C20NEJ Without ABS	•		GHA235013	
	1990.09-1994.03	Saloon Engine C20NEJ Without ABS	•		GHA235013	
2.0 (74 kW)	1990.09-1994.03	Estate Engine C20NEF		○	GWB1326	
	1990.09-1994.03	Estate Engine C20NEF With ABS	•		GHA235001	K
	1990.09-1994.03	Estate Engine C20NEF With ABS	•		GHA235001	K
	1990.09-1994.03	Estate Engine C20NEF Without ABS	•		GHA235013	
	1990.09-1994.03	Estate Engine C20NEF Without ABS	•		GHA235013	
	1990.09-1994.03	Saloon Engine C20NEF		○	GWB0754	
	1990.09-1994.03	Saloon Engine C20NEF With ABS	•		GHA235001	K
	1990.09-1994.03	Saloon Engine C20NEF With ABS	•		GHA235001	K
	1990.09-1994.03	Saloon Engine C20NEF Without ABS	•		GHA235013	
	1990.09-1994.03	Saloon Engine C20NEF Without ABS	•		GHA235013	
2.0 i (73 kW)	1990.09-1994.03	Estate Engine C20NEJ		○	GWB1326	
	1990.09-1994.03	Estate Engine C20NEJ With ABS	•		GHA235001	K
	1990.09-1994.03	Estate Engine C20NEJ With ABS	•		GHA235001	K
	1990.09-1994.03	Estate Engine C20NEJ Without ABS	•		GHA235013	
	1990.09-1994.03	Estate Engine C20NEJ Without ABS	•		GHA235013	
2.6 i (110 kW)	1990.09-1994.03	Estate Engine C26NE		○	GWB1326	
	1990.09-1994.03	Estate Engine C26NE With ABS	•		GHA235001	K
	1990.09-1994.03	Estate Engine C26NE With ABS	•		GHA235001	K
	1990.09-1994.03	Estate Engine C26NE Without ABS	•		GHA235013	
	1990.09-1994.03	Estate Engine C26NE Without ABS	•		GHA235013	
	1990.09-1994.03	Saloon Engine C26NE		○	GWB1326	
	1990.09-1994.03	Saloon Engine C26NE With ABS	•		GHA235001	K
	1990.09-1994.03	Saloon Engine C26NE With ABS	•		GHA235001	K
	1990.09-1994.03	Saloon Engine C26NE Without ABS	•		GHA235013	
3.6 24V Lotus (277 kW)	1990.08-1992.09	Saloon Engine C36GET		○	GWB1326	
	1990.08-1992.09	Saloon Engine C36GET With ABS	•		GHA235001	K
	1990.08-1992.09	Saloon Engine C36GET With ABS	•		GHA235001	K
	1990.08-1992.09	Saloon Engine C36GET Without ABS	•		GHA235013	
	1990.08-1992.09	Saloon Engine C36GET Without ABS	•		GHA235013	
CASCADA						
1.4 (103 kW)	2013.02-	Convertible Engine A14NET	•		GHA330019	K
1.4 (88 kW)	2013.02-	Convertible Engine A14NEL	•		GHA330019	K
1.6 (125 kW)	2013.02-	Convertible Engine A16XHT	•		GHA330019	K
2.0 CDTi (121 kW)	2013.02-	Convertible Engine A20DTH	•		GHA330019	K
2.0 CDTi (143 kW)	2013.02-	Convertible Engine A20DTR	•		GHA330019	K
CAVALIER III						
1.6 i (52 kW)	1993.09-1995.11	Hatchback Engine X16SZ	•		GHA422006	K



	 YEAR		F	R	G-AP Ref.	KIT
VAUXHALL						
CAVALIER III						
1.6 i (52 kW)	1993.09-1995.11	Hatchback Engine X16SZ	•		GWB3256	
	1993.09-1995.11	Hatchback Engine X16SZ	•		GWB3403	
	1993.09-1995.11	Hatchback Engine X16SZ			GWB0663	
	1993.09-1995.11	Hatchback Engine X16SZ With ABS		○	GHA400064	K
	1993.09-1995.11	Hatchback Engine X16SZ Without ABS		○	GHA400058	K
1.7 D (44 kW)	1992.07-1995.11	Hatchback Engine 17DR	•		GHA433007	
	1992.07-1995.11	Hatchback Engine 17DR	•		GWB0736	
	1992.07-1995.11	Hatchback Engine 17DR		○	GWB0944	
	1992.07-1995.11	Hatchback Engine 17DR With ABS		○	GHA400064	K
	1992.07-1995.11	Hatchback Engine 17DR Without ABS		○	GHA400058	K
1.8 i CAT (66 kW)	1990.03-1995.11	Hatchback Engine C18NZ	•		GHA433007	
	1990.03-1995.11	Hatchback Engine C18NZ	•		GWB0736	
	1990.03-1995.11	Hatchback Engine C18NZ		○	GWB0944	
	1990.03-1995.11	Hatchback Engine C18NZ With ABS		○	GHA400064	K
	1990.03-1995.11	Hatchback Engine C18NZ Without ABS		○	GHA400058	K
2.0 i 16V (100 kW)	1993.09-1995.11	Hatchback Engine X20XEV	•		GHA433007	
	1993.09-1995.11	Hatchback Engine X20XEV	•		GWB0736	
	1993.09-1995.11	Hatchback Engine X20XEV With ABS		○	GHA400064	K
	1993.09-1995.11	Hatchback Engine X20XEV Without ABS		○	GHA400058	K
2.0 i 16V 4x4 (110 kW)	1992.01-1993.11	Hatchback Engine C20XE	•		GHA433007	
	1992.01-1993.11	Hatchback Engine C20XE	•		GWB0736	
	1992.01-1993.11	Hatchback Engine C20XE		○	GWB1326	
2.0 i 4x4 (85 kW)	1991.01-1992.10	Hatchback Engine 20NE	•		GWB0736	
	1991.01-1992.10	Hatchback Engine 20NE		○	GWB1326	
2.0 i CAT (85 kW)	1990.09-1995.11	Hatchback Engine C20NE	•		GHA433007	
	1990.09-1995.11	Hatchback Engine C20NE	•		GWB0736	
	1990.09-1995.11	Hatchback Engine C20NE		○	GWB0944	
	1990.09-1995.11	Hatchback Engine C20NE With ABS		○	GHA400064	K
	1990.09-1995.11	Hatchback Engine C20NE Without ABS		○	GHA400058	K
CAVALIER III (87)						
1.6 i (52 kW)	1993.09-1995.11	Saloon Engine X16SZ	•		GHA422006	K
	1993.09-1995.11	Saloon Engine X16SZ	•		GWB3256	
	1993.09-1995.11	Saloon Engine X16SZ	•		GWB3403	
	1993.09-1995.11	Saloon Engine X16SZ			GWB0663	
	1993.09-1995.11	Saloon Engine X16SZ With ABS		○	GHA400064	K
	1993.09-1995.11	Saloon Engine X16SZ Without ABS		○	GHA400058	K
1.7 D (44 kW)	1992.07-1995.11	Saloon Engine 17DR	•		GHA433007	
	1992.07-1995.11	Saloon Engine 17DR	•		GHA433013	
	1992.07-1995.11	Saloon Engine 17DR	•		GWB0736	
	1992.07-1995.11	Saloon Engine 17DR		○	GWB0944	
	1992.07-1995.11	Saloon Engine 17DR With ABS		○	GHA400064	K
	1992.07-1995.11	Saloon Engine 17DR Without ABS		○	GHA400058	K
1.8 i CAT (66 kW)	1990.03-1995.11	Saloon Engine C18NZ	•		GHA433007	
	1990.03-1995.11	Saloon Engine C18NZ	•		GHA433013	
	1990.03-1995.11	Saloon Engine C18NZ	•		GWB0736	
	1990.03-1995.11	Saloon Engine C18NZ		○	GWB0944	
	1990.03-1995.11	Saloon Engine C18NZ With ABS		○	GHA400064	K
	1990.03-1995.11	Saloon Engine C18NZ Without ABS		○	GHA400058	K
2.0 i 4x4 (85 kW)	1991.01-1992.10	Saloon Engine 20NE	•		GHA433013	
	1991.01-1992.10	Saloon Engine 20NE	•		GWB0736	
	1991.01-1992.10	Saloon Engine 20NE		○	GWB1326	
2.0 i CAT (85 kW)	1990.09-1995.11	Saloon Engine C20NE	•		GHA433007	
	1990.09-1995.11	Saloon Engine C20NE	•		GHA433013	
	1990.09-1995.11	Saloon Engine C20NE	•		GWB0736	
	1990.09-1995.11	Saloon Engine C20NE		○	GWB0944	
	1990.09-1995.11	Saloon Engine C20NE With ABS		○	GHA400064	K
	1990.09-1995.11	Saloon Engine C20NE Without ABS		○	GHA400058	K
2.0 i Turbo 4x4 (150 kW)	1992.06-1994.11	Saloon Engine C20LET	•		GHA433013	
	1992.06-1994.11	Saloon Engine C20LET	•		GWB0736	
	1992.06-1994.11	Saloon Engine C20LET	•		GWB3410	
	1992.06-1994.11	Saloon Engine C20LET		○	GWB1326	
2.0 SRi 16V (100 kW)	1993.09-1995.11	Saloon Engine X20XEV	•		GHA433007	
	1993.09-1995.11	Saloon Engine X20XEV	•		GHA433013	
	1993.09-1995.11	Saloon Engine X20XEV	•		GWB0736	



	 YEAR		F	R	G-AP Ref.	KIT
VAUXHALL						
CAVALIER III (87)						
2.0 SRi 16V (100 kW)	1993.09-1995.11	Saloon Engine X20XEV With ABS		o	GHA400064	K
	1993.09-1995.11	Saloon Engine X20XEV Without ABS		o	GHA400058	K
COMBO I (B)						
1.2 (33 kW)	1994.07-2001.10	Box Engine C12NZ/X12SZ	•		GWB3403	
	1994.07-2001.10	Box Engine C12NZ/X12SZ		o	GWB0526	
1.4 (44 kW)	1994.07-2001.10	Box Engine C14NZ	•		GHA422006	K
	1994.07-2001.10	Box Engine C14NZ	•		GWB3403	
	1994.07-2001.10	Box Engine C14NZ		o	GWB0526	
1.4 (60 kW)	1994.07-2001.10	Box Engine C14SE	•		GWB3403	
	1994.07-2001.10	Box Engine C14SE		o	GWB0526	
1.7 D (44 kW)	1994.07-2001.10	Box Engine 17D(4EE1)/X17D(4EE1)	•		GHA422006	K
	1994.07-2001.10	Box Engine 17D(4EE1)/X17D(4EE1)	•		GWB3403	
	1994.07-2001.10	Box Engine 17D(4EE1)/X17D(4EE1)		o	GWB0526	
COMBO II (C) (F25)						
1.3 CDTi 16V (51 kW)	2004.09-2012.02	Box Body / Estate Engine Z13DT	•		GHA422014	
	2004.09-2012.02	Box Body / Estate Engine Z13DT With ABS		o	GHA400064	K
	2004.09-2012.02	Box Body / Estate Engine Z13DT Without ABS		o	GHA400058	K
1.3 CDTi 16V (55 kW)	2005.10-2011.11	Box Body / Estate Engine Z13DTJ With ABS		o	GHA400064	K
	2005.10-2011.11	Box Body / Estate Engine Z13DTJ Without ABS		o	GHA400058	K
1.4 16V (66 kW)	2001.10-2007.05	Box Body / Estate Engine Z14XE With ABS		o	GHA400064	K
	2001.10-2007.05	Box Body / Estate Engine Z14XE Without ABS		o	GHA400058	K
1.4 i 16V (66 kW)	2004.01-2011.11	Box Body / Estate Engine Z14XEP	•		GHA422014	
	2004.01-2011.11	Box Body / Estate Engine Z14XEP With ABS		o	GHA400064	K
	2004.01-2011.11	Box Body / Estate Engine Z14XEP Without ABS		o	GHA400058	K
1.6 (62 kW)	2001.08-2004.10	Box Body / Estate Engine Z16SE With ABS		o	GHA400064	K
	2001.08-2004.10	Box Body / Estate Engine Z16SE Without ABS		o	GHA400058	K
1.6 (64 kW)	2001.10-2011.11	Box Body / Estate Engine Z16SE	•		GHA422014	
	2001.10-2011.11	Box Body / Estate Engine Z16SE With ABS		o	GHA400064	K
	2001.10-2011.11	Box Body / Estate Engine Z16SE Without ABS		o	GHA400058	K
1.6 CNG 16V (69 kW)	2006.06-2012.02	Box Body / Estate Engine Z16YNG	•		GHA422014	
	2006.06-2012.02	Box Body / Estate Engine Z16YNG With ABS		o	GHA400064	K
	2006.06-2012.02	Box Body / Estate Engine Z16YNG Without ABS		o	GHA400058	K
1.6 CNG 16V (71 kW)	2005.04-2012.02	Box Body / Estate Engine Z16YNG With ABS		o	GHA400064	K
	2005.04-2012.02	Box Body / Estate Engine Z16YNG Without ABS		o	GHA400058	K
1.7 CDTi 16V (74 kW)	2004.12-2011.11	Box Body / Estate Engine Z17DTH	•		GWB0736	
	2004.12-2011.11	Box Body / Estate Engine Z17DTH With ABS		o	GHA400052	K
	2004.12-2011.11	Box Body / Estate Engine Z17DTH With ABS		o	GHA400064	K
	2004.12-2011.11	Box Body / Estate Engine Z17DTH Without ABS		o	GHA400058	K
1.7 Di 16V (48 kW)	2001.09-2011.11	Box Body / Estate Engine Y17DTL	•		GHA422014	
	2001.09-2011.11	Box Body / Estate Engine Y17DTL With ABS		o	GHA400064	K
	2001.09-2011.11	Box Body / Estate Engine Y17DTL Without ABS		o	GHA400058	K
1.7 DTi 16V (55 kW)	2001.10-2011.11	Box Body / Estate Engine Y17DT	•		GHA422014	
	2001.10-2011.11	Box Body / Estate Engine Y17DT With ABS		o	GHA400064	K
	2001.10-2011.11	Box Body / Estate Engine Y17DT Without ABS		o	GHA400058	K
COMBO III (D)						
1.3 CDTi (66 kW)	2011.11-	Box Body / Estate Engine A13FD	•		GWB3598	
	2011.11-	Box Body / Estate Engine A13FD		o	GHA230086	K
	2011.11-	Box Body / Estate Engine A13FD With ABS		o	GHA230128	
	2011.11-	Box Body / Estate Engine A13FD Without ABS		o	GHA230127	
1.4 (70 kW)	2011.11-	Box Body / Estate Engine 843A14FP	•		GWB3598	
	2011.11-	Box Body / Estate Engine 843A14FP		o	GHA230086	K
	2011.11-	Box Body / Estate Engine 843A14FP With ABS		o	GHA230128	
	2011.11-	Box Body / Estate Engine 843A14FP Without ABS		o	GHA230127	
1.4 CNG (88 kW)	2011.11-	Box Body / Estate Engine A4.FC	•		GWB3598	
1.6 CDTi (66 kW)	2011.11-	Box Body / Estate Engine A16FDL	•		GWB3598	
	2011.11-	Box Body / Estate Engine A16FDL	•		GWB3598	
	2011.11-	Box Body / Estate Engine A16FDL	•		GWB6774	
	2011.11-	Box Body / Estate Engine A16FDL		o	GHA230086	K
	2011.11-	Box Body / Estate Engine A16FDL With ABS		o	GHA230128	
	2011.11-	Box Body / Estate Engine A16FDL Without ABS		o	GHA230127	
1.6 CDTi (74 kW)	2011.11-	Box Body / Estate Engine A16FDH	•		GWB3598	
	2011.11-	Box Body / Estate Engine A16FDH	•		GWB3598	
	2011.11-	Box Body / Estate Engine A16FDH	•		GWB6774	
	2011.11-	Box Body / Estate Engine A16FDH		o	GHA230086	K



	 YEAR		F	R	G-AP Ref.	KIT
VAUXHALL						
COMBO III (D)						
1.6 CDTi (74 kW)	2011.11-	Box Body / Estate Engine A16FDH With ABS		o	GHA230128	
1.6 CDTi (77 kW)	2011.11-	Box Body / Estate Engine A16FDH	•		GWB3598	
	2011.11-	Box Body / Estate Engine A16FDH	•		GWB3599	
	2011.11-	Box Body / Estate Engine A16FDH	•		GWB6774	
	2011.11-	Box Body / Estate Engine A16FDH		o	GHA230086	K
	2011.11-	Box Body / Estate Engine A16FDH With ABS		o	GHA230128	
	2011.11-	Box Body / Estate Engine A16FDH Without ABS		o	GHA230127	
	2.0 CDTi (99 kW)	2011.11-	Box Body / Estate Engine A20FD	•		GWB3599
	2011.11-	Box Body / Estate Engine A20FD	•		GWB6774	
	2011.11-	Box Body / Estate Engine A20FD		o	GHA230086	K
	2011.11-	Box Body / Estate Engine A20FD With ABS		o	GHA230128	
	2011.11-	Box Body / Estate Engine A20FD Without ABS		o	GHA230127	
COMBO TOUR II (C) (F25)						
1.3 CDTi 16V (51 kW)	2004.09-2006.09	MPV Engine Y13DT/Z13DT With ABS		o	GHA400064	K
	2004.09-2006.09	MPV Engine Y13DT/Z13DT Without ABS		o	GHA400058	K
1.3 CDTi 16V (55 kW)	2006.07-2012.02	MPV Engine Z13DTJ With ABS		o	GHA400064	K
	2006.07-2012.02	MPV Engine Z13DTJ Without ABS		o	GHA400058	K
1.4 (66 kW)	2004.10-2010.09	MPV Engine Z14XEP With ABS		o	GHA400064	K
	2004.10-2010.09	MPV Engine Z14XEP Without ABS		o	GHA400058	K
1.6 (64 kW)	2001.10-2004.06	MPV Engine Z16SE With ABS		o	GHA400064	K
	2001.10-2004.06	MPV Engine Z16SE Without ABS		o	GHA400058	K
1.6 CNG (69 kW)	2006.06-2010.09	MPV Engine Z16YNG With ABS		o	GHA400064	K
	2006.06-2010.09	MPV Engine Z16YNG Without ABS		o	GHA400058	K
1.6 CNG 16V (71 kW)	2005.04-2012.02	MPV Engine Z16YNG With ABS		o	GHA400064	K
	2005.04-2012.02	MPV Engine Z16YNG Without ABS		o	GHA400058	K
1.7 CDTi 16V (74 kW)	2004.12-2010.09	MPV Engine Z17DTH	•		GWB0736	
	2004.12-2010.09	MPV Engine Z17DTH With ABS		o	GHA400052	K
	2004.12-2010.09	MPV Engine Z17DTH With ABS		o	GHA400064	K
	2004.12-2010.09	MPV Engine Z17DTH Without ABS		o	GHA400058	K
1.7 Di 16V (48 kW)	2001.09-2004.06	MPV Engine Y17DTL With ABS		o	GHA400064	K
	2001.09-2004.06	MPV Engine Y17DTL Without ABS		o	GHA400058	K
1.7 DTi 16V (55 kW)	2001.10-2012.02	MPV Engine Y17DT With ABS		o	GHA400064	K
	2001.10-2012.02	MPV Engine Y17DT Without ABS		o	GHA400058	K
CORSA I (B)						
1.0 i 12V (40 kW)	1996.11-2000.09	Hatchback Engine X10XE	•		GHA422006	K
	1996.11-2000.09	Hatchback Engine X10XE	•		GWB3403	
	1996.11-2000.09	Hatchback Engine X10XE		o	GWB0944	
1.2 i (33 kW)	1993.03-2000.09	Hatchback Engine C12NZ/X12SZ	•		GHA422006	K
	1993.03-2000.09	Hatchback Engine C12NZ/X12SZ	•		GWB3403	
	1993.03-2000.09	Hatchback Engine C12NZ/X12SZ		o	GWB0944	
1.2 i 16V (48 kW)	1998.03-2000.09	Hatchback Engine X12XE	•		GHA422006	K
	1998.03-2000.09	Hatchback Engine X12XE	•		GWB3403	
	1998.03-2000.09	Hatchback Engine X12XE		o	GWB0944	
1.4 i (44 kW)	1993.03-2000.09	Hatchback Engine C14NZ/X14SZ	•		GHA422006	K
	1993.03-2000.09	Hatchback Engine C14NZ/X14SZ	•		GWB3403	
	1993.03-2000.09	Hatchback Engine C14NZ/X14SZ		o	GWB0944	
1.4 i 16V (63 kW)	1997.08-2000.09	Hatchback Engine C14SEL	•		GWB3403	
	1997.08-2000.09	Hatchback Engine C14SEL		o	GWB0944	
1.4 i 16V (66 kW)	1994.09-2000.09	Hatchback Engine X14XE	•		GHA422006	K
	1994.09-2000.09	Hatchback Engine X14XE	•		GWB3403	
	1994.09-2000.09	Hatchback Engine X14XE		o	GWB0944	
1.4 i S (60 kW)	1993.03-2000.09	Hatchback Engine C14SE	•		GHA422006	K
	1993.03-2000.09	Hatchback Engine C14SE	•		GWB3403	
	1993.03-2000.09	Hatchback Engine C14SE		o	GWB0944	
1.5 D (37 kW)	1993.03-2000.09	Hatchback Engine 15D	•		GHA422006	K
	1993.03-2000.09	Hatchback Engine 15D	•		GWB3403	
	1993.03-2000.09	Hatchback Engine 15D		o	GWB0944	
1.5 TD (49 kW)	1993.03-1996.10	Hatchback Engine 15DT(T4EC1)/X15DT(T4EC1)	•		GHA422006	K
	1993.03-1996.10	Hatchback Engine 15DT(T4EC1)/X15DT(T4EC1)	•		GWB3403	
	1993.03-1996.10	Hatchback Engine 15DT(T4EC1)/X15DT(T4EC1)		o	GWB0944	
1.6 GSi 16V (80 kW)	1993.03-2000.09	Hatchback Engine C16XE	•		GHA422006	K
	1993.03-2000.09	Hatchback Engine C16XE	•		GWB3403	
	1993.03-2000.09	Hatchback Engine C16XE		o	GWB0944	
1.6 i 16V (74 kW)	1997.08-2000.09	Hatchback Engine C16SEL	•		GWB3403	



	 YEAR		F	R	G-AP Ref.	KIT
VAUXHALL						
CORSA I (B)						
1.6 i 16V (74 kW)	1997.08-2000.09	Hatchback Engine C16SEL		o	GWB0944	
1.6 i 16V (78 kW)	1994.09-2000.09	Hatchback Engine X16XE	•		GHA422006	K
	1994.09-2000.09	Hatchback Engine X16XE	•		GWB3403	
	1994.09-2000.09	Hatchback Engine X16XE		o	GWB0944	
1.7 D (44 kW)	1996.02-2000.09	Hatchback Engine 17D(4EE1)/X17D(4EE1)	•		GHA422006	K
	1996.02-2000.09	Hatchback Engine 17D(4EE1)/X17D(4EE1)	•		GWB3403	
	1996.02-2000.09	Hatchback Engine 17D(4EE1)/X17D(4EE1)		o	GWB0944	
CORSA II (C) (W5L, F08)						
1.0 12V (43 kW)	2000.09-2003.10	Hatchback Engine Z10XE	•		GHA422014	
	2000.09-2003.10	Hatchback Engine Z10XE		o	GHA227023	K
	2000.09-2003.10	Hatchback Engine Z10XE		o	GWB3601	
1.0 12V (44 kW)	2003.11-2006.10	Hatchback Engine Z10XEP	•		GHA422014	
	2003.11-2006.10	Hatchback Engine Z10XEP		o	GHA227023	K
	2003.11-2006.10	Hatchback Engine Z10XEP		o	GWB3601	
1.2 16V (55 kW)	2000.09-2006.10	Hatchback Engine Z12XE	•		GHA422014	
	2000.09-2006.10	Hatchback Engine Z12XE		o	GHA227023	K
	2000.09-2006.10	Hatchback Engine Z12XE		o	GWB3601	
1.2 16V Dualfuel (55 kW)	2001.08-2006.10	Hatchback Engine Z12XE	•		GHA422014	
	2001.08-2006.10	Hatchback Engine Z12XE		o	GHA227023	K
	2001.08-2006.10	Hatchback Engine Z12XE		o	GWB3601	
1.2 Twinport (59 kW)	2004.07-2006.10	Hatchback Engine Z12XEP	•		GHA422014	
	2004.07-2006.10	Hatchback Engine Z12XEP		o	GHA227023	K
	2004.07-2006.10	Hatchback Engine Z12XEP		o	GWB3601	
1.3 CDTi 16V (52 kW)	2000.08-2006.09	Hatchback Engine Z13DT	•		GHA422014	
	2000.08-2006.09	Hatchback Engine Z13DT		o	GHA227023	K
	2000.08-2006.09	Hatchback Engine Z13DT		o	GWB3601	
1.3 CDTi 16V (55 kW)	2005.09-2006.09	Hatchback Engine Z13DTJ		o	GHA227023	K
	2005.09-2006.09	Hatchback Engine Z13DTJ		o	GWB3601	
1.4 16V (66 kW)	2000.09-2006.10	Hatchback Engine Z14XE	•		GHA422014	
	2000.09-2006.10	Hatchback Engine Z14XE		o	GHA227023	K
	2000.09-2006.10	Hatchback Engine Z14XE		o	GWB3601	
1.4 Twinport (66 kW)	2003.06-2006.10	Hatchback Engine Z14XEP	•		GHA422014	
	2003.06-2006.10	Hatchback Engine Z14XEP		o	GHA227023	K
	2003.06-2006.10	Hatchback Engine Z14XEP		o	GWB3601	
1.6 (62 kW)	2001.08-2004.10	Hatchback Engine Z16SE		o	GHA227023	K
	2001.08-2004.10	Hatchback Engine Z16SE		o	GWB3601	
1.7 CDTi 16V (74 kW)	2000.08-2006.09	Hatchback Engine Z17DTH	•		GWB0736	
	2000.08-2006.09	Hatchback Engine Z17DTH		o	GHA227023	K
	2000.08-2006.09	Hatchback Engine Z17DTH		o	GWB3601	
1.7 Di 16V (48 kW)	2000.08-2006.09	Hatchback Engine Y17DTL	•		GHA422014	
	2000.08-2006.09	Hatchback Engine Y17DTL		o	GHA227023	K
	2000.08-2006.09	Hatchback Engine Y17DTL		o	GWB3601	
1.7 DTi 16V (55 kW)	2000.08-2006.09	Hatchback Engine Y17DT	•		GHA422014	
	2000.08-2006.09	Hatchback Engine Y17DT		o	GHA227023	K
	2000.08-2006.09	Hatchback Engine Y17DT		o	GWB3601	
1.8 16V (92 kW)	2000.08-2006.09	Hatchback Engine Z18XE	•		GHA422014	
	2000.08-2006.09	Hatchback Engine Z18XE		o	GHA227023	K
	2000.08-2006.09	Hatchback Engine Z18XE		o	GWB3601	
CORSA III (D) (L_8)						
1.0 (44 kW)	2006.11-	Hatchback Engine A10XEP/Z10XEP	•		GWB6550	
	2006.11-	Hatchback Engine A10XEP/Z10XEP		o	GHA230092	S
	2006.11-	Hatchback Engine A10XEP/Z10XEP		o	GHA230098	K
1.0 i 12V (48 kW)	2010.06-	Hatchback Engine A10XEP	•		GWB6550	
	2010.06-	Hatchback Engine A10XEP		o	GHA230092	S
	2010.06-	Hatchback Engine A10XEP		o	GHA230098	K
1.2 (51 kW)	2010.06-	Hatchback Engine A12XEL	•		GWB6550	
	2010.06-	Hatchback Engine A12XEL		o	GHA230092	S
	2010.06-	Hatchback Engine A12XEL		o	GHA230098	K
1.2 (59 kW)	2006.11-	Hatchback Engine Z12XEP	•		GWB6550	
	2006.11-	Hatchback Engine Z12XEP		o	GHA230092	S
	2006.11-	Hatchback Engine Z12XEP		o	GHA230098	K
1.2 i 16V (63 kW)	2006.11-	Hatchback Engine A12XER	•		GWB6550	
	2006.11-	Hatchback Engine A12XER		o	GHA230092	S
	2006.11-	Hatchback Engine A12XER		o	GHA230098	K



	 YEAR		F	R	G-AP Ref.	KIT
VAUXHALL						
CORSA III (D) (L_8)						
1.2 LPG (59 kW)	2009.09-	Hatchback Engine Z12XEP	•		GWB6550	
	2009.09-	Hatchback Engine Z12XEP		◦	GHA230092	S
	2009.09-	Hatchback Engine Z12XEP		◦	GHA230098	K
1.2 LPG (61 kW)	2011.06-	Hatchback Engine A12XER	•		GWB6550	
	2011.06-	Hatchback Engine A12XER		◦	GHA230092	S
	2011.06-	Hatchback Engine A12XER		◦	GHA230098	K
1.2 LPG (63 kW)	2011.08-	Hatchback Engine A12XER	•		GWB6550	
	2011.08-	Hatchback Engine A12XER		◦	GHA230092	S
	2011.08-	Hatchback Engine A12XER		◦	GHA230098	K
1.3 CDTi (55 kW)	2006.11-	Hatchback Engine A13DTC/Z13DTJ	•		GHA422014	
	2006.11-	Hatchback Engine A13DTC/Z13DTJ	•		GWB3539	
	2006.11-	Hatchback Engine A13DTC/Z13DTJ	•		GWB6540	
	2006.11-	Hatchback Engine A13DTC/Z13DTJ		◦	GHA230092	S
	2006.11-	Hatchback Engine A13DTC/Z13DTJ		◦	GHA230098	K
1.3 CDTi (66 kW)	2006.11-	Hatchback Engine Z13DTH	•		GHA422014	
	2006.11-	Hatchback Engine Z13DTH	•		GWB3539	
	2006.11-	Hatchback Engine Z13DTH	•		GWB6540	
	2006.11-	Hatchback Engine Z13DTH		◦	GHA230092	S
	2006.11-	Hatchback Engine Z13DTH		◦	GHA230098	K
1.3 CDTi (70 kW)	2006.11-	Hatchback Engine A13DTE/A13DTE/Z13DTE/A13DTR	•		GWB3539	
	2006.11-	Hatchback Engine A13DTE/A13DTE/Z13DTE/A13DTR	•		GWB6540	
	2006.11-	Hatchback Engine A13DTE/A13DTE/Z13DTE/A13DTR		◦	GHA230092	S
	2006.11-	Hatchback Engine A13DTE/A13DTE/Z13DTE/A13DTR		◦	GHA230098	K
1.4 (64 kW)	2009.09-	Hatchback Engine A14XEL	•		GWB3539	
	2009.09-	Hatchback Engine A14XEL	•		GWB6540	
	2009.09-	Hatchback Engine A14XEL		◦	GHA230092	S
	2009.09-	Hatchback Engine A14XEL		◦	GHA230098	K
1.4 (66 kW)	2006.07-	Hatchback Engine Z14XEP	•		GWB6550	
	2006.07-	Hatchback Engine Z14XEP		◦	GHA230092	S
	2006.07-	Hatchback Engine Z14XEP		◦	GHA230098	K
1.4 (74 kW)	2010.07-	Hatchback Engine A14XER	•		GWB6550	
	2010.07-	Hatchback Engine A14XER		◦	GHA230092	S
	2010.07-	Hatchback Engine A14XER		◦	GHA230098	K
1.4 LPG (64 kW)	2009.09-	Hatchback Engine A14XEL	•		GWB6550	
	2009.09-	Hatchback Engine A14XEL		◦	GHA230092	S
	2009.09-	Hatchback Engine A14XEL		◦	GHA230098	K
1.4 LPG (66 kW)	2006.07-	Hatchback Engine Z14XEP	•		GWB6550	
	2006.07-	Hatchback Engine Z14XEP		◦	GHA230092	S
	2006.07-	Hatchback Engine Z14XEP		◦	GHA230098	K
1.6 SRi (110 kW)	2007.05-	Hatchback Engine A16LEL/Z16LEL	•		GWB3539	
	2007.05-	Hatchback Engine A16LEL/Z16LEL	•		GWB6540	
	2007.05-	Hatchback Engine A16LEL/Z16LEL		◦	GHA230092	S
	2007.05-	Hatchback Engine A16LEL/Z16LEL		◦	GHA230098	K
1.6 VXR (141 kW)	2007.02-	Hatchback Engine A16LER/Z16LER	•		GHA422014	
	2007.02-	Hatchback Engine A16LER/Z16LER	•		GWB3539	
	2007.02-	Hatchback Engine A16LER/Z16LER	•		GWB6540	
	2007.02-	Hatchback Engine A16LER/Z16LER		◦	GHA230092	S
1.6 VXR (150 kW)	2011.06-2012.03	Hatchback Engine A16LES	•		GWB3539	
	2011.06-2012.03	Hatchback Engine A16LES	•		GWB6540	
	2011.06-2012.03	Hatchback Engine A16LES		◦	GHA230098	K
1.7 CDTi (92 kW)	2006.11-	Hatchback Engine A17DTR/Z17DTR	•		GWB3539	
	2006.11-	Hatchback Engine A17DTR/Z17DTR	•		GWB6540	
	2006.11-	Hatchback Engine A17DTR/Z17DTR		◦	GHA230092	S
	2006.11-	Hatchback Engine A17DTR/Z17DTR		◦	GHA230098	K
1.7 CDTi (96 kW)	2006.11-	Hatchback Engine A17DTS	•		GWB3539	
	2006.11-	Hatchback Engine A17DTS	•		GWB6540	
	2006.11-	Hatchback Engine A17DTS		◦	GHA230092	S
	2006.11-	Hatchback Engine A17DTS		◦	GHA230098	K
CORSA MK IV (E)						
1.0 (66 kW)	2014.08-	Hatchback Engine B 10 XFL	•		GWB3539	
	2014.08-	Hatchback Engine B 10 XFL	•		GWB6540	
	2014.08-	Hatchback Engine B 10 XFL	•		GWB6550	
1.0 (85 kW)	2014.08-	Hatchback Engine B 10 XFL	•		GWB3539	
	2014.08-	Hatchback Engine B 10 XFL	•		GWB6540	



	 YEAR		F	R	G-AP Ref.	KIT
VAUXHALL						
CORSA MK IV (E)						
1.0 (85 kW)	2014.08-	Hatchback Engine B 10 XFL	•		GWB6550	
1.2 (51 kW)	2014.08-	Hatchback Engine B 12 XEL	•		GWB6550	
1.3 CDTi (55 kW)	2014.08-	Hatchback Engine B 13 DTC	•		GWB3539	
	2014.08-	Hatchback Engine B 13 DTC	•		GWB6540	
1.3 CDTi (70 kW)	2014.08-	Hatchback Engine B 13 DTE/B 13 DTR	•		GWB3539	
	2014.08-	Hatchback Engine B 13 DTE/B 13 DTR	•		GWB6540	
1.4 (66 kW)	2014.08-	Hatchback Engine B 14 XEL	•		GWB3539	
	2014.08-	Hatchback Engine B 14 XEL	•		GWB6540	
	2014.08-	Hatchback Engine B 14 XEL	•		GWB6550	
1.4 (74 kW)	2014.08-	Hatchback Engine B 14 NEL	•		GWB3539	
	2014.08-	Hatchback Engine B 14 NEL	•		GWB6540	
	2014.08-	Hatchback Engine B 14 NEL	•		GWB6550	
CORSAVAN I (B)						
1.4 i (44 kW)	1994.01-2000.09	Box Engine C14NZ	•		GHA422006	K
	1994.01-2000.09	Box Engine C14NZ	•		GWB3403	
	1994.01-2000.09	Box Engine C14NZ		◦	GWB0944	
1.5 D (37 kW)	1994.08-1995.12	Box Engine 15D	•		GHA422006	K
	1994.08-1995.12	Box Engine 15D	•		GWB3403	
	1994.08-1995.12	Box Engine 15D		◦	GWB0944	
1.7 D (44 kW)	1994.01-2000.09	Box Engine 17D(4EE1)/X17D(4EE1)	•		GHA422006	K
	1994.01-2000.09	Box Engine 17D(4EE1)/X17D(4EE1)	•		GWB3403	
	1994.01-2000.09	Box Engine 17D(4EE1)/X17D(4EE1)		◦	GWB0944	
CORSAVAN II (C)						
1.2 16V (55 kW)	2000.09-2006.06	Box Engine Z12XE	•		GHA422014	
	2000.09-2006.06	Box Engine Z12XE		◦	GHA227023	K
	2000.09-2006.06	Box Engine Z12XE		◦	GWB3601	
1.2 16V Dualfuel (55 kW)	2001.08-2006.06	Box Engine Z12XE	•		GHA422014	
	2001.08-2006.06	Box Engine Z12XE		◦	GHA227023	K
	2001.08-2006.06	Box Engine Z12XE		◦	GWB3601	
1.3 CDTi 16V (52 kW)	2004.04-2006.06	Box Engine Z13DT	•		GHA422014	
	2004.04-2006.06	Box Engine Z13DT		◦	GHA227023	K
	2004.04-2006.06	Box Engine Z13DT		◦	GWB3601	
1.4 (66 kW)	2003.11-2006.06	Box Engine Z14XEP	•		GHA422014	
	2003.11-2006.06	Box Engine Z14XEP		◦	GHA227023	K
	2003.11-2006.06	Box Engine Z14XEP		◦	GWB3601	
1.7 Di 16V (48 kW)	2000.09-2006.06	Box Engine Y17DTL	•		GHA422014	
	2000.09-2006.06	Box Engine Y17DTL		◦	GHA227023	K
	2000.09-2006.06	Box Engine Y17DTL		◦	GWB3601	
1.7 DTi 16V (55 kW)	2000.09-2006.06	Box Engine Y17DT	•		GHA422014	
	2000.09-2006.06	Box Engine Y17DT		◦	GHA227023	K
	2000.09-2006.06	Box Engine Y17DT		◦	GWB3601	
CORSAVAN III (D)						
1.2 (51 kW)	2010.01-	Box Engine A12XEL	•		GWB6550	
	2010.01-	Box Engine A12XEL		◦	GHA230092	S
	2010.01-	Box Engine A12XEL		◦	GHA230098	K
1.2 (59 kW)	2009.07-	Box Engine Z12XEP	•		GWB6550	
	2009.07-	Box Engine Z12XEP		◦	GHA230092	S
	2009.07-	Box Engine Z12XEP		◦	GHA230098	K
1.3 CDTi (55 kW)	2006.07-	Box Engine Z13DTJ	•		GWB3539	
	2006.07-	Box Engine Z13DTJ	•		GWB6540	
	2006.07-	Box Engine Z13DTJ		◦	GHA230092	S
	2006.07-	Box Engine Z13DTJ		◦	GHA230098	K
1.3 CDTi (66 kW)	2006.07-	Box Engine Z13DTH	•		GWB3539	
	2006.07-	Box Engine Z13DTH	•		GWB6540	
	2006.07-	Box Engine Z13DTH		◦	GHA230092	S
	2006.07-	Box Engine Z13DTH		◦	GHA230098	K
1.3 CDTi (70 kW)	2006.07-	Box Engine Z13DTE	•		GWB3539	
	2006.07-	Box Engine Z13DTE	•		GWB6540	
	2006.07-	Box Engine Z13DTE		◦	GHA230092	S
	2006.07-	Box Engine Z13DTE		◦	GHA230098	K
CORSAVAN MK IV (E)						
1.2 (51 kW)	2014.10-	Box Engine B 12 XEL	•		GWB6550	
1.3 CDTi (55 kW)	2014.10-	Box Engine B 13 DTC	•		GWB3539	
	2014.10-	Box Engine B 13 DTC	•		GWB6540	



	 YEAR		F	R	G-AP Ref.	KIT
VAUXHALL						
CORSAVAN MK IV (E)						
1.3 CDTi (70 kW)	2014.10-	Box Engine B 13 DTE	•		GWB3539	
	2014.10-	Box Engine B 13 DTE	•		GWB6540	
INSIGNIA						
1.4 (103 kW)	2011.04-	Hatchback Engine A14NET Without ABS	•		GHA330024	K
	2011.04-	Hatchback Engine A14NET Without ABS		◦	GHA330024	S
	2011.04-	Saloon Engine A14NET Without ABS	•		GHA330024	K
	2011.04-	Saloon Engine A14NET Without ABS		◦	GHA330024	S
1.6 (85 kW)	2008.07-	Hatchback Engine A16XER Without ABS	•		GHA330024	K
	2008.07-	Hatchback Engine A16XER Without ABS		◦	GHA330024	S
	2008.07-	Saloon Engine A16XER Without ABS	•		GHA330024	K
	2008.07-	Saloon Engine A16XER Without ABS		◦	GHA330024	S
1.6 Turbo (125 kW)	2013.07-	Hatchback Engine A16XHT Without ABS	•		GHA330024	K
	2013.07-	Saloon Engine A16XHT Without ABS	•		GHA330024	K
1.6 Turbo (132 kW)	2009.01-	Hatchback Engine A16LET Without ABS	•		GHA330024	K
	2009.01-	Hatchback Engine A16LET Without ABS		◦	GHA330024	S
	2009.01-	Saloon Engine A16LET Without ABS	•		GHA330024	K
	2009.01-	Saloon Engine A16LET Without ABS		◦	GHA330024	S
1.8 (103 kW)	2008.07-2013.09	Hatchback Engine A18XER Without ABS	•		GHA330024	K
	2008.07-2013.09	Hatchback Engine A18XER Without ABS		◦	GHA330024	S
	2008.07-2013.09	Saloon Engine A18XER Without ABS	•		GHA330024	K
	2008.07-2013.09	Saloon Engine A18XER Without ABS		◦	GHA330024	S
2.0 Biturbo CDTi (143 kW)	2012.03-	Hatchback Engine A20DTR Without ABS	•		GHA330024	K
	2012.03-	Saloon Engine A20DTR Without ABS	•		GHA330024	K
2.0 Biturbo CDTi 4x4 (143 kW)	2012.03-	Hatchback Engine A20DTR Without ABS	•		GHA330024	K
	2012.03-	Hatchback Engine A20DTR Without ABS		◦	GHA330024	F
	2012.03-	Saloon Engine A20DTR Without ABS	•		GHA330024	K
	2012.03-	Saloon Engine A20DTR Without ABS		◦	GHA330024	F
2.0 CDTi (103 kW)	2013.07-	Hatchback Engine A20DTE Without ABS	•		GHA330024	K
	2013.07-	Saloon Engine A20DTE Without ABS	•		GHA330024	K
2.0 CDTi (118 kW)	2008.07-	Hatchback Engine A20DTH Without ABS	•		GHA330024	K
	2008.07-	Hatchback Engine A20DTH Without ABS		◦	GHA330024	S
	2008.07-	Saloon Engine A20DTH Without ABS	•		GHA330024	K
	2008.07-	Saloon Engine A20DTH Without ABS		◦	GHA330024	S
2.0 CDTi (120 kW)	2013.07-	Hatchback Engine A20DTH Without ABS	•		GHA330024	K
	2013.07-	Saloon Engine A20DTH Without ABS	•		GHA330024	K
2.0 CDTi (125 kW)	2014.11-	Estate Engine B 20 DTH Without ABS	•		GHA330024	K
	2014.11-	Hatchback Engine B 20 DTH Without ABS	•		GHA330024	K
	2014.11-	Saloon Engine B 20 DTH Without ABS	•		GHA330024	K
2.0 CDTi (140 kW)	2008.10-	Hatchback Engine A20DTR Without ABS	•		GHA330024	K
	2008.10-	Hatchback Engine A20DTR Without ABS		◦	GHA330024	S
	2008.11-	Saloon Engine A20DTR Without ABS	•		GHA330024	K
	2008.11-	Saloon Engine A20DTR Without ABS		◦	GHA330024	S
2.0 CDTi (81 kW)	2008.07-	Hatchback Engine A20DTC Without ABS	•		GHA330024	K
	2008.07-	Hatchback Engine A20DTC Without ABS		◦	GHA330024	S
	2008.07-	Saloon Engine A20DTC Without ABS	•		GHA330024	K
	2008.07-	Saloon Engine A20DTC Without ABS		◦	GHA330024	S
2.0 CDTi (88 kW)	2012.03-	Hatchback Engine A20DTE Without ABS	•		GHA330024	K
	2012.03-	Saloon Engine A20DTE Without ABS	•		GHA330024	K
2.0 CDTi (96 kW)	2008.07-	Hatchback Engine A20DTH Without ABS	•		GHA330024	K
	2008.07-	Hatchback Engine A20DTH Without ABS		◦	GHA330024	S
	2008.07-	Saloon Engine A20DTJ Without ABS	•		GHA330024	K
	2008.07-	Saloon Engine A20DTJ Without ABS		◦	GHA330024	S
2.0 CDTi 4x4 (118 kW)	2008.07-	Hatchback Engine A20DTH Without ABS	•		GHA330024	K
	2008.07-	Hatchback Engine A20DTH Without ABS		◦	GHA330024	F
	2008.07-	Saloon Engine A20DTH Without ABS	•		GHA330024	K
	2008.07-	Saloon Engine A20DTH Without ABS		◦	GHA330024	F
2.0 CDTi 4x4 (120 kW)	2013.07-	Hatchback Engine A20DTH Without ABS	•		GHA330024	K
	2013.07-	Hatchback Engine A20DTH Without ABS		◦	GHA330024	F
	2013.07-	Saloon Engine A20DTH Without ABS	•		GHA330024	K
	2013.07-	Saloon Engine A20DTH Without ABS		◦	GHA330024	F
2.0 CDTi 4x4 (125 kW)	2014.11-	Estate Engine B 20 DTH Without ABS	•		GHA330024	K
	2014.11-	Estate Engine B 20 DTH Without ABS		◦	GHA330024	F
	2014.11-	Hatchback Engine B 20 DTH Without ABS	•		GHA330024	K
	2014.11-	Hatchback Engine B 20 DTH Without ABS		◦	GHA330024	F



	 YEAR		F	R	G-AP Ref.	KIT
VAUXHALL						
INSIGNIA						
	2014.11-	Saloon Engine B 20 DTH Without ABS	•		GHA330024	K
	2014.11-	Saloon Engine B 20 DTH Without ABS		◦	GHA330024	F
2.0 CDTi 4x4 (140 kW)	2009.05-	Hatchback Engine A20DTR Without ABS	•		GHA330024	K
	2009.05-	Hatchback Engine A20DTR Without ABS		◦	GHA330024	F
	2009.05-	Saloon Engine A20DTR Without ABS	•		GHA330024	K
	2009.05-	Saloon Engine A20DTR Without ABS		◦	GHA330024	F
2.0 Turbo (162 kW)	2008.07-	Hatchback Engine A18XER Without ABS	•		GHA330024	K
	2008.07-	Hatchback Engine A18XER Without ABS		◦	GHA330024	S
	2008.07-	Saloon Engine A20NHT Without ABS	•		GHA330024	K
	2008.07-	Saloon Engine A20NHT Without ABS		◦	GHA330024	S
2.0 Turbo (184 kW)	2014.04-	Estate Engine A20NFT Without ABS	•		GHA330024	K
	2014.04-	Hatchback Engine A 20 NFT Without ABS	•		GHA330024	K
2.0 Turbo 4x4 (162 kW)	2008.07-	Hatchback Engine A20NHT Without ABS	•		GHA330024	K
	2008.07-	Hatchback Engine A20NHT Without ABS		◦	GHA330024	F
	2008.07-	Saloon Engine A20NHT Without ABS	•		GHA330024	K
	2008.07-	Saloon Engine A20NHT Without ABS		◦	GHA330024	F
2.0 Turbo 4x4 (184 kW)	2011.09-	Hatchback Engine A20NFT Without ABS	•		GHA330024	K
	2011.09-	Hatchback Engine A20NFT Without ABS		◦	GHA330024	F
	2011.09-	Saloon Engine A20NFT Without ABS	•		GHA330024	K
	2011.09-	Saloon Engine A20NFT Without ABS		◦	GHA330024	F
2.8 V6 Turbo 4x4 (191 kW)	2008.07-	Hatchback Engine A28NET Without ABS	•		GHA330024	K
	2008.07-	Hatchback Engine A28NET Without ABS		◦	GHA330024	F
	2008.07-	Saloon Engine A28NET Without ABS	•		GHA330024	K
	2008.07-	Saloon Engine A28NET Without ABS		◦	GHA330024	F
2.8 VXR (239 kW)	2009.07-	Hatchback Engine A28NER Without ABS	•		GHA330024	K
	2009.07-	Hatchback Engine A28NER Without ABS		◦	GHA330024	F
	2009.07-	Saloon Engine A28NER Without ABS	•		GHA330024	K
	2009.07-	Saloon Engine A28NER Without ABS		◦	GHA330024	F
INSIGNIA SPORTS TOURER						
1.4 (103 kW)	2011.04-	Estate Engine A14NET Without ABS	•		GHA330024	K
	2011.04-	Estate Engine A14NET Without ABS		◦	GHA330024	S
1.6 (85 kW)	2008.07-	Estate Engine A16XER Without ABS	•		GHA330024	K
	2008.07-	Estate Engine A16XER Without ABS		◦	GHA330024	S
1.6 Turbo (125 kW)	2013.07-	Estate Engine A16XHT Without ABS	•		GHA330024	K
1.6 Turbo (132 kW)	2009.01-	Estate Engine A16LET Without ABS	•		GHA330024	K
	2009.01-	Estate Engine A16LET Without ABS		◦	GHA330024	S
1.8 (103 kW)	2008.07-2013.09	Estate Engine A18XER Without ABS	•		GHA330024	K
	2008.07-2013.09	Estate Engine A18XER Without ABS		◦	GHA330024	S
2.0 Biturbo CDTi (143 kW)	2012.03-	Estate Engine A20DTR Without ABS	•		GHA330024	K
2.0 Biturbo CDTi 4x4 (143 kW)	2012.03-	Estate Engine A20DTR Without ABS	•		GHA330024	K
	2012.03-	Estate Engine A20DTR Without ABS		◦	GHA330024	F
2.0 CDTi (103 kW)	2013.07-	Estate Engine A20DTE Without ABS	•		GHA330024	K
2.0 CDTi (118 kW)	2008.07-	Estate Engine A20DTH Without ABS	•		GHA330024	K
	2008.07-	Estate Engine A20DTH Without ABS		◦	GHA330024	S
2.0 CDTi (120 kW)	2013.07-	Estate Engine A20DTH Without ABS	•		GHA330024	K
2.0 CDTi (140 kW)	2008.11-	Estate Engine A20DTR Without ABS	•		GHA330024	K
	2008.11-	Estate Engine A20DTR Without ABS		◦	GHA330024	S
2.0 CDTi (81 kW)	2008.07-	Estate Engine A20DTC Without ABS	•		GHA330024	K
	2008.07-	Estate Engine A20DTC Without ABS		◦	GHA330024	S
2.0 CDTi (88 kW)	2012.03-	Estate Engine A20DTE Without ABS	•		GHA330024	K
2.0 CDTi (96 kW)	2008.07-	Estate Engine A20DTJ Without ABS	•		GHA330024	K
	2008.07-	Estate Engine A20DTJ Without ABS		◦	GHA330024	S
2.0 CDTi 4x4 (118 kW)	2008.07-	Estate Engine A20DTH Without ABS	•		GHA330024	K
	2008.07-	Estate Engine A20DTH Without ABS		◦	GHA330024	F
2.0 CDTi 4x4 (120 kW)	2013.07-	Estate Engine A20DTH Without ABS	•		GHA330024	K
	2013.07-	Estate Engine A20DTH Without ABS		◦	GHA330024	F
2.0 CDTi 4x4 (140 kW)	2009.05-	Estate Engine A20DTR Without ABS	•		GHA330024	K
	2009.05-	Estate Engine A20DTR Without ABS		◦	GHA330024	F
2.0 Turbo (162 kW)	2008.07-	Estate Engine A20NHT Without ABS	•		GHA330024	K
	2008.07-	Estate Engine A20NHT Without ABS		◦	GHA330024	S
2.0 Turbo 4x4 (162 kW)	2008.07-	Estate Engine A20NHT Without ABS	•		GHA330024	K
	2008.07-	Estate Engine A20NHT Without ABS		◦	GHA330024	F
2.0 Turbo 4x4 (184 kW)	2011.09-	Estate Engine A20NFT Without ABS	•		GHA330024	K
	2011.09-	Estate Engine A20NFT Without ABS		◦	GHA330024	F



	 YEAR		F	R	G-AP Ref.	KIT
VAUXHALL						
INSIGNIA SPORTS TOURER						
2.8 V6 Turbo (191 kW)	2008.08-	Estate Engine A28NET Without ABS	•		GHA330024	K
	2008.08-	Estate Engine A28NET Without ABS		◦	GHA330024	S
2.8 VXR (239 kW)	2009.07-	Estate Engine A28NER Without ABS	•		GHA330024	K
	2009.07-	Estate Engine A28NER Without ABS		◦	GHA330024	F
MERIVA I (A)						
1.3 CDTi (55 kW)	2003.01-2009.10	MPV Engine Z13DTJ	•		GHA422014	
	2003.01-2009.10	MPV Engine Z13DTJ With ABS		◦	GHA400064	K
1.4 16V Twinport (66 kW)	2003.01-2009.10	MPV Engine Z14XEP	•		GHA422014	
	2003.01-2009.10	MPV Engine Z14XEP With ABS		◦	GHA400064	K
1.6 i (64 kW)	2003.01-2010.06	MPV Engine Z16SE	•		GHA422014	
	2003.01-2010.06	MPV Engine Z16SE With ABS		◦	GHA400064	K
	2003.01-2010.06	MPV Engine Z16SE Without ABS		◦	GHA400058	K
1.6 i 16V (74 kW)	2003.01-2005.09	MPV Engine Z16XE	•		GHA422014	
	2003.01-2005.09	MPV Engine Z16XE With ABS		◦	GHA400064	K
	2003.01-2005.09	MPV Engine Z16XE Without ABS		◦	GHA400058	K
1.6 i 16V Twinport (77 kW)	2003.05-2010.06	MPV Engine Z16XEP	•		GHA422014	
	2003.05-2010.06	MPV Engine Z16XEP With ABS		◦	GHA400064	K
1.6 Turbo (132 kW)	2006.05-2010.06	MPV Engine Z16LET	•		GHA422014	
	2006.05-2010.06	MPV Engine Z16LET	•		GWB0736	
	2006.05-2010.06	MPV Engine Z16LET With ABS		◦	GHA400052	K
1.7 CDTi 16V (74 kW)	2003.09-2005.08	MPV Engine Z17DTH	•		GHA422014	
	2003.09-2005.08	MPV Engine Z17DTH	•		GWB0736	
	2003.09-2005.08	MPV Engine Z17DTH With ABS		◦	GHA400052	K
1.7 DTi 16V (55 kW)	2003.06-2010.06	MPV Engine Y17DT	•		GHA422014	
	2003.06-2010.06	MPV Engine Y17DT With ABS		◦	GHA400064	K
	2003.06-2010.06	MPV Engine Y17DT Without ABS		◦	GHA400058	K
1.8 i 16V (92 kW)	2003.05-2005.08	MPV Engine Z18XE	•		GHA422014	
	2003.05-2005.08	MPV Engine Z18XE With ABS		◦	GHA400064	K
	2003.05-2005.08	MPV Engine Z18XE Without ABS		◦	GHA400058	K
MERIVA II (B)						
1.3 CDTi (55 kW)	2010.06-	MPV Engine A13DTC	•		GHA422014	
	2010.06-	MPV Engine A13DTC	•		GWB6720	
	2010.06-	MPV Engine A13DTC		◦	GHA400133	K
1.3 CDTi (70 kW)	2010.06-	MPV Engine A13DTE	•		GHA422014	
	2010.06-	MPV Engine A13DTE	•		GWB6720	
1.4 (103 kW)	2010.06-	MPV Engine A14NET	•		GHA422014	
	2010.06-	MPV Engine A14NET	•		GWB6720	
	2010.06-	MPV Engine A14NET		◦	GHA400133	K
1.4 (74 kW)	2010.06-	MPV Engine A14XER	•		GWB6720	
	2010.06-	MPV Engine A14XER		◦	GHA400133	K
1.4 (88 kW)	2010.06-	MPV Engine A14NEL	•		GHA422014	
	2010.06-	MPV Engine A14NEL	•		GWB6720	
	2010.06-	MPV Engine A14NEL		◦	GHA400133	K
1.4 LPG (88 kW)	2011.06-	MPV Engine A14NEL	•		GWB6720	
	2011.06-	MPV Engine A14NEL		◦	GHA400133	K
1.7 CDTi (74 kW)	2010.06-	MPV Engine A17DT	•		GHA422014	
	2010.06-	MPV Engine A17DT	•		GWB6720	
	2010.06-	MPV Engine A17DT		◦	GHA400133	K
1.7 CDTi (81 kW)	2010.06-	MPV Engine A17DTC	•		GHA422014	
	2010.06-	MPV Engine A17DTC	•		GWB6720	
	2010.06-	MPV Engine A17DTC		◦	GHA400133	K
1.7 CDTi (96 kW)	2010.06-	MPV Engine A17DTS	•		GHA422014	
	2010.06-	MPV Engine A17DTS	•		GWB6720	
	2010.06-	MPV Engine A17DTS		◦	GHA400133	K
MERIVA MK II (B)						
1.6 CDTi (100 kW)	2013.11-	MPV Engine B 16 DTH	•		GWB6720	
	2013.11-	MPV Engine B 16 DTH		◦	GHA400133	K
1.6 CDTi (70 kW)	2014.01-	MPV Engine B 16 DTC	•		GWB6720	
	2014.01-	MPV Engine B 16 DTC		◦	GHA400133	K
1.6 CDTi (81 kW)	2014.07-	MPV Engine B16DTE/B16DTL/B16DTN	•		GWB6720	
	2014.07-	MPV Engine B16DTE/B16DTL/B16DTN		◦	GHA400133	K
MOKKA						
1.4 (103 kW)	2013.04-	Closed Off-Road Vehicle Engine A 14 NET	•		GWB6720	
	2013.04-	Closed Off-Road Vehicle Engine A 14 NET		◦	GHA400259	



	 YEAR		F	R	G-AP Ref.	KIT
VAUXHALL						
MOKKA						
1.4 4x4 (103 kW)	2012.06-	Closed Off-Road Vehicle Engine A14NET	•		GWB6720	
1.6 (85 kW)	2012.06-	Closed Off-Road Vehicle Engine A16XER	•		GWB6720	
	2012.06-	Closed Off-Road Vehicle Engine A16XER		○	GHA400259	
1.6 CDTi (100 kW)	2015.01-	Closed Off-Road Vehicle Engine B 16 DTH	•		GWB6720	
	2015.01-	Closed Off-Road Vehicle Engine B 16 DTH		○	GHA400259	
1.6 CDTi 4x4 (100 kW)	2015.01-	Closed Off-Road Vehicle Engine B 16 DTH	•		GWB6720	
1.7 CDTi (96 kW)	2012.06-	Closed Off-Road Vehicle Engine A17DTS	•		GWB6720	
	2012.06-	Closed Off-Road Vehicle Engine A17DTS		○	GHA400259	
1.7 CDTi 4x4 (96 kW)	2012.06-	Closed Off-Road Vehicle Engine A17DTS	•		GWB6720	
MOVANO I (A) (JD)						
1.9 DTi (59 kW)	2000.09-2001.10	Bus Engine F9Q770	•		GWB3500	
	2000.09-2001.10	Bus Engine F9Q770	•		GWB3613	
	2000.09-2001.10	Bus Engine F9Q770		○	GWB3501	
	2000.09-2001.10	Bus Engine F9Q770		○	GWB3614	
1.9 DTi (60 kW)	2001.10-2010.05	Bus Engine F9Q774	•		GWB3500	
	2001.10-2010.05	Bus Engine F9Q774	•		GWB3613	
	2001.10-2010.05	Bus Engine F9Q774		○	GWB3501	
	2001.10-2010.05	Bus Engine F9Q774		○	GWB3614	
2.2 DTi (66 kW)	2000.09-2010.05	Bus Engine G9T720/G9T750	•		GWB3500	
	2000.09-2010.05	Bus Engine G9T720/G9T750	•		GWB3613	
	2000.09-2010.05	Bus Engine G9T720/G9T750		○	GWB3501	
	2000.09-2010.05	Bus Engine G9T720/G9T750		○	GWB3614	
2.5 CDTi (107 kW)	2006.08-2010.05	Bus Engine G9U632	•		GWB3613	
	2006.08-2010.05	Bus Engine G9U632		○	GWB3501	
	2006.08-2010.05	Bus Engine G9U632		○	GWB3614	
2.5 CDTi (74 kW)	2001.10-2009.08	Bus Engine G9U650/G9U754	•		GWB3613	
	2001.10-2009.08	Bus Engine G9U650/G9U754		○	GWB3501	
	2001.10-2009.08	Bus Engine G9U650/G9U754		○	GWB3614	
2.5 CDTi (88 kW)	2003.02-2009.08	Bus Engine G9U632/G9U650	•		GWB3613	
	2003.02-2009.08	Bus Engine G9U632/G9U650		○	GWB3501	
	2003.02-2009.08	Bus Engine G9U632/G9U650		○	GWB3614	
2.5 D (59 kW)	1998.10-2000.09	Bus Engine S8U770	•		GWB3500	
	1998.10-2000.09	Bus Engine S8U770	•		GWB3613	
	1998.10-2000.09	Bus Engine S8U770		○	GWB3501	
	1998.10-2000.09	Bus Engine S8U770		○	GWB3614	
2.5 DTi (84 kW)	2001.10-2009.08	Bus Engine G9U720/G9U750/G9U754	•		GWB3500	
	2001.10-2009.08	Bus Engine G9U720/G9U750/G9U754	•		GWB3613	
	2001.10-2009.08	Bus Engine G9U720/G9U750/G9U754		○	GWB3501	
	2001.10-2009.08	Bus Engine G9U720/G9U750/G9U754		○	GWB3614	
2.8 DTi (84 kW)	1998.10-2001.10	Bus Engine S9W702	•		GWB3500	
	1998.10-2001.10	Bus Engine S9W702	•		GWB3613	
	1998.10-2001.10	Bus Engine S9W702		○	GWB3501	
	1998.10-2001.10	Bus Engine S9W702		○	GWB3614	
3.0 DTi (100 kW)	2003.10-2010.05	Bus Engine ZD3200	•		GWB3613	
	2003.10-2010.05	Bus Engine ZD3200		○	GWB3501	
	2003.10-2010.05	Bus Engine ZD3200		○	GWB3614	
MOVANO I (A) CHASSIS/CAB (ED, UD, HD)						
2.2 DTi (66 kW)	2000.09-2010.05	Platform/Chassis Engine G9T720/G9T722/G9T750	•		GWB3500	
	2000.09-2010.05	Platform/Chassis Engine G9T720/G9T722/G9T750	•		GWB3613	
	2000.09-2010.05	Platform/Chassis Engine G9T720/G9T722/G9T750		○	GWB3501	
	2000.09-2010.05	Platform/Chassis Engine G9T720/G9T722/G9T750		○	GWB3614	
2.5 CDTi (107 kW)	2006.08-2010.05	Platform/Chassis Engine G9U632	•		GWB3613	
	2006.08-2010.05	Platform/Chassis Engine G9U632		○	GWB3501	
	2006.08-2010.05	Platform/Chassis Engine G9U632		○	GWB3614	
2.5 CDTi (74 kW)	2004.04-2010.05	Platform/Chassis Engine G9U650/G9U754	•		GWB3613	
	2004.04-2010.05	Platform/Chassis Engine G9U650/G9U754		○	GWB3501	
	2004.04-2010.05	Platform/Chassis Engine G9U650/G9U754		○	GWB3614	
2.5 CDTi (88 kW)	2006.08-2010.05	Platform/Chassis Engine G9U632/G9U650	•		GWB3613	
	2006.08-2010.05	Platform/Chassis Engine G9U632/G9U650		○	GWB3501	
	2006.08-2010.05	Platform/Chassis Engine G9U632/G9U650		○	GWB3614	
2.5 D (59 kW)	1998.10-2000.09	Platform/Chassis Engine S8U770	•		GWB3500	
	1998.10-2000.09	Platform/Chassis Engine S8U770	•		GWB3613	
	1998.10-2000.09	Platform/Chassis Engine S8U770		○	GWB3501	
	1998.10-2000.09	Platform/Chassis Engine S8U770		○	GWB3614	



	 YEAR		F	R	G-AP Ref.	KIT
VAUXHALL						
MOVANO I (A) CHASSIS/CAB (ED, UD, HD)						
2.5 DTi (84 kW)	2001.10-2010.05	Platform/Chassis Engine G9U720/G9U724/G9U754	•		GWB3500	
	2001.10-2010.05	Platform/Chassis Engine G9U720/G9U724/G9U754	•		GWB3613	
	2001.10-2010.05	Platform/Chassis Engine G9U720/G9U724/G9U754		○	GWB3501	
	2001.10-2010.05	Platform/Chassis Engine G9U720/G9U724/G9U754		○	GWB3614	
2.8 DTi (84 kW)	1998.10-2001.10	Platform/Chassis Engine S9W702	•		GWB3500	
	1998.10-2001.10	Platform/Chassis Engine S9W702	•		GWB3613	
	1998.10-2001.10	Platform/Chassis Engine S9W702		○	GWB3501	
	1998.10-2001.10	Platform/Chassis Engine S9W702		○	GWB3614	
3.0 DTi (100 kW)	2003.10-2010.05	Platform/Chassis Engine ZD3202	•		GWB3613	
	2003.10-2010.05	Platform/Chassis Engine ZD3202		○	GWB3501	
	2003.10-2010.05	Platform/Chassis Engine ZD3202		○	GWB3614	
MOVANO I (A) VAN (FD)						
1.9 DTi (59 kW)	2000.09-2001.10	Box Engine F9Q770	•		GWB3500	
	2000.09-2001.10	Box Engine F9Q770	•		GWB3613	
	2000.09-2001.10	Box Engine F9Q770		○	GWB3501	
	2000.09-2001.10	Box Engine F9Q770		○	GWB3614	
1.9 DTi (60 kW)	2001.10-2010.05	Box Engine F9Q774	•		GWB3500	
	2001.10-2010.05	Box Engine F9Q774	•		GWB3613	
	2001.10-2010.05	Box Engine F9Q774		○	GWB3501	
	2001.10-2010.05	Box Engine F9Q774		○	GWB3614	
2.2 DTi (66 kW)	2000.09-2010.05	Box Engine G9T720/G9T722/G9T750	•		GWB3500	
	2000.09-2010.05	Box Engine G9T720/G9T722/G9T750	•		GWB3613	
	2000.09-2010.05	Box Engine G9T720/G9T722/G9T750		○	GWB3501	
	2000.09-2010.05	Box Engine G9T720/G9T722/G9T750		○	GWB3614	
2.5 CDTi (107 kW)	2006.08-2010.05	Box Engine G9U632	•		GWB3613	
	2006.08-2010.05	Box Engine G9U632		○	GWB3501	
	2006.08-2010.05	Box Engine G9U632		○	GWB3614	
2.5 CDTi (74 kW)	2004.04-2010.05	Box Engine G9U650/G9U754	•		GWB3613	
	2004.04-2010.05	Box Engine G9U650/G9U754		○	GWB3501	
	2004.04-2010.05	Box Engine G9U650/G9U754		○	GWB3614	
2.5 CDTi (88 kW)	2006.08-2010.05	Box Engine G9U632/G9U650	•		GWB3613	
	2006.08-2010.05	Box Engine G9U632/G9U650		○	GWB3501	
	2006.08-2010.05	Box Engine G9U632/G9U650		○	GWB3614	
2.5 D (59 kW)	1998.10-2000.09	Box Engine S8U770	•		GWB3500	
	1998.10-2000.09	Box Engine S8U770	•		GWB3613	
	1998.10-2000.09	Box Engine S8U770		○	GWB3501	
	1998.10-2000.09	Box Engine S8U770		○	GWB3614	
2.5 DTi (84 kW)	2001.10-2010.05	Box Engine G9U720/G9U724/G9U750/G9U754	•		GWB3500	
	2001.10-2010.05	Box Engine G9U720/G9U724/G9U750/G9U754	•		GWB3613	
	2001.10-2010.05	Box Engine G9U720/G9U724/G9U750/G9U754		○	GWB3501	
	2001.10-2010.05	Box Engine G9U720/G9U724/G9U750/G9U754		○	GWB3614	
2.8 TDi (84 kW)	1998.10-2001.10	Box Engine S9W702	•		GWB3500	
	1998.10-2001.10	Box Engine S9W702	•		GWB3613	
	1998.10-2001.10	Box Engine S9W702		○	GWB3501	
	1998.10-2001.10	Box Engine S9W702		○	GWB3614	
3.0 DTi (100 kW)	2003.10-2010.05	Box Engine ZD3202	•		GWB3613	
	2003.10-2010.05	Box Engine ZD3202		○	GWB3501	
MOVANO II (B) CHASSIS/CAB						
2.3 CDTi (107 kW)	2010.05-	Platform/Chassis Engine M9T678/M9T680	•		GWB6721	
	2010.05-	Platform/Chassis Engine M9T678/M9T680		○	GWB6722	
	2010.07-	Platform/Chassis Engine M9T694/M9T696/M9T698	•		GWB6721	
	2010.07-	Platform/Chassis Engine M9T694/M9T696/M9T698		○	GWB6742	
2.3 CDTi (110 kW)	2013.01-	Platform/Chassis	•		GWB6721	
	2013.01-	Platform/Chassis	•		GWB6721	
	2013.01-	Platform/Chassis		○	GWB6722	
	2013.01-	Platform/Chassis		○	GWB6742	
2.3 CDTi (74 kW)	2010.05-	Platform/Chassis Engine M9T670/M9T672/M9T676	•		GWB6721	
	2010.05-	Platform/Chassis Engine M9T670/M9T672/M9T676		○	GWB6722	
	2010.07-	Platform/Chassis Engine M9T690/M9T692	•		GWB6721	
	2010.07-	Platform/Chassis Engine M9T690/M9T692		○	GWB6742	
2.3 CDTi (92 kW)	2010.05-	Platform/Chassis Engine M9T670/M9T672/M9T676/M9T680	•		GWB6721	
	2010.05-	Platform/Chassis Engine M9T670/M9T672/M9T676/M9T680		○	GWB6722	
	2010.07-	Platform/Chassis Engine M9T686/M9T690/M9T692/M9T696/M9T698	•		GWB6721	
	2010.07-	Platform/Chassis Engine M9T686/M9T690/M9T692/M9T696/M9T698		○	GWB6742	



	 YEAR		F	R	G-AP Ref.	KIT
VAUXHALL						
MOVANO II (B) COMBI						
2.3 CDTi (107 kW)	2010.05-	Bus Engine M9T678/M9T680	•		GWB6721	
	2010.05-	Bus Engine M9T678/M9T680		◦	GWB6722	
2.3 CDTi (110 kW)	2013.01-	Bus	•		GWB6721	
	2013.01-	Bus		◦	GWB6722	
2.3 CDTi (74 kW)	2010.05-	Bus Engine M9T670/M9T672/M9T676	•		GWB6721	
	2010.05-	Bus Engine M9T670/M9T672/M9T676		◦	GWB6722	
2.3 CDTi (92 kW)	2010.05-	Bus Engine M9T670/M9T672/M9T676/M9T680	•		GWB6721	
	2010.05-	Bus Engine M9T670/M9T672/M9T676/M9T680		◦	GWB6722	
MOVANO II (B) VAN						
2.3 CDTi (107 kW)	2010.05-	Box Engine M9T678/M9T680	•		GWB6721	
	2010.05-	Box Engine M9T678/M9T680		◦	GWB6722	
	2010.05-	Box Engine M9T694/M9T696/M9T698	•		GWB6721	
	2010.05-	Box Engine M9T694/M9T696/M9T698		◦	GWB6742	
2.3 CDTi (110 kW)	2013.01-	Box	•		GWB6721	
	2013.01-	Box	•		GWB6721	
	2013.01-	Box		◦	GWB6722	
	2013.01-	Box		◦	GWB6742	
2.3 CDTi (74 kW)	2010.05-	Box Engine M9T670/M9T672/M9T676	•		GWB6721	
	2010.05-	Box Engine M9T670/M9T672/M9T676		◦	GWB6722	
	2010.05-	Box Engine M9T690/M9T692	•		GWB6721	
	2010.05-	Box Engine M9T690/M9T692		◦	GWB6742	
2.3 CDTi (92 kW)	2010.05-	Box Engine M9T670/M9T672/M9T676/M9T680	•		GWB6721	
	2010.05-	Box Engine M9T670/M9T672/M9T676/M9T680		◦	GWB6722	
	2010.05-	Box Engine M9T686/M9T690/M9T692/M9T696/M9T692/M9T698	•		GWB6721	
	2010.05-	Box Engine M9T686/M9T690/M9T692/M9T696/M9T692/M9T698		◦	GWB6742	
MOVANO MK II (B) VAN						
2.3 CDTi [RWD] (100 kW)	2014.05-	Box Engine M9T 700	•		GWB6721	
	2014.05-	Box Engine M9T 700		◦	GWB6742	
2.3 CDTi [RWD] (120 kW)	2014.05-	Box Engine M9T 700	•		GWB6721	
	2014.05-	Box Engine M9T 700		◦	GWB6742	
2.3 CDTi FWD (100 kW)	2014.05-	Box Engine M9T 702	•		GWB6721	
	2014.05-	Box Engine M9T 702		◦	GWB6722	
2.3 CDTi FWD (120 kW)	2014.05-	Box Engine M9T 700	•		GWB6721	
	2014.05-	Box Engine M9T 700		◦	GWB6722	
2.3 CDTi FWD (81 kW)	2012.02-	Box Engine M9T 870	•		GWB6721	
	2012.02-	Box Engine M9T 870		◦	GWB6722	
NOVA						
1.2 N (38 kW)	1990.01-1993.03	Hatchback Engine 12NV	•		GHA422006	K
	1990.01-1993.03	Hatchback Engine 12NV	•		GWB3256	
	1990.01-1993.03	Hatchback Engine 12NV	•		GWB3403	
	1990.01-1993.03	Hatchback Engine 12NV		◦	GWB0944	
	1990.01-1993.03	Hatchback Engine 12NV			GWB0663	
1.4 (44 kW)	1990.10-1992.08	Saloon Engine C14NZ	•		GHA422006	K
	1990.10-1992.08	Saloon Engine C14NZ	•		GWB3256	
	1990.10-1992.08	Saloon Engine C14NZ	•		GWB3403	
	1990.10-1992.08	Saloon Engine C14NZ		◦	GWB0944	
	1990.10-1992.08	Saloon Engine C14NZ			GWB0663	
1.4 (60 kW)	1990.09-1992.08	Saloon Engine C14SE	•		GHA422006	K
	1990.09-1992.08	Saloon Engine C14SE	•		GWB3256	
	1990.09-1992.08	Saloon Engine C14SE	•		GWB3403	
	1990.09-1992.08	Saloon Engine C14SE		◦	GWB0944	
1.4 i (44 kW)	1990.01-1993.03	Hatchback Engine C14NZ	•		GHA422006	K
	1990.01-1993.03	Hatchback Engine C14NZ	•		GWB3256	
	1990.01-1993.03	Hatchback Engine C14NZ	•		GWB3403	
	1990.01-1993.03	Hatchback Engine C14NZ		◦	GWB0944	
	1990.01-1993.03	Hatchback Engine C14NZ			GWB0663	
1.4 i S (60 kW)	1991.09-1993.03	Hatchback Engine C14SE	•		GHA422006	K
	1991.09-1993.03	Hatchback Engine C14SE	•		GWB3256	
	1991.09-1993.03	Hatchback Engine C14SE	•		GWB3403	
	1991.09-1993.03	Hatchback Engine C14SE		◦	GWB0944	
	1991.09-1993.03	Hatchback Engine C14SE			GWB0663	
1.4 S (55 kW)	1990.01-1993.02	Saloon Engine 14NV	•		GHA422006	K
	1990.01-1993.02	Saloon Engine 14NV	•		GWB3256	
	1990.01-1993.02	Saloon Engine 14NV	•		GWB3403	



	 YEAR		F	R	G-AP Ref.	KIT	
VAUXHALL							
NOVA							
1.4 S (55 kW)	1990.01-1993.02	Saloon Engine 14NV		o	GWB0944		
	1990.01-1993.02	Saloon Engine 14NV			GWB0663		
	1990.01-1993.03	Hatchback Engine 14NV	•		GHA422006	K	
	1990.01-1993.03	Hatchback Engine 14NV	•		GWB3256		
	1990.01-1993.03	Hatchback Engine 14NV	•		GWB3403		
	1990.01-1993.03	Hatchback Engine 14NV		o	GWB0944		
1.5 TD (49 kW)	1990.01-1993.02	Saloon Engine 15DT(T4EC1)	•		GWB3256		
	1990.01-1993.02	Saloon Engine 15DT(T4EC1)	•		GWB3403		
	1990.01-1993.02	Saloon Engine 15DT(T4EC1)		o	GWB0944		
	1990.01-1993.02	Saloon Engine 15DT(T4EC1)			GWB0663		
	1990.01-1993.03	Hatchback Engine 15DT(T4EC1)	•		GHA422006	K	
	1990.01-1993.03	Hatchback Engine 15DT(T4EC1)	•		GWB3256		
	1990.01-1993.03	Hatchback Engine 15DT(T4EC1)	•		GWB3403		
	1990.01-1993.03	Hatchback Engine 15DT(T4EC1)		o	GWB0944		
	1990.01-1993.03	Hatchback Engine 15DT(T4EC1)			GWB0663		
	1990.01-1993.03	Hatchback Engine 15DT(T4EC1)			GWB0663		
1.6 GSi CAT (74 kW)	1992.02-1993.03	Hatchback Engine C16SE	•		GHA422006	K	
	1992.02-1993.03	Hatchback Engine C16SE	•		GWB3256		
	1992.02-1993.03	Hatchback Engine C16SE	•		GWB3403		
	1992.02-1993.03	Hatchback Engine C16SE		o	GWB0944		
	1992.02-1993.03	Hatchback Engine C16SE			GWB0663		
NOVAVAN							
1.2 (38 kW)	1990.01-1994.10	Box Engine 12NV	•		GWB3256		
	1990.01-1994.10	Box Engine 12NV	•		GWB3403		
	1990.01-1994.10	Box Engine 12NV		o	GWB0944		
	1990.01-1994.10	Box Engine 12NV			GWB0663		
1.4 (55 kW)	1990.11-1993.03	Box Engine 14NV	•		GHA422006	K	
	1990.11-1993.03	Box Engine 14NV	•		GWB3256		
	1990.11-1993.03	Box Engine 14NV	•		GWB3403		
	1990.11-1993.03	Box Engine 14NV		o	GWB0944		
	1990.11-1993.03	Box Engine 14NV			GWB0663		
1.5 D (37 kW)	1991.01-1994.10	Box Engine 15D	•		GHA422006	K	
	1991.01-1994.10	Box Engine 15D	•		GWB3256		
	1991.01-1994.10	Box Engine 15D	•		GWB3403		
	1991.01-1994.10	Box Engine 15D		o	GWB0944		
	1991.01-1994.10	Box Engine 15D			GWB0663		
OMEGA (B)							
2.0 (85 kW)	1994.03-1999.09	Estate Engine X20SE		o	GWB1326		
	1994.03-1999.09	Estate Engine X20SE With ABS	•		GHA235001	K	
	1994.03-1999.09	Estate Engine X20SE With ABS	•		GHA235001	K	
	1994.03-1999.09	Estate Engine X20SE Without ABS	•		GHA235013		
	1994.03-1999.09	Estate Engine X20SE Without ABS	•		GHA235013		
	1994.03-1999.09	Saloon Engine X20SE		o	GWB1326		
	1994.03-1999.09	Saloon Engine X20SE		o	GWB3410		
	1994.03-1999.09	Saloon Engine X20SE With ABS	•		GHA235001	K	
	1994.03-1999.09	Saloon Engine X20SE With ABS	•		GHA235001	K	
	1994.03-1999.09	Saloon Engine X20SE Without ABS	•		GHA235013		
	1994.03-1999.09	Saloon Engine X20SE Without ABS	•		GHA235013		
	1995.09-1996.09	Saloon Engine 20SE		o	GWB1326		
	1995.09-1996.09	Saloon Engine 20SE		o	GWB3410		
	1995.09-1996.09	Saloon Engine 20SE With ABS	•		GHA235001	K	
	1995.09-1996.09	Saloon Engine 20SE With ABS	•		GHA235001	K	
	1995.09-1996.09	Saloon Engine 20SE Without ABS	•		GHA235013		
	1995.09-1996.09	Saloon Engine 20SE Without ABS	•		GHA235013		
	2.0 16V (100 kW)	1994.03-1999.09	Saloon Engine X20XEV		o	GWB1326	
		1994.03-1999.09	Saloon Engine X20XEV		o	GWB3410	
		1994.03-1999.09	Saloon Engine X20XEV With ABS	•		GHA235001	K
1994.03-1999.09		Saloon Engine X20XEV With ABS	•		GHA235001	K	
1994.03-1999.09		Saloon Engine X20XEV Without ABS	•		GHA235013		
1994.03-1999.09		Saloon Engine X20XEV Without ABS	•		GHA235013		
1994.03-2001.02		Estate Engine X20XEV		o	GWB1326		
1994.03-2001.02		Estate Engine X20XEV With ABS	•		GHA235001	K	
1994.03-2001.02		Estate Engine X20XEV With ABS	•		GHA235001	K	
1994.03-2001.02		Estate Engine X20XEV Without ABS	•		GHA235013		
1994.03-2001.02		Estate Engine X20XEV Without ABS	•		GHA235013		



	 YEAR		F	R	G-AP Ref.	KIT
VAUXHALL						
OMEGA (B)						
2.0 DTi 16V (74 kW)	1998.01-2000.09	Estate Engine X20DTH		o	GWB1326	
	1998.01-2000.09	Estate Engine X20DTH With ABS	•		GHA235001	K
	1998.01-2000.09	Estate Engine X20DTH With ABS	•		GHA235001	K
	1998.01-2000.09	Estate Engine X20DTH Without ABS	•		GHA235013	
	1998.01-2000.09	Estate Engine X20DTH Without ABS	•		GHA235013	
	1998.01-2000.09	Saloon Engine X20DTH		o	GWB1326	
	1998.01-2000.09	Saloon Engine X20DTH		o	GWB3410	
	1998.01-2000.09	Saloon Engine X20DTH With ABS	•		GHA235001	K
	1998.01-2000.09	Saloon Engine X20DTH With ABS	•		GHA235001	K
	1998.01-2000.09	Saloon Engine X20DTH Without ABS	•		GHA235013	
2.2 16V (106 kW)	1994.01-2003.06	Saloon Engine Y22XE/Z22XE		o	GWB1326	
	1994.01-2003.06	Saloon Engine Y22XE/Z22XE		o	GWB3410	
	1994.01-2003.06	Saloon Engine Y22XE/Z22XE With ABS	•		GHA235001	K
	1994.01-2003.06	Saloon Engine Y22XE/Z22XE With ABS	•		GHA235001	K
	1994.01-2003.06	Saloon Engine Y22XE/Z22XE Without ABS	•		GHA235013	
	1994.01-2003.06	Saloon Engine Y22XE/Z22XE Without ABS	•		GHA235013	
	1994.02-2003.06	Estate Engine Y22XE/Z22XE		o	GWB1326	
	1994.02-2003.06	Estate Engine Y22XE/Z22XE With ABS	•		GHA235001	K
	1994.02-2003.06	Estate Engine Y22XE/Z22XE With ABS	•		GHA235001	K
	1994.02-2003.06	Estate Engine Y22XE/Z22XE Without ABS	•		GHA235013	
2.2 DTi 16V (88 kW)	2000.08-2003.06	Estate Engine Y22DTH		o	GWB1326	
	2000.08-2003.06	Estate Engine Y22DTH With ABS	•		GHA235001	K
	2000.08-2003.06	Estate Engine Y22DTH With ABS	•		GHA235001	K
	2000.08-2003.06	Estate Engine Y22DTH Without ABS	•		GHA235013	
	2000.08-2003.06	Estate Engine Y22DTH Without ABS	•		GHA235013	
	2000.08-2003.07	Saloon Engine Y22DTH		o	GWB1326	
	2000.08-2003.07	Saloon Engine Y22DTH		o	GWB3410	
	2000.08-2003.07	Saloon Engine Y22DTH With ABS	•		GHA235001	K
	2000.08-2003.07	Saloon Engine Y22DTH With ABS	•		GHA235001	K
	2000.08-2003.07	Saloon Engine Y22DTH Without ABS	•		GHA235013	
2.5 DTi 24V (110 kW)	2001.09-2003.06	Estate Engine Y25DT		o	GWB1326	
	2001.09-2003.06	Estate Engine Y25DT With ABS	•		GHA235001	K
	2001.09-2003.06	Estate Engine Y25DT With ABS	•		GHA235001	K
	2001.09-2003.06	Estate Engine Y25DT Without ABS	•		GHA235013	
	2001.09-2003.06	Estate Engine Y25DT Without ABS	•		GHA235013	
	2001.09-2003.07	Saloon Engine Y25DT		o	GWB1326	
	2001.09-2003.07	Saloon Engine Y25DT		o	GWB3410	
	2001.09-2003.07	Saloon Engine Y25DT With ABS	•		GHA235001	K
	2001.09-2003.07	Saloon Engine Y25DT With ABS	•		GHA235001	K
	2001.09-2003.07	Saloon Engine Y25DT Without ABS	•		GHA235013	
2.5 TD (96 kW)	1994.04-2001.07	Estate Engine 25DT/X25DT		o	GWB1326	
	1994.04-2001.07	Estate Engine 25DT/X25DT With ABS	•		GHA235001	K
	1994.04-2001.07	Estate Engine 25DT/X25DT With ABS	•		GHA235001	K
	1994.04-2001.07	Estate Engine 25DT/X25DT Without ABS	•		GHA235013	
	1994.04-2001.07	Estate Engine 25DT/X25DT Without ABS	•		GHA235013	
	1994.04-2001.07	Saloon Engine 25DT/X25DT		o	GWB1326	
	1994.04-2001.07	Saloon Engine 25DT/X25DT		o	GWB3410	
	1994.04-2001.07	Saloon Engine 25DT/X25DT With ABS	•		GHA235001	K
	1994.04-2001.07	Saloon Engine 25DT/X25DT With ABS	•		GHA235001	K
	1994.04-2001.07	Saloon Engine 25DT/X25DT Without ABS	•		GHA235013	
2.5 V6 (125 kW)	1994.03-2000.09	Estate Engine X25XE		o	GWB1326	
	1994.03-2000.09	Estate Engine X25XE With ABS	•		GHA235001	K
	1994.03-2000.09	Estate Engine X25XE With ABS	•		GHA235001	K
	1994.03-2000.09	Estate Engine X25XE Without ABS	•		GHA235013	
	1994.03-2000.09	Estate Engine X25XE Without ABS	•		GHA235013	
	1994.03-2000.09	Saloon Engine X25XE		o	GWB1326	
	1994.03-2000.09	Saloon Engine X25XE		o	GWB3410	
	1994.03-2000.09	Saloon Engine X25XE With ABS	•		GHA235001	K
	1994.03-2000.09	Saloon Engine X25XE With ABS	•		GHA235001	K
	1994.03-2000.09	Saloon Engine X25XE With ABS	•		GHA235001	K



	 YEAR		F	R	G-AP Ref.	KIT
VAUXHALL						
OMEGA (B)						
2.5 V6 (125 kW)	1994.03-2000.09	Saloon Engine X25XE Without ABS	•		GHA235013	
	1994.03-2000.09	Saloon Engine X25XE Without ABS	•		GHA235013	
2.6 V6 (132 kW)	2000.08-2003.06	Estate Engine Y26SE		◦	GWB1326	
	2000.08-2003.06	Estate Engine Y26SE With ABS	•		GHA235001	K
	2000.08-2003.06	Estate Engine Y26SE With ABS	•		GHA235001	K
	2000.08-2003.06	Estate Engine Y26SE Without ABS	•		GHA235013	
	2000.08-2003.06	Estate Engine Y26SE Without ABS	•		GHA235013	
	2000.08-2003.07	Saloon Engine Y26SE		◦	GWB1326	
	2000.08-2003.07	Saloon Engine Y26SE		◦	GWB3410	
	2000.08-2003.07	Saloon Engine Y26SE With ABS	•		GHA235001	K
	2000.08-2003.07	Saloon Engine Y26SE With ABS	•		GHA235001	K
	2000.08-2003.07	Saloon Engine Y26SE Without ABS	•		GHA235013	
	2000.08-2003.07	Saloon Engine Y26SE Without ABS	•		GHA235013	
3.0 V6 (155 kW)	1994.04-2000.07	Saloon Engine X30XE		◦	GWB1326	
	1994.04-2000.07	Saloon Engine X30XE		◦	GWB3410	
	1994.04-2000.07	Saloon Engine X30XE With ABS	•		GHA235001	K
	1994.04-2000.07	Saloon Engine X30XE With ABS	•		GHA235001	K
	1994.04-2000.07	Saloon Engine X30XE Without ABS	•		GHA235013	
	1994.04-2000.07	Saloon Engine X30XE Without ABS	•		GHA235013	
	1994.07-2000.07	Estate Engine X30XE		◦	GWB1326	
	1994.07-2000.07	Estate Engine X30XE With ABS	•		GHA235001	K
	1994.07-2000.07	Estate Engine X30XE With ABS	•		GHA235001	K
	1994.07-2000.07	Estate Engine X30XE Without ABS	•		GHA235013	
	1994.07-2000.07	Estate Engine X30XE Without ABS	•		GHA235013	
3.2 V6 (160 kW)	2001.02-2003.06	Estate Engine Y32SE		◦	GWB1326	
	2001.02-2003.06	Estate Engine Y32SE With ABS	•		GHA235001	K
	2001.02-2003.06	Estate Engine Y32SE With ABS	•		GHA235001	K
	2001.02-2003.06	Estate Engine Y32SE Without ABS	•		GHA235013	
	2001.02-2003.06	Estate Engine Y32SE Without ABS	•		GHA235013	
	2001.02-2003.07	Saloon Engine Y32SE		◦	GWB1326	
	2001.02-2003.07	Saloon Engine Y32SE		◦	GWB3410	
	2001.02-2003.07	Saloon Engine Y32SE With ABS	•		GHA235001	K
	2001.02-2003.07	Saloon Engine Y32SE With ABS	•		GHA235001	K
	2001.02-2003.07	Saloon Engine Y32SE Without ABS	•		GHA235013	
	2001.02-2003.07	Saloon Engine Y32SE Without ABS	•		GHA235013	
SENATOR II (B)						
2.6 i (110 kW)	1990.09-1993.09	Saloon Engine C26NE		◦	GWB1326	
	1990.09-1993.09	Saloon Engine C26NE With ABS	•		GHA235001	K
	1990.09-1993.09	Saloon Engine C26NE With ABS	•		GHA235001	K
	1990.09-1993.09	Saloon Engine C26NE Without ABS	•		GHA235013	
	1990.09-1993.09	Saloon Engine C26NE Without ABS	•		GHA235013	
SIGNUM						
1.8 (103 kW)	2005.08-2008.05	Hatchback Engine Z18XER	•		GHA330021	K
	2005.08-2008.05	Hatchback Engine Z18XER		◦	GHA400137	K
1.8 (90 kW)	2003.06-2005.07	Hatchback Engine Z18XE	•		GHA330011	K
	2003.06-2005.07	Hatchback Engine Z18XE	•		GHA330021	K
	2003.06-2005.07	Hatchback Engine Z18XE		◦	GHA400137	K
1.9 CDTi (88 kW)	2004.04-2008.03	Hatchback Engine Z19DT	•		GHA330011	K
	2004.04-2008.03	Hatchback Engine Z19DT	•		GHA330021	K
	2004.04-2008.03	Hatchback Engine Z19DT		◦	GHA400137	K
1.9 CDTi 16V (110 kW)	2004.04-2008.03	Hatchback Engine Z19DTH	•		GHA330011	K
	2004.04-2008.03	Hatchback Engine Z19DTH	•		GHA330021	K
	2004.04-2008.03	Hatchback Engine Z19DTH		◦	GHA400137	K
1.9 Turbo (74 kW)	2005.01-2008.05	Hatchback Engine Z19DTL	•		GHA330021	K
	2005.01-2008.05	Hatchback Engine Z19DTL		◦	GHA400137	K
2.0 DTi (74 kW)	2003.05-2008.05	Hatchback Engine Y20DTH	•		GHA330011	K
	2003.05-2008.05	Hatchback Engine Y20DTH	•		GHA330021	K
	2003.05-2008.05	Hatchback Engine Y20DTH		◦	GHA400137	K
2.0 i Turbo (129 kW)	2002.01-2008.10	Hatchback Engine Z20NET	•		GHA330011	K
	2002.01-2008.10	Hatchback Engine Z20NET	•		GHA330021	K
	2002.01-2008.10	Hatchback Engine Z20NET		◦	GHA400137	K
2.2 DTi (92 kW)	2003.05-2008.05	Hatchback Engine Y22DTR	•		GHA330011	K
	2003.05-2008.05	Hatchback Engine Y22DTR	•		GHA330021	K
	2003.05-2008.05	Hatchback Engine Y22DTR		◦	GHA400137	K



	 YEAR		F	R	G-AP Ref.	KIT
VAUXHALL						
SIGNUM						
2.2 i (114 kW)	2003.05-2008.05	Hatchback Engine Z22YH	•		GHA330011	K
	2003.05-2008.05	Hatchback Engine Z22YH	•		GHA330021	K
	2003.05-2008.05	Hatchback Engine Z22YH		○	GHA400137	K
2.8 V6 Turbo (169 kW)	2002.04-2008.05	Hatchback Engine Z28NEL	•		GHA330021	K
	2002.04-2008.05	Hatchback Engine Z28NEL		○	GHA400137	K
3.0 CDTi (130 kW)	2003.05-2008.05	Hatchback Engine Y30DT	•		GHA330011	K
	2003.05-2008.05	Hatchback Engine Y30DT	•		GHA330021	K
	2003.05-2008.05	Hatchback Engine Y30DT		○	GHA400137	K
3.0 V6 CDTi (135 kW)	2002.04-2008.05	Hatchback Engine Z30DT	•		GHA330021	K
	2002.04-2008.05	Hatchback Engine Z30DT		○	GHA400137	K
3.2 V6 (155 kW)	2003.05-2008.05	Hatchback Engine Z32SE	•		GHA330011	K
	2003.05-2008.05	Hatchback Engine Z32SE	•		GHA330021	K
	2003.05-2008.05	Hatchback Engine Z32SE		○	GHA400137	K
SINTRA						
2.2 DTi (85 kW)	1997.07-1999.04	MPV Engine X22DTH	•		GHA333083	K
	1997.07-1999.04	MPV Engine X22DTH		○	GHA400013	
	1997.07-1999.04	MPV Engine X22DTH		○	GHA400031	
2.2 i 16V (104 kW)	1996.11-1999.04	MPV Engine X22XE	•		GHA333083	K
	1996.11-1999.04	MPV Engine X22XE		○	GHA400013	
	1996.11-1999.04	MPV Engine X22XE		○	GHA400031	
3.0 i 24V (148 kW)	1996.11-1999.04	MPV Engine X30XE	•		GHA333083	K
	1996.11-1999.04	MPV Engine X30XE		○	GHA400013	
	1996.11-1999.04	MPV Engine X30XE		○	GHA400031	
TIGRA I (F07)						
1.4 16V (66 kW)	1994.07-2000.12	Coupe Engine X14XE	•		GHA422006	K
	1994.07-2000.12	Coupe Engine X14XE	•		GWB3403	
	1994.07-2000.12	Coupe Engine X14XE		○	GWB0944	
1.6 16V (78 kW)	1994.07-2000.12	Coupe Engine X16XE	•		GHA422006	K
	1994.07-2000.12	Coupe Engine X16XE	•		GWB3403	
	1994.07-2000.12	Coupe Engine X16XE		○	GWB0944	
TIGRA TWINTOP						
1.3 CDTi (51 kW)	2004.06-2009.08	Convertible Engine Z13DT	•		GHA422014	
	2004.06-2009.08	Convertible Engine Z13DT		○	GHA227023	K
	2004.06-2009.08	Convertible Engine Z13DT		○	GWB3601	
1.4 (66 kW)	2004.06-2009.08	Convertible Engine Z14XEP	•		GHA422014	
	2004.06-2009.08	Convertible Engine Z14XEP		○	GHA227023	K
	2004.06-2009.08	Convertible Engine Z14XEP		○	GWB3601	
1.8 (92 kW)	2004.06-2009.08	Convertible Engine Z18XE	•		GHA422014	
	2004.06-2009.08	Convertible Engine Z18XE		○	GHA227023	K
	2004.06-2009.08	Convertible Engine Z18XE		○	GWB3601	
VECTRA (B)						
1.6 i (55 kW)	1995.08-2001.10	Hatchback Engine X16SZR	•		GHA422023	
	1995.08-2001.10	Hatchback Engine X16SZR	•		GHA433004	
	1995.08-2001.10	Hatchback Engine X16SZR	•		GHA433019	
	1995.08-2001.10	Hatchback Engine X16SZR	•		GWB3410	
	1995.08-2001.10	Hatchback Engine X16SZR With ABS		○	GHA400052	K
	1995.08-2001.10	Hatchback Engine X16SZR With ABS		○	GHA400064	K
	1995.08-2001.10	Saloon Engine X16SZR	•		GHA422023	
	1995.08-2001.10	Saloon Engine X16SZR	•		GHA433004	
	1995.08-2001.10	Saloon Engine X16SZR	•		GHA433019	
	1995.08-2001.10	Saloon Engine X16SZR	•		GWB3410	
	1995.08-2001.10	Saloon Engine X16SZR With ABS		○	GHA400052	K
1.6 i 16V (74 kW)	1995.08-2001.10	Hatchback Engine X16XEL/Y16XE/Z16XE	•		GHA422023	
	1995.08-2001.10	Hatchback Engine X16XEL/Y16XE/Z16XE	•		GHA433004	
	1995.08-2001.10	Hatchback Engine X16XEL/Y16XE/Z16XE	•		GHA433019	
	1995.08-2001.10	Hatchback Engine X16XEL/Y16XE/Z16XE With ABS		○	GHA400052	K
	1995.08-2001.10	Hatchback Engine X16XEL/Y16XE/Z16XE With ABS		○	GHA400064	K
	1995.08-2001.10	Saloon Engine X16XEL/Y16XE/Z16XE	•		GHA422023	
	1995.08-2001.10	Saloon Engine X16XEL/Y16XE/Z16XE	•		GHA433004	
	1995.08-2001.10	Saloon Engine X16XEL/Y16XE/Z16XE	•		GHA433019	
	1995.08-2001.10	Saloon Engine X16XEL/Y16XE/Z16XE	•		GWB3410	
	1995.08-2001.10	Saloon Engine X16XEL/Y16XE/Z16XE With ABS		○	GHA400052	K
	1995.08-2001.10	Saloon Engine X16XEL/Y16XE/Z16XE With ABS		○	GHA400064	K



	 YEAR		F	R	G-AP Ref.	KIT	
VAUXHALL							
VECTRA (B)							
1.7 TD (60 kW)	1995.10-1996.11	Hatchback Engine X17DT(TC4EE1)	•		GHA433004		
	1995.10-1996.11	Hatchback Engine X17DT(TC4EE1)	•		GHA433019		
	1995.10-1996.11	Hatchback Engine X17DT(TC4EE1)	•		GWB3410		
	1995.10-1996.11	Hatchback Engine X17DT(TC4EE1) With ABS		○	GHA400064	K	
	1995.10-1996.11	Saloon Engine X17DT(TC4EE1)	•		GHA433004		
	1995.10-1996.11	Saloon Engine X17DT(TC4EE1)	•		GHA433019		
	1995.10-1996.11	Saloon Engine X17DT(TC4EE1)	•		GWB3410		
	1995.10-1996.11	Saloon Engine X17DT(TC4EE1) With ABS		○	GHA400064	K	
	1.8 i 16V (85 kW)	1995.10-2000.09	Hatchback Engine X18XE/X18XE1	•		GHA433004	
		1995.10-2000.09	Hatchback Engine X18XE/X18XE1	•		GHA433019	
1995.10-2000.09		Hatchback Engine X18XE/X18XE1	•		GWB3410		
1995.10-2000.09		Hatchback Engine X18XE/X18XE1 With ABS		○	GHA400052	K	
1995.10-2000.09		Hatchback Engine X18XE/X18XE1 With ABS		○	GHA400064	K	
1995.10-2000.09		Saloon Engine X18XE/X18XE1	•		GHA433004		
1995.10-2000.09		Saloon Engine X18XE/X18XE1	•		GHA433019		
1995.10-2000.09		Saloon Engine X18XE/X18XE1	•		GWB3410		
1995.10-2000.09		Saloon Engine X18XE/X18XE1 With ABS		○	GHA400052	K	
1995.10-2000.09		Saloon Engine X18XE/X18XE1 With ABS		○	GHA400064	K	
1996.11-2000.09		Estate Engine X18XE/X18XE1	•		GHA433004		
1996.11-2000.09		Estate Engine X18XE/X18XE1	•		GHA433019		
1996.11-2000.09		Estate Engine X18XE/X18XE1	•		GWB3410		
1996.11-2000.09		Estate Engine X18XE/X18XE1 With ABS		○	GHA400052	K	
1996.11-2000.09		Estate Engine X18XE/X18XE1 With ABS		○	GHA400064	K	
1.8 i 16V (92 kW)		2000.09-2002.03	Estate Engine Z18XE	•		GHA433004	
	2000.09-2002.03	Estate Engine Z18XE	•		GHA433019		
	2000.09-2002.03	Estate Engine Z18XE	•		GWB3410		
	2000.09-2002.03	Estate Engine Z18XE With ABS		○	GHA400052	K	
	2000.09-2002.03	Estate Engine Z18XE With ABS		○	GHA400064	K	
	2000.09-2002.03	Saloon Engine Z18XE	•		GHA433004		
	2000.09-2002.03	Saloon Engine Z18XE	•		GHA433019		
	2000.09-2002.03	Saloon Engine Z18XE	•		GWB3410		
	2000.09-2002.03	Saloon Engine Z18XE With ABS		○	GHA400052	K	
	2000.09-2002.03	Saloon Engine Z18XE With ABS		○	GHA400064	K	
	2000.09-2003.07	Hatchback Engine Z18XE	•		GHA433004		
	2000.09-2003.07	Hatchback Engine Z18XE	•		GHA433019		
	2000.09-2003.07	Hatchback Engine Z18XE	•		GWB3410		
	2000.09-2003.07	Hatchback Engine Z18XE With ABS		○	GHA400052	K	
	2000.09-2003.07	Hatchback Engine Z18XE With ABS		○	GHA400064	K	
	2.0 Di 16V (60 kW)	1995.08-2001.10	Estate Engine X20DTL	•		GHA433004	
1995.08-2001.10		Estate Engine X20DTL	•		GHA433019		
1995.08-2001.10		Estate Engine X20DTL	•		GWB3410		
1995.08-2001.10		Estate Engine X20DTL With ABS		○	GHA400052	K	
1995.08-2001.10		Estate Engine X20DTL With ABS		○	GHA400064	K	
1995.08-2001.10		Hatchback Engine X20DTL	•		GHA433004		
1995.08-2001.10		Hatchback Engine X20DTL	•		GHA433019		
1995.08-2001.10		Hatchback Engine X20DTL	•		GWB3410		
1995.08-2001.10		Hatchback Engine X20DTL With ABS		○	GHA400052	K	
1995.08-2001.10		Hatchback Engine X20DTL With ABS		○	GHA400064	K	
1995.08-2001.10		Saloon Engine X20DTL	•		GHA433004		
1995.08-2001.10		Saloon Engine X20DTL	•		GHA433019		
1995.08-2001.10		Saloon Engine X20DTL	•		GWB3410		
1995.08-2001.10		Saloon Engine X20DTL With ABS		○	GHA400052	K	
1995.08-2001.10		Saloon Engine X20DTL With ABS		○	GHA400064	K	
2.0 DTi 16V (74 kW)		1995.08-2001.10	Estate Engine X20DTH/Y20DTH	•		GHA433004	
	1995.08-2001.10	Estate Engine X20DTH/Y20DTH	•		GHA433019		
	1995.08-2001.10	Estate Engine X20DTH/Y20DTH	•		GWB3410		
	1995.08-2001.10	Estate Engine X20DTH/Y20DTH With ABS		○	GHA400052	K	
	1995.08-2001.10	Estate Engine X20DTH/Y20DTH With ABS		○	GHA400064	K	
	1995.08-2001.10	Saloon Engine X20DTH/Y20DTH	•		GHA433004		
	1995.08-2001.10	Saloon Engine X20DTH/Y20DTH	•		GHA433019		
	1995.08-2001.10	Saloon Engine X20DTH/Y20DTH	•		GWB3410		
	1995.08-2001.10	Saloon Engine X20DTH/Y20DTH With ABS		○	GHA400052	K	
	1995.08-2001.10	Saloon Engine X20DTH/Y20DTH With ABS		○	GHA400064	K	
	1997.06-2001.10	Hatchback Engine X20DTH/Y20DTH	•		GHA433004		



	 YEAR		F	R	G-AP Ref.	KIT
VAUXHALL						
VECTRA (B)						
2.0 DTi 16V (74 kW)	1997.06-2001.10	Hatchback Engine X20DTH/Y20DTH	•		GHA433019	
	1997.06-2001.10	Hatchback Engine X20DTH/Y20DTH	•		GWB3410	
	1997.06-2001.10	Hatchback Engine X20DTH/Y20DTH With ABS		◦	GHA400052	K
	1997.06-2001.10	Hatchback Engine X20DTH/Y20DTH With ABS		◦	GHA400064	K
2.0 i 16V (100 kW)	1995.10-2001.01	Estate Engine X20XEV	•		GHA433004	
	1995.10-2001.01	Estate Engine X20XEV	•		GWB3410	
	1995.10-2001.01	Estate Engine X20XEV With ABS		◦	GHA400052	K
	1995.10-2001.01	Estate Engine X20XEV With ABS		◦	GHA400064	K
	1995.10-2001.01	Hatchback Engine X20XEV	•		GHA433004	
	1995.10-2001.01	Hatchback Engine X20XEV	•		GWB3410	
	1995.10-2001.01	Hatchback Engine X20XEV With ABS		◦	GHA400052	K
	1995.10-2001.01	Hatchback Engine X20XEV With ABS		◦	GHA400064	K
	1995.10-2001.01	Saloon Engine X20XEV	•		GHA433004	
	1995.10-2001.01	Saloon Engine X20XEV	•		GWB3410	
	1995.10-2001.01	Saloon Engine X20XEV With ABS		◦	GHA400052	K
	1995.10-2001.01	Saloon Engine X20XEV With ABS		◦	GHA400064	K
2.2 DTi 16V (92 kW)	1995.08-2001.10	Estate Engine Y22DTR	•		GHA433004	
	1995.08-2001.10	Estate Engine Y22DTR	•		GWB3410	
	1995.08-2001.10	Estate Engine Y22DTR With ABS		◦	GHA400052	K
	1995.08-2001.10	Hatchback Engine Y22DTR	•		GHA433004	
	1995.08-2001.10	Hatchback Engine Y22DTR	•		GWB3410	
	1995.08-2001.10	Hatchback Engine Y22DTR With ABS		◦	GHA400052	K
	1995.08-2001.10	Saloon Engine Y22DTR	•		GHA433004	
	1995.08-2001.10	Saloon Engine Y22DTR	•		GWB3410	
	1995.08-2001.10	Saloon Engine Y22DTR With ABS		◦	GHA400052	K
	1995.08-2001.10	Saloon Engine Y22DTR With ABS		◦	GHA400064	K
2.2 i 16V (108 kW)	1995.08-2001.10	Estate Engine Z22SE	•		GHA433004	
	1995.08-2001.10	Estate Engine Z22SE	•		GWB3410	
	1995.08-2001.10	Estate Engine Z22SE With ABS		◦	GHA400052	K
	1995.08-2001.10	Saloon Engine Z22SE	•		GHA433004	
	1995.08-2001.10	Saloon Engine Z22SE	•		GWB3410	
	1995.08-2001.10	Saloon Engine Z22SE With ABS		◦	GHA400052	K
	2000.09-2003.07	Hatchback Engine Z22SE	•		GHA433004	
	2000.09-2003.07	Hatchback Engine Z22SE	•		GWB3410	
	2000.09-2003.07	Hatchback Engine Z22SE With ABS		◦	GHA400052	K
	2000.09-2003.07	Hatchback Engine Z22SE With ABS		◦	GHA400064	K
2.5 i GSi (143 kW)	1998.03-2000.07	Hatchback Engine X25XE	•		GHA433004	
	1998.03-2000.07	Hatchback Engine X25XE	•		GWB3410	
	1998.03-2000.07	Hatchback Engine X25XE With ABS		◦	GHA400052	K
	1998.03-2000.07	Hatchback Engine X25XE With ABS		◦	GHA400064	K
	1998.03-2000.07	Saloon Engine X25XE	•		GWB3410	
	1998.03-2000.07	Saloon Engine X25XE With ABS		◦	GHA400052	K
	1998.03-2000.07	Saloon Engine X25XE With ABS		◦	GHA400064	K
	1998.05-1999.09	Estate Engine X25XE	•		GWB3410	
	1998.05-1999.09	Estate Engine X25XE With ABS		◦	GHA400052	K
	1998.05-1999.09	Estate Engine X25XE With ABS		◦	GHA400064	K
2.5 i V6 (125 kW)	1995.09-2000.08	Hatchback Engine X25XE	•		GHA433004	
	1995.09-2000.08	Hatchback Engine X25XE	•		GWB3410	
	1995.09-2000.08	Hatchback Engine X25XE With ABS		◦	GHA400052	K
	1995.09-2000.08	Hatchback Engine X25XE With ABS		◦	GHA400064	K
	1995.09-2000.08	Saloon Engine X25XE	•		GHA433004	
	1995.09-2000.08	Saloon Engine X25XE	•		GWB3410	
	1995.09-2000.08	Saloon Engine X25XE With ABS		◦	GHA400052	K
	1995.09-2000.08	Saloon Engine X25XE With ABS		◦	GHA400064	K
	1996.11-2000.08	Estate Engine X25XE	•		GHA433004	
	1996.11-2000.08	Estate Engine X25XE	•		GWB3410	
	1996.11-2000.08	Estate Engine X25XE With ABS		◦	GHA400052	K
	1996.11-2000.08	Estate Engine X25XE With ABS		◦	GHA400064	K
	2000.09-2002.03	Estate Engine Y26SE	•		GHA433004	
	2000.09-2002.03	Estate Engine Y26SE	•		GWB3410	
2000.09-2002.03	Estate Engine Y26SE With ABS		◦	GHA400052	K	
2000.09-2002.03	Saloon Engine Y26SE	•		GHA433004		
2000.09-2002.03	Saloon Engine Y26SE	•		GWB3410		
2000.09-2002.03	Saloon Engine Y26SE With ABS		◦	GHA400052	K	
2000.09-2003.07	Hatchback Engine Y26SE	•		GHA433004		
2000.09-2003.07	Hatchback Engine Y26SE	•		GWB3410		



	 YEAR		F	R	G-AP Ref.	KIT
VAUXHALL						
VECTRA (B)						
2.6 i V6 (125 kW)	2000.09-2003.07	Hatchback Engine Y26SE With ABS		o	GHA400052	K
VECTRA II (C)						
1.8 (103 kW)	2006.01-2008.07	Estate Engine Z18XER	•		GHA330021	K
	2006.01-2008.07	Estate Engine Z18XER		o	GHA400137	K
	2006.01-2008.07	Saloon Engine Z18XER	•		GHA330021	K
	2006.01-2008.07	Saloon Engine Z18XER		o	GHA400137	K
1.8 16V (90 kW)	2002.04-2008.07	Saloon Engine Z18XE	•		GHA330011	K
	2002.04-2008.07	Saloon Engine Z18XE	•		GHA330021	K
	2002.04-2008.07	Saloon Engine Z18XE		o	GHA400137	K
	2003.10-2005.08	Estate Engine Z18XE	•		GHA330011	K
	2003.10-2005.08	Estate Engine Z18XE	•		GHA330021	K
	2003.10-2005.08	Estate Engine Z18XE		o	GHA400137	K
1.8 16V Dualfuel (90 kW)	2002.04-2008.07	Saloon Engine Z18XE	•		GHA330011	K
	2002.04-2008.07	Saloon Engine Z18XE	•		GHA330021	K
	2002.04-2008.07	Saloon Engine Z18XE		o	GHA400137	K
1.9 CDTi (88 kW)	2002.04-2008.09	Saloon Engine Z19DT	•		GHA330011	K
	2002.04-2008.09	Saloon Engine Z19DT	•		GHA330021	K
	2002.04-2008.09	Saloon Engine Z19DT		o	GHA400137	K
	2004.04-2008.07	Estate Engine Z19DT	•		GHA330011	K
	2004.04-2008.07	Estate Engine Z19DT	•		GHA330021	K
	2004.04-2008.07	Estate Engine Z19DT		o	GHA400137	K
1.9 CDTi 16V (110 kW)	2004.04-2008.07	Estate Engine Z19DTH	•		GHA330011	K
	2004.04-2008.07	Estate Engine Z19DTH	•		GHA330021	K
	2004.04-2008.07	Estate Engine Z19DTH		o	GHA400137	K
	2004.04-2008.08	Saloon Engine Z19DTH	•		GHA330011	K
	2004.04-2008.08	Saloon Engine Z19DTH	•		GHA330021	K
	2004.04-2008.08	Saloon Engine Z19DTH		o	GHA400137	K
2.0 16V Turbo (129 kW)	2000.01-2008.10	Saloon Engine Z20NET	•		GHA330011	K
	2000.01-2008.10	Saloon Engine Z20NET	•		GHA330021	K
	2000.01-2008.10	Saloon Engine Z20NET		o	GHA400137	K
	2003.10-2008.07	Estate Engine Z20NET	•		GHA330011	K
	2003.10-2008.07	Estate Engine Z20NET	•		GHA330021	K
	2003.10-2008.07	Estate Engine Z20NET		o	GHA400137	K
2.0 DTi 16V (74 kW)	2002.04-2008.10	Saloon Engine Y20DTH	•		GHA330011	K
	2002.04-2008.10	Saloon Engine Y20DTH	•		GHA330021	K
	2002.04-2008.10	Saloon Engine Y20DTH		o	GHA400137	K
	2003.10-2008.07	Estate Engine Y20DTH	•		GHA330011	K
	2003.10-2008.07	Estate Engine Y20DTH	•		GHA330021	K
	2003.10-2008.07	Estate Engine Y20DTH		o	GHA400137	K
2.2 16V (108 kW)	2002.01-2008.10	Saloon Engine Z22SE	•		GHA330011	K
	2002.01-2008.10	Saloon Engine Z22SE	•		GHA330021	K
	2002.01-2008.10	Saloon Engine Z22SE		o	GHA400137	K
2.2 Direct (114 kW)	2002.01-2008.10	Saloon Engine Z22YH	•		GHA330011	K
	2002.01-2008.10	Saloon Engine Z22YH	•		GHA330021	K
	2002.01-2008.10	Saloon Engine Z22YH		o	GHA400137	K
	2003.10-2008.07	Estate Engine Z22YH	•		GHA330011	K
	2003.10-2008.07	Estate Engine Z22YH	•		GHA330021	K
	2003.10-2008.07	Estate Engine Z22YH		o	GHA400137	K
2.2 DTi 16V (92 kW)	2002.04-2008.10	Saloon Engine Y22DTR	•		GHA330011	K
	2002.04-2008.10	Saloon Engine Y22DTR	•		GHA330021	K
	2002.04-2008.10	Saloon Engine Y22DTR		o	GHA400137	K
	2003.10-2008.07	Estate Engine Y22DTR	•		GHA330011	K
	2003.10-2008.07	Estate Engine Y22DTR	•		GHA330021	K
	2003.10-2008.07	Estate Engine Y22DTR		o	GHA400137	K
2.8 V6 Turbo (169 kW)	2005.08-2008.07	Estate Engine Z28NEL	•		GHA330021	K
	2005.08-2008.07	Estate Engine Z28NEL		o	GHA400137	K
2.8 V6 Turbo (188 kW)	2006.08-2008.07	Estate Engine Z28NET	•		GHA330021	K
	2006.08-2008.07	Estate Engine Z28NET		o	GHA400137	K
2.8 V6 Turbo (206 kW)	2006.10-2008.07	Estate Engine Z28NET	•		GHA330021	K
	2006.10-2008.07	Estate Engine Z28NET		o	GHA400137	K
3.0 CDTi (135 kW)	2005.08-2008.07	Estate Engine Z30DT	•		GHA330021	K
	2005.08-2008.07	Estate Engine Z30DT		o	GHA400137	K
	2005.08-2008.07	Saloon Engine Z30DT	•		GHA330021	K
	2005.08-2008.07	Saloon Engine Z30DT		o	GHA400137	K



	 YEAR		F	R	G-AP Ref.	KIT
VAUXHALL						
VECTRA II (C)						
3.0 V6 CDTi (130 kW)	2003.06-2005.08	Saloon Engine Y30DT	•		GHA330011	K
	2003.06-2005.08	Saloon Engine Y30DT	•		GHA330021	K
	2003.06-2005.08	Saloon Engine Y30DT		◦	GHA400137	K
	2003.10-2005.08	Estate Engine Y30DT	•		GHA330011	K
	2003.10-2005.08	Estate Engine Y30DT	•		GHA330021	K
	2003.10-2005.08	Estate Engine Y30DT		◦	GHA400137	K
3.2 V6 (155 kW)	2003.06-2008.07	Saloon Engine Z32SE	•		GHA330011	K
	2003.06-2008.07	Saloon Engine Z32SE	•		GHA330021	K
	2003.06-2008.07	Saloon Engine Z32SE		◦	GHA400137	K
	2003.10-2005.08	Estate Engine Z32SE	•		GHA330011	K
	2003.10-2005.08	Estate Engine Z32SE	•		GHA330021	K
	2003.10-2005.08	Estate Engine Z32SE		◦	GHA400137	K
VECTRA II (C) GTS						
1.8 (103 kW)	2006.01-2008.07	Hatchback Engine Z18XER	•		GHA330021	K
	2006.01-2008.07	Hatchback Engine Z18XER		◦	GHA400137	K
1.8 16V (90 kW)	2002.08-2008.07	Hatchback Engine Z18XE	•		GHA330011	K
	2002.08-2008.07	Hatchback Engine Z18XE	•		GHA330021	K
	2002.08-2008.07	Hatchback Engine Z18XE		◦	GHA400137	K
1.8 16V Dualfuel (90 kW)	2002.08-2008.07	Hatchback Engine Z18XE	•		GHA330011	K
	2002.08-2008.07	Hatchback Engine Z18XE	•		GHA330021	K
	2002.08-2008.07	Hatchback Engine Z18XE		◦	GHA400137	K
1.9 CDTi (88 kW)	2002.08-2008.07	Hatchback Engine Z19DT	•		GHA330011	K
	2002.08-2008.07	Hatchback Engine Z19DT	•		GHA330021	K
	2002.08-2008.07	Hatchback Engine Z19DT		◦	GHA400137	K
1.9 CDTi 16V (110 kW)	2004.04-2008.07	Hatchback Engine Z19DTH	•		GHA330011	K
	2004.04-2008.07	Hatchback Engine Z19DTH	•		GHA330021	K
	2004.04-2008.07	Hatchback Engine Z19DTH		◦	GHA400137	K
2.0 16V Turbo (129 kW)	2003.03-2008.07	Hatchback Engine Z20NET	•		GHA330011	K
	2003.03-2008.07	Hatchback Engine Z20NET	•		GHA330021	K
	2003.03-2008.07	Hatchback Engine Z20NET		◦	GHA400137	K
2.0 DTi 16V (74 kW)	2002.08-2008.07	Hatchback Engine Y20DTH	•		GHA330011	K
	2002.08-2008.07	Hatchback Engine Y20DTH	•		GHA330021	K
	2002.08-2008.07	Hatchback Engine Y20DTH		◦	GHA400137	K
2.2 16V (108 kW)	2002.08-2008.07	Hatchback Engine Z22SE	•		GHA330011	K
	2002.08-2008.07	Hatchback Engine Z22SE	•		GHA330021	K
	2002.08-2008.07	Hatchback Engine Z22SE		◦	GHA400137	K
2.2 Direct (114 kW)	2003.10-2005.08	Hatchback Engine Z22YH	•		GHA330011	K
	2003.10-2005.08	Hatchback Engine Z22YH	•		GHA330021	K
	2003.10-2005.08	Hatchback Engine Z22YH		◦	GHA400137	K
2.2 DTi 16V (92 kW)	2002.08-2008.07	Hatchback Engine Y22DTR	•		GHA330011	K
	2002.08-2008.07	Hatchback Engine Y22DTR	•		GHA330021	K
	2002.08-2008.07	Hatchback Engine Y22DTR		◦	GHA400137	K
2.8 V6 Turbo (169 kW)	2005.08-2008.07	Hatchback Engine Z28NEL	•		GHA330021	K
	2005.08-2008.07	Hatchback Engine Z28NEL		◦	GHA400137	K
2.8 V6 Turbo (184 kW)	2006.08-2008.07	Hatchback Engine Z28NET	•		GHA330021	K
	2006.08-2008.07	Hatchback Engine Z28NET		◦	GHA400137	K
2.8 V6 Turbo (188 kW)	2005.08-2008.07	Hatchback Engine Z28NET	•		GHA330021	K
	2005.08-2008.07	Hatchback Engine Z28NET		◦	GHA400137	K
2.8 V6 Turbo (206 kW)	2006.08-	Hatchback Engine Z28NET	•		GHA330021	K
	2006.08-	Hatchback Engine Z28NET		◦	GHA400137	K
3.0 CDTi (135 kW)	2005.08-2008.07	Hatchback Engine Z30DT	•		GHA330021	K
	2005.08-2008.07	Hatchback Engine Z30DT		◦	GHA400137	K
3.0 V6 CDTi (130 kW)	2003.06-2005.08	Hatchback Engine Y30DT	•		GHA330011	K
	2003.06-2005.08	Hatchback Engine Y30DT	•		GHA330021	K
	2003.06-2005.08	Hatchback Engine Y30DT		◦	GHA400137	K
3.2 V6 (155 kW)	2002.08-2008.07	Hatchback Engine Z32SE	•		GHA330011	K
	2002.08-2008.07	Hatchback Engine Z32SE	•		GHA330021	K
	2002.08-2008.07	Hatchback Engine Z32SE		◦	GHA400137	K
VIVARO (E7)						
1.9 Di (59 kW)	2001.08-	Platform/Chassis Engine F9Q762	•		GWB3616	
	2001.08-	Platform/Chassis Engine F9Q762	•		GWB3618	
	2001.08-	Platform/Chassis Engine F9Q762	•		GWB3648	
	2001.08-	Platform/Chassis Engine F9Q762		◦	GWB3617	
2.0 16V (88 kW)	2003.04-	Platform/Chassis Engine F4R720	•		GWB3616	



	 YEAR		F	R	G-AP Ref.	KIT
VAUXHALL						
VIVARO (E7)						
2.0 16V (88 kW)	2003.04-	Platform/Chassis Engine F4R720	•		GWB3618	
	2003.04-	Platform/Chassis Engine F4R720	•		GWB3648	
	2003.04-	Platform/Chassis Engine F4R720		o	GWB3617	
2.0 CDTi (66 kW)	2006.01-	Platform/Chassis Engine M9R630/M9R782	•		GWB3648	
	2006.01-	Platform/Chassis Engine M9R630/M9R782		o	GHA235025	
	2006.01-	Platform/Chassis Engine M9R630/M9R782		o	GWB3617	
2.0 CDTi (84 kW)	2006.08-	Platform/Chassis Engine M9R630/M9R780/M9R788	•		GWB3648	
	2006.08-	Platform/Chassis Engine M9R630/M9R780/M9R788		o	GHA235025	
	2006.08-	Platform/Chassis Engine M9R630/M9R780/M9R788		o	GWB3617	
2.0 EcoTec (86 kW)	2006.08-	Platform/Chassis Engine F4R820	•		GWB3648	
	2006.08-	Platform/Chassis Engine F4R820		o	GWB3617	
2.5 CDTi (107 kW)	2006.08-	Platform/Chassis Engine G9U630	•		GWB3648	
	2006.08-	Platform/Chassis Engine G9U630		o	GHA235025	
	2006.08-	Platform/Chassis Engine G9U630		o	GWB3617	
	2006.08-	Platform/Chassis Engine G9U730	•		GWB3648	
	2006.08-	Platform/Chassis Engine G9U730		o	GWB3617	
2.5 CDTi (99 kW)	2003.04-2006.07	Platform/Chassis Engine G9U630/G9U730	•		GWB3616	
	2003.04-2006.07	Platform/Chassis Engine G9U630/G9U730	•		GWB3618	
	2003.04-2006.07	Platform/Chassis Engine G9U630/G9U730	•		GWB3648	
	2003.04-2006.07	Platform/Chassis Engine G9U630/G9U730		o	GHA235025	
	2003.04-2006.07	Platform/Chassis Engine G9U630/G9U730		o	GWB3617	
VIVARO (F7)						
1.9 Di (59 kW)	2001.08-2006.12	Box Engine F9Q762	•		GWB3616	
	2001.08-2006.12	Box Engine F9Q762	•		GWB3618	
	2001.08-2006.12	Box Engine F9Q762	•		GWB3648	
	2001.08-2006.12	Box Engine F9Q762		o	GHA235025	
	2001.08-2006.12	Box Engine F9Q762		o	GWB3617	
1.9 DTi (74 kW)	2001.08-2006.12	Box Engine F9Q760	•		GWB3616	
	2001.08-2006.12	Box Engine F9Q760	•		GWB3618	
	2001.08-2006.12	Box Engine F9Q760	•		GWB3648	
	2001.08-2006.12	Box Engine F9Q760		o	GHA235025	
	2001.08-2006.12	Box Engine F9Q760		o	GWB3617	
2.0 16V (88 kW)	2001.08-2006.12	Box Engine F4R720	•		GWB3616	
	2001.08-2006.12	Box Engine F4R720	•		GWB3618	
	2001.08-2006.12	Box Engine F4R720	•		GWB3648	
	2001.08-2006.12	Box Engine F4R720		o	GHA235025	
	2001.08-2006.12	Box Engine F4R720		o	GWB3617	
2.0 CDTi (66 kW)	2006.01-	Box Engine M9R630/M9R780/M9R782/M9R786	•		GWB3648	
	2006.01-	Box Engine M9R630/M9R780/M9R782/M9R786		o	GHA235025	
	2006.01-	Box Engine M9R630/M9R780/M9R782/M9R786		o	GWB3617	
2.0 CDTi (84 kW)	2006.08-	Box Engine M9R630/M9R780/M9R788	•		GWB3648	
	2006.08-	Box Engine M9R630/M9R780/M9R788		o	GHA235025	
	2006.08-	Box Engine M9R630/M9R780/M9R788		o	GWB3617	
2.0 EcoTec (86 kW)	2006.08-	Box Engine F4R820	•		GWB3648	
	2006.08-	Box Engine F4R820		o	GWB3617	
2.5 CDTi (107 kW)	2006.08-	Box Engine G9U630	•		GWB3648	
	2006.08-	Box Engine G9U630		o	GHA235025	
	2006.08-	Box Engine G9U630		o	GWB3617	
2.5 DTi (99 kW)	2004.04-	Box Engine G9U730/G9U630	•		GWB3616	
	2004.04-	Box Engine G9U730/G9U630	•		GWB3618	
	2004.04-	Box Engine G9U730/G9U630	•		GWB3648	
	2004.04-	Box Engine G9U730/G9U630		o	GHA235025	
	2004.04-	Box Engine G9U730/G9U630		o	GWB3617	
VIVARO (J7)						
1.9 Di (59 kW)	2001.08-2006.12	Bus Engine F9Q762	•		GWB3616	
	2001.08-2006.12	Bus Engine F9Q762	•		GWB3618	
	2001.08-2006.12	Bus Engine F9Q762	•		GWB3648	
	2001.08-2006.12	Bus Engine F9Q762		o	GHA235025	
	2001.08-2006.12	Bus Engine F9Q762		o	GWB3617	
1.9 DTi (74 kW)	2001.08-2006.12	Bus Engine F9Q760	•		GWB3616	
	2001.08-2006.12	Bus Engine F9Q760	•		GWB3618	
	2001.08-2006.12	Bus Engine F9Q760	•		GWB3648	
	2001.08-2006.12	Bus Engine F9Q760		o	GHA235025	
	2001.08-2006.12	Bus Engine F9Q760		o	GWB3617	



	 YEAR		F	R	G-AP Ref.	KIT
VAUXHALL						
VIVARO (J7)						
2.0 16V (88 kW)	2001.08-2006.12	Bus Engine F4R720	•		GWB3616	
	2001.08-2006.12	Bus Engine F4R720	•		GWB3618	
	2001.08-2006.12	Bus Engine F4R720	•		GWB3648	
	2001.08-2006.12	Bus Engine F4R720		○	GHA235025	
	2001.08-2006.12	Bus Engine F4R720		○	GWB3617	
2.0 CDTi (66 kW)	2006.01-	Bus Engine M9R630/M9R780/M9R782/M9R786	•		GWB3648	
	2006.01-	Bus Engine M9R630/M9R780/M9R782/M9R786		○	GHA235025	
	2006.01-	Bus Engine M9R630/M9R780/M9R782/M9R786		○	GWB3617	
2.0 CDTi (84 kW)	2006.08-	Bus Engine M9R630/M9R780/M9R784/M9R786/M9R788	•		GWB3648	
	2006.08-	Bus Engine M9R630/M9R780/M9R784/M9R786/M9R788		○	GHA235025	
	2006.08-	Bus Engine M9R630/M9R780/M9R784/M9R786/M9R788		○	GWB3617	
2.0 EcoTec (86 kW)	2006.08-	Bus Engine F4R820	•		GWB3648	
	2006.08-	Bus Engine F4R820		○	GWB3617	
2.5 CDTi (107 kW)	2006.01-	Bus Engine G9U630	•		GWB3648	
	2006.01-	Bus Engine G9U630		○	GHA235025	
	2006.01-	Bus Engine G9U630		○	GWB3617	
2.5 DTi (99 kW)	2004.04-	Bus Engine G9U730/G9U630	•		GWB3616	
	2004.04-	Bus Engine G9U730/G9U630	•		GWB3618	
	2004.04-	Bus Engine G9U730/G9U630	•		GWB3648	
	2004.04-	Bus Engine G9U730/G9U630		○	GHA235025	
	2004.04-	Bus Engine G9U730/G9U630		○	GWB3617	
ZAFIRA I (A) (F75)						
1.6 16V (74 kW)	1999.04-2005.08	MPV Engine X16XEL/Z16XE	•		GHA333102	K
	1999.04-2005.08	MPV Engine X16XEL/Z16XE With ABS	•		GHA333029	K
	1999.04-2005.08	MPV Engine X16XEL/Z16XE With ABS		○	GHA400052	K
	1999.04-2005.08	MPV Engine X16XEL/Z16XE Without ABS		○	GHA400053	K
1.6 CNG (71 kW)	2001.09-2005.06	MPV Engine Z16YNG	•		GHA333102	K
	2001.09-2005.06	MPV Engine Z16YNG With ABS	•		GHA333029	K
	2001.09-2005.06	MPV Engine Z16YNG With ABS		○	GHA400052	K
	2001.09-2005.06	MPV Engine Z16YNG Without ABS		○	GHA400053	K
1.6 Dualfuel (74 kW)	1998.11-2005.08	MPV Engine X16XEL/Z16XE	•		GHA333102	K
	1998.11-2005.08	MPV Engine X16XEL/Z16XE With ABS	•		GHA333029	K
	1998.11-2005.08	MPV Engine X16XEL/Z16XE With ABS		○	GHA400052	K
	1998.11-2005.08	MPV Engine X16XEL/Z16XE Without ABS		○	GHA400053	K
1.8 16V (85 kW)	1999.05-2000.08	MPV Engine X18XE1	•		GHA333102	K
	1999.05-2000.08	MPV Engine X18XE1 With ABS	•		GHA333029	K
	1999.05-2000.08	MPV Engine X18XE1 With ABS		○	GHA400052	K
	1999.05-2000.08	MPV Engine X18XE1 Without ABS		○	GHA400053	K
1.8 16V (92 kW)	2000.09-2005.08	MPV Engine Z18XE	•		GHA333102	K
	2000.09-2005.08	MPV Engine Z18XE With ABS	•		GHA333029	K
	2000.09-2005.08	MPV Engine Z18XE With ABS		○	GHA400052	K
	2000.09-2005.08	MPV Engine Z18XE Without ABS		○	GHA400053	K
1.8 Dualfuel (92 kW)	2000.09-2005.08	MPV Engine Z18XE	•		GHA333102	K
	2000.09-2005.08	MPV Engine Z18XE With ABS	•		GHA333029	K
	2000.09-2005.08	MPV Engine Z18XE With ABS		○	GHA400052	K
	2000.09-2005.08	MPV Engine Z18XE Without ABS		○	GHA400053	K
2.0 Di 16V (60 kW)	1999.10-2005.08	MPV Engine X20DTL	•		GHA333102	K
	1999.10-2005.08	MPV Engine X20DTL With ABS	•		GHA333029	K
	1999.10-2005.08	MPV Engine X20DTL With ABS		○	GHA400052	K
	1999.10-2005.08	MPV Engine X20DTL Without ABS		○	GHA400053	K
2.0 DTi 16V (74 kW)	1999.04-2005.08	MPV Engine Y20DTH	•		GHA333102	K
	1999.04-2005.08	MPV Engine Y20DTH With ABS	•		GHA333029	K
	1999.04-2005.08	MPV Engine Y20DTH With ABS		○	GHA400052	K
	1999.04-2005.08	MPV Engine Y20DTH Without ABS		○	GHA400053	K
2.0 GSi Turbo (141 kW)	2001.09-2005.06	MPV Engine Z20LET	•		GHA333102	K
	2001.09-2005.06	MPV Engine Z20LET With ABS	•		GHA333029	K
	2001.09-2005.06	MPV Engine Z20LET With ABS		○	GHA400052	K
	2001.09-2005.06	MPV Engine Z20LET Without ABS		○	GHA400053	K
2.2 16V (108 kW)	1998.11-2004.08	MPV Engine Z22SE	•		GHA333102	K
	1998.11-2004.08	MPV Engine Z22SE With ABS	•		GHA333029	K
	1998.11-2004.08	MPV Engine Z22SE With ABS		○	GHA400052	K
	1998.11-2004.08	MPV Engine Z22SE Without ABS		○	GHA400053	K
2.2 D (92 kW)	2001.06-2005.06	MPV Engine Y22DTR	•		GHA333102	K
	2001.06-2005.06	MPV Engine Y22DTR With ABS	•		GHA333029	K



	 YEAR		F	R	G-AP Ref.	KIT
VAUXHALL						
ZAFIRA I (A) (F75)						
2.2 D (92 kW)	2001.06-2005.06	MPV Engine Y22DTR With ABS		o	GHA400052	K
	2001.06-2005.06	MPV Engine Y22DTR Without ABS		o	GHA400053	K
ZAFIRA II (B) (M75)						
1.6 (77 kW)	2005.07-	MPV Engine Z16XEP	•		GHA333070	K
	2005.07-	MPV Engine Z16XEP		o	GHA400133	K
1.6 (85 kW)	2007.12-	MPV Engine A16XER/Z16XER	•		GHA333070	K
	2007.12-	MPV Engine A16XER/Z16XER		o	GHA400133	K
1.6 CNG (69 kW)	2005.07-	MPV Engine Z16YNG	•		GHA333097	K
1.6 CNG Turbo (110 kW)	2009.02-	MPV Engine A16XNT/Z16XNT	•		GHA333097	K
	2009.02-	MPV Engine A16XNT/Z16XNT		o	GHA400338	K
1.7 CDTi (81 kW)	2009.04-	MPV Engine Z17DTJ/A17DTJ	•		GHA333097	K
	2009.04-	MPV Engine Z17DTJ/A17DTJ		o	GHA400133	K
1.7 CDTi (92 kW)	2008.01-	MPV Engine A17DTR	•		GHA333097	K
	2008.01-	MPV Engine A17DTR		o	GHA400133	K
1.8 (103 kW)	2005.04-	MPV Engine A18XER/Z18XER	•		GHA333070	K
	2005.04-	MPV Engine A18XER/Z18XER		o	GHA400133	K
1.9 CDTi (110 kW)	2005.07-	MPV Engine Z19DTH	•		GHA330013	K
	2005.07-	MPV Engine Z19DTH		o	GHA400133	K
1.9 CDTi (74 kW)	2005.07-	MPV Engine Z19DTL	•		GHA333070	K
	2005.07-	MPV Engine Z19DTL	•		GHA333097	K
	2005.07-	MPV Engine Z19DTL		o	GHA400133	K
1.9 CDTi (88 kW)	2005.07-	MPV Engine Z19DT	•		GHA333070	K
	2005.07-	MPV Engine Z19DT		o	GHA400133	K
2.0 (147 kW)	2005.07-	MPV Engine Z20LER	•		GHA333070	K
	2005.07-	MPV Engine Z20LER	•		GHA333097	K
	2005.07-	MPV Engine Z20LER		o	GHA400133	K
2.0 (176 kW)	2006.01-	MPV Engine Z20LEH	•		GHA333070	K
	2006.01-	MPV Engine Z20LEH	•		GHA333097	K
	2006.01-	MPV Engine Z20LEH		o	GHA400133	K
2.2 (110 kW)	2005.07-	MPV Engine Z22YH	•		GHA333070	K
	2005.07-	MPV Engine Z22YH		o	GHA400133	K
ZAFIRA III (P12)						
1.4 (103 kW)	2011.10-	MPV Engine A14NET	•		GHA330019	K
	2011.10-	MPV Engine A14NET		o	GHA400193	K
1.4 (88 kW)	2011.10-	MPV Engine A14NEL	•		GHA330019	K
	2011.10-	MPV Engine A14NEL		o	GHA400193	K
1.4 LPG (103 kW)	2011.10-	MPV Engine A14NET	•		GHA330019	K
	2011.10-	MPV Engine A14NET		o	GHA400193	K
1.6 CNG (110 kW)	2011.10-	MPV Engine A16XNT	•		GHA330019	K
	2011.10-	MPV Engine A16XNT		o	GHA400193	K
1.8 (103 kW)	2011.10-	MPV Engine A18XER	•		GHA330019	K
	2011.10-	MPV Engine A18XER		o	GHA400193	K
1.8 (85 kW)	2011.10-	MPV Engine A18XEL	•		GHA330019	K
	2011.10-	MPV Engine A18XEL		o	GHA400193	K
1.8 (88 kW)	2011.10-	MPV Engine A18XEL	•		GHA330019	K
	2011.10-	MPV Engine A18XEL		o	GHA400193	K
2.0 CDTi (118 kW)	2011.10-	MPV Engine A20DTH	•		GHA330019	K
	2011.10-	MPV Engine A20DTH		o	GHA400193	K
2.0 CDTi (121 kW)	2011.10-	MPV Engine A20DTH	•		GHA330019	K
	2011.10-	MPV Engine A20DTH		o	GHA400193	K
2.0 CDTi (81 kW)	2011.10-	MPV Engine A20DTL	•		GHA330019	K
	2011.10-	MPV Engine A20DTL		o	GHA400193	K
2.0 CDTi (96 kW)	2011.10-	MPV Engine A20DT/Y20DTJ/Z20DTJ	•		GHA330019	K
	2011.10-	MPV Engine A20DT/Y20DTJ/Z20DTJ		o	GHA400193	K
ZAFIRA MK III (P12)						
1.6 CDTi (100 kW)	2013.03-	MPV Engine B 16 DTH	•		GHA330019	K
1.6 Turbo (125 kW)	2012.12-	MPV Engine A 16 XHT	•		GHA330019	K
2.0 BiTurbo CDTi (143 kW)	2013.01-	MPV Engine A 20 DTR	•		GHA330019	K
2.0 CDTi (125 kW)	2015.01-	MPV Engine B 20 DTH	•		GHA330019	K
VOLKSWAGEN						
BEETLE						
1.6 i (34 kW)	1992.10-2003.07	Special Design Engine ACD	•		GWB0529	



	 YEAR		F	R	G-AP Ref.	KIT
VOLKSWAGEN						
BEETLE (5C1)						
1.2 TSi (77 kW)	2011.07-	Hatchback Engine CBZB 4 hole	•		GHA336007	K
	2011.07-	Hatchback Engine CBZB Inner Diameter [30mm]		○	GHA230082	K
	2011.07-	Hatchback Engine CBZB Inner Diameter [32mm]		○	GHA232018	K
1.2 TSi 16V (77 kW)	2014.12-	Hatchback Engine CYVD 4 hole	•		GHA336007	K
	2014.12-	Hatchback Engine CYVD Inner Diameter [30mm]		○	GHA230082	K
	2014.12-	Hatchback Engine CYVD Inner Diameter [32mm]		○	GHA232018	K
1.4 TSi (110 kW)	2014.12-	Hatchback Engine CZDA 4 hole	•		GHA336007	K
	2014.12-	Hatchback Engine CZDA Inner Diameter [30mm]		○	GHA230082	K
	2014.12-	Hatchback Engine CZDA Inner Diameter [32mm]		○	GHA232018	K
1.4 TSi (118 kW)	2011.04-	Hatchback Engine CAVD/CNWA/CTHD/CTKA 4 hole	•		GHA336007	K
	2011.04-	Hatchback Engine CAVD/CNWA/CTHD/CTKA Inner Diameter [30mm]		○	GHA230082	K
	2011.04-	Hatchback Engine CAVD/CNWA/CTHD/CTKA Inner Diameter [32mm]		○	GHA232018	K
1.6 TDi (77 kW)	2011.10-	Hatchback Engine CAYC 4 hole	•		GHA336007	K
	2011.10-	Hatchback Engine CAYC Inner Diameter [30mm]		○	GHA230082	K
	2011.10-	Hatchback Engine CAYC Inner Diameter [32mm]		○	GHA232018	K
2.0 TDi (103 kW)	2011.04-	Hatchback Engine CFFB/CJAA 4 hole	•		GHA336007	K
	2011.04-	Hatchback Engine CFFB/CJAA Inner Diameter [30mm]		○	GHA230082	K
	2011.04-	Hatchback Engine CFFB/CJAA Inner Diameter [32mm]		○	GHA232018	K
2.0 TDi (110 kW)	2014.07-	Hatchback Engine CUUB/CVCA 4 hole	•		GHA336007	K
	2014.07-	Hatchback Engine CUUB/CVCA Inner Diameter [30mm]		○	GHA230082	K
	2014.07-	Hatchback Engine CUUB/CVCA Inner Diameter [32mm]		○	GHA232018	K
2.0 TDi (81 kW)	2014.06-	Hatchback Engine CUUA 4 hole	•		GHA336007	K
	2014.06-	Hatchback Engine CUUA Inner Diameter [30mm]		○	GHA230082	K
	2014.06-	Hatchback Engine CUUA Inner Diameter [32mm]		○	GHA232018	K
2.0 TSi (147 kW)	2011.04-	Hatchback Engine CBFA/CCTA/CCZA 4 hole	•		GHA336007	K
	2011.04-	Hatchback Engine CBFA/CCTA/CCZA Inner Diameter [30mm]		○	GHA230082	K
	2011.04-	Hatchback Engine CBFA/CCTA/CCZA Inner Diameter [32mm]		○	GHA232018	K
2.0 TSi (155 kW)	2012.12-	Hatchback Engine CPPA/CPLA 4 hole	•		GHA336007	K
	2012.12-	Hatchback Engine CPPA/CPLA Inner Diameter [30mm]		○	GHA230082	K
	2012.12-	Hatchback Engine CPPA/CPLA Inner Diameter [32mm]		○	GHA232018	K
2.0 TSi (162 kW)	2014.12-	Hatchback Engine CULC 4 hole	•		GHA336007	K
	2014.12-	Hatchback Engine CULC Inner Diameter [30mm]		○	GHA230082	K
	2014.12-	Hatchback Engine CULC Inner Diameter [32mm]		○	GHA232018	K
2.5 (125 kW)	2011.04-	Hatchback Engine CCCA/CBUA/CBTA 4 hole	•		GHA336007	K
	2011.04-	Hatchback Engine CCCA/CBUA/CBTA Inner Diameter [30mm]		○	GHA230082	K
	2011.04-	Hatchback Engine CCCA/CBUA/CBTA Inner Diameter [32mm]		○	GHA232018	K
BEETLE (5C7)						
1.2 TSi (77 kW)	2012.12-	Convertible Engine CBZB 4 hole	•		GHA336007	K
	2012.12-	Convertible Engine CBZB Inner Diameter [30mm]		○	GHA230082	K
	2012.12-	Convertible Engine CBZB Inner Diameter [32mm]		○	GHA232018	K
1.2 TSi 16V (77 kW)	2014.12-	Convertible Engine CYVD 4 hole	•		GHA336007	K
	2014.12-	Convertible Engine CYVD Inner Diameter [30mm]		○	GHA230082	K
	2014.12-	Convertible Engine CYVD Inner Diameter [32mm]		○	GHA232018	K
1.4 TSi (110 kW)	2014.12-	Convertible Engine CZDA 4 hole	•		GHA336007	K
	2014.12-	Convertible Engine CZDA Inner Diameter [30mm]		○	GHA230082	K
	2014.12-	Convertible Engine CZDA Inner Diameter [32mm]		○	GHA232018	K
1.4 TSi (118 kW)	2012.12-	Convertible Engine CAVD/CNWA/CTHD/CTKA 4 hole	•		GHA336007	K
	2012.12-	Convertible Engine CAVD/CNWA/CTHD/CTKA Inner Diameter [30mm]		○	GHA230082	K
	2012.12-	Convertible Engine CAVD/CNWA/CTHD/CTKA Inner Diameter [32mm]		○	GHA232018	K
1.6 TDi (77 kW)	2012.12-	Convertible Engine CAYC 4 hole	•		GHA336007	K
	2012.12-	Convertible Engine CAYC Inner Diameter [30mm]		○	GHA230082	K
	2012.12-	Convertible Engine CAYC Inner Diameter [32mm]		○	GHA232018	K
1.8 TSi (125 kW)	2013.12-	Convertible Engine CPKA/CPRA 4 hole	•		GHA336007	K
	2013.12-	Convertible Engine CPKA/CPRA Inner Diameter [30mm]		○	GHA230082	K
	2013.12-	Convertible Engine CPKA/CPRA Inner Diameter [32mm]		○	GHA232018	K
2.0 TDi (103 kW)	2012.12-	Convertible Engine CFFB/CJAA 4 hole	•		GHA336007	K
	2012.12-	Convertible Engine CFFB/CJAA Inner Diameter [30mm]		○	GHA230082	K
	2012.12-	Convertible Engine CFFB/CJAA Inner Diameter [32mm]		○	GHA232018	K
2.0 TDi (110 kW)	2014.09-	Convertible Engine CUUB/CVCA/DELA 4 hole	•		GHA336007	K
	2014.09-	Convertible Engine CUUB/CVCA/DELA Inner Diameter [30mm]		○	GHA230082	K
	2014.09-	Convertible Engine CUUB/CVCA/DELA Inner Diameter [32mm]		○	GHA232018	K
2.0 TDi (81 kW)	2014.06-	Convertible Engine CUUA 4 hole	•		GHA336007	K
	2014.06-	Convertible Engine CUUA Inner Diameter [30mm]		○	GHA230082	K
	2014.06-	Convertible Engine CUUA Inner Diameter [32mm]		○	GHA232018	K



	 YEAR		F	R	G-AP Ref.	KIT
VOLKSWAGEN						
BEETLE (5C7)						
2.0 TSi (147 kW)	2012.12-	Convertible Engine CCZA/CBFA/CCTA 4 hole	•		GHA336007	K
	2012.12-	Convertible Engine CCZA/CBFA/CCTA Inner Diameter [30mm]		◦	GHA230082	K
	2012.12-	Convertible Engine CCZA/CBFA/CCTA Inner Diameter [32mm]		◦	GHA232018	K
2.0 TSi (155 kW)	2012.12-	Convertible Engine CPLA/CPPA 4 hole	•		GHA336007	K
	2012.12-	Convertible Engine CPLA/CPPA Inner Diameter [30mm]		◦	GHA230082	K
	2012.12-	Convertible Engine CPLA/CPPA Inner Diameter [32mm]		◦	GHA232018	K
2.0 TSi (162 kW)	2014.12-	Convertible Engine CULC 4 hole	•		GHA336007	K
	2014.12-	Convertible Engine CULC Inner Diameter [30mm]		◦	GHA230082	K
	2014.12-	Convertible Engine CULC Inner Diameter [32mm]		◦	GHA232018	K
2.5 (125 kW)	2011.12-	Convertible Engine CBTA CBUA CCCA 4 hole	•		GHA336007	K
	2011.12-	Convertible Engine CBTA CBUA CCCA Inner Diameter [30mm]		◦	GHA230082	K
BORA (1J2)						
1.4 16V (55 kW)	2000.03-2005.05	Saloon Engine AHW/AKQ/APE/XP/BCA	•		GHA436002	K
	2000.03-2005.05	Saloon Engine AHW/AKQ/APE/XP/BCA	•		GWB3455	
	2000.03-2005.05	Saloon Engine AHW/AKQ/APE/XP/BCA With ABS		◦	GHA230051	K
1.6 (74 kW)	1998.10-2005.05	Saloon Engine AEH/AKL/APF	•		GHA436002	K
	1998.10-2005.05	Saloon Engine AEH/AKL/APF	•		GWB3455	
	1998.10-2005.05	Saloon Engine AEH/AKL/APF With ABS		◦	GHA230051	K
1.6 (75 kW)	2000.08-2005.05	Saloon Engine AVU/BFQ	•		GHA436002	K
	2000.08-2005.05	Saloon Engine AVU/BFQ	•		GWB3455	
	2000.08-2005.05	Saloon Engine AVU/BFQ With ABS		◦	GHA230051	K
1.6 (78 kW)	2002.06-2004.1	Saloon Engine AWB	•		GWB3455	
	2002.06-2004.1	Saloon Engine AWB With ABS		◦	GHA230051	K
1.6 16V (77 kW)	2000.05-2005.05	Saloon Engine ATN/AUS/AZD/BCB	•		GHA436002	K
	2000.05-2005.05	Saloon Engine ATN/AUS/AZD/BCB	•		GWB3455	
	2000.05-2005.05	Saloon Engine ATN/AUS/AZD/BCB With ABS		◦	GHA230051	K
1.6 FSi (81 kW)	2002.01-2005.05	Saloon Engine BAD	•		GHA436002	K
	2002.01-2005.05	Saloon Engine BAD	•		GWB3455	
	2002.01-2005.05	Saloon Engine BAD With ABS		◦	GHA230051	K
1.8 (92 kW)	1998.10-2005.05	Saloon Engine AGN/BAF	•		GHA436002	K
	1998.10-2005.05	Saloon Engine AGN/BAF	•		GWB3455	
	1998.10-2005.05	Saloon Engine AGN/BAF With ABS		◦	GHA230051	K
1.8 4motion (92 kW)	1999.02-2005.05	Saloon Engine AGN	•		GWB3455	
	1999.02-2005.05	Saloon Engine AGN		◦	GHA436002	K
1.8 T (110 kW)	2000.05-2005.05	Saloon Engine AGU/ARX/AUM/BAE	•		GHA436002	K
	2000.05-2005.05	Saloon Engine AGU/ARX/AUM/BAE	•		GWB3455	
	2000.05-2005.05	Saloon Engine AGU/ARX/AUM/BAE With ABS		◦	GHA230051	K
1.8 T (132 kW)	2002.03-2005.05	Saloon Engine AUQ	•		GHA436002	K
	2002.03-2005.05	Saloon Engine AUQ	•		GWB3455	
	2002.03-2005.05	Saloon Engine AUQ With ABS		◦	GHA230051	K
1.8 T 4motion (110 kW)	2000.10-2001.05	Saloon Engine ARX		◦	GHA436002	K
1.9 SDi (50 kW)	1998.10-2005.05	Saloon Engine AGP/AQM	•		GHA436002	K
	1998.10-2005.05	Saloon Engine AGP/AQM	•		GWB3455	
	1998.10-2005.05	Saloon Engine AGP/AQM With ABS		◦	GHA230051	K
1.9 TDi (110 kW)	2000.05-2005.05	Saloon Engine ARL	•		GHA436002	K
	2000.05-2005.05	Saloon Engine ARL	•		GWB3455	
	2000.05-2005.05	Saloon Engine ARL With ABS		◦	GHA230051	K
1.9 TDi (66 kW)	1998.10-2001.06	Saloon Engine AGR/ALH	•		GHA436002	K
	1998.10-2001.06	Saloon Engine AGR/ALH	•		GWB3455	
	1998.10-2001.06	Saloon Engine AGR/ALH With ABS		◦	GHA230051	K
1.9 TDi (74 kW)	2000.09-2005.05	Saloon Engine ATD/AXR	•		GHA436002	K
	2000.09-2005.05	Saloon Engine ATD/AXR	•		GWB3455	
	2000.09-2005.05	Saloon Engine ATD/AXR With ABS		◦	GHA230051	K
1.9 TDi (81 kW)	1998.10-2001.06	Saloon Engine AHF/ASV	•		GHA436002	K
	1998.10-2001.06	Saloon Engine AHF/ASV	•		GWB3455	
	1998.10-2001.06	Saloon Engine AHF/ASV With ABS		◦	GHA230051	K
1.9 TDi (85 kW)	1998.12-2002.01	Saloon Engine AJM/AUY	•		GHA436002	K
	1998.12-2002.01	Saloon Engine AJM/AUY	•		GWB3455	
	1998.12-2002.01	Saloon Engine AJM/AUY With ABS		◦	GHA230051	K
1.9 TDi (96 kW)	2000.11-2005.05	Saloon Engine ASZ	•		GHA436002	K
	2000.11-2005.05	Saloon Engine ASZ	•		GWB3455	
	2000.11-2005.05	Saloon Engine ASZ With ABS		◦	GHA230051	K
1.9 TDi 4motion (110 kW)	2000.05-2005.05	Saloon Engine ARL	•		GWB3455	
	2000.05-2005.05	Saloon Engine ARL		◦	GHA436002	K



	 YEAR		F	R	G-AP Ref.	KIT
VOLKSWAGEN						
BORA (1J2)						
1.9 TDi 4motion (66 kW)	1999.02-2001.06	Saloon Engine AGR	•		GWB3455	
	1999.02-2001.06	Saloon Engine AGR		○	GHA436002	K
1.9 TDi 4motion (74 kW)	2000.09-2005.05	Saloon Engine ATD	•		GWB3455	
	2000.09-2005.05	Saloon Engine ATD		○	GHA436002	K
1.9 TDi 4motion (85 kW)	1999.02-2001.06	Saloon Engine AJM/AUY	•		GWB3455	
	1999.02-2001.06	Saloon Engine AJM/AUY		○	GHA436002	K
1.9 TDi 4motion (96 kW)	2000.11-2005.05	Saloon Engine ASZ	•		GWB3455	
	2000.11-2005.05	Saloon Engine ASZ		○	GHA436002	K
2.0 (85 kW)	1998.10-2005.05	Saloon Engine APK/AQY/AZG/AZH/AZJ/BBW	•		GHA436002	K
	1998.10-2005.05	Saloon Engine APK/AQY/AZG/AZH/AZJ/BBW	•		GWB3455	
	1998.10-2005.05	Saloon Engine APK/AQY/AZG/AZH/AZJ/BBW With ABS		○	GHA230051	K
2.0 4motion (85 kW)	2000.04-2005.05	Saloon Engine AZH/AZJ	•		GWB3455	
	2000.04-2005.05	Saloon Engine AZH/AZJ		○	GHA436002	K
2.3 V5 (110 kW)	1998.10-2000.10	Saloon Engine AGZ	•		GHA436002	K
	1998.10-2000.10	Saloon Engine AGZ	•		GWB3455	
	1998.10-2000.10	Saloon Engine AGZ With ABS		○	GHA230051	K
2.3 V5 (125 kW)	2000.10-2005.05	Saloon Engine AQN	•		GHA436002	K
	2000.10-2005.05	Saloon Engine AQN	•		GWB3455	
	2000.10-2005.05	Saloon Engine AQN With ABS		○	GHA230051	K
2.3 V5 4motion (110 kW)	1998.12-2000.10	Saloon Engine AGZ	•		GWB3455	
	1998.12-2000.10	Saloon Engine AGZ		○	GHA436002	K
2.3 V5 4motion (125 kW)	2000.10-2005.05	Saloon Engine AQN	•		GWB3455	
	2000.10-2005.05	Saloon Engine AQN		○	GHA436002	K
2.8 V6 4motion (150 kW)	1999.03-2005.05	Saloon Engine AQP/AUE/BDE	•		GWB3455	
	1999.03-2005.05	Saloon Engine AQP/AUE/BDE		○	GHA436002	K
BORA (1J6)						
1.4 16V (55 kW)	2001.09-2005.05	Estate Engine AHW/AXP/BCA	•		GHA436002	K
	2001.09-2005.05	Estate Engine AHW/AXP/BCA	•		GWB3455	
	2001.09-2005.05	Estate Engine AHW/AXP/BCA With ABS		○	GHA230051	K
1.6 (74 kW)	1999.05-2005.05	Estate Engine AEH/APF	•		GHA436002	K
	1999.05-2005.05	Estate Engine AEH/APF	•		GWB3455	
	1999.05-2005.05	Estate Engine AEH/APF With ABS		○	GHA230051	K
1.6 (75 kW)	2000.08-2005.05	Estate Engine AVU/BFQ	•		GHA436002	K
	2000.08-2005.05	Estate Engine AVU/BFQ	•		GWB3455	
	2000.08-2005.05	Estate Engine AVU/BFQ With ABS		○	GHA230051	K
1.6 16V (77 kW)	2000.02-2005.05	Estate Engine ATN/AUS/AZD/BCB	•		GHA436002	K
	2000.02-2005.05	Estate Engine ATN/AUS/AZD/BCB	•		GWB3455	
	2000.02-2005.05	Estate Engine ATN/AUS/AZD/BCB With ABS		○	GHA230051	K
1.6 FSi (81 kW)	2002.01-2005.05	Estate Engine BAD	•		GHA436002	K
	2002.01-2005.05	Estate Engine BAD	•		GWB3455	
	2002.01-2005.05	Estate Engine BAD With ABS		○	GHA230051	K
1.8 4motion (92 kW)	1999.05-2005.05	Estate Engine AGN	•		GWB3455	
	1999.05-2005.05	Estate Engine AGN		○	GHA436002	K
1.8 T (110 kW)	2000.05-2005.05	Estate Engine AGU/ARX/AUM	•		GHA436002	K
	2000.05-2005.05	Estate Engine AGU/ARX/AUM	•		GWB3455	
	2000.05-2005.05	Estate Engine AGU/ARX/AUM With ABS		○	GHA230051	K
1.8 T (132 kW)	2002.05-2005.05	Estate Engine AUQ	•		GHA436002	K
	2002.05-2005.05	Estate Engine AUQ	•		GWB3455	
	2002.05-2005.05	Estate Engine AUQ With ABS		○	GHA230051	K
1.9 TDi (110 kW)	2001.05-2005.05	Estate Engine ARL	•		GHA436002	K
	2001.05-2005.05	Estate Engine ARL	•		GWB3455	
	2001.05-2005.05	Estate Engine ARL With ABS		○	GHA230051	K
1.9 TDi (66 kW)	2004.07-2005.05	Estate Engine AGR	•		GHA436002	K
	2004.07-2005.05	Estate Engine AGR	•		GWB3455	
	2004.07-2005.05	Estate Engine AGR With ABS		○	GHA230051	K
1.9 TDi (74 kW)	2000.09-2005.05	Estate Engine ATD/AXR	•		GHA436002	K
	2000.09-2005.05	Estate Engine ATD/AXR	•		GWB3455	
	2000.09-2005.05	Estate Engine ATD/AXR With ABS		○	GHA230051	K
1.9 TDi (81 kW)	1999.05-2001.06	Estate Engine AHF/ASV	•		GHA436002	K
	1999.05-2001.06	Estate Engine AHF/ASV	•		GWB3455	
	1999.05-2001.06	Estate Engine AHF/ASV With ABS		○	GHA230051	K
1.9 TDi (85 kW)	1999.05-2001.06	Estate Engine AJM/AUY	•		GHA436002	K
	1999.05-2001.06	Estate Engine AJM/AUY	•		GWB3455	
	1999.05-2001.06	Estate Engine AJM/AUY With ABS		○	GHA230051	K



	 YEAR		F	R	G-AP Ref.	KIT
VOLKSWAGEN						
BORA (1J6)						
1.9 TDi (96 kW)	2000.11-2005.05	Estate Engine ASZ	•		GHA436002	K
	2000.11-2005.05	Estate Engine ASZ	•		GWB3455	
	2000.11-2005.05	Estate Engine ASZ With ABS		○	GHA230051	K
1.9 TDi 4motion (110 kW)	2001.05-2005.05	Estate Engine ARL	•		GWB3455	
	2001.05-2005.05	Estate Engine ARL		○	GHA436002	K
1.9 TDi 4motion (74 kW)	2000.09-2005.05	Estate Engine ATD	•		GWB3455	
	2000.09-2005.05	Estate Engine ATD		○	GHA436002	K
1.9 TDi 4motion (85 kW)	1999.05-2001.06	Estate Engine AJM/AUY	•		GWB3455	
	1999.05-2001.06	Estate Engine AJM/AUY		○	GHA436002	K
1.9 TDi 4motion (96 kW)	2000.11-2005.05	Estate Engine ASZ	•		GWB3455	
	2000.11-2005.05	Estate Engine ASZ		○	GHA436002	K
2.0 (85 kW)	1999.05-2005.05	Estate Engine APK/AQY/AZH/AZJ	•		GHA436002	K
	1999.05-2005.05	Estate Engine APK/AQY/AZH/AZJ	•		GWB3455	
	1999.05-2005.05	Estate Engine APK/AQY/AZH/AZJ With ABS		○	GHA230051	K
2.0 4motion (85 kW)	2000.04-2005.05	Estate Engine AZH/AZJ	•		GWB3455	
	2000.04-2005.05	Estate Engine AZH/AZJ		○	GHA436002	K
2.0 4motion (88 kW)	1999.12-2003.05	Estate Engine ATF	•		GWB3455	
2.3 V5 (110 kW)	1999.05-2000.10	Estate Engine AGZ	•		GHA436002	K
	1999.05-2000.10	Estate Engine AGZ	•		GWB3455	
	1999.05-2000.10	Estate Engine AGZ With ABS		○	GHA230051	K
2.3 V5 (125 kW)	2000.10-2005.05	Estate Engine AQN	•		GHA436002	K
	2000.10-2005.05	Estate Engine AQN	•		GWB3455	
	2000.10-2005.05	Estate Engine AQN With ABS		○	GHA230051	K
2.3 V5 4motion (110 kW)	1999.05-2000.10	Estate Engine AGZ	•		GWB3455	
	1999.05-2000.10	Estate Engine AGZ		○	GHA436002	K
2.3 V5 4motion (125 kW)	2000.10-2005.05	Estate Engine AQN	•		GWB3455	
	2000.10-2005.05	Estate Engine AQN		○	GHA436002	K
2.8 V6 4motion (150 kW)	1999.05-2005.05	Estate Engine AQP/AUE/BDE	•		GWB3455	
	1999.05-2005.05	Estate Engine AQP/AUE/BDE		○	GHA436002	K
2.8 VR6 (150 kW)	2000.03-2000.05	Estate Engine AUE	•		GHA436002	K
	2000.03-2000.05	Estate Engine AUE	•		GWB3455	
	2000.03-2000.05	Estate Engine AUE With ABS		○	GHA230051	K
CADDY II (9K9A)						
1.4 (44 kW)	1995.11-2004.01	Box Engine AEX/APQ/AUD	•		GHA422036	K
	1995.11-2004.01	Box Engine AEX/APQ/AUD	•		GWB1358	
	1995.11-2004.01	Box Engine AEX/APQ/AUD		○	GHA230057	K
	1995.11-2004.01	Box Engine AEX/APQ/AUD		○	GWB0542	
	1995.11-2004.01	Box Engine AEX/APQ/AUD		○	GWB3519	
1.4 (55 kW)	2000.08-2004.01	Box Engine AUA	•		GHA422036	K
	2000.08-2004.01	Box Engine AUA	•		GWB1358	
	2000.08-2004.01	Box Engine AUA		○	GHA230057	K
1.6 (55 kW)	1995.11-1997.05	Box Engine 1F	•		GHA422036	K
	1995.11-1997.05	Box Engine 1F	•		GWB1358	
	1995.11-1997.05	Box Engine 1F		○	GWB0542	
	1995.11-1997.05	Box Engine 1F		○	GWB3519	
	1995.11-2000.09	Box Engine AEE	•		GHA422036	K
	1995.11-2000.09	Box Engine AEE	•		GWB1358	
	1995.11-2000.09	Box Engine AEE		○	GHA230057	K
	1995.11-2000.09	Box Engine AEE		○	GWB0542	
1.7 SDi (42 kW)	1996.07-2000.09	Box Engine AHB	•		GHA422036	K
	1996.07-2000.09	Box Engine AHB	•		GWB1358	
	1996.07-2000.09	Box Engine AHB		○	GHA230057	K
	1996.07-2000.09	Box Engine AHB		○	GWB0542	
	1996.07-2000.09	Box Engine AHB		○	GWB3519	
1.9 D (47 kW)	1995.11-2004.01	Box Engine 1Y	•		GHA422036	K
	1995.11-2004.01	Box Engine 1Y	•		GWB1358	
	1995.11-2004.01	Box Engine 1Y		○	GHA230057	K
	1995.11-2004.01	Box Engine 1Y		○	GWB0542	
	1995.11-2004.01	Box Engine 1Y		○	GWB3519	
1.9 SDi (47 kW)	1995.11-2004.01	Box Engine AEY/AYQ	•		GHA422036	K
	1995.11-2004.01	Box Engine AEY/AYQ	•		GWB1358	
	1995.11-2004.01	Box Engine AEY/AYQ		○	GHA230057	K
	1995.11-2004.01	Box Engine AEY/AYQ		○	GWB0542	



	 YEAR		F	R	G-AP Ref.	KIT
VOLKSWAGEN						
CADDY II (9K9A)						
1.9 SDi (47 kW)	1995.11-2004.01	Box Engine AEY/AYQ		o	GWB3519	
1.9 TDi (66 kW)	1996.09-2004.01	Box Engine 1Z/AHU/ALH	•		GHA422036	K
	1996.09-2004.01	Box Engine 1Z/AHU/ALH	•		GWB1358	
	1996.09-2004.01	Box Engine 1Z/AHU/ALH		o	GHA230057	K
	1996.09-2004.01	Box Engine 1Z/AHU/ALH		o	GWB0542	
	1996.09-2004.01	Box Engine 1Z/AHU/ALH		o	GWB3519	
CADDY II (9K9B)						
1.4 (44 kW)	1995.11-2004.01	Estate Engine AEX/AKV/APQ/AUD	•		GHA422036	K
	1995.11-2004.01	Estate Engine AEX/AKV/APQ/AUD	•		GWB1358	
	1995.11-2004.01	Estate Engine AEX/AKV/APQ/AUD		o	GHA230057	K
	1995.11-2004.01	Estate Engine AEX/AKV/APQ/AUD		o	GWB0542	
	1995.11-2004.01	Estate Engine AEX/AKV/APQ/AUD		o	GWB3519	
1.4 16V (55 kW)	2000.08-2004.01	Estate Engine AUA	•		GHA422036	K
	2000.08-2004.01	Estate Engine AUA	•		GWB1358	
	2000.08-2004.01	Estate Engine AUA		o	GHA230057	K
1.6 (55 kW)	1995.11-1997.05	Estate Engine 1F	•		GHA422036	K
	1995.11-1997.05	Estate Engine 1F	•		GWB1358	
	1995.11-1997.05	Estate Engine 1F		o	GWB0542	
	1997.06-2000.09	Estate Engine AEE	•		GHA422036	K
	1997.06-2000.09	Estate Engine AEE	•		GWB1358	
	1997.06-2000.09	Estate Engine AEE		o	GHA230057	K
	1997.06-2000.09	Estate Engine AEE		o	GWB3519	
1.7 SDi (42 kW)	1996.07-2000.09	Estate Engine AHB	•		GHA422036	K
	1996.07-2000.09	Estate Engine AHB	•		GWB1358	
	1996.07-2000.09	Estate Engine AHB		o	GHA230057	K
	1996.07-2000.09	Estate Engine AHB		o	GWB0542	
	1996.07-2000.09	Estate Engine AHB		o	GWB3519	
1.9 D (47 kW)	1995.11-2004.01	Estate Engine 1Y	•		GHA422036	K
	1995.11-2004.01	Estate Engine 1Y	•		GWB1358	
	1995.11-2004.01	Estate Engine 1Y		o	GHA230057	K
	1995.11-2004.01	Estate Engine 1Y		o	GWB0542	
	1995.11-2004.01	Estate Engine 1Y		o	GWB3519	
1.9 SDi (47 kW)	1995.11-2004.01	Estate Engine AEY/AYQ	•		GHA422036	K
	1995.11-2004.01	Estate Engine AEY/AYQ	•		GWB1358	
	1995.11-2004.01	Estate Engine AEY/AYQ		o	GHA230057	K
	1995.11-2004.01	Estate Engine AEY/AYQ		o	GWB0542	
	1995.11-2004.01	Estate Engine AEY/AYQ		o	GWB3519	
1.9 TDi (66 kW)	1996.10-2004.01	Estate Engine AHU/ALE/ALH	•		GHA422036	K
	1996.10-2004.01	Estate Engine AHU/ALE/ALH	•		GWB1358	
	1996.10-2004.01	Estate Engine AHU/ALE/ALH		o	GHA230057	K
	1996.10-2004.01	Estate Engine AHU/ALE/ALH		o	GWB0542	
	1996.10-2004.01	Estate Engine AHU/ALE/ALH		o	GWB3519	
CADDY II (9U7)						
1.6 (55 kW)	1996.06-2000.12	Pickup Engine AEE	•		GHA422036	K
	1996.06-2000.12	Pickup Engine AEE	•		GWB3441	
	1996.06-2000.12	Pickup Engine AEE		o	GWB0529	
1.9 D (47 kW)	1996.06-2000.12	Pickup Engine AEF	•		GHA422036	K
	1996.06-2000.12	Pickup Engine AEF	•		GWB3441	
	1996.06-2000.12	Pickup Engine AEF		o	GWB0529	
CADDY III (2KA, 2KH, 2CA, 2CH)						
1.2 TSi (63 kW)	2010.09-	Box Engine CBZA 3 hole	•		GHA336004	K
	2010.09-	Box Engine CBZA 4 hole	•		GHA336007	K
1.2 TSi (77 kW)	2010.09-	Box Engine CBZB 3 hole	•		GHA336004	K
	2010.09-	Box Engine CBZB 4 hole	•		GHA336007	K
1.4 (55 kW)	2004.03-2006.05	Box Engine BCA 3 hole	•		GHA336004	K
	2004.03-2006.05	Box Engine BCA 4 hole	•		GHA336007	K
1.4 16V (59 kW)	2006.05-2010.08	Box Engine BUD 3 hole	•		GHA336004	K
	2006.05-2010.08	Box Engine BUD 4 hole	•		GHA336007	K
1.6 (75 kW)	2004.04-	Box Engine BGU/BSE/BSF 3 hole	•		GHA336004	K
	2004.04-	Box Engine BGU/BSE/BSF 4 hole	•		GHA336007	K
1.6 BiFuel (75 kW)	2011.05-	Box Engine CHGA 3 hole	•		GHA336004	K
	2011.05-	Box Engine CHGA 4 hole	•		GHA336007	K
1.6 TDi (55 kW)	2010.08-	Box Engine CAYE 3 hole	•		GHA336004	K
	2010.08-	Box Engine CAYE 4 hole	•		GHA336007	K



	 YEAR		F	R	G-AP Ref.	KIT
VOLKSWAGEN						
CADDY III (2KA, 2KH, 2CA, 2CH)						
1.6 TDi (75 kW)	2010.08-	Box Engine CAYD 3 hole	•		GHA336004	K
	2010.08-	Box Engine CAYD 4 hole	•		GHA336007	K
1.9 TDi (55 kW)	2005.09-2010.08	Box Engine BSU 3 hole	•		GHA336004	K
	2005.09-2010.08	Box Engine BSU 4 hole	•		GHA336007	K
1.9 TDi (77 kW)	2004.04-2010.08	Box Engine BJB/BLS 3 hole	•		GHA336004	K
	2004.04-2010.08	Box Engine BJB/BLS 4 hole	•		GHA336007	K
1.9 TDi 4motion (77 kW)	2008.11-2010.08	Box Engine BLS 4 hole	•		GHA336007	K
2.0 EcoFuel (80 kW)	2006.04-	Box Engine BSX 3 hole	•		GHA336004	K
	2006.04-	Box Engine BSX 4 hole	•		GHA336007	K
2.0 SDi (51 kW)	2004.03-2010.08	Box Engine BDJ/BST 3 hole	•		GHA336004	K
	2004.03-2010.08	Box Engine BDJ/BST 4 hole	•		GHA336007	K
2.0 TDi (103 kW)	2007.09-2010.08	Box Engine BMM 3 hole	•		GHA336004	K
	2007.09-2010.08	Box Engine BMM 4 hole	•		GHA336007	K
2.0 TDi (125 kW)	2012.05-	Box Engine CFJA 3 hole	•		GHA336004	K
	2012.05-	Box Engine CFJA 4 hole	•		GHA336007	K
2.0 TDi (62 kW)	2010.11-	Box Engine CFHE 3 hole	•		GHA336004	K
	2010.11-	Box Engine CFHE 4 hole	•		GHA336007	K
2.0 TDi (81 kW)	2010.08-	Box Engine CLCA 3 hole	•		GHA336004	K
	2010.08-	Box Engine CLCA 4 hole	•		GHA336007	K
2.0 TDi 16V (103 kW)	2010.11-	Box Engine CFHC/CLCB 3 hole	•		GHA336004	K
	2010.11-	Box Engine CFHC/CLCB 4 hole	•		GHA336007	K
2.0 TDi 16V 4motion (103 kW)	2010.11-	Box Engine CFHC 4 hole	•		GHA336007	K
2.0 TDi 4motion (62 kW)	2010.12-	Box Engine CFHE 4 hole	•		GHA336007	K
2.0 TDi 4motion (81 kW)	2010.08-	Box Engine CFHF 4 hole	•		GHA336007	K
CADDY III (2KB, 2KJ, 2CB, 2CJ)						
1.2 TSi (63 kW)	2010.09-	Estate Engine CBZA 3 hole	•		GHA336004	K
	2010.09-	Estate Engine CBZA 4 hole	•		GHA336007	K
1.2 TSi (77 kW)	2010.09-	Estate Engine CBZB 3 hole	•		GHA336004	K
	2010.09-	Estate Engine CBZB 4 hole	•		GHA336007	K
1.4 (55 kW)	2004.03-2006.05	Estate Engine BCA 3 hole	•		GHA336004	K
	2004.03-2006.05	Estate Engine BCA 4 hole	•		GHA336007	K
1.4 16V (59 kW)	2006.05-2010.08	Estate Engine BUD 3 hole	•		GHA336004	K
	2006.05-2010.08	Estate Engine BUD 4 hole	•		GHA336007	K
1.6 (74 kW)	2005.03-	Estate 3 hole	•		GHA336004	K
	2005.03-	Estate 4 hole	•		GHA336007	K
1.6 (75 kW)	2004.04-	Estate Engine BGU/BSE/BSF 3 hole	•		GHA336004	K
	2004.04-	Estate Engine BGU/BSE/BSF 4 hole	•		GHA336007	K
1.6 BiFuel (75 kW)	2011.05-	Estate Engine CHGA 3 hole	•		GHA336004	K
	2011.05-	Estate Engine CHGA 4 hole	•		GHA336007	K
1.6 TDi (55 kW)	2010.08-	Estate Engine CAYE 3 hole	•		GHA336004	K
	2010.08-	Estate Engine CAYE 4 hole	•		GHA336007	K
1.6 TDi (75 kW)	2010.08-	Estate Engine CAYD 3 hole	•		GHA336004	K
	2010.08-	Estate Engine CAYD 4 hole	•		GHA336007	K
1.9 TDi (55 kW)	2005.09-2010.08	Estate Engine BSU 3 hole	•		GHA336004	K
	2005.09-2010.08	Estate Engine BSU 4 hole	•		GHA336007	K
1.9 TDi (77 kW)	2004.04-2010.08	Estate Engine BJB/BLS 3 hole	•		GHA336004	K
	2004.04-2010.08	Estate Engine BJB/BLS 4 hole	•		GHA336007	K
1.9 TDi 4motion (77 kW)	2008.05-2010.08	Estate Engine BLS 4 hole	•		GHA336007	K
2.0 EcoFuel (80 kW)	2006.04-	Estate Engine BSX 3 hole	•		GHA336004	K
	2006.04-	Estate Engine BSX 4 hole	•		GHA336007	K
2.0 SDi (51 kW)	2004.03-2010.08	Estate Engine BDJ/BST 3 hole	•		GHA336004	K
	2004.03-2010.08	Estate Engine BDJ/BST 4 hole	•		GHA336007	K
2.0 TDi (103 kW)	2007.09-2010.08	Estate Engine BMM 3 hole	•		GHA336004	K
	2007.09-2010.08	Estate Engine BMM 4 hole	•		GHA336007	K
2.0 TDi (125 kW)	2012.05-	Estate Engine CFJA 3 hole	•		GHA336004	K
	2012.05-	Estate Engine CFJA 4 hole	•		GHA336007	K
2.0 TDi (81 kW)	2010.08-	Estate Engine CLCA 3 hole	•		GHA336004	K
	2010.08-	Estate Engine CLCA 4 hole	•		GHA336007	K
2.0 TDi 16V (103 kW)	2010.11-	Estate Engine CFHC/CLCB 3 hole	•		GHA336004	K
	2010.11-	Estate Engine CFHC/CLCB 4 hole	•		GHA336007	K
2.0 TDi 16V 4motion (103 kW)	2010.11-	Estate Engine CFHC 4 hole	•		GHA336007	K
2.0 TDi 4motion (81 kW)	2010.08-	Estate Engine CFHF 4 hole	•		GHA336007	K
CC (358)						
1.4 TSi (118 kW)	2011.11-	Coupe Engine CKMA 4 hole	•		GHA336007	K



	 YEAR		F	R	G-AP Ref.	KIT
VOLKSWAGEN						
CC (358)						
1.4 TSi (118 kW)	2011.11-	Coupe Engine CKMA Inner Diameter [32mm]		o	GHA232018	K
1.4 TSi MultiFuel (118 kW)	2011.11-	Coupe Engine CKMA 4 hole	•		GHA336007	K
	2011.11-	Coupe Engine CKMA Inner Diameter [32mm]		o	GHA232018	K
1.8 TSi (112 kW)	2011.11-	Coupe Engine CDAB 4 hole	•		GHA336007	K
	2011.11-	Coupe Engine CDAB Inner Diameter [32mm]		o	GHA232018	K
1.8 TSi (118 kW)	2011.11-	Coupe Engine CDAA 4 hole	•		GHA336007	K
	2011.11-	Coupe Engine CDAA Inner Diameter [32mm]		o	GHA232018	K
2.0 TDi (100 kW)	2011.11-	Coupe Engine CFFA 4 hole	•		GHA336007	K
	2011.11-	Coupe Engine CFFA Inner Diameter [32mm]		o	GHA232018	K
2.0 TDi (103 kW)	2011.11-	Coupe Engine CFFB 4 hole	•		GHA336007	K
	2011.11-	Coupe Engine CFFB Inner Diameter [32mm]		o	GHA232018	K
2.0 TDi (125 kW)	2011.11-	Coupe Engine CFGB/CLLA 4 hole	•		GHA336007	K
	2011.11-	Coupe Engine CFGB/CLLA Inner Diameter [32mm]		o	GHA232018	K
2.0 TDi (130 kW)	2012.12-	Coupe Engine CFGC 4 hole	•		GHA336007	K
	2012.12-	Coupe Engine CFGC Inner Diameter [32mm]		o	GHA232018	K
2.0 TDi 4motion (103 kW)	2011.11-	Coupe Engine CFFB 4 hole	•		GHA336007	K
2.0 TDi 4motion (125 kW)	2011.11-	Coupe Engine CFGB 4 hole	•		GHA336007	K
2.0 TDi 4motion (130 kW)	2012.12-	Coupe Engine CFGC 4 hole	•		GHA336007	K
2.0 TSi (147 kW)	2011.11-	Coupe Engine CBFA/CCTA 4 hole	•		GHA336007	K
	2011.11-	Coupe Engine CBFA/CCTA Inner Diameter [32mm]		o	GHA232018	K
2.0 TSi (155 kW)	2011.11-	Coupe Engine CCZB 4 hole	•		GHA336007	K
	2011.11-	Coupe Engine CCZB Inner Diameter [32mm]		o	GHA232018	K
3.6 FSi 4motion (220 kW)	2011.11-	Coupe Engine BWS 4 hole	•		GHA336007	K
CORRADO (53I)						
2.0 i (85 kW)	1993.04-1995.12	Coupe Engine 2E/ADY	•		GHA422009	K
	1993.04-1995.12	Coupe Engine 2E/ADY	•		GHA422036	K
	1993.04-1995.12	Coupe Engine 2E/ADY	•		GWB1358	
	1993.04-1995.12	Coupe Engine 2E/ADY		o	GHA499014	
	1993.04-1995.12	Coupe Engine 2E/ADY		o	GHA499015	
	1993.04-1995.12	Coupe Engine 2E/ADY		o	GWB0529	
2.0 i 16V (100 kW)	1991.08-1995.12	Coupe Engine 9A	•		GHA422009	K
	1991.08-1995.12	Coupe Engine 9A	•		GHA422036	K
	1991.08-1995.12	Coupe Engine 9A	•		GWB1358	
	1991.08-1995.12	Coupe Engine 9A		o	GHA499014	
	1991.08-1995.12	Coupe Engine 9A		o	GHA499015	
	1991.08-1995.12	Coupe Engine 9A		o	GWB0529	
2.9 VR6 (140 kW)	1991.08-1995.12	Coupe Engine ABV	•		GHA436001	
	1991.08-1995.12	Coupe Engine ABV	•		GWB1491	
	1991.08-1995.12	Coupe Engine ABV		o	GHA499014	
	1991.08-1995.12	Coupe Engine ABV		o	GHA499015	
	1991.08-1995.12	Coupe Engine ABV		o	GWB0529	
CRAFTER 30-35 (2E_)						
2.0 TDi (100 kW)	2011.05-		•		GHA400353	K
	2011.05-		•		GHA400354	K
	2011.05-			o	GHA329008	K
2.0 TDi (105 kW)	2011.10-	Bus Engine CKUC	•		GHA400353	K
	2011.10-	Bus Engine CKUC	•		GHA400354	K
2.0 TDi (120 kW)	2011.07-		•		GHA400353	K
	2011.07-		•		GHA400354	K
	2011.07-			o	GHA329008	K
2.0 TDi (80 kW)	2011.05-		•		GHA400353	K
	2011.05-		•		GHA400354	K
	2011.05-			o	GHA329008	K
2.5 TDi (100 kW)	2006.04-	Bus Engine BJL/CECA	•		GHA400353	K
	2006.04-	Bus Engine BJL/CECA	•		GHA400354	K
	2006.04-	Bus Engine BJL/CECA		o	GHA329008	K
2.5 TDi (120 kW)	2006.04-2011.07	Bus Engine BJM/CECB	•		GHA400353	K
	2006.04-2011.07	Bus Engine BJM/CECB	•		GHA400354	K
	2006.04-2011.07	Bus Engine BJM/CECB		o	GHA329008	K
2.5 TDi (65 kW)	2006.04-2011.07	Bus Engine BJJ/CEBA	•		GHA400353	K
	2006.04-2011.07	Bus Engine BJJ/CEBA	•		GHA400354	K
	2006.04-2011.07	Bus Engine BJJ/CEBA		o	GHA329008	K
2.5 TDi (80 kW)	2006.04-	Bus Engine BJK/CEBB	•		GHA400353	K
	2006.04-	Bus Engine BJK/CEBB	•		GHA400354	K



	 YEAR		F	R	G-AP Ref.	KIT
VOLKSWAGEN						
CRAFTER 30-35 (2E_)						
2.5 TDi (80 kW)	2006.04-	Bus Engine BJK/CEBB		o	GHA329008	K
CRAFTER 30-50 (2E_)						
2.0 TDi (100 kW)	2011.05-	Box Engine CKTC	•		GHA400353	K
	2011.05-	Box Engine CKTC	•		GHA400354	K
	2011.05-	Box Engine CKTC		o	GHA329008	K
2.0 TDi (105 kW)	2011.10-	Platform/Chassis Engine CKUC	•		GHA400353	K
	2011.10-	Platform/Chassis Engine CKUC	•		GHA400354	K
	2011.10-	Platform/Chassis Engine CKUC		o	GHA329008	K
2.0 TDi (120 kW)	2011.07-	Box Engine CKUB	•		GHA400353	K
	2011.07-	Box Engine CKUB	•		GHA400354	K
	2011.07-	Box Engine CKUB		o	GHA329008	K
2.0 TDi (80 kW)	2011.05-	Box Engine CKTB	•		GHA400353	K
	2011.05-	Box Engine CKTB	•		GHA400354	K
	2011.05-	Box Engine CKTB		o	GHA329008	K
2.5 TDi (100 kW)	2006.04-	Box Engine BJL/CECA	•		GHA400353	K
	2006.04-	Box Engine BJL/CECA	•		GHA400354	K
	2006.04-	Box Engine BJL/CECA		o	GHA329008	K
2.5 TDi (120 kW)	2006.04-2011.07	Box Engine BJM/CECB	•		GHA400353	K
	2006.04-2011.07	Box Engine BJM/CECB	•		GHA400354	K
	2006.04-2011.07	Box Engine BJM/CECB		o	GHA329008	K
2.5 TDi (65 kW)	2006.04-2011.07	Box Engine BJJ/CEBA	•		GHA400353	K
	2006.04-2011.07	Box Engine BJJ/CEBA	•		GHA400354	K
	2006.04-2011.07	Box Engine BJJ/CEBA		o	GHA329008	K
2.5 TDi (80 kW)	2006.04-	Box Engine BJK/CEBB	•		GHA400353	K
	2006.04-	Box Engine BJK/CEBB	•		GHA400354	K
	2006.04-	Box Engine BJK/CEBB		o	GHA329008	K
CRAFTER 30-50 (2F_)						
2.0 TDi (100 kW)	2011.05-	Platform/Chassis Engine CKTC	•		GHA400353	K
	2011.05-	Platform/Chassis Engine CKTC	•		GHA400354	K
	2011.05-	Platform/Chassis Engine CKTC		o	GHA329008	K
2.0 TDi (105 kW)	2011.10-	Platform/Chassis Engine CKUC	•		GHA400353	K
	2011.10-	Platform/Chassis Engine CKUC	•		GHA400354	K
	2011.10-	Platform/Chassis Engine CKUC		o	GHA329008	K
2.0 TDi (120 kW)	2011.07-	Platform/Chassis Engine CKUB	•		GHA400353	K
	2011.07-	Platform/Chassis Engine CKUB	•		GHA400354	K
	2011.07-	Platform/Chassis Engine CKUB		o	GHA329008	K
2.0 TDi (80 kW)	2011.05-	Platform/Chassis Engine CKTB	•		GHA400353	K
	2011.05-	Platform/Chassis Engine CKTB	•		GHA400354	K
	2011.05-	Platform/Chassis Engine CKTB		o	GHA329008	K
2.5 TDi (100 kW)	2006.04-	Platform/Chassis Engine BJL/CECA	•		GHA400353	K
	2006.04-	Platform/Chassis Engine BJL/CECA	•		GHA400354	K
	2006.04-	Platform/Chassis Engine BJL/CECA		o	GHA329008	K
2.5 TDi (120 kW)	2006.04-2011.07	Platform/Chassis Engine BJM/CECB	•		GHA400353	K
	2006.04-2011.07	Platform/Chassis Engine BJM/CECB	•		GHA400354	K
	2006.04-2011.07	Platform/Chassis Engine BJM/CECB		o	GHA329008	K
2.5 TDi (65 kW)	2006.04-2011.07	Platform/Chassis Engine BJJ/CEBA	•		GHA400353	K
	2006.04-2011.07	Platform/Chassis Engine BJJ/CEBA	•		GHA400354	K
	2006.04-2011.07	Platform/Chassis Engine BJJ/CEBA		o	GHA329008	K
2.5 TDi (80 kW)	2006.04-	Platform/Chassis Engine BJK/CEBB	•		GHA400353	K
	2006.04-	Platform/Chassis Engine BJK/CEBB	•		GHA400354	K
	2006.04-	Platform/Chassis Engine BJK/CEBB		o	GHA329008	K
EOS (1F7, 1F8)						
1.4 TSi (118 kW)	2008.05-	Convertible Engine CAVD/CTHD 4 hole	•		GHA336007	K
	2008.05-	Convertible Engine CAVD/CTHD Inner Diameter [32mm]		o	GHA232018	K
1.4 TSi (90 kW)	2007.11-	Convertible Engine CAXA 4 hole	•		GHA336007	K
	2007.11-	Convertible Engine CAXA Inner Diameter [32mm]		o	GHA232018	K
1.6 FSi (85 kW)	2006.06-2008.05	Convertible Engine BLF 4 hole	•		GHA336007	K
	2006.06-2008.05	Convertible Engine BLF Inner Diameter [32mm]		o	GHA232018	K
2.0 FSi (110 kW)	2006.03-2008.05	Convertible Engine BVY/BVZ 4 hole	•		GHA336007	K
	2006.03-2008.05	Convertible Engine BVY/BVZ Inner Diameter [32mm]		o	GHA232018	K
2.0 TDi (100 kW)	2010.11-	Convertible Engine CFFA 4 hole	•		GHA336007	K
	2010.11-	Convertible Engine CFFA Inner Diameter [32mm]		o	GHA232018	K
2.0 TDi (103 kW)	2006.06-2008.05	Convertible Engine BMM 4 hole	•		GHA336007	K
	2006.06-2008.05	Convertible Engine BMM Inner Diameter [32mm]		o	GHA232018	K



	 YEAR		F	R	G-AP Ref.	KIT
VOLKSWAGEN						
EOS (1F7, 1F8)						
2.0 TDi 16V (103 kW)	2008.05-	Convertible Engine CBAB/CFFB 4 hole	•		GHA336007	K
	2008.05-	Convertible Engine CBAB/CFFB Inner Diameter [32mm]		○	GHA232018	K
2.0 TFSi (147 kW)	2006.03-	Convertible Engine BWA/CAWB/CCZA 4 hole	•		GHA336007	K
	2006.03-	Convertible Engine BWA/CAWB/CCZA Inner Diameter [32mm]		○	GHA232018	K
2.0 TSi (155 kW)	2009.11-	Convertible Engine CCZB 4 hole	•		GHA336007	K
	2009.11-	Convertible Engine CCZB Inner Diameter [32mm]		○	GHA232018	K
3.2 V6 (184 kW)	2006.06-2009.05	Convertible Engine BUB/CBRA 4 hole	•		GHA336007	K
	2006.06-2009.05	Convertible Engine BUB/CBRA Inner Diameter [32mm]		○	GHA232018	K
3.6 V6 (191 kW)	2009.05-2010.11	Convertible Engine CDVA 4 hole	•		GHA336007	K
	2009.05-2010.11	Convertible Engine CDVA Inner Diameter [32mm]		○	GHA232018	K
FOX (5Z1, 5Z3)						
1.2 (40 kW)	2005.04-	Hatchback Engine BMD/CHFB	•		GHA320002	K
	2005.04-	Hatchback Engine BMD/CHFB	•		GHA422026	
	2005.04-	Hatchback Engine BMD/CHFB With ABS	•		GHA336001	K
	2005.04-	Hatchback Engine BMD/CHFB With ABS		○	GHA228036	K
	2005.04-	Hatchback Engine BMD/CHFB Without ABS	•		GHA336002	
	2005.04-	Hatchback Engine BMD/CHFB Without ABS		○	GHA228037	
1.2 (44 kW)	2010.09-	Hatchback Engine CHFA	•		GHA422026	
	2010.09-	Hatchback Engine CHFA With ABS	•		GHA336001	K
	2010.09-	Hatchback Engine CHFA With ABS		○	GHA228036	K
	2010.09-	Hatchback Engine CHFA Without ABS	•		GHA336002	
	2010.09-	Hatchback Engine CHFA Without ABS		○	GHA228037	
1.4 (55 kW)	2005.04-	Hatchback Engine BKR	•		GHA422026	
	2005.04-	Hatchback Engine BKR With ABS	•		GHA336001	K
	2005.04-	Hatchback Engine BKR With ABS		○	GHA228036	K
	2005.04-	Hatchback Engine BKR Without ABS	•		GHA336002	
	2005.04-	Hatchback Engine BKR Without ABS		○	GHA228037	
1.4 TDi (51 kW)	2005.04-	Hatchback Engine BNM	•		GHA422026	
	2005.04-	Hatchback Engine BNM With ABS	•		GHA336001	K
	2005.04-	Hatchback Engine BNM With ABS		○	GHA228036	K
	2005.04-	Hatchback Engine BNM Without ABS	•		GHA336002	
	2005.04-	Hatchback Engine BNM Without ABS		○	GHA228037	
1.6 (74 kW)	2003.10-	Hatchback Engine BAH/BJA/BLH	•		GHA422026	
	2003.10-	Hatchback Engine BAH/BJA/BLH With ABS	•		GHA336001	K
	2003.10-	Hatchback Engine BAH/BJA/BLH With ABS		○	GHA228036	K
1.6 Total Flex (74 kW)	2003.10-	Hatchback Engine BJA/BPA/CCRA	•		GHA422026	
	2003.10-	Hatchback Engine BJA/BPA/CCRA With ABS	•		GHA336001	K
	2003.10-	Hatchback Engine BJA/BPA/CCRA With ABS		○	GHA228036	K
GOLF ALLTRACK (BA5)						
1.6 TDi 4motion (81 kW)	2014.12-	Estate Engine CRKB/CXXB 3 hole	•		GHA336004	K
1.8 TSi 4motion (132 kW)	2014.12-	Estate Engine CISB 3 hole	•		GHA336004	K
2.0 TDi 4motion (110 kW)	2014.12-	Estate Engine CRBC/CRLB 3 hole	•		GHA336004	K
2.0 TDi 4motion (135 kW)	2014.12-	Estate Engine CUNA 3 hole	•		GHA336004	K
GOLF II (19E, 1G1)						
1.8 GTi G60 (118 kW)	1990.04-1991.07	Hatchback Engine PG	•		GHA422009	K
	1990.04-1991.07	Hatchback Engine PG	•		GHA422036	K
	1990.04-1991.07	Hatchback Engine PG	•		GWB1358	
	1990.04-1991.07	Hatchback Engine PG		○	GHA499014	
	1990.04-1991.07	Hatchback Engine PG		○	GHA499015	
	1990.04-1991.07	Hatchback Engine PG		○	GHA499045	
	1990.04-1991.07	Hatchback Engine PG		○	GHA499046	
	1990.04-1991.07	Hatchback Engine PG		○	GWB0529	
GOLF III (1E7)						
1.6 (74 kW)	1998.06-2002.06	Convertible Engine AFT/AKS	•		GHA422036	K
	1998.06-2002.06	Convertible Engine AFT/AKS	•		GWB1358	
	1998.06-2002.06	Convertible Engine AFT/AKS		○	GHA499044	
	1998.06-2002.06	Convertible Engine AFT/AKS		○	GHA499046	
	1998.06-2002.06	Convertible Engine AFT/AKS		○	GWB0529	
1.8 (55 kW)	1998.06-2002.06	Convertible Engine AAM/ANN	•		GHA422036	K
	1998.06-2002.06	Convertible Engine AAM/ANN	•		GWB1358	
	1998.06-2002.06	Convertible Engine AAM/ANN		○	GHA499044	
	1998.06-2002.06	Convertible Engine AAM/ANN		○	GHA499046	
	1998.06-2002.06	Convertible Engine AAM/ANN		○	GWB0529	
1.8 (66 kW)	1998.06-2002.06	Convertible Engine ADZ/ANP	•		GHA422036	K



	 YEAR		F	R	G-AP Ref.	KIT
VOLKSWAGEN						
GOLF III (1E7)						
1.8 (66 kW)	1998.06-2002.06	Convertible Engine ADZ/ANP	•		GWB1358	
	1998.06-2002.06	Convertible Engine ADZ/ANP		○	GHA499014	
	1998.06-2002.06	Convertible Engine ADZ/ANP		○	GHA499015	
	1998.06-2002.06	Convertible Engine ADZ/ANP		○	GHA499044	
	1998.06-2002.06	Convertible Engine ADZ/ANP		○	GHA499045	
	1998.06-2002.06	Convertible Engine ADZ/ANP		○	GHA499046	
	1998.06-2002.06	Convertible Engine ADZ/ANP		○	GWB0529	
1.9 TDi (66 kW)	1998.06-2002.06	Convertible Engine AHU/ALE	•		GHA422036	K
	1998.06-2002.06	Convertible Engine AHU/ALE	•		GWB1358	
	1998.06-2002.06	Convertible Engine AHU/ALE		○	GHA499044	
	1998.06-2002.06	Convertible Engine AHU/ALE		○	GHA499046	
	1998.06-2002.06	Convertible Engine AHU/ALE		○	GWB0529	
1.9 TDi (81 kW)	1998.06-2002.06	Convertible Engine AFN/AVG	•		GHA422036	K
	1998.06-2002.06	Convertible Engine AFN/AVG	•		GWB1358	
	1998.06-2002.06	Convertible Engine AFN/AVG		○	GHA499044	
	1998.06-2002.06	Convertible Engine AFN/AVG		○	GHA499046	
	1998.06-2002.06	Convertible Engine AFN/AVG		○	GWB0529	
2.0 (85 kW)	1998.06-2002.06	Convertible Engine AGG/AKR/ATU/AWF/AWG	•		GHA422036	K
	1998.06-2002.06	Convertible Engine AGG/AKR/ATU/AWF/AWG	•		GWB1358	
	1998.06-2002.06	Convertible Engine AGG/AKR/ATU/AWF/AWG		○	GHA499044	
	1998.06-2002.06	Convertible Engine AGG/AKR/ATU/AWF/AWG		○	GHA499046	
	1998.06-2002.06	Convertible Engine AGG/AKR/ATU/AWF/AWG		○	GWB0529	
GOLF III (1H1)						
1.4 (40 kW)	1991.11-1997.08	Hatchback Engine ABD/AEX	•		GHA422009	K
	1991.11-1997.08	Hatchback Engine ABD/AEX	•		GHA422036	K
	1991.11-1997.08	Hatchback Engine ABD/AEX	•		GWB1358	
	1991.11-1997.08	Hatchback Engine ABD/AEX		○	GHA499014	
	1991.11-1997.08	Hatchback Engine ABD/AEX		○	GHA499015	
	1991.11-1997.08	Hatchback Engine ABD/AEX		○	GHA499044	
	1991.11-1997.08	Hatchback Engine ABD/AEX		○	GHA499045	
	1991.11-1997.08	Hatchback Engine ABD/AEX		○	GHA499046	
	1991.11-1997.08	Hatchback Engine ABD/AEX		○	GWB0529	
1.4 (44 kW)	1991.10-1997.08	Hatchback Engine ABD/AEX	•		GHA422009	K
	1991.10-1997.08	Hatchback Engine ABD/AEX	•		GHA422036	K
	1991.10-1997.08	Hatchback Engine ABD/AEX	•		GWB1358	
	1991.10-1997.08	Hatchback Engine ABD/AEX		○	GHA499014	
	1991.10-1997.08	Hatchback Engine ABD/AEX		○	GHA499015	
	1991.10-1997.08	Hatchback Engine ABD/AEX		○	GHA499044	
	1991.10-1997.08	Hatchback Engine ABD/AEX		○	GHA499045	
	1991.10-1997.08	Hatchback Engine ABD/AEX		○	GHA499046	
	1991.10-1997.08	Hatchback Engine ABD/AEX		○	GWB0529	
1.6 (55 kW)	1992.09-1997.08	Hatchback Engine ABU/AEA/AEE	•		GHA422009	K
	1992.09-1997.08	Hatchback Engine ABU/AEA/AEE	•		GHA422036	K
	1992.09-1997.08	Hatchback Engine ABU/AEA/AEE	•		GWB1358	
	1992.09-1997.08	Hatchback Engine ABU/AEA/AEE		○	GHA499014	
	1992.09-1997.08	Hatchback Engine ABU/AEA/AEE		○	GHA499015	
	1992.09-1997.08	Hatchback Engine ABU/AEA/AEE		○	GHA499044	
	1992.09-1997.08	Hatchback Engine ABU/AEA/AEE		○	GHA499045	
	1992.09-1997.08	Hatchback Engine ABU/AEA/AEE		○	GHA499046	
	1992.09-1997.08	Hatchback Engine ABU/AEA/AEE		○	GWB0529	
1.6 (74 kW)	1995.07-1997.08	Hatchback Engine AEK/AFT/AKS	•		GHA422009	K
	1995.07-1997.08	Hatchback Engine AEK/AFT/AKS	•		GHA422036	K
	1995.07-1997.08	Hatchback Engine AEK/AFT/AKS	•		GWB1358	
	1995.07-1997.08	Hatchback Engine AEK/AFT/AKS		○	GHA499014	
	1995.07-1997.08	Hatchback Engine AEK/AFT/AKS		○	GHA499015	
	1995.07-1997.08	Hatchback Engine AEK/AFT/AKS		○	GHA499044	
	1995.07-1997.08	Hatchback Engine AEK/AFT/AKS		○	GHA499045	
	1995.07-1997.08	Hatchback Engine AEK/AFT/AKS		○	GHA499046	
	1995.07-1997.08	Hatchback Engine AEK/AFT/AKS		○	GWB0529	
1.8 (55 kW)	1991.11-1997.08	Hatchback Engine AAM	•		GHA422009	K
	1991.11-1997.08	Hatchback Engine AAM	•		GHA422036	K
	1991.11-1997.08	Hatchback Engine AAM	•		GWB1358	
	1991.11-1997.08	Hatchback Engine AAM		○	GHA499044	
	1991.11-1997.08	Hatchback Engine AAM		○	GHA499045	



	 YEAR		F	R	G-AP Ref.	KIT
VOLKSWAGEN						
GOLF III (1H1)						
1.8 (55 kW)	1991.11-1997.08	Hatchback Engine AAM		o	GHA499046	
	1991.11-1997.08	Hatchback Engine AAM		o	GWB0529	
1.8 (66 kW)	1991.11-1997.08	Hatchback Engine ABS/ACC/ADZ	•		GHA422009	K
	1991.11-1997.08	Hatchback Engine ABS/ACC/ADZ	•		GHA422036	K
	1991.11-1997.08	Hatchback Engine ABS/ACC/ADZ	•		GWB1358	
	1991.11-1997.08	Hatchback Engine ABS/ACC/ADZ		o	GHA499014	
	1991.11-1997.08	Hatchback Engine ABS/ACC/ADZ		o	GHA499015	
	1991.11-1997.08	Hatchback Engine ABS/ACC/ADZ		o	GHA499044	
	1991.11-1997.08	Hatchback Engine ABS/ACC/ADZ		o	GHA499045	
	1991.11-1997.08	Hatchback Engine ABS/ACC/ADZ		o	GHA499046	
	1991.11-1997.08	Hatchback Engine ABS/ACC/ADZ		o	GWB0529	
1.8 Syncro (66 kW)	1993.01-1997.08	Hatchback Engine ABS/ADZ	•		GHA422008	A
	1993.01-1997.08	Hatchback Engine ABS/ADZ	•		GHA422009	K
	1993.01-1997.08	Hatchback Engine ABS/ADZ	•		GHA422036	K
	1993.01-1997.08	Hatchback Engine ABS/ADZ	•		GWB1358	
	1993.01-1997.08	Hatchback Engine ABS/ADZ		o	GWB0575	
1.9 D (48 kW)	1991.11-1997.08	Hatchback Engine 1Y	•		GHA422009	K
	1991.11-1997.08	Hatchback Engine 1Y	•		GHA422036	K
	1991.11-1997.08	Hatchback Engine 1Y	•		GWB1358	
	1991.11-1997.08	Hatchback Engine 1Y		o	GHA499014	
	1991.11-1997.08	Hatchback Engine 1Y		o	GHA499015	
	1991.11-1997.08	Hatchback Engine 1Y		o	GHA499044	
	1991.11-1997.08	Hatchback Engine 1Y		o	GHA499045	
	1991.11-1997.08	Hatchback Engine 1Y		o	GHA499046	
1.9 SDi (47 kW)	1995.07-1997.08	Hatchback Engine AEY	•		GHA422009	K
	1995.07-1997.08	Hatchback Engine AEY	•		GHA422036	K
	1995.07-1997.08	Hatchback Engine AEY	•		GWB1358	
	1995.07-1997.08	Hatchback Engine AEY		o	GHA499014	
	1995.07-1997.08	Hatchback Engine AEY		o	GHA499015	
	1995.07-1997.08	Hatchback Engine AEY		o	GHA499044	
	1995.07-1997.08	Hatchback Engine AEY		o	GHA499045	
	1995.07-1997.08	Hatchback Engine AEY		o	GHA499046	
1.9 TD,GTD (55 kW)	1991.11-1997.08	Hatchback Engine AAZ	•		GHA422009	K
	1991.11-1997.08	Hatchback Engine AAZ	•		GHA422036	K
	1991.11-1997.08	Hatchback Engine AAZ	•		GWB1358	
	1991.11-1997.08	Hatchback Engine AAZ		o	GHA499014	
	1991.11-1997.08	Hatchback Engine AAZ		o	GHA499015	
	1991.11-1997.08	Hatchback Engine AAZ		o	GHA499044	
	1991.11-1997.08	Hatchback Engine AAZ		o	GHA499045	
	1991.11-1997.08	Hatchback Engine AAZ		o	GHA499046	
1.9 TDi (66 kW)	1993.09-1997.08	Hatchback Engine 1Z/AHU/ALE	•		GHA422009	K
	1993.09-1997.08	Hatchback Engine 1Z/AHU/ALE	•		GHA422036	K
	1993.09-1997.08	Hatchback Engine 1Z/AHU/ALE	•		GWB1358	
	1993.09-1997.08	Hatchback Engine 1Z/AHU/ALE	•		GWB1491	
	1993.09-1997.08	Hatchback Engine 1Z/AHU/ALE		o	GHA499014	
	1993.09-1997.08	Hatchback Engine 1Z/AHU/ALE		o	GHA499015	
	1993.09-1997.08	Hatchback Engine 1Z/AHU/ALE		o	GHA499044	
	1993.09-1997.08	Hatchback Engine 1Z/AHU/ALE		o	GHA499045	
	1993.09-1997.08	Hatchback Engine 1Z/AHU/ALE		o	GHA499046	
1.9 TDi (81 kW)	1996.04-1997.08	Hatchback Engine AFN	•		GHA422009	K
	1996.04-1997.08	Hatchback Engine AFN	•		GHA422036	K
	1996.04-1997.08	Hatchback Engine AFN	•		GWB1358	
	1996.04-1997.08	Hatchback Engine AFN	•		GWB1491	
	1996.04-1997.08	Hatchback Engine AFN		o	GHA499014	
	1996.04-1997.08	Hatchback Engine AFN		o	GHA499015	
	1996.04-1997.08	Hatchback Engine AFN		o	GHA499044	
	1996.04-1997.08	Hatchback Engine AFN		o	GHA499045	
	1996.04-1997.08	Hatchback Engine AFN		o	GHA499046	
1.9 TDi Syncro (66 kW)	1996.04-1997.08	Hatchback Engine AFN		o	GWB0529	
	1995.08-1997.08	Hatchback Engine 1Z/AHU/ALE	•		GHA422008	A



	 YEAR		F	R	G-AP Ref.	KIT
VOLKSWAGEN						
GOLF III (1H1)						
1.9 TDi Syncro (66 kW)	1995.08-1997.08	Hatchback Engine 1Z/AHU/ALE	•		GHA422009	K
	1995.08-1997.08	Hatchback Engine 1Z/AHU/ALE	•		GHA422036	K
	1995.08-1997.08	Hatchback Engine 1Z/AHU/ALE	•		GWB1358	
	1995.08-1997.08	Hatchback Engine 1Z/AHU/ALE		○	GWB0575	
2.0 (85 kW)	1991.11-1997.08	Hatchback Engine 2E/ABA/ADY/AGG/AKR	•		GHA422009	K
	1991.11-1997.08	Hatchback Engine 2E/ABA/ADY/AGG/AKR	•		GHA422036	K
	1991.11-1997.08	Hatchback Engine 2E/ABA/ADY/AGG/AKR	•		GHA436001	
	1991.11-1997.08	Hatchback Engine 2E/ABA/ADY/AGG/AKR	•		GWB1358	
	1991.11-1997.08	Hatchback Engine 2E/ABA/ADY/AGG/AKR		○	GHA499014	
	1991.11-1997.08	Hatchback Engine 2E/ABA/ADY/AGG/AKR		○	GHA499015	
	1991.11-1997.08	Hatchback Engine 2E/ABA/ADY/AGG/AKR		○	GHA499044	
	1991.11-1997.08	Hatchback Engine 2E/ABA/ADY/AGG/AKR		○	GHA499045	
	1991.11-1997.08	Hatchback Engine 2E/ABA/ADY/AGG/AKR		○	GHA499046	
1991.11-1997.08	Hatchback Engine 2E/ABA/ADY/AGG/AKR		○	GWB0529		
2.0 GL (79 kW)	1995.08-1997.09	Hatchback Engine AEP	•		GHA422009	K
	1995.08-1997.09	Hatchback Engine AEP	•		GHA422036	K
	1995.08-1997.09	Hatchback Engine AEP	•		GWB1358	
	1995.08-1997.09	Hatchback Engine AEP		○	GHA499014	
	1995.08-1997.09	Hatchback Engine AEP		○	GHA499015	
	1995.08-1997.09	Hatchback Engine AEP		○	GHA499044	
	1995.08-1997.09	Hatchback Engine AEP		○	GHA499045	
	1995.08-1997.09	Hatchback Engine AEP		○	GHA499046	
1995.08-1997.09	Hatchback Engine AEP		○	GWB0529		
2.0 GTi 16V (110 kW)	1992.08-1997.08	Hatchback Engine ABF	•		GHA422009	K
	1992.08-1997.08	Hatchback Engine ABF	•		GHA422036	K
	1992.08-1997.08	Hatchback Engine ABF	•		GHA436001	
	1992.08-1997.08	Hatchback Engine ABF	•		GWB1491	
	1992.08-1997.08	Hatchback Engine ABF		○	GHA499014	
	1992.08-1997.08	Hatchback Engine ABF		○	GHA499015	
	1992.08-1997.08	Hatchback Engine ABF		○	GHA499044	
	1992.08-1997.08	Hatchback Engine ABF		○	GHA499045	
	1992.08-1997.08	Hatchback Engine ABF		○	GHA499046	
1992.08-1997.08	Hatchback Engine ABF		○	GWB0529		
2.0 Syncro (85 kW)	1995.08-1997.08	Hatchback Engine AGG	•		GHA422008	A
	1995.08-1997.08	Hatchback Engine AGG	•		GHA422009	K
	1995.08-1997.08	Hatchback Engine AGG	•		GHA422036	K
	1995.08-1997.08	Hatchback Engine AGG	•		GHA436001	
	1995.08-1997.08	Hatchback Engine AGG	•		GWB1358	
	1995.08-1997.08	Hatchback Engine AGG		○	GWB0575	
2.8 VR6 (120 kW)	1995.08-1997.09	Hatchback Engine AAA	•		GHA436001	
	1995.08-1997.09	Hatchback Engine AAA	•		GWB1491	
	1995.08-1997.09	Hatchback Engine AAA		○	GWB0529	
2.8 VR6 (128 kW)	1992.01-1997.08	Hatchback Engine AAA	•		GHA436001	
	1992.01-1997.08	Hatchback Engine AAA	•		GWB1491	
	1992.01-1997.08	Hatchback Engine AAA		○	GHA499014	
	1992.01-1997.08	Hatchback Engine AAA		○	GHA499015	
	1992.01-1997.08	Hatchback Engine AAA		○	GHA499044	
	1992.01-1997.08	Hatchback Engine AAA		○	GHA499045	
	1992.01-1997.08	Hatchback Engine AAA		○	GHA499046	
1992.01-1997.08	Hatchback Engine AAA		○	GWB0529		
2.9 VR6 Syncro (140 kW)	1994.10-1997.08	Hatchback Engine ABV	•		GHA436001	
	1994.10-1997.08	Hatchback Engine ABV	•		GWB1491	
	1994.10-1997.08	Hatchback Engine ABV		○	GWB1358	
Citystromer (20 kW)	1994.11-1997.08	Hatchback	•		GHA422009	K
	1994.11-1997.08	Hatchback	•		GHA422036	K
	1994.11-1997.08	Hatchback		○	GHA499044	
GOLF III CABRIOLET (1E7)						
1.6 (74 kW)	1994.10-1998.05	Convertible Engine AEK/AFT/AKS	•		GHA422036	K
	1994.10-1998.05	Convertible Engine AEK/AFT/AKS	•		GWB1358	
	1994.10-1998.05	Convertible Engine AEK/AFT/AKS		○	GHA499044	
	1994.10-1998.05	Convertible Engine AEK/AFT/AKS		○	GHA499046	
1.8 (55 kW)	1993.07-1998.05	Convertible Engine AAM	•		GHA422036	K
	1993.07-1998.05	Convertible Engine AAM	•		GWB1358	



	 YEAR		F	R	G-AP Ref.	KIT
VOLKSWAGEN						
GOLF III CABRIOLET (1E7)						
1.8 (55 kW)	1993.07-1998.05	Convertible Engine AAM		o	GHA499044	
	1993.07-1998.05	Convertible Engine AAM		o	GHA499046	
	1993.07-1998.05	Convertible Engine AAM		o	GWB0529	
1.8 (66 kW)	1993.07-1998.05	Convertible Engine ABS/ADZ	•		GHA422036	K
	1993.07-1998.05	Convertible Engine ABS/ADZ	•		GWB1358	
	1993.07-1998.05	Convertible Engine ABS/ADZ		o	GHA499044	
	1993.07-1998.05	Convertible Engine ABS/ADZ		o	GHA499046	
	1993.07-1998.05	Convertible Engine ABS/ADZ		o	GWB0529	
1.9 TDi (66 kW)	1995.08-1998.05	Convertible Engine 1Z/AHU/ALE	•		GHA422036	K
	1995.08-1998.05	Convertible Engine 1Z/AHU/ALE	•		GWB1358	
	1995.08-1998.05	Convertible Engine 1Z/AHU/ALE		o	GHA499044	
	1995.08-1998.05	Convertible Engine 1Z/AHU/ALE		o	GHA499046	
1.9 TDi (81 kW)	1995.08-1998.05	Convertible Engine 1Z/AHU/ALE		o	GWB0529	
	1996.07-1998.05	Convertible Engine AFN	•		GHA422036	K
	1996.07-1998.05	Convertible Engine AFN	•		GWB1358	
	1996.07-1998.05	Convertible Engine AFN		o	GHA499044	
	1996.07-1998.05	Convertible Engine AFN		o	GHA499046	
2.0 (85 kW)	1996.07-1998.05	Convertible Engine AFN		o	GWB0529	
	1993.07-1998.05	Convertible Engine 2E/ADY/AGG/AKR	•		GHA422036	K
	1993.07-1998.05	Convertible Engine 2E/ADY/AGG/AKR	•		GWB1358	
	1993.07-1998.05	Convertible Engine 2E/ADY/AGG/AKR		o	GHA499014	
	1993.07-1998.05	Convertible Engine 2E/ADY/AGG/AKR		o	GHA499015	
	1993.07-1998.05	Convertible Engine 2E/ADY/AGG/AKR		o	GHA499044	
	1993.07-1998.05	Convertible Engine 2E/ADY/AGG/AKR		o	GHA499045	
GOLF III VARIANT (1H5)	1993.07-1998.05	Convertible Engine 2E/ADY/AGG/AKR		o	GHA499046	
	1993.07-1998.05	Convertible Engine 2E/ADY/AGG/AKR		o	GWB0529	
	1.4 (40 kW)	1993.07-1999.04	Estate Engine ABD	•	GHA422009	K
	1993.07-1999.04	Estate Engine ABD	•		GHA422036	K
	1993.07-1999.04	Estate Engine ABD	•		GWB1358	
	1993.07-1999.04	Estate Engine ABD		o	GHA499014	
	1993.07-1999.04	Estate Engine ABD		o	GHA499015	
	1993.07-1999.04	Estate Engine ABD		o	GHA499044	
	1993.07-1999.04	Estate Engine ABD		o	GHA499045	
	1993.07-1999.04	Estate Engine ABD		o	GHA499046	
1.4 (44 kW)	1993.07-1999.04	Estate Engine ABD		o	GWB0529	
	1993.07-1999.04	Estate Engine ABD/AEX/APQ	•		GHA422009	K
	1993.07-1999.04	Estate Engine ABD/AEX/APQ	•		GHA422036	K
	1993.07-1999.04	Estate Engine ABD/AEX/APQ	•		GWB1358	
	1993.07-1999.04	Estate Engine ABD/AEX/APQ		o	GHA499014	
	1993.07-1999.04	Estate Engine ABD/AEX/APQ		o	GHA499015	
	1993.07-1999.04	Estate Engine ABD/AEX/APQ		o	GHA499044	
	1993.07-1999.04	Estate Engine ABD/AEX/APQ		o	GHA499045	
1.6 (74 kW)	1993.07-1999.04	Estate Engine ABD/AEX/APQ		o	GHA499046	
	1993.07-1999.04	Estate Engine ABD/AEX/APQ		o	GWB0529	
	1994.07-1999.04	Estate Engine AEK/AFT/AKS	•		GHA422009	K
	1994.07-1999.04	Estate Engine AEK/AFT/AKS	•		GHA422036	K
	1994.07-1999.04	Estate Engine AEK/AFT/AKS	•		GWB1358	
	1994.07-1999.04	Estate Engine AEK/AFT/AKS		o	GHA499014	
	1994.07-1999.04	Estate Engine AEK/AFT/AKS		o	GHA499015	
	1994.07-1999.04	Estate Engine AEK/AFT/AKS		o	GHA499045	
1.8 (55 kW)	1994.07-1999.04	Estate Engine AEK/AFT/AKS		o	GHA499046	
	1994.07-1999.04	Estate Engine AEK/AFT/AKS		o	GWB0529	
	1993.07-1999.04	Estate Engine AAM/ANN	•		GHA422009	K
	1993.07-1999.04	Estate Engine AAM/ANN	•		GHA422036	K
	1993.07-1999.04	Estate Engine AAM/ANN	•		GWB1358	
	1993.07-1999.04	Estate Engine AAM/ANN		o	GHA499014	
	1993.07-1999.04	Estate Engine AAM/ANN		o	GHA499015	
	1993.07-1999.04	Estate Engine AAM/ANN		o	GHA499045	
1.8 (66 kW)	1993.07-1999.04	Estate Engine AAM/ANN		o	GHA499046	
	1993.07-1999.04	Estate Engine AAM/ANN		o	GWB0529	
	1993.07-1999.04	Estate Engine ABS/ADZ/ANP	•		GHA422009	K
1.8 (66 kW)	1993.07-1999.04	Estate Engine ABS/ADZ/ANP	•		GHA422036	K
	1993.07-1999.04	Estate Engine ABS/ADZ/ANP	•		GWB1358	



	 YEAR		F	R	G-AP Ref.	KIT
VOLKSWAGEN						
GOLF III VARIANT (1H5)						
1.8 (66 kW)	1993.07-1999.04	Estate Engine ABS/ADZ/ANP		o	GHA499014	
	1993.07-1999.04	Estate Engine ABS/ADZ/ANP		o	GHA499015	
	1993.07-1999.04	Estate Engine ABS/ADZ/ANP		o	GHA499045	
	1993.07-1999.04	Estate Engine ABS/ADZ/ANP		o	GHA499046	
	1993.07-1999.04	Estate Engine ABS/ADZ/ANP		o	GWB0529	
1.8 Syncro (66 kW)	1994.10-1999.04	Estate Engine ADZ	•		GHA422009	K
	1994.10-1999.04	Estate Engine ADZ	•		GHA422036	K
	1994.10-1999.04	Estate Engine ADZ	•		GWB1358	
	1994.10-1999.04	Estate Engine ADZ		o	GWB0575	
1.9 D (48 kW)	1993.07-1999.04	Estate Engine 1Y	•		GHA422009	K
	1993.07-1999.04	Estate Engine 1Y	•		GHA422036	K
	1993.07-1999.04	Estate Engine 1Y	•		GWB1358	
	1993.07-1999.04	Estate Engine 1Y		o	GHA499014	
	1993.07-1999.04	Estate Engine 1Y		o	GHA499015	
	1993.07-1999.04	Estate Engine 1Y		o	GHA499045	
	1993.07-1999.04	Estate Engine 1Y		o	GHA499046	
	1993.07-1999.04	Estate Engine 1Y		o	GWB0529	
1.9 SDi (47 kW)	1995.07-1999.04	Estate Engine AEY	•		GHA422009	K
	1995.07-1999.04	Estate Engine AEY	•		GHA422036	K
	1995.07-1999.04	Estate Engine AEY	•		GWB1358	
	1995.07-1999.04	Estate Engine AEY		o	GHA499014	
	1995.07-1999.04	Estate Engine AEY		o	GHA499015	
	1995.07-1999.04	Estate Engine AEY		o	GHA499045	
	1995.07-1999.04	Estate Engine AEY		o	GWB0529	
1.9 TD (55 kW)	1993.07-1999.04	Estate Engine AAZ	•		GHA422009	K
	1993.07-1999.04	Estate Engine AAZ	•		GHA422036	K
	1993.07-1999.04	Estate Engine AAZ	•		GWB1358	
	1993.07-1999.04	Estate Engine AAZ		o	GHA499014	
	1993.07-1999.04	Estate Engine AAZ		o	GHA499015	
	1993.07-1999.04	Estate Engine AAZ		o	GHA499045	
	1993.07-1999.04	Estate Engine AAZ		o	GHA499046	
	1993.07-1999.04	Estate Engine AAZ		o	GWB0529	
1.9 TDi (66 kW)	1994.03-1999.04	Estate Engine 1Z/AHU/ALE	•		GHA422009	K
	1994.03-1999.04	Estate Engine 1Z/AHU/ALE	•		GHA422036	K
	1994.03-1999.04	Estate Engine 1Z/AHU/ALE	•		GWB1358	
	1994.03-1999.04	Estate Engine 1Z/AHU/ALE		o	GHA499014	
	1994.03-1999.04	Estate Engine 1Z/AHU/ALE		o	GHA499015	
	1994.03-1999.04	Estate Engine 1Z/AHU/ALE		o	GHA499045	
	1994.03-1999.04	Estate Engine 1Z/AHU/ALE		o	GHA499046	
1.9 TDi (81 kW)	1996.04-1999.04	Estate Engine AFN	•		GHA422009	K
	1996.04-1999.04	Estate Engine AFN	•		GHA422036	K
	1996.04-1999.04	Estate Engine AFN	•		GWB1358	
	1996.04-1999.04	Estate Engine AFN		o	GHA499014	
	1996.04-1999.04	Estate Engine AFN		o	GHA499015	
	1996.04-1999.04	Estate Engine AFN		o	GHA499045	
	1996.04-1999.04	Estate Engine AFN		o	GHA499046	
	1996.04-1999.04	Estate Engine AFN		o	GWB0529	
1.9 TDi Syncro (66 kW)	1995.07-1999.04	Estate Engine 1Z/AHU/ALE	•		GHA422009	K
	1995.07-1999.04	Estate Engine 1Z/AHU/ALE	•		GHA422036	K
	1995.07-1999.04	Estate Engine 1Z/AHU/ALE	•		GWB1358	
	1995.07-1999.04	Estate Engine 1Z/AHU/ALE		o	GWB0575	
2.0 (79 kW)	1995.08-1996.04	Estate Engine AEP	•		GHA422009	K
	1995.08-1996.04	Estate Engine AEP	•		GHA422036	K
	1995.08-1996.04	Estate Engine AEP	•		GWB1358	
	1995.08-1996.04	Estate Engine AEP		o	GHA499014	
	1995.08-1996.04	Estate Engine AEP		o	GHA499015	
	1995.08-1996.04	Estate Engine AEP		o	GHA499045	
	1995.08-1996.04	Estate Engine AEP		o	GHA499046	
2.0 (85 kW)	1993.07-1999.04	Estate Engine 2E/ADY/AGG/AKR	•		GHA422009	K
	1993.07-1999.04	Estate Engine 2E/ADY/AGG/AKR	•		GHA422036	K
	1993.07-1999.04	Estate Engine 2E/ADY/AGG/AKR	•		GWB1358	



	 YEAR		F	R	G-AP Ref.	KIT
VOLKSWAGEN						
GOLF III VARIANT (1H5)						
2.0 (85 kW)	1993.07-1999.04	Estate Engine 2E/ADY/AGG/AKR		o	GHA499014	
	1993.07-1999.04	Estate Engine 2E/ADY/AGG/AKR		o	GHA499015	
	1993.07-1999.04	Estate Engine 2E/ADY/AGG/AKR		o	GHA499045	
	1993.07-1999.04	Estate Engine 2E/ADY/AGG/AKR		o	GHA499046	
	1993.07-1999.04	Estate Engine 2E/ADY/AGG/AKR		o	GWB0529	
2.0 Syncro (85 kW)	1995.08-1999.04	Estate Engine AGG	•		GHA422009	K
	1995.08-1999.04	Estate Engine AGG	•		GHA422036	K
	1995.08-1999.04	Estate Engine AGG	•		GWB1358	
	1995.08-1999.04	Estate Engine AGG		o	GWB0575	
2.9 VR6 Syncro (140 kW)	1994.10-1999.04	Estate Engine ABV	•		GHA436001	
	1994.10-1999.04	Estate Engine ABV	•		GWB1491	
	1994.10-1999.04	Estate Engine ABV		o	GWB1358	
GOLF IV (1J1)						
1.0 (43 kW)	1998.08-2002.05	Hatchback	•		GWB3455	
	1998.08-2002.05	Hatchback With ABS		o	GHA230051	K
1.4 16V (55 kW)	1997.08-2005.06	Hatchback Engine AHW/AKQ/APE/AXP/BCA	•		GHA436002	K
	1997.08-2005.06	Hatchback Engine AHW/AKQ/APE/AXP/BCA	•		GWB3455	
	1997.08-2005.06	Hatchback Engine AHW/AKQ/APE/AXP/BCA With ABS		o	GHA230051	K
1.6 (74 kW)	1997.08-2004.05	Hatchback Engine AEH/AKL/APF	•		GHA436002	K
	1997.08-2004.05	Hatchback Engine AEH/AKL/APF	•		GWB3455	
	1997.08-2004.05	Hatchback Engine AEH/AKL/APF With ABS		o	GHA230051	K
	2001.02-2001.06	Hatchback Engine BAH	•		GWB3455	
1.6 (75 kW)	2001.02-2001.06	Hatchback Engine BAH With ABS		o	GHA230051	K
	2000.08-2005.06	Hatchback Engine AVU/BFQ	•		GHA436002	K
	2000.08-2005.06	Hatchback Engine AVU/BFQ	•		GWB3455	
1.6 (78 kW)	2000.08-2005.06	Hatchback Engine AVU/BFQ With ABS		o	GHA230051	K
	2003.08-2005.06	Hatchback Engine AWB	•		GWB3455	
1.6 16V (77 kW)	2003.08-2005.06	Hatchback Engine AWB With ABS		o	GHA230051	K
	2000.02-2005.06	Hatchback Engine ATN/AUS/AZD/BCB	•		GHA436002	K
1.6 FSi (81 kW)	2000.02-2005.06	Hatchback Engine ATN/AUS/AZD/BCB	•		GWB3455	
	2000.02-2005.06	Hatchback Engine ATN/AUS/AZD/BCB With ABS		o	GHA230051	K
	2002.01-2005.06	Hatchback Engine BAD	•		GHA436002	K
1.8 (66 kW)	2002.01-2005.06	Hatchback Engine BAD	•		GWB3455	
	2002.01-2005.06	Hatchback Engine BAD With ABS		o	GHA230051	K
	1997.10-1999.09	Hatchback Engine ACC	•		GWB3455	
1.8 (92 kW)	1997.10-1999.09	Hatchback Engine ACC With ABS		o	GHA230051	K
	1997.08-2005.06	Hatchback Engine AGN/BAF	•		GHA436002	K
1.8 4motion (92 kW)	1997.08-2005.06	Hatchback Engine AGN/BAF	•		GWB3455	
	1997.08-2005.06	Hatchback Engine AGN/BAF With ABS		o	GHA230051	K
	1998.05-2005.06	Hatchback Engine AGN	•		GWB3455	
1.8 T (110 kW)	1998.05-2005.06	Hatchback Engine AGN		o	GHA436002	K
	1997.08-2005.06	Hatchback Engine AGU/AQA/ARZ/AUM/AWD	•		GHA436002	K
	1997.08-2005.06	Hatchback Engine AGU/AQA/ARZ/AUM/AWD	•		GWB3455	
1.8 T GTi (132 kW)	1997.08-2005.06	Hatchback Engine AGU/AQA/ARZ/AUM/AWD With ABS		o	GHA230051	K
	2001.08-2005.06	Hatchback Engine AUQ	•		GHA436002	K
	2001.08-2005.06	Hatchback Engine AUQ	•		GWB3607	
1.9 SDi (50 kW)	2001.08-2005.06	Hatchback Engine AUQ With ABS		o	GHA230051	K
	1997.08-2005.06	Hatchback Engine AGP/AQM	•		GHA436002	K
	1997.08-2005.06	Hatchback Engine AGP/AQM	•		GWB3455	
1.9 TD (55 kW)	1997.08-2005.06	Hatchback Engine AGP/AQM With ABS		o	GHA230051	K
	1997.10-1999.09	Hatchback Engine AAZ	•		GWB3455	
1.9 TDi (110 kW)	1997.10-1999.09	Hatchback Engine AAZ With ABS		o	GHA230051	K
	2000.05-2005.06	Hatchback Engine ARL	•		GHA436002	K
	2000.05-2005.06	Hatchback Engine ARL	•		GWB3455	
1.9 TDi (66 kW)	2000.05-2005.06	Hatchback Engine ARL With ABS		o	GHA230051	K
	1997.10-2004.05	Hatchback Engine AGR/ALH	•		GHA436002	K
	1997.10-2004.05	Hatchback Engine AGR/ALH	•		GWB3455	
1.9 TDi (74 kW)	1997.10-2004.05	Hatchback Engine AGR/ALH With ABS		o	GHA230051	K
	2000.09-2005.06	Hatchback Engine ATD/AXR	•		GHA436002	K
	2000.09-2005.06	Hatchback Engine ATD/AXR	•		GWB3455	
1.9 TDi (81 kW)	2000.09-2005.06	Hatchback Engine ATD/AXR With ABS		o	GHA230051	K
	1997.08-2004.05	Hatchback Engine AHF/ASV	•		GHA436002	K
	1997.08-2004.05	Hatchback Engine AHF/ASV	•		GWB3455	
	1997.08-2004.05	Hatchback Engine AHF/ASV With ABS		o	GHA230051	K



	 YEAR		F	R	G-AP Ref.	KIT
VOLKSWAGEN						
GOLF IV (1J1)						
1.9 TDi (85 kW)	1998.12-2001.06	Hatchback Engine AJM/AUY	•		GHA436002	K
	1998.12-2001.06	Hatchback Engine AJM/AUY	•		GWB3455	
	1998.12-2001.06	Hatchback Engine AJM/AUY With ABS		◦	GHA230051	K
1.9 TDi (96 kW)	2000.11-2005.06	Hatchback Engine ASZ	•		GHA436002	K
	2000.11-2005.06	Hatchback Engine ASZ	•		GWB3455	
	2000.11-2005.06	Hatchback Engine ASZ With ABS		◦	GHA230051	K
1.9 TDi 4motion (110 kW)	2000.02-2005.06	Hatchback Engine ARL	•		GWB3455	
	2000.02-2005.06	Hatchback Engine ARL		◦	GHA436002	K
1.9 TDi 4motion (66 kW)	1998.07-2002.04	Hatchback Engine AGR/ALH	•		GWB3455	
	1998.07-2002.04	Hatchback Engine AGR/ALH		◦	GHA436002	K
1.9 TDi 4motion (74 kW)	2000.09-2005.06	Hatchback Engine ATD	•		GWB3455	
	2000.09-2005.06	Hatchback Engine ATD		◦	GHA436002	K
1.9 TDi 4motion (85 kW)	1999.09-2001.06	Hatchback Engine AJM/AUY	•		GWB3455	
	1999.09-2001.06	Hatchback Engine AJM/AUY		◦	GHA436002	K
1.9 TDi 4motion (96 kW)	2000.11-2005.06	Hatchback Engine ASZ	•		GWB3455	
	2000.11-2005.06	Hatchback Engine ASZ		◦	GHA436002	K
2.0 (85 kW)	1998.07-2004.05	Hatchback Engine APK/AQY/AZG/AZJ/BER	•		GHA436002	K
	1998.07-2004.05	Hatchback Engine APK/AQY/AZG/AZJ/BER	•		GWB3455	
	1998.07-2004.05	Hatchback Engine APK/AQY/AZG/AZJ/BER With ABS		◦	GHA230051	K
2.0 4motion (85 kW)	2000.10-2005.06	Hatchback Engine AZH/AZJ	•		GWB3455	
	2000.10-2005.06	Hatchback Engine AZH/AZJ		◦	GHA436002	K
2.3 V5 (110 kW)	1997.08-2000.10	Hatchback Engine AGZ	•		GHA436002	K
	1997.08-2000.10	Hatchback Engine AGZ	•		GWB3455	
	1997.08-2000.10	Hatchback Engine AGZ With ABS		◦	GHA230051	K
2.3 V5 (125 kW)	2000.10-2005.06	Hatchback Engine AQN	•		GHA436002	K
	2000.10-2005.06	Hatchback Engine AQN	•		GWB3455	
	2000.10-2005.06	Hatchback Engine AQN With ABS		◦	GHA230051	K
2.3 V5 4motion (110 kW)	1998.12-2000.10	Hatchback Engine AGZ	•		GWB3455	
	1998.12-2000.10	Hatchback Engine AGZ		◦	GHA436002	K
2.3 V5 4motion (125 kW)	2000.10-2005.06	Hatchback Engine AQN	•		GWB3455	
	2000.10-2005.06	Hatchback Engine AQN		◦	GHA436002	K
2.8 V6 4motion (150 kW)	1999.03-2005.06	Hatchback Engine AQP/AUE/BDE	•		GWB3455	
	1999.03-2005.06	Hatchback Engine AQP/AUE/BDE		◦	GHA436002	K
3.2 R32 4motion (177 kW)	2002.09-2005.06	Hatchback Engine BFH/BML	•		GWB3607	
	2002.09-2005.06	Hatchback Engine BFH/BML		◦	GWB3455	
GOLF IV (1J5)						
1.4 16V (55 kW)	1999.05-2006.06	Estate Engine AHW/AKQ/APE/AXP/BCA	•		GHA436002	K
	1999.05-2006.06	Estate Engine AHW/AKQ/APE/AXP/BCA	•		GWB3455	
	1999.05-2006.06	Estate Engine AHW/AKQ/APE/AXP/BCA With ABS		◦	GHA230051	K
1.6 (74 kW)	1999.05-2002.04	Estate Engine AEH/AKL/APF	•		GHA436002	K
	1999.05-2002.04	Estate Engine AEH/AKL/APF	•		GWB3455	
	1999.05-2002.04	Estate Engine AEH/AKL/APF With ABS		◦	GHA230051	K
1.6 (75 kW)	2000.08-2006.06	Estate Engine AVU/BFQ	•		GHA436002	K
	2000.08-2006.06	Estate Engine AVU/BFQ	•		GWB3455	
	2000.08-2006.06	Estate Engine AVU/BFQ With ABS		◦	GHA230051	K
1.6 16V (77 kW)	2000.02-2006.06	Estate Engine ATN/AUS/AZD/BCB	•		GHA436002	K
	2000.02-2006.06	Estate Engine ATN/AUS/AZD/BCB	•		GWB3455	
	2000.02-2006.06	Estate Engine ATN/AUS/AZD/BCB With ABS		◦	GHA230051	K
1.6 FSi (81 kW)	2002.01-2006.06	Estate Engine BAD	•		GHA436002	K
	2002.01-2006.06	Estate Engine BAD	•		GWB3455	
	2002.01-2006.06	Estate Engine BAD With ABS		◦	GHA230051	K
1.8 4motion (92 kW)	1999.05-2006.06	Estate Engine AGN	•		GWB3455	
	1999.05-2006.06	Estate Engine AGN		◦	GHA436002	K
1.8 T (110 kW)	2000.05-2006.06	Estate Engine AGU/AQA/ARZ/AUM/AWD	•		GHA436002	K
	2000.05-2006.06	Estate Engine AGU/AQA/ARZ/AUM/AWD	•		GWB3455	
	2000.05-2006.06	Estate Engine AGU/AQA/ARZ/AUM/AWD With ABS		◦	GHA230051	K
1.9 SDi (50 kW)	1999.05-2006.06	Estate Engine AGP/AQM	•		GHA436002	K
	1999.05-2006.06	Estate Engine AGP/AQM	•		GWB3455	
	1999.05-2006.06	Estate Engine AGP/AQM With ABS		◦	GHA230051	K
1.9 TDi (66 kW)	1999.05-2006.05	Estate Engine AGR/ALH	•		GHA436002	K
	1999.05-2006.05	Estate Engine AGR/ALH	•		GWB3455	
	1999.05-2006.05	Estate Engine AGR/ALH With ABS		◦	GHA230051	K
1.9 TDi (74 kW)	2000.09-2006.06	Estate Engine ATD/AXR	•		GHA436002	K
	2000.09-2006.06	Estate Engine ATD/AXR	•		GWB3455	



	 YEAR		F	R	G-AP Ref.	KIT
VOLKSWAGEN						
GOLF IV (1J5)						
1.9 TDi (74 kW)	2000.09-2006.06	Estate Engine ATD/AXR With ABS		o	GHA230051	K
1.9 TDi (81 kW)	1999.08-2006.05	Estate Engine AHF/ASV	•		GHA436002	K
	1999.08-2006.05	Estate Engine AHF/ASV	•		GWB3455	
	1999.08-2006.05	Estate Engine AHF/ASV With ABS		o	GHA230051	K
1.9 TDi (85 kW)	1999.10-2006.05	Estate Engine AJM/AUY	•		GHA436002	K
	1999.10-2006.05	Estate Engine AJM/AUY	•		GWB3455	
	1999.10-2006.05	Estate Engine AJM/AUY With ABS		o	GHA230051	K
1.9 TDi (96 kW)	2000.11-2006.06	Estate Engine ASZ	•		GHA436002	K
	2000.11-2006.06	Estate Engine ASZ	•		GWB3455	
	2000.11-2006.06	Estate Engine ASZ With ABS		o	GHA230051	K
1.9 TDi 4motion (110 kW)	2002.05-2005.06	Estate Engine ARL	•		GWB3455	
	2002.05-2005.06	Estate Engine ARL		o	GHA436002	K
1.9 TDi 4motion (66 kW)	1999.05-2002.04	Estate Engine AGR/ALH	•		GWB3455	
	1999.05-2002.04	Estate Engine AGR/ALH		o	GHA436002	K
1.9 TDi 4motion (74 kW)	2000.09-2006.06	Estate Engine ATD	•		GWB3455	
	2000.09-2006.06	Estate Engine ATD		o	GHA436002	K
1.9 TDi 4motion (85 kW)	1999.05-2001.06	Estate Engine AJM	•		GWB3455	
	1999.05-2001.06	Estate Engine AJM		o	GHA436002	K
1.9 TDi 4motion (96 kW)	2000.11-2006.06	Estate Engine ASZ	•		GWB3455	
	2000.11-2006.06	Estate Engine ASZ		o	GHA436002	K
2.0 (85 kW)	1999.05-2006.06	Estate Engine APK/AQY/AZJ	•		GHA436002	K
	1999.05-2006.06	Estate Engine APK/AQY/AZJ	•		GWB3455	
	1999.05-2006.06	Estate Engine APK/AQY/AZJ With ABS		o	GHA230051	K
2.0 4motion (85 kW)	2000.10-2006.06	Estate Engine AZH/AZJ	•		GWB3455	
	2000.10-2006.06	Estate Engine AZH/AZJ		o	GHA436002	K
2.0 4motion (88 kW)	1999.12-2006.06	Estate Engine ATF	•		GWB3455	
2.0 BiFuel (85 kW)	2002.02-2006.06	Estate Engine BEH	•		GHA436002	K
	2002.02-2006.06	Estate Engine BEH	•		GWB3455	
	2002.02-2006.06	Estate Engine BEH With ABS		o	GHA230051	K
2.3 V5 (110 kW)	1999.05-2006.06	Estate Engine AGZ	•		GHA436002	K
	1999.05-2006.06	Estate Engine AGZ	•		GWB3455	
	1999.05-2006.06	Estate Engine AGZ With ABS		o	GHA230051	K
2.3 V5 (125 kW)	2000.10-2006.06	Estate Engine AQN	•		GHA436002	K
	2000.10-2006.06	Estate Engine AQN	•		GWB3455	
	2000.10-2006.06	Estate Engine AQN With ABS		o	GHA230051	K
2.3 V5 4motion (110 kW)	1999.05-2006.06	Estate Engine AGZ	•		GWB3455	
	1999.05-2006.06	Estate Engine AGZ		o	GHA436002	K
2.3 V5 4motion (125 kW)	2000.10-2006.06	Estate Engine AQN	•		GWB3455	
	2000.10-2006.06	Estate Engine AQN		o	GHA436002	K
2.8 V6 4motion (150 kW)	1999.05-2006.06	Estate Engine AQP/AUE/BDE	•		GWB3455	
	1999.05-2006.06	Estate Engine AQP/AUE/BDE		o	GHA436002	K
GOLF IV VARIANT (1J5)						
1.9 TDi (110 kW)	2001.06-2006.06	Estate Engine ARL	•		GHA436002	K
GOLF PLUS (5M1, 521)						
1.2 TSi (63 kW)	2010.05-	Hatchback Engine CBZA 3 hole	•		GHA336004	K
	2010.05-	Hatchback Engine CBZA 4 hole	•		GHA336007	K
	2010.05-	Hatchback Engine CBZA Inner Diameter [30mm]		o	GHA230082	K
	2010.05-	Hatchback Engine CBZA Inner Diameter [32mm]		o	GHA232018	K
1.2 TSi (77 kW)	2009.11-	Hatchback Engine CBZB 3 hole	•		GHA336004	K
	2009.11-	Hatchback Engine CBZB 4 hole	•		GHA336007	K
	2009.11-	Hatchback Engine CBZB Inner Diameter [30mm]		o	GHA230082	K
	2009.11-	Hatchback Engine CBZB Inner Diameter [32mm]		o	GHA232018	K
1.4 16V (55 kW)	2005.06-2006.05	Hatchback Engine BCA 3 hole	•		GHA336004	K
	2005.06-2006.05	Hatchback Engine BCA 4 hole	•		GHA336007	K
	2005.06-2006.05	Hatchback Engine BCA Inner Diameter [30mm]		o	GHA230082	K
	1.4 16V (59 kW)	2006.06-2008.03	Hatchback Engine BUD/CGGA 3 hole	•		GHA336004
2006.06-2008.03		Hatchback Engine BUD/CGGA 4 hole	•		GHA336007	K
2006.06-2008.03		Hatchback Engine BUD/CGGA Inner Diameter [30mm]		o	GHA230082	K
2006.06-2008.03		Hatchback Engine BUD/CGGA Inner Diameter [32mm]		o	GHA232018	K
1.4 FSi (66 kW)		2005.07-	Hatchback Engine BLN 3 hole	•		GHA336004
	2005.07-	Hatchback Engine BLN 4 hole	•		GHA336007	K
	2005.07-	Hatchback Engine BLN Inner Diameter [30mm]		o	GHA230082	K
1.4 TSi (103 kW)	2006.06-2008.03	Hatchback Engine BMY 3 hole	•		GHA336004	K
	2006.06-2008.03	Hatchback Engine BMY 4 hole	•		GHA336007	K



	 YEAR		F	R	G-AP Ref.	KIT
VOLKSWAGEN						
GOLF PLUS (5M1, 521)						
1.4 TSi (103 kW)	2006.06-2008.03	Hatchback Engine BMY Inner Diameter [30mm]		o	GHA230082	K
1.4 TSi (118 kW)	2008.06-	Hatchback Engine CAVD/CNWA 3 hole	•		GHA336004	K
	2008.06-	Hatchback Engine CAVD/CNWA 4 hole	•		GHA336007	K
	2008.06-	Hatchback Engine CAVD/CNWA Inner Diameter [30mm]		o	GHA230082	K
	2008.06-	Hatchback Engine CAVD/CNWA Inner Diameter [32mm]		o	GHA232018	K
	1.4 TSi (125 kW)	2006.05-2008.06	Hatchback Engine BLG 3 hole	•		GHA336004
1.4 TSi (90 kW)	2006.05-2008.06	Hatchback Engine BLG 4 hole	•		GHA336007	K
	2006.05-2008.06	Hatchback Engine BLG Inner Diameter [30mm]		o	GHA230082	K
	2007.09-	Hatchback Engine CAXA 3 hole	•		GHA336004	K
1.6 (75 kW)	2007.09-	Hatchback Engine CAXA 4 hole	•		GHA336007	K
	2007.09-	Hatchback Engine CAXA Inner Diameter [30mm]		o	GHA230082	K
	2007.09-	Hatchback Engine CAXA Inner Diameter [32mm]		o	GHA232018	K
	2005.05-	Hatchback Engine BSE/BSF/CCSA/CMXA 3 hole	•		GHA336004	K
1.6 BiFuel (75 kW)	2005.05-	Hatchback Engine BSE/BSF/CCSA/CMXA 4 hole	•		GHA336007	K
	2005.05-	Hatchback Engine BSE/BSF/CCSA/CMXA Inner Diameter [30mm]		o	GHA230082	K
	2005.05-	Hatchback Engine BSE/BSF/CCSA/CMXA Inner Diameter [32mm]		o	GHA232018	K
	2009.05-	Hatchback Engine CHGA 3 hole	•		GHA336004	K
1.6 FSi (85 kW)	2009.05-	Hatchback Engine CHGA 4 hole	•		GHA336007	K
	2009.05-	Hatchback Engine CHGA Inner Diameter [30mm]		o	GHA230082	K
	2009.05-	Hatchback Engine CHGA Inner Diameter [32mm]		o	GHA232018	K
	2005.06-2008.03	Hatchback Engine BLF 3 hole	•		GHA336004	K
1.6 MultiFuel (75 kW)	2005.06-2008.03	Hatchback Engine BLF 4 hole	•		GHA336007	K
	2005.06-2008.03	Hatchback Engine BLF Inner Diameter [30mm]		o	GHA230082	K
	2007.11-	Hatchback Engine CCSA/CMXA 3 hole	•		GHA336004	K
1.6 TDi (66 kW)	2007.11-	Hatchback Engine CCSA/CMXA 4 hole	•		GHA336007	K
	2007.11-	Hatchback Engine CCSA/CMXA Inner Diameter [30mm]		o	GHA230082	K
	2007.11-	Hatchback Engine CCSA/CMXA Inner Diameter [32mm]		o	GHA232018	K
	2009.02-	Hatchback Engine CAYB 3 hole	•		GHA336004	K
1.6 TDi (77 kW)	2009.02-	Hatchback Engine CAYB 4 hole	•		GHA336007	K
	2009.02-	Hatchback Engine CAYB Inner Diameter [30mm]		o	GHA230082	K
	2009.02-	Hatchback Engine CAYB Inner Diameter [32mm]		o	GHA232018	K
	2009.03-	Hatchback Engine CAYC 3 hole	•		GHA336004	K
1.9 TDi (66 kW)	2009.03-	Hatchback Engine CAYC 4 hole	•		GHA336007	K
	2009.03-	Hatchback Engine CAYC Inner Diameter [30mm]		o	GHA230082	K
	2009.03-	Hatchback Engine CAYC Inner Diameter [32mm]		o	GHA232018	K
	2005.06-2008.03	Hatchback Engine BRU/BXF/BXJ 3 hole	•		GHA336004	K
1.9 TDi (77 kW)	2005.06-2008.03	Hatchback Engine BRU/BXF/BXJ 4 hole	•		GHA336007	K
	2005.06-2008.03	Hatchback Engine BRU/BXF/BXJ Inner Diameter [30mm]		o	GHA230082	K
	2005.06-2008.03	Hatchback Engine BKC/BLS/BXE 3 hole	•		GHA336004	K
2.0 FSi (110 kW)	2005.06-2008.03	Hatchback Engine BKC/BLS/BXE 4 hole	•		GHA336007	K
	2005.06-2008.03	Hatchback Engine BKC/BLS/BXE Inner Diameter [30mm]		o	GHA230082	K
	2005.06-2008.03	Hatchback Engine BKC/BLS/BXE Inner Diameter [32mm]		o	GHA232018	K
	2005.06-2006.05	Hatchback Engine BLR/BLY/BVY/BVZ 3 hole	•		GHA336004	K
2.0 TDi (100 kW)	2005.06-2006.05	Hatchback Engine BLR/BLY/BVY/BVZ 4 hole	•		GHA336007	K
	2005.06-2006.05	Hatchback Engine BLR/BLY/BVY/BVZ Inner Diameter [30mm]		o	GHA230082	K
	2005.05-	Hatchback Engine AZV/CBDA/CFHB 3 hole	•		GHA336004	K
	2005.05-	Hatchback Engine AZV/CBDA/CFHB 4 hole	•		GHA336007	K
2.0 TDi (103 kW)	2005.05-	Hatchback Engine AZV/CBDA/CFHB Inner Diameter [30mm]		o	GHA230082	K
	2005.05-	Hatchback Engine AZV/CBDA/CFHB Inner Diameter [32mm]		o	GHA232018	K
	2006.06-2008.03	Hatchback Engine BMM 3 hole	•		GHA336004	K
	2006.06-2008.03	Hatchback Engine BMM 4 hole	•		GHA336007	K
2.0 TDi (81 kW)	2006.06-2008.03	Hatchback Engine BMM Inner Diameter [30mm]		o	GHA230082	K
	2006.06-2008.03	Hatchback Engine BMM Inner Diameter [32mm]		o	GHA232018	K
	2009.01-	Hatchback Engine CLCA/CBDC 3 hole	•		GHA336004	K
	2009.01-	Hatchback Engine CLCA/CBDC 4 hole	•		GHA336007	K
2.0 TDi (96 kW)	2009.01-	Hatchback Engine CLCA/CBDC Inner Diameter [30mm]		o	GHA230082	K
	2009.01-	Hatchback Engine CLCA/CBDC Inner Diameter [32mm]		o	GHA232018	K
	2005.05-2007.05	Hatchback Engine BEE 3 hole	•		GHA336004	K
	2005.05-2007.05	Hatchback Engine BEE 4 hole	•		GHA336007	K
2.0 TDi 16V (103 kW)	2005.05-2007.05	Hatchback Engine BEE Inner Diameter [30mm]		o	GHA230082	K
	2005.01-	Hatchback Engine BKD/CBDB/CFHC 3 hole	•		GHA336004	K
	2005.01-	Hatchback Engine BKD/CBDB/CFHC 4 hole	•		GHA336007	K
	2005.01-	Hatchback Engine BKD/CBDB/CFHC Inner Diameter [30mm]		o	GHA230082	K
	2005.01-	Hatchback Engine BKD/CBDB/CFHC Inner Diameter [32mm]		o	GHA232018	K



	 YEAR		F	R	G-AP Ref.	KIT
VOLKSWAGEN						
GOLF V (1K1)						
1.4 16V (55 kW)	2003.10-2006.05	Hatchback Engine BCA 3 hole	•		GHA336004	K
	2003.10-2006.05	Hatchback Engine BCA 4 hole	•		GHA336007	K
	2003.10-2006.05	Hatchback Engine BCA Inner Diameter [30mm]		○	GHA230082	K
	2003.10-2006.05	Hatchback Engine BCA Inner Diameter [32mm]		○	GHA232018	K
1.4 16V (59 kW)	2006.06-2007.05	Hatchback Engine BUD 3 hole	•		GHA336004	K
	2006.06-2007.05	Hatchback Engine BUD 4 hole	•		GHA336007	K
	2006.06-2007.05	Hatchback Engine BUD Inner Diameter [30mm]		○	GHA230082	K
	2006.06-2007.05	Hatchback Engine BUD Inner Diameter [32mm]		○	GHA232018	K
1.4 FSi (66 kW)	2004.02-2007.02	Hatchback Engine BKG/BLN 3 hole	•		GHA336004	K
	2004.02-2007.02	Hatchback Engine BKG/BLN 4 hole	•		GHA336007	K
	2004.02-2007.02	Hatchback Engine BKG/BLN Inner Diameter [30mm]		○	GHA230082	K
	2004.02-2007.02	Hatchback Engine BKG/BLN Inner Diameter [32mm]		○	GHA232018	K
1.4 TSi (103 kW)	2006.06-2008.03	Hatchback Engine BMY 3 hole	•		GHA336004	K
	2006.06-2008.03	Hatchback Engine BMY 4 hole	•		GHA336007	K
	2006.06-2008.03	Hatchback Engine BMY Inner Diameter [30mm]		○	GHA230082	K
	2006.06-2008.03	Hatchback Engine BMY Inner Diameter [32mm]		○	GHA232018	K
1.4 TSi (125 kW)	2006.06-2008.03	Hatchback Engine BLG 3 hole	•		GHA336004	K
	2006.06-2008.03	Hatchback Engine BLG 4 hole	•		GHA336007	K
	2006.06-2008.03	Hatchback Engine BLG Inner Diameter [30mm]		○	GHA230082	K
	2006.06-2008.03	Hatchback Engine BLG Inner Diameter [32mm]		○	GHA232018	K
1.4 TSi (90 kW)	2007.09-2008.11	Hatchback Engine CAXA 3 hole	•		GHA336004	K
	2007.09-2008.11	Hatchback Engine CAXA 4 hole	•		GHA336007	K
	2007.09-2008.11	Hatchback Engine CAXA Inner Diameter [30mm]		○	GHA230082	K
	2007.09-2008.11	Hatchback Engine CAXA Inner Diameter [32mm]		○	GHA232018	K
1.6 (75 kW)	2004.01-2008.11	Hatchback Engine BGU/BSE/BSF 3 hole	•		GHA336004	K
	2004.01-2008.11	Hatchback Engine BGU/BSE/BSF 4 hole	•		GHA336007	K
	2004.01-2008.11	Hatchback Engine BGU/BSE/BSF Inner Diameter [30mm]		○	GHA230082	K
	2004.01-2008.11	Hatchback Engine BGU/BSE/BSF Inner Diameter [32mm]		○	GHA232018	K
1.6 FSi (85 kW)	2004.02-2008.03	Hatchback Engine BAG/BLF/BLP 3 hole	•		GHA336004	K
	2004.02-2008.03	Hatchback Engine BAG/BLF/BLP 4 hole	•		GHA336007	K
	2004.02-2008.03	Hatchback Engine BAG/BLF/BLP Inner Diameter [30mm]		○	GHA230082	K
	2004.02-2008.03	Hatchback Engine BAG/BLF/BLP Inner Diameter [32mm]		○	GHA232018	K
1.6 MultiFuel (75 kW)	2007.10-2008.11	Hatchback Engine CCSA 3 hole	•		GHA336004	K
	2007.10-2008.11	Hatchback Engine CCSA 4 hole	•		GHA336007	K
	2007.10-2008.11	Hatchback Engine CCSA Inner Diameter [30mm]		○	GHA230082	K
	2007.10-2008.11	Hatchback Engine CCSA Inner Diameter [32mm]		○	GHA232018	K
1.8 GTi (132 kW)	2006.08-2008.11	Hatchback 4 hole	•		GHA336007	K
	2006.08-2008.11	Hatchback Inner Diameter [30mm]		○	GHA230082	K
	2006.08-2008.11	Hatchback Inner Diameter [32mm]		○	GHA232018	K
1.9 TDi (66 kW)	2004.05-2008.11	Hatchback Engine BRU/BXF/BXJ 3 hole	•		GHA336004	K
	2004.05-2008.11	Hatchback Engine BRU/BXF/BXJ 4 hole	•		GHA336007	K
	2004.05-2008.11	Hatchback Engine BRU/BXF/BXJ Inner Diameter [30mm]		○	GHA230082	K
	2004.05-2008.11	Hatchback Engine BRU/BXF/BXJ Inner Diameter [32mm]		○	GHA232018	K
1.9 TDi (77 kW)	2004.02-2008.03	Hatchback Engine BKC/BLS/BXE 3 hole	•		GHA336004	K
	2004.02-2008.03	Hatchback Engine BKC/BLS/BXE 4 hole	•		GHA336007	K
	2004.02-2008.03	Hatchback Engine BKC/BLS/BXE Inner Diameter [30mm]		○	GHA230082	K
	2004.02-2008.03	Hatchback Engine BKC/BLS/BXE Inner Diameter [32mm]		○	GHA232018	K
1.9 TDi 4motion (77 kW)	2004.08-2008.11	Hatchback Engine BKC/BLS/BXE 4 hole	•		GHA336007	K
2.0 (85 kW)	2006.08-2008.11	Hatchback Engine BHY/CBPA 3 hole	•		GHA336004	K
	2006.08-2008.11	Hatchback Engine BHY/CBPA 4 hole	•		GHA336007	K
	2006.08-2008.11	Hatchback Engine BHY/CBPA Inner Diameter [30mm]		○	GHA230082	K
	2006.08-2008.11	Hatchback Engine BHY/CBPA Inner Diameter [32mm]		○	GHA232018	K
2.0 FSi (110 kW)	2004.02-2005.07	Hatchback Engine AXW/BLR/BLX/BLY/BVX/BVY/BVZ 3 hole	•		GHA336004	K
	2004.02-2005.07	Hatchback Engine AXW/BLR/BLX/BLY/BVX/BVY/BVZ 4 hole	•		GHA336007	K
	2004.02-2005.07	Hatchback Engine AXW/BLR/BLX/BLY/BVX/BVY/BVZ Inner Diameter [30mm]		○	GHA230082	K
	2004.02-2005.07	Hatchback Engine AXW/BLR/BLX/BLY/BVX/BVY/BVZ Inner Diameter [32mm]		○	GHA232018	K
2.0 FSi 4motion (110 kW)	2004.08-2008.11	Hatchback Engine BLX/BVX 4 hole	•		GHA336007	K
2.0 GTi (147 kW)	2004.10-2009.02	Hatchback Engine AXX/BWA/CAWB 4 hole	•		GHA336007	K
	2004.10-2009.02	Hatchback Engine AXX/BWA/CAWB Inner Diameter [30mm]		○	GHA230082	K
	2004.10-2009.02	Hatchback Engine AXX/BWA/CAWB Inner Diameter [32mm]		○	GHA232018	K
2.0 GTi (169 kW)	2006.09-2008.12	Hatchback Engine BYD 4 hole	•		GHA336007	K
	2006.09-2008.12	Hatchback Engine BYD Inner Diameter [30mm]		○	GHA230082	K
	2006.09-2008.12	Hatchback Engine BYD Inner Diameter [32mm]		○	GHA232018	K
2.0 SDi (55 kW)	2004.02-2007.05	Hatchback Engine BDK 3 hole	•		GHA336004	K



	 YEAR		F	R	G-AP Ref.	KIT
VOLKSWAGEN						
GOLF V (1K1)						
2.0 SDi (55 kW)	2004.02-2007.05	Hatchback Engine BDK 4 hole	•		GHA336007	K
	2004.02-2007.05	Hatchback Engine BDK Inner Diameter [30mm]		○	GHA230082	K
	2004.02-2007.05	Hatchback Engine BDK Inner Diameter [32mm]		○	GHA232018	K
2.0 TDi (100 kW)	2003.10-2008.11	Hatchback Engine AZV 3 hole	•		GHA336004	K
	2003.10-2008.11	Hatchback Engine AZV 4 hole	•		GHA336007	K
	2003.10-2008.11	Hatchback Engine AZV Inner Diameter [30mm]		○	GHA230082	K
	2003.10-2008.11	Hatchback Engine AZV Inner Diameter [32mm]		○	GHA232018	K
2.0 TDi (103 kW)	2004.02-2008.03	Hatchback Engine BMM 3 hole	•		GHA336004	K
	2004.02-2008.03	Hatchback Engine BMM 4 hole	•		GHA336007	K
	2004.02-2008.03	Hatchback Engine BMM Inner Diameter [30mm]		○	GHA230082	K
	2004.02-2008.03	Hatchback Engine BMM Inner Diameter [32mm]		○	GHA232018	K
2.0 TDi (125 kW)	2006.06-2008.03	Hatchback Engine BMN 3 hole	•		GHA336004	K
	2006.06-2008.03	Hatchback Engine BMN 4 hole	•		GHA336007	K
	2006.06-2008.03	Hatchback Engine BMN Inner Diameter [30mm]		○	GHA230082	K
	2006.06-2008.03	Hatchback Engine BMN Inner Diameter [32mm]		○	GHA232018	K
2.0 TDi 16V (103 kW)	2004.02-2008.03	Hatchback Engine BKD 3 hole	•		GHA336004	K
	2004.02-2008.03	Hatchback Engine BKD 4 hole	•		GHA336007	K
	2004.02-2008.03	Hatchback Engine BKD Inner Diameter [30mm]		○	GHA230082	K
	2004.02-2008.03	Hatchback Engine BKD Inner Diameter [32mm]		○	GHA232018	K
2.0 TDi 16V 4motion (103 kW)	2004.08-2008.11	Hatchback Engine BKD 4 hole	•		GHA336007	K
2.0 TDi 4motion (103 kW)	2006.06-2008.03	Hatchback Engine BMM 4 hole	•		GHA336007	K
3.2 (184 kW)	2005.09-2008.11	Hatchback Engine BUB 4 hole	•		GHA336007	K
	2005.09-2008.11	Hatchback Engine BUB Inner Diameter [30mm]		○	GHA230082	K
	2005.09-2008.11	Hatchback Engine BUB Inner Diameter [32mm]		○	GHA232018	K
3.2 R32 4motion (177 kW)	2004.01-2008.11	Hatchback Engine BJS 4 hole	•		GHA336007	K
3.2 R32 4motion (184 kW)	2005.09-2007.05	Hatchback Engine BUB/CBRA 4 hole	•		GHA336007	K
GOLF V VARIANT (1K5)						
1.4 (59 kW)	2007.06-	Estate Engine BUD 4 hole	•		GHA336007	K
	2007.06-	Estate Engine BUD Inner Diameter [32mm]		○	GHA232018	K
1.4 TSi (103 kW)	2007.06-	Estate Engine BMY 4 hole	•		GHA336007	K
	2007.06-	Estate Engine BMY Inner Diameter [32mm]		○	GHA232018	K
1.4 TSi (118 kW)	2008.07-	Estate Engine CAVD 4 hole	•		GHA336007	K
	2008.07-	Estate Engine CAVD Inner Diameter [32mm]		○	GHA232018	K
1.4 TSi (125 kW)	2007.06-	Estate Engine BLG 4 hole	•		GHA336007	K
	2007.06-	Estate Engine BLG Inner Diameter [32mm]		○	GHA232018	K
1.4 TSi (90 kW)	2007.06-	Estate Engine CAXA 4 hole	•		GHA336007	K
	2007.06-	Estate Engine CAXA Inner Diameter [32mm]		○	GHA232018	K
1.6 (75 kW)	2007.06-	Estate Engine BSE/BSF/CCSA/BGU 4 hole	•		GHA336007	K
	2007.06-	Estate Engine BSE/BSF/CCSA/BGU Inner Diameter [32mm]		○	GHA232018	K
1.6 MultiFuel (75 kW)	2007.11-	Estate Engine CCSA 4 hole	•		GHA336007	K
	2007.11-	Estate Engine CCSA Inner Diameter [32mm]		○	GHA232018	K
1.9 TDi (77 kW)	2007.06-	Estate Engine BLS/BXE 4 hole	•		GHA336007	K
	2007.06-	Estate Engine BLS/BXE Inner Diameter [32mm]		○	GHA232018	K
1.9 TDi 4motion (77 kW)	2008.01-	Estate Engine BLS 4 hole	•		GHA336007	K
2.0 (147 kW)	2007.06-	Estate Engine BWA/CAWB 4 hole	•		GHA336007	K
	2007.06-	Estate Engine BWA/CAWB Inner Diameter [32mm]		○	GHA232018	K
2.0 TDi (100 kW)	2007.06-	Estate Engine AZV 4 hole	•		GHA336007	K
	2007.06-	Estate Engine AZV Inner Diameter [32mm]		○	GHA232018	K
2.0 TDi (103 kW)	2007.06-	Estate Engine BMM 4 hole	•		GHA336007	K
	2007.06-	Estate Engine BMM Inner Diameter [32mm]		○	GHA232018	K
2.0 TDi 16V (103 kW)	2007.06-	Estate Engine BKD/CBDB 4 hole	•		GHA336007	K
	2007.06-	Estate Engine BKD/CBDB Inner Diameter [32mm]		○	GHA232018	K
2.0 TDi 4motion (100 kW)	2007.06-	Estate Engine AZV 4 hole	•		GHA336007	K
GOLF VI (517)						
1.2 TSi (77 kW)	2011.03-2013.11	Convertible Engine CBZB 4 hole	•		GHA336007	K
	2011.03-2013.11	Convertible Engine CBZB Inner Diameter [30mm]		○	GHA230082	K
1.4 TSi (118 kW)	2011.03-	Convertible Engine CAVD/CNWA/CTHD/CTKA 4 hole	•		GHA336007	K
	2011.03-	Convertible Engine CAVD/CNWA/CTHD/CTKA Inner Diameter [30mm]		○	GHA230082	K
1.4 TSi (90 kW)	2011.11-	Convertible Engine CAXA 4 hole	•		GHA336007	K
	2011.11-	Convertible Engine CAXA Inner Diameter [30mm]		○	GHA230082	K
1.6 TDi (77 kW)	2011.03-	Convertible Engine CAYC 4 hole	•		GHA336007	K
	2011.03-	Convertible Engine CAYC Inner Diameter [30mm]		○	GHA230082	K
2.0 GTi (155 kW)	2011.11-	Convertible Engine CCZB 4 hole	•		GHA336007	K
	2011.11-	Convertible Engine CCZB Inner Diameter [30mm]		○	GHA230082	K



	 YEAR		F	R	G-AP Ref.	KIT
VOLKSWAGEN						
GOLF VI (517)						
2.0 R (195 kW)	2013.01-	Convertible Engine CDLA 4 hole	•		GHA336007	K
	2013.01-	Convertible Engine CDLA Inner Diameter [30mm]		○	GHA230082	K
2.0 TDi (103 kW)	2011.11-	Convertible Engine CFHC 4 hole	•		GHA336007	K
	2011.11-	Convertible Engine CFHC Inner Diameter [30mm]		○	GHA230082	K
2.0 TDi (110 kW)	2013.11-	Convertible Engine CUUB 3 hole	•		GHA336004	K
	2013.11-	Convertible Engine CUUB Inner Diameter [30mm]		○	GHA230082	K
2.0 TSi (162 kW)	2013.11-	Hatchback Engine ABF 3 hole	•		GHA336004	K
	2013.11-	Hatchback Engine ABF Inner Diameter [30mm]		○	GHA230082	K
GOLF VI (5K1)						
1.2 TSi (63 kW)	2010.05-2012.11	Hatchback Engine CBZA 3 hole	•		GHA336004	K
	2010.05-2012.11	Hatchback Engine CBZA 4 hole	•		GHA336007	K
	2010.05-2012.11	Hatchback Engine CBZA Inner Diameter [30mm]		○	GHA230082	K
	2010.05-2012.11	Hatchback Engine CBZA Inner Diameter [32mm]		○	GHA232018	K
1.2 TSi (77 kW)	2009.05-2012.11	Hatchback Engine CBZB 3 hole	•		GHA336004	K
	2009.05-2012.11	Hatchback Engine CBZB 4 hole	•		GHA336007	K
	2009.05-2012.11	Hatchback Engine CBZB Inner Diameter [30mm]		○	GHA230082	K
	2009.05-2012.11	Hatchback Engine CBZB Inner Diameter [32mm]		○	GHA232018	K
1.4 (59 kW)	2008.10-2012.11	Hatchback Engine CGGA 3 hole	•		GHA336004	K
	2008.10-2012.11	Hatchback Engine CGGA 4 hole	•		GHA336007	K
	2008.10-2012.11	Hatchback Engine CGGA Inner Diameter [30mm]		○	GHA230082	K
	2008.10-2012.11	Hatchback Engine CGGA Inner Diameter [32mm]		○	GHA232018	K
1.4 TSi (118 kW)	2008.10-2012.11	Hatchback Engine CTHD/CTKA/CNWA/CAVD 3 hole	•		GHA336004	K
	2008.10-2012.11	Hatchback Engine CTHD/CTKA/CNWA/CAVD 4 hole	•		GHA336007	K
	2008.10-2012.11	Hatchback Engine CTHD/CTKA/CNWA/CAVD Inner Diameter [30mm]		○	GHA230082	K
	2008.10-2012.11	Hatchback Engine CTHD/CTKA/CNWA/CAVD Inner Diameter [32mm]		○	GHA232018	K
1.4 TSi (90 kW)	2008.10-2012.11	Hatchback Engine CAXA 3 hole	•		GHA336004	K
	2008.10-2012.11	Hatchback Engine CAXA 4 hole	•		GHA336007	K
	2008.10-2012.11	Hatchback Engine CAXA Inner Diameter [30mm]		○	GHA230082	K
	2008.10-2012.11	Hatchback Engine CAXA Inner Diameter [32mm]		○	GHA232018	K
1.6 (75 kW)	2008.10-2012.11	Hatchback Engine BSE/BSF/CCSA/CMXA 3 hole	•		GHA336004	K
	2008.10-2012.11	Hatchback Engine BSE/BSF/CCSA/CMXA 4 hole	•		GHA336007	K
	2008.10-2012.11	Hatchback Engine BSE/BSF/CCSA/CMXA Inner Diameter [30mm]		○	GHA230082	K
	2008.10-2012.11	Hatchback Engine BSE/BSF/CCSA/CMXA Inner Diameter [32mm]		○	GHA232018	K
1.6 BiFuel (75 kW)	2009.03-2012.11	Hatchback Engine CHGA 3 hole	•		GHA336004	K
	2009.03-2012.11	Hatchback Engine CHGA 4 hole	•		GHA336007	K
	2009.03-2012.11	Hatchback Engine CHGA Inner Diameter [30mm]		○	GHA230082	K
	2009.03-2012.11	Hatchback Engine CHGA Inner Diameter [32mm]		○	GHA232018	K
1.6 MultiFuel (75 kW)	2008.10-2012.11	Hatchback Engine CCSA/CMXA 3 hole	•		GHA336004	K
	2008.10-2012.11	Hatchback Engine CCSA/CMXA 4 hole	•		GHA336007	K
	2008.10-2012.11	Hatchback Engine CCSA/CMXA Inner Diameter [30mm]		○	GHA230082	K
	2008.10-2012.11	Hatchback Engine CCSA/CMXA Inner Diameter [32mm]		○	GHA232018	K
1.6 TDi (66 kW)	2009.02-2012.11	Hatchback Engine CAYB 3 hole	•		GHA336004	K
	2009.02-2012.11	Hatchback Engine CAYB 4 hole	•		GHA336007	K
	2009.02-2012.11	Hatchback Engine CAYB Inner Diameter [30mm]		○	GHA230082	K
	2009.02-2012.11	Hatchback Engine CAYB Inner Diameter [32mm]		○	GHA232018	K
1.6 TDi (77 kW)	2009.02-2012.11	Hatchback Engine CAYC 3 hole	•		GHA336004	K
	2009.02-2012.11	Hatchback Engine CAYC 4 hole	•		GHA336007	K
	2009.02-2012.11	Hatchback Engine CAYC Inner Diameter [30mm]		○	GHA230082	K
	2009.02-2012.11	Hatchback Engine CAYC Inner Diameter [32mm]		○	GHA232018	K
1.8 TSi (118 kW)	2009.06-2011.01	Hatchback Engine CDAA 3 hole	•		GHA336004	K
	2009.06-2011.01	Hatchback Engine CDAA 4 hole	•		GHA336007	K
	2009.06-2011.01	Hatchback Engine CDAA Inner Diameter [30mm]		○	GHA230082	K
	2009.06-2011.01	Hatchback Engine CDAA Inner Diameter [32mm]		○	GHA232018	K
2.0 GTi (147 kW)	2009.06-2013.11	Hatchback Engine CBFA/CCTA/CCZA 4 hole	•		GHA336007	K
	2009.06-2013.11	Hatchback Engine CBFA/CCTA/CCZA Inner Diameter [30mm]		○	GHA230082	K
	2009.06-2013.11	Hatchback Engine CBFA/CCTA/CCZA Inner Diameter [32mm]		○	GHA232018	K
2.0 GTi (155 kW)	2009.04-2012.11	Hatchback Engine CCZB 4 hole	•		GHA336007	K
	2009.04-2012.11	Hatchback Engine CCZB Inner Diameter [30mm]		○	GHA230082	K
	2009.04-2012.11	Hatchback Engine CCZB Inner Diameter [32mm]		○	GHA232018	K
2.0 GTi (173 kW)	2011.05-2012.11	Hatchback Engine CDLG 4 hole	•		GHA336007	K
	2011.05-2012.11	Hatchback Engine CDLG Inner Diameter [30mm]		○	GHA230082	K
	2011.05-2012.11	Hatchback Engine CDLG Inner Diameter [32mm]		○	GHA232018	K
2.0 R 4motion (188 kW)	2009.11-2013.11	Hatchback Engine CDLC/CRZA 4 hole	•		GHA336007	K
2.0 R 4motion (195 kW)	2009.11-2011.05	Hatchback Engine CDLA 4 hole	•		GHA336007	K



	 YEAR		F	R	G-AP Ref.	KIT
VOLKSWAGEN						
GOLF VI (5K1)						
2.0 R 4motion (199 kW)	2009.11-2012.11	Hatchback Engine CDLF 4 hole	•		GHA336007	K
2.0 TDi (100 kW)	2008.10-2012.11	Hatchback Engine CBAA/CFFA 3 hole	•		GHA336004	K
	2008.10-2012.11	Hatchback Engine CBAA/CFFA 4 hole	•		GHA336007	K
	2008.10-2012.11	Hatchback Engine CBAA/CFFA Inner Diameter [30mm]		○	GHA230082	K
	2008.10-2012.11	Hatchback Engine CBAA/CFFA Inner Diameter [32mm]		○	GHA232018	K
	2008.10-2012.11	Hatchback Engine CBAB/CFFB 3 hole	•		GHA336004	K
2.0 TDi (103 kW)	2008.10-2013.05	Hatchback Engine CBAB/CFFB 4 hole	•		GHA336007	K
	2008.10-2013.05	Hatchback Engine CBAB/CFFB Inner Diameter [30mm]		○	GHA230082	K
	2008.10-2013.05	Hatchback Engine CBAB/CFFB Inner Diameter [32mm]		○	GHA232018	K
	2009.04-2012.11	Hatchback Engine CFGB/CBBB 3 hole	•		GHA336004	K
2.0 TDi (125 kW)	2009.04-2012.11	Hatchback Engine CFGB/CBBB 4 hole	•		GHA336007	K
	2009.04-2012.11	Hatchback Engine CFGB/CBBB Inner Diameter [30mm]		○	GHA230082	K
	2009.04-2012.11	Hatchback Engine CFGB/CBBB Inner Diameter [32mm]		○	GHA232018	K
	2008.10-2012.11	Hatchback Engine CBDC/CLCA 3 hole	•		GHA336004	K
2.0 TDi (81 kW)	2008.10-2012.11	Hatchback Engine CBDC/CLCA 4 hole	•		GHA336007	K
	2008.10-2012.11	Hatchback Engine CBDC/CLCA Inner Diameter [30mm]		○	GHA230082	K
	2008.10-2012.11	Hatchback Engine CBDC/CLCA Inner Diameter [32mm]		○	GHA232018	K
	2009.05-2012.11	Hatchback Engine CFFB/CBAB 3 hole	•		GHA336004	K
2.0 TDi 4motion (103 kW)	2009.05-2012.11	Hatchback Engine CFFB/CBAB 4 hole	•		GHA336007	K
	2010.12-2013.11	Hatchback 3 hole	•		GHA336004	K
Blue E-Motion (65 kW)	2010.12-2013.11	Hatchback 4 hole	•		GHA336007	K
	2010.12-2013.11	Hatchback Inner Diameter [30mm]		○	GHA230082	K
	2010.12-2013.11	Hatchback Inner Diameter [32mm]		○	GHA232018	K
GOLF VI CONVERTIBLE (517)						
1.2 TSi 16V (77 kW)	2013.11-	Convertible Engine CJZA 3 hole	•		GHA336004	K
	2013.11-	Convertible Engine CJZA Inner Diameter [30mm]		○	GHA230082	K
GOLF VI VARIANT (AJ5)						
1.2 TSi (63 kW)	2010.07-	Estate Engine CBZA 4 hole	•		GHA336007	K
	2010.07-	Estate Engine CBZA Inner Diameter [32mm]		○	GHA232018	K
1.2 TSi (77 kW)	2009.08-	Estate Engine CBZB 4 hole	•		GHA336007	K
	2009.08-	Estate Engine CBZB Inner Diameter [32mm]		○	GHA232018	K
1.4 (59 kW)	2009.07-	Estate Engine BUD/CGGA 4 hole	•		GHA336007	K
	2009.07-	Estate Engine BUD/CGGA Inner Diameter [32mm]		○	GHA232018	K
1.4 TSi (118 kW)	2009.07-	Estate Engine CAVD/CNWA/CTHD/CTKA 4 hole	•		GHA336007	K
	2009.07-	Estate Engine CAVD/CNWA/CTHD/CTKA Inner Diameter [32mm]		○	GHA232018	K
1.4 TSi (90 kW)	2009.07-	Estate Engine CAXA 4 hole	•		GHA336007	K
	2009.07-	Estate Engine CAXA Inner Diameter [32mm]		○	GHA232018	K
1.6 (75 kW)	2009.07-	Estate Engine BSE/BSF/CCSA/CMXA 4 hole	•		GHA336007	K
	2009.07-	Estate Engine BSE/BSF/CCSA/CMXA Inner Diameter [32mm]		○	GHA232018	K
1.6 MultiFuel (75 kW)	2010.07-	Estate Engine CMXA 4 hole	•		GHA336007	K
	2010.07-	Estate Engine CMXA Inner Diameter [32mm]		○	GHA232018	K
1.6 TDi (66 kW)	2009.12-	Estate Engine CAYB 4 hole	•		GHA336007	K
	2009.12-	Estate Engine CAYB Inner Diameter [32mm]		○	GHA232018	K
1.6 TDi (77 kW)	2009.07-	Estate Engine CAYC 4 hole	•		GHA336007	K
	2009.07-	Estate Engine CAYC Inner Diameter [32mm]		○	GHA232018	K
1.6 TDi 4motion (77 kW)	2009.07-	Estate Engine CAYC 4 hole	•		GHA336007	K
2.0 TDi (100 kW)	2009.07-	Estate Engine CBDA/CFHB 4 hole	•		GHA336007	K
	2009.07-	Estate Engine CBDA/CFHB Inner Diameter [32mm]		○	GHA232018	K
2.0 TDi (81 kW)	2010.01-	Estate Engine CLCA 4 hole	•		GHA336007	K
	2010.01-	Estate Engine CLCA Inner Diameter [32mm]		○	GHA232018	K
2.0 TDi 16V (103 kW)	2009.07-	Estate Engine CBDB/CFHC/CJAA/CLCB 4 hole	•		GHA336007	K
	2009.07-	Estate Engine CBDB/CFHC/CJAA/CLCB Inner Diameter [32mm]		○	GHA232018	K
2.0 TSi (147 kW)	2009.07-	Estate Engine CCZA 4 hole	•		GHA336007	K
	2009.07-	Estate Engine CCZA Inner Diameter [32mm]		○	GHA232018	K
GOLF VII (5G1)						
1.2 TSi (81 kW)	2014.04-	Hatchback Engine CYVB 3 hole	•		GHA336004	K
	2014.04-	Hatchback Engine CYVB Inner Diameter [30mm]		○	GHA230082	K
1.4 TGI (81 kW)	2013.06-	Hatchback Engine CPWA/CZBA 3 hole	•		GHA336004	K
	2013.06-	Hatchback Engine CPWA/CZBA Inner Diameter [30mm]		○	GHA230082	K
1.4 TSi (103 kW)	2012.11-	Hatchback Engine CHPA/CPTA 3 hole	•		GHA336004	K
	2012.11-	Hatchback Engine CHPA/CPTA Inner Diameter [30mm]		○	GHA230082	K
1.4 TSi (110 kW)	2014.05-	Hatchback Engine CHPB/CZDA/CZEA 3 hole	•		GHA336004	K
	2014.05-	Hatchback Engine CHPB/CZDA/CZEA Inner Diameter [30mm]		○	GHA230082	K
1.4 TSi (90 kW)	2012.11-	Hatchback Engine CMBA/CPVA/CUKA/CXSA 3 hole	•		GHA336004	K



	 YEAR		F	R	G-AP Ref.	KIT
VOLKSWAGEN						
GOLF VII (5G1)						
1.4 TSi (90 kW)	2012.11-	Hatchback Engine CMB/CPVA/CUKA/CXSA Inner Diameter [30mm]		o	GHA230082	K
1.4 TSi MultiFuel (90 kW)	2013.04-	Hatchback Engine CPVA 3 hole	•		GHA336004	K
	2013.04-	Hatchback Engine CPVA Inner Diameter [30mm]		o	GHA230082	K
1.6 TDi (66 kW)	2013.04-	Hatchback Engine CLHB/CRKA 3 hole	•		GHA336004	K
	2013.04-	Hatchback Engine CLHB/CRKA Inner Diameter [30mm]		o	GHA230082	K
1.6 TDi (81 kW)	2013.01-	Hatchback Engine CRKB/CXXB 3 hole	•		GHA336004	K
	2013.01-	Hatchback Engine CRKB/CXXB Inner Diameter [30mm]		o	GHA230082	K
1.6 TDi 4motion (81 kW)	2013.01-	Hatchback Engine CRKB/CXXB 3 hole	•		GHA336004	K
2.0 TDi (81 kW)	2012.11-	Hatchback Engine CRVA 3 hole	•		GHA336004	K
	2012.11-	Hatchback Engine CRVA Inner Diameter [30mm]		o	GHA230082	K
GOLF VII (5G1, BE1)						
1.2 TSi (63 kW)	2012.08-	Hatchback Engine CJZB/CYVA 3 hole	•		GHA336004	K
	2012.08-	Hatchback Engine CJZB/CYVA Inner Diameter [30mm]		o	GHA230082	K
1.2 TSi (77 kW)	2012.11-	Hatchback Engine CJZA 3 hole	•		GHA336004	K
	2012.11-	Hatchback Engine CJZA Inner Diameter [30mm]		o	GHA230082	K
1.4 GTE Hybrid (110 kW)	2014.05-	Hatchback Engine CUKB 3 hole	•		GHA336004	K
	2014.05-	Hatchback Engine CUKB Inner Diameter [30mm]		o	GHA230082	K
1.4 TSi (92 kW)	2014.05-	Hatchback Engine CPVB/CZCA 3 hole	•		GHA336004	K
	2014.05-	Hatchback Engine CPVB/CZCA Inner Diameter [30mm]		o	GHA230082	K
1.4 TSi MultiFuel (92 kW)	2013.12-	Hatchback Engine CPVB 3 hole	•		GHA336004	K
	2013.12-	Hatchback Engine CPVB Inner Diameter [30mm]		o	GHA230082	K
1.6 (81 kW)	2014.05-	Hatchback Engine CWVA 3 hole	•		GHA336004	K
	2014.05-	Hatchback Engine CWVA Inner Diameter [30mm]		o	GHA230082	K
1.6 TDi (77 kW)	2012.08-	Hatchback Engine CLHA 3 hole	•		GHA336004	K
	2012.08-	Hatchback Engine CLHA Inner Diameter [30mm]		o	GHA230082	K
1.6 TDi 4motion (77 kW)	2012.11-	Hatchback Engine CLHA 3 hole	•		GHA336004	K
2.0 GTD (135 kW)	2013.04-	Hatchback Engine CUNA Inner Diameter [30mm]		o	GHA230082	K
2.0 GTi (155 kW)	2013.11-	Hatchback Engine CNTA/CXCA 3 hole	•		GHA336004	K
	2013.11-	Hatchback Engine CNTA/CXCA Inner Diameter [30mm]		o	GHA230082	K
2.0 GTi (162 kW)	2013.04-	Hatchback Engine CHHB Inner Diameter [30mm]		o	GHA230082	K
2.0 GTi (169 kW)	2013.04-	Hatchback Engine CHHA Inner Diameter [30mm]		o	GHA230082	K
2.0 R 4motion (206 kW)	2013.11-	Hatchback Engine CJXB 3 hole	•		GHA336004	K
2.0 R 4motion (221 kW)	2013.11-	Hatchback Engine CJXC 3 hole	•		GHA336004	K
2.0 TDi (105 kW)	2012.08-	Hatchback Engine CRBB/CRVC 3 hole	•		GHA336004	K
	2012.08-	Hatchback Engine CRBB/CRVC Inner Diameter [30mm]		o	GHA230082	K
2.0 TDi (110 kW)	2012.11-	Hatchback Engine CKFC/CRBCCRLB/CRMB 3 hole	•		GHA336004	K
	2012.11-	Hatchback Engine CKFC/CRBCCRLB/CRMB Inner Diameter [30mm]		o	GHA230082	K
2.0 TDi 4motion (110 kW)	2012.11-	Hatchback Engine CKFC/CRBC 3 hole	•		GHA336004	K
e-Golf (85 kW)	2014.03-	Hatchback Engine EAGA Inner Diameter [30mm]		o	GHA230082	K
GOLF VII (BA5)						
1.2 TSi (63 kW)	2013.05-	Estate Engine CJZB/CYVA 3 hole	•		GHA336004	K
	2013.05-	Estate Engine CJZB/CYVA Inner Diameter [30mm]		o	GHA230082	K
1.2 TSi (77 kW)	2013.05-	Estate Engine CJZA 3 hole	•		GHA336004	K
	2013.05-	Estate Engine CJZA Inner Diameter [30mm]		o	GHA230082	K
1.4 TSi (92 kW)	2014.05-	Estate Engine CPVB/CZCA 3 hole	•		GHA336004	K
	2014.05-	Estate Engine CPVB/CZCA Inner Diameter [30mm]		o	GHA230082	K
1.4 TSi MultiFuel (90 kW)	2013.04-	Estate Engine CPVA 3 hole	•		GHA336004	K
	2013.04-	Estate Engine CPVA Inner Diameter [30mm]		o	GHA230082	K
1.4 TSi MultiFuel (92 kW)	2014.05-	Estate Engine CPVB 3 hole	•		GHA336004	K
	2014.05-	Estate Engine CPVB Inner Diameter [30mm]		o	GHA230082	K
1.6 (81 kW)	2014.05-	Estate Engine CWVA 3 hole	•		GHA336004	K
	2014.05-	Estate Engine CWVA Inner Diameter [30mm]		o	GHA230082	K
1.6 TDi (77 kW)	2013.05-	Estate Engine CLHA 3 hole	•		GHA336004	K
	2013.05-	Estate Engine CLHA Inner Diameter [30mm]		o	GHA230082	K
1.6 TDi 4motion (81 kW)	2013.05-	Estate Engine CRKB/CXXB 4 hole	•		GHA336007	K
2.0 R 4motion (206 kW)	2015.03-	Estate Engine CJXB 3 hole		o	GHA336004	K
2.0 R 4motion (221 kW)	2015.03-	Estate Engine CJXC 3 hole		o	GHA336004	K
2.0 TDi (110 kW)	2013.04-	Estate Engine CRBC/CRLB 3 hole	•		GHA336004	K
	2013.04-	Estate Engine CRBC/CRLB Inner Diameter [30mm]		o	GHA230082	K
2.0 TDi 4motion (110 kW)	2013.04-	Estate Engine CRBC/CRLB 4 hole	•		GHA336007	K
GOLF VII KOMBI (BA5)						
1.2 TSi (81 kW)	2014.04-	Estate Engine CYVB 3 hole	•		GHA336004	K
	2014.04-	Estate Engine CYVB Inner Diameter [30mm]		o	GHA230082	K
1.4 TGI (81 kW)	2013.09-	Estate Engine CPWA 3 hole	•		GHA336004	K



	 YEAR		F	R	G-AP Ref.	KIT
VOLKSWAGEN						
GOLF VII KOMBI (BA5)						
1.4 TGI (81 kW)	2013.09-	Estate Engine CPWA Inner Diameter [30mm]		o	GHA230082	K
1.4 TSi (103 kW)	2013.05-	Estate Engine CHPA 3 hole	•		GHA336004	K
	2013.05-	Estate Engine CHPA Inner Diameter [30mm]		o	GHA230082	K
1.4 TSi (110 kW)	2014.05-	Estate Engine CHPB/CZDA 3 hole	•		GHA336004	K
	2014.05-	Estate Engine CHPB/CZDA Inner Diameter [30mm]		o	GHA230082	K
1.4 TSi (90 kW)	2013.05-	Estate Engine CPVA/CXSA 3 hole	•		GHA336004	K
	2013.05-	Estate Engine CPVA/CXSA Inner Diameter [30mm]		o	GHA230082	K
1.6 TDi (66 kW)	2013.05-	Estate Engine CLHB/CRKA 3 hole	•		GHA336004	K
	2013.05-	Estate Engine CLHB/CRKA Inner Diameter [30mm]		o	GHA230082	K
1.6 TDi (81 kW)	2013.05-	Estate Engine CRKB 3 hole	•		GHA336004	K
	2013.05-	Estate Engine CRKB Inner Diameter [30mm]		o	GHA230082	K
1.6 TDi 4motion (77 kW)	2013.05-	Estate Engine CLHA 4 hole	•		GHA336007	K
2.0 TDi (81 kW)	2013.05-	Estate Engine CRVA 3 hole	•		GHA336004	K
	2013.05-	Estate Engine CRVA Inner Diameter [30mm]		o	GHA230082	K
JETTA II (19E, 1G2, 165)						
1.6 TD (44 kW)	1990.01-1991.10	Saloon Engine 1V	•		GHA422009	K
	1990.01-1991.10	Saloon Engine 1V	•		GHA422036	K
	1990.01-1991.10	Saloon Engine 1V	•		GWB1358	
	1990.01-1991.10	Saloon Engine 1V		o	GHA499044	
	1990.01-1991.10	Saloon Engine 1V		o	GHA499045	
	1990.01-1991.10	Saloon Engine 1V		o	GWB0529	
JETTA III (1K2)						
1.4 TSi (103 kW)	2007.01-2008.01	Saloon Engine BMY 4 hole	•		GHA336007	K
	2007.01-2008.01	Saloon Engine BMY Inner Diameter [32mm]		o	GHA232018	K
1.4 TSi (118 kW)	2008.07-2010.10	Saloon Engine CAVD 4 hole	•		GHA336007	K
	2008.07-2010.10	Saloon Engine CAVD Inner Diameter [32mm]		o	GHA232018	K
1.4 TSi (125 kW)	2007.01-2008.01	Saloon Engine BLG 4 hole	•		GHA336007	K
	2007.01-2008.01	Saloon Engine BLG Inner Diameter [32mm]		o	GHA232018	K
1.4 TSi (90 kW)	2007.09-2010.10	Saloon Engine CAXA 4 hole	•		GHA336007	K
	2007.09-2010.10	Saloon Engine CAXA Inner Diameter [32mm]		o	GHA232018	K
1.6 (75 kW)	2005.10-2010.10	Saloon Engine BSE/BSF/CCSA 4 hole	•		GHA336007	K
	2005.10-2010.10	Saloon Engine BSE/BSF/CCSA Inner Diameter [32mm]		o	GHA232018	K
1.6 FSi (85 kW)	2005.11-2007.12	Saloon Engine BLF 4 hole	•		GHA336007	K
	2005.11-2007.12	Saloon Engine BLF Inner Diameter [32mm]		o	GHA232018	K
1.6 MultiFuel (75 kW)	2008.01-2010.10	Saloon Engine CCSA 4 hole	•		GHA336007	K
	2008.01-2010.10	Saloon Engine CCSA Inner Diameter [32mm]		o	GHA232018	K
1.6 TDi (66 kW)	2009.12-2010.10	Saloon Engine CAYB 4 hole	•		GHA336007	K
	2009.12-2010.10	Saloon Engine CAYB Inner Diameter [32mm]		o	GHA232018	K
1.6 TDi (77 kW)	2009.06-2010.10	Saloon Engine CAYC 4 hole	•		GHA336007	K
	2009.06-2010.10	Saloon Engine CAYC Inner Diameter [32mm]		o	GHA232018	K
1.9 TDi (77 kW)	2005.08-2010.10	Saloon Engine BKC/BLS/BXE 4 hole	•		GHA336007	K
	2005.08-2010.10	Saloon Engine BKC/BLS/BXE Inner Diameter [32mm]		o	GHA232018	K
2.0 FSi (110 kW)	2005.08-2010.10	Saloon Engine BLR/BLY/BVY/BVZ 4 hole	•		GHA336007	K
	2005.08-2010.10	Saloon Engine BLR/BLY/BVY/BVZ Inner Diameter [32mm]		o	GHA232018	K
2.0 TDi (100 kW)	2007.03-2008.01	Saloon Engine AZV/CBDA 4 hole	•		GHA336007	K
	2007.03-2008.01	Saloon Engine AZV/CBDA Inner Diameter [32mm]		o	GHA232018	K
2.0 TDi (103 kW)	2005.11-2008.01	Saloon Engine BMM 4 hole	•		GHA336007	K
	2005.11-2008.01	Saloon Engine BMM Inner Diameter [32mm]		o	GHA232018	K
2.0 TDi (125 kW)	2007.12-2010.10	Saloon Engine BMN/CEGA 4 hole	•		GHA336007	K
	2007.12-2010.10	Saloon Engine BMN/CEGA Inner Diameter [32mm]		o	GHA232018	K
2.0 TDi 16V (103 kW)	2005.08-2010.10	Saloon Engine BKD/CBDB/CJAA 4 hole	•		GHA336007	K
	2005.08-2010.10	Saloon Engine BKD/CBDB/CJAA Inner Diameter [32mm]		o	GHA232018	K
2.0 TFSi (125 kW)	2008.03-2010.10	Saloon Engine CAWA 4 hole	•		GHA336007	K
	2008.03-2010.10	Saloon Engine CAWA Inner Diameter [32mm]		o	GHA232018	K
2.0 TFSi (147 kW)	2005.11-2008.01	Saloon Engine BPY/BWA/CAWB/CBFA/CCTA/CCZA 4 hole	•		GHA336007	K
	2005.11-2008.01	Saloon Engine BPY/BWA/CAWB/CBFA/CCTA/CCZA Inner Diameter [32mm]		o	GHA232018	K
2.5 FSi (110 kW)	2006.01-2010.10	Saloon Engine BTK 4 hole	•		GHA336007	K
	2006.01-2010.10	Saloon Engine BTK Inner Diameter [32mm]		o	GHA232018	K
2.5 FSi (125 kW)	2008.07-2010.10	Saloon Engine CBTA/CBUA/CCCA 4 hole	•		GHA336007	K
	2008.07-2010.10	Saloon Engine CBTA/CBUA/CCCA Inner Diameter [32mm]		o	GHA232018	K
JETTA IV (162)						
1.2 TSi (77 kW)	2011.02-	Saloon Engine CBZB 4 hole	•		GHA336007	K
	2011.02-	Saloon Engine CBZB Inner Diameter [30mm]		o	GHA230082	K
	2011.02-	Saloon Engine CBZB Inner Diameter [32mm]		o	GHA232018	K



	 YEAR		F	R	G-AP Ref.	KIT
VOLKSWAGEN						
JETTA IV (162)						
1.4 TSi (110 kW)	2011.04-	Saloon Engine CAVA/CTHA 4 hole	•		GHA336007	K
	2011.04-	Saloon Engine CAVA/CTHA Inner Diameter [30mm]		○	GHA230082	K
	2011.04-	Saloon Engine CAVA/CTHA Inner Diameter [32mm]		○	GHA232018	K
1.4 TSi (118 kW)	2011.04-	Saloon Engine CAVD/CTHD 4 hole	•		GHA336007	K
	2011.04-	Saloon Engine CAVD/CTHD Inner Diameter [30mm]		○	GHA230082	K
	2011.04-	Saloon Engine CAVD/CTHD Inner Diameter [32mm]		○	GHA232018	K
1.4 TSi (90 kW)	2011.05-	Saloon Engine CAXA/CMSB 4 hole	•		GHA336007	K
	2011.05-	Saloon Engine CAXA/CMSB Inner Diameter [30mm]		○	GHA230082	K
	2011.05-	Saloon Engine CAXA/CMSB Inner Diameter [32mm]		○	GHA232018	K
1.6 (77 kW)	2011.12-	Saloon Engine CFNA/CLRA 4 hole	•		GHA336007	K
	2011.12-	Saloon Engine CFNA/CLRA Inner Diameter [30mm]		○	GHA230082	K
	2011.12-	Saloon Engine CFNA/CLRA Inner Diameter [32mm]		○	GHA232018	K
1.6 TDi (77 kW)	2011.02-	Saloon Engine CAYC 4 hole	•		GHA336007	K
	2011.02-	Saloon Engine CAYC Inner Diameter [30mm]		○	GHA230082	K
	2011.02-	Saloon Engine CAYC Inner Diameter [32mm]		○	GHA232018	K
2.0 (85 kW)	2010.06-	Saloon Engine CBPA/CKJA 4 hole	•		GHA336007	K
	2010.06-	Saloon Engine CBPA/CKJA Inner Diameter [30mm]		○	GHA230082	K
	2010.06-	Saloon Engine CBPA/CKJA Inner Diameter [32mm]		○	GHA232018	K
2.0 TDi (103 kW)	2011.02-	Saloon Engine CFFB/CFHC/CJAA/CLCB 4 hole	•		GHA336007	K
	2011.02-	Saloon Engine CFFB/CFHC/CJAA/CLCB Inner Diameter [30mm]		○	GHA230082	K
	2011.02-	Saloon Engine CFFB/CFHC/CJAA/CLCB Inner Diameter [32mm]		○	GHA232018	K
2.0 TDi (81 kW)	2010.10-	Saloon Engine CLCA 4 hole	•		GHA336007	K
	2010.10-	Saloon Engine CLCA Inner Diameter [32mm]		○	GHA232018	K
2.0 TSi (147 kW)	2010.12-	Saloon Engine CBFA/CCTA/CCZA 4 hole	•		GHA336007	K
	2010.12-	Saloon Engine CBFA/CCTA/CCZA Inner Diameter [30mm]		○	GHA230082	K
	2010.12-	Saloon Engine CBFA/CCTA/CCZA Inner Diameter [32mm]		○	GHA232018	K
2.5 FSi (125 kW)	2010.04-	Saloon Engine CBTA/CBUA/CCCA 4 hole	•		GHA336007	K
	2010.04-	Saloon Engine CBTA/CBUA/CCCA Inner Diameter [32mm]		○	GHA232018	K
JETTA IV (162, 163)						
1.4 TSi (110 kW)	2014.08-	Saloon Engine CZDA 4 hole	•		GHA336007	K
	2014.08-	Saloon Engine CZDA Inner Diameter [32mm]		○	GHA232018	K
1.4 TSi (92 kW)	2014.08-	Saloon Engine CZCA 4 hole	•		GHA336007	K
	2014.08-	Saloon Engine CZCA Inner Diameter [32mm]		○	GHA232018	K
1.4 TSi Hybrid (110 kW)	2011.04-	Saloon Engine CNLA/CRJA 4 hole	•		GHA336007	K
	2011.04-	Saloon Engine CNLA/CRJA Inner Diameter [30mm]		○	GHA230082	K
	2011.04-	Saloon Engine CNLA/CRJA Inner Diameter [32mm]		○	GHA232018	K
1.6 (63 kW)	2013.03-	Saloon Engine CFNB 4 hole	•		GHA336007	K
	2013.03-	Saloon Engine CFNB Inner Diameter [30mm]		○	GHA230082	K
	2013.03-	Saloon Engine CFNB Inner Diameter [32mm]		○	GHA232018	K
1.8 TSi (125 kW)	2014.07-	Saloon Engine CPKA/CPRA 4 hole	•		GHA336007	K
	2014.07-	Saloon Engine CPKA/CPRA Inner Diameter [32mm]		○	GHA232018	K
2.0 TDi (110 kW)	2014.08-	Saloon Engine CUUB 4 hole	•		GHA336007	K
	2014.08-	Saloon Engine CUUB Inner Diameter [32mm]		○	GHA232018	K
2.0 TSi (155 kW)	2012.12-	Saloon Engine CPLA/CPPA 4 hole	•		GHA336007	K
	2012.12-	Saloon Engine CPLA/CPPA Inner Diameter [30mm]		○	GHA230082	K
	2012.12-	Saloon Engine CPLA/CPPA Inner Diameter [32mm]		○	GHA232018	K
LT 28-50 (281-363)						
2.4 D (51 kW)	1990.07-1996.05	Box Engine 1S/ACT	•		GWB0802	
	1990.08-1996.06	Platform/Chassis Engine 1S/ACT	•		GWB0802	
2.4 i (69 kW)	1994.03-1996.06	Box Engine 1E	•		GWB0802	
	1994.03-1996.06	Platform/Chassis Engine 1E	•		GWB0802	
2.4 TD (68 kW)	1990.08-1992.08	Platform/Chassis Engine 1G	•		GWB0802	
2.4 TD (70 kW)	1992.06-1996.05	Box Engine ACL	•		GWB0802	
	1992.08-1996.06	Platform/Chassis Engine ACL	•		GWB0802	
	1992.09-1996.06	Bus Engine ACL	•		GWB0802	
LT II (2DA, 2DD, 2DH)						
2.3 (105 kW)	1996.05-2006.07	Box Engine AGL	•		GWB3434	
	1996.05-2006.07	Box Engine AGL		○	GWB3435	
	1996.05-2006.07	Box Engine AGL		○	GWB3475	
2.5 SDi (55 kW)	1996.09-2006.07	Box Engine AGX	•		GWB3434	
	1996.09-2006.07	Box Engine AGX		○	GWB3435	
	1996.09-2006.07	Box Engine AGX		○	GWB3475	
2.5 TDi (61 kW)	2001.05-2006.07	Box Engine BBE	•		GWB3434	
	2001.05-2006.07	Box Engine BBE		○	GWB3435	



	 YEAR		F	R	G-AP Ref.	KIT
VOLKSWAGEN						
LT II (2DA, 2DD, 2DH)						
2.5 TDi (61 kW)	2001.05-2006.07	Box Engine BBE		○	GWB3475	
2.5 TDi (66 kW)	1999.05-2006.07	Box Engine APA	●		GWB3434	
	1999.05-2006.07	Box Engine APA		○	GWB3435	
2.5 TDi (70 kW)	1999.05-2006.07	Box Engine APA		○	GWB3475	
	2001.05-2006.07	Box Engine BBF	●		GWB3434	
2.5 TDi (75 kW)	2001.05-2006.07	Box Engine BBF		○	GWB3435	
	2001.05-2006.07	Box Engine BBF		○	GWB3475	
	1996.05-1999.08	Box Engine AHD	●		GWB3434	
2.5 TDi (80 kW)	1996.05-1999.08	Box Engine AHD		○	GWB3435	
	1996.05-1999.08	Box Engine AHD		○	GWB3475	
	1999.05-2006.07	Box Engine ANJ/AVR	●		GWB3434	
2.8 TDi (116 kW)	1999.05-2006.07	Box Engine ANJ/AVR		○	GWB3435	
	1999.05-2006.07	Box Engine ANJ/AVR		○	GWB3475	
	2002.04-2006.07	Box Engine AUH/BCQ	●		GWB3434	
2.8 TDi (92 kW)	2002.04-2006.07	Box Engine AUH/BCQ		○	GWB3435	
	2002.04-2006.07	Box Engine AUH/BCQ		○	GWB3475	
	1997.06-1998.12	Box Engine AGK	●		GWB3434	
2.8 TDi (96 kW)	1997.06-1998.12	Box Engine AGK		○	GWB3435	
	1997.06-1998.12	Box Engine AGK		○	GWB3475	
	1999.01-2006.07	Box Engine ATA	●		GWB3434	
LT II (2DB, 2DE, 2DK)	1999.01-2006.07	Box Engine ATA		○	GWB3435	
	1999.01-2006.07	Box Engine ATA		○	GWB3475	
	1996.05-2006.07	Bus Engine AGL	●		GWB3434	
2.3 (105 kW)	1996.05-2006.07	Bus Engine AGL		○	GWB3435	
	1996.07-2006.07	Bus Engine AGX	●		GWB3434	
2.5 SDi (55 kW)	1996.07-2006.07	Bus Engine AGX		○	GWB3435	
	2001.05-2006.07	Bus Engine BBE	●		GWB3434	
2.5 TDi (61 kW)	2001.05-2006.07	Bus Engine BBE		○	GWB3435	
	1999.05-2006.07	Bus Engine APA	●		GWB3434	
2.5 TDi (66 kW)	1999.05-2006.07	Bus Engine APA		○	GWB3435	
	2001.05-2006.07	Bus Engine BBF	●		GWB3434	
2.5 TDi (70 kW)	2001.05-2006.07	Bus Engine BBF		○	GWB3435	
	1996.05-1999.08	Bus Engine AHD	●		GWB3434	
2.5 TDi (75 kW)	1996.05-1999.08	Bus Engine AHD		○	GWB3435	
	1999.05-2006.07	Bus Engine ANJ/AVR	●		GWB3434	
2.5 TDi (80 kW)	1999.05-2006.07	Bus Engine ANJ/AVR		○	GWB3435	
	2001.05-2006.06	Bus Engine BCQ	●		GWB3434	
2.8 TDi (116 kW)	2001.05-2006.06	Bus Engine BCQ		○	GWB3435	
	1997.02-1998.12	Bus Engine AGK	●		GWB3434	
2.8 TDi (92 kW)	1997.02-1998.12	Bus Engine AGK		○	GWB3435	
	1999.01-2002.01	Bus Engine ATA	●		GWB3434	
2.8 TDi (96 kW)	1999.01-2002.01	Bus Engine ATA		○	GWB3435	
	LT II (2DC, 2DF, 2DG, 2DL, 2DM)					
2.3 (105 kW)	1996.06-2006.07	Platform/Chassis Engine AGL	●		GWB3434	
	1996.06-2006.07	Platform/Chassis Engine AGL		○	GWB3435	
	1996.06-2006.07	Platform/Chassis Engine AGL		○	GWB3475	
2.5 SDi (55 kW)	1996.09-2006.07	Platform/Chassis Engine AGX	●		GWB3434	
	1996.09-2006.07	Platform/Chassis Engine AGX		○	GWB3435	
	1996.09-2006.07	Platform/Chassis Engine AGX		○	GWB3475	
2.5 TDi (61 kW)	2001.05-2006.07	Platform/Chassis Engine BBE	●		GWB3434	
	2001.05-2006.07	Platform/Chassis Engine BBE		○	GWB3435	
	2001.05-2006.07	Platform/Chassis Engine BBE		○	GWB3475	
2.5 TDi (66 kW)	1999.05-2006.07	Platform/Chassis Engine APA	●		GWB3434	
	1999.05-2006.07	Platform/Chassis Engine APA		○	GWB3435	
	1999.05-2006.07	Platform/Chassis Engine APA		○	GWB3475	
2.5 TDi (70 kW)	2001.05-2006.07	Platform/Chassis Engine BBF	●		GWB3434	
	2001.05-2006.07	Platform/Chassis Engine BBF		○	GWB3435	
	2001.05-2006.07	Platform/Chassis Engine BBF		○	GWB3475	
2.5 TDi (75 kW)	1996.06-1999.08	Platform/Chassis Engine AHD	●		GWB3434	
	1996.06-1999.08	Platform/Chassis Engine AHD		○	GWB3435	
	1996.06-1999.08	Platform/Chassis Engine AHD		○	GWB3475	
2.5 TDi (80 kW)	1999.05-2006.07	Platform/Chassis Engine ANJ/AVR	●		GWB3434	
	1999.05-2006.07	Platform/Chassis Engine ANJ/AVR		○	GWB3435	



	 YEAR		F	R	G-AP Ref.	KIT
VOLKSWAGEN						
LT II (2DC, 2DF, 2DG, 2DL, 2DM)						
2.5 TDi (80 kW)	1999.05-2006.07	Platform/Chassis Engine ANJ/AVR		o	GWB3475	
2.8 TDi (116 kW)	2002.04-2006.07	Platform/Chassis Engine AUH/BCQ	•		GWB3434	
	2002.04-2006.07	Platform/Chassis Engine AUH/BCQ		o	GWB3435	
2.8 TDi (92 kW)	2002.04-2006.07	Platform/Chassis Engine AUH/BCQ		o	GWB3475	
	1997.06-1998.12	Platform/Chassis Engine AGK	•		GWB3434	
	1997.06-1998.12	Platform/Chassis Engine AGK		o	GWB3435	
2.8 TDi (96 kW)	1997.06-1998.12	Platform/Chassis Engine AGK		o	GWB3475	
	1999.01-2006.07	Platform/Chassis Engine ATA	•		GWB3434	
	1999.01-2006.07	Platform/Chassis Engine ATA		o	GWB3435	
	1999.01-2006.07	Platform/Chassis Engine ATA		o	GWB3475	
LUPO (6X1, 6E1)						
1.0 (37 kW)	1998.09-2005.07	Hatchback Engine AER/ALD/ALL/ANV/AUC	•		GHA422022	
	1998.09-2005.07	Hatchback Engine AER/ALD/ALL/ANV/AUC	•		GWB0906	
	1998.09-2005.07	Hatchback Engine AER/ALD/ALL/ANV/AUC With ABS		o	GHA228041	K
	1998.09-2005.07	Hatchback Engine AER/ALD/ALL/ANV/AUC Without ABS		o	GHA228052	
	1998.10-2000.05	Hatchback Engine AHT	•		GHA422022	
	1998.10-2000.05	Hatchback Engine AHT	•		GWB0906	
	1998.10-2000.05	Hatchback Engine AHT With ABS		o	GHA228041	K
	1998.10-2000.05	Hatchback Engine AHT Without ABS		o	GHA228052	
1.2 TDi (45 kW)	1999.07-2005.07	Hatchback Engine ANY/AYZ	•		GHA320003	K
	1999.07-2005.07	Hatchback Engine ANY/AYZ		o	GHA225029	K
1.4 (44 kW)	2000.10-2005.07	Hatchback Engine AUD	•		GHA422022	
	2000.10-2005.07	Hatchback Engine AUD	•		GWB0906	
	2000.10-2005.07	Hatchback Engine AUD With ABS		o	GHA228041	K
	2000.10-2005.07	Hatchback Engine AUD Without ABS		o	GHA228052	
1.4 16V (55 kW)	1998.09-2005.07	Hatchback Engine AHW/AKQ/APE/AUA/BBY	•		GHA422022	
	1998.09-2005.07	Hatchback Engine AHW/AKQ/APE/AUA/BBY	•		GWB0906	
	1998.09-2005.07	Hatchback Engine AHW/AKQ/APE/AUA/BBY With ABS		o	GHA228041	K
	1998.09-2005.07	Hatchback Engine AHW/AKQ/APE/AUA/BBY Without ABS		o	GHA228052	
1.4 16V (74 kW)	1999.08-2005.07	Hatchback Engine AFK/AQQ/AUB	•		GHA422022	
	1999.08-2005.07	Hatchback Engine AFK/AQQ/AUB	•		GWB0906	
	1999.08-2005.07	Hatchback Engine AFK/AQQ/AUB With ABS		o	GHA228041	K
	1999.08-2005.07	Hatchback Engine AFK/AQQ/AUB Without ABS		o	GHA228052	
1.4 FSi (77 kW)	2001.02-2005.07	Hatchback Engine ARR	•		GHA422022	
	2001.02-2005.07	Hatchback Engine ARR	•		GWB0906	
	2001.02-2005.07	Hatchback Engine ARR With ABS		o	GHA228041	K
	2001.02-2005.07	Hatchback Engine ARR Without ABS		o	GHA228052	
1.4 TDi (55 kW)	1999.01-2005.07	Hatchback Engine AMF	•		GHA422022	
	1999.01-2005.07	Hatchback Engine AMF	•		GWB0906	
	1999.01-2005.07	Hatchback Engine AMF With ABS		o	GHA228041	K
	1999.01-2005.07	Hatchback Engine AMF Without ABS		o	GHA228052	
1.6 GTi (92 kW)	2000.09-2005.07	Hatchback Engine AVY	•		GHA422022	
	2000.09-2005.07	Hatchback Engine AVY	•		GWB0906	
	2000.09-2005.07	Hatchback Engine AVY With ABS		o	GHA228041	K
	2000.09-2005.07	Hatchback Engine AVY Without ABS		o	GHA228052	
1.7 SDi (44 kW)	1998.09-2005.07	Hatchback Engine AKU	•		GHA422022	
	1998.09-2005.07	Hatchback Engine AKU	•		GWB0906	
	1998.09-2005.07	Hatchback Engine AKU With ABS		o	GHA228041	K
	1998.09-2005.07	Hatchback Engine AKU Without ABS		o	GHA228052	
MULTIVAN V (7HM, 7HN, 7HF, 7EF, 7EM, 7EN)						
1.9 TDi (62 kW)	2006.01-2009.11	MPV Engine BRR	•		GHA338001	K
1.9 TDi (63 kW)	2003.04-2009.11	MPV Engine AXC	•		GHA338001	K
1.9 TDi (75 kW)	2006.06-2009.11	MPV Engine BRS	•		GHA338001	K
1.9 TDi (77 kW)	2003.04-2009.11	MPV Engine AXB	•		GHA338001	K
2.0 (85 kW)	2003.11-	MPV Engine AXA	•		GHA338001	K
2.0 BiTDi (132 kW)	2009.09-	MPV Engine CFCA	•		GHA338001	K
2.0 BiTDi 4motion (132 kW)	2009.09-	MPV Engine CFCA	•		GHA338001	K
2.0 TDi (100 kW)	2010.05-	MPV Engine CAAE/CCHB	•		GHA338001	K
2.0 TDi (103 kW)	2009.09-	MPV Engine CAAC/CCHA	•		GHA338001	K
2.0 TDi (62 kW)	2009.09-	MPV Engine CAAA	•		GHA338001	K
2.0 TDi (75 kW)	2009.09-	MPV Engine CAAB	•		GHA338001	K
2.0 TDi (84 kW)	2011.05-	MPV Engine CAAD	•		GHA338001	K
2.0 TDi 4motion (100 kW)	2010.05-	MPV Engine CAAE/CCHB	•		GHA338001	K
2.0 TDi 4motion (103 kW)	2009.09-	MPV Engine CAAC/CCHA	•		GHA338001	K



	 YEAR		F	R	G-AP Ref.	KIT
VOLKSWAGEN						
MULTIVAN V (7HM, 7HN, 7HF, 7EF, 7EM, 7EN)						
2.0 TSi (110 kW)	2012.07-	MPV Engine CJKB	•		GHA338001	K
2.0 TSi (150 kW)	2011.05-	MPV Engine CJKA	•		GHA338001	K
2.0 TSi 4motion (150 kW)	2011.07-	MPV Engine CJKA	•		GHA338001	K
2.5 TDi (120 kW)	2003.11-2009.11	MPV Engine BLJ	•		GHA338001	K
2.5 TDi (128 kW)	2003.04-2009.11	MPV Engine AXE/BPC	•		GHA338001	K
2.5 TDi (96 kW)	2003.04-2009.11	MPV Engine AXD/BNZ	•		GHA338001	K
2.5 TDi 4motion (128 kW)	2004.07-2009.11	MPV Engine AXE/BPC	•		GHA338001	K
2.5 TDi 4motion (96 kW)	2004.07-2009.11	MPV Engine AXD/BNZ	•		GHA338001	K
3.2 V6 (170 kW)	2004.02-2004.06	MPV Engine BDL	•		GHA338001	K
3.2 V6 (173 kW)	2004.02-2009.11	MPV Engine BKK/CFLA	•		GHA338001	K
3.2 V6 4motion (173 kW)	2004.07-2009.11	MPV Engine BKK/CFLA	•		GHA338001	K
MULTIVAN VI (SGF, SGM, SGN)						
2.0 TDi (103 kW)	2015.04	MPV Engine CXFA/CXHA	•		GHA338001	K
2.0 TDi (110 kW)	2015.04	MPV Engine CXFA/CXHA	•		GHA338001	K
2.0 TDi (132 kW)	2015.04	MPV Engine CFCA	•		GHA338001	K
2.0 TDi (150 kW)	2015.06	MPV Engine CXEB	•		GHA338001	K
2.0 TDi (62 kW)	2015.04-	MPV Engine CXGA	•		GHA338001	K
2.0 TDi (75 kW)	2015.04	MPV Engine CAAB/CXGB	•		GHA338001	K
2.0 TDi 4motion (103 kW)	2015.06	MPV Engine CAAC	•		GHA338001	K
2.0 TDi 4motion (110 kW)	2015.08-	MPV Engine CXFA	•		GHA338001	K
2.0 TDi 4motion (132 kW)	2015.06	MPV Engine CFCA	•		GHA338001	K
2.0 TDi 4motion (150 kW)	2015.06	MPV Engine CXEB	•		GHA338001	K
2.0 TSi (110 kW)	2015.04	MPV Engine CJKB	•		GHA338001	K
2.0 TSi (150 kW)	2015.04	MPV Engine CJKA	•		GHA338001	K
2.0 TSi 4motion (150 kW)	2015.06	MPV Engine CJKA	•		GHA338001	K
NEW BEETLE (1Y7)						
1.4 (55 kW)	2003.01-2010.09	Convertible Engine BCA	•		GHA436002	K
	2003.01-2010.09	Convertible Engine BCA	•		GWB3455	
	2003.01-2010.09	Convertible Engine BCA With ABS		◦	GHA230051	K
1.6 (75 kW)	2003.01-2010.09	Convertible Engine BFS	•		GHA436002	K
	2003.01-2010.09	Convertible Engine BFS	•		GWB3455	
	2003.01-2010.09	Convertible Engine BFS With ABS		◦	GHA230051	K
1.8 T (110 kW)	2004.01-2007.05	Convertible Engine AWU/AWV/BKF	•		GHA436002	K
	2004.01-2007.05	Convertible Engine AWU/AWV/BKF	•		GWB3455	
	2004.01-2007.05	Convertible Engine AWU/AWV/BKF With ABS		◦	GHA230051	K
1.9 TDi (74 kW)	2003.06-2010.09	Convertible Engine AXR	•		GHA436002	K
	2003.06-2010.09	Convertible Engine AXR	•		GWB3455	
	2003.06-2010.09	Convertible Engine AXR With ABS		◦	GHA230051	K
1.9 TDi (77 kW)	2005.07-2010.09	Convertible Engine BSW	•		GHA436002	K
	2005.07-2010.09	Convertible Engine BSW	•		GWB3455	
	2005.07-2010.09	Convertible Engine BSW With ABS		◦	GHA230051	K
2.0 (85 kW)	2002.09-2010.10	Convertible Engine AZJ/BEV	•		GHA436002	K
	2002.09-2010.10	Convertible Engine AZJ/BEV	•		GWB3455	
	2002.09-2010.10	Convertible Engine AZJ/BEV With ABS		◦	GHA230051	K
2.5 (110 kW)	2005.07-2010.09	Convertible Engine BPR/BPS	•		GHA436002	K
	2005.07-2010.09	Convertible Engine BPR/BPS	•		GWB3455	
	2005.07-2010.09	Convertible Engine BPR/BPS With ABS		◦	GHA230051	K
NEW BEETLE (9C1, 1C1)						
1.4 (55 kW)	2001.11-	Hatchback Engine BCA	•		GHA436002	K
	2001.11-	Hatchback Engine BCA	•		GWB3455	
	2001.11-	Hatchback Engine BCA With ABS		◦	GHA230051	K
1.6 (74 kW)	1999.10-2000.09	Hatchback Engine AWH	•		GHA436002	K
	1999.10-2000.09	Hatchback Engine AWH	•		GWB3455	
	1999.10-2000.09	Hatchback Engine AWH With ABS		◦	GHA230051	K
1.6 (75 kW)	2000.06-	Hatchback Engine AYD/BFS	•		GHA436002	K
	2000.06-	Hatchback Engine AYD/BFS	•		GWB3455	
	2000.06-	Hatchback Engine AYD/BFS With ABS		◦	GHA230051	K
1.8 T (110 kW)	1999.10-	Hatchback Engine AGU/APH/AVC/AWU/AWV/BKF	•		GHA436002	K
	1999.10-	Hatchback Engine AGU/APH/AVC/AWU/AWV/BKF	•		GWB3455	
	1999.10-	Hatchback Engine AGU/APH/AVC/AWU/AWV/BKF With ABS		◦	GHA230051	K
1.8 T (132 kW)	2001.11-2005.06	Hatchback Engine AWP/BNU	•		GHA436002	K
	2001.11-2005.06	Hatchback Engine AWP/BNU	•		GWB3455	
	2001.11-2005.06	Hatchback Engine AWP/BNU With ABS		◦	GHA230051	K
1.9 TDi (66 kW)	1998.01-2004.06	Hatchback Engine ALH	•		GHA436002	K



	 YEAR		F	R	G-AP Ref.	KIT
VOLKSWAGEN						
NEW BEETLE (9C1, 1C1)						
1.9 TDi (66 kW)	1998.01-2004.06	Hatchback Engine ALH	•		GWB3455	
	1998.01-2004.06	Hatchback Engine ALH With ABS		◦	GHA230051	K
1.9 TDi (74 kW)	2001.02-	Hatchback Engine ATD/BEW	•		GHA436002	K
	2001.02-	Hatchback Engine ATD/BEW	•		GWB3455	
	2001.02-	Hatchback Engine ATD/BEW With ABS		◦	GHA230051	K
1.9 TDi (77 kW)	2005.07-	Hatchback Engine BSW	•		GHA436002	K
	2005.07-	Hatchback Engine BSW	•		GWB3455	
	2005.07-	Hatchback Engine BSW With ABS		◦	GHA230051	K
2.0 (85 kW)	1998.01-	Hatchback Engine AEG/AQY/AVH/AZJ/BEJ/BER/BHP/CBPA	•		GHA436002	K
	1998.01-	Hatchback Engine AEG/AQY/AVH/AZJ/BEJ/BER/BHP/CBPA	•		GWB3455	
	1998.01-	Hatchback Engine AEG/AQY/AVH/AZJ/BEJ/BER/BHP/CBPA With ABS		◦	GHA230051	K
2.3 V5 (125 kW)	2000.10-	Hatchback Engine AQN	•		GHA436002	K
	2000.10-	Hatchback Engine AQN	•		GWB3455	
	2000.10-	Hatchback Engine AQN With ABS		◦	GHA230051	K
2.5 (110 kW)	2005.07-	Hatchback Engine BPR/BPS	•		GHA436002	K
	2005.07-	Hatchback Engine BPR/BPS	•		GWB3455	
	2005.07-	Hatchback Engine BPR/BPS With ABS		◦	GHA230051	K
3.2 RSi 4motion (165 kW)	2000.04-2001.05	Hatchback Engine AXJ	•		GWB3455	
	2000.04-2001.05	Hatchback Engine AXJ		◦	GHA436002	K
	2000.04-2001.05	Hatchback Engine AXJ With ABS		◦	GHA230051	K
PASSAT (362)						
1.4 TSi (118 kW)	2012.11-	Saloon Engine CTHD 4 hole	•		GHA336007	K
	2012.11-	Saloon Engine CTHD Inner Diameter [32mm]		◦	GHA232018	K
1.4 TSi (90 kW)	2010.08-	Saloon Engine CAXA 4 hole	•		GHA336007	K
	2010.08-	Saloon Engine CAXA Inner Diameter [32mm]		◦	GHA232018	K
1.4 TSi EcoFuel (110 kW)	2010.08-	Saloon Engine CDGA 4 hole	•		GHA336007	K
	2010.08-	Saloon Engine CDGA Inner Diameter [32mm]		◦	GHA232018	K
1.4 TSi MultiFuel (118 kW)	2010.11-	Saloon Engine CKMA 4 hole	•		GHA336007	K
	2010.11-	Saloon Engine CKMA Inner Diameter [32mm]		◦	GHA232018	K
1.6 TDi (77 kW)	2010.08-	Saloon Engine CAYC 4 hole	•		GHA336007	K
	2010.08-	Saloon Engine CAYC Inner Diameter [32mm]		◦	GHA232018	K
1.8 TSi (112 kW)	2011.02-	Saloon Engine CDAB 4 hole	•		GHA336007	K
	2011.02-	Saloon Engine CDAB Inner Diameter [32mm]		◦	GHA232018	K
1.8 TSi (118 kW)	2010.08-	Saloon Engine CDAA 4 hole	•		GHA336007	K
	2010.08-	Saloon Engine CDAA Inner Diameter [32mm]		◦	GHA232018	K
2.0 TDi (100 kW)	2010.08-	Saloon Engine CFFA 4 hole	•		GHA336007	K
	2010.08-	Saloon Engine CFFA Inner Diameter [32mm]		◦	GHA232018	K
2.0 TDi (103 kW)	2010.08-	Saloon Engine CFFB 4 hole	•		GHA336007	K
	2010.08-	Saloon Engine CFFB Inner Diameter [32mm]		◦	GHA232018	K
2.0 TDi (125 kW)	2010.08-	Saloon Engine CFGB/CLLA 4 hole	•		GHA336007	K
	2010.08-	Saloon Engine CFGB/CLLA Inner Diameter [32mm]		◦	GHA232018	K
2.0 TDi (130 kW)	2012.12-	Saloon Engine CFGC 4 hole	•		GHA336007	K
	2012.12-	Saloon Engine CFGC Inner Diameter [32mm]		◦	GHA232018	K
2.0 TDi 4motion (103 kW)	2010.08-	Saloon Engine CFFB 4 hole	•		GHA336007	K
2.0 TDi 4motion (125 kW)	2010.08-	Saloon Engine CFGB/CLLA 4 hole	•		GHA336007	K
2.0 TDi 4motion (130 kW)	2013.01-	Saloon Engine CFGC 4 hole	•		GHA336007	K
2.0 TSi (155 kW)	2010.11-	Saloon Engine CCZB 4 hole	•		GHA336007	K
	2010.11-	Saloon Engine CCZB Inner Diameter [32mm]		◦	GHA232018	K
3.6 FSi 4motion (220 kW)	2011.01-	Saloon Engine BWS 4 hole	•		GHA336007	K
PASSAT (3A2, 35I)						
1.6 (74 kW)	1994.10-1996.08	Saloon Engine AEK/AFT	•		GHA422036	K
	1994.10-1996.08	Saloon Engine AEK/AFT	•		GWB1358	
	1994.10-1996.08	Saloon Engine AEK/AFT		◦	GHA499014	
	1994.10-1996.08	Saloon Engine AEK/AFT		◦	GHA499015	
	1994.10-1996.08	Saloon Engine AEK/AFT		◦	GHA499044	
	1994.10-1996.08	Saloon Engine AEK/AFT		◦	GHA499045	
	1994.10-1996.08	Saloon Engine AEK/AFT		◦	GHA499046	
	1994.10-1996.08	Saloon Engine AEK/AFT		◦	GWB0529	
1.8 (55 kW)	1990.08-1996.08	Saloon Engine AAM	•		GHA422009	K
	1990.08-1996.08	Saloon Engine AAM	•		GHA422036	K
	1990.08-1996.08	Saloon Engine AAM	•		GWB1358	
	1990.08-1996.08	Saloon Engine AAM		◦	GHA499044	
	1990.08-1996.08	Saloon Engine AAM		◦	GHA499045	
	1990.08-1996.08	Saloon Engine AAM		◦	GHA499046	



	 YEAR		F	R	G-AP Ref.	KIT
VOLKSWAGEN						
PASSAT (3A2, 35I)						
1.8 (55 kW)	1990.08-1996.08	Saloon Engine AAM		o	GWB0529	
1.8 GL (102 kW)	1991.08-1993.09	Saloon Engine KR	•		GHA422009	K
	1991.08-1993.09	Saloon Engine KR	•		GHA422036	K
	1991.08-1993.09	Saloon Engine KR	•		GWB1358	
	1991.08-1993.09	Saloon Engine KR		o	GHA499046	
	1991.08-1993.09	Saloon Engine KR		o	GWB0529	
	1991.08-1993.09	Saloon Engine KR		o	GWB0529	
1.9 TD (55 kW)	1991.03-1996.08	Saloon Engine AAZ	•		GHA422009	K
	1991.03-1996.08	Saloon Engine AAZ	•		GHA422036	K
	1991.03-1996.08	Saloon Engine AAZ	•		GWB1358	
	1991.03-1996.08	Saloon Engine AAZ		o	GHA499014	
	1991.03-1996.08	Saloon Engine AAZ		o	GHA499015	
	1991.03-1996.08	Saloon Engine AAZ		o	GHA499044	
	1991.03-1996.08	Saloon Engine AAZ		o	GHA499045	
	1991.03-1996.08	Saloon Engine AAZ		o	GHA499046	
	1991.03-1996.08	Saloon Engine AAZ		o	GWB0529	
	1991.03-1996.08	Saloon Engine AAZ		o	GWB0529	
1.9 TDi (66 kW)	1993.10-1996.08	Saloon Engine 1Z/AHU	•		GHA422036	K
	1993.10-1996.08	Saloon Engine 1Z/AHU	•		GWB1358	
	1993.10-1996.08	Saloon Engine 1Z/AHU		o	GHA499014	
	1993.10-1996.08	Saloon Engine 1Z/AHU		o	GHA499015	
	1993.10-1996.08	Saloon Engine 1Z/AHU		o	GHA499044	
	1993.10-1996.08	Saloon Engine 1Z/AHU		o	GHA499045	
	1993.10-1996.08	Saloon Engine 1Z/AHU		o	GHA499046	
	1993.10-1996.08	Saloon Engine 1Z/AHU		o	GWB0529	
1.9 TDi (81 kW)	1996.03-1996.08	Saloon Engine AFN	•		GHA436001	
	1996.03-1996.08	Saloon Engine AFN	•		GWB1491	
	1996.03-1996.08	Saloon Engine AFN		o	GHA499014	
	1996.03-1996.08	Saloon Engine AFN		o	GHA499015	
	1996.03-1996.08	Saloon Engine AFN		o	GHA499045	
	1996.03-1996.08	Saloon Engine AFN		o	GHA499046	
	1996.03-1996.08	Saloon Engine AFN		o	GWB0529	
2.0 (79 kW)	1995.03-1996.08	Saloon Engine AEP	•		GHA422036	K
	1995.03-1996.08	Saloon Engine AEP	•		GWB1358	
	1995.03-1996.08	Saloon Engine AEP		o	GHA499014	
	1995.03-1996.08	Saloon Engine AEP		o	GHA499015	
	1995.03-1996.08	Saloon Engine AEP		o	GHA499045	
	1995.03-1996.08	Saloon Engine AEP		o	GHA499046	
	1995.03-1996.08	Saloon Engine AEP		o	GWB0529	
2.0 (85 kW)	1990.02-1996.08	Saloon Engine 2E/ADY/AGG	•		GHA422009	K
	1990.02-1996.08	Saloon Engine 2E/ADY/AGG	•		GHA422036	K
	1990.02-1996.08	Saloon Engine 2E/ADY/AGG	•		GWB1358	
	1990.02-1996.08	Saloon Engine 2E/ADY/AGG		o	GHA499014	
	1990.02-1996.08	Saloon Engine 2E/ADY/AGG		o	GHA499015	
	1990.02-1996.08	Saloon Engine 2E/ADY/AGG		o	GHA499045	
	1990.02-1996.08	Saloon Engine 2E/ADY/AGG		o	GHA499046	
	1990.02-1996.08	Saloon Engine 2E/ADY/AGG		o	GWB0529	
2.0 16V (110 kW)	1994.01-1996.08	Saloon Engine ABF	•		GHA436001	
	1994.01-1996.08	Saloon Engine ABF	•		GWB1491	
	1994.01-1996.08	Saloon Engine ABF		o	GHA499014	
	1994.01-1996.08	Saloon Engine ABF		o	GHA499015	
	1994.01-1996.08	Saloon Engine ABF		o	GHA499045	
	1994.01-1996.08	Saloon Engine ABF		o	GHA499046	
	1994.01-1996.08	Saloon Engine ABF		o	GWB0529	
2.0 Syncro (85 kW)	1990.10-1996.08	Saloon Engine 2E/ADY/AGG	•		GHA422009	K
	1990.10-1996.08	Saloon Engine 2E/ADY/AGG	•		GHA422036	K
	1990.10-1996.08	Saloon Engine 2E/ADY/AGG	•		GWB1358	
	1990.10-1996.08	Saloon Engine 2E/ADY/AGG		o	GHA422008	A
	1990.10-1996.08	Saloon Engine 2E/ADY/AGG		o	GWB0575	
2.8 VR6 (128 kW)	1991.06-1996.08	Saloon Engine AAA	•		GHA422036	K
	1991.06-1996.08	Saloon Engine AAA	•		GHA436001	
	1991.06-1996.08	Saloon Engine AAA	•		GWB1358	
	1991.06-1996.08	Saloon Engine AAA	•		GWB1491	
	1991.06-1996.08	Saloon Engine AAA		o	GHA499014	
	1991.06-1996.08	Saloon Engine AAA		o	GHA499015	
	1991.06-1996.08	Saloon Engine AAA		o	GHA499045	



	 YEAR		F	R	G-AP Ref.	KIT
VOLKSWAGEN						
PASSAT (3A2, 35I)						
2.8 VR6 (128 kW)	1991.06-1996.08	Saloon Engine AAA		o	GHA499046	
	1991.06-1996.08	Saloon Engine AAA		o	GWB0529	
PASSAT (3B2)						
1.6 (74 kW)	1996.10-2000.11	Saloon Engine ADP/AHL/ANA/ARM	•		GHA433002	
	1996.10-2000.11	Saloon Engine ADP/AHL/ANA/ARM	•		GWB1355	
	1996.10-2000.11	Saloon Engine ADP/AHL/ANA/ARM		o	GHA400003	
1.8 (112 kW)	2000.01-2001.12	Saloon Engine AEB	•		GWB1355	
	2000.01-2001.12	Saloon Engine AEB		o	GHA400003	
1.8 (85 kW)	1997.01-2000.11	Saloon Engine AFY	•		GHA433002	
	1997.01-2000.11	Saloon Engine AFY	•		GWB1355	
	1997.01-2000.11	Saloon Engine AFY		o	GHA400003	
1.8 (92 kW)	1996.10-2000.11	Saloon Engine ADR/APT/ARG	•		GHA433002	
	1996.10-2000.11	Saloon Engine ADR/APT/ARG	•		GWB1355	
	1996.10-2000.11	Saloon Engine ADR/APT/ARG		o	GHA400003	
1.8 Syncro/4motion (92 kW)	1996.10-2000.11	Saloon Engine ADR/APT/ARG	•		GWB1356	
	1996.10-2000.11	Saloon Engine ADR/APT/ARG		o	GHA433002	
	1996.10-2000.11	Saloon Engine ADR/APT/ARG		o	GWB1355	
1.8 T (110 kW)	1996.10-2000.11	Saloon Engine AEB/ANB/APU	•		GHA433002	
	1996.10-2000.11	Saloon Engine AEB/ANB/APU	•		GWB1355	
	1996.10-2000.11	Saloon Engine AEB/ANB/APU		o	GHA400003	
1.8 T Syncro (110 kW)	1996.11-2000.08	Saloon Engine AEB	•		GWB1356	
	1996.11-2000.08	Saloon Engine AEB		o	GHA433002	
	1996.11-2000.08	Saloon Engine AEB		o	GWB1355	
1.9 TDi (66 kW)	1996.10-2000.11	Saloon Engine AHH/AHU	•		GHA433002	
	1996.10-2000.11	Saloon Engine AHH/AHU	•		GWB1355	
	1996.10-2000.11	Saloon Engine AHH/AHU		o	GHA400003	
1.9 TDi (74 kW)	2000.02-2000.11	Saloon Engine AVB	•		GHA433002	
	2000.02-2000.11	Saloon Engine AVB	•		GWB1355	
	2000.02-2000.11	Saloon Engine AVB	•		GWB1356	
	2000.02-2000.11	Saloon Engine AVB		o	GHA400003	
1.9 TDi (81 kW)	1996.10-2000.11	Saloon Engine AFN/AVG	•		GHA433002	
	1996.10-2000.11	Saloon Engine AFN/AVG	•		GWB1356	
	1996.10-2000.11	Saloon Engine AFN/AVG		o	GHA400003	
1.9 TDi (85 kW)	1998.08-2000.11	Saloon Engine AJM/ATJ	•		GHA433002	
	1998.08-2000.11	Saloon Engine AJM/ATJ	•		GWB1355	
	1998.08-2000.11	Saloon Engine AJM/ATJ	•		GWB1356	
	1998.08-2000.11	Saloon Engine AJM/ATJ		o	GHA400003	
1.9 TDi 4motion (85 kW)	1999.08-2000.11	Saloon Engine ATJ	•		GWB1356	
	1999.08-2000.11	Saloon Engine ATJ		o	GHA433002	
	1999.08-2000.11	Saloon Engine ATJ		o	GWB1355	
1.9 TDi Syncro/4motion (81 kW)	1996.10-2000.11	Saloon Engine AFN/AVG	•		GWB1355	
	1996.10-2000.11	Saloon Engine AFN/AVG		o	GHA433002	
2.0 (88 kW)	2000.04-2000.11	Saloon Engine ASU/AUZ	•		GWB1355	
	2000.04-2000.11	Saloon Engine ASU/AUZ		o	GHA400003	
2.0 4motion (88 kW)	2000.04-2000.11	Saloon Engine ASU		o	GHA433002	
2.3 VR5 (110 kW)	1996.10-2000.11	Saloon Engine AGZ	•		GHA433002	
	1996.10-2000.11	Saloon Engine AGZ	•		GWB1355	
	1996.10-2000.11	Saloon Engine AGZ	•		GWB1356	
	1996.10-2000.11	Saloon Engine AGZ		o	GHA400003	
2.3 VR5 Syncro/4motion (110 kW)	1997.10-2000.11	Saloon Engine AGZ	•		GWB1355	
	1997.10-2000.11	Saloon Engine AGZ		o	GHA433002	
2.5 TDi (110 kW)	1998.07-2000.11	Saloon Engine AFB/AKN	•		GHA433002	
	1998.07-2000.11	Saloon Engine AFB/AKN	•		GWB1356	
	1998.07-2000.11	Saloon Engine AFB/AKN		o	GHA400003	
2.5 TDi Syncro/4motion (110 kW)	1998.12-2000.11	Saloon Engine AFB/AKN	•		GWB1356	
	1998.12-2000.11	Saloon Engine AFB/AKN		o	GHA433002	
	1998.12-2000.11	Saloon Engine AFB/AKN		o	GWB1355	
2.8 Syncro (132 kW)	1997.05-1999.09	Saloon Engine AGE	•		GWB1356	
	1997.05-1999.09	Saloon Engine AGE		o	GHA433002	
	1997.05-1999.09	Saloon Engine AGE		o	GWB1355	
2.8 V6 (132 kW)	1997.05-1999.09	Saloon Engine AGE	•		GWB1356	
	1997.05-1999.09	Saloon Engine AGE		o	GHA400003	
2.8 V6 (140 kW)	1999.09-2000.11	Saloon Engine ATX/BBG	•		GWB1356	
	1999.09-2000.11	Saloon Engine ATX/BBG		o	GHA400003	



	 YEAR		F	R	G-AP Ref.	KIT
VOLKSWAGEN						
PASSAT (3B2)						
2.8 V6 (142 kW)	1996.08-2000.11	Saloon Engine AHA/APR/ACK	•		GWB1356	
	1996.08-2000.11	Saloon Engine AHA/APR/ACK		◦	GHA400003	
2.8 V6 Syncro/4motion (142 kW)	1996.10-2000.11	Saloon Engine ACK/AHA/ALG/APR/AQD	•		GWB1356	
	1996.10-2000.11	Saloon Engine ACK/AHA/ALG/APR/AQD		◦	GHA433002	
	1996.10-2000.11	Saloon Engine ACK/AHA/ALG/APR/AQD		◦	GWB1355	
PASSAT (3B3)						
1.6 (75 kW)	2000.11-2005.05	Saloon Engine ALZ	•		GHA433002	
	2000.11-2005.05	Saloon Engine ALZ	•		GWB1355	
	2000.11-2005.05	Saloon Engine ALZ		◦	GHA400003	
1.8 T (125 kW)	2001.02-2005.05	Saloon Engine AWM	•		GWB1356	
	2001.02-2005.05	Saloon Engine AWM		◦	GHA400003	
1.8 T 20V (110 kW)	2000.11-2005.05	Saloon Engine AWL/AWT	•		GHA433002	
	2000.11-2005.05	Saloon Engine AWL/AWT	•		GWB1355	
	2000.11-2005.05	Saloon Engine AWL/AWT	•		GWB1356	
	2000.11-2005.05	Saloon Engine AWL/AWT		◦	GHA400003	
1.9 TDi (74 kW)	2000.11-2005.05	Saloon Engine AVB	•		GHA433002	
	2000.11-2005.05	Saloon Engine AVB	•		GWB1355	
	2000.11-2005.05	Saloon Engine AVB	•		GWB1356	
	2000.11-2005.05	Saloon Engine AVB		◦	GHA400003	
1.9 TDi (96 kW)	2000.11-2005.05	Saloon Engine AVF/AWX	•		GWB1356	
	2000.11-2005.05	Saloon Engine AVF/AWX		◦	GHA400003	
1.9 TDi 4motion (96 kW)	2000.11-2005.05	Saloon Engine AVF	•		GWB1356	
	2000.11-2005.05	Saloon Engine AVF		◦	GHA433002	
	2000.11-2005.05	Saloon Engine AVF		◦	GWB1355	
2.0 (85 kW)	2000.11-2005.05	Saloon Engine AZM/BFF	•		GHA433002	
	2000.11-2005.05	Saloon Engine AZM/BFF	•		GWB1355	
	2000.11-2005.05	Saloon Engine AZM/BFF		◦	GHA400003	
2.0 (96 kW)	2001.11-2005.05	Saloon Engine ALT	•		GHA433002	
	2001.11-2005.05	Saloon Engine ALT	•		GWB1355	
	2001.11-2005.05	Saloon Engine ALT		◦	GHA400003	
2.0 4motion (85 kW)	2000.11-2005.05	Saloon Engine AZM	•		GWB1355	
	2000.11-2005.05	Saloon Engine AZM		◦	GHA433002	
2.0 TDi (100 kW)	2003.12-2005.05	Saloon Engine BGW	•		GWB1356	
	2003.12-2005.05	Saloon Engine BGW		◦	GHA400003	
2.3 V5 (125 kW)	2000.11-2005.05	Saloon Engine AZX	•		GHA433002	
	2000.11-2005.05	Saloon Engine AZX	•		GWB1356	
	2000.11-2005.05	Saloon Engine AZX		◦	GHA400003	
2.3 V5 4motion (125 kW)	2000.11-2005.05	Saloon Engine AZX	•		GWB1356	
	2000.11-2005.05	Saloon Engine AZX		◦	GHA433002	
	2000.11-2005.05	Saloon Engine AZX		◦	GWB1355	
2.5 TDi (110 kW)	2000.11-2005.05	Saloon Engine AFB/AKN	•		GWB1356	
	2000.11-2005.05	Saloon Engine AFB/AKN		◦	GHA400003	
2.5 TDi (120 kW)	2003.05-2005.05	Saloon Engine BDG	•		GWB1356	
	2003.05-2005.05	Saloon Engine BDG		◦	GHA400003	
2.5 TDi 4motion (110 kW)	2000.11-2005.05	Saloon Engine AFB/AKN	•		GWB1356	
	2000.11-2005.05	Saloon Engine AFB/AKN		◦	GHA433002	
	2000.11-2005.05	Saloon Engine AFB/AKN		◦	GWB1355	
2.5 TDi 4motion (132 kW)	2003.01-2005.05	Saloon Engine BAU/BDH	•		GWB1356	
	2003.01-2005.05	Saloon Engine BAU/BDH		◦	GHA433002	
	2003.01-2005.05	Saloon Engine BAU/BDH		◦	GWB1355	
2.8 4motion (142 kW)	2000.11-2005.05	Saloon Engine AMX/ATQ	•		GWB1356	
	2000.11-2005.05	Saloon Engine AMX/ATQ		◦	GHA433002	
	2000.11-2005.05	Saloon Engine AMX/ATQ		◦	GWB1355	
4.0 W8 4motion (202 kW)	2001.09-2004.09	Saloon Engine BDN	•		GHA245010	K
	2001.09-2004.09	Saloon Engine BDN	•		GWB1356	
	2001.09-2004.09	Saloon Engine BDN		◦	GHA433002	
PASSAT (3B5)						
2.8 Syncro (132 kW)	1997.05-1999.09	Estate Engine AGE	•		GWB1356	
	1997.05-1999.09	Estate Engine AGE		◦	GHA400003	
	1997.05-1999.09	Estate Engine AGE		◦	GHA433002	
PASSAT (3C2)						
1.4 TSi (90 kW)	2007.05-2010.07	Saloon Engine CAXA 4 hole	•		GHA336007	K
	2007.05-2010.07	Saloon Engine CAXA Inner Diameter [32mm]		◦	GHA232018	K
1.4 TSi EcoFuel (110 kW)	2009.01-2010.07	Saloon Engine CDGA 4 hole	•		GHA336007	K



	 YEAR		F	R	G-AP Ref.	KIT
VOLKSWAGEN						
PASSAT (3C2)						
1.4 TSi EcoFuel (110 kW)	2009.01-2010.07	Saloon Engine CDGA Inner Diameter [32mm]		o	GHA232018	K
1.6 (75 kW)	2005.05-2010.07	Saloon Engine BSE/BSF 4 hole	•		GHA336007	K
	2005.05-2010.07	Saloon Engine BSE/BSF Inner Diameter [32mm]		o	GHA232018	K
1.6 FSi (85 kW)	2005.05-2007.11	Saloon Engine BLF 4 hole	•		GHA336007	K
	2005.05-2007.11	Saloon Engine BLF Inner Diameter [32mm]		o	GHA232018	K
1.6 TDi (77 kW)	2009.08-2010.07	Saloon Engine CAYC 4 hole	•		GHA336007	K
	2009.08-2010.07	Saloon Engine CAYC Inner Diameter [32mm]		o	GHA232018	K
1.8 TSi (112 kW)	2009.11-2010.07	Saloon Engine CDAB/CGYA 4 hole	•		GHA336007	K
	2009.11-2010.07	Saloon Engine CDAB/CGYA Inner Diameter [32mm]		o	GHA232018	K
1.8 TSi (118 kW)	2007.05-2010.07	Saloon Engine BZB/CDA 4 hole	•		GHA336007	K
	2007.05-2010.07	Saloon Engine BZB/CDA Inner Diameter [32mm]		o	GHA232018	K
1.9 TDi (77 kW)	2005.03-2008.11	Saloon Engine BKC/BLS/BXE 4 hole	•		GHA336007	K
	2005.03-2008.11	Saloon Engine BKC/BLS/BXE Inner Diameter [32mm]		o	GHA232018	K
2.0 BlueTDi (105 kW)	2009.01-	Saloon Engine CBAC 4 hole	•		GHA336007	K
	2009.01-	Saloon Engine CBAC Inner Diameter [32mm]		o	GHA232018	K
2.0 FSi (110 kW)	2005.03-2010.07	Saloon Engine BLR/BLY/BVY/BVZ 4 hole	•		GHA336007	K
	2005.03-2010.07	Saloon Engine BLR/BLY/BVY/BVZ Inner Diameter [32mm]		o	GHA232018	K
2.0 FSi (125 kW)	2007.08-2010.07	Saloon Engine CCTB 4 hole	•		GHA336007	K
	2007.08-2010.07	Saloon Engine CCTB Inner Diameter [32mm]		o	GHA232018	K
2.0 FSi (147 kW)	2005.07-2010.07	Saloon Engine AXV/BPY/BWA/CAWB/CBFA/CCCTA/CCZA 4 hole	•		GHA336007	K
	2005.07-2010.07	Saloon Engine AXV/BPY/BWA/CAWB/CBFA/CCCTA/CCZA Inner Diameter [32mm]		o	GHA232018	K
2.0 FSi 4motion (110 kW)	2005.09-2010.07	Saloon Engine BLX/BLY/BVX 4 hole	•		GHA336007	K
2.0 TDi (100 kW)	2005.03-2010.11	Saloon Engine BMA/CBAA 4 hole	•		GHA336007	K
	2005.03-2010.11	Saloon Engine BMA/CBAA Inner Diameter [32mm]		o	GHA232018	K
2.0 TDi (103 kW)	2005.05-2007.11	Saloon Engine BMP 4 hole	•		GHA336007	K
	2005.05-2007.11	Saloon Engine BMP Inner Diameter [32mm]		o	GHA232018	K
2.0 TDi (120 kW)	2005.08-	Saloon Engine BUZ 4 hole	•		GHA336007	K
	2005.08-	Saloon Engine BUZ Inner Diameter [32mm]		o	GHA232018	K
2.0 TDi (125 kW)	2005.08-	Saloon Engine BMR/CBBB 4 hole	•		GHA336007	K
	2005.08-	Saloon Engine BMR/CBBB Inner Diameter [32mm]		o	GHA232018	K
2.0 TDi (81 kW)	2008.11-2010.07	Saloon Engine CBDC 4 hole	•		GHA336007	K
	2008.11-2010.07	Saloon Engine CBDC Inner Diameter [32mm]		o	GHA232018	K
2.0 TDi (88 kW)	2005.11-2007.05	Saloon Engine BWV 4 hole	•		GHA336007	K
	2005.11-2007.05	Saloon Engine BWV Inner Diameter [32mm]		o	GHA232018	K
2.0 TDi (90 kW)	2005.08-2006.07	Saloon Engine BVE 4 hole	•		GHA336007	K
	2005.08-2006.07	Saloon Engine BVE Inner Diameter [32mm]		o	GHA232018	K
2.0 TDi 16V (103 kW)	2005.05-2007.11	Saloon Engine BKP/CBAB 4 hole	•		GHA336007	K
	2005.05-2007.11	Saloon Engine BKP/CBAB Inner Diameter [32mm]		o	GHA232018	K
2.0 TDi 16V 4motion (103 kW)	2005.03-	Saloon Engine BKP/CBAB 4 hole	•		GHA336007	K
2.0 TDi 4motion (103 kW)	2005.03-	Saloon Engine BMP 4 hole	•		GHA336007	K
2.0 TDi 4motion (125 kW)	2009.05-	Saloon Engine CBBB 4 hole	•		GHA336007	K
3.2 FSi 4motion (184 kW)	2005.11-2010.07	Saloon Engine AXZ 4 hole	•		GHA336007	K
3.6 R36 4motion (220 kW)	2007.04-2010.07	Saloon Engine BWS 4 hole	•		GHA336007	K
PASSAT ALLTRACK (365)						
1.8 TSi (112 kW)	2012.01-	Estate Engine CDAB 4 hole	•		GHA336007	K
	2012.01-	Estate Engine CDAB Inner Diameter [32mm]		o	GHA232018	K
1.8 TSi (118 kW)	2012.01-	Estate Engine CDAA 4 hole	•		GHA336007	K
	2012.01-	Estate Engine CDAA Inner Diameter [32mm]		o	GHA232018	K
2.0 TDi (103 kW)	2012.01-	Estate Engine CFFB 4 hole	•		GHA336007	K
	2012.01-	Estate Engine CFFB Inner Diameter [32mm]		o	GHA232018	K
2.0 TDi 4motion (103 kW)	2012.01-	Estate Engine CFFB 4 hole	•		GHA336007	K
2.0 TDi 4motion (125 kW)	2012.01-	Estate Engine CFGB 4 hole	•		GHA336007	K
2.0 TDi 4motion (130 kW)	2013.01-	Estate Engine CFGC 4 hole	•		GHA336007	K
2.0 TSi 4motion (155 kW)	2012.01-	Estate Engine CCZB 4 hole	•		GHA336007	K
PASSAT ALLTRACK (3G5)						
2.0 TDi 4motion (110 kW)	2015.05-	Estate Engine CRLB/DFEA 3 hole		o	GHA336004	K
2.0 TDi 4motion (140 kW)	2015.05-	Estate Engine DDAA/DFCA 3 hole		o	GHA336004	K
2.0 TDi 4motion (176 kW)	2015.05-	Estate Engine CUAA 3 hole		o	GHA336004	K
2.0 TSi 4motion (162 kW)	2015.07-	Estate Engine CHHB 3 hole		o	GHA336004	K
PASSAT CC (357)						
1.4 TSi MultiFuel (118 kW)	2011.01-	Coupe Engine CKMA 4 hole	•		GHA336007	K
	2011.01-	Coupe Engine CKMA Inner Diameter [32mm]		o	GHA232018	K
1.8 TSi (112 kW)	2008.11-2010.05	Coupe Engine CDAB/CGYA 4 hole	•		GHA336007	K
	2008.11-2010.05	Coupe Engine CDAB/CGYA Inner Diameter [32mm]		o	GHA232018	K



	 YEAR		F	R	G-AP Ref.	KIT
VOLKSWAGEN						
PASSAT CC (357)						
1.8 TSi (118 kW)	2008.06-2010.11	Coupe Engine BZB/CDAA 4 hole	•		GHA336007	K
	2008.06-2010.11	Coupe Engine BZB/CDAA Inner Diameter [32mm]		◦	GHA232018	K
2.0 BlueTDi (105 kW)	2009.05-2010.11	Coupe Engine CBAC 4 hole	•		GHA336007	K
	2009.05-2010.11	Coupe Engine CBAC Inner Diameter [32mm]		◦	GHA232018	K
2.0 TDi (100 kW)	2008.06-2011.05	Coupe Engine CBAA/CFFA 4 hole	•		GHA336007	K
	2008.06-2011.05	Coupe Engine CBAA/CFFA Inner Diameter [32mm]		◦	GHA232018	K
2.0 TDi (103 kW)	2008.06-	Coupe Engine CBAB/CFFB 4 hole	•		GHA336007	K
	2008.06-	Coupe Engine CBAB/CFFB Inner Diameter [32mm]		◦	GHA232018	K
2.0 TDi (120 kW)	2008.05-2011.05	Coupe Engine CBBA 4 hole	•		GHA336007	K
	2008.05-2011.05	Coupe Engine CBBA Inner Diameter [32mm]		◦	GHA232018	K
2.0 TDi (125 kW)	2008.06-	Coupe Engine CBBB/CFGB/CLLA 4 hole	•		GHA336007	K
	2008.06-	Coupe Engine CBBB/CFGB/CLLA Inner Diameter [32mm]		◦	GHA232018	K
2.0 TDi 4motion (103 kW)	2009.08-	Coupe Engine CBAB/CFFB 4 hole	•		GHA336007	K
2.0 TDi 4motion (125 kW)	2009.11-	Coupe Engine CFGB/CBBB 4 hole	•		GHA336007	K
2.0 TSi (147 kW)	2008.06-	Coupe Engine CAWB/CCZA 4 hole	•		GHA336007	K
	2008.06-	Coupe Engine CAWB/CCZA Inner Diameter [32mm]		◦	GHA232018	K
2.0 TSi (155 kW)	2010.11-	Coupe Engine CCZB 4 hole	•		GHA336007	K
	2010.11-	Coupe Engine CCZB Inner Diameter [32mm]		◦	GHA232018	K
3.6 FSi 4motion (206 kW)	2008.06-2012.01	Coupe Engine BLV/CNNA 4 hole	•		GHA336007	K
3.6 FSi 4motion (220 kW)	2008.06-2010.05	Coupe Engine BWS 4 hole	•		GHA336007	K
PASSAT VARIANT (365)						
1.4 TSi (118 kW)	2012.11-	Estate Engine CTHD 4 hole	•		GHA336007	K
	2012.11-	Estate Engine CTHD Inner Diameter [32mm]		◦	GHA232018	K
1.4 TSi (90 kW)	2010.08-	Estate Engine CAXA 4 hole	•		GHA336007	K
	2010.08-	Estate Engine CAXA Inner Diameter [32mm]		◦	GHA232018	K
1.4 TSi EcoFuel (110 kW)	2010.08-	Estate Engine CDGA 4 hole	•		GHA336007	K
	2010.08-	Estate Engine CDGA Inner Diameter [32mm]		◦	GHA232018	K
1.4 TSi MultiFuel (118 kW)	2010.11-	Estate Engine CKMA 4 hole	•		GHA336007	K
	2010.11-	Estate Engine CKMA Inner Diameter [32mm]		◦	GHA232018	K
1.6 TDi (77 kW)	2010.08-	Estate Engine CAYC 4 hole	•		GHA336007	K
	2010.08-	Estate Engine CAYC Inner Diameter [32mm]		◦	GHA232018	K
1.8 TSi (112 kW)	2011.02-	Estate Engine CDAB 4 hole	•		GHA336007	K
	2011.02-	Estate Engine CDAB Inner Diameter [32mm]		◦	GHA232018	K
1.8 TSi (118 kW)	2010.08-	Estate Engine CDAA 4 hole	•		GHA336007	K
	2010.08-	Estate Engine CDAA Inner Diameter [32mm]		◦	GHA232018	K
2.0 TDi (100 kW)	2010.08-	Estate Engine CFFA 4 hole	•		GHA336007	K
	2010.08-	Estate Engine CFFA Inner Diameter [32mm]		◦	GHA232018	K
2.0 TDi (103 kW)	2010.08-	Estate Engine CFFB 4 hole	•		GHA336007	K
	2010.08-	Estate Engine CFFB Inner Diameter [32mm]		◦	GHA232018	K
2.0 TDi (125 kW)	2010.08-	Estate Engine CFGB/CLLA 4 hole	•		GHA336007	K
	2010.08-	Estate Engine CFGB/CLLA Inner Diameter [32mm]		◦	GHA232018	K
2.0 TDi (130 kW)	2012.12-	Hatchback Engine CFGC 4 hole	•		GHA336007	K
	2012.12-	Hatchback Engine CFGC Inner Diameter [32mm]		◦	GHA232018	K
2.0 TDi 4motion (103 kW)	2010.08-	Estate Engine CFFB 4 hole	•		GHA336007	K
2.0 TDi 4motion (125 kW)	2010.08-	Estate Engine CLLA/CFGB 4 hole	•		GHA336007	K
2.0 TDi 4motion (130 kW)	2013.01-	Estate Engine CFGC 4 hole	•		GHA336007	K
2.0 TSi (155 kW)	2010.11-	Estate Engine CCZB 4 hole	•		GHA336007	K
	2010.11-	Estate Engine CCZB Inner Diameter [32mm]		◦	GHA232018	K
3.6 FSi 4motion (220 kW)	2011.01-	Estate Engine BWS 4 hole	•		GHA336007	K
PASSAT VARIANT (3A5, 35I)						
1.6 (74 kW)	1994.07-1995.12	Estate Engine AEK/AFT	•		GHA422036	K
	1994.07-1995.12	Estate Engine AEK/AFT	•		GWB1358	
	1994.07-1995.12	Estate Engine AEK/AFT		◦	GHA499014	
	1994.07-1995.12	Estate Engine AEK/AFT		◦	GHA499015	
	1994.07-1995.12	Estate Engine AEK/AFT		◦	GHA499044	
	1994.07-1995.12	Estate Engine AEK/AFT		◦	GHA499045	
	1994.07-1995.12	Estate Engine AEK/AFT		◦	GHA499046	
	1994.07-1995.12	Estate Engine AEK/AFT		◦	GWB0529	
1.8 (102 kW)	1991.08-1993.09	Estate Engine KR	•		GHA422009	K
	1991.08-1993.09	Estate Engine KR	•		GHA422036	K
	1991.08-1993.09	Estate Engine KR	•		GWB1358	
	1991.08-1993.09	Estate Engine KR		◦	GHA499046	
	1991.08-1993.09	Estate Engine KR		◦	GWB0529	
1.8 (55 kW)	1990.08-1997.05	Estate Engine AAM	•		GHA422009	K



	 YEAR		F	R	G-AP Ref.	KIT
VOLKSWAGEN						
PASSAT VARIANT (3A5, 35I)						
1.8 (55 kW)	1990.08-1997.05	Estate Engine AAM	•		GHA422036	K
	1990.08-1997.05	Estate Engine AAM	•		GWB1358	
	1990.08-1997.05	Estate Engine AAM		○	GHA499044	
	1990.08-1997.05	Estate Engine AAM		○	GHA499045	
	1990.08-1997.05	Estate Engine AAM		○	GHA499046	
	1990.08-1997.05	Estate Engine AAM		○	GWB0529	
1.9 TD (55 kW)	1991.03-1997.05	Estate Engine AAZ	•		GHA422009	K
	1991.03-1997.05	Estate Engine AAZ	•		GHA422036	K
	1991.03-1997.05	Estate Engine AAZ	•		GWB1358	
	1991.03-1997.05	Estate Engine AAZ		○	GHA499014	
	1991.03-1997.05	Estate Engine AAZ		○	GHA499015	
	1991.03-1997.05	Estate Engine AAZ		○	GHA499044	
	1991.03-1997.05	Estate Engine AAZ		○	GHA499045	
	1991.03-1997.05	Estate Engine AAZ		○	GHA499046	
1.9 TDi (66 kW)	1993.10-1997.05	Estate Engine 1Z/AHU	•		GHA422036	K
	1993.10-1997.05	Estate Engine 1Z/AHU	•		GWB1358	
	1993.10-1997.05	Estate Engine 1Z/AHU		○	GHA499014	
	1993.10-1997.05	Estate Engine 1Z/AHU		○	GHA499015	
	1993.10-1997.05	Estate Engine 1Z/AHU		○	GHA499044	
	1993.10-1997.05	Estate Engine 1Z/AHU		○	GHA499045	
	1993.10-1997.05	Estate Engine 1Z/AHU		○	GHA499046	
	1993.10-1997.05	Estate Engine 1Z/AHU		○	GWB0529	
1.9 TDi (81 kW)	1996.03-1997.05	Estate Engine AFN	•		GHA436001	
	1996.03-1997.05	Estate Engine AFN	•		GWB1491	
	1996.03-1997.05	Estate Engine AFN		○	GHA499014	
	1996.03-1997.05	Estate Engine AFN		○	GHA499015	
	1996.03-1997.05	Estate Engine AFN		○	GHA499045	
	1996.03-1997.05	Estate Engine AFN		○	GHA499046	
	1996.03-1997.05	Estate Engine AFN		○	GWB0529	
2.0 (79 kW)	1995.03-1996.08	Estate Engine AEP	•		GHA422036	K
	1995.03-1996.08	Estate Engine AEP	•		GWB1358	
	1995.03-1996.08	Estate Engine AEP		○	GHA499014	
	1995.03-1996.08	Estate Engine AEP		○	GHA499015	
	1995.03-1996.08	Estate Engine AEP		○	GHA499045	
	1995.03-1996.08	Estate Engine AEP		○	GHA499046	
	1995.03-1996.08	Estate Engine AEP		○	GWB0529	
2.0 (85 kW)	1990.02-1997.05	Estate Engine 2E/ADY/AGG	•		GHA422009	K
	1990.02-1997.05	Estate Engine 2E/ADY/AGG	•		GHA422036	K
	1990.02-1997.05	Estate Engine 2E/ADY/AGG	•		GWB1358	
	1990.02-1997.05	Estate Engine 2E/ADY/AGG		○	GHA499014	
	1990.02-1997.05	Estate Engine 2E/ADY/AGG		○	GHA499015	
	1990.02-1997.05	Estate Engine 2E/ADY/AGG		○	GHA499045	
	1990.02-1997.05	Estate Engine 2E/ADY/AGG		○	GHA499046	
	1990.02-1997.05	Estate Engine 2E/ADY/AGG		○	GWB0529	
	1993.10-1996.10	Estate Engine 2E/ADY/AGG	•		GWB1358	
	1993.10-1996.10	Estate Engine 2E/ADY/AGG		○	GWB0529	
2.0 16V (110 kW)	1994.01-1997.05	Estate Engine ABF	•		GHA436001	
	1994.01-1997.05	Estate Engine ABF	•		GWB1491	
	1994.01-1997.05	Estate Engine ABF		○	GHA499014	
	1994.01-1997.05	Estate Engine ABF		○	GHA499015	
	1994.01-1997.05	Estate Engine ABF		○	GHA499045	
	1994.01-1997.05	Estate Engine ABF		○	GHA499046	
	1994.01-1997.05	Estate Engine ABF		○	GWB0529	
2.0 Syncro (85 kW)	1990.10-1997.05	Estate Engine 2E/ADY/AGG	•		GHA422009	K
	1990.10-1997.05	Estate Engine 2E/ADY/AGG	•		GHA422036	K
	1990.10-1997.05	Estate Engine 2E/ADY/AGG	•		GWB1358	
	1990.10-1997.05	Estate Engine 2E/ADY/AGG		○	GHA422008	A
	1990.10-1997.05	Estate Engine 2E/ADY/AGG		○	GWB0575	
2.8 VR6 (128 kW)	1991.06-1997.05	Estate Engine AAA	•		GHA422036	K
	1991.06-1997.05	Estate Engine AAA	•		GHA436001	
	1991.06-1997.05	Estate Engine AAA	•		GWB1358	
	1991.06-1997.05	Estate Engine AAA	•		GWB1491	
	1991.06-1997.05	Estate Engine AAA		○	GHA499014	



	 YEAR		F	R	G-AP Ref.	KIT
VOLKSWAGEN						
PASSAT VARIANT (3A5, 35I)						
2.8 VR6 (128 kW)	1991.06-1997.05	Estate Engine AAA		o	GHA499015	
	1991.06-1997.05	Estate Engine AAA		o	GHA499045	
	1991.06-1997.05	Estate Engine AAA		o	GHA499046	
	1991.06-1997.05	Estate Engine AAA		o	GWB0529	
2.9 VR6 Syncro (135 kW)	1994.01-1997.05	Estate Engine ABV	•		GHA436001	
	1994.01-1997.05	Estate Engine ABV	•		GWB1491	
	1994.01-1997.05	Estate Engine ABV		o	GWB1358	
PASSAT VARIANT (3B5)						
1.6 (74 kW)	1997.06-2000.11	Estate Engine ADP/AHL/ANA/ARM	•		GHA433002	
	1997.06-2000.11	Estate Engine ADP/AHL/ANA/ARM	•		GWB1355	
	1997.06-2000.11	Estate Engine ADP/AHL/ANA/ARM		o	GHA400003	
1.8 (112 kW)	2000.01-2001.12	Estate Engine AEB	•		GWB1355	
	2000.01-2001.12	Estate Engine AEB		o	GHA400003	
1.8 (85 kW)	1997.06-2000.11	Estate Engine AFY	•		GHA433002	
	1997.06-2000.11	Estate Engine AFY	•		GWB1355	
	1997.06-2000.11	Estate Engine AFY		o	GHA400003	
1.8 (92 kW)	1997.06-2000.11	Estate Engine ADR/APT/ARG	•		GHA433002	
	1997.06-2000.11	Estate Engine ADR/APT/ARG	•		GWB1355	
	1997.06-2000.11	Estate Engine ADR/APT/ARG		o	GHA400003	
1.8 Syncro/4motion (92 kW)	1997.06-2000.11	Estate Engine ADR/APT/ARG	•		GWB1355	
	1997.06-2000.11	Estate Engine ADR/APT/ARG		o	GHA433002	
1.8 T (110 kW)	1997.06-2000.11	Estate Engine AEB/ANB/APU	•		GHA433002	
	1997.06-2000.11	Estate Engine AEB/ANB/APU	•		GWB1355	
	1997.06-2000.11	Estate Engine AEB/ANB/APU		o	GHA400003	
1.9 TDi (66 kW)	1997.06-2000.11	Estate Engine AHH/AHU	•		GHA433002	
	1997.06-2000.11	Estate Engine AHH/AHU	•		GWB1355	
	1997.06-2000.11	Estate Engine AHH/AHU		o	GHA400003	
1.9 TDi (74 kW)	2000.02-2000.11	Estate Engine AVB	•		GHA433002	
	2000.02-2000.11	Estate Engine AVB	•		GWB1355	
	2000.02-2000.11	Estate Engine AVB	•		GWB1356	
	2000.02-2000.11	Estate Engine AVB		o	GHA400003	
1.9 TDi (81 kW)	1997.06-2000.11	Estate Engine AFN/AVG	•		GHA433002	
	1997.06-2000.11	Estate Engine AFN/AVG	•		GWB1356	
	1997.06-2000.11	Estate Engine AFN/AVG		o	GHA400003	
1.9 TDi (85 kW)	1998.08-2000.11	Estate Engine AJM/ATJ	•		GHA433002	
	1998.08-2000.11	Estate Engine AJM/ATJ	•		GWB1355	
	1998.08-2000.11	Estate Engine AJM/ATJ	•		GWB1356	
	1998.08-2000.11	Estate Engine AJM/ATJ		o	GHA400003	
1.9 TDi 4motion (85 kW)	1999.08-2000.11	Estate Engine ATJ	•		GWB1356	
	1999.08-2000.11	Estate Engine ATJ		o	GHA433002	
	1999.08-2000.11	Estate Engine ATJ		o	GWB1355	
1.9 TDi Syncro/4motion (81 kW)	1997.06-2000.11	Estate Engine AFN/AVG	•		GWB1355	
	1997.06-2000.11	Estate Engine AFN/AVG		o	GHA433002	
2.0 (88 kW)	2000.04-2000.11	Estate Engine ASU/AUZ	•		GWB1355	
	2000.04-2000.11	Estate Engine ASU/AUZ		o	GHA400003	
2.0 4motion (88 kW)	2000.04-2000.11	Estate Engine ASU/AUZ		o	GHA433002	
2.3 VR5 (110 kW)	1997.06-2000.11	Estate Engine AGZ	•		GHA433002	
	1997.06-2000.11	Estate Engine AGZ	•		GWB1355	
	1997.06-2000.11	Estate Engine AGZ	•		GWB1356	
	1997.06-2000.11	Estate Engine AGZ		o	GHA400003	
2.3 VR5 Syncro/4motion (110 kW)	1997.10-2000.11	Estate Engine AGZ	•		GWB1355	
	1997.10-2000.11	Estate Engine AGZ		o	GHA433002	
2.5 TDi (110 kW)	1998.07-2000.11	Estate Engine AFB/AKN	•		GHA433002	
	1998.07-2000.11	Estate Engine AFB/AKN	•		GWB1356	
	1998.07-2000.11	Estate Engine AFB/AKN		o	GHA400003	
2.5 TDi Syncro/4motion (110 kW)	1998.12-2000.11	Estate Engine AFB/AKN	•		GWB1356	
	1998.12-2000.11	Estate Engine AFB/AKN		o	GHA433002	
	1998.12-2000.11	Estate Engine AFB/AKN		o	GWB1355	
2.8 V6 (132 kW)	1997.09-1999.09	Estate Engine AGE	•		GWB1356	
	1997.09-1999.09	Estate Engine AGE		o	GHA400003	
2.8 V6 (140 kW)	1999.09-2000.11	Estate Engine ATX/BBG	•		GWB1356	
	1999.09-2000.11	Estate Engine ATX/BBG		o	GHA400003	
2.8 V6 (142 kW)	1997.06-2000.11	Estate Engine AHA/APR/ACK	•		GWB1356	
	1997.06-2000.11	Estate Engine AHA/APR/ACK		o	GHA400003	



	 YEAR		F	R	G-AP Ref.	KIT
VOLKSWAGEN						
PASSAT VARIANT (3B5)						
2.8 V6 Syncro/4motion (142 kW)	1997.06-2000.11	Estate Engine ACK/AHA/ALG/APR/AQD	•		GWB1356	
	1997.06-2000.11	Estate Engine ACK/AHA/ALG/APR/AQD		○	GHA433002	
	1997.06-2000.11	Estate Engine ACK/AHA/ALG/APR/AQD		○	GWB1355	
PASSAT VARIANT (3B6)						
1.6 (75 kW)	2000.11-2005.05	Estate Engine ALZ	•		GHA433002	
	2000.11-2005.05	Estate Engine ALZ	•		GWB1355	
	2000.11-2005.05	Estate Engine ALZ		○	GHA400003	
1.8 4motion (125 kW)	2001.03-2005.05	Estate Engine AWM	•		GWB1356	
	2001.03-2005.05	Estate Engine AWM		○	GWB1355	
1.8 T (125 kW)	2002.05-2005.08	Estate Engine AWM	•		GWB1356	
	2002.05-2005.08	Estate Engine AWM		○	GHA400003	
1.8 T 20V (110 kW)	2000.11-2005.05	Estate Engine AWT	•		GHA433002	
	2000.11-2005.05	Estate Engine AWT	•		GWB1355	
	2000.11-2005.05	Estate Engine AWT	•		GWB1356	
	2000.11-2005.05	Estate Engine AWT		○	GHA400003	
1.9 TDi (74 kW)	2000.11-2005.05	Estate Engine AVB	•		GHA433002	
	2000.11-2005.05	Estate Engine AVB	•		GWB1355	
	2000.11-2005.05	Estate Engine AVB	•		GWB1356	
	2000.11-2005.05	Estate Engine AVB		○	GHA400003	
1.9 TDi (96 kW)	2000.11-2005.05	Estate Engine AVF/AWX	•		GWB1356	
	2000.11-2005.05	Estate Engine AVF/AWX		○	GHA400003	
1.9 TDi 4motion (96 kW)	2000.11-2005.05	Estate Engine AVF	•		GWB1356	
	2000.11-2005.05	Estate Engine AVF		○	GHA433002	
	2000.11-2005.05	Estate Engine AVF		○	GWB1355	
2.0 (85 kW)	2000.11-2005.05	Estate Engine AZM	•		GHA433002	
	2000.11-2005.05	Estate Engine AZM	•		GWB1355	
	2000.11-2005.05	Estate Engine AZM		○	GHA400003	
2.0 (96 kW)	2001.11-2005.05	Estate Engine ALT	•		GHA433002	
	2001.11-2005.05	Estate Engine ALT	•		GWB1355	
	2001.11-2005.05	Estate Engine ALT		○	GHA400003	
2.0 4motion (85 kW)	2000.11-2005.05	Estate Engine AZM	•		GWB1355	
	2000.11-2005.05	Estate Engine AZM		○	GHA433002	
2.0 TDi (100 kW)	2003.12-2005.05	Estate Engine BGW	•		GWB1356	
	2003.12-2005.05	Estate Engine BGW		○	GHA400003	
2.3 VR5 (125 kW)	2000.11-2005.05	Estate Engine AZX	•		GHA433002	
	2000.11-2005.05	Estate Engine AZX	•		GWB1356	
	2000.11-2005.05	Estate Engine AZX		○	GHA400003	
2.3 VR5 4motion (125 kW)	2000.11-2005.05	Estate Engine AZX	•		GWB1356	
	2000.11-2005.05	Estate Engine AZX		○	GHA433002	
	2000.11-2005.05	Estate Engine AZX		○	GWB1355	
2.5 TDi (110 kW)	2000.11-2005.05	Estate Engine AFB/AKN	•		GWB1356	
	2000.11-2005.05	Estate Engine AFB/AKN		○	GHA400003	
2.5 TDi (120 kW)	2003.05-2005.05	Estate Engine BDG	•		GWB1356	
	2003.05-2005.05	Estate Engine BDG		○	GHA400003	
2.5 TDi 4motion (110 kW)	2000.11-2005.05	Estate Engine AFB/AKN	•		GWB1356	
	2000.11-2005.05	Estate Engine AFB/AKN		○	GHA433002	
	2000.11-2005.05	Estate Engine AFB/AKN		○	GWB1355	
2.5 TDi 4motion (132 kW)	2003.01-2005.05	Estate Engine BAU/BDH	•		GWB1356	
	2003.01-2005.05	Estate Engine BAU/BDH		○	GHA433002	
	2003.01-2005.05	Estate Engine BAU/BDH		○	GWB1355	
2.8 4motion (142 kW)	2000.11-2005.05	Estate Engine AMX/ATQ	•		GWB1356	
	2000.11-2005.05	Estate Engine AMX/ATQ		○	GHA433002	
	2000.11-2005.05	Estate Engine AMX/ATQ		○	GWB1355	
4.0 W8 4motion (202 kW)	2001.09-2004.09	Estate Engine BDN/BDP	•		GHA245010	K
	2001.09-2004.09	Estate Engine BDN/BDP	•		GWB1356	
	2001.09-2004.09	Estate Engine BDN/BDP		○	GHA433002	
PASSAT VARIANT (3C5)						
1.4 TSi (90 kW)	2007.05-2010.11	Estate Engine CAXA 4 hole	•		GHA336007	K
	2007.05-2010.11	Estate Engine CAXA Inner Diameter [32mm]		○	GHA232018	K
1.4 TSi EcoFuel (110 kW)	2009.01-2010.11	Estate Engine CDGA 4 hole	•		GHA336007	K
	2009.01-2010.11	Estate Engine CDGA Inner Diameter [32mm]		○	GHA232018	K
1.6 (75 kW)	2005.08-2010.11	Estate Engine BSE/BSF 4 hole	•		GHA336007	K
	2005.08-2010.11	Estate Engine BSE/BSF Inner Diameter [32mm]		○	GHA232018	K
1.6 FSi (85 kW)	2005.08-2008.06	Estate Engine BLF 4 hole	•		GHA336007	K



	 YEAR		F	R	G-AP Ref.	KIT
VOLKSWAGEN						
PASSAT VARIANT (3C5)						
1.6 FSi (85 kW)	2005.08-2008.06	Estate Engine BLF Inner Diameter [32mm]		o	GHA232018	K
1.6 TDi (77 kW)	2009.08-2010.11	Estate Engine CAYC 4 hole	•		GHA336007	K
	2009.08-2010.11	Estate Engine CAYC Inner Diameter [32mm]		o	GHA232018	K
1.8 TSi (112 kW)	2009.11-2010.11	Estate Engine CGYA/CDAB 4 hole	•		GHA336007	K
	2009.11-2010.11	Estate Engine CGYA/CDAB Inner Diameter [32mm]		o	GHA232018	K
1.8 TSi (118 kW)	2007.05-2011.10	Estate Engine BZB/CDAA 4 hole	•		GHA336007	K
	2007.05-2011.10	Estate Engine BZB/CDAA Inner Diameter [32mm]		o	GHA232018	K
1.9 TDi (77 kW)	2005.08-2008.11	Estate Engine BKC/BLS/BXE 4 hole	•		GHA336007	K
	2005.08-2008.11	Estate Engine BKC/BLS/BXE Inner Diameter [32mm]		o	GHA232018	K
2.0 BlueTDi (105 kW)	2009.01-	Estate Engine CBAC 4 hole	•		GHA336007	K
	2009.01-	Estate Engine CBAC Inner Diameter [32mm]		o	GHA232018	K
2.0 FSi (110 kW)	2005.08-2010.11	Estate Engine BLR/BLY/BVY/BVZ 4 hole	•		GHA336007	K
	2005.08-2010.11	Estate Engine BLR/BLY/BVY/BVZ Inner Diameter [32mm]		o	GHA232018	K
2.0 FSi (125 kW)	2007.08-2010.11	Estate Engine CCTB 4 hole	•		GHA336007	K
	2007.08-2010.11	Estate Engine CCTB Inner Diameter [32mm]		o	GHA232018	K
2.0 FSi (147 kW)	2005.08-2010.11	Estate Engine AXX/BPY/BWA/CAWB/CBFA/CCTA/CCZA 4 hole	•		GHA336007	K
	2005.08-2010.11	Estate Engine AXX/BPY/BWA/CAWB/CBFA/CCTA/CCZA Inner Diameter [32mm]		o	GHA232018	K
2.0 FSi 4motion (110 kW)	2005.09-2010.11	Estate Engine BLX/BLY/BVX 4 hole	•		GHA336007	K
2.0 TDi (100 kW)	2005.08-2010.11	Estate Engine BMA/CBAA 4 hole	•		GHA336007	K
	2005.08-2010.11	Estate Engine BMA/CBAA Inner Diameter [32mm]		o	GHA232018	K
2.0 TDi (103 kW)	2005.08-	Estate Engine BMP 4 hole	•		GHA336007	K
	2005.08-	Estate Engine BMP Inner Diameter [32mm]		o	GHA232018	K
2.0 TDi (120 kW)	2005.08-	Estate Engine BUZ 4 hole	•		GHA336007	K
	2005.08-	Estate Engine BUZ Inner Diameter [32mm]		o	GHA232018	K
2.0 TDi (125 kW)	2005.08-	Estate Engine BMR/CBBB 4 hole	•		GHA336007	K
	2005.08-	Estate Engine BMR/CBBB Inner Diameter [32mm]		o	GHA232018	K
2.0 TDi (81 kW)	2008.11-2010.11	Estate Engine CBDC 4 hole	•		GHA336007	K
	2008.11-2010.11	Estate Engine CBDC Inner Diameter [32mm]		o	GHA232018	K
2.0 TDi (88 kW)	2005.11-2007.05	Estate Engine BWV 4 hole	•		GHA336007	K
	2005.11-2007.05	Estate Engine BWV Inner Diameter [32mm]		o	GHA232018	K
2.0 TDi (90 kW)	2005.08-2006.02	Estate Engine BVE 4 hole	•		GHA336007	K
	2005.08-2006.02	Estate Engine BVE Inner Diameter [32mm]		o	GHA232018	K
2.0 TDi 16V (103 kW)	2005.08-	Estate Engine BKP/CBAB 4 hole	•		GHA336007	K
	2005.08-	Estate Engine BKP/CBAB Inner Diameter [32mm]		o	GHA232018	K
2.0 TDi 16V 4motion (103 kW)	2005.08-	Estate Engine BKP/CBAB 4 hole	•		GHA336007	K
2.0 TDi 4motion (103 kW)	2005.08-	Estate Engine BMP 4 hole	•		GHA336007	K
2.0 TDi 4motion (125 kW)	2009.05-	Estate Engine CBBB 4 hole	•		GHA336007	K
3.2 FSi 4motion (184 kW)	2005.11-2007.11	Estate Engine AXZ 4 hole	•		GHA336007	K
3.6 R36 4motion (220 kW)	2007.04-2010.11	Estate Engine BWS 4 hole	•		GHA336007	K
PASSAT VARIANT (3G5)						
1.4 TSi (110 kW)	2014.11-	Estate Engine CZEA Inner Diameter [32mm]		o	GHA232018	K
1.4 TSi (92 kW)	2014.11-	Estate Engine CZCA Inner Diameter [32mm]		o	GHA232018	K
1.6 TDi (88 kW)	2014.08-	Estate Engine DCXA Inner Diameter [32mm]		o	GHA232018	K
1.8 TSi (132 kW)	2015.02-	Estate Engine CJSJ/CJSC Inner Diameter [32mm]		o	GHA232018	K
2.0 TDi (110 kW)	2014.11-	Estate Engine CRLB Inner Diameter [32mm]		o	GHA232018	K
2.0 TDi (140 kW)	2014.11-	Estate Engine DDAA Inner Diameter [32mm]		o	GHA232018	K
2.0 TSi (162 kW)	2015.02-	Estate Engine CHHB/CXDA Inner Diameter [32mm]		o	GHA232018	K
PHAETON (3D_)						
3.0 V6 TDi 4motion (165 kW)	2004.10-2008.04	Saloon Engine BMK	•		GHA247001	K
3.0 V6 TDi 4motion (171 kW)	2007.06-	Saloon Engine CARA	•		GHA247001	K
3.0 V6 TDi 4motion (176 kW)	2008.11-	Saloon Engine CARB/CEXA	•		GHA247001	K
3.0 V6 TDi 4motion (180 kW)	2013.11-	Saloon Engine CEXB	•		GHA247001	K
3.2 V6 (177 kW)	2002.04-	Saloon Engine AYT/BKL	•		GHA247001	K
3.2 V6 4motion (177 kW)	2004.06-2007.12	Saloon Engine BKL/BRK	•		GHA247001	K
3.6 V6 4motion (206 kW)	2008.11-	Saloon Engine CHNA/CMVA	•		GHA247001	K
4.2 V8 4motion (246 kW)	2003.12-2008.04	Saloon Engine BGH/BGJ	•		GHA247001	K
5.0 V10 TDi 4motion (230 kW)	2002.11-	Saloon Engine AJS	•		GHA247001	K
6.0 W12 4motion (309 kW)	2002.04-	Saloon Engine BAN	•		GHA247001	K
6.0 W12 4motion (331 kW)	2005.05-2008.04	Saloon Engine BRN/BTT	•		GHA247001	K
POLO						
1.6 (63 kW)	2010.11-	Saloon Engine CFNB With ABS	•		GHA336001	K
	2010.11-	Saloon Engine CFNB With ABS		o	GHA228036	K
1.6 (77 kW)	2010.05-	Saloon Engine CFNA/CLSA With ABS	•		GHA336001	K
	2010.05-	Saloon Engine CFNA/CLSA With ABS		o	GHA228036	K



	 YEAR		F	R	G-AP Ref.	KIT
VOLKSWAGEN						
POLO (6KV2)						
1,9 D (47 kW)	1996.01-1996.10	Saloon Engine 1Y	•		GHA422036	K
	1996.01-1996.10	Saloon Engine 1Y	•		GWB1358	
	1996.01-1996.10	Saloon Engine 1Y		○	GHA499046	
	1996.01-1996.10	Saloon Engine 1Y		○	GWB0529	
1.4 (44 kW)	1995.12-2001.09	Saloon Engine AEX/AKK/AKV/ANW/APQ/AUD	•		GHA422036	K
	1995.12-2001.09	Saloon Engine AEX/AKK/AKV/ANW/APQ/AUD	•		GWB1358	
	1995.12-2001.09	Saloon Engine AEX/AKK/AKV/ANW/APQ/AUD		○	GHA499046	
	1995.12-2001.09	Saloon Engine AEX/AKK/AKV/ANW/APQ/AUD		○	GWB0529	
	1995.12-2001.09	Saloon Engine AEX/AKK/AKV/ANW/APQ/AUD With ABS		○	GHA228041	K
1.4 16V (55 kW)	1999.10-2001.09	Saloon Engine APE/AUA	•		GHA422036	K
	1999.10-2001.09	Saloon Engine APE/AUA	•		GWB1358	
	1999.10-2001.09	Saloon Engine APE/AUA With ABS		○	GHA228041	K
1.6 (55 kW)	1995.11-1997.09	Saloon Engine 1F	•		GHA422036	K
	1995.11-1997.09	Saloon Engine 1F	•		GWB1358	
	1995.11-1997.09	Saloon Engine 1F		○	GHA499046	
	1995.11-1997.09	Saloon Engine 1F		○	GWB0529	
	1995.11-2001.09	Saloon Engine AEE/ALM	•		GHA422036	K
	1995.11-2001.09	Saloon Engine AEE/ALM	•		GWB1358	
	1995.11-2001.09	Saloon Engine AEE/ALM		○	GWB0529	
	1995.11-2001.09	Saloon Engine AEE/ALM With ABS		○	GHA228041	K
1.6 (74 kW)	1995.12-2001.09	Saloon Engine AEH/AFT/AKL/APF/AUR	•		GHA422036	K
	1995.12-2001.09	Saloon Engine AEH/AFT/AKL/APF/AUR	•		GWB1358	
	1995.12-2001.09	Saloon Engine AEH/AFT/AKL/APF/AUR		○	GHA499046	
	1995.12-2001.09	Saloon Engine AEH/AFT/AKL/APF/AUR		○	GWB0529	
	1995.12-2001.09	Saloon Engine AEH/AFT/AKL/APF/AUR With ABS		○	GHA228041	K
1.8 (66 kW)	1997.01-2001.09	Saloon Engine ADD	•		GHA422036	K
	1997.01-2001.09	Saloon Engine ADD	•		GWB1358	
	1997.01-2001.09	Saloon Engine ADD		○	GWB0529	
	1997.01-2001.09	Saloon Engine ADD With ABS		○	GHA228041	K
1.9 SDi (47 kW)	1995.12-1999.08	Saloon Engine AEY	•		GHA422036	K
	1995.12-1999.08	Saloon Engine AEY	•		GWB1358	
	1995.12-1999.08	Saloon Engine AEY		○	GHA499046	
	1995.12-1999.08	Saloon Engine AEY		○	GWB0529	
	1995.12-1999.08	Saloon Engine AEY With ABS		○	GHA228041	K
1.9 SDi (48 kW)	1996.06-2001.09	Saloon Engine AEY	•		GHA422036	K
	1996.06-2001.09	Saloon Engine AEY	•		GWB1358	
	1996.06-2001.09	Saloon Engine AEY		○	GHA499046	
	1996.06-2001.09	Saloon Engine AEY		○	GWB0529	
	1996.06-2001.09	Saloon Engine AEY With ABS		○	GHA228041	K
1.9 SDi (50 kW)	1999.08-2002.01	Saloon Engine AGP/AQM	•		GHA422036	K
	1999.08-2002.01	Saloon Engine AGP/AQM	•		GWB1358	
	1999.08-2002.01	Saloon Engine AGP/AQM		○	GWB0529	
	1999.08-2002.01	Saloon Engine AGP/AQM With ABS		○	GHA228041	K
1.9 TDi (66 kW)	1996.09-2001.09	Saloon Engine AGR/AHU/ALE/ALH	•		GHA422036	K
	1996.09-2001.09	Saloon Engine AGR/AHU/ALE/ALH	•		GWB1358	
	1996.09-2001.09	Saloon Engine AGR/AHU/ALE/ALH		○	GWB0529	
	1996.09-2001.09	Saloon Engine AGR/AHU/ALE/ALH With ABS		○	GHA228041	K
1.9 TDi (67 kW)	1997.01-1999.08	Saloon Engine AHU	•		GWB1358	
	1997.01-1999.08	Saloon Engine AHU		○	GWB0529	
1.9 TDi (81 kW)	1998.06-2002.01	Saloon Engine AFN/ASV	•		GHA422036	K
	1998.06-2002.01	Saloon Engine AFN/ASV	•		GWB1358	
	1998.06-2002.01	Saloon Engine AFN/ASV		○	GHA499014	
	1998.06-2002.01	Saloon Engine AFN/ASV		○	GHA499015	
	1998.06-2002.01	Saloon Engine AFN/ASV		○	GWB0529	
	1998.06-2002.01	Saloon Engine AFN/ASV With ABS		○	GHA228041	K
54 1.4 (40 kW)	1998.01-1999.08	Saloon Engine ANX	•		GHA422036	K
	1998.01-1999.08	Saloon Engine ANX	•		GWB1358	
	1998.01-1999.08	Saloon Engine ANX		○	GWB0529	
57 1.7 SDi (42 kW)	1997.07-2001.09	Saloon Engine AKW	•		GHA422036	K
	1997.07-2001.09	Saloon Engine AKW	•		GWB1358	
	1997.07-2001.09	Saloon Engine AKW		○	GWB0529	
	1997.07-2001.09	Saloon Engine AKW With ABS		○	GHA228041	K
POLO (6N1)						
1.0 (33 kW)	1994.10-1996.09	Hatchback Engine AEV	•		GHA422022	



	 YEAR		F	R	G-AP Ref.	KIT
VOLKSWAGEN						
POLO (6N1)						
1.0 (33 kW)	1994.10-1996.09	Hatchback Engine AEV	•		GWB0906	
	1994.10-1996.09	Hatchback Engine AEV		○	GHA499044	
	1994.10-1996.09	Hatchback Engine AEV		○	GHA499046	
	1994.10-1996.09	Hatchback Engine AEV		○	GWB0529	
1.0 (37 kW)	1996.09-1999.10	Hatchback Engine AER/ALL	•		GHA422022	
	1996.09-1999.10	Hatchback Engine AER/ALL	•		GWB0906	
	1996.09-1999.10	Hatchback Engine AER/ALL		○	GHA499044	
	1996.09-1999.10	Hatchback Engine AER/ALL		○	GHA499046	
	1996.09-1999.10	Hatchback Engine AER/ALL		○	GWB0529	
	1996.09-1999.10	Hatchback Engine AER/ALL With ABS		○	GHA228041	K
1.3 (40 kW)	1994.10-1995.07	Hatchback Engine ADX	•		GHA422022	
	1994.10-1995.07	Hatchback Engine ADX	•		GWB0906	
	1994.10-1995.07	Hatchback Engine ADX		○	GHA499044	
	1994.10-1995.07	Hatchback Engine ADX		○	GHA499046	
	1994.10-1995.07	Hatchback Engine ADX		○	GWB0529	
1.4 (40 kW)	1995.08-1999.10	Hatchback Engine AEX	•		GHA422022	
	1995.08-1999.10	Hatchback Engine AEX	•		GWB0906	
	1995.08-1999.10	Hatchback Engine AEX		○	GHA499044	
	1995.08-1999.10	Hatchback Engine AEX		○	GHA499046	
	1995.08-1999.10	Hatchback Engine AEX		○	GWB0529	
	1995.08-1999.10	Hatchback Engine AEX With ABS		○	GHA228041	K
1.4 (44 kW)	1995.07-1999.10	Hatchback Engine AEX/AKV/APQ	•		GHA422022	
	1995.07-1999.10	Hatchback Engine AEX/AKV/APQ	•		GWB0906	
	1995.07-1999.10	Hatchback Engine AEX/AKV/APQ		○	GHA499044	
	1995.07-1999.10	Hatchback Engine AEX/AKV/APQ		○	GHA499046	
	1995.07-1999.10	Hatchback Engine AEX/AKV/APQ		○	GWB0529	
	1995.07-1999.10	Hatchback Engine AEX/AKV/APQ With ABS		○	GHA228041	K
1.4 16V (74 kW)	1996.04-1999.10	Hatchback Engine AFH	•		GHA422022	
	1996.04-1999.10	Hatchback Engine AFH	•		GWB0906	
	1996.04-1999.10	Hatchback Engine AFH		○	GHA499014	
	1996.04-1999.10	Hatchback Engine AFH		○	GHA499015	
	1996.04-1999.10	Hatchback Engine AFH		○	GHA499044	
	1996.04-1999.10	Hatchback Engine AFH		○	GHA499046	
	1996.04-1999.10	Hatchback Engine AFH		○	GWB0529	
	1996.04-1999.10	Hatchback Engine AFH With ABS		○	GHA228041	K
1.6 (55 kW)	1994.10-1999.10	Hatchback Engine AEA/AEE	•		GHA422022	
	1994.10-1999.10	Hatchback Engine AEA/AEE	•		GWB0906	
	1994.10-1999.10	Hatchback Engine AEA/AEE		○	GHA499014	
	1994.10-1999.10	Hatchback Engine AEA/AEE		○	GHA499015	
	1994.10-1999.10	Hatchback Engine AEA/AEE		○	GHA499044	
	1994.10-1999.10	Hatchback Engine AEA/AEE		○	GHA499046	
	1994.10-1999.10	Hatchback Engine AEA/AEE		○	GWB0529	
	1994.10-1999.10	Hatchback Engine AEA/AEE With ABS		○	GHA228041	K
1.6 16V GTi (88 kW)	1998.09-1999.10	Hatchback Engine AJV	•		GHA422022	
	1998.09-1999.10	Hatchback Engine AJV	•		GWB0906	
	1998.09-1999.10	Hatchback Engine AJV		○	GHA499014	
	1998.09-1999.10	Hatchback Engine AJV		○	GHA499015	
	1998.09-1999.10	Hatchback Engine AJV		○	GHA499044	
	1998.09-1999.10	Hatchback Engine AJV		○	GHA499046	
	1998.09-1999.10	Hatchback Engine AJV		○	GWB0529	
	1998.09-1999.10	Hatchback Engine AJV With ABS		○	GHA228041	K
1.7 SDi (42 kW)	1997.04-1999.10	Hatchback Engine AHG	•		GHA422022	
	1997.04-1999.10	Hatchback Engine AHG	•		GWB0906	
	1997.04-1999.10	Hatchback Engine AHG		○	GHA499044	
	1997.04-1999.10	Hatchback Engine AHG		○	GHA499046	
	1997.04-1999.10	Hatchback Engine AHG		○	GWB0529	
	1997.04-1999.10	Hatchback Engine AHG With ABS		○	GHA228041	K
1.7 SDi (44 kW)	1997.08-1999.10	Hatchback Engine AKU	•		GHA422022	
	1997.08-1999.10	Hatchback Engine AKU	•		GWB0906	
	1997.08-1999.10	Hatchback Engine AKU		○	GHA499044	
	1997.08-1999.10	Hatchback Engine AKU		○	GHA499046	
	1997.08-1999.10	Hatchback Engine AKU		○	GWB0529	
	1997.08-1999.10	Hatchback Engine AKU With ABS		○	GHA228041	K
1.9 D (47 kW)	1994.10-1999.10	Hatchback Engine AEF	•		GHA422022	



	 YEAR		F	R	G-AP Ref.	KIT	
VOLKSWAGEN							
POLO (6N1)							
1.9 D (47 kW)	1994.10-1999.10	Hatchback Engine AEF	•		GWB0906		
	1994.10-1999.10	Hatchback Engine AEF		○	GHA499044		
	1994.10-1999.10	Hatchback Engine AEF		○	GHA499046		
	1994.10-1999.10	Hatchback Engine AEF		○	GWB0529		
	1994.10-1999.10	Hatchback Engine AEF With ABS		○	GHA228041	K	
1.9 SDi (47 kW)	1996.07-1999.10	Hatchback Engine AGD	•		GHA422022		
	1996.07-1999.10	Hatchback Engine AGD	•		GWB0906		
	1996.07-1999.10	Hatchback Engine AGD		○	GHA499044		
	1996.07-1999.10	Hatchback Engine AGD		○	GHA499046		
	1996.07-1999.10	Hatchback Engine AGD		○	GWB0529		
	1996.07-1999.10	Hatchback Engine AGD With ABS		○	GHA228041	K	
POLO (6N2)							
1.0 (37 kW)	1999.10-2001.09	Hatchback Engine ALD/AUC	•		GHA422022		
	1999.10-2001.09	Hatchback Engine ALD/AUC	•		GWB0906		
	1999.10-2001.09	Hatchback Engine ALD/AUC		○	GHA499044		
	1999.10-2001.09	Hatchback Engine ALD/AUC With ABS		○	GHA228041	K	
1.4 (40 kW)	1999.10-2001.09	Hatchback Engine AKP/ANX	•		GHA422022		
	1999.10-2001.09	Hatchback Engine AKP/ANX	•		GWB0906		
	1999.10-2001.09	Hatchback Engine AKP/ANX		○	GHA499014		
	1999.10-2001.09	Hatchback Engine AKP/ANX		○	GHA499015		
	1999.10-2001.09	Hatchback Engine AKP/ANX		○	GHA499044		
	1999.10-2001.09	Hatchback Engine AKP/ANX With ABS		○	GHA228041	K	
	1.4 (44 kW)	1999.10-2001.09	Hatchback Engine AKK/AUD	•		GHA422022	
		1999.10-2001.09	Hatchback Engine AKK/AUD	•		GWB0906	
1999.10-2001.09		Hatchback Engine AKK/AUD		○	GHA499014		
1999.10-2001.09		Hatchback Engine AKK/AUD		○	GHA499015		
1999.10-2001.09		Hatchback Engine AKK/AUD		○	GHA499044		
1999.10-2001.09		Hatchback Engine AKK/AUD With ABS		○	GHA228041	K	
1.4 16V (55 kW)	1999.10-2001.09	Hatchback Engine AHW/APE/AUA	•		GHA422022		
	1999.10-2001.09	Hatchback Engine AHW/APE/AUA	•		GWB0906		
	1999.10-2001.09	Hatchback Engine AHW/APE/AUA		○	GHA499014		
	1999.10-2001.09	Hatchback Engine AHW/APE/AUA		○	GHA499015		
	1999.10-2001.09	Hatchback Engine AHW/APE/AUA		○	GHA499044		
	1999.10-2001.09	Hatchback Engine AHW/APE/AUA With ABS		○	GHA228041	K	
1.4 16V (74 kW)	1999.10-2001.09	Hatchback Engine AFK/AQQ/AUB	•		GHA422022		
	1999.10-2001.09	Hatchback Engine AFK/AQQ/AUB	•		GWB0906		
	1999.10-2001.09	Hatchback Engine AFK/AQQ/AUB		○	GHA499014		
	1999.10-2001.09	Hatchback Engine AFK/AQQ/AUB		○	GHA499015		
	1999.10-2001.09	Hatchback Engine AFK/AQQ/AUB		○	GHA499044		
	1999.10-2001.09	Hatchback Engine AFK/AQQ/AUB With ABS		○	GHA228041	K	
	1.4 TDi (55 kW)	1999.10-2001.09	Hatchback Engine AMF	•		GHA422022	
1999.10-2001.09		Hatchback Engine AMF	•		GWB0906		
1999.10-2001.09		Hatchback Engine AMF		○	GHA499014		
1999.10-2001.09		Hatchback Engine AMF		○	GHA499015		
1999.10-2001.09		Hatchback Engine AMF		○	GHA499044		
1999.10-2001.09		Hatchback Engine AMF With ABS		○	GHA228041	K	
1.6 16V GTi (92 kW)	1999.10-2001.09	Hatchback Engine ARC/AVY	•		GHA422022		
	1999.10-2001.09	Hatchback Engine ARC/AVY	•		GWB0906		
	1999.10-2001.09	Hatchback Engine ARC/AVY		○	GHA499014		
	1999.10-2001.09	Hatchback Engine ARC/AVY		○	GHA499015		
	1999.10-2001.09	Hatchback Engine ARC/AVY		○	GHA499044		
	1999.10-2001.09	Hatchback Engine ARC/AVY With ABS		○	GHA228041	K	
1.7 SDi (44 kW)	1999.10-2001.09	Hatchback Engine AKU	•		GHA422022		
	1999.10-2001.09	Hatchback Engine AKU	•		GWB0906		
	1999.10-2001.09	Hatchback Engine AKU		○	GHA499014		
	1999.10-2001.09	Hatchback Engine AKU		○	GHA499015		
	1999.10-2001.09	Hatchback Engine AKU		○	GHA499044		
	1999.10-2001.09	Hatchback Engine AKU With ABS		○	GHA228041	K	
1.9 D (47 kW)	1999.10-2001.09	Hatchback Engine AEF	•		GHA422022		
	1999.10-2001.09	Hatchback Engine AEF	•		GWB0906		
	1999.10-2001.09	Hatchback Engine AEF		○	GHA499014		
	1999.10-2001.09	Hatchback Engine AEF		○	GHA499015		
	1999.10-2001.09	Hatchback Engine AEF		○	GHA499044		
	1999.10-2001.09	Hatchback Engine AEF With ABS		○	GHA228041	K	



	 YEAR		F	R	G-AP Ref.	KIT
VOLKSWAGEN						
POLO (6N2)						
1.9 SDi (47 kW)	1999.10-2001.09	Hatchback Engine AGD/ASX	•		GHA422022	
	1999.10-2001.09	Hatchback Engine AGD/ASX	•		GWB0906	
	1999.10-2001.09	Hatchback Engine AGD/ASX		○	GHA499014	
	1999.10-2001.09	Hatchback Engine AGD/ASX		○	GHA499015	
	1999.10-2001.09	Hatchback Engine AGD/ASX		○	GHA499044	
	1999.10-2001.09	Hatchback Engine AGD/ASX With ABS		○	GHA228041	K
POLO (6NF)						
1.7 SDi (44 kW)	1997.08-1999.12	Box Engine AKU		○	GHA499046	
POLO (6R, 6C)						
1.0 (44 kW)	2014.01-	Hatchback Engine CHYA With ABS	•		GHA336001	K
	2014.01-	Hatchback Engine CHYA With ABS		○	GHA228036	K
1.0 (55 kW)	2014.01-	Hatchback Engine CHYB With ABS	•		GHA336001	K
	2014.01-	Hatchback Engine CHYB With ABS		○	GHA228036	K
1.2 (44 kW)	2009.06-	Hatchback Engine CGPB With ABS	•		GHA336001	K
	2009.06-	Hatchback Engine CGPB With ABS		○	GHA228036	K
	2009.06-	Hatchback Engine CGPB Without ABS	•		GHA336002	
	2009.06-	Hatchback Engine CGPB Without ABS		○	GHA228037	
1.2 (51 kW)	2009.06-	Hatchback Engine CGPA With ABS	•		GHA336001	K
	2009.06-	Hatchback Engine CGPA With ABS		○	GHA228036	K
	2009.06-	Hatchback Engine CGPA Without ABS	•		GHA336002	
	2009.06-	Hatchback Engine CGPA Without ABS		○	GHA228037	
1.2 TDi (55 kW)	2009.10-	Hatchback Engine CFWA With ABS	•		GHA336001	K
	2009.10-	Hatchback Engine CFWA With ABS		○	GHA228036	K
	2009.10-	Hatchback Engine CFWA Without ABS	•		GHA336002	
	2009.10-	Hatchback Engine CFWA Without ABS		○	GHA228037	
1.2 TSi (66 kW)	2011.05-	Hatchback Engine CBZC With ABS	•		GHA336001	K
	2011.05-	Hatchback Engine CBZC With ABS		○	GHA228036	K
	2011.05-	Hatchback Engine CBZC Without ABS	•		GHA336002	
1.2 TSi (77 kW)	2009.11-	Hatchback Engine CBZB With ABS	•		GHA336001	K
	2009.11-	Hatchback Engine CBZB With ABS		○	GHA228036	K
	2009.11-	Hatchback Engine CBZB Without ABS	•		GHA336002	
	2009.11-	Hatchback Engine CBZB Without ABS		○	GHA228037	
1.2 TSi (81 kW)	2014.01-	Hatchback Engine CJZD With ABS	•		GHA336001	K
	2014.01-	Hatchback Engine CJZD With ABS		○	GHA228036	K
1.2 TSi 16V (66 kW)	2014.02-	Hatchback Engine CJZC With ABS	•		GHA336001	K
	2014.02-	Hatchback Engine CJZC With ABS		○	GHA228036	K
1.4 (63 kW)	2009.06-	Hatchback Engine CGGB With ABS	•		GHA336001	K
	2009.06-	Hatchback Engine CGGB With ABS		○	GHA228036	K
	2009.06-	Hatchback Engine CGGB Without ABS	•		GHA336002	
	2009.06-	Hatchback Engine CGGB Without ABS		○	GHA228037	
1.4 BiFuel (60 kW)	2010.03-2011.01	Hatchback Engine CMAA With ABS	•		GHA336001	K
	2010.03-2011.01	Hatchback Engine CMAA With ABS		○	GHA228036	K
	2010.03-2011.01	Hatchback Engine CMAA Without ABS	•		GHA336002	
1.4 GTi (132 kW)	2010.05-	Hatchback Engine CTHE/CAVE With ABS	•		GHA336001	K
	2010.05-	Hatchback Engine CTHE/CAVE With ABS		○	GHA228036	K
1.4 TDi (55 kW)	2014.03-	Hatchback Engine CUSA With ABS	•		GHA336001	K
	2014.03-	Hatchback Engine CUSA With ABS		○	GHA228036	K
1.4 TDi (66 kW)	2014.02-	Hatchback Engine CUSB With ABS	•		GHA336001	K
	2014.02-	Hatchback Engine CUSB With ABS		○	GHA228036	K
1.4 TDi (77 kW)	2014.05-	Hatchback Engine CUTA/CYZA With ABS	•		GHA336001	K
	2014.05-	Hatchback Engine CUTA/CYZA With ABS		○	GHA228036	K
1.4 TSi (103 kW)	2012.10-	Hatchback Engine CPTA With ABS	•		GHA336001	K
	2012.10-	Hatchback Engine CPTA With ABS		○	GHA228036	K
1.4 TSi (110 kW)	2014.05-	Hatchback Engine CZEA With ABS	•		GHA336001	K
	2014.05-	Hatchback Engine CZEA With ABS		○	GHA228036	K
1.6 (81 kW)	2014.07-	Hatchback Engine CWVA With ABS	•		GHA336001	K
	2014.07-	Hatchback Engine CWVA With ABS		○	GHA228036	K
1.6 BiFuel (60 kW)	2011.01-	Hatchback Engine CNKA With ABS	•		GHA336001	K
	2011.01-	Hatchback Engine CNKA With ABS		○	GHA228036	K
	2011.01-	Hatchback Engine CNKA Without ABS	•		GHA336002	
1.6 TDi (55 kW)	2009.06-	Hatchback Engine CAYA With ABS	•		GHA336001	K
	2009.06-	Hatchback Engine CAYA With ABS		○	GHA228036	K
	2009.06-	Hatchback Engine CAYA Without ABS	•		GHA336002	
	2009.06-	Hatchback Engine CAYA Without ABS		○	GHA228037	



	 YEAR		F	R	G-AP Ref.	KIT
VOLKSWAGEN						
POLO (6R, 6C)						
1.6 TDi (66 kW)	2009.06-	Hatchback Engine CAYB With ABS	•		GHA336001	K
	2009.06-	Hatchback Engine CAYB With ABS		◦	GHA228036	K
	2009.06-	Hatchback Engine CAYB Without ABS	•		GHA336002	
	2009.06-	Hatchback Engine CAYB Without ABS		◦	GHA228037	
1.6 TDi (77 kW)	2009.06-	Hatchback Engine CLNA/CAYC With ABS	•		GHA336001	K
	2009.06-	Hatchback Engine CLNA/CAYC With ABS		◦	GHA228036	K
	2009.06-	Hatchback Engine CLNA/CAYC Without ABS	•		GHA336002	
	2009.06-	Hatchback Engine CLNA/CAYC Without ABS		◦	GHA228037	
2.0 R WRC (162 kW)	2013.08-	Hatchback Engine CDLJ With ABS	•		GHA336001	K
	2013.08-	Hatchback Engine CDLJ With ABS		◦	GHA228036	K
POLO (86C, 80)						
1.3 (56 kW)	1990.10-1994.08	Hatchback Engine 3F	•		GWB0577	
	1990.10-1994.08	Hatchback Engine 3F	•		GWB0906	
	1990.10-1994.08	Hatchback Engine 3F		◦	GWB0529	
1.3 (57 kW)	1991.03-1994.09	Coupe Engine 3F	•		GWB0577	
	1991.03-1994.09	Coupe Engine 3F		◦	GWB0529	
1.3 G40 (83 kW)	1990.08-1994.09	Coupe Engine PY	•		GWB0577	
	1990.08-1994.09	Coupe Engine PY		◦	GWB0529	
1.4 D (35 kW)	1990.08-1994.09	Coupe Engine 1W	•		GWB0577	
	1990.08-1994.09	Coupe Engine 1W		◦	GHA499044	
	1990.08-1994.09	Coupe Engine 1W		◦	GWB0529	
	1990.10-1994.09	Hatchback Engine 1W	•		GWB0577	
	1990.10-1994.09	Hatchback Engine 1W	•		GWB0906	
	1990.10-1994.09	Hatchback Engine 1W		◦	GHA499044	
	1990.10-1994.09	Hatchback Engine 1W		◦	GWB0529	
	1990.10-1994.09	Saloon Engine 1W	•		GWB0577	
	1990.10-1994.09	Saloon Engine 1W		◦	GWB0529	
POLO (86CF)						
1.0 (33 kW)	1992.08-1994.07	Box Engine AAU		◦	GHA499044	
1.3 (40 kW)	1992.08-1994.07	Box Engine AAV		◦	GHA499044	
1.4 D (35 kW)	1992.08-1994.07	Box Engine 1W		◦	GHA499044	
POLO (9A4)						
1.4 (55 kW)	2003.07-	Saloon Engine BBY/BKY	•		GHA422026	
	2003.07-	Saloon Engine BBY/BKY With ABS	•		GHA336001	K
	2003.07-	Saloon Engine BBY/BKY With ABS		◦	GHA228036	K
	2003.07-	Saloon Engine BBY/BKY Without ABS	•		GHA336002	
	2003.07-	Saloon Engine BBY/BKY Without ABS		◦	GHA228037	
1.4 (74 kW)	2003.11-	Saloon Engine BBZ With ABS	•		GHA336001	K
	2003.11-	Saloon Engine BBZ With ABS		◦	GHA228036	K
	2003.11-	Saloon Engine BBZ Without ABS	•		GHA336002	
	2003.11-	Saloon Engine BBZ Without ABS		◦	GHA228037	
1.4 TDi (55 kW)	2003.07-	Saloon Engine BAY With ABS	•		GHA336001	K
	2003.07-	Saloon Engine BAY With ABS		◦	GHA228036	K
	2003.07-	Saloon Engine BAY Without ABS	•		GHA336002	
	2003.07-	Saloon Engine BAY Without ABS		◦	GHA228037	
1.6 (74 kW)	2002.09-	Saloon Engine BAH/BPA/CFZA	•		GHA422026	
	2002.09-	Saloon Engine BAH/BPA/CFZA With ABS	•		GHA336001	K
	2002.09-	Saloon Engine BAH/BPA/CFZA With ABS		◦	GHA228036	K
1.9 SDi (47 kW)	2002.09-	Saloon Engine ASY	•		GHA422026	
	2002.09-	Saloon Engine ASY With ABS	•		GHA336001	K
	2002.09-	Saloon Engine ASY With ABS		◦	GHA228036	K
	2002.09-	Saloon Engine ASY Without ABS	•		GHA336002	
	2002.09-	Saloon Engine ASY Without ABS		◦	GHA228037	
1.9 TDi (74 kW)	2002.09-	Saloon Engine ATD With ABS	•		GHA336001	K
	2002.09-	Saloon Engine ATD With ABS		◦	GHA228036	K
POLO (9N_)						
1.2 (40 kW)	2002.01-2007.05	Hatchback Engine AWY/BMD	•		GHA320002	K
	2002.01-2007.05	Hatchback Engine AWY/BMD With ABS	•		GHA336001	K
	2002.01-2007.05	Hatchback Engine AWY/BMD With ABS		◦	GHA228036	K
	2002.01-2007.05	Hatchback Engine AWY/BMD Without ABS	•		GHA336002	
	2002.01-2007.05	Hatchback Engine AWY/BMD Without ABS		◦	GHA228037	
1.2 (44 kW)	2007.05-2009.11	Hatchback Engine BBM	•		GHA320002	K
	2007.05-2009.11	Hatchback Engine BBM With ABS	•		GHA336001	K
	2007.05-2009.11	Hatchback Engine BBM With ABS		◦	GHA228036	K



	 YEAR		F	R	G-AP Ref.	KIT
VOLKSWAGEN						
POLO (9N_)						
1.2 (44 kW)	2007.05-2009.11	Hatchback Engine BBM Without ABS	•		GHA336002	
	2007.05-2009.11	Hatchback Engine BBM Without ABS		◦	GHA228037	
1.2 12V (47 kW)	2001.10-2007.07	Hatchback Engine AZQ/BME	•		GHA320002	K
	2001.10-2007.07	Hatchback Engine AZQ/BME With ABS	•		GHA336001	K
	2001.10-2007.07	Hatchback Engine AZQ/BME With ABS		◦	GHA228036	K
	2001.10-2007.07	Hatchback Engine AZQ/BME Without ABS	•		GHA336002	
	2001.10-2007.07	Hatchback Engine AZQ/BME Without ABS		◦	GHA228037	
1.2 12V (51 kW)	2007.05-2009.11	Hatchback Engine BZG	•		GHA320002	K
	2007.05-2009.11	Hatchback Engine BZG With ABS	•		GHA336001	K
	2007.05-2009.11	Hatchback Engine BZG With ABS		◦	GHA228036	K
	2007.05-2009.11	Hatchback Engine BZG Without ABS	•		GHA336002	
	2007.05-2009.11	Hatchback Engine BZG Without ABS		◦	GHA228037	
1.4 (63 kW)	2005.06-2009.11	Hatchback	•		GHA320002	K
	2005.06-2009.11	Hatchback With ABS	•		GHA336001	K
	2005.06-2009.11	Hatchback With ABS		◦	GHA228036	K
1.4 16V (55 kW)	2001.10-2008.05	Hatchback Engine AUA/BBY/BKY	•		GHA320002	K
	2001.10-2008.05	Hatchback Engine AUA/BBY/BKY With ABS	•		GHA336001	K
	2001.10-2008.05	Hatchback Engine AUA/BBY/BKY With ABS		◦	GHA228036	K
	2001.10-2008.05	Hatchback Engine AUA/BBY/BKY Without ABS	•		GHA336002	
	2001.10-2008.05	Hatchback Engine AUA/BBY/BKY Without ABS		◦	GHA228037	
1.4 16V (59 kW)	2006.06-2007.11	Hatchback Engine BUD	•		GHA320002	K
	2006.06-2007.11	Hatchback Engine BUD With ABS	•		GHA336001	K
	2006.06-2007.11	Hatchback Engine BUD With ABS		◦	GHA228036	K
	2006.06-2007.11	Hatchback Engine BUD Without ABS	•		GHA336002	
	2006.06-2007.11	Hatchback Engine BUD Without ABS		◦	GHA228037	
1.4 16V (74 kW)	2001.10-2008.05	Hatchback Engine AUB/BBZ	•		GHA320002	K
	2001.10-2008.05	Hatchback Engine AUB/BBZ With ABS	•		GHA336001	K
	2001.10-2008.05	Hatchback Engine AUB/BBZ With ABS		◦	GHA228036	K
	2001.10-2008.05	Hatchback Engine AUB/BBZ Without ABS	•		GHA336002	
	2001.10-2008.05	Hatchback Engine AUB/BBZ Without ABS		◦	GHA228037	
1.4 FSi (63 kW)	2002.02-2006.07	Hatchback Engine AXU	•		GHA320002	K
	2002.02-2006.07	Hatchback Engine AXU With ABS	•		GHA336001	K
	2002.02-2006.07	Hatchback Engine AXU With ABS		◦	GHA228036	K
	2002.02-2006.07	Hatchback Engine AXU Without ABS	•		GHA336002	
	2002.02-2006.07	Hatchback Engine AXU Without ABS		◦	GHA228037	
1.4 TDi (51 kW)	2005.06-2007.06	Hatchback Engine BNM/BWB With ABS	•		GHA336001	K
	2005.06-2007.06	Hatchback Engine BNM/BWB With ABS		◦	GHA228036	K
	2005.06-2007.06	Hatchback Engine BNM/BWB Without ABS	•		GHA336002	
	2005.06-2007.06	Hatchback Engine BNM/BWB Without ABS		◦	GHA228037	
1.4 TDi (55 kW)	2001.10-2005.06	Hatchback Engine AMF/BAY With ABS	•		GHA336001	K
	2001.10-2005.06	Hatchback Engine AMF/BAY With ABS		◦	GHA228036	K
	2001.10-2005.06	Hatchback Engine AMF/BAY Without ABS	•		GHA336002	
	2001.10-2005.06	Hatchback Engine AMF/BAY Without ABS		◦	GHA228037	
1.4 TDi (59 kW)	2005.06-2007.06	Hatchback Engine BMS/BNV With ABS	•		GHA336001	K
	2005.06-2007.06	Hatchback Engine BMS/BNV With ABS		◦	GHA228036	K
	2005.06-2007.06	Hatchback Engine BMS/BNV Without ABS	•		GHA336002	
	2005.06-2007.06	Hatchback Engine BMS/BNV Without ABS		◦	GHA228037	
1.6 (74 kW)	2002.08-2005.05	Hatchback Engine BAH	•		GHA320002	K
	2002.08-2005.05	Hatchback Engine BAH With ABS	•		GHA336001	K
	2002.08-2005.05	Hatchback Engine BAH With ABS		◦	GHA228036	K
	2002.08-2005.05	Hatchback Engine BAH Without ABS		◦	GHA228037	
1.6 16V (77 kW)	2006.06-2007.06	Hatchback Engine BTS	•		GHA320002	K
	2006.06-2007.06	Hatchback Engine BTS With ABS	•		GHA336001	K
	2006.06-2007.06	Hatchback Engine BTS With ABS		◦	GHA228036	K
	2006.06-2007.06	Hatchback Engine BTS Without ABS	•		GHA336002	
	2006.06-2007.06	Hatchback Engine BTS Without ABS		◦	GHA228037	
1.6 Flex (74 kW)	2008.06-2009.04	Hatchback Engine CCRA	•		GHA320002	K
	2008.06-2009.04	Hatchback Engine CCRA With ABS	•		GHA336001	K
	2008.06-2009.04	Hatchback Engine CCRA With ABS		◦	GHA228036	K
1.8 GTi (110 kW)	2006.03-2007.06	Hatchback Engine BJX With ABS	•		GHA336001	K
	2006.03-2007.06	Hatchback Engine BJX With ABS		◦	GHA228036	K
	2006.03-2007.06	Hatchback Engine BJX Without ABS	•		GHA336002	
	2006.03-2007.06	Hatchback Engine BJX Without ABS		◦	GHA228037	
1.8 GTi Cup EDition (132 kW)	2006.05-2009.11	Hatchback Engine BBU With ABS	•		GHA336001	K



	 YEAR		F	R	G-AP Ref.	KIT
VOLKSWAGEN						
POLO (9N_)						
1.8 GTi Cup Edition (132 kW)	2006.05-2009.11	Hatchback Engine BBU With ABS		o	GHA228036	K
	2006.05-2009.11	Hatchback Engine BBU Without ABS	•		GHA336002	
	2006.05-2009.11	Hatchback Engine BBU Without ABS		o	GHA228037	
1.9 SDi (47 kW)	2001.10-2009.11	Hatchback Engine ASY With ABS	•		GHA336001	K
	2001.10-2009.11	Hatchback Engine ASY With ABS		o	GHA228036	K
	2001.10-2009.11	Hatchback Engine ASY Without ABS	•		GHA336002	
	2001.10-2009.11	Hatchback Engine ASY Without ABS		o	GHA228037	
1.9 TDi (74 kW)	2001.10-2009.11	Hatchback Engine ATD/AXR/BMT With ABS	•		GHA336001	K
	2001.10-2009.11	Hatchback Engine ATD/AXR/BMT With ABS		o	GHA228036	K
	2001.10-2009.11	Hatchback Engine ATD/AXR/BMT Without ABS	•		GHA336002	
	2001.10-2009.11	Hatchback Engine ATD/AXR/BMT Without ABS		o	GHA228037	
1.9 TDi (96 kW)	2004.07-2006.05	Hatchback Engine ASZ/BLT With ABS	•		GHA336001	K
	2004.07-2006.05	Hatchback Engine ASZ/BLT With ABS		o	GHA228036	K
	2004.07-2006.05	Hatchback Engine ASZ/BLT Without ABS	•		GHA336002	
	2004.07-2006.05	Hatchback Engine ASZ/BLT Without ABS		o	GHA228037	
POLO CLASSIC (6KV2)						
1.4 (62 kW)	1996.05-2002.07	Saloon Engine AGY	•		GHA422036	K
	1996.05-2002.07	Saloon Engine AGY	•		GWB1358	
	1996.05-2002.07	Saloon Engine AGY		o	GWB0529	
	1996.05-2002.07	Saloon Engine AGY With ABS		o	GHA228041	K
1.8 HybriD (74 kW)	1996.05-2001.09	Saloon	•		GWB1358	
	1996.05-2001.09	Saloon		o	GWB0529	
	1996.05-2001.09	Saloon With ABS		o	GHA228041	K
POLO VARIANT (6KV5)						
1.4 (40 kW)	1998.12-2001.09	Estate Engine AKP	•		GHA422036	K
	1998.12-2001.09	Estate Engine AKP	•		GWB1358	
	1998.12-2001.09	Estate Engine AKP		o	GWB0529	
	1998.12-2001.09	Estate Engine AKP With ABS		o	GHA228041	K
1.4 (44 kW)	1997.05-2001.09	Estate Engine AEX/AKK/AKV/ANW/APQ/AUD	•		GHA422036	K
	1997.05-2001.09	Estate Engine AEX/AKK/AKV/ANW/APQ/AUD	•		GWB1358	
	1997.05-2001.09	Estate Engine AEX/AKK/AKV/ANW/APQ/AUD		o	GHA499046	
	1997.05-2001.09	Estate Engine AEX/AKK/AKV/ANW/APQ/AUD		o	GWB0529	
	1997.05-2001.09	Estate Engine AEX/AKK/AKV/ANW/APQ/AUD With ABS		o	GHA228041	K
1.4 16V (55 kW)	1999.10-2001.09	Estate Engine APE/AUA	•		GHA422036	K
	1999.10-2001.09	Estate Engine APE/AUA	•		GWB1358	
	1999.10-2001.09	Estate Engine APE/AUA With ABS		o	GHA228041	K
1.6 (55 kW)	1997.05-2001.09	Estate Engine AEE/ALM	•		GHA422036	K
	1997.05-2001.09	Estate Engine AEE/ALM	•		GWB1358	
	1997.05-2001.09	Estate Engine AEE/ALM		o	GHA499046	
	1997.05-2001.09	Estate Engine AEE/ALM		o	GWB0529	
	1997.05-2001.09	Estate Engine AEE/ALM With ABS		o	GHA228041	K
	1997.05-2001.09	Estate Engine AEE/ALM With ABS		o	GWB0529	
1.6 (74 kW)	1997.05-2001.09	Estate Engine AEH/AFT/AKL/APF/AUR	•		GHA422036	K
	1997.05-2001.09	Estate Engine AEH/AFT/AKL/APF/AUR	•		GWB1358	
	1997.05-2001.09	Estate Engine AEH/AFT/AKL/APF/AUR		o	GHA499046	
	1997.05-2001.09	Estate Engine AEH/AFT/AKL/APF/AUR		o	GWB0529	
	1997.05-2001.09	Estate Engine AEH/AFT/AKL/APF/AUR With ABS		o	GHA228041	K
1.7 SDi (42 kW)	1997.08-2001.09	Estate Engine AKW	•		GHA422036	K
	1997.08-2001.09	Estate Engine AKW	•		GWB1358	
	1997.08-2001.09	Estate Engine AKW		o	GHA499046	
	1997.08-2001.09	Estate Engine AKW		o	GWB0529	
	1997.08-2001.09	Estate Engine AKW With ABS		o	GHA228041	K
	1997.08-2001.09	Estate Engine AKW With ABS		o	GWB0529	
1.8 (66 kW)	1997.05-2001.09	Estate Engine ADZ	•		GHA422036	K
	1997.05-2001.09	Estate Engine ADZ	•		GWB1358	
	1997.05-2001.09	Estate Engine ADZ		o	GWB0529	
	1997.05-2001.09	Estate Engine ADZ With ABS		o	GHA228041	K
1.9 SDi (47 kW)	1997.06-2001.09	Estate Engine AEY	•		GHA422036	K
	1997.06-2001.09	Estate Engine AEY	•		GWB1358	
	1997.06-2001.09	Estate Engine AEY		o	GHA499046	
	1997.06-2001.09	Estate Engine AEY		o	GWB0529	
	1997.06-2001.09	Estate Engine AEY With ABS		o	GHA228041	K
1.9 SDi (50 kW)	1999.08-2001.09	Estate Engine AGP/AQM	•		GHA422036	K
	1999.08-2001.09	Estate Engine AGP/AQM	•		GWB1358	
	1999.08-2001.09	Estate Engine AGP/AQM		o	GWB0529	
	1999.08-2001.09	Estate Engine AGP/AQM With ABS		o	GHA228041	K



	 YEAR		F	R	G-AP Ref.	KIT
VOLKSWAGEN						
POLO VARIANT (6KV5)						
1.9 TDi (66 kW)	1997.05-2001.09	Estate Engine AGR/AHU/ALE/ALH	•		GHA422036	K
	1997.05-2001.09	Estate Engine AGR/AHU/ALE/ALH	•		GWB1358	
	1997.05-2001.09	Estate Engine AGR/AHU/ALE/ALH		◦	GHA499046	
	1997.05-2001.09	Estate Engine AGR/AHU/ALE/ALH		◦	GWB0529	
	1997.05-2001.09	Estate Engine AGR/AHU/ALE/ALH With ABS		◦	GHA228041	K
1.9 TDi (81 kW)	1998.06-2001.09	Estate Engine AFN/ASV	•		GHA422036	K
	1998.06-2001.09	Estate Engine AFN/ASV	•		GWB1358	
	1998.06-2001.09	Estate Engine AFN/ASV		◦	GHA499014	
	1998.06-2001.09	Estate Engine AFN/ASV		◦	GHA499015	
	1998.06-2001.09	Estate Engine AFN/ASV		◦	GHA499046	
	1998.06-2001.09	Estate Engine AFN/ASV		◦	GWB0529	
	1998.06-2001.09	Estate Engine AFN/ASV With ABS		◦	GHA228041	K
ROUTAN						
3.6 (196 kW)	2011.1-	MPV Engine CJRA		◦	GHA400175	
3.6 (208 kW)	2011.1-	MPV		◦	GHA400175	
3.8 (147 kW)	2008.9-2010.12	MPV Engine CGUA		◦	GHA400175	
4.0 (187 kW)	2008.9-2010.12	MPV Engine CGUA		◦	GHA400175	
SANTANA						
1.8 i (72 kW)	1995.01-	Saloon Engine AFE	•		GWB1355	
	1995.01-	Saloon Engine AFE	•		GWB1358	
	1995.01-	Saloon Engine AFE		◦	GHA400003	
	1995.01-	Saloon Engine AFE		◦	GWB0529	
SCIROCCO (137)						
1.4 TSi (118 kW)	2008.05-	Coupe Engine CAVD/CNWA/CTHD/CTKA 4 hole	•		GHA336007	K
	2008.05-	Coupe Engine CAVD/CNWA/CTHD/CTKA Inner Diameter [32mm]		◦	GHA232018	K
1.4 TSi (90 kW)	2008.08-	Coupe Engine CAXA/CMSB 4 hole	•		GHA336007	K
	2008.08-	Coupe Engine CAXA/CMSB Inner Diameter [32mm]		◦	GHA232018	K
2.0 R (188 kW)	2009.11-	Coupe Engine CDLC 4 hole	•		GHA336007	K
	2009.11-	Coupe Engine CDLC Inner Diameter [32mm]		◦	GHA232018	K
2.0 R (195 kW)	2009.11-	Coupe Engine CDLA 4 hole	•		GHA336007	K
	2009.11-	Coupe Engine CDLA Inner Diameter [32mm]		◦	GHA232018	K
2.0 TDi (100 kW)	2010.11-	Coupe Engine CFHB 4 hole	•		GHA336007	K
	2010.11-	Coupe Engine CFHB Inner Diameter [32mm]		◦	GHA232018	K
2.0 TDi (103 kW)	2008.08-	Coupe Engine CBDB/CFHC 4 hole	•		GHA336007	K
	2008.08-	Coupe Engine CBDB/CFHC Inner Diameter [32mm]		◦	GHA232018	K
2.0 TDi (125 kW)	2009.05-	Coupe Engine CBBB/CFGB 4 hole	•		GHA336007	K
	2009.05-	Coupe Engine CBBB/CFGB Inner Diameter [32mm]		◦	GHA232018	K
2.0 TDi (130 kW)	2013.01-	Coupe Engine CFGC 4 hole	•		GHA336007	K
	2013.01-	Coupe Engine CFGC Inner Diameter [32mm]		◦	GHA232018	K
2.0 TSi (147 kW)	2008.05-2009.11	Coupe Engine CAWB 4 hole	•		GHA336007	K
	2008.05-2009.11	Coupe Engine CAWB Inner Diameter [32mm]		◦	GHA232018	K
2.0 TSi (155 kW)	2009.11-2011.05	Coupe Engine CCZB 4 hole	•		GHA336007	K
	2009.11-2011.05	Coupe Engine CCZB Inner Diameter [32mm]		◦	GHA232018	K
SCIROCCO (137, 138)						
1.4 TSi (92 kW)	2013.11-	Coupe Engine CXSB/CZCA 4 hole	•		GHA336007	K
	2013.11-	Coupe Engine CXSB/CZCA Inner Diameter [32mm]		◦	GHA232018	K
2.0 R (206 kW)	2014.05-	Coupe Engine CDLK 4 hole	•		GHA336007	K
	2014.05-	Coupe Engine CDLK Inner Diameter [32mm]		◦	GHA232018	K
2.0 TDi (110 kW)	2013.11-	Coupe Engine CUUB 4 hole	•		GHA336007	K
	2013.11-	Coupe Engine CUUB Inner Diameter [32mm]		◦	GHA232018	K
2.0 TDi (135 kW)	2014.05-	Coupe Engine CUWA/CUXA 4 hole	•		GHA336007	K
	2014.05-	Coupe Engine CUWA/CUXA Inner Diameter [32mm]		◦	GHA232018	K
2.0 TSi (132 kW)	2013.11-	Coupe Engine CULA 4 hole	•		GHA336007	K
	2013.11-	Coupe Engine CULA Inner Diameter [32mm]		◦	GHA232018	K
2.0 TSi (162 kW)	2013.11-	Coupe Engine CULC 4 hole	•		GHA336007	K
	2013.11-	Coupe Engine CULC Inner Diameter [32mm]		◦	GHA232018	K
SHARAN (7M8, 7M9, 7M6)						
1.8 T 20V (110 kW)	1997.09-2010.03	MPV Engine AJH/AWC	•		GWB3449	
	1997.09-2010.03	MPV Engine AJH/AWC		◦	GWB3450	
1.9 TDi (110 kW)	2005.06-2010.03	MPV Engine BTB	•		GWB3449	
	2005.06-2010.03	MPV Engine BTB		◦	GWB3450	
1.9 TDi (66 kW)	1995.09-2010.03	MPV Engine 1Z/AHU/ANU	•		GWB3449	
	1995.09-2010.03	MPV Engine 1Z/AHU/ANU		◦	GWB3450	



	 YEAR		F	R	G-AP Ref.	KIT
VOLKSWAGEN						
SHARAN (7M8, 7M9, 7M6)						
1.9 TDi (81 kW)	1996.09-2000.04	MPV Engine AFN/AVG	•		GWB3449	
	1996.09-2000.04	MPV Engine AFN/AVG		◦	GWB3450	
1.9 TDi (85 kW)	2000.04-2010.03	MPV Engine AUJ/BVK	•		GWB3449	
	2000.04-2010.03	MPV Engine AUJ/BVK		◦	GWB3450	
1.9 TDi (96 kW)	2002.11-2010.03	MPV Engine ASZ	•		GWB3449	
	2002.11-2010.03	MPV Engine ASZ		◦	GWB3450	
1.9 TDi 4motion (85 kW)	2000.04-2010.03	MPV Engine AUJ/BVK	•		GWB3449	
2.0 (85 kW)	1995.09-2010.03	MPV Engine ADY/ATM	•		GWB3449	
	1995.09-2010.03	MPV Engine ADY/ATM		◦	GWB3450	
2.0 16V (110 kW)	1995.09-2000.02	MPV Engine ABF	•		GWB3449	
	1995.09-2000.02	MPV Engine ABF		◦	GWB3450	
2.0 LPG (85 kW)	2006.04-2010.03	MPV Engine ATM	•		GWB3449	
	2006.04-2010.03	MPV Engine ATM		◦	GWB3450	
2.0 TDi (100 kW)	2005.11-2010.03	MPV Engine BVH	•		GWB3449	
	2005.11-2010.03	MPV Engine BVH		◦	GWB3450	
2.0 TDi (103 kW)	2005.11-2008.02	MPV Engine BRT	•		GWB3449	
	2005.11-2008.02	MPV Engine BRT		◦	GWB3450	
2.8 V6 24V (150 kW)	2000.04-2010.03	MPV Engine AYL	•		GWB3449	
	2000.04-2010.03	MPV Engine AYL		◦	GWB3450	
2.8 V6 24V 4motion (150 kW)	2000.04-2010.03	MPV Engine AYL	•		GWB3449	
2.8 VR6 (128 kW)	1995.09-2000.04	MPV Engine AAA/AMY	•		GWB3449	
	1995.09-2000.04	MPV Engine AAA/AMY		◦	GWB3450	
2.8 VR6 Syncro (128 kW)	1996.11-2000.04	MPV Engine AAA/AMY	•		GWB3449	
SHARAN (7N)						
1.4 TSi (110 kW)	2010.05-	MPV Engine CAVA 4 hole	•		GHA336007	K
	2010.05-	MPV Engine CAVA Inner Diameter [32mm]		◦	GHA232018	K
2.0 TDi (100 kW)	2010.05-	MPV Engine CFFA 4 hole	•		GHA336007	K
	2010.05-	MPV Engine CFFA Inner Diameter [32mm]		◦	GHA232018	K
2.0 TDi (103 kW)	2010.05-	MPV Engine CFFB 4 hole	•		GHA336007	K
	2010.05-	MPV Engine CFFB Inner Diameter [32mm]		◦	GHA232018	K
2.0 TDi (125 kW)	2010.08-	MPV Engine CFGB 4 hole	•		GHA336007	K
	2010.08-	MPV Engine CFGB Inner Diameter [32mm]		◦	GHA232018	K
2.0 TDi (130 kW)	2013.01-	MPV Engine CFGC 4 hole	•		GHA336007	K
	2013.01-	MPV Engine CFGC Inner Diameter [32mm]		◦	GHA232018	K
2.0 TDi (85 kW)	2011.05-	MPV Engine CFFE 4 hole	•		GHA336007	K
	2011.05-	MPV Engine CFFE Inner Diameter [32mm]		◦	GHA232018	K
2.0 TDi 4motion (100 kW)	2011.05-2012.05	MPV Engine CFFA 4 hole	•		GHA336007	K
2.0 TDi 4motion (103 kW)	2011.05-	MPV Engine CFFB 4 hole	•		GHA336007	K
2.0 TSi (147 kW)	2010.12-	MPV Engine CCZA 4 hole	•		GHA336007	K
	2010.12-	MPV Engine CCZA Inner Diameter [32mm]		◦	GHA232018	K
TARO						
2.4 D (58 kW)	1994.07-1997.03	Pickup Engine 2L	•		GWB0826	
	1994.07-1997.03	Pickup Engine 2L		◦	GWB0827	
2.4 D (59 kW)	1991.09-1994.07	Pickup Engine 2L	•		GWB0826	
	1991.09-1994.07	Pickup Engine 2L		◦	GWB0827	
2.4 D 4x4 (58 kW)	1994.07-1997.03	Pickup Engine 2L	•		GWB1951	
	1994.07-1997.03	Pickup Engine 2L		◦	GWB0827	
TIGUAN (5N_)						
1.4 TSi (110 kW)	2008.05-	Closed Off-Road Vehicle Engine BWK/CAVA/CTHA 4 hole	•		GHA336007	K
	2008.05-	Closed Off-Road Vehicle Engine BWK/CAVA/CTHA Inner Diameter [32mm]		◦	GHA232018	K
	2015.05-	Closed Off-Road Vehicle Engine CZDA 4 hole	•		GHA336007	K
	2015.05-	Closed Off-Road Vehicle Engine CZDA Inner Diameter [32mm]		◦	GHA232018	K
1.4 TSi (118 kW)	2011.05-	Closed Off-Road Vehicle Engine CAVD/CTHD 4 hole	•		GHA336007	K
	2011.05-	Closed Off-Road Vehicle Engine CAVD/CTHD Inner Diameter [32mm]		◦	GHA232018	K
1.4 TSi (90 kW)	2010.08-	Closed Off-Road Vehicle Engine CAXA 4 hole	•		GHA336007	K
	2010.08-	Closed Off-Road Vehicle Engine CAXA Inner Diameter [32mm]		◦	GHA232018	K
1.4 TSi (92 kW)	2015.05-	Closed Off-Road Vehicle Engine CZDB 4 hole	•		GHA336007	K
	2015.05-	Closed Off-Road Vehicle Engine CZDB Inner Diameter [32mm]		◦	GHA232018	K
1.4 TSi 4motion (110 kW)	2007.10-	Closed Off-Road Vehicle Engine BWK/CAVA/CTHA 4 hole	•		GHA336007	K
1.4 TSi 4motion (118 kW)	2011.05-	Closed Off-Road Vehicle Engine CAVD/CTHD 4 hole	•		GHA336007	K
2.0 TDi (103 kW)	2008.03-	Closed Off-Road Vehicle Engine CBAB/CFFB 4 hole	•		GHA336007	K
	2008.03-	Closed Off-Road Vehicle Engine CBAB/CFFB Inner Diameter [32mm]		◦	GHA232018	K
2.0 TDi (110 kW)	2015.05-	Closed Off-Road Vehicle Engine CUVC 4 hole	•		GHA336007	K
	2015.05-	Closed Off-Road Vehicle Engine CUVC Inner Diameter [32mm]		◦	GHA232018	K



	 YEAR		F	R	G-AP Ref.	KIT
VOLKSWAGEN						
TIGUAN (5N_)						
2.0 TDi (81 kW)	2010.05-	Closed Off-Road Vehicle Engine CFFD 4 hole	•		GHA336007	K
	2010.05-	Closed Off-Road Vehicle Engine CFFD Inner Diameter [32mm]		◦	GHA232018	K
2.0 TDi 4motion (100 kW)	2007.11-	Closed Off-Road Vehicle Engine CFFA/CBAA 4 hole	•		GHA336007	K
2.0 TDi 4motion (103 kW)	2007.10-	Closed Off-Road Vehicle Engine CBAB/CFFB/CLJA 4 hole	•		GHA336007	K
2.0 TDi 4motion (110 kW)	2015.05-	Closed Off-Road Vehicle Engine CUVC 4 hole	•		GHA336007	K
2.0 TDi 4motion (120 kW)	2008.02-2009.08	Closed Off-Road Vehicle Engine CBBA 4 hole	•		GHA336007	K
2.0 TDi 4motion (125 kW)	2007.10-	Closed Off-Road Vehicle Engine CBBB/CFGB 4 hole	•		GHA336007	K
2.0 TDi 4motion (130 kW)	2012.11-	Closed Off-Road Vehicle Engine CFGC 4 hole	•		GHA336007	K
2.0 TDi 4motion (135 kW)	2015.05-	Closed Off-Road Vehicle Engine CUWA 4 hole	•		GHA336007	K
2.0 TFSi 4motion (125 kW)	2007.10-	Closed Off-Road Vehicle Engine CAWA/CCZC 4 hole	•		GHA336007	K
2.0 TFSi 4motion (147 kW)	2007.10-	Closed Off-Road Vehicle Engine CAWB/CCTA/CCZA 4 hole	•		GHA336007	K
2.0 TSi 4motion (132 kW)	2011.05-	Closed Off-Road Vehicle Engine CCZD 4 hole	•		GHA336007	K
2.0 TSi 4motion (155 kW)	2011.05-	Closed Off-Road Vehicle Engine CCZB 4 hole	•		GHA336007	K
TOUAREG (7LA, 7L6, 7L7)						
2.5 R5 TDi (120 kW)	2003.08-2010.05	Closed Off-Road Vehicle Engine BLK/BPD	•		GHA338001	K
2.5 R5 TDi (128 kW)	2003.01-2010.05	Closed Off-Road Vehicle Engine BAC/BPE	•		GHA338001	K
3.0 TDi (155 kW)	2006.04-2010.05	Closed Off-Road Vehicle Engine CASB/BUN	•		GWB3645	
3.0 V6 TDi (165 kW)	2004.10-2008.02	Closed Off-Road Vehicle Engine BKS/CATA	•		GWB3645	
3.0 V6 TDi (176 kW)	2007.11-2010.05	Closed Off-Road Vehicle Engine CASA/CASC	•		GWB3645	
3.2 V6 (162 kW)	2002.10-2006.11	Closed Off-Road Vehicle Engine AZZ/BKJ/BMV/BMX/BRJ	•		GWB3645	
3.2 V6 (177 kW)	2004.11-2006.11	Closed Off-Road Vehicle Engine BMV	•		GWB3645	
3.6 V6 FSi (206 kW)	2005.10-2010.05	Closed Off-Road Vehicle Engine BHK/BHL	•		GWB3645	
4.2 V8 (228 kW)	2002.12-2006.11	Closed Off-Road Vehicle Engine AXQ	•		GWB3645	
4.2 V8 FSi (257 kW)	2006.06-2010.05	Closed Off-Road Vehicle Engine BAR	•		GWB3645	
5.0 R50 TDi (257 kW)	2007.08-2010.05	Closed Off-Road Vehicle Engine CBWA	•		GWB3645	
5.0 V10 TDi (230 kW)	2002.10-2010.05	Closed Off-Road Vehicle Engine AYH/BLE/BWF	•		GWB3645	
6.0 W12 (331 kW)	2004.08-2010.05	Closed Off-Road Vehicle Engine BJN/CFRA	•		GWB3645	
TOUAREG (7P5)						
3.0 V6 TDi (150 kW)	2010.01-	Closed Off-Road Vehicle Engine CASD/CJMA	•		GWB3645	
	2010.01-	Closed Off-Road Vehicle Engine CASD/CJMA		◦	GHA251002	K
3.0 V6 TDi (165 kW)	2010.06-	Closed Off-Road Vehicle Engine CATA	•		GWB3645	
	2010.06-	Closed Off-Road Vehicle Engine CATA		◦	GHA251002	K
3.0 V6 TDi (176 kW)	2010.01-	Closed Off-Road Vehicle Engine CASA/CNRB	•		GWB3645	
	2010.01-	Closed Off-Road Vehicle Engine CASA/CNRB		◦	GHA251002	K
3.0 V6 TDi (180 kW)	2011.05-	Closed Off-Road Vehicle Engine CJGD/CRCA	•		GWB3645	
	2011.05-	Closed Off-Road Vehicle Engine CJGD/CRCA		◦	GHA251002	K
3.0 V6 TSi (213 kW)	2010.08-	Closed Off-Road Vehicle Engine CJTA	•		GWB3645	
	2010.08-	Closed Off-Road Vehicle Engine CJTA		◦	GHA251002	K
3.0 V6 TSi Hybrid (245 kW)	2010.04-	Closed Off-Road Vehicle Hybrid Engine CGEA/CGFA	•		GHA251002	K
3.6 V6 FSi (183 kW)	2010.08-	Closed Off-Road Vehicle Engine CMTA	•		GWB3645	
	2010.08-	Closed Off-Road Vehicle Engine CMTA		◦	GHA251002	K
3.6 V6 FSi (206 kW)	2010.04-	Closed Off-Road Vehicle Engine CGRA	•		GWB3645	
	2010.04-	Closed Off-Road Vehicle Engine CGRA		◦	GHA251002	K
4.2 V8 FSi (265 kW)	2011.01-	Closed Off-Road Vehicle Engine CGNA	•		GHA251002	K
4.2 V8 TDi (250 kW)	2010.01-	Closed Off-Road Vehicle Engine CKDA	•		GHA251002	K
TOURAN (1T1, 1T2)						
1.4 FSi (125 kW)	2006.11-2010.05	MPV Engine CAVB/BLG 4 hole	•		GHA336007	K
	2006.11-2010.05	MPV Engine CAVB/BLG Inner Diameter [32mm]		◦	GHA232018	K
1.4 TSi (103 kW)	2006.06-2010.05	MPV Engine BMY/CAVC 4 hole	•		GHA336007	K
	2006.06-2010.05	MPV Engine BMY/CAVC Inner Diameter [32mm]		◦	GHA232018	K
1.4 TSi EcoFuel (110 kW)	2009.05-2010.05	MPV Engine CDGA 4 hole	•		GHA336007	K
	2009.05-2010.05	MPV Engine CDGA Inner Diameter [32mm]		◦	GHA232018	K
1.6 (75 kW)	2003.08-2010.05	MPV Engine BGU/BSE/BSF 4 hole	•		GHA336007	K
	2003.08-2010.05	MPV Engine BGU/BSE/BSF Inner Diameter [32mm]		◦	GHA232018	K
1.6 FSi (85 kW)	2003.08-2007.01	MPV Engine BAG/BLF/BLP 4 hole	•		GHA336007	K
	2003.08-2007.01	MPV Engine BAG/BLF/BLP Inner Diameter [32mm]		◦	GHA232018	K
1.9 TDi (66 kW)	2004.11-2010.05	MPV Engine BRU/BXF/BXJ 4 hole	•		GHA336007	K
	2004.11-2010.05	MPV Engine BRU/BXF/BXJ Inner Diameter [32mm]		◦	GHA232018	K
1.9 TDi (74 kW)	2003.08-2010.05	MPV Engine AVQ 4 hole	•		GHA336007	K
	2003.08-2010.05	MPV Engine AVQ Inner Diameter [32mm]		◦	GHA232018	K
1.9 TDi (77 kW)	2003.08-2010.05	MPV Engine BKC/BLS/BXE 4 hole	•		GHA336007	K
	2003.08-2010.05	MPV Engine BKC/BLS/BXE Inner Diameter [32mm]		◦	GHA232018	K
2.0 EcoFuel (80 kW)	2006.02-2009.05	MPV Engine BSX 4 hole	•		GHA336007	K
	2006.02-2009.05	MPV Engine BSX Inner Diameter [32mm]		◦	GHA232018	K



	 YEAR		F	R	G-AP Ref.	KIT
VOLKSWAGEN						
TOURAN (1T1, 1T2)						
2.0 FSi (110 kW)	2004.01-2006.12	MPV Engine AXW/BLR/BLX/BLY/BVY/BVZ 4 hole	•		GHA336007	K
	2004.01-2006.12	MPV Engine AXW/BLR/BLX/BLY/BVY/BVZ Inner Diameter [32mm]		○	GHA232018	K
2.0 FSi (85 kW)	2004.10-2010.05	MPV Engine BJZ 4 hole	•		GHA336007	K
	2004.10-2010.05	MPV Engine BJZ Inner Diameter [32mm]		○	GHA232018	K
2.0 TDi (100 kW)	2003.08-2010.05	MPV Engine AZV 4 hole	•		GHA336007	K
	2003.08-2010.05	MPV Engine AZV Inner Diameter [32mm]		○	GHA232018	K
2.0 TDi (103 kW)	2006.12-2010.05	MPV Engine BMM 4 hole	•		GHA336007	K
	2006.12-2010.05	MPV Engine BMM Inner Diameter [32mm]		○	GHA232018	K
2.0 TDi (125 kW)	2006.06-2010.05	MPV Engine BMN/CFJA 4 hole	•		GHA336007	K
	2006.06-2010.05	MPV Engine BMN/CFJA Inner Diameter [32mm]		○	GHA232018	K
2.0 TDi 16V (103 kW)	2003.08-2010.05	MPV Engine BKD 4 hole	•		GHA336007	K
	2003.08-2010.05	MPV Engine BKD Inner Diameter [32mm]		○	GHA232018	K
TOURAN (1T3)						
1.2 TSi (77 kW)	2010.05-	MPV Engine CBZB 4 hole	•		GHA336007	K
	2010.05-	MPV Engine CBZB Inner Diameter [32mm]		○	GHA232018	K
1.4 TSi (103 kW)	2010.05-	MPV Engine CAVC/CTHC 4 hole	•		GHA336007	K
	2010.05-	MPV Engine CAVC/CTHC Inner Diameter [32mm]		○	GHA232018	K
1.4 TSi (125 kW)	2010.05-	MPV Engine CAVB/CTHB 4 hole	•		GHA336007	K
	2010.05-	MPV Engine CAVB/CTHB Inner Diameter [32mm]		○	GHA232018	K
1.4 TSi EcoFuel (110 kW)	2010.05-	MPV Engine CDGA 4 hole	•		GHA336007	K
	2010.05-	MPV Engine CDGA Inner Diameter [32mm]		○	GHA232018	K
1.6 TDi (66 kW)	2010.05-	MPV Engine CAYB 4 hole	•		GHA336007	K
	2010.05-	MPV Engine CAYB Inner Diameter [32mm]		○	GHA232018	K
1.6 TDi (77 kW)	2010.05-	MPV Engine CAYC 4 hole	•		GHA336007	K
	2010.05-	MPV Engine CAYC Inner Diameter [32mm]		○	GHA232018	K
2.0 TDi (103 kW)	2010.05-	MPV Engine CFHC 4 hole	•		GHA336007	K
	2010.05-	MPV Engine CFHC Inner Diameter [32mm]		○	GHA232018	K
2.0 TDi (125 kW)	2010.05-2013.01	MPV Engine CFJA 4 hole	•		GHA336007	K
	2010.05-2013.01	MPV Engine CFJA Inner Diameter [32mm]		○	GHA232018	K
2.0 TDi (130 kW)	2013.01-2015.05	MPV Engine CFJB 4 hole	•		GHA336007	K
	2013.01-2015.05	MPV Engine CFJB Inner Diameter [32mm]		○	GHA232018	K
2.0 TDi (81 kW)	2010.11-	MPV Engine CLCA/CFHF 4 hole	•		GHA336007	K
	2010.11-	MPV Engine CLCA/CFHF Inner Diameter [32mm]		○	GHA232018	K
TOURAN (5T1)						
1.2 TSi (81 kW)	2015.05-	MPV Engine CYVB 4 hole	•		GHA336007	K
	2015.05-	MPV Engine CYVB Inner Diameter [32mm]		○	GHA232018	K
1.4 TSi (110 kW)	2015.05-	MPV Engine CZDA 4 hole	•		GHA336007	K
	2015.05-	MPV Engine CZDA Inner Diameter [32mm]		○	GHA232018	K
1.6 TDi (81 kW)	2015.05-	MPV Engine CRKB 4 hole	•		GHA336007	K
	2015.05-	MPV Engine CRKB Inner Diameter [32mm]		○	GHA232018	K
2.0 TDi (110 kW)	2015.05-	MPV Engine DFEA 4 hole	•		GHA336007	K
	2015.05-	MPV Engine DFEA Inner Diameter [32mm]		○	GHA232018	K
TRANSPORTER / CARAVELLE V (7HB, 7HJ, 7EB, 7EJ, 7EF)						
1.9 TDi (62 kW)	2006.01-2009.11	Bus Engine BRR	•		GHA338001	K
1.9 TDi (63 kW)	2003.04-2009.11	Bus Engine AXC	•		GHA338001	K
1.9 TDi (75 kW)	2006.06-2009.11	Bus Engine BRS	•		GHA338001	K
1.9 TDi (77 kW)	2003.04-2009.11	Bus Engine AXB	•		GHA338001	K
2.0 (85 kW)	2003.11-	Bus Engine AXA	•		GHA338001	K
2.0 BiTDi (132 kW)	2009.09-	Bus Engine CFCA	•		GHA338001	K
2.0 BiTDi 4motion (132 kW)	2009.09-	Bus Engine CFCA	•		GHA338001	K
2.0 TDi (100 kW)	2010.05-	Bus Engine CAAE/CCHB	•		GHA338001	K
2.0 TDi (103 kW)	2009.09-	Bus Engine CAAC/CCHA	•		GHA338001	K
2.0 TDi (62 kW)	2009.09-	Bus Engine CAAA	•		GHA338001	K
2.0 TDi (75 kW)	2009.09-	Bus Engine CAAB	•		GHA338001	K
2.0 TDi (84 kW)	2011.05-	Bus Engine CAAD	•		GHA338001	K
2.0 TDi 4motion (100 kW)	2010.05-	Bus Engine CAAE/CCHB	•		GHA338001	K
2.0 TDi 4motion (103 kW)	2009.09-	Bus Engine CAAC/CCHA	•		GHA338001	K
2.0 TSi (110 kW)	2012.07-	Bus Engine CJKB	•		GHA338001	K
2.0 TSi (150 kW)	2011.05-	Bus Engine CJKA	•		GHA338001	K
2.0 TSi 4motion (150 kW)	2011.07-	Bus Engine CJKA	•		GHA338001	K
2.5 TDi (120 kW)	2003.11-2009.11	Bus Engine BLJ	•		GHA338001	K
2.5 TDi (128 kW)	2003.04-2009.11	Bus Engine AXE/BPC	•		GHA338001	K
2.5 TDi (96 kW)	2003.04-2009.11	Bus Engine AXD/BNZ	•		GHA338001	K
2.5 TDi 4motion (128 kW)	2004.07-2009.11	Bus Engine AXE/BPC	•		GHA338001	K



	 YEAR		F	R	G-AP Ref.	KIT
VOLKSWAGEN						
TRANSPORTER / CARAVELLE V (7HB, 7HJ, 7EB, 7EJ, 7EF)						
2.5 TDi 4motion (96 kW)	2004.07-2009.11	Bus Engine AXD/BNZ	•		GHA338001	K
3.2 V6 (170 kW)	2004.02-2004.06	Bus Engine BDL	•		GHA338001	K
3.2 V6 (173 kW)	2004.02-2009.11	Bus Engine BKK/CFLA	•		GHA338001	K
3.2 V6 4motion (173 kW)	2003.11-2009.11	Bus Engine BKK/CFLA	•		GHA338001	K
TRANSPORTER V (7HA, 7HH, 7EA, 7EH)						
1.9 TDi (62 kW)	2006.01-2009.11	Box Engine BRR	•		GHA338001	K
1.9 TDi (63 kW)	2003.04-2009.11	Box Engine AXC	•		GHA338001	K
1.9 TDi (75 kW)	2006.06-2009.11	Box Engine BRS	•		GHA338001	K
1.9 TDi (77 kW)	2003.04-2009.11	Box Engine AXB	•		GHA338001	K
2.0 (85 kW)	2003.11-	Box Engine AXA	•		GHA338001	K
2.0 BiTDi (132 kW)	2009.09-	Box Engine CFCA	•		GHA338001	K
2.0 BiTDi 4motion (132 kW)	2009.09-	Box Engine CFCA	•		GHA338001	K
2.0 TDi (100 kW)	2010.05-	Box Engine CAAE/CCHB	•		GHA338001	K
2.0 TDi (103 kW)	2009.09-	Box Engine CAAC/CCHA	•		GHA338001	K
2.0 TDi (62 kW)	2009.09-	Box Engine CAAA	•		GHA338001	K
2.0 TDi (75 kW)	2009.09-	Box Engine CAAB	•		GHA338001	K
2.0 TDi (84 kW)	2011.05-	Box Engine CAAD	•		GHA338001	K
2.0 TDi 4motion (100 kW)	2010.05-	Box Engine CAAE/CCHB	•		GHA338001	K
2.0 TDi 4motion (103 kW)	2009.09-	Box Engine CAAC/CCHA	•		GHA338001	K
2.0 TSi (110 kW)	2012.07-	Box Engine CJKB	•		GHA338001	K
2.0 TSi (150 kW)	2011.05-	Box Engine CJKA	•		GHA338001	K
2.0 TSi 4motion (150 kW)	2011.07-	Box Engine CJKA	•		GHA338001	K
2.5 TDi (128 kW)	2003.04-2009.11	Box Engine AXE/BPC	•		GHA338001	K
2.5 TDi (96 kW)	2003.04-2009.11	Box Engine AXD/BNZ	•		GHA338001	K
2.5 TDi 4motion (128 kW)	2004.07-2009.11	Box Engine AXE/BPC	•		GHA338001	K
2.5 TDi 4motion (96 kW)	2004.07-2009.11	Box Engine AXD/BNZ	•		GHA338001	K
3.2 4motion (173 kW)	2003.11-2009.11	Box Engine BKK/CFLA	•		GHA338001	K
3.2 V6 (170 kW)	2003.04-2004.06	Box Engine BDL	•		GHA338001	K
3.2 V6 (173 kW)	2004.02-2009.11	Box Engine BKK/CFLA	•		GHA338001	K
TRANSPORTER V (7JD, 7JE, 7JL, 7JY, 7JZ)						
1.9 TDi (62 kW)	2006.01-2009.11	Platform/Chassis Engine BRR	•		GHA338001	K
1.9 TDi (63 kW)	2003.04-2009.11	Platform/Chassis Engine AXC	•		GHA338001	K
1.9 TDi (75 kW)	2006.06-2009.11	Platform/Chassis Engine BRS	•		GHA338001	K
1.9 TDi (77 kW)	2003.04-2009.11	Platform/Chassis Engine AXB	•		GHA338001	K
2.0 (85 kW)	2003.11-	Platform/Chassis Engine AXA	•		GHA338001	K
2.0 BiTDi (132 kW)	2009.09-	Platform/Chassis Engine CFCA	•		GHA338001	K
2.0 BiTDi 4motion (132 kW)	2009.09-	Platform/Chassis Engine CFCA	•		GHA338001	K
2.0 TDi (100 kW)	2010.05-	Platform/Chassis Engine CAAE	•		GHA338001	K
2.0 TDi (103 kW)	2009.09-	Platform/Chassis Engine CAAC	•		GHA338001	K
2.0 TDi (62 kW)	2009.09-	Platform/Chassis Engine CAAA	•		GHA338001	K
2.0 TDi (75 kW)	2009.09-	Platform/Chassis Engine CAAB	•		GHA338001	K
2.0 TDi (84 kW)	2011.05-	Platform/Chassis Engine CAAD	•		GHA338001	K
2.0 TDi 4motion (100 kW)	2010.05-	Platform/Chassis Engine CAAE/CCHB	•		GHA338001	K
2.0 TDi 4motion (103 kW)	2009.09-	Platform/Chassis Engine CAAC	•		GHA338001	K
2.0 TSi (110 kW)	2012.07-	Platform/Chassis Engine CJKB	•		GHA338001	K
2.5 TDi (128 kW)	2003.04-2009.11	Platform/Chassis Engine AXE/BPC	•		GHA338001	K
2.5 TDi (96 kW)	2003.04-2009.11	Platform/Chassis Engine AXD/BNZ	•		GHA338001	K
2.5 TDi 4motion (128 kW)	2004.04-2009.11	Platform/Chassis Engine AXE/BPC	•		GHA338001	K
2.5 TDi 4motion (96 kW)	2004.07-2009.11	Platform/Chassis Engine AXD/BNZ	•		GHA338001	K
3.2 V6 (170 kW)	2004.02-2009.11	Platform/Chassis Engine BDL	•		GHA338001	K
3.2 V6 (173 kW)	2003.08-2006.05	Platform/Chassis Engine BKK	•		GHA338001	K
TRANSPORTER VI (SFD, SFE, SFL, SFZ)						
2.0 TDi (103 kW)	2015.04	Platform/Chassis Engine CAAC	•		GHA338001	K
2.0 TDi (132 kW)	2015.04	Platform/Chassis Engine CFCA	•		GHA338001	K
2.0 TDi (62 kW)	2015.04	Platform/Chassis Engine CAAA	•		GHA338001	K
2.0 TDi (75 kW)	2015.04	Platform/Chassis Engine CAAB	•		GHA338001	K
2.0 TDi 4motion (103 kW)	2015.06	Platform/Chassis Engine CAAC	•		GHA338001	K
2.0 TDi 4motion (132 kW)	2015.06	Platform/Chassis Engine CFCA	•		GHA338001	K
2.0 TSi (110 kW)	2015.04	Platform/Chassis Engine CJKB	•		GHA338001	K
TRANSPORTER VI (SGA, SGH)						
2.0 TDi (103 kW)	2015.04	Box Engine CAAC	•		GHA338001	K
2.0 TDi (110 kW)	2015.04	Box Engine CXFA/CXHA	•		GHA338001	K
2.0 TDi (132 kW)	2015.04	Box Engine CFCA	•		GHA338001	K
2.0 TDi (150 kW)	2015.06	Box Engine CXEB	•		GHA338001	K



	 YEAR		F	R	G-AP Ref.	KIT
VOLKSWAGEN						
TRANSPORTER VI (SGA, SGH)						
2.0 TDi (62 kW)	2015.04	Box Engine CAAC/CXGA	•		GHA338001	K
2.0 TDi (75 kW)	2015.04	Box Engine CAAB/CXGB	•		GHA338001	K
2.0 TDi 4motion (103 kW)	2015.06	Box Engine CAAC	•		GHA338001	K
2.0 TDi 4motion (110 kW)	2015.08-	Box Engine CXFA/CXHA	•		GHA338001	K
2.0 TDi 4motion (132 kW)	2015.06	Box Engine CFCA	•		GHA338001	K
2.0 TDi 4motion (150 kW)	2015.06	Box Engine CXEB	•		GHA338001	K
2.0 TSi (110 kW)	2015.04	Box Engine CJKB	•		GHA338001	K
2.0 TSi (150 kW)	2015.04	Box Engine CJKA	•		GHA338001	K
2.0 TSi 4motion (150 kW)	2015.06	Box Engine CJKA	•		GHA338001	K
TRANSPORTER VI (SGB, SGG, SGJ)						
2.0 TDi (103 kW)	2015.04	Bus Engine CAAC	•		GHA338001	K
2.0 TDi (110 kW)	2015.04	Bus Engine CXFA/CXHA	•		GHA338001	K
2.0 TDi (132 kW)	2015.04	Bus Engine CFCA	•		GHA338001	K
2.0 TDi (150 kW)	2015.06	Bus Engine CXEB	•		GHA338001	K
2.0 TDi (62 kW)	2015.04	Bus Engine CAAA/CXGA	•		GHA338001	K
2.0 TDi (75 kW)	2015.04	Bus Engine CAAB/CXGB	•		GHA338001	K
2.0 TDi 4motion (103 kW)	2015.06	Bus Engine CAAC	•		GHA338001	K
2.0 TDi 4motion (110 kW)	2015.08-	Bus Engine CXFA/CXHA	•		GHA338001	K
2.0 TDi 4motion (132 kW)	2015.06	Bus Engine CFCA	•		GHA338001	K
2.0 TDi 4motion (150 kW)	2015.06	Bus Engine CXEB	•		GHA338001	K
2.0 TSi (110 kW)	2015.04	Bus Engine CJKB	•		GHA338001	K
2.0 TSi (150 kW)	2015.04	Bus Engine CJKA	•		GHA338001	K
2.0 TSi 4motion (150 kW)	2015.06	Bus Engine CJKA	•		GHA338001	K
UP						
1.0 (44 kW)	2011.12-	Hatchback Engine CHYA		○	GHA228061	K
1.0 (55 kW)	2011.12-	Hatchback Engine CHYB		○	GHA228061	K
1.0 (56 kW)	2014.01-	Hatchback		○	GHA228061	K
1.0 EcoFuel (50 kW)	2012.11-	Hatchback Engine CPGA		○	GHA228061	K
e-Up (60 kW)	2013.07-	Hatchback Engine EABA		○	GHA228061	K
VENTO (1H2)						
1.4 (40 kW)	1991.11-1998.09	Saloon Engine ABD/AEX	•		GHA422009	K
	1991.11-1998.09	Saloon Engine ABD/AEX	•		GHA422036	K
	1991.11-1998.09	Saloon Engine ABD/AEX	•		GWB1358	
	1991.11-1998.09	Saloon Engine ABD/AEX		○	GHA499014	
	1991.11-1998.09	Saloon Engine ABD/AEX		○	GHA499015	
	1991.11-1998.09	Saloon Engine ABD/AEX		○	GHA499044	
	1991.11-1998.09	Saloon Engine ABD/AEX		○	GHA499045	
	1991.11-1998.09	Saloon Engine ABD/AEX		○	GHA499046	
	1991.11-1998.09	Saloon Engine ABD/AEX		○	GWB0529	
1.4 (44 kW)	1991.11-1998.09	Saloon Engine ABD/AEX	•		GHA422009	K
	1991.11-1998.09	Saloon Engine ABD/AEX	•		GHA422036	K
	1991.11-1998.09	Saloon Engine ABD/AEX	•		GWB1358	
	1991.11-1998.09	Saloon Engine ABD/AEX		○	GHA499014	
	1991.11-1998.09	Saloon Engine ABD/AEX		○	GHA499015	
	1991.11-1998.09	Saloon Engine ABD/AEX		○	GHA499044	
	1991.11-1998.09	Saloon Engine ABD/AEX		○	GHA499045	
	1991.11-1998.09	Saloon Engine ABD/AEX		○	GHA499046	
	1991.11-1998.09	Saloon Engine ABD/AEX		○	GWB0529	
1.6 (55 kW)	1992.09-1998.09	Saloon Engine ABU/AEA/AEE	•		GHA422009	K
	1992.09-1998.09	Saloon Engine ABU/AEA/AEE	•		GHA422036	K
	1992.09-1998.09	Saloon Engine ABU/AEA/AEE	•		GWB1358	
	1992.09-1998.09	Saloon Engine ABU/AEA/AEE		○	GHA499014	
	1992.09-1998.09	Saloon Engine ABU/AEA/AEE		○	GHA499015	
	1992.09-1998.09	Saloon Engine ABU/AEA/AEE		○	GHA499044	
	1992.09-1998.09	Saloon Engine ABU/AEA/AEE		○	GHA499045	
	1992.09-1998.09	Saloon Engine ABU/AEA/AEE		○	GHA499046	
	1992.09-1998.09	Saloon Engine ABU/AEA/AEE		○	GWB0529	
1.6 (74 kW)	1994.10-1998.09	Saloon Engine AEK/AFT	•		GHA422009	K
	1994.10-1998.09	Saloon Engine AEK/AFT	•		GHA422036	K
	1994.10-1998.09	Saloon Engine AEK/AFT	•		GWB1358	
	1994.10-1998.09	Saloon Engine AEK/AFT		○	GHA499014	
	1994.10-1998.09	Saloon Engine AEK/AFT		○	GHA499015	
	1994.10-1998.09	Saloon Engine AEK/AFT		○	GHA499044	
1994.10-1998.09	Saloon Engine AEK/AFT		○	GHA499045		



	 YEAR		F	R	G-AP Ref.	KIT
VOLKSWAGEN						
VENTO (1H2)						
1.6 (74 kW)	1994.10-1998.09	Saloon Engine AEK/AFT		o	GHA499046	
	1994.10-1998.09	Saloon Engine AEK/AFT		o	GWB0529	
1.8 (55 kW)	1991.11-1998.09	Saloon Engine AAM	•		GHA422009	K
	1991.11-1998.09	Saloon Engine AAM	•		GHA422036	K
	1991.11-1998.09	Saloon Engine AAM	•		GWB1358	
	1991.11-1998.09	Saloon Engine AAM		o	GHA499044	
	1991.11-1998.09	Saloon Engine AAM		o	GHA499045	
	1991.11-1998.09	Saloon Engine AAM		o	GHA499046	
	1991.11-1998.09	Saloon Engine AAM		o	GWB0529	
1.8 (66 kW)	1991.11-1998.09	Saloon Engine ABS/ADZ	•		GHA422009	K
	1991.11-1998.09	Saloon Engine ABS/ADZ	•		GHA422036	K
	1991.11-1998.09	Saloon Engine ABS/ADZ	•		GWB1358	
	1991.11-1998.09	Saloon Engine ABS/ADZ		o	GHA499014	
	1991.11-1998.09	Saloon Engine ABS/ADZ		o	GHA499015	
	1991.11-1998.09	Saloon Engine ABS/ADZ		o	GHA499044	
	1991.11-1998.09	Saloon Engine ABS/ADZ		o	GHA499045	
	1991.11-1998.09	Saloon Engine ABS/ADZ		o	GHA499046	
	1991.11-1998.09	Saloon Engine ABS/ADZ		o	GWB0529	
1.9 D (48 kW)	1991.11-1998.09	Saloon Engine 1Y	•		GHA422009	K
	1991.11-1998.09	Saloon Engine 1Y	•		GHA422036	K
	1991.11-1998.09	Saloon Engine 1Y	•		GWB1358	
	1991.11-1998.09	Saloon Engine 1Y		o	GHA499014	
	1991.11-1998.09	Saloon Engine 1Y		o	GHA499015	
	1991.11-1998.09	Saloon Engine 1Y		o	GHA499044	
	1991.11-1998.09	Saloon Engine 1Y		o	GHA499045	
	1991.11-1998.09	Saloon Engine 1Y		o	GHA499046	
	1991.11-1998.09	Saloon Engine 1Y		o	GWB0529	
1.9 SDi (47 kW)	1997.04-1998.09	Saloon Engine AEY	•		GHA422009	K
	1997.04-1998.09	Saloon Engine AEY	•		GHA422036	K
	1997.04-1998.09	Saloon Engine AEY	•		GWB1358	
	1997.04-1998.09	Saloon Engine AEY		o	GHA499014	
	1997.04-1998.09	Saloon Engine AEY		o	GHA499015	
	1997.04-1998.09	Saloon Engine AEY		o	GHA499044	
	1997.04-1998.09	Saloon Engine AEY		o	GHA499045	
	1997.04-1998.09	Saloon Engine AEY		o	GHA499046	
	1997.04-1998.09	Saloon Engine AEY		o	GWB0529	
1.9 TD (55 kW)	1991.11-1998.09	Saloon Engine AAZ	•		GHA422009	K
	1991.11-1998.09	Saloon Engine AAZ	•		GHA422036	K
	1991.11-1998.09	Saloon Engine AAZ	•		GWB1358	
	1991.11-1998.09	Saloon Engine AAZ		o	GHA499014	
	1991.11-1998.09	Saloon Engine AAZ		o	GHA499015	
	1991.11-1998.09	Saloon Engine AAZ		o	GHA499044	
	1991.11-1998.09	Saloon Engine AAZ		o	GHA499045	
	1991.11-1998.09	Saloon Engine AAZ		o	GHA499046	
	1991.11-1998.09	Saloon Engine AAZ		o	GWB0529	
1.9 TDi (66 kW)	1993.09-1998.09	Saloon Engine 1Z/AHU/ALE	•		GHA422009	K
	1993.09-1998.09	Saloon Engine 1Z/AHU/ALE	•		GHA422036	K
	1993.09-1998.09	Saloon Engine 1Z/AHU/ALE	•		GWB1358	
	1993.09-1998.09	Saloon Engine 1Z/AHU/ALE		o	GHA499014	
	1993.09-1998.09	Saloon Engine 1Z/AHU/ALE		o	GHA499015	
	1993.09-1998.09	Saloon Engine 1Z/AHU/ALE		o	GHA499044	
	1993.09-1998.09	Saloon Engine 1Z/AHU/ALE		o	GHA499045	
	1993.09-1998.09	Saloon Engine 1Z/AHU/ALE		o	GHA499046	
	1993.09-1998.09	Saloon Engine 1Z/AHU/ALE		o	GWB0529	
1.9 TDi (81 kW)	1996.04-1998.09	Saloon Engine AFN	•		GHA422009	K
	1996.04-1998.09	Saloon Engine AFN	•		GHA422036	K
	1996.04-1998.09	Saloon Engine AFN	•		GWB1358	
	1996.04-1998.09	Saloon Engine AFN		o	GHA499014	
	1996.04-1998.09	Saloon Engine AFN		o	GHA499015	
	1996.04-1998.09	Saloon Engine AFN		o	GHA499044	
	1996.04-1998.09	Saloon Engine AFN		o	GHA499045	
	1996.04-1998.09	Saloon Engine AFN		o	GHA499046	
	1996.04-1998.09	Saloon Engine AFN		o	GWB0529	
2.0 (85 kW)	1991.11-1998.09	Saloon Engine 2E/ADY/AGG/AKR	•		GHA422009	K



	 YEAR		F	R	G-AP Ref.	KIT
VOLKSWAGEN						
VENTO (1H2)						
2.0 (85 kW)	1991.11-1998.09	Saloon Engine 2E/ADY/AGG/AKR	•		GHA422036	K
	1991.11-1998.09	Saloon Engine 2E/ADY/AGG/AKR	•		GHA436001	
	1991.11-1998.09	Saloon Engine 2E/ADY/AGG/AKR	•		GWB1358	
	1991.11-1998.09	Saloon Engine 2E/ADY/AGG/AKR		○	GHA499014	
	1991.11-1998.09	Saloon Engine 2E/ADY/AGG/AKR		○	GHA499015	
	1991.11-1998.09	Saloon Engine 2E/ADY/AGG/AKR		○	GHA499044	
	1991.11-1998.09	Saloon Engine 2E/ADY/AGG/AKR		○	GHA499045	
	1991.11-1998.09	Saloon Engine 2E/ADY/AGG/AKR		○	GHA499046	
	1991.11-1998.09	Saloon Engine 2E/ADY/AGG/AKR		○	GWB0529	
2.8 VR6 (128 kW)	1992.01-1998.09	Saloon Engine AAA	•		GHA436001	
	1992.01-1998.09	Saloon Engine AAA	•		GWB1491	
	1992.01-1998.09	Saloon Engine AAA		○	GHA499014	
	1992.01-1998.09	Saloon Engine AAA		○	GHA499015	
	1992.01-1998.09	Saloon Engine AAA		○	GHA499044	
	1992.01-1998.09	Saloon Engine AAA		○	GHA499045	
	1992.01-1998.09	Saloon Engine AAA		○	GHA499046	
1992.01-1998.09	Saloon Engine AAA		○	GWB0529		
VOLVO						
440 K (445)						
1.6 (69 kW)	1991.09-1993.08	Hatchback Engine B16F1	•		GWB1495	
	1991.09-1993.08	Hatchback Engine B16F1 With ABS		○	GHA230061	K
	1991.09-1993.08	Hatchback Engine B16F1 Without ABS		○	GHA230110	K
1.7 Turbo (90 kW)	1991.01-1996.12	Hatchback Engine B18FT	•		GWB1495	
	1991.01-1996.12	Hatchback Engine B18FT With ABS		○	GHA230061	K
	1991.01-1996.12	Hatchback Engine B18FT Without ABS		○	GHA230110	K
1.8 (66 kW)	1991.08-1996.07	Hatchback Engine B18U	•		GWB1495	
	1991.08-1996.07	Hatchback Engine B18U With ABS		○	GHA230061	K
	1991.08-1996.07	Hatchback Engine B18U Without ABS		○	GHA230110	K
	1995.09-1996.12	Hatchback Engine B18U	•		GWB1495	
	1995.09-1996.12	Hatchback Engine B18U With ABS		○	GHA230061	K
1.9 Turbo Diesel (66 kW)	1994.07-1996.12	Hatchback Engine D19T	•		GWB1495	
	1994.07-1996.12	Hatchback Engine D19T With ABS		○	GHA230061	K
	1994.07-1996.12	Hatchback Engine D19T Without ABS		○	GHA230110	K
2.0 (80 kW)	1993.08-1996.07	Hatchback Engine B20F	•		GWB1495	
	1993.08-1996.07	Hatchback Engine B20F With ABS		○	GHA230061	K
	1993.08-1996.07	Hatchback Engine B20F Without ABS		○	GHA230110	K
2.0 (81 kW)	1992.08-1995.07	Hatchback Engine B20F	•		GWB1495	
	1992.08-1995.07	Hatchback Engine B20F With ABS		○	GHA230061	K
	1992.08-1995.07	Hatchback Engine B20F Without ABS		○	GHA230110	K
460 L (464)						
1.6 (61 kW)	1992.07-1996.07	Saloon Engine B16F	•		GWB1495	
	1992.07-1996.07	Saloon Engine B16F With ABS		○	GHA230061	K
	1992.07-1996.07	Saloon Engine B16F Without ABS		○	GHA230110	K
1.7 (66 kW)	1990.09-1996.07	Saloon Engine B18KP	•		GWB1495	
	1990.09-1996.07	Saloon Engine B18KP With ABS		○	GHA230061	K
	1990.09-1996.07	Saloon Engine B18KP Without ABS		○	GHA230110	K
1.7 Turbo (90 kW)	1991.01-1996.07	Saloon Engine B18FT	•		GWB1495	
	1991.01-1996.07	Saloon Engine B18FT With ABS		○	GHA230061	K
	1991.01-1996.07	Saloon Engine B18FT Without ABS		○	GHA230110	K
1.8 (66 kW)	1991.08-1996.07	Saloon Engine B18U	•		GWB1495	
	1991.08-1996.07	Saloon Engine B18U With ABS		○	GHA230061	K
	1991.08-1996.07	Saloon Engine B18U Without ABS		○	GHA230110	K
1.9 Turbo Diesel (66 kW)	1994.07-1996.07	Saloon Engine D19T	•		GWB1495	
	1994.07-1996.07	Saloon Engine D19T With ABS		○	GHA230061	K
	1994.07-1996.07	Saloon Engine D19T Without ABS		○	GHA230110	K
2.0 (80 kW)	1993.08-1996.07	Saloon Engine B20F	•		GWB1495	
	1993.08-1996.07	Saloon Engine B20F With ABS		○	GHA230061	K
	1993.08-1996.07	Saloon Engine B20F Without ABS		○	GHA230110	K
2.0 (81 kW)	1992.08-1995.07	Saloon Engine B20F	•		GWB1495	
	1992.08-1995.07	Saloon Engine B20F With ABS		○	GHA230061	K
	1992.08-1995.07	Saloon Engine B20F Without ABS		○	GHA230110	K



	 YEAR		F	R	G-AP Ref.	KIT
VOLVO						
480 E						
1.7 Turbo (90 kW)	1991.01-1996.07	Coupe Engine B18FT	•		GWB1495	
	1991.01-1996.07	Coupe Engine B18FT With ABS		◦	GHA230061	K
	1991.01-1996.07	Coupe Engine B18FT Without ABS		◦	GHA230110	K
2.0 (81 kW)	1992.08-1995.09	Coupe Engine B20F	•		GWB1495	
	1992.08-1995.09	Coupe Engine B20F With ABS		◦	GHA230061	K
	1992.08-1995.09	Coupe Engine B20F Without ABS		◦	GHA230110	K
740 (744)						
2.0 (147 kW)	1990.09-1992.08	Saloon Engine B 204 FTE With ABS	•		GHA235011	K
	1990.09-1992.08	Saloon Engine B 204 FTE Without ABS	•		GHA235008	K
	1990.09-1992.08	Saloon Engine B 204 FTE Without ABS	•		GHA235008	K
2.0 (82 kW)	1990.09-1992.08	Saloon Engine B 200 F With ABS	•		GHA235011	K
	1990.09-1992.08	Saloon Engine B 200 F Without ABS	•		GHA235008	K
	1990.09-1992.08	Saloon Engine B 200 F Without ABS	•		GHA235008	K
2.0 Turbo (114 kW)	1990.09-1991.08	Saloon Engine B 200 FT With ABS	•		GHA235011	K
	1990.09-1991.08	Saloon Engine B 200 FT Without ABS	•		GHA235008	K
	1990.09-1991.08	Saloon Engine B 200 FT Without ABS	•		GHA235008	K
740 KOMBI (745)						
2.0 (147 kW)	1990.09-1992.08	Estate Engine B 204 FTE With ABS	•		GHA235011	K
	1990.09-1992.08	Estate Engine B 204 FTE Without ABS	•		GHA235008	K
	1990.09-1992.08	Estate Engine B 204 FTE Without ABS	•		GHA235008	K
2.0 Turbo (114 kW)	1990.09-1991.08	Estate Engine B 200 FT With ABS	•		GHA235011	K
	1990.09-1991.08	Estate Engine B 200 FT Without ABS	•		GHA235008	K
	1990.09-1991.08	Estate Engine B 200 FT Without ABS	•		GHA235008	K
850 (LS)						
2.0 (105 kW)	1991.06-1996.12	Saloon Engine B5204F	•		GHA326004	K
	1991.06-1996.12	Saloon Engine B5204F	•		GHA326005	K
	1991.06-1996.12	Saloon Engine B5204F		◦	GHA230109	K
2.0 (93 kW)	1994.08-1996.12	Saloon Engine B5202S	•		GHA326004	K
	1994.08-1996.12	Saloon Engine B5202S		◦	GHA230109	K
2.0 Turbo (132 kW)	1993.09-1996.10	Saloon Engine B5204T2	•		GHA326004	K
	1993.09-1996.10	Saloon Engine B5204T2		◦	GHA230109	K
2.0 Turbo (155 kW)	1993.08-1996.12	Saloon Engine B5204FT/B5204T	•		GHA326004	K
	1993.08-1996.12	Saloon Engine B5204FT/B5204T		◦	GHA230109	K
2.3 (106 kW)	1996.01-1996.1	Saloon Engine B 5234 FS	•		GHA326004	K
	1996.01-1996.1	Saloon Engine B 5234 FS		◦	GHA230109	K
2.3 T5 (166 kW)	1993.08-1996.07	Saloon Engine B5234FT	•		GHA326004	K
	1993.08-1996.07	Saloon Engine B5234FT		◦	GHA230109	K
2.3 T5 R (176 kW)	1996.04-1996.1	Saloon Engine B 5234 T2	•		GHA326004	K
	1996.04-1996.1	Saloon Engine B 5234 T2		◦	GHA230109	K
2.3 T5 R (184 kW)	1995.08-1996.12	Saloon Engine B5234T4	•		GHA326004	K
	1995.08-1996.12	Saloon Engine B5234T4		◦	GHA230109	K
2.3 Turbo R (177 kW)	1995.06-1996.10	Saloon Engine B5234T5	•		GHA326004	K
	1995.06-1996.10	Saloon Engine B5234T5		◦	GHA230109	K
2.4 GLE (142 kW)	1993.09-1997.10	Saloon Engine B5254T	•		GHA326004	K
	1993.09-1997.10	Saloon Engine B5254T		◦	GHA230109	K
2.5 (103 kW)	1991.06-1994.07	Saloon Engine B5252	•		GHA326004	K
	1991.06-1994.07	Saloon Engine B5252	•		GHA326005	K
	1991.06-1994.07	Saloon Engine B5252		◦	GHA230109	K
2.5 (106 kW)	1994.08-1996.12	Saloon Engine B5252FS	•		GHA326004	K
	1994.08-1996.12	Saloon Engine B5252FS		◦	GHA230109	K
2.5 (125 kW)	1991.08-1996.12	Saloon Engine B5254S	•		GHA326004	K
	1991.08-1996.12	Saloon Engine B5254S	•		GHA326005	K
	1991.08-1996.12	Saloon Engine B5254S		◦	GHA230109	K
2.5 TDi (103 kW)	1995.08-1996.12	Saloon Engine D5252T	•		GHA326004	K
	1995.08-1996.12	Saloon Engine D5252T		◦	GHA230109	K
850 (LW)						
2.0 (105 kW)	1993.02-1996.12	Estate Engine B5204F	•		GHA326004	K
	1993.02-1996.12	Estate Engine B5204F	•		GHA326005	K
	1993.02-1996.12	Estate Engine B5204F		◦	GHA230109	K
2.0 (93 kW)	1994.08-1996.12	Estate Engine B5202S	•		GHA326004	K
	1994.08-1996.12	Estate Engine B5202S		◦	GHA230109	K
2.0 Turbo (132 kW)	1993.09-1997.10	Estate Engine B5204T2	•		GHA326004	K
	1993.09-1997.10	Estate Engine B5204T2		◦	GHA230109	K
2.0 Turbo (155 kW)	1993.02-1996.12	Estate Engine B5204FT/B5204T	•		GHA326004	K



	 YEAR		F	R	G-AP Ref.	KIT
VOLVO						
850 (LW)						
2.0 Turbo (155 kW)	1993.02-1996.12	Estate Engine B5204FT/B5204T	•		GHA326005	K
	1993.02-1996.12	Estate Engine B5204FT/B5204T		◦	GHA230109	K
2.3 (106 kW)	1996.01-1996.10	Estate Engine B5234FS	•		GHA326004	K
	1996.01-1996.10	Estate Engine B5234FS		◦	GHA230109	K
2.3 T5 (166 kW)	1993.02-1996.12	Estate Engine B5234FT	•		GHA326004	K
	1993.02-1996.12	Estate Engine B5234FT	•		GHA326005	K
	1993.02-1996.12	Estate Engine B5234FT		◦	GHA230109	K
2.3 T5 R (176 kW)	1996.04-1996.10	Estate Engine B5234T2	•		GHA326004	K
	1996.04-1996.10	Estate Engine B5234T2		◦	GHA230109	K
2.3 T5 R (184 kW)	1995.08-1996.12	Estate Engine B5234T4	•		GHA326004	K
	1995.08-1996.12	Estate Engine B5234T4		◦	GHA230109	K
2.3 Turbo R (177 kW)	1995.06-1997.10	Estate Engine B5234T5	•		GHA326004	K
	1995.06-1997.10	Estate Engine B5234T5		◦	GHA230109	K
2.4 GLE (142 kW)	1993.09-1997.10	Estate Engine B5254T	•		GHA326004	K
	1993.09-1997.10	Estate Engine B5254T		◦	GHA230109	K
2.5 (103 kW)	1992.08-1994.07	Estate Engine B5252	•		GHA326004	K
	1992.08-1994.07	Estate Engine B5252	•		GHA326005	K
	1992.08-1994.07	Estate Engine B5252		◦	GHA230109	K
2.5 (106 kW)	1994.08-1996.12	Estate Engine B5252FS	•		GHA326004	K
	1994.08-1996.12	Estate Engine B5252FS		◦	GHA230109	K
2.5 (125 kW)	1992.09-1996.12	Estate Engine B5254S	•		GHA326004	K
	1992.09-1996.12	Estate Engine B5254S	•		GHA326005	K
	1992.09-1996.12	Estate Engine B5254S		◦	GHA230109	K
2.5 AWD (142 kW)	1996.04-1996.12	Estate Engine B5254T	•		GHA326004	K
	1996.04-1996.12	Estate Engine B5254T		◦	GWB1314	
2.5 TDi (103 kW)	1995.08-1996.12	Estate Engine D5252T	•		GHA326004	K
	1995.08-1996.12	Estate Engine D5252T		◦	GHA230109	K
940 (944)						
2.0 (102 kW)	1990.09-1993.09	Saloon Engine B 204 FT		◦	GWB1314	
	1990.09-1993.09	Saloon Engine B 204 FT With ABS	•		GHA235011	K
	1990.09-1993.09	Saloon Engine B 204 FT Without ABS	•		GHA235008	K
	1990.09-1993.09	Saloon Engine B 204 FT Without ABS	•		GHA235008	K
2.0 (82 kW)	1992.01-1994.07	Saloon Engine B200F		◦	GWB1314	
	1992.01-1994.07	Saloon Engine B200F With ABS	•		GHA235011	K
	1992.01-1994.07	Saloon Engine B200F Without ABS	•		GHA235008	K
	1992.01-1994.07	Saloon Engine B200F Without ABS	•		GHA235008	K
2.0 (89 kW)	1990.09-1993.09	Saloon Engine B 200 E/B 200 G		◦	GWB1314	
	1990.09-1993.09	Saloon Engine B 200 E/B 200 G With ABS	•		GHA235011	K
	1990.09-1993.09	Saloon Engine B 200 E/B 200 G Without ABS	•		GHA235008	K
	1990.09-1993.09	Saloon Engine B 200 E/B 200 G Without ABS	•		GHA235008	K
2.0 Turbo (114 kW)	1990.08-1994.12	Saloon Engine B200FT		◦	GWB1314	
	1990.08-1994.12	Saloon Engine B200FT With ABS	•		GHA235011	K
2.3 (114 kW)	1990.08-1991.07	Saloon Engine B234F/B234G		◦	GWB1314	
	1990.08-1991.07	Saloon Engine B234F/B234G With ABS	•		GHA235011	K
	1990.08-1991.07	Saloon Engine B234F/B234G Without ABS	•		GHA235008	K
	1990.08-1991.07	Saloon Engine B234F/B234G Without ABS	•		GHA235008	K
2.3 (118 kW)	1990.09-1993.09	Saloon Engine B230FT		◦	GWB1314	
	1990.09-1993.09	Saloon Engine B230FT With ABS	•		GHA235011	K
	1990.09-1993.09	Saloon Engine B230FT Without ABS	•		GHA235008	K
	1990.09-1993.09	Saloon Engine B230FT Without ABS	•		GHA235008	K
2.3 (85 kW)	1992.08-1994.07	Saloon Engine B230FD		◦	GWB1314	
	1992.08-1994.07	Saloon Engine B230FD With ABS	•		GHA235011	K
	1992.08-1994.07	Saloon Engine B230FD Without ABS	•		GHA235008	K
	1992.08-1994.07	Saloon Engine B230FD Without ABS	•		GHA235008	K
2.3 (96 kW)	1990.08-1994.12	Saloon Engine B230FB/B230G		◦	GWB1314	
	1990.08-1994.12	Saloon Engine B230FB/B230G With ABS	•		GHA235011	K
	1990.08-1994.12	Saloon Engine B230FB/B230G Without ABS	•		GHA235008	K
	1990.08-1994.12	Saloon Engine B230FB/B230G Without ABS	•		GHA235008	K
2.3 Turbo (121 kW)	1990.08-1994.07	Saloon Engine B230FT		◦	GWB1314	
	1990.08-1994.07	Saloon Engine B230FT With ABS	•		GHA235011	K
2.3 Turbo (140 kW)	1991.08-1993.07	Saloon Engine B230FT+		◦	GWB1314	
	1991.08-1993.07	Saloon Engine B230FT+ With ABS	•		GHA235011	K
2.4 D (60 kW)	1990.08-1994.12	Saloon Engine D24		◦	GWB1314	
	1990.08-1994.12	Saloon Engine D24 With ABS	•		GHA235011	K



	 YEAR		F	R	G-AP Ref.	KIT
VOLVO						
940 (944)						
	1990.08-1994.12	Saloon Engine D24 Without ABS	•		GHA235008	K
	1990.08-1994.12	Saloon Engine D24 Without ABS	•		GHA235008	K
2.4 TD Intercooler (90 kW)	1990.08-1994.12	Saloon Engine D24TIC		◦	GWB1314	
	1990.08-1994.12	Saloon Engine D24TIC With ABS	•		GHA235011	K
	1990.08-1994.12	Saloon Engine D24TIC Without ABS	•		GHA235008	K
	1990.08-1994.12	Saloon Engine D24TIC Without ABS	•		GHA235008	K
2.4 Turbo Diesel (80 kW)	1990.08-1994.12	Saloon Engine D24T		◦	GWB1314	
	1990.08-1994.12	Saloon Engine D24T With ABS	•		GHA235011	K
	1990.08-1994.12	Saloon Engine D24T Without ABS	•		GHA235008	K
	1990.08-1994.12	Saloon Engine D24T Without ABS	•		GHA235008	K
940 II (944)						
2.0 (102 kW)	1994.10-1997.05	Saloon Engine B 204 FT		◦	GWB1314	
	1994.10-1997.05	Saloon Engine B 204 FT With ABS	•		GHA235011	K
	1994.10-1997.05	Saloon Engine B 204 FT Without ABS	•		GHA235008	K
	1994.10-1997.05	Saloon Engine B 204 FT Without ABS	•		GHA235008	K
2.0 (89 kW)	1994.11-1995.12	Saloon Engine B 200 G		◦	GWB1314	
	1994.11-1995.12	Saloon Engine B 200 G With ABS	•		GHA235011	K
	1994.11-1995.12	Saloon Engine B 200 G Without ABS	•		GHA235008	K
	1994.11-1995.12	Saloon Engine B 200 G Without ABS	•		GHA235008	K
2.0 Turbo (114 kW)	1996.04-1998.10	Estate Engine B200FT		◦	GWB1314	
	1996.04-1998.10	Estate Engine B200FT With ABS	•		GHA235011	K
	1996.04-1998.10	Saloon Engine B200FT		◦	GWB1314	
	1996.04-1998.10	Saloon Engine B200FT With ABS	•		GHA235011	K
2.3 (85 kW)	1994.08-1995.07	Estate Engine B230FD		◦	GWB1314	
	1994.08-1995.07	Estate Engine B230FD With ABS	•		GHA235011	K
	1994.08-1995.07	Estate Engine B230FD Without ABS	•		GHA235008	K
	1994.08-1995.07	Estate Engine B230FD Without ABS	•		GHA235008	K
	1994.08-1995.07	Saloon Engine B230FD		◦	GWB1314	
	1994.08-1995.07	Saloon Engine B230FD With ABS	•		GHA235011	K
	1994.08-1995.07	Saloon Engine B230FD Without ABS	•		GHA235008	K
	1994.08-1995.07	Saloon Engine B230FD Without ABS	•		GHA235008	K
2.3 (96 kW)	1994.08-1998.10	Estate Engine B230FB		◦	GWB1314	
	1994.08-1998.10	Estate Engine B230FB With ABS	•		GHA235011	K
	1994.08-1998.10	Estate Engine B230FB Without ABS	•		GHA235008	K
	1994.08-1998.10	Estate Engine B230FB Without ABS	•		GHA235008	K
	1994.08-1998.10	Saloon Engine B230FB		◦	GWB1314	
	1994.08-1998.10	Saloon Engine B230FB With ABS	•		GHA235011	K
	1994.08-1998.10	Saloon Engine B230FB Without ABS	•		GHA235008	K
	1994.08-1998.10	Saloon Engine B230FB Without ABS	•		GHA235008	K
2.3 Ti (99 kW)	1995.01-1998.10	Estate Engine B230FK		◦	GWB1314	
	1995.01-1998.10	Estate Engine B230FK With ABS	•		GHA235011	K
	1995.01-1998.10	Estate Engine B230FK Without ABS	•		GHA235008	K
	1995.01-1998.10	Estate Engine B230FK Without ABS	•		GHA235008	K
	1995.01-1998.10	Saloon Engine B230FK		◦	GWB1314	
	1995.01-1998.10	Saloon Engine B230FK With ABS	•		GHA235011	K
	1995.01-1998.10	Saloon Engine B230FK Without ABS	•		GHA235008	K
	1995.01-1998.10	Saloon Engine B230FK Without ABS	•		GHA235008	K
2.3 Turbo (121 kW)	1994.08-1998.10	Estate Engine B230FT		◦	GWB1314	
	1994.08-1998.10	Estate Engine B230FT With ABS	•		GHA235011	K
	1994.08-1998.10	Saloon Engine B230FK		◦	GWB1314	
	1994.08-1998.10	Saloon Engine B230FK With ABS	•		GHA235011	K
2.3 Turbo (126 kW)	1995.01-1998.12	Saloon Engine B230FT		◦	GWB1314	
	1995.01-1998.12	Saloon Engine B230FT With ABS	•		GHA235011	K
	1995.08-1998.10	Estate Engine B230FT		◦	GWB1314	
	1995.08-1998.10	Estate Engine B230FT With ABS	•		GHA235011	K
2.4 TD Interc. (90 kW)	1994.08-1998.10	Estate Engine D24TIC		◦	GWB1314	
	1994.08-1998.10	Estate Engine D24TIC With ABS	•		GHA235011	K
	1994.08-1998.10	Estate Engine D24TIC Without ABS	•		GHA235008	K
	1994.08-1998.10	Estate Engine D24TIC Without ABS	•		GHA235008	K
	1994.08-1998.10	Saloon Engine D24TIC		◦	GWB1314	
	1994.08-1998.10	Saloon Engine D24TIC With ABS	•		GHA235011	K
	1994.08-1998.10	Saloon Engine D24TIC Without ABS	•		GHA235008	K
	1994.08-1998.10	Saloon Engine D24TIC Without ABS	•		GHA235008	K



	 YEAR		F	R	G-AP Ref.	KIT
VOLVO						
940 II (945)						
2.0 (102 kW)	1994.10-1997.05	Estate Engine B 204 FT		o	GWB1314	
	1994.10-1997.05	Estate Engine B 204 FT With ABS	•		GHA235011	K
	1994.10-1997.05	Estate Engine B 204 FT Without ABS	•		GHA235008	K
	1994.10-1997.05	Estate Engine B 204 FT Without ABS	•		GHA235008	K
2.0 (89 kW)	1994.11-1995.12	Estate Engine B 200 G		o	GWB1314	
	1994.11-1995.12	Estate Engine B 200 G With ABS	•		GHA235011	K
	1994.11-1995.12	Estate Engine B 200 G Without ABS	•		GHA235008	K
	1994.11-1995.12	Estate Engine B 200 G Without ABS	•		GHA235008	K
940 KOMBI (945)						
2.0 (82 kW)	1992.01-1994.07	Estate Engine B200F		o	GWB1314	
	1992.01-1994.07	Estate Engine B200F With ABS	•		GHA235011	K
	1992.01-1994.07	Estate Engine B200F Without ABS	•		GHA235008	K
	1992.01-1994.07	Estate Engine B200F Without ABS	•		GHA235008	K
2.0 (89 kW)	1990.09-1993.09	Estate Engine B 200 G		o	GWB1314	
	1990.09-1993.09	Estate Engine B 200 G With ABS	•		GHA235011	K
	1990.09-1993.09	Estate Engine B 200 G Without ABS	•		GHA235008	K
	1990.09-1993.09	Estate Engine B 200 G Without ABS	•		GHA235008	K
2.0 Turbo (114 kW)	1991.01-1995.07	Estate Engine B200FT		o	GWB1314	
	1991.01-1995.07	Estate Engine B200FT With ABS	•		GHA235011	K
2.3 (114 kW)	1990.08-1991.07	Estate Engine B234F		o	GWB1314	
	1990.08-1991.07	Estate Engine B234F With ABS	•		GHA235011	K
	1990.08-1991.07	Estate Engine B234F Without ABS	•		GHA235008	K
	1990.08-1991.07	Estate Engine B234F Without ABS	•		GHA235008	K
2.3 (85 kW)	1992.08-1994.07	Estate Engine B230FD		o	GWB1314	
	1992.08-1994.07	Estate Engine B230FD With ABS	•		GHA235011	K
	1992.08-1994.07	Estate Engine B230FD Without ABS	•		GHA235008	K
	1992.08-1994.07	Estate Engine B230FD Without ABS	•		GHA235008	K
2.3 (96 kW)	1990.08-1994.12	Estate Engine B230FB		o	GWB1314	
	1990.08-1994.12	Estate Engine B230FB With ABS	•		GHA235011	K
	1990.08-1994.12	Estate Engine B230FB Without ABS	•		GHA235008	K
	1990.08-1994.12	Estate Engine B230FB Without ABS	•		GHA235008	K
2.3 Turbo (121 kW)	1990.08-1994.07	Estate Engine B230FT		o	GWB1314	
	1990.08-1994.07	Estate Engine B230FT With ABS	•		GHA235011	K
2.3 Turbo (140 kW)	1991.08-1993.07	Estate Engine B230FT+		o	GWB1314	
	1991.08-1993.07	Estate Engine B230FT+ With ABS	•		GHA235011	K
2.4 D (60 kW)	1990.08-1995.07	Estate Engine D24		o	GWB1314	
	1990.08-1995.07	Estate Engine D24 Without ABS	•		GHA235008	K
	1990.08-1995.07	Estate Engine D24 Without ABS	•		GHA235008	K
2.4 TD Intercooler (90 kW)	1990.08-1994.08	Estate Engine D24TIC		o	GWB1314	
	1990.08-1994.08	Estate Engine D24TIC Without ABS	•		GHA235008	K
	1990.08-1994.08	Estate Engine D24TIC Without ABS	•		GHA235008	K
2.4 Turbo Diesel (80 kW)	1990.08-1994.07	Estate Engine D24T		o	GWB1314	
	1990.08-1994.07	Estate Engine D24T With ABS	•		GHA235011	K
	1990.08-1994.07	Estate Engine D24T Without ABS	•		GHA235008	K
	1990.08-1994.07	Estate Engine D24T Without ABS	•		GHA235008	K
960 (964)						
2.0 (103 kW)	1990.09-1993.08	Saloon Engine B204E		o	GWB1314	
	1990.09-1993.08	Saloon Engine B204E With ABS	•		GHA235011	K
	1990.09-1993.08	Saloon Engine B204E Without ABS	•		GHA235008	K
	1990.09-1993.08	Saloon Engine B204E Without ABS	•		GHA235008	K
2.0 (140 kW)	1990.08-1993.09	Saloon Engine B204FT		o	GWB1314	
	1990.08-1993.09	Saloon Engine B204FT With ABS	•		GHA235011	K
	1990.08-1993.09	Saloon Engine B204FT Without ABS	•		GHA235008	K
	1990.08-1993.09	Saloon Engine B204FT Without ABS	•		GHA235008	K
2.3 Turbo (121 kW)	1990.09-1993.08	Saloon Engine B230FT		o	GWB1314	
	1990.09-1993.08	Saloon Engine B230FT With ABS	•		GHA235011	K
	1990.09-1993.08	Saloon Engine B230FT Without ABS	•		GHA235008	K
	1990.09-1993.08	Saloon Engine B230FT Without ABS	•		GHA235008	K
2.4 TD Interc. (85 kW)	1991.09-1994.07	Saloon Engine D24TIC		o	GWB1314	
	1991.09-1994.07	Saloon Engine D24TIC With ABS	•		GHA235011	K
	1991.09-1994.07	Saloon Engine D24TIC Without ABS	•		GHA235008	K
	1991.09-1994.07	Saloon Engine D24TIC Without ABS	•		GHA235008	K
2.8 GL (108 kW)	1990.09-1992.05	Saloon Engine B 280 F		o	GWB1314	
	1990.09-1992.05	Saloon Engine B 280 F With ABS	•		GHA235011	K



	 YEAR		F	R	G-AP Ref.	KIT
VOLVO						
960 (964)						
2.8 GL (108 kW)	1990.09-1992.05	Saloon Engine B 280 F Without ABS	•		GHA235008	K
	1990.09-1992.05	Saloon Engine B 280 F Without ABS	•		GHA235008	K
2.9 (150 kW)	1990.08-1994.07	Saloon Engine B6304F		○	GWB1314	
	1990.08-1994.07	Saloon Engine B6304F With ABS	•		GHA235011	K
	1990.08-1994.07	Saloon Engine B6304F Without ABS	•		GHA235008	K
	1990.08-1994.07	Saloon Engine B6304F Without ABS	•		GHA235008	K
960 II (964)						
2.5 (125 kW)	1994.07-1996.12	Saloon Engine B6254S	•		GHA235019	K
	1994.07-1996.12	Saloon Engine B6254S		○	GWB1314	
2.9 (150 kW)	1994.07-1996.12	Saloon Engine B6304S	•		GHA235019	K
	1994.07-1996.12	Saloon Engine B6304S		○	GWB1314	
960 II (965)						
2.5 (125 kW)	1994.08-1996.12	Estate Engine B6254S	•		GHA235019	K
	1994.08-1996.12	Estate Engine B6254S		○	GWB1314	
2.9 (150 kW)	1994.09-1996.12	Estate Engine B6304S	•		GHA235019	K
	1994.09-1996.12	Estate Engine B6304S		○	GWB1314	
960 KOMBI (965)						
2.0 (103 kW)	1990.09-1993.08	Estate Engine B204E		○	GWB1314	
	1990.09-1993.08	Estate Engine B204E With ABS	•		GHA235011	K
	1990.09-1993.08	Estate Engine B204E Without ABS	•		GHA235008	K
	1990.09-1993.08	Estate Engine B204E Without ABS	•		GHA235008	K
2.0 (140 kW)	1990.08-1993.09	Estate Engine B204FT		○	GWB1314	
	1990.08-1993.09	Estate Engine B204FT With ABS	•		GHA235011	K
	1990.08-1993.09	Estate Engine B204FT Without ABS	•		GHA235008	K
	1990.08-1993.09	Estate Engine B204FT Without ABS	•		GHA235008	K
2.3 Turbo (121 kW)	1990.09-1993.08	Estate Engine B230FT		○	GWB1314	
	1990.09-1993.08	Estate Engine B230FT With ABS	•		GHA235011	K
	1990.09-1993.08	Estate Engine B230FT Without ABS	•		GHA235008	K
	1990.09-1993.08	Estate Engine B230FT Without ABS	•		GHA235008	K
2.4 TD Interc. (85 kW)	1991.09-1994.07	Estate Engine D24TIC		○	GWB1314	
	1991.09-1994.07	Estate Engine D24TIC With ABS	•		GHA235011	K
	1991.09-1994.07	Estate Engine D24TIC Without ABS	•		GHA235008	K
	1991.09-1994.07	Estate Engine D24TIC Without ABS	•		GHA235008	K
2.4 TDi (90 kW)	1990.09-1993.08	Estate Engine D24TIC		○	GWB1314	
	1990.09-1993.08	Estate Engine D24TIC With ABS	•		GHA235011	K
	1990.09-1993.08	Estate Engine D24TIC Without ABS	•		GHA235008	K
	1990.09-1993.08	Estate Engine D24TIC Without ABS	•		GHA235008	K
2.8 (108 kW)	1990.09-1992.05	Estate Engine B 208 F		○	GWB1314	
	1990.09-1992.05	Estate Engine B 208 F With ABS	•		GHA235011	K
	1990.09-1992.05	Estate Engine B 208 F Without ABS	•		GHA235008	K
	1990.09-1992.05	Estate Engine B 208 F Without ABS	•		GHA235008	K
2.9 (150 kW)	1990.08-1994.07	Estate Engine B6304F/B6304S		○	GWB1314	
	1990.08-1994.07	Estate Engine B6304F/B6304S With ABS	•		GHA235011	K
	1990.08-1994.07	Estate Engine B6304F/B6304S Without ABS	•		GHA235008	K
	1990.08-1994.07	Estate Engine B6304F/B6304S Without ABS	•		GHA235008	K
C30						
1.6 (74 kW)	2006.10-2008.02	Hatchback Engine B4164S3	•		GHA336010	K
	2006.10-2008.02	Hatchback Engine B4164S3		○	GHA400174	K
1.6 D (80 kW)	2006.10-2008.02	Hatchback Engine D4164T	•		GHA336010	K
	2006.10-2008.02	Hatchback Engine D4164T		○	GHA400174	K
1.6 D2 (84 kW)	2010.10-2012.12	Hatchback Engine D4162T	•		GHA336010	K
	2010.10-2012.12	Hatchback Engine D4162T		○	GHA400174	K
1.8 (92 kW)	2006.10-2008.02	Hatchback Engine B4184S11	•		GHA336010	K
	2006.10-2008.02	Hatchback Engine B4184S11		○	GHA400174	K
1.8 FlexFuel (92 kW)	2007.01-2012.12	Hatchback Engine B4184S8	•		GHA336010	K
	2007.01-2012.12	Hatchback Engine B4184S8		○	GHA400174	K
2.0 (107 kW)	2006.10-2008.02	Hatchback Engine B4204S3	•		GHA336010	K
	2006.10-2008.02	Hatchback Engine B4204S3		○	GHA400174	K
2.0 D (100 kW)	2006.10-2008.02	Hatchback Engine D4204T	•		GHA336010	K
	2006.10-2008.02	Hatchback Engine D4204T		○	GHA400174	K
2.0 D3 (110 kW)	2010.10-2012.12	Hatchback Engine D5204T5	•		GHA336010	K
	2010.10-2012.12	Hatchback Engine D5204T5		○	GHA400174	K
2.0 D4 (130 kW)	2010.10-2012.12	Hatchback Engine D5204T	•		GHA336010	K
	2010.10-2012.12	Hatchback Engine D5204T		○	GHA400174	K



	 YEAR		F	R	G-AP Ref.	KIT
VOLVO						
C30						
2.0 FlexFuel (107 kW)	2010.01-2012.12	Hatchback Engine B4204S4	•		GHA336010	K
	2010.01-2012.12	Hatchback Engine B4204S4		◦	GHA400174	K
2.4 D5 (120 kW)	2006.10-2012.12	Hatchback Engine D5244T9	•		GHA336010	K
	2006.10-2012.12	Hatchback Engine D5244T9		◦	GHA400174	K
2.4 D5 (132 kW)	2006.10-2008.02	Hatchback Engine D5244T13/D5244T8	•		GHA336010	K
	2006.10-2008.02	Hatchback Engine D5244T13/D5244T8		◦	GHA400174	K
2.4 i (125 kW)	2006.10-2008.02	Hatchback Engine B5244S4	•		GHA336010	K
	2006.10-2008.02	Hatchback Engine B5244S4		◦	GHA400174	K
2.5 T5 (162 kW)	2006.10-2008.02	Hatchback Engine B5254T3	•		GHA336010	K
	2006.10-2008.02	Hatchback Engine B5254T3		◦	GHA400174	K
2.5 T5 (169 kW)	2007.07-2012.12	Hatchback Engine B5254T7	•		GHA336010	K
	2007.07-2012.12	Hatchback Engine B5254T7		◦	GHA400174	K
C70 I						
2.0 (132 kW)	1997.03-2002.09	Coupe Engine B5204T2	•		GHA326004	K
	1997.03-2002.09	Coupe Engine B5204T2	•		GHA336005	K
	1997.03-2002.09	Coupe Engine B5204T2		◦	GHA230109	K
	1998.03-2005.10	Convertible Engine B5204T2	•		GHA326004	K
	1998.03-2005.10	Convertible Engine B5204T2	•		GHA336005	K
	1998.03-2005.10	Convertible Engine B5204T2		◦	GHA230109	K
2.0 T (120 kW)	2000.03-2002.09	Coupe Engine B5204T4	•		GHA336005	K
	2000.03-2002.09	Coupe Engine B5204T4		◦	GHA230109	K
	2000.03-2005.10	Convertible Engine B5204T4	•		GHA336005	K
	2000.03-2005.10	Convertible Engine B5204T4		◦	GHA230109	K
2.0 T (166 kW)	1997.03-2002.09	Coupe Engine B5204T3	•		GHA326004	K
	1997.03-2002.09	Coupe Engine B5204T3	•		GHA336005	K
	1997.03-2002.09	Coupe Engine B5204T3		◦	GHA230109	K
	1998.03-2005.10	Convertible Engine B5204T3	•		GHA326004	K
	1998.03-2005.10	Convertible Engine B5204T3	•		GHA336005	K
	1998.03-2005.10	Convertible Engine B5204T3		◦	GHA230109	K
2.3 T5 (176 kW)	1997.03-2002.09	Coupe Engine B5234T3	•		GHA326004	K
	1997.03-2002.09	Coupe Engine B5234T3	•		GHA336005	K
	1997.03-2002.09	Coupe Engine B5234T3		◦	GHA230109	K
	1998.03-2005.10	Convertible Engine B5234T3	•		GHA326004	K
	1998.03-2005.10	Convertible Engine B5234T3	•		GHA336005	K
	1998.03-2005.10	Convertible Engine B5234T3		◦	GHA230109	K
2.3 T5 (180 kW)	2002.07-2005.10	Convertible Engine B5234T9	•		GHA336005	K
	2002.07-2005.10	Convertible Engine B5234T9		◦	GHA230109	K
2.4 T (147 kW)	1999.04-2002.08	Convertible Engine B5244T7	•		GHA336005	K
	1999.04-2002.08	Convertible Engine B5244T7		◦	GHA230109	K
2.5 (121 kW)	1999.03-2002.09	Coupe Engine B5254S	•		GHA336005	K
	1999.03-2002.09	Coupe Engine B5254S		◦	GHA230109	K
2.5 (125 kW)	1998.06-2005.10	Convertible Engine B5254S	•		GHA326004	K
	1998.06-2005.10	Convertible Engine B5254S	•		GHA336005	K
	1998.06-2005.10	Convertible Engine B5254S		◦	GHA230109	K
	1999.05-2002.09	Coupe Engine B5244S/B5254S	•		GHA336005	K
	1999.05-2002.09	Coupe Engine B5244S/B5254S		◦	GHA230109	K
2.5 T (142 kW)	1997.03-2002.09	Coupe Engine B5244T/B5254T	•		GHA326004	K
	1997.03-2002.09	Coupe Engine B5244T/B5254T	•		GHA336005	K
	1997.03-2002.09	Coupe Engine B5244T/B5254T		◦	GHA230109	K
	1998.03-2005.10	Convertible Engine B5244T/B5254T	•		GHA326004	K
	1998.03-2005.10	Convertible Engine B5244T/B5254T	•		GHA336005	K
	1998.03-2005.10	Convertible Engine B5244T/B5254T		◦	GHA230109	K
C70 II						
2.0 D (100 kW)	2008.01-	Convertible Engine D4204T	•		GHA336010	K
2.0 D3 (110 kW)	2010.10-	Convertible Engine D5204T5	•		GHA336010	K
2.0 D4 (130 kW)	2010.10-	Convertible Engine D5204T	•		GHA336010	K
2.4 (103 kW)	2006.03-	Convertible Engine B5244S5	•		GHA336010	K
2.4 D (120 kW)	2007.03-	Convertible Engine D5244T9	•		GHA336010	K
2.4 D5 (132 kW)	2006.06-2007.04	Convertible Engine D5244T8/D5244T13	•		GHA336010	K
2.4 i (125 kW)	2006.03-	Convertible Engine B5244S4	•		GHA336010	K
2.5 T5 (162 kW)	2006.03-	Convertible Engine B5254T3	•		GHA336010	K
2.5 T5 (169 kW)	2007.03-	Convertible Engine B5254T7	•		GHA336010	K
S40 I (VS)						
1.6 (77 kW)	1995.09-1999.08	Saloon Engine B4164S	•		GWB3443	



	 YEAR		F	R	G-AP Ref.	KIT
VOLVO						
S40 I (VS)						
1.6 (77 kW)	1995.09-1999.08	Saloon Engine B4164S	•		GWB3647	
	1995.09-1999.08	Saloon Engine B4164S		◦	GHA230071	K
1.6 (80 kW)	1999.03-2003.12	Saloon Engine B4164S2	•		GWB3647	
	1999.03-2003.12	Saloon Engine B4164S2		◦	GHA230071	K
1.8 (85 kW)	1995.07-1999.08	Saloon Engine B4184S/B4184S3	•		GWB3443	
	1995.07-1999.08	Saloon Engine B4184S/B4184S3	•		GWB3647	
	1995.07-1999.08	Saloon Engine B4184S/B4184S3		◦	GHA230071	K
	1998.09-1999.03	Saloon Engine B4184S2	•		GWB3647	
	1998.09-1999.03	Saloon Engine B4184S2		◦	GHA230071	K
1.8 (90 kW)	1999.03-2003.12	Saloon Engine B4184S2/B4184S9	•		GWB3647	
	1999.03-2003.12	Saloon Engine B4184S2/B4184S9		◦	GHA230071	K
1.8 i (90 kW)	2001.06-2003.12	Saloon Engine B4184SJ	•		GWB3647	
	2001.06-2003.12	Saloon Engine B4184SJ		◦	GHA230071	K
1.8 i (92 kW)	1998.03-2003.12	Saloon Engine B4184SM	•		GWB3647	
	1998.03-2003.12	Saloon Engine B4184SM		◦	GHA230071	K
1.9 Di (70 kW)	1999.03-2000.07	Saloon Engine D4192T2	•		GWB3647	
	1999.03-2000.07	Saloon Engine D4192T2		◦	GHA230071	K
1.9 Di (75 kW)	2000.07-2003.12	Saloon Engine D4192T4	•		GWB3647	
	2000.07-2003.12	Saloon Engine D4192T4		◦	GHA230071	K
1.9 Di (85 kW)	2000.07-2003.12	Saloon Engine D4192T3	•		GWB3647	
	2000.07-2003.12	Saloon Engine D4192T3		◦	GHA230071	K
1.9 T4 (147 kW)	1997.05-2000.07	Saloon Engine B4194T/B4194T2	•		GWB3443	
	1997.05-2000.07	Saloon Engine B4194T/B4194T2	•		GWB3647	
	1997.05-2000.07	Saloon Engine B4194T/B4194T2		◦	GHA230071	K
1.9 TD (66 kW)	1995.07-1999.08	Saloon Engine D4192T	•		GWB3443	
	1995.07-1999.08	Saloon Engine D4192T	•		GWB3647	
	1995.07-1999.08	Saloon Engine D4192T		◦	GHA230071	K
2.0 (100 kW)	1995.07-2003.12	Saloon Engine B4204S/B4204S2	•		GWB3443	
	1995.07-2003.12	Saloon Engine B4204S/B4204S2	•		GWB3647	
	1995.07-2003.12	Saloon Engine B4204S/B4204S2		◦	GHA230071	K
2.0 (103 kW)	1995.07-1999.08	Saloon Engine B4204S	•		GWB3443	
	1995.07-1999.08	Saloon Engine B4204S	•		GWB3647	
	1995.07-1999.08	Saloon Engine B4204S		◦	GHA230071	K
2.0 T (118 kW)	1997.10-2003.12	Saloon Engine B4204T	•		GWB3647	
	1997.10-2003.12	Saloon Engine B4204T		◦	GHA230071	K
2.0 T (120 kW)	2001.06-2003.12	Saloon Engine B4204T3	•		GWB3647	
	2001.06-2003.12	Saloon Engine B4204T3		◦	GHA230071	K
2.0 T (121 kW)	2000.07-2001.06	Saloon Engine B4204T3	•		GWB3647	
	2000.07-2001.06	Saloon Engine B4204T3		◦	GHA230071	K
2.0 T4 (147 kW)	2000.07-2003.12	Saloon Engine B4204T5	•		GWB3647	
	2000.07-2003.12	Saloon Engine B4204T5		◦	GHA230071	K
S40 II (MS)						
1.6 (74 kW)	2004.11-2007.04	Saloon Engine B4164S3	•		GHA336010	K
	2004.11-2007.04	Saloon Engine B4164S3		◦	GHA400174	K
1.6 D (81 kW)	2004.11-2007.04	Saloon Engine D4164T	•		GHA336010	K
	2004.11-2007.04	Saloon Engine D4164T		◦	GHA400174	K
1.6 D2 (84 kW)	2010.10-	Saloon Engine D4162T	•		GHA336010	K
	2010.10-	Saloon Engine D4162T		◦	GHA400174	K
1.8 (92 kW)	2004.01-2008.02	Saloon Engine B4184S11	•		GHA336010	K
	2004.01-2008.02	Saloon Engine B4184S11		◦	GHA400174	K
1.8 FlexFuel (92 kW)	2006.01-	Saloon Engine B4184S8	•		GHA336010	K
	2006.01-	Saloon Engine B4184S8		◦	GHA400174	K
2.0 (107 kW)	2004.06-2007.06	Saloon Engine B4204S3	•		GHA336010	K
	2004.06-2007.06	Saloon Engine B4204S3		◦	GHA400174	K
2.0 D (100 kW)	2004.01-2007.06	Saloon Engine D4204T	•		GHA336010	K
	2004.01-2007.06	Saloon Engine D4204T		◦	GHA400174	K
2.0 D3 (110 kW)	2010.10-	Saloon Engine D5204T5	•		GHA336010	K
	2010.10-	Saloon Engine D5204T5		◦	GHA400174	K
2.0 D4 (130 kW)	2010.10-	Saloon Engine D5204T	•		GHA336010	K
	2010.10-	Saloon Engine D5204T		◦	GHA400174	K
2.0 D4 (96 kW)	2005.07-	Saloon Engine D 4204 T2	•		GHA336010	K
	2005.07-	Saloon Engine D 4204 T2		◦	GHA400174	K
2.0 F (107 kW)	2006.10-	Saloon Engine B4204S4	•		GHA336010	K
	2006.10-	Saloon Engine B4204S4		◦	GHA400174	K



	 YEAR		F	R	G-AP Ref.	KIT
VOLVO						
S40 II (MS)						
2.4 (103 kW)	2004.01-	Saloon Engine B5244S5	•		GHA336010	K
	2004.01-	Saloon Engine B5244S5		◦	GHA400174	K
2.4 (125 kW)	2004.01-2007.04	Saloon Engine B5244S	•		GHA336010	K
	2004.01-2007.04	Saloon Engine B5244S		◦	GHA400174	K
2.4 AWD (125 kW)	2006.08-	Saloon Engine B 5244 S4	•		GHA336010	K
2.4 D5 (132 kW)	2006.04-2007.06	Saloon Engine D5244T8	•		GHA336010	K
	2006.04-2007.06	Saloon Engine D5244T8		◦	GHA400174	K
2.5 T5 (162 kW)	2004.01-2007.04	Saloon Engine B5254T3	•		GHA336010	K
	2004.01-2007.04	Saloon Engine B5254T3		◦	GHA400174	K
2.5 T5 (169 kW)	2007.05-2008.02	Saloon Engine B5254T7	•		GHA336010	K
	2007.05-2008.02	Saloon Engine B5254T7		◦	GHA400174	K
2.5 T5 AWD (162 kW)	2004.04-	Saloon Engine B5254T3	•		GHA336010	K
2.5 T5 AWD (169 kW)	2007.03-	Saloon Engine B5254T7	•		GHA336010	K
S60						
2.0 T (132 kW)	2001.09-2010.04	Saloon Engine B5204T5	•		GHA336006	K
	2001.09-2010.04	Saloon Engine B5204T5		◦	GHA400109	K
2.3 T5 (184 kW)	2000.11-2010.04	Saloon Engine B5234T3	•		GHA336006	K
	2000.11-2010.04	Saloon Engine B5234T3		◦	GHA400109	K
2.3 T5 (195 kW)	2000.07-2002.09	Saloon Engine B5234T7	•		GHA336006	K
	2000.07-2002.09	Saloon Engine B5234T7		◦	GHA400109	K
2.4 (103 kW)	2000.11-2010.04	Saloon Engine B5244S2	•		GHA336006	K
	2000.11-2010.04	Saloon Engine B5244S2		◦	GHA400109	K
2.4 (125 kW)	2000.11-2010.04	Saloon Engine B5244S	•		GHA336006	K
	2000.11-2010.04	Saloon Engine B5244S		◦	GHA400109	K
2.4 Bifuel (103 kW)	2002.06-2010.04	Saloon Engine B5244SG	•		GHA336006	K
	2002.06-2010.04	Saloon Engine B5244SG		◦	GHA400109	K
2.4 D (120 kW)	2005.09-2009.01	Saloon Engine D5244T5	•		GHA336006	K
	2005.09-2009.01	Saloon Engine D5244T5		◦	GHA400109	K
2.4 D (93 kW)	2005.09-2010.04	Saloon Engine D5244T7	•		GHA336006	K
	2005.09-2010.04	Saloon Engine D5244T7		◦	GHA400109	K
2.4 D (96 kW)	2001.12-2010.04	Saloon Engine D5244T2	•		GHA336006	K
	2001.12-2010.04	Saloon Engine D5244T2		◦	GHA400109	K
2.4 D5 (120 kW)	2001.07-2010.04	Saloon Engine D5244T	•		GHA336006	K
	2001.07-2010.04	Saloon Engine D5244T		◦	GHA400109	K
2.4 D5 (136 kW)	2005.05-2007.11	Saloon Engine D5244T4	•		GHA336006	K
	2005.05-2007.11	Saloon Engine D5244T4		◦	GHA400109	K
2.4 T (147 kW)	2000.11-2010.04	Saloon Engine B5244T3	•		GHA336006	K
	2000.11-2010.04	Saloon Engine B5244T3		◦	GHA400109	K
2.4 T AWD (147 kW)	2001.11-2010.04	Saloon Engine B5244T3	•		GHA336006	K
	2001.11-2010.04	Saloon Engine B5244T3		◦	GHA336014	K
2.4 T5 (191 kW)	2004.05-2007.11	Saloon Engine B5244T5	•		GHA336006	K
	2004.05-2007.11	Saloon Engine B5244T5		◦	GHA400109	K
2.5 T (154 kW)	2003.03-2007.11	Saloon Engine B5254T2	•		GHA336006	K
	2003.03-2007.11	Saloon Engine B5254T2		◦	GHA400109	K
2.5 T AWD (154 kW)	2004.04-2010.04	Saloon Engine B5254T2	•		GHA336006	K
	2004.04-2010.04	Saloon Engine B5254T2		◦	GHA336014	K
R 2.5 T AWD (221 kW)	2003.03-2010.04	Saloon Engine B5254T4	•		GHA336006	K
	2003.03-2010.04	Saloon Engine B5254T4		◦	GHA336014	K
S60 I						
2.4 AWD (191 kW)	2004.02-2010.04	Saloon Engine B 5244 T5	•		GHA336006	K
	2004.02-2010.04	Saloon Engine B 5244 T5		◦	GHA336014	K
S60 II						
1.5 T3 (112 kW)	2015.03-	Saloon Engine B 4154 T4	•		GHA340003	K
	2015.03-	Saloon Engine B 4154 T4		◦	GHA400253	K
1.6 Drive/D2 (84 kW)	2011.01-	Saloon Engine D4162T	•		GHA340003	K
	2011.01-	Saloon Engine D4162T		◦	GHA400253	K
1.6 T3 (110 kW)	2010.04-	Saloon Engine B4164T3	•		GHA340003	K
	2010.04-	Saloon Engine B4164T3		◦	GHA400253	K
1.6 T4 (132 kW)	2010.04-	Saloon Engine B4164T	•		GHA340003	K
	2010.04-	Saloon Engine B4164T		◦	GHA400253	K
1.6 T4F (132 kW)	2011.04-	Saloon Engine B4164T2	•		GHA340003	K
	2011.04-	Saloon Engine B4164T2		◦	GHA400253	K
2.0 D2 (88 kW)	2015.03-	Saloon Engine D 4204 T20	•		GHA340003	K
	2015.03-	Saloon Engine D 4204 T20		◦	GHA400253	K



	 YEAR		F	R	G-AP Ref.	KIT
VOLVO						
S60 II						
2.0 D3 (100 kW)	2012.05-	Saloon Engine D5204T7	•		GHA340003	K
	2012.05-	Saloon Engine D5204T7		◦	GHA400253	K
2.0 D3 (110 kW)	2015.03-	Saloon Engine D 4204 T9	•		GHA340003	K
	2015.03-	Saloon Engine D 4204 T9		◦	GHA400253	K
2.0 D3 (120 kW)	2010.04-2012.04	Saloon Engine D5204T2/D5204T3	•		GHA340003	K
	2010.04-2012.04	Saloon Engine D5204T2/D5204T3		◦	GHA400253	K
2.0 D4 (120 kW)	2012.05-	Saloon Engine D5204T3	•		GHA340003	K
	2012.05-	Saloon Engine D5204T3		◦	GHA400253	K
2.0 D4 (140 kW)	2015.03-	Saloon Engine D 4204 T14	•		GHA340003	K
	2015.03-	Saloon Engine D 4204 T14		◦	GHA400253	K
2.0 D5 (165 kW)	2015.03-	Saloon Engine D 4204 T11	•		GHA340003	K
	2015.03-	Saloon Engine D 4204 T11		◦	GHA400253	K
2.0 T (132 kW)	2013.12-	Saloon Engine B 5204 T8	•		GHA340003	K
	2013.12-	Saloon Engine B 5204 T8		◦	GHA400253	K
2.0 T (149 kW)	2010.04-	Saloon Engine B4204T6	•		GHA340003	K
	2010.04-	Saloon Engine B4204T6		◦	GHA400253	K
2.0 T3 (112 kW)	2015.03-	Saloon Engine B 4204 T37	•		GHA340003	K
	2015.03-	Saloon Engine B 4204 T37		◦	GHA400253	K
2.0 T4 (140 kW)	2015.05-	Saloon Engine B 4204 T19	•		GHA340003	K
	2015.05-	Saloon Engine B 4204 T19		◦	GHA400253	K
2.0 T5 (177 kW)	2010.04-	Saloon Engine B4204T7	•		GHA340003	K
	2010.04-	Saloon Engine B4204T7		◦	GHA400253	K
2.4 D4 AWD (140 kW)	2015.03-	Saloon Engine D 5244 T21	•		GHA340003	K
	2015.03-	Saloon Engine D 5244 T21		◦	GHA336016	K
2.4 D5 (151 kW)	2010.04-	Saloon Engine D5244T10	•		GHA340003	K
	2010.04-	Saloon Engine D5244T10		◦	GHA400253	K
2.4 D5 (158 kW)	2011.06-	Saloon Engine D5244T11/D5244T15	•		GHA340003	K
	2011.06-	Saloon Engine D5244T11/D5244T15		◦	GHA400253	K
2.4 D5 AWD (151 kW)	2010.04-	Saloon Engine D5244T10	•		GHA340003	K
	2010.04-	Saloon Engine D5244T10		◦	GHA336016	K
2.4 D5 AWD (158 kW)	2011.06-	Saloon Engine D5244T11/D5244T15	•		GHA340003	K
	2011.06-	Saloon Engine D5244T11/D5244T15		◦	GHA336016	K
2.5 T5 (186 kW)	2011.09-	Saloon Engine B 5254 T5	•		GHA340003	K
	2011.09-	Saloon Engine B 5254 T5		◦	GHA400253	K
2.5 T5 AWD (186 kW)	2012.09-	Saloon Engine B 5254 T5	•		GHA340003	K
	2012.09-	Saloon Engine B 5254 T5		◦	GHA336016	K
3.0 T AWD (258 kW)	2014.05-	Saloon Engine B 6304 T5	•		GHA340003	K
	2014.05-	Saloon Engine B 6304 T5		◦	GHA336016	K
3.0 T6 AWD (224 kW)	2010.04-	Saloon Engine B6304T4	•		GHA340003	K
	2010.04-	Saloon Engine B6304T4		◦	GHA336016	K
D4 (133 kW)	2013.09-	Saloon Engine D 4204 T5	•		GHA340003	K
	2013.09-	Saloon Engine D 4204 T5		◦	GHA400253	K
D5 (169 kW)	2014.04-	Saloon Engine D 5244 T23	•		GHA340003	K
	2014.04-	Saloon Engine D 5244 T23		◦	GHA400253	K
D5 AWD (169 kW)	2014.04-	Saloon Engine D 5244 T23	•		GHA340003	K
	2014.04-	Saloon Engine D 5244 T23		◦	GHA336016	K
T5 (180 kW)	2013.09-	Saloon Engine B 4204 T11	•		GHA340003	K
	2013.09-	Saloon Engine B 4204 T11		◦	GHA400253	K
T5 AWD (187 kW)	2015.08-	Saloon Engine B 5254 T12	•		GHA340003	K
	2015.08-	Saloon Engine B 5254 T12		◦	GHA336016	K
T6 (225 kW)	2013.09-	Saloon Engine B 4204 T9	•		GHA340003	K
	2013.09-	Saloon Engine B 4204 T9		◦	GHA400253	K
T6 AWD (242 kW)	2014.04-	Saloon Engine B 6304 T3/B 6304 T4	•		GHA340003	K
	2014.04-	Saloon Engine B 6304 T3/B 6304 T4		◦	GHA336016	K
S70 (LS)						
2.0 (105 kW)	1997.01-2000.11	Saloon Engine B5204F	•		GHA326004	K
	1997.01-2000.11	Saloon Engine B5204F	•		GHA336005	K
	1997.01-2000.11	Saloon Engine B5204F		◦	GHA230109	K
2.0 (120 kW)	1997.01-2000.11	Saloon Engine B5204T4	•		GHA326004	K
	1997.01-2000.11	Saloon Engine B5204T4	•		GHA336005	K
	1997.01-2000.11	Saloon Engine B5204T4		◦	GHA230109	K
2.0 (132 kW)	1997.01-2000.11	Saloon Engine B5204T2	•		GHA326004	K
	1997.01-2000.11	Saloon Engine B5204T2	•		GHA336005	K
	1997.01-2000.11	Saloon Engine B5204T2		◦	GHA230109	K



	 YEAR		F	R	G-AP Ref.	KIT	
VOLVO							
S70 (LS)							
2.0 (93 kW)	1997.01-2000.11	Saloon Engine B5202S	•		GHA326004	K	
	1997.01-2000.11	Saloon Engine B5202S	•		GHA336005	K	
	1997.01-2000.11	Saloon Engine B5202S		◦	GHA230109	K	
2.0 Turbo (155 kW)	1997.01-2000.11	Saloon Engine B5204T	•		GHA326004	K	
	1997.01-2000.11	Saloon Engine B5204T	•		GHA336005	K	
	1997.01-2000.11	Saloon Engine B5204T		◦	GHA230109	K	
2.0 Turbo (166 kW)	1997.01-2000.11	Saloon Engine B5204T3	•		GHA326004	K	
	1997.01-2000.11	Saloon Engine B5204T3	•		GHA336005	K	
	1997.01-2000.11	Saloon Engine B5204T3		◦	GHA230109	K	
2.3 (177 kW)	1996.11-2000.11	Saloon Engine B5234T3	•		GHA326004	K	
	2.3 (195 kW)	1999.04-2000.09	Saloon Engine B 5234 T7	•		GHA326004	K
		1999.04-2000.09	Saloon Engine B 5234 T7	•		GHA336005	K
2.3 T5 (176 kW)	1999.04-2000.09	Saloon Engine B 5234 T7		◦	GHA230109	K	
	1997.01-2000.11	Saloon Engine B5234T3	•		GHA326004	K	
	1997.01-2000.11	Saloon Engine B5234T3	•		GHA336005	K	
2.3 T5 AWD (177 kW)	1997.01-2000.11	Saloon Engine B5234T3		◦	GHA230109	K	
	1996.11-1998.09	Saloon Engine B5234T3	•		GHA326004	K	
	1996.11-1998.09	Saloon Engine B5234T3	•		GHA336005	K	
2.3 T5 AWD (184 kW)	1996.11-1998.09	Saloon Engine B5234T3		◦	GWB1314		
	1997.07-2000.09	Saloon Engine B 5234 T4	•		GHA326004	K	
	1997.07-2000.09	Saloon Engine B 5234 T4	•		GHA336005	K	
2.3 Turbo (184 kW)	1997.07-2000.09	Saloon Engine B 5234 T4		◦	GWB1314		
	1997.01-2000.11	Saloon Engine B5234FT+	•		GHA326004	K	
	1997.01-2000.11	Saloon Engine B5234FT+	•		GHA336005	K	
2.4 (103 kW)	1997.01-2000.11	Saloon Engine B5234FT+		◦	GHA230109	K	
	1999.08-2000.11	Saloon Engine B5244S2/B5244SG	•		GHA326004	K	
	1999.08-2000.11	Saloon Engine B5244S2/B5244SG	•		GHA336005	K	
2.4 (125 kW)	1999.08-2000.11	Saloon Engine B5244S2/B5244SG		◦	GHA230109	K	
	1997.01-2000.11	Saloon Engine B5244S	•		GHA326004	K	
	1997.01-2000.11	Saloon Engine B5244S	•		GHA336005	K	
2.4 AWD (103 kW)	1997.01-2000.11	Saloon Engine B5244S		◦	GHA230109	K	
	1999.04-2000.09	Saloon Engine B5244S2	•		GHA326004	K	
	1999.04-2000.09	Saloon Engine B5244S2	•		GHA336005	K	
2.4 AWD (106 kW)	1999.04-2000.09	Saloon Engine B5244S2		◦	GWB1314		
	1996.11-1999.05	Saloon Engine B5252FS	•		GHA326004	K	
	1996.11-1999.05	Saloon Engine B5252FS	•		GHA336005	K	
2.4 AWD (121 kW)	1996.11-1999.05	Saloon Engine B5252FS		◦	GWB1314		
	1998.10-1999.05	Saloon Engine B5254S	•		GHA326004	K	
	1998.10-1999.05	Saloon Engine B5254S	•		GHA336005	K	
2.4 AWD (125 kW)	1998.10-1999.05	Saloon Engine B5254S		◦	GWB1314		
	1999.04-2000.09	Saloon Engine B5244S	•		GHA326004	K	
	1999.04-2000.09	Saloon Engine B5244S	•		GHA336005	K	
2.4 Blu-Fuel (103 kW)	1999.04-2000.09	Saloon Engine B5244S		◦	GWB1314		
	1997.07-2000.09	Saloon Engine B 5244 S2/B 5244 SG	•		GHA326004	K	
	1997.07-2000.09	Saloon Engine B 5244 S2/B 5244 SG	•		GHA336005	K	
2.4 T5 AWD (142 kW)	1997.07-2000.09	Saloon Engine B 5244 S2/B 5244 SG		◦	GHA230109	K	
	1996.11-1999.04	Saloon Engine B5254T	•		GHA326004	K	
	1996.11-1999.04	Saloon Engine B5254T	•		GHA336005	K	
2.4 Turbo (142 kW)	1996.11-1999.04	Saloon Engine B5254T		◦	GWB1314		
	1997.01-2000.11	Saloon Engine B5244T/B5254T	•		GHA326004	K	
	1997.01-2000.11	Saloon Engine B5244T/B5254T	•		GHA336005	K	
2.5 (106 kW)	1997.01-2000.11	Saloon Engine B5244T/B5254T		◦	GHA230109	K	
	1997.01-2000.11	Saloon Engine B5252FS	•		GHA326004	K	
	1997.01-2000.11	Saloon Engine B5252FS	•		GHA336005	K	
2.5 (121 kW)	1997.01-2000.11	Saloon Engine B5252FS		◦	GHA230109	K	
	1998.06-2000.11	Saloon Engine B5254S	•		GHA326004	K	
	1998.06-2000.11	Saloon Engine B5254S	•		GHA336005	K	
2.5 Bifuel (103 kW)	1998.06-2000.11	Saloon Engine B5254S		◦	GHA230109	K	
	1999.07-2000.11	Saloon Engine B5244SG	•		GHA326004	K	
	1999.07-2000.11	Saloon Engine B5244SG	•		GHA336005	K	
2.5 Bifuel (106 kW)	1999.07-2000.11	Saloon Engine B5244SG		◦	GHA230109	K	
	1998.10-2000.11	Saloon Engine GB5252S	•		GHA326004	K	
	1998.10-2000.11	Saloon Engine GB5252S	•		GHA336005	K	
	1998.10-2000.11	Saloon Engine GB5252S		◦	GHA230109	K	



	 YEAR		F	R	G-AP Ref.	KIT
VOLVO						
S70 (LS)						
2.5 TDi (103 kW)	1997.01-2000.11	Saloon Engine D5252T	•		GHA326004	K
	1997.01-2000.11	Saloon Engine D5252T	•		GHA336005	K
	1997.01-2000.11	Saloon Engine D5252T		◦	GHA230109	K
2.5 TDi AWD (103 kW)	1999.10-2000.09	Saloon Engine D 5252 T	•		GHA326004	K
	1999.10-2000.09	Saloon Engine D 5252 T	•		GHA336005	K
	1999.10-2000.09	Saloon Engine D 5252 T		◦	GWB1314	
S80 I (TS, XY)						
2.0 (120 kW)	1998.06-2006.07	Saloon Engine B5204T4	•		GHA336006	K
	1998.06-2006.07	Saloon Engine B5204T4	•		GHA336006	S
	1998.06-2006.07	Saloon Engine B5204T4		◦	GHA400109	K
2.0 T (132 kW)	1999.12-2006.07	Saloon Engine B5204T5	•		GHA336006	K
	1999.12-2006.07	Saloon Engine B5204T5	•		GHA336006	S
	1999.12-2006.07	Saloon Engine B5204T5		◦	GHA400109	K
2.0 T (166 kW)	1998.06-2006.07	Saloon Engine B5204T3	•		GHA336006	K
	1998.06-2006.07	Saloon Engine B5204T3	•		GHA336006	S
	1998.06-2006.07	Saloon Engine B5204T3		◦	GHA400109	K
2.4 (103 kW)	1999.01-2006.07	Saloon Engine B5244S2	•		GHA336006	K
	1999.01-2006.07	Saloon Engine B5244S2	•		GHA336006	S
	1999.01-2006.07	Saloon Engine B5244S2		◦	GHA400109	K
2.4 (125 kW)	1999.01-2006.07	Saloon Engine B5244S	•		GHA336006	K
	1999.01-2006.07	Saloon Engine B5244S	•		GHA336006	S
	1999.01-2006.07	Saloon Engine B5244S		◦	GHA400109	K
2.4 Bifuel (103 kW)	2001.09-2006.07	Saloon Engine B5244SG2	•		GHA336006	K
	2001.09-2006.07	Saloon Engine B5244SG2	•		GHA336006	S
	2001.09-2006.07	Saloon Engine B5244SG2		◦	GHA400109	K
2.4 D (96 kW)	2001.10-2006.07	Saloon Engine D5244T2	•		GHA336006	K
	2001.10-2006.07	Saloon Engine D5244T2	•		GHA336006	S
	2001.10-2006.07	Saloon Engine D5244T2		◦	GHA400109	K
2.4 D5 (120 kW)	2001.08-2006.07	Saloon Engine D5244T	•		GHA336006	K
	2001.08-2006.07	Saloon Engine D5244T	•		GHA336006	S
	2001.08-2006.07	Saloon Engine D5244T		◦	GHA400109	K
2.4 LTP (132 kW)	2004.06-2006.07	Saloon Engine B5244T4	•		GHA336006	K
	2004.06-2006.07	Saloon Engine B5244T4	•		GHA336006	S
	2004.06-2006.07	Saloon Engine B5244T4		◦	GHA400109	K
2.4 T (147 kW)	2000.06-2006.07	Saloon Engine B5244T3	•		GHA336006	K
	2000.06-2006.07	Saloon Engine B5244T3	•		GHA336006	S
	2000.06-2006.07	Saloon Engine B5244T3		◦	GHA400109	K
2.4 T5 AWD (147 kW)	2000.04-2003.09	Saloon Engine B5244T3	•		GHA336006	K
	2000.04-2003.09	Saloon Engine B5244T3	•		GHA336006	S
	2000.04-2003.09	Saloon Engine B5244T3		◦	GHA336014	K
2.5 T (154 kW)	2003.03-2006.02	Saloon Engine B5254T2	•		GHA336006	K
	2003.03-2006.02	Saloon Engine B5254T2	•		GHA336006	S
	2003.03-2006.02	Saloon Engine B5254T2		◦	GHA400109	K
2.5 T AWD (154 kW)	2003.07-2006.07	Saloon Engine B5254T2	•		GHA336006	K
	2003.07-2006.07	Saloon Engine B5254T2	•		GHA336006	S
	2003.07-2006.07	Saloon Engine B5254T2		◦	GHA336014	K
2.5 TDi (103 kW)	1999.01-2006.07	Saloon Engine D5252T	•		GHA336006	K
	1999.01-2006.07	Saloon Engine D5252T	•		GHA336006	S
	1999.01-2006.07	Saloon Engine D5252T		◦	GHA400109	K
2.8 T6 (200 kW)	1998.05-2006.07	Saloon Engine B6284T	•		GHA336006	K
	1998.05-2006.07	Saloon Engine B6284T	•		GHA336006	S
	1998.05-2006.07	Saloon Engine B6284T		◦	GHA400109	K
2.9 (147 kW)	1999.03-2006.07	Saloon Engine B6294S	•		GHA336006	K
	1999.03-2006.07	Saloon Engine B6294S	•		GHA336006	S
	1999.03-2006.07	Saloon Engine B6294S		◦	GHA400109	K
2.9 (150 kW)	1998.05-2006.07	Saloon Engine B6304S3	•		GHA336006	K
	1998.05-2006.07	Saloon Engine B6304S3	•		GHA336006	S
	1998.05-2006.07	Saloon Engine B6304S3		◦	GHA400109	K
3.0 (144 kW)	2001.06-2006.07	Saloon Engine B6294S2	•		GHA336006	K
	2001.06-2006.07	Saloon Engine B6294S2	•		GHA336006	S
	2001.06-2006.07	Saloon Engine B6294S2		◦	GHA400109	K
3.0 T6 (200 kW)	2001.06-2006.07	Saloon Engine B6294T	•		GHA336006	K
	2001.06-2006.07	Saloon Engine B6294T	•		GHA336006	S
	2001.06-2006.07	Saloon Engine B6294T		◦	GHA400109	K



	 YEAR		F	R	G-AP Ref.	KIT
VOLVO						
S80 II (AS)						
1.6 D Drive (80 kW)	2010.01-	Saloon Engine D4164T	•		GHA340003	K
	2010.01-	Saloon Engine D4164T		◦	GHA400253	K
1.6 Drive (84 kW)	2011.06-	Saloon Engine D4162T	•		GHA340003	K
	2011.06-	Saloon Engine D4162T		◦	GHA400253	K
1.6 T4 (132 kW)	2010.10-	Saloon Engine B4164T	•		GHA340003	K
	2010.10-	Saloon Engine B4164T		◦	GHA400253	K
1.6 T4F (132 kW)	2011.05-	Saloon Engine B4164T2	•		GHA340003	K
	2011.05-	Saloon Engine B4164T2		◦	GHA400253	K
2.0 (107 kW)	2008.01-	Saloon Engine B4204S3	•		GHA340003	K
	2008.01-	Saloon Engine B4204S3		◦	GHA400253	K
2.0 D3/D4 (120 kW)	2010.01-	Saloon Engine D5204T2/D5204T3	•		GHA340003	K
	2010.01-	Saloon Engine D5204T2/D5204T3		◦	GHA400253	K
2.0 FlexFuel (107 kW)	2008.01-	Saloon Engine B4204S4	•		GHA340003	K
	2008.01-	Saloon Engine B4204S4		◦	GHA400253	K
2.0 T (149 kW)	2010.01-	Saloon Engine B4204T6	•		GHA340003	K
	2010.01-	Saloon Engine B4204T6		◦	GHA400253	K
2.0 T5 (177 kW)	2010.10-	Saloon Engine B4204T7	•		GHA340003	K
	2010.10-	Saloon Engine B4204T7		◦	GHA400253	K
2.0 TDi (100 kW)	2008.02-	Saloon Engine D4204T	•		GHA340003	K
	2008.02-	Saloon Engine D4204T		◦	GHA400253	K
2.4 D (120 kW)	2006.03-2007.01	Saloon Engine D5244T/D5244T5	•		GHA340003	K
	2006.03-2007.01	Saloon Engine D5244T/D5244T5		◦	GHA400253	K
2.4 D (129 kW)	2010.01-	Saloon Engine D5244T14	•		GHA340003	K
	2010.01-	Saloon Engine D5244T14		◦	GHA400253	K
2.4 D5 (136 kW)	2006.03-2007.01	Saloon Engine D5244T4	•		GHA340003	K
	2006.03-2007.01	Saloon Engine D5244T4		◦	GHA400253	K
2.4 D5 (151 kW)	2010.01-	Saloon Engine D5244T10	•		GHA340003	K
	2010.01-	Saloon Engine D5244T10		◦	GHA400253	K
2.4 D5 (158 kW)	2011.06-	Saloon Engine D5244T11/D5244T15	•		GHA340003	K
	2011.06-	Saloon Engine D5244T11/D5244T15		◦	GHA400253	K
2.4 D5 AWD (136 kW)	2007.01-	Saloon Engine D5244T4	•		GHA340003	K
	2007.01-	Saloon Engine D5244T4		◦	GHA336016	K
2.4 D5 AWD (151 kW)	2010.01-	Saloon Engine D5244T10	•		GHA340003	K
	2010.01-	Saloon Engine D5244T10		◦	GHA336016	K
2.4 D5 AWD (158 kW)	2011.06-	Saloon Engine D5244T11/D5244T15	•		GHA340003	K
	2011.06-	Saloon Engine D5244T11/D5244T15		◦	GHA336016	K
2.5 T (147 kW)	2006.03-2007.01	Saloon Engine B5254T6	•		GHA340003	K
	2006.03-2007.01	Saloon Engine B5254T6		◦	GHA400253	K
2.5 T (170 kW)	2010.01-	Saloon Engine B5254T10	•		GHA340003	K
	2010.01-	Saloon Engine B5254T10		◦	GHA400253	K
2.5 T (183 kW)	2012.09-	Saloon Engine B 5254 T14	•		GHA340003	K
	2012.09-	Saloon Engine B 5254 T14		◦	GHA400253	K
2.5 T (187 kW)	2012.01-	Saloon Engine B 5254 T12	•		GHA340003	K
	2012.01-	Saloon Engine B 5254 T12		◦	GHA400253	K
2.5 T AWD (147 kW)	2006.10-	Saloon Engine B5254T6	•		GHA340003	K
	2006.10-	Saloon Engine B5254T6		◦	GHA336016	K
2.5 T FlexFuel (147 kW)	2008.05-	Saloon Engine B5254T8	•		GHA340003	K
	2008.05-	Saloon Engine B5254T8		◦	GHA400253	K
2.5 T FlexFuel (170 kW)	2010.01-	Saloon Engine B5254T11	•		GHA340003	K
	2010.01-	Saloon Engine B5254T11		◦	GHA400253	K
3.0 T6 AWD (210 kW)	2007.01-	Saloon Engine B6304T2	•		GHA340003	K
	2007.01-	Saloon Engine B6304T2		◦	GHA336016	K
3.0 T6 AWD (224 kW)	2010.10-	Saloon Engine B6304T4	•		GHA340003	K
	2010.10-	Saloon Engine B6304T4		◦	GHA336016	K
3.2 (175 kW)	2006.03-2007.01	Saloon Engine B6324S	•		GHA340003	K
	2006.03-2007.01	Saloon Engine B6324S		◦	GHA400253	K
3.2 (179 kW)	2010.01-	Saloon Engine B6324S5	•		GHA340003	K
	2010.01-	Saloon Engine B6324S5		◦	GHA400253	K
3.2 AWD (175 kW)	2007.01-	Saloon Engine B6324S	•		GHA340003	K
	2007.01-	Saloon Engine B6324S		◦	GHA336016	K
3.2 AWD (179 kW)	2010.01-	Saloon Engine B6324S5	•		GHA340003	K
	2010.01-	Saloon Engine B6324S5		◦	GHA336016	K
4.4 V8 AWD (232 kW)	2006.03-2007.01	Saloon Engine B8444S	•		GHA340003	K
	2006.03-2007.01	Saloon Engine B8444S		◦	GHA336016	K



	 YEAR		F	R	G-AP Ref.	KIT
VOLVO						
S90						
2.5 (125 kW)	1996.11-1998.1	Saloon Engine B 6254 FS	•		GHA235019	K
	1996.11-1998.1	Saloon Engine B 6254 FS		◦	GWB1314	
2.5 (132 kW)	1996.11-1997.1	Saloon Engine B 6244 FS	•		GHA235019	K
	1996.11-1997.1	Saloon Engine B 6244 FS		◦	GWB1314	
2.9 (132 kW)	1997.01-1998.05	Saloon Engine B6304S2	•		GHA235019	K
	1997.01-1998.05	Saloon Engine B6304S2		◦	GWB1314	
2.9 (150 kW)	1997.01-1998.05	Saloon Engine B6304G	•		GHA235019	K
	1997.01-1998.05	Saloon Engine B6304G		◦	GWB1314	
V40 (VW)						
1.6 (77 kW)	1995.12-1999.08	Estate Engine B4164S	•		GWB3443	
	1995.12-1999.08	Estate Engine B4164S	•		GWB3647	
	1995.12-1999.08	Estate Engine B4164S		◦	GHA230071	K
1.6 (80 kW)	1999.03-2004.06	Estate Engine B4164S2	•		GWB3647	
	1999.03-2004.06	Estate Engine B4164S2		◦	GHA230071	K
1.8 (85 kW)	1995.07-1999.08	Estate Engine B4184S/B4184S3	•		GWB3443	
	1995.07-1999.08	Estate Engine B4184S/B4184S3	•		GWB3647	
	1995.07-1999.08	Estate Engine B4184S/B4184S3		◦	GHA230071	K
1.8 (90 kW)	1999.03-2004.06	Estate Engine B4184S2/B4184S9	•		GWB3647	
	1999.03-2004.06	Estate Engine B4184S2/B4184S9		◦	GHA230071	K
1.8 i (90 kW)	2001.06-2004.06	Estate Engine B4184SJ	•		GWB3647	
	2001.06-2004.06	Estate Engine B4184SJ		◦	GHA230071	K
1.8 i (92 kW)	1998.03-2004.06	Estate Engine B4184SM	•		GWB3647	
	1998.03-2004.06	Estate Engine B4184SM		◦	GHA230071	K
1.9 Di (70 kW)	1999.03-2000.07	Estate Engine D4192T2	•		GWB3647	
	1999.03-2000.07	Estate Engine D4192T2		◦	GHA230071	K
1.9 Di (75 kW)	2000.07-2004.06	Estate Engine D4192T4	•		GWB3647	
	2000.07-2004.06	Estate Engine D4192T4		◦	GHA230071	K
1.9 Di (85 kW)	2000.07-2004.06	Estate Engine D4192T3	•		GWB3647	
	2000.07-2004.06	Estate Engine D4192T3		◦	GHA230071	K
1.9 T4 (147 kW)	1997.05-2000.07	Estate Engine B4194T	•		GWB3443	
	1997.05-2000.07	Estate Engine B4194T	•		GWB3647	
	1997.05-2000.07	Estate Engine B4194T		◦	GHA230071	K
1.9 TD (66 kW)	1995.07-1999.08	Estate Engine D4192T	•		GWB3443	
	1995.07-1999.08	Estate Engine D4192T	•		GWB3647	
	1995.07-1999.08	Estate Engine D4192T		◦	GHA230071	K
2.0 (100 kW)	1995.07-2004.06	Estate Engine B4204S/B4204S2	•		GWB3443	
	1995.07-2004.06	Estate Engine B4204S/B4204S2	•		GWB3647	
	1995.07-2004.06	Estate Engine B4204S/B4204S2		◦	GHA230071	K
2.0 (103 kW)	1995.07-1999.08	Estate Engine B4204S	•		GWB3443	
	1995.07-1999.08	Estate Engine B4204S	•		GWB3647	
	1995.07-1999.08	Estate Engine B4204S		◦	GHA230071	K
2.0 T (118 kW)	1997.10-2004.01	Estate Engine B4204T	•		GWB3647	
	1997.10-2004.01	Estate Engine B4204T		◦	GHA230071	K
2.0 T (120 kW)	2001.06-2004.06	Estate Engine B4204T3	•		GWB3647	
	2001.06-2004.06	Estate Engine B4204T3		◦	GHA230071	K
2.0 T (121 kW)	1999.07-2004.06	Estate Engine B4204T2	•		GWB3647	
	1999.07-2004.06	Estate Engine B4204T2		◦	GHA230071	K
2.0 T4 (147 kW)	2000.07-2004.06	Estate Engine B4204T5	•		GWB3647	
	2000.07-2004.06	Estate Engine B4204T5		◦	GHA230071	K
V50 (MW)						
1.6 (74 kW)	2007.02-2007.04	Estate Engine B4164S3	•		GHA336010	K
	2007.02-2007.04	Estate Engine B4164S3		◦	GHA400174	K
1.6 D (81 kW)	2007.02-2007.04	Estate Engine D4164T	•		GHA336010	K
	2007.02-2007.04	Estate Engine D4164T		◦	GHA400174	K
1.6 D2 (84 kW)	2010.01-	Estate Engine D4162T	•		GHA336010	K
	2010.01-	Estate Engine D4162T		◦	GHA400174	K
1.8 (92 kW)	2004.04-	Estate Engine B4184S11	•		GHA336010	K
	2004.04-	Estate Engine B4184S11		◦	GHA400174	K
1.8 FlexFuel (92 kW)	2005.01-	Estate Engine B4184S8	•		GHA336010	K
	2005.01-	Estate Engine B4184S8		◦	GHA400174	K
2.0 (107 kW)	2006.10-	Estate Engine B4204S3	•		GHA336010	K
	2006.10-	Estate Engine B4204S3		◦	GHA400174	K
2.0 D (100 kW)	2004.04-	Estate Engine D4204T	•		GHA336010	K
	2004.04-	Estate Engine D4204T		◦	GHA400174	K



	 YEAR		F	R	G-AP Ref.	KIT
VOLVO						
V50 (MW)						
2.0 D3 (110 kW)	2010.10-	Estate Engine D5204T5	•		GHA336010	K
	2010.10-	Estate Engine D5204T5		◦	GHA400174	K
2.0 D4 (130 kW)	2010.10-	Estate Engine D5204T	•		GHA336010	K
	2010.10-	Estate Engine D5204T		◦	GHA400174	K
2.0 FlexFuel (107 kW)	2010.01-	Estate Engine B4204S4	•		GHA336010	K
	2010.01-	Estate Engine B4204S4		◦	GHA400174	K
2.4 (103 kW)	2004.04-	Estate Engine B5244S5	•		GHA336010	K
	2004.04-	Estate Engine B5244S5		◦	GHA400174	K
2.4 (125 kW)	2004.04-	Estate Engine B5244S4	•		GHA336010	K
	2004.04-	Estate Engine B5244S4		◦	GHA400174	K
2.4 AWD (125 kW)	2006.08-	Estate Engine B 5244 S4	•		GHA336010	K
2.4 D5 (132 kW)	2006.04-2008.02	Estate Engine D5244T8/D5244T13	•		GHA336010	K
	2006.04-2008.02	Estate Engine D5244T8/D5244T13		◦	GHA400174	K
2.4 TDi (120 kW)	2007.05-	Estate Engine D5244T9	•		GHA336010	K
	2007.05-	Estate Engine D5244T9		◦	GHA400174	K
2.5 T5 (162 kW)	2004.04-	Estate Engine B5254T3	•		GHA336010	K
	2004.04-	Estate Engine B5254T3		◦	GHA400174	K
2.5 T5 (169 kW)	2007.05-2008.02	Estate Engine B5254T7	•		GHA336010	K
	2007.05-2008.02	Estate Engine B5254T7		◦	GHA400174	K
2.5 T5 AWD (162 kW)	2004.04-	Estate Engine B5254T3	•		GHA336010	K
2.5 T5 AWD (169 kW)	2007.03-	Estate Engine B5254T7	•		GHA336010	K
V60						
1.6 Drive (84 kW)	2011.06-	Estate Engine D4162T	•		GHA340003	K
	2011.06-	Estate Engine D4162T		◦	GHA400253	K
1.6 T3 (110 kW)	2010.09-	Estate Engine B4164T3	•		GHA340003	K
	2010.09-	Estate Engine B4164T3		◦	GHA400253	K
1.6 T4 (132 kW)	2010.09-	Estate Engine B4164T	•		GHA340003	K
	2010.09-	Estate Engine B4164T		◦	GHA400253	K
1.6 T4F (132 kW)	2011.04-	Estate Engine B4164T2	•		GHA340003	K
	2011.04-	Estate Engine B4164T2		◦	GHA400253	K
2.0 D2 (88 kW)	2015.03-	Estate Engine D 4204 T20	•		GHA340003	K
	2015.03-	Estate Engine D 4204 T20		◦	GHA400253	K
2.0 D3 (110 kW)	2015.03-	Estate Engine D 4204 T4	•		GHA340003	K
	2015.03-	Estate Engine D 4204 T4		◦	GHA400253	K
2.0 D3/D4 (120 kW)	2010.09-	Estate Engine D5204T2/D5204T3	•		GHA340003	K
	2010.09-	Estate Engine D5204T2/D5204T3		◦	GHA400253	K
2.0 D4 (140 kW)	2015.03-	Estate Engine D 4204 T14	•		GHA340003	K
	2015.03-	Estate Engine D 4204 T14		◦	GHA400253	K
2.0 T (149 kW)	2010.09-	Estate Engine B4204T6	•		GHA340003	K
	2010.09-	Estate Engine B4204T6		◦	GHA400253	K
2.0 T4 (140 kW)	2015.05-	Estate Engine B 4204 T19	•		GHA340003	K
	2015.05-	Estate Engine B 4204 T19		◦	GHA400253	K
2.0 T5 (177 kW)	2010.09-	Estate Engine B4204T7	•		GHA340003	K
	2010.09-	Estate Engine B4204T7		◦	GHA400253	K
2.4 D5 (151 kW)	2010.09-	Estate Engine D5244T10	•		GHA340003	K
	2010.09-	Estate Engine D5244T10		◦	GHA400253	K
2.4 D5 (158 kW)	2011.06-	Estate Engine D5244T11/D5244T15	•		GHA340003	K
	2011.06-	Estate Engine D5244T11/D5244T15		◦	GHA400253	K
2.4 D5 AWD (151 kW)	2010.09-	Estate Engine D5244T10	•		GHA340003	K
	2010.09-	Estate Engine D5244T10		◦	GHA336016	K
2.4 D5 AWD (158 kW)	2011.06-	Estate Engine D5244T11/D5244T15	•		GHA340003	K
	2011.06-	Estate Engine D5244T11/D5244T15		◦	GHA336016	K
2.4 D5 Hybrid AWD (120 kW)	2015.03-	Estate Engine D87PHEV	•		GHA340003	K
	2015.03-	Estate Engine D87PHEV		◦	GHA336016	K
2.4 Hybrid AWD (158 kW)	2012.06-	Estate Engine D5244T15/D82PHEV	•		GHA340003	K
	2012.06-	Estate Engine D5244T15/D82PHEV		◦	GHA400253	K
3.0 T AWD (258 kW)	2014.05-	Estate Engine B 6304 T5	•		GHA340003	K
	2014.05-	Estate Engine B 6304 T5		◦	GHA336016	K
3.0 T6 AWD (224 kW)	2010.09-	Estate Engine B6304T4	•		GHA340003	K
	2010.09-	Estate Engine B6304T4		◦	GHA336016	K
D3 (100 kW)	2012.12-	Estate Engine D 5204 T7	•		GHA340003	K
	2012.12-	Estate Engine D 5204 T7		◦	GHA400253	K
D4 (133 kW)	2013.10-	Estate Engine D 4204 T5	•		GHA340003	K
	2013.10-	Estate Engine D 4204 T5		◦	GHA400253	K

	 YEAR		F	R	G-AP Ref.	KIT
VOLVO						
V60						
D4 AWD (120 kW)	2012.12-	Estate Engine D 5244 T17	•		GHA340003	K
	2012.12-	Estate Engine D 5244 T17		◦	GHA336016	K
D4 AWD (133 kW)	2013.10-	Estate Engine D 5244 T12	•		GHA340003	K
	2013.10-	Estate Engine D 5244 T12		◦	GHA336016	K
D4 AWD (140 kW)	2015.03-	Estate Engine D 5244 T21	•		GHA340003	K
	2015.03-	Estate Engine D 5244 T21		◦	GHA336016	K
D5 (165 kW)	2015.03-	Estate Engine D 4204 T11	•		GHA340003	K
	2015.03-	Estate Engine D 4204 T11		◦	GHA400253	K
D5 (169 kW)	2014.04-	Estate Engine D 5244 T23	•		GHA340003	K
	2014.04-	Estate Engine D 5244 T23		◦	GHA400253	K
D5 AWD (169 kW)	2014.04-	Estate Engine D 5244 T15/D 5244 T23	•		GHA340003	K
	2014.04-	Estate Engine D 5244 T15/D 5244 T23		◦	GHA336016	K
D6 HybriD AWD (162 kW)	2015.03-	Estate Engine D97PHEV	•		GHA340003	K
	2015.03-	Estate Engine D97PHEV		◦	GHA336016	K
T3 (112 kW)	2015.03-	Estate Engine B 4154 T4	•		GHA340003	K
	2015.03-	Estate Engine B 4154 T4		◦	GHA400253	K
	2015.03-	Estate Engine B 4204 T37	•		GHA340003	K
	2015.03-	Estate Engine B 4204 T37		◦	GHA400253	K
T5 (157 kW)	2014.04-	Estate Engine B 5204 T9	•		GHA340003	K
	2014.04-	Estate Engine B 5204 T9		◦	GHA400253	K
T5 (176 kW)	2012.08-	Estate Engine B 4204 T7	•		GHA340003	K
	2012.08-	Estate Engine B 4204 T7		◦	GHA400253	K
T5 (180 kW)	2013.10-	Estate Engine B 4204 T11	•		GHA340003	K
	2013.10-	Estate Engine B 4204 T11		◦	GHA400253	K
T6 (187 kW)	2015.08-	Estate Engine B 5254 T12	•		GHA340003	K
	2015.08-	Estate Engine B 5254 T12		◦	GHA336016	K
T6 (225 kW)	2013.10-	Estate Engine B 4204 T9	•		GHA340003	K
	2013.10-	Estate Engine B 4204 T9		◦	GHA400253	K
T6 AWD (242 kW)	2014.04-	Estate Engine B 6304 T3/B 6304 T4	•		GHA340003	K
	2014.04-	Estate Engine B 6304 T3/B 6304 T4		◦	GHA336016	K
V70 (LV)						
2.0 (105 kW)	1997.01-2000.03	Estate Engine B5204F	•		GHA326004	K
	1997.01-2000.03	Estate Engine B5204F	•		GHA336005	K
	1997.01-2000.03	Estate Engine B5204F		◦	GHA230109	K
2.0 (120 kW)	1997.01-2000.03	Estate Engine B5204T4	•		GHA326004	K
	1997.01-2000.03	Estate Engine B5204T4	•		GHA336005	K
	1997.01-2000.03	Estate Engine B5204T4		◦	GHA230109	K
2.0 (132 kW)	1997.01-2000.03	Estate Engine B5204T2	•		GHA326004	K
	1997.01-2000.03	Estate Engine B5204T2	•		GHA336005	K
	1997.01-2000.03	Estate Engine B5204T2		◦	GHA230109	K
2.0 (93 kW)	1997.01-2000.03	Estate Engine B5202S	•		GHA326004	K
	1997.01-2000.03	Estate Engine B5202S	•		GHA336005	K
	1997.01-2000.03	Estate Engine B5202S		◦	GHA230109	K
2.0 Turbo (155 kW)	1997.01-2000.03	Estate Engine B5204T	•		GHA326004	K
	1997.01-2000.03	Estate Engine B5204T	•		GHA336005	K
	1997.01-2000.03	Estate Engine B5204T		◦	GHA230109	K
2.0 Turbo (166 kW)	1997.01-2000.03	Estate Engine B5204T3	•		GHA326004	K
	1997.01-2000.03	Estate Engine B5204T3	•		GHA336005	K
	1997.01-2000.03	Estate Engine B5204T3		◦	GHA230109	K
2.0 Turbo AWD (166 kW)	1997.01-2000.03	Estate Engine B5204T3	•		GHA326004	K
	1997.01-2000.03	Estate Engine B5204T3	•		GHA336005	K
	1997.01-2000.03	Estate Engine B5204T3		◦	GWB1314	
2.3 AWD (177 kW)	1997.04-1998.09	Estate Engine B5234T3	•		GHA326004	K
	1997.04-1998.09	Estate Engine B5234T3	•		GHA336005	K
	1997.04-1998.09	Estate Engine B5234T3		◦	GWB1314	
2.3 T AWD (184 kW)	1997.04-2000.03	Estate Engine B5234FT+/B5234T4	•		GHA326004	K
	1997.04-2000.03	Estate Engine B5234FT+/B5234T4	•		GHA336005	K
	1997.04-2000.03	Estate Engine B5234FT+/B5234T4		◦	GWB1314	
2.3 T5 (176 kW)	1997.01-2000.03	Estate Engine B5234T3	•		GHA326004	K
	1997.01-2000.03	Estate Engine B5234T3	•		GHA336005	K
	1997.01-2000.03	Estate Engine B5234T3		◦	GHA230109	K
2.3 T5 AWD (176 kW)	1997.01-2000.03	Estate Engine B5234T3	•		GHA326004	K
	1997.01-2000.03	Estate Engine B5234T3	•		GHA336005	K
	1997.01-2000.03	Estate Engine B5234T3		◦	GWB1314	

	 YEAR		F	R	G-AP Ref.	KIT
VOLVO						
V70 (LV)						
2.3 Turbo (184 kW)	1997.01-2000.03	Estate Engine B5234FT+	•		GHA326004	K
	1997.01-2000.03	Estate Engine B5234FT+	•		GHA336005	K
	1997.01-2000.03	Estate Engine B5234FT+		○	GHA230109	K
2.4 (103 kW)	1999.08-2000.05	Estate Engine B5244S2/B5244SG2	•		GHA336005	K
	1999.08-2000.05	Estate Engine B5244S2/B5244SG2		○	GHA230109	K
2.4 (125 kW)	1997.01-2000.05	Estate Engine B5254S/B5244S	•		GHA326004	K
	1997.01-2000.05	Estate Engine B5254S/B5244S	•		GHA336005	K
	1997.01-2000.05	Estate Engine B5254S/B5244S		○	GHA230109	K
2.4 AWD (121 kW)	1998.10-1999.05	Estate Engine B5254S	•		GHA336005	K
	1998.10-1999.05	Estate Engine B5254S		○	GWB1314	
2.4 Bifuel (103 kW)	1999.08-2000.03	Estate Engine B5244SG	•		GHA336005	K
	1999.08-2000.03	Estate Engine B5244SG		○	GHA230109	K
2.4 Turbo (142 kW)	1997.01-2000.03	Estate Engine B5244T/B5254T	•		GHA326004	K
	1997.01-2000.03	Estate Engine B5244T/B5254T	•		GHA336005	K
	1997.01-2000.03	Estate Engine B5244T/B5254T		○	GHA230109	K
2.5 (106 kW)	1997.01-2000.03	Estate Engine B5252FS	•		GHA326004	K
	1997.01-2000.03	Estate Engine B5252FS	•		GHA336005	K
	1997.01-2000.03	Estate Engine B5252FS		○	GHA230109	K
2.5 (121 kW)	1998.06-2000.03	Estate Engine B5254S	•		GHA326004	K
	1998.06-2000.03	Estate Engine B5254S	•		GHA336005	K
	1998.06-2000.03	Estate Engine B5254S		○	GHA230109	K
2.5 AWD (195 kW)	1999.03-2000.03	Estate Engine B5244T2	•		GHA336005	K
	1999.03-2000.03	Estate Engine B5244T2		○	GWB1314	
2.5 Bifuel (106 kW)	1998.10-1999.08	Estate Engine GB5252S	•		GHA336005	K
	1998.10-1999.08	Estate Engine GB5252S		○	GHA230109	K
2.5 TDi (103 kW)	1997.01-2000.05	Estate Engine D5252T	•		GHA326004	K
	1997.01-2000.05	Estate Engine D5252T	•		GHA336005	K
	1997.01-2000.05	Estate Engine D5252T		○	GHA230109	K
2.5 TDi AWD (103 kW)	1996.11-2000.02	Estate Engine D5252T	•		GHA326004	K
	1996.11-2000.02	Estate Engine D5252T	•		GHA336005	K
	1996.11-2000.02	Estate Engine D5252T		○	GWB1314	
2.5 Turbo AWD (142 kW)	1997.01-2000.05	Estate Engine B5244T/B5254T	•		GHA326004	K
	1997.01-2000.05	Estate Engine B5244T/B5254T	•		GHA336005	K
	1997.01-2000.05	Estate Engine B5244T/B5254T		○	GWB1314	
V70 I (LV)						
2.3 AWD (195 kW)	1998.12-2000.02	Estate Engine B 5234 T7/B 5234 T8	•		GHA336005	K
	1998.12-2000.02	Estate Engine B 5234 T7/B 5234 T8		○	GWB1314	
V70 II (SW)						
2.0 T (132 kW)	2001.07-2007.08	Estate Engine B5204T5	•		GHA336006	K
	2001.07-2007.08	Estate Engine B5204T5		○	GHA400109	K
2.3 (195 kW)	2000.10-2004.09	Estate Engine B5234T7	•		GHA336006	K
	2000.10-2004.09	Estate Engine B5234T7		○	GHA400109	K
2.3 AWD (195 kW)	2000.10-2004.09	Estate Engine B 5234 T7/B 5234 T8	•		GHA336006	K
	2000.10-2004.09	Estate Engine B 5234 T7/B 5234 T8		○	GHA336014	K
2.3 T5 (184 kW)	2000.03-2007.08	Estate Engine B5234T3/B5234T4	•		GHA336006	K
	2000.03-2007.08	Estate Engine B5234T3/B5234T4		○	GHA400109	K
2.4 (103 kW)	2000.03-2007.08	Estate Engine B5244S2	•		GHA336006	K
	2000.03-2007.08	Estate Engine B5244S2		○	GHA400109	K
2.4 (121 kW)	2000.03-2003.09	Estate	•		GHA336006	K
	2000.03-2003.09	Estate		○	GHA400109	K
2.4 (125 kW)	2000.03-2007.08	Estate Engine B5244S	•		GHA336006	K
	2000.03-2007.08	Estate Engine B5244S		○	GHA400109	K
2.4 AWD (121 kW)	2000.03-2003.09	Estate Engine B 5254 S	•		GHA336006	K
	2000.03-2003.09	Estate Engine B 5254 S		○	GHA336014	K
2.4 Bifuel (103 kW)	2001.09-2007.08	Estate Engine B5244SG2	•		GHA336006	K
	2001.09-2007.08	Estate Engine B5244SG2		○	GHA400109	K
2.4 D (93 kW)	2005.05-2007.08	Estate Engine D5244T7	•		GHA336006	K
	2005.05-2007.08	Estate Engine D5244T7		○	GHA400109	K
2.4 D (96 kW)	2001.12-2007.08	Estate Engine D5244T2	•		GHA336006	K
	2001.12-2007.08	Estate Engine D5244T2		○	GHA400109	K
2.4 D5 (120 kW)	2001.08-2007.08	Estate Engine D5244T/D5244T5	•		GHA336006	K
	2001.08-2007.08	Estate Engine D5244T/D5244T5		○	GHA400109	K
2.4 D5 (136 kW)	2005.05-2007.04	Estate Engine D5244T4	•		GHA336006	K
	2005.05-2007.04	Estate Engine D5244T4		○	GHA400109	K

	 YEAR		F	R	G-AP Ref.	KIT
VOLVO						
V70 II (SW)						
2.4 D5 AWD (120 kW)	2003.03-2007.08	Estate Engine D5244T/D5244T2/D5244T5	•		GHA336006	K
	2003.03-2007.08	Estate Engine D5244T/D5244T2/D5244T5		◦	GHA336014	K
2.4 D5 AWD (136 kW)	2005.05-2007.04	Estate Engine D5244T4	•		GHA336006	K
	2005.05-2007.04	Estate Engine D5244T4		◦	GHA336014	K
2.4 T (147 kW)	2000.03-2007.08	Estate Engine B5244T3	•		GHA336006	K
	2000.03-2007.08	Estate Engine B5244T3		◦	GHA400109	K
2.4 T AWD (147 kW)	2001.09-2007.08	Estate Engine B5244T3	•		GHA336006	K
	2001.09-2007.08	Estate Engine B5244T3		◦	GHA336014	K
2.4 T5 (191 kW)	2005.05-2007.04	Estate Engine B5244T5	•		GHA336006	K
	2005.05-2007.04	Estate Engine B5244T5		◦	GHA400109	K
2.5 R Sport (221 kW)	2006.04-2007.04	Estate Engine B5254T4	•		GHA336006	K
	2006.04-2007.04	Estate Engine B5254T4		◦	GHA336014	K
2.5 T (154 kW)	2002.09-2007.10	Estate Engine B5254T2	•		GHA336006	K
	2002.09-2007.10	Estate Engine B5254T2		◦	GHA400109	K
2.5 T AWD (154 kW)	2002.09-2007.08	Estate Engine B5254T2	•		GHA336006	K
	2002.09-2007.08	Estate Engine B5254T2		◦	GHA336014	K
2.5 TDi (103 kW)	2000.03-2007.08	Estate Engine D5252T	•		GHA336006	K
	2000.03-2007.08	Estate Engine D5252T		◦	GHA400109	K
R 2,5 T AWD (221 kW)	2003.03-2007.08	Estate Engine B5254T4	•		GHA336006	K
	2003.03-2007.08	Estate Engine B5254T4		◦	GHA336014	K
V70 III (BW)						
1.6 D (80 kW)	2010.01-	Estate Engine D4164T	•		GHA340003	K
	2010.01-	Estate Engine D4164T		◦	GHA400253	K
1.6 Drive/D2 (84 kW)	2011.06-	Estate Engine D4162T	•		GHA340003	K
	2011.06-	Estate Engine D4162T		◦	GHA400253	K
1.6 T4 (132 kW)	2010.10-	Estate Engine B4164T	•		GHA340003	K
	2010.10-	Estate Engine B4164T		◦	GHA400253	K
1.6 T4F (132 kW)	2011.01-	Estate Engine B4164T2	•		GHA340003	K
	2011.01-	Estate Engine B4164T2		◦	GHA400253	K
2.0 (107 kW)	2007.11-	Estate Engine B4204S3	•		GHA340003	K
	2007.11-	Estate Engine B4204S3		◦	GHA400253	K
2.0 D (100 kW)	2007.10-	Estate Engine D4204T	•		GHA340003	K
	2007.10-	Estate Engine D4204T		◦	GHA400253	K
2.0 D3/D4 (120 kW)	2010.03-	Estate Engine D5204T2/D5204T3	•		GHA340003	K
	2010.03-	Estate Engine D5204T2/D5204T3		◦	GHA400253	K
2.0 FlexFuel (107 kW)	2008.01-	Estate Engine B4204S4	•		GHA340003	K
	2008.01-	Estate Engine B4204S4		◦	GHA400253	K
2.0 T (149 kW)	2010.01-	Estate Engine B4204T6	•		GHA340003	K
	2010.01-	Estate Engine B4204T6		◦	GHA400253	K
2.0 T5 (177 kW)	2010.01-	Estate Engine B4204T7	•		GHA340003	K
	2010.01-	Estate Engine B4204T7		◦	GHA400253	K
2.4 D (120 kW)	2007.08-	Estate Engine D5244T5	•		GHA340003	K
	2007.08-	Estate Engine D5244T5		◦	GHA400253	K
2.4 D (129 kW)	2009.10-	Estate Engine D5244T14	•		GHA340003	K
	2009.10-	Estate Engine D5244T14		◦	GHA400253	K
2.4 D5 (136 kW)	2007.08-	Estate Engine D5244T4	•		GHA340003	K
	2007.08-	Estate Engine D5244T4		◦	GHA400253	K
2.4 D5 (151 kW)	2009.12-	Estate Engine D5244T10	•		GHA340003	K
	2009.12-	Estate Engine D5244T10		◦	GHA400253	K
2.4 D5 (158 kW)	2011.06-	Estate Engine D5244T11/D5244T15	•		GHA340003	K
	2011.06-	Estate Engine D5244T11/D5244T15		◦	GHA400253	K
2.4 D5 AWD (136 kW)	2007.10-	Estate Engine D5244T4	•		GHA340003	K
	2007.10-	Estate Engine D5244T4		◦	GHA336016	K
2.4 D5 AWD (151 kW)	2009.12-	Estate Engine D5244T10	•		GHA340003	K
	2009.12-	Estate Engine D5244T10		◦	GHA336016	K
2.4 D5 AWD (158 kW)	2011.06-	Estate Engine D5244T11/D5244T15	•		GHA340003	K
	2011.06-	Estate Engine D5244T11/D5244T15		◦	GHA336016	K
2.5 T (147 kW)	2007.08-	Estate Engine B5254T6	•		GHA340003	K
	2007.08-	Estate Engine B5254T6		◦	GHA400253	K
2.5 T (170 kW)	2010.01-	Estate Engine B5254T10	•		GHA340003	K
	2010.01-	Estate Engine B5254T10		◦	GHA400253	K
2.5 T FlexFuel (147 kW)	2008.05-	Estate Engine B5254T8	•		GHA340003	K
	2008.05-	Estate Engine B5254T8		◦	GHA400253	K
2.5 T FlexFuel (170 kW)	2009.10-	Estate Engine B5254T11	•		GHA340003	K

	 YEAR		F	R	G-AP Ref.	KIT
VOLVO						
V70 III (BW)						
2.5 T FlexFuel (170 kW)	2009.10-	Estate Engine B5254T11		o	GHA400253	K
3.0 T6 AWD (210 kW)	2007.08-	Estate Engine B6304T2	•		GHA340003	K
	2007.08-	Estate Engine B6304T2		o	GHA336016	K
3.0 T6 AWD (224 kW)	2011.04-	Estate Engine B6304T4	•		GHA340003	K
	2011.04-	Estate Engine B6304T4		o	GHA336016	K
3.2 (175 kW)	2007.11-	Estate Engine B6324S	•		GHA340003	K
	2007.11-	Estate Engine B6324S		o	GHA400253	K
3.2 (179 kW)	2011.05-	Estate Engine B6324S5	•		GHA340003	K
	2011.05-	Estate Engine B6324S5		o	GHA400253	K
3.2 AWD (175 kW)	2007.08-	Estate Engine B6324S	•		GHA340003	K
	2007.08-	Estate Engine B6324S		o	GHA336016	K
3.2 AWD (179 kW)	2011.05-	Estate Engine B6324S5	•		GHA340003	K
	2011.05-	Estate Engine B6324S5		o	GHA336016	K
V90						
2.5 (125 kW)	1996.11-1998.1	Estate Engine B 6254 FS	•		GHA235019	K
	1996.11-1998.1	Estate Engine B 6254 FS		o	GWB1314	
2.5 (132 kW)	1996.11-1997.1	Estate Engine B 6244 FS	•		GHA235019	K
	1996.11-1997.1	Estate Engine B 6244 FS		o	GWB1314	
2.9 (132 kW)	1997.01-1998.12	Estate Engine B6304S2	•		GHA235019	K
	1997.01-1998.12	Estate Engine B6304S2		o	GWB1314	
2.9 (150 kW)	1997.01-1998.12	Estate Engine B6304G	•		GHA235019	K
	1997.01-1998.12	Estate Engine B6304G		o	GWB1314	
XC60						
2.0 D3/D4 (120 kW)	2010.03-	Estate Engine D5204T2/D5204T3	•		GHA340003	K
	2010.03-	Estate Engine D5204T2/D5204T3		o	GHA336015	K
2.0 T (149 kW)	2010.03-	Estate Engine B4204T6	•		GHA340003	K
2.0 T5 (177 kW)	2010.09-	Estate Engine B4204T7	•		GHA340003	K
2.4 D (129 kW)	2009.07-	Estate Engine D5244T14	•		GHA340003	K
2.4 D/D3/D4 AWD (120 kW)	2008.05-	Estate Engine D5244T5/D5244T16/D5244T17	•		GHA340003	K
	2008.05-	Estate Engine D5244T5/D5244T16/D5244T17		o	GHA336015	K
2.4 D5 (158 kW)	2011.06-	Estate Engine D5244T11	•		GHA340003	K
2.4 D5 AWD (136 kW)	2008.05-	Estate Engine D5244T4	•		GHA340003	K
	2008.05-	Estate Engine D5244T4		o	GHA336015	K
2.4 D5 AWD (151 kW)	2009.07-	Estate Engine D5244T10	•		GHA340003	K
	2009.07-	Estate Engine D5244T10		o	GHA336015	K
2.4 D5 AWD (158 kW)	2011.06-	Estate Engine D5244T11/D5244T15	•		GHA340003	K
3.0 T6 AWD (210 kW)	2008.05-	Estate Engine B6304T2	•		GHA340003	K
	2008.05-	Estate Engine B6304T2		o	GHA336015	K
3.0 T6 AWD (224 kW)	2010.03-	Estate Engine B6304T4	•		GHA340003	K
	2010.03-	Estate Engine B6304T4		o	GHA336015	K
3.2 AWD (175 kW)	2009.07-	Estate Engine B6324S	•		GHA340003	K
3.2 AWD (179 kW)	2010.03-	Estate Engine B6324S5	•		GHA340003	K
	2010.03-	Estate Engine B6324S5		o	GHA336015	K
D3 (100 kW)	2012.04-	Estate Engine D 5204 T7	•		GHA340003	K
XC70 CROSS COUNTRY						
2.4 D5 AWD (136 kW)	2005.05-2008.04	Estate Engine D5244T4	•		GHA336006	K
	2005.05-2008.04	Estate Engine D5244T4		o	GHA336014	K
2.4 D5 XC AWD (120 kW)	2002.09-2007.08	Estate Engine D5244T	•		GHA336006	K
	2002.09-2007.08	Estate Engine D5244T		o	GHA336014	K
2.4 T XC AWD (142 kW)	1997.11-2002.09	Estate Engine B5254T	•		GHA336005	K
	1997.11-2002.09	Estate Engine B5254T		o	GWB1314	
2.4 T XC AWD (147 kW)	2000.03-2002.09	Estate Engine B5244T3	•		GHA336006	K
	2000.03-2002.09	Estate Engine B5244T3		o	GHA336014	K
2.5 T XC AWD (154 kW)	2002.09-2007.10	Estate Engine B5254T2	•		GHA336006	K
	2002.09-2007.10	Estate Engine B5254T2		o	GHA336014	K
XC70 II						
2.0 D3 (120 kW)	2011.08-	Estate Engine D5204T2/D5204T3	•		GHA340003	K
	2011.08-	Estate Engine D5204T2/D5204T3		o	GHA400253	K
2.0 D3 AWD (120 kW)	2011.08-	Estate Engine D5204T2	•		GHA340003	K
	2011.08-	Estate Engine D5204T2		o	GHA336016	K
2.4 D (129 kW)	2010.01-	Estate Engine D5244T14	•		GHA340003	K
	2010.01-	Estate Engine D5244T14		o	GHA400253	K
2.4 D/D4 AWD (120 kW)	2007.08-	Estate Engine D5244T5/D5244T16/D5244T17	•		GHA340003	K
	2007.08-	Estate Engine D5244T5/D5244T16/D5244T17		o	GHA336016	K

	 YEAR		F	R	G-AP Ref.	KIT
VOLVO						
XC70 II						
2.4 D5 AWD (136 kW)	2007.08-	Estate Engine D5244T4	•		GHA340003	K
	2007.08-	Estate Engine D5244T4		◦	GHA336016	K
2.4 D5 AWD (151 kW)	2009.12-	Estate Engine D5244T10	•		GHA340003	K
	2009.12-	Estate Engine D5244T10		◦	GHA336016	K
2.4 D5 AWD (158 kW)	2011.06-	Estate Engine D5244T11/D5244T15	•		GHA340003	K
	2011.06-	Estate Engine D5244T11/D5244T15		◦	GHA336016	K
3.0 T6 AWD (210 kW)	2008.01-	Estate Engine B6304T2	•		GHA340003	K
	2008.01-	Estate Engine B6304T2		◦	GHA336016	K
3.0 T6 AWD (224 kW)	2010.01-	Estate Engine B6304T4	•		GHA340003	K
	2010.01-	Estate Engine B6304T4		◦	GHA336016	K
3.2 (179 kW)	2007.08-	Estate Engine B6324S5	•		GHA340003	K
	2007.08-	Estate Engine B6324S5		◦	GHA400253	K
3.2 AWD (175 kW)	2007.08-	Estate Engine B6324S	•		GHA340003	K
	2007.08-	Estate Engine B6324S		◦	GHA336016	K
3.2 AWD (179 kW)	2007.08-	Estate Engine B6324S5	•		GHA340003	K
	2007.08-	Estate Engine B6324S5		◦	GHA336016	K
D4 (133 kW)	2013.10-	Estate Engine D 4204 T5	•		GHA340003	K
	2013.10-	Estate Engine D 4204 T5		◦	GHA400253	K
D4 AWD (133 kW)	2013.10-	Estate Engine D 5244 T12	•		GHA340003	K
	2013.10-	Estate Engine D 5244 T12		◦	GHA336016	K
D5 AWD (162 kW)	2015.03-	Estate Engine D 5244 T20	•		GHA340003	K
	2015.03-	Estate Engine D 5244 T20		◦	GHA336016	K
T5 (180 kW)	2013.10-	Estate Engine B 4204 T11	•		GHA340003	K
	2013.10-	Estate Engine B 4204 T11		◦	GHA400253	K
T5 AWD (187 kW)	2015.08-	Estate Engine B 5254 T12	•		GHA340003	K
	2015.08-	Estate Engine B 5254 T12		◦	GHA400253	K
XC90						
2.4 D3/D5 (120 kW)	2009.04-	Estate Engine D5244T5	•		GHA340004	K
	2009.04-	Estate Engine D5244T5		◦	GHA336012	K
	2009.04-	Estate Engine D5244T5		◦	GHA400285	K
2.4 D5 (120 kW)	2002.10-	Estate Engine D5244T/D5244T5	•		GHA336011	K
	2002.10-	Estate Engine D5244T/D5244T5	•		GHA340004	K
	2002.10-	Estate Engine D5244T/D5244T5		◦	GHA336012	K
	2002.10-	Estate Engine D5244T/D5244T5		◦	GHA400285	K
2.4 D5 (136 kW)	2005.05-2007.11	Estate Engine D5244T4	•		GHA336011	K
	2005.05-2007.11	Estate Engine D5244T4	•		GHA340004	K
	2005.05-2007.11	Estate Engine D5244T4		◦	GHA336012	K
	2005.05-2007.11	Estate Engine D5244T4		◦	GHA400285	K
2.4 D5 (147 kW)	2011.01-	Estate Engine D5244T18	•		GHA340004	K
	2011.01-	Estate Engine D5244T18		◦	GHA336012	K
	2011.01-	Estate Engine D5244T18		◦	GHA400285	K
2.5 T (154 kW)	2002.10-	Estate Engine B5254T2	•		GHA336011	K
	2002.10-	Estate Engine B5254T2	•		GHA340004	K
	2002.10-	Estate Engine B5254T2		◦	GHA336012	K
	2002.10-	Estate Engine B5254T2		◦	GHA400285	K
3.0 T6 (200 kW)	2002.10-	Estate Engine B6294T	•		GHA336011	K
	2002.10-	Estate Engine B6294T	•		GHA340004	K
	2002.10-	Estate Engine B6294T		◦	GHA336012	K
	2002.10-	Estate Engine B6294T		◦	GHA400285	K
3.2 (175 kW)	2006.04-2007.11	Estate Engine B6324S	•		GHA336011	K
	2006.04-2007.11	Estate Engine B6324S	•		GHA340004	K
	2006.04-2007.11	Estate Engine B6324S		◦	GHA336012	K
	2006.04-2007.11	Estate Engine B6324S		◦	GHA400285	K
3.2 AWD (179 kW)	2010.04-	Estate Engine B6324S5	•		GHA340004	K
	2010.04-	Estate Engine B6324S5		◦	GHA336012	K
	2010.04-	Estate Engine B6324S5		◦	GHA400285	K
4.4 V8 (232 kW)	2006.04-2007.11	Estate Engine B8444S	•		GHA336011	K
	2006.04-2007.11	Estate Engine B8444S	•		GHA340004	K
	2006.04-2007.11	Estate Engine B8444S		◦	GHA336012	K
	2006.04-2007.11	Estate Engine B8444S		◦	GHA400285	K

COMPETITOR	G-AP Ref.	COMPETITOR	G-AP Ref.	COMPETITOR	G-AP Ref.	COMPETITOR	G-AP Ref.	COMPETITOR	G-AP Ref.
SKF		VKBA3457	GHA230117K	VKBA3635	GHA230121K	VKBA6531	GHA340003K	VKBA6779	GHA230128
VKBA1301	GHA235001K	VKBA3458	GHA230071K	VKBA3643	GHA336007K	VKBA6532	GHA400253K	VKBA6781	GHA400314K
VKBA1303	GHA235014K	VKBA3459	GHA230104K	VKBA3644	GHA232018K	VKBA6533	GHA336016K	VKBA6800	GHA336008
VKBA1313	GHA235008K	VKBA3460	GHA230151K	VKBA3646	GHA338001K	VKBA6534	GHA332002	VKBA6801	GHA400106
VKBA1338	GHA237001K	VKBA3463	GHA230017K	VKBA3650	GHA333069K	VKBA6541	GHA230092K	VKBA6803	GHA228019K
VKBA1375	GHA230014K	VKBA3464	GHA225036K	VKBA3651	GHA333070K	VKBA6543	GHA336010K	VKBA6806	GHA228049K
VKBA1378	GHA225008	VKBA3465	GHA225037K	VKBA3652	GHA400153K	VKBA6546	GHA247001K	VKBA6807	GHA228067K
VKBA1379	GHA225003K	VKBA3466	GHA225022K	VKBA3653	GHA400133K	VKBA6547	GHA245007K	VKBA6808	GHA400158K
VKBA1405	GHA228030K	VKBA3468	GHA225003K	VKBA3655	GHA245016K	VKBA6548	GHA400196K	VKBA6809	GHA400130K
VKBA1408	GHA225032K	VKBA3469	GHA225006F	VKBA3656	GHA230082K	VKBA6552	GHA230092S	VKBA6810	GHA228068K
VKBA1408	GHA326011K	VKBA3471	GHA230116K	VKBA3659	GHA225011K	VKBA6553	GHA230098K	VKBA6813	GHA232040K
VKBA1409	GHA230005K	VKBA3477	GHA232011K	VKBA3660	GHA336003K	VKBA6556	GHA336004K	VKBA6814	GHA232037K
VKBA1435	GHA235011K	VKBA3478	GHA232007F	VKBA3661	GHA400084K	VKBA6557	GHA245007S	VKBA6817	GHA230093K
VKBA1436	GHA230061K	VKBA3479	GHA232022K	VKBA3665	GHA231001K	VKBA6558	GHA232018K	VKBA6818	GHA230112K
VKBA1437	GHA230110K	VKBA3480	GHA225031K	VKBA3667	GHA237002K	VKBA6565	GHA400174K	VKBA6821	GHA228057K
VKBA1440	GHA230044K	VKBA3482	GHA232033K	VKBA3670	GHA400170K	VKBA6566	GHA249002K	VKBA6822	GHA400129K
VKBA1441	GHA230028K	VKBA3483	GHA230113K	VKBA3671	GHA400248K	VKBA6571	GHA242008K	VKBA6823	GHA400121
VKBA1443	GHA320001K	VKBA3489	GHA400003	VKBA3673	GHA400154K	VKBA6572	GHA242007K	VKBA6824	GHA326027K
VKBA1458	GHA237002K	VKBA3491	GHA225015K	VKBA3674	GHA326026K	VKBA6577	GHA400182K	VKBA6828	GHA400087K
VKBA1475	GHA225009A	VKBA3497	GHA230075A	VKBA3675	GHA245012K	VKBA6579	GHA400188K	VKBA6834	GHA230049K
VKBA1481	GHA235009K	VKBA3502	GHA242009K	VKBA3677	GHA225030K	VKBA6580	GHA324003	VKBA6837	GHA232008K
VKBA1482	GHA235005K	VKBA3503	GHA235018K	VKBA3681	GHA400171K	VKBA6582	GHA330025K	VKBA6838	GHA232043
VKBA1490	GHA232001K	VKBA3506	GHA225026K	VKBA3685	GHA400135K	VKBA6584	GHA400206K	VKBA6839	GHA230065K
VKBA1643	GHA326017K	VKBA3510	GHA333036K	VKBA3686	GHA326038K	VKBA6585	GHA340001K	VKBA6840	GHA232044
VKBA1949	GHA230036	VKBA3511	GHA333033K	VKBA3691	GHA230118K	VKBA6586	GHA400207K	VKBA6841	GHA230078K
VKBA3200	GHA230034K	VKBA3512	GHA333102K	VKBA3693	GHA232029K	VKBA6588	GHA228048	VKBA6843	GHA232015K
VKBA3202	GHA227001K	VKBA3513	GHA333029K	VKBA3697	GHA400149	VKBA6596	GHA228073	VKBA6844	GHA232002K
VKBA3204	GHA227010	VKBA3514	GHA400053K	VKBA3698	GHA232038K	VKBA6597	GHA326014K	VKBA6846	GHA230067K
VKBA3218	GHA233010K	VKBA3517	GHA400191	VKBA3704	GHA227017K	VKBA6600	GHA400071	VKBA6850	GHA400077
VKBA3222	GHA227003K	VKBA3523	GHA336006K	VKBA3715	GHA228033K	VKBA6601	GHA336006S	VKBA6851	GHA400095
VKBA3223	GHA227026K	VKBA3524	GHA400109K	VKBA3725	GHA233003	VKBA6602	GHA340004K	VKBA6857	GHA243004K
VKBA3225	GHA227022F	VKBA3526	GHA336005K	VKBA3728	GHA238001K	VKBA6612	GHA330011K	VKBA6858	GHA243003K
VKBA3229	GHA233009K	VKBA3534	GHA400118K	VKBA3731	GHA228006K	VKBA6614	GHA332006	VKBA6860	GHA234005K
VKBA3234	GHA230038K	VKBA3536	GHA245010K	VKBA3772	GHA230125K	VKBA6618	GHA251003	VKBA6861	GHA230135
VKBA3240	GHA230026K	VKBA3540	GHA230046K	VKBA3773	GHA230122K	VKBA6619	GHA330026K	VKBA6862	GHA228051K
VKBA3250	GHA243001K	VKBA3541	GHA235021K	VKBA3778	GHA228056K	VKBA6623	GHA336007K	VKBA6863	GHA236003
VKBA3251	GHA230003K	VKBA3542	GHA225035K	VKBA3779	GHA228046K	VKBA6624	GHA228058K	VKBA6868	GHA228066K
VKBA3254	GHA234001	VKBA3544	GHA235020K	VKBA3781	GHA233002F	VKBA6625	GHA324002K	VKBA6869	GHA228019K
VKBA3263	GHA234008K	VKBA3545	GHA225013K	VKBA3787	GHA230123K	VKBA6626	GHA400254	VKBA6870	GHA400242
VKBA3264	GHA234003K	VKBA3546	GHA225012K	VKBA3789	GHA230131	VKBA6627	GHA333076K	VKBA6871	GHA400127
VKBA3265	GHA400037	VKBA3548	GHA228041K	VKBA3793	GHA400004	VKBA6629	GHA249005K	VKBA6872	GHA2411001
VKBA3266	GHA228017K	VKBA3549	GHA225029K	VKBA3794	GHA228018K	VKBA6633	GHA400134F	VKBA6873	GHA241002
VKBA3267	GHA228031K	VKBA3550	GHA320003K	VKBA3795	GHA228028K	VKBA6634	GHA326031K	VKBA6874	GHA326024K
VKBA3268	GHA228035K	VKBA3553	GHA245017	VKBA3798	GHA228032K	VKBA6635	GHA336013K	VKBA6875	GHA330014K
VKBA3269	GHA230119K	VKBA3555	GHA400052K	VKBA3888RP	GHA400040	VKBA6637	GHA400207K	VKBA6876	GHA400090
VKBA3270	GHA228034K	VKBA3559	GHA225028K	VKBA3889RP	GHA400042	VKBA6638	GHA336017K	VKBA6877	GHA400079
VKBA3271	GHA228022K	VKBA3560	GHA232034K	VKBA3908	GHA230023K	VKBA6649	GHA262001K	VKBA6885	GHA327039K
VKBA3274	GHA230039K	VKBA3561	GHA225027K	VKBA3930	GHA400007	VKBA6650	GHA232026K	VKBA6888	GHA240008K
VKBA3279	GHA230035K	VKBA3562	GHA232035K	VKBA3931	GHA400008	VKBA6654	GHA400136K	VKBA6889	GHA325025K
VKBA3280	GHA230066K	VKBA3564	GHA225010K	VKBA3932	GHA236002K	VKBA6666	GHA330024K	VKBA6890	GHA232047
VKBA3282	GHA234002	VKBA3567	GHA228036K	VKBA3934	GHA233007K	VKBA6667	GHA330024S	VKBA6896	GHA237056
VKBA3295	GHA228009	VKBA3568	GHA320002K	VKBA3937	GHA328003K	VKBA6669	GHA400268K	VKBA6897	GHA230114
VKBA3298	GHA230050K	VKBA3569	GHA336001K	VKBA3938	GHA400049	VKBA6670	GHA249006K	VKBA6898	GHA400241
VKBA3299	GHA230029K	VKBA3570	GHA230057K	VKBA3944	GHA400061	VKBA6678	GHA332009K	VKBA6900	GHA254002K
VKBA3300	GHA230015K	VKBA3576	GHA400081K	VKBA3947	GHA400060	VKBA6680	GHA325026K	VKBA6905	GHA400131
VKBA3303	GHA230095	VKBA3580	GHA237018K	VKBA3952	GHA230030K	VKBA6688	GHA333097K	VKBA6906	GHA254003K
VKBA3305	GHA228020K	VKBA3583	GHA230047K	VKBA3953	GHA230072	VKBA6701	GHA400134K	VKBA6907	GHA244003K
VKBA3306	GHA230008K	VKBA3585	GHA225014K	VKBA3954	GHA230024K	VKBA6709	GHA400279	VKBA6908	GHA244006
VKBA3307	GHA240001K	VKBA3587	GHA232032K	VKBA3962	GHA400068	VKBA6711	GHA400171S	VKBA6909	GHA244004K
VKBA3323	GHA228055	VKBA3588	GHA245009K	VKBA3973	GHA230053	VKBA6714	GHA333080K	VKBA6910	GHA244005
VKBA3326	GHA230040K	VKBA3589	GHA237015K	VKBA3975	GHA400062	VKBA6715	GHA330019K	VKBA6914	GHA330066K
VKBA3327	GHA230081K	VKBA3590	GHA237017K	VKBA3992	GHA230039K	VKBA6717	GHA237013	VKBA6917	GHA400083
VKBA3401	GHA326005K	VKBA3592	GHA232012K	VKBA625	GHA230002F	VKBA6724	GHA242009S	VKBA6921	GHA400099
VKBA3409	GHA400064K	VKBA3594	GHA232030K	VKBA6500	GHA232021K	VKBA6725	GHA230115K	VKBA6924	GHA326028K
VKBA3418	GHA230109K	VKBA3595	GHA232028K	VKBA6501	GHA400181	VKBA6733	GHA327040K	VKBA6925	GHA400114
VKBA3422	GHA400058K	VKBA3597	GHA230120K	VKBA6506	GHA330013K	VKBA6735	GHA251002K	VKBA6928	GHA230087K
VKBA3424	GHA230111K	VKBA3602	GHA227023K	VKBA6507	GHA330021K	VKBA6750	GHA329018K	VKBA6939	GHA235015K
VKBA3425	GHA235019K	VKBA3604	GHA232023	VKBA6510	GHA400240K	VKBA6752	GHA340005K	VKBA6940	GHA235012K
VKBA3433	GHA235022K	VKBA3606	GHA232014K	VKBA6516	GHA230097K	VKBA6753	GHA245022K	VKBA6941	GHA235023K
VKBA3440	GHA225034K	VKBA3619	GHA330022F	VKBA6521	GHA237016K	VKBA6760	GHA332020	VKBA6942	GHA400231
VKBA3442	GHA230090K	VKBA3620	GHA330011K	VKBA6522	GHA237016K	VKBA6762	GHA232036K	VKBA6943	GHA233005K
VKBA3444	GHA400001K	VKBA3621	GHA237004K	VKBA6523	GHA340005K	VKBA6763	GHA332018	VKBA6948	GHA400190
VKBA3445	GHA245001K	VKBA3624	GHA400137K	VKBA6524	GHA400197K	VKBA6764	GHA400175	VKBA6949	GHA232025
VKBA3451	GHA237003K	VKBA3626	GHA336011K	VKBA6525	GHA245008K	VKBA6765	GHA330024F	VKBA6950	GHA400108
VKBA3453	GHA232039K	VKBA3627	GHA336012K	VKBA6526	GHA249001K	VKBA6767	GHA228061K	VKBA6953	GHA400237
VKBA3454	GHA232013K	VKBA3631	GHA400285K	VKBA6527	GHA237010K	VKBA6769	GHA329007	VKBA6954	GHA400210
VKBA3456	GHA230051K	VKBA3632	GHA336014K	VKBA6528	GHA245015K	VKBA6778	GHA230086K	VKBA6955	GHA330029

COMPETITOR	G-AP Ref.	COMPETITOR	G-AP Ref.	COMPETITOR	G-AP Ref.	COMPETITOR	G-AP Ref.	COMPETITOR	G-AP Ref.
SKF		VKBA7692	GHA329009	VKBA1320	GWB1320	VKBA3235	GWB3235	VKBA3584	GWB3584
		VKBA913	GHA326001	VKBA1324	GWB1324	VKBA3236	GWB3236	VKBA3596	GWB3596
VKBA6963	GHA326036	VKBA938	GHA231001K	VKBA1326	GWB1326	VKBA3237	GWB3237	VKBA3598	GWB3598
VKBA6978	GHA328007K	VKBA939	GHA237004K	VKBA1327	GWB1327	VKBA3245	GWB3245	VKBA3599	GWB3599
VKBA6979	GHA228027K	VKBA940	GHA230002S	VKBA1333	GWB1333	VKBA3246	GWB3246	VKBA3601	GWB3601
VKBA6980	GHA228026K	VKBA968	GHA225020K	VKBA1340	GWB1340	VKBA3255	GWB3255	VKBA3603	GWB3603
VKBA6984	GHA329001K	VKBD1006	GHA225018K	VKBA1342	GWB1342	VKBA3256	GWB3256	VKBA3605	GWB3605
VKBA6985	GHA329015K	VKBD1007	GHA230141K	VKBA1344	GWB1344	VKBA3257	GWB3257	VKBA3607	GWB3607
VKBA6990	GHA327043K	VKBD1009	GHA230140K	VKBA1345	GWB1345	VKBA3272	GWB3272	VKBA3608	GWB3608
VKBA6991	GHA230091K	VKBD1010	GHA230142K	VKBA1347	GWB1347	VKBA3308	GWB3308	VKBA3613	GWB3613
VKBA6996	GHA329006K	VKBD1011	GHA225042K	VKBA1349	GWB1349	VKBA3309	GWB3309	VKBA3614	GWB3614
VKBA6997	GHA400161	VKBD1012	GHA230145K	VKBA1352	GWB1352	VKBA3319	GWB3319	VKBA3615	GWB3615
VKBA6998	GHA325019K	VKBD1013	GHA235025	VKBA1353	GWB1353	VKBA3325	GWB3325	VKBA3616	GWB3616
VKBA6999	GHA329003	VKBD1014	GHA225041K	VKBA1355	GWB1355	VKBA3331	GWB3331	VKBA3617	GWB3617
VKBA7022	GHA327043K	VKBD1015	GHA225019K	VKBA1356	GWB1356	VKBA3332	GWB3332	VKBA3618	GWB3618
VKBA7026	GHA327028	VKBD1016	GHA230148K	VKBA1358	GWB1358	VKBA3400	GWB3400	VKBA3625	GWB3625
VKBA734	GHA320001K	VKBD1017	GHA230146K	VKBA1362	GWB1362	VKBA3403	GWB3403	VKBA3628	GWB3628
VKBA7400	GHA225025K	VKBD1018	GHA230144K	VKBA1363	GWB1363	VKBA3404	GWB3404	VKBA3633	GWB3633
VKBA7401	GHA225021K	VKBD1025	GHA225039K	VKBA1365	GWB1365	VKBA3405	GWB3405	VKBA3637	GWB3637
VKBA7402	GHA230058K	VKBD1026	GHA225038K	VKBA1366	GWB1366	VKBA3410	GWB3410	VKBA3638	GWB3638
VKBA7403	GHA332005K	VKBD1027	GHA230137K	VKBA1367	GWB1367	VKBA3412	GWB3412	VKBA3639	GWB3639
VKBA7405	GHA230100	VKBD1028	GHA230138K	VKBA1369	GWB1369	VKBA3413	GWB3413	VKBA3640	GWB3640
VKBA7406	GHA327032	VKBA504	GWB0504	VKBA1370	GWB1370	VKBA3414	GWB3414	VKBA3641	GWB3641
VKBA7407	GHA240009	VKBA523	GWB0523	VKBA1374	GWB1374	VKBA3416	GWB3416	VKBA3642	GWB3642
VKBA7409	GHA327044K	VKBA526	GWB0526	VKBA1383	GWB1383	VKBA3417	GWB3417	VKBA3645	GWB3645
VKBA7410	GHA325001	VKBA528	GWB0528	VKBA1393	GWB1393	VKBA3420	GWB3420	VKBA3647	GWB3647
VKBA7413	GHA254004K	VKBA529	GWB0529	VKBA1397	GWB1397	VKBA3421	GWB3421	VKBA3648	GWB3648
VKBA7414	GHA330009	VKBA534	GWB0534	VKBA1401	GWB1401	VKBA3423	GWB3423	VKBA3649	GWB3649
VKBA7417	GHA400072K	VKBA540	GWB0540	VKBA1410	GWB1410	VKBA3427	GWB3427	VKBA3657	GWB3657
VKBA7419	GHA400091K	VKBA542	GWB0542	VKBA1412	GWB1412	VKBA3428	GWB3428	VKBA3658	GWB3658
VKBA743	GHA232004K	VKBA575	GWB0575	VKBA1430	GWB1430	VKBA3429	GWB3429	VKBA3664	GWB3664
VKBA7430	GHA400059	VKBA577	GWB0577	VKBA1431	GWB1431	VKBA3430	GWB3430	VKBA3666	GWB3666
VKBA7435	GHA328006K	VKBA593	GWB0593	VKBA1432	GWB1432	VKBA3434	GWB3434	VKBA3668	GWB3668
VKBA7437	GHA330010K	VKBA596	GWB0596	VKBA1433	GWB1433	VKBA3435	GWB3435	VKBA3676	GWB3676
VKBA7439	GHA330008K	VKBA613	GWB0613A	VKBA1438	GWB1438	VKBA3441	GWB3441	VKBA3678	GWB3678
VKBA7441	GHA328002K	VKBA652	GWB0652	VKBA1439	GWB1439	VKBA3443	GWB3443	VKBA3679	GWB3679
VKBA7447	GHA230068K	VKBA663	GWB0663	VKBA1444	GWB1444	VKBA3446	GWB3446	VKBA3680	GWB3680
VKBA7449	GHA400107	VKBA687	GWB0687	VKBA1445	GWB1445	VKBA3449	GWB3449	VKBA3682	GWB3682
VKBA7451	GHA250011	VKBA736	GWB0736	VKBA1455	GWB1455	VKBA3450	GWB3450	VKBA3683	GWB3683
VKBA7454	GHA400262	VKBA739	GWB0739	VKBA1459	GWB1459	VKBA3455	GWB3455	VKBA3684	GWB3684
VKBA7459	GHA400187	VKBA740	GWB0740	VKBA1460	GWB0001	VKBA3475	GWB3475	VKBA3688	GWB3688
VKBA7462	GHA400269	VKBA741	GWB0741	VKBA1465	GWB1465	VKBA3485	GWB3485	VKBA3689	GWB3689
VKBA7466	GHA326030K	VKBA749	GWB0749	VKBA1466	GWB1466	VKBA3486	GWB3486	VKBA3690	GWB3690
VKBA7479	GHA327038K	VKBA754	GWB0754	VKBA1467	GWB1467	VKBA3490	GWB3490	VKBA3692	GWB3692
VKBA7482	GHA232002K	VKBA756	GWB0756	VKBA1470	GWB1470	VKBA3492	GWB3492	VKBA3703	GWB3703
VKBA7488	GHA331007A	VKBA757	GWB0757	VKBA1473	GWB1473	VKBA3495	GWB3495	VKBA3713	GWB3713
VKBA7489	GHA245013	VKBA802	GWB0802	VKBA1480	GWB1480	VKBA3496	GWB3496	VKBA3716	GWB3716
VKBA7492	GHA400164K	VKBA826	GWB0826	VKBA1488	GWB1488	VKBA3499	GWB3499	VKBA3717	GWB3717
VKBA7493	GHA400193K	VKBA827	GWB0827	VKBA1491	GWB1491	VKBA3500	GWB3500	VKBA3718	GWB3718
VKBA7495	GHA327056	VKBA828	GWB0828	VKBA1495	GWB1495	VKBA3501	GWB3501	VKBA3727	GWB3727
VKBA7497	GHA254001K	VKBA841	GWB0841	VKBA1498	GWB1498	VKBA3504	GWB3504	VKBA3729	GWB3729
VKBA7498	GHA227018K	VKBA882	GWB0882	VKBA1499	GWB1499	VKBA3518	GWB3518	VKBA3730	GWB3730
VKBA7505	GHA325018K	VKBA897	GWB0897	VKBA1905	GWB1905	VKBA3519	GWB3519	VKBA3740	GWB3740
VKBA7514	GHA400295	VKBA898	GWB0898	VKBA1909	GWB1909	VKBA3520	GWB3520	VKBA3765	GWB3765
VKBA7529	GHA400086K	VKBA904	GWB0904	VKBA1911	GWB1911	VKBA3521	GWB3521	VKBA3775	GWB3775
VKBA7535	GHA325016K	VKBA906	GWB0906	VKBA1915	GWB1915	VKBA3522	GWB3522	VKBA3785	GWB3785
VKBA7540	GHA400101	VKBA909	GWB0909	VKBA1928	GWB1928	VKBA3525	GWB3525	VKBA3786	GWB3786
VKBA7544	GHA328012	VKBA910	GWB0910	VKBA1930	GWB1930	VKBA3527	GWB3527	VKBA3796	GWB3796
VKBA7554	GHA400054	VKBA911	GWB0911	VKBA1931	GWB1931	VKBA3528	GWB3528	VKBA3797	GWB3797
VKBA7555	GHA400036K	VKBA915	GWB0915	VKBA1948	GWB1948	VKBA3530	GWB3530	VKBA3901	GWB3901
VKBA7556	GHA400152	VKBA918	GWB0918	VKBA1950	GWB1950	VKBA3531	GWB3531	VKBA3902	GWB3902
VKBA7560	GHA400247	VKBA919	GWB0919	VKBA1951	GWB1951	VKBA3532	GWB3532	VKBA3906	GWB3906
VKBA7561	GHA243006K	VKBA926	GWB0926	VKBA1956	GWB1956	VKBA3535	GWB3535	VKBA3907	GWB3907
VKBA7565	GHA400260	VKBA927	GWB0927	VKBA1961	GWB1961	VKBA3538	GWB3538	VKBA3909	GWB3909
VKBA7568	GHA400208	VKBA928	GWB0928	VKBA1962	GWB1962	VKBA3539	GWB3539	VKBA3916	GWB3916
VKBA7570	GHA400258	VKBA941	GWB0941	VKBA1970	GWB1970	VKBA3543	GWB3543	VKBA3917	GWB3917
VKBA7576	GHA326039	VKBA944	GWB0944	VKBA1971	GWB1971	VKBA3551	GWB3551	VKBA3922	GWB3922
VKBA7581	GHA400274	VKBA947	GWB0947	VKBA1973	GWB1973	VKBA3552	GWB3552	VKBA3929	GWB3929
VKBA7589	GHA230108K	VKBA949	GWB0949	VKBA1999	GWB1999	VKBA3554	GWB3554A	VKBA3936	GWB3936
VKBA7591	GHA400232	VKBA961	GWB0961	VKBA3201	GWB3201	VKBA3556	GWB3556	VKBA3940	GWB3940
VKBA7592	GHA325005	VKBA962	GWB0962	VKBA3205	GWB3205	VKBA3565	GWB3565	VKBA3945	GWB3945
VKBA7604	GHA400259	VKBA969	GWB0969	VKBA3206	GWB3206	VKBA3571	GWB3571	VKBA3946	GWB3946
VKBA7607	GHA329005	VKBA975	GWB0975	VKBA3217	GWB3217	VKBA3572	GWB3572	VKBA3949	GWB3949
VKBA7612	GHA329023	VKBA976	GWB0976	VKBA3219	GWB3219	VKBA3574	GWB3574	VKBA3950	GWB3950
VKBA7630	GHA245019	VKBA1306	GWB1306	VKBA3220	GWB3220	VKBA3575	GWB3575	VKBA3951	GWB3951
VKBA7631	GHA245011	VKBA1314	GWB1314	VKBA3221	GWB3221	VKBA3577	GWB3577	VKBA3959	GWB3959
VKBA7642	GHA400232	VKBA1317	GWB1317	VKBA3224	GWB3224	VKBA3581	GWB3581	VKBA3961	GWB3961

COMPETITOR	G-AP Ref.	COMPETITOR	G-AP Ref.	COMPETITOR	G-AP Ref.	COMPETITOR	G-AP Ref.	COMPETITOR	G-AP Ref.
SKF		VKBA7032	GWB7032	370159		1469186		3981586	
VKBA3965	GWB3965	VKBA7408	GWB7408	370164	GHA232011K	1471854	GHA336003K	4052783	GHA245009K
VKBA3966	GWB3966	VKBA7440	GWB7440	370167	GHA225031K	1496721	GHA340001K	4107462	GHA326011K
VKBA3967	GWB3967	VKBA7446	GWB7446	370182	GHA242008K	1500263	GHA400207K	4122007	GHA327041
VKBA3968	GWB3968	VKBA7455	GWB7455	370183	GHA242007K	1501070	GHA400197K	4164670	GHA237017K
VKBA3970	GWB3970	VKBA7456	GWB7456	370183	GHA242007K	1501070	GHA400197K	4164670	GHA237017K
VKBA3970	GWB3970	VKBA7458	GWB7458	373036	GHA327044K	1506577	GHA400084K	4164671	GHA237015K
VKBA3974	GWB3974	VKBA7469	GWB7469	374815	GHA232004K	1538604	GHA336017K	4242194	GHA433004
VKBA3979	GWB3979	VKBA7474	GWB7474	374818	GHA232032K	1541797	GHA422015	4260431	GHA420004
VKBA3981	GWB3981	VKBA7490	GWB7490	374828	GHA232011K	1547177	GHA400136K	4338560	GHA326007
VKBA3985	GWB3985	VKBA7525	GWB7525	374829	GHA232007F	1570733	GHA400197K	4340315	GHA331002
VKBA3991	GWB3991	VKBA7526	GWB7526	374831	GHA225037K	1587590	GHA230046K	4340326	GHA326017K
VKBA3997	GWB3997	VKBA7534	GWB7534A	374832	GHA225009A	1591164	GHA423007	4340334	GHA326020K
VKBA5549	GWB5549	VKBA7536	GWB7536	374833	GHA232001K	1603143	GHA330011K	4344535	GHA230002S
VKBA6502	GWB6502	VKBA7537	GWB7537	374834	GHA232039K	1603194	GHA235001K	4379767	GHA230002S
VKBA6508	GWB6508	VKBA7538	GWB7538	374835	GHA232013K	1603208	GHA333036K	4390949	GHA422001
VKBA6509	GWB6509	VKBA7545	GWB7545	374836	GHA232033K	1603209	GHA333033K	4398046	GHA400052K
VKBA6515	GWB6515	VKBA7549	GWB7549	374837	GHA225012K	1603210	GHA333102K	4399777	GHA420004
VKBA6520	GWB6520	VKBA7573	GWB7573	374838	GHA225013K	1603211	GHA333029K	4400918	GHA320001K
VKBA6530	GWB6530	VKBA7587	GWB7587	374841	GHA225010K	1603243	GHA330011K	4408276	GHA235025
VKBA6537	GWB6537	VKBA7606	GWB7606	374843	GHA232032K	1603253	GHA333069K	4419850	GHA326007
VKBA6540	GWB6540			374844	GHA232012K	1603254	GHA333070K	4423893	GHA228059
VKBA6544	GWB6544	OE		374848	GHA225013K	1603255	GHA330021K	4443485	GHA326017K
VKBA6549	GWB6549	37016	GHA225037K	374869	GHA232034K	1603294	GHA330011K	4459689	GHA230107
VKBA6550	GWB6550	271394	GHA235008K	374870	GHA232030K	1603295	GHA330021K	4486860	GHA326010
VKBA6559	GWB6559	271450	GHA235011K	374872	GHA225013K	1603296	GHA330013K	4504038	GHA326020K
VKBA6561	GWB6561	271589	GHA326005K	374874	GHA225014K	1603841	GHA333097K	4504039	GHA326017K
VKBA6570	GWB6570	271643	GHA235008K	374875	GHA225031K	1604002	GHA400052K	4506244	GHA245009K
VKBA6575	GWB6575	271644	GHA235011K	374876	GHA225011K	1604003	GHA400064K	4509325	GHA228059
VKBA6578	GWB6578	271786	GHA326004K	374879	GHA225011K	1604004	GHA400058K	4509599	GHA228016
VKBA6590	GWB6590	271795	GHA230109K	374882	GHA232029K	1604005	GHA400053K	4509600	GHA228016
VKBA6591	GWB6591	271905	GHA235019K	374885	GHA400149	1604017	GHA230092S	4509766	GHA228013
VKBA6632	GWB6632	272456	GHA336005K	374886	GHA232029K	1604018	GHA230092S	4509767	GHA228048
VKBA6636	GWB6636	274181	GHA326004K	374887	GHA232029K	1604301	GHA400052K	4509792	GHA228073
VKBA6639	GWB6639	274298	GHA336006K	374888	GHA232021K	1604302	GHA400064K	4568192	GHA433004
VKBA6640	GWB6640	274324	GHA336005K	374889	GHA232038K	1604303	GHA400058K	4582219	GHA232017
VKBA6642	GWB6642	274378	GHA326004K	374895	GHA400182K	1604306	GHA400064K	4582220	GHA232005
VKBA6643	GWB6643	326001	GHA422014	374898	GHA230046K	1604307	GHA400058K	4593003	GHA333031
VKBA6646	GWB6646	326002	GHA333083K	378484	GHA232029K	1604314	GHA400137K	4593450	GHA333031
VKBA6647	GWB6647	326169	GHA422006K	420240	GHA227023K	1604315	GHA400153K	4593462	GHA326008
VKBA6653	GWB6653	326173	GHA433007	424919	GHA230145K	1604316	GHA400133K	4593777	GHA326008
VKBA6658	GWB6658	326178	GHA422006K	424932	GHA230145K	1604358	GHA230092S	4616263	GHA228005
VKBA6686	GWB6686	326180	GHA235001K	424934	GHA225042K	1604359	GHA400338K	4616477	GHA228011
VKBA6700	GWB6700	326181	GHA235001K	424945	GHA230148K	1604360	GHA230098K	4621122	GHA423006
VKBA6720	GWB6720	326184	GHA433007	424946	GHA230148K	1644842	GHA423007	4641120	GHA423005K
VKBA6721	GWB6721	326194	GHA433019	424966	GHA230146K	1675466	GHA400136K	4641196	GHA326017K
VKBA6722	GWB6722	326195	GHA433004	702355	GHA225003K	1699196	GHA400136K	4641516	GHA326022
VKBA6726	GWB6726	326196	GHA422023	1053004	GHA400191	1753553	GHA400197K	4641517	GHA326014K
VKBA6731	GWB6731	326197	GHA422006K	1057808	GHA400191	1753554	GHA400207K	4641525	GHA326016
VKBA6742	GWB6742	328001	GHA330019K	1057809	GHA400191	1766628	GHA400084K	4641732	GHA326017K
VKBA6774	GWB6774	328002	GHA400164K	1115019	GHA400081K	1768073	GHA400336K	4642653	GHA331002
VKBA6799	GWB6799	328003	GHA400193K	1118053	GHA400191	1783318	GHA400337K	4670287	GHA423005K
VKBA6805	GWB6805	328006	GHA330024K	1118054	GHA400191	2715852	GHA230109K	4683513	GHA400026
VKBA6812	GWB6812	328013	GHA230086K	1124904	GHA400081K	2715894	GHA326005K	4683514	GHA400030
VKBA6819	GWB6819	328014	GHA230128	1146119	GHA425004K	2716439	GHA235008K	4683515	GHA400030
VKBA6820	GWB6820	328016	GHA333080K	1146689	GHA400081K	2716447	GHA235011K	4721513	GHA400026
VKBA6825	GWB6825	328021	GHA330019K	1201300	GHA245009K	2717866	GHA326004K	4721514	GHA400030
VKBA6830	GWB6830	328028	GHA230127	1201303	GHA237017K	2717957	GHA230109K	4721515	GHA400030
VKBA6831	GWB6831	328292	GHA330024S	1201304	GHA237015K	2724560	GHA336005K	4728867	GHA333031
VKBA6845	GWB6845	330756	GHA425022	1230942	GHA400084K	2724565	GHA336005K	4778494	GHA400052K
VKBA6849	GWB6849	330758	GHA232039K	1309814	GHA400084K	2741817	GHA326004K	4779011	GHA232005
VKBA6856	GWB6856	330761	GHA232001K	1318151	GHA245016K	2742980	GHA336006K	4779081	GHA232017
VKBA6878	GWB6878	330765	GHA428004	1318154	GHA245016K	2743240	GHA336005K	4804658	GHA330008K
VKBA6891	GWB6891	330766	GHA435001	1332888	GHA400081K	2743789	GHA326004K	4809314	GHA330010K
VKBA6901	GWB6901	330769	GHA425022	1333147	GHA425004K	3433927	GHA233002F	4814139	GHA330008K
VKBA6913	GWB6913	330771	GHA425022	1336139	GHA336003K	3450524	GHA230061K	4814304	GHA330010K
VKBA6923	GWB6923	330772	GHA425022	1377119	GHA400197K	3450528	GHA230061K	4839122	GHA400052K
VKBA6926	GWB6926	330776	GHA421003	1377907	GHA245008K	3472719	GHA230110K	4858822	GHA400081K
VKBA6931	GWB6931	330777	GHA428006	1377908	GHA249001K	3516037	GHA235011K	4860394	GHA245015K
VKBA6938	GWB6938	330778	GHA435002	1377910	GHA237015K	3516184	GHA326005K	5016458	GHA327013
VKBA6944	GWB6944	330783	GHA435002	1377911	GHA237010K	3555333	GHA425004K	5027621	GHA235009K
VKBA6956	GWB6956	330784	GHA428006	1377912	GHA245015K	3800914	GHA243001K	5027622	GHA235005K
VKBA6966	GWB6966	330785	GHA425022	1437643	GHA340005K	3801212	GHA233001	5058185	GHA400118K
VKBA6967	GWB6967	335028	GHA230111K	1454712	GHA428027	3801213	GHA327032	5212770	GHA426009K
VKBA6972	GWB6972	335071	GHA230121K	1458702	GHA237016K	3802312	GHA231001K	5241067	GHA326020K
VKBA6975	GWB6975	370142	GHA232004K	1458881	GHA428008	3802315	GHA237001K	5241068	GHA326017K
VKBA7016	GWB7016	370152	GHA225032K	1463833	GHA340001K	3903036	GHA425004K	5392493	GHA330022F

COMPETITOR	G-AP Ref.	COMPETITOR	G-AP Ref.	COMPETITOR	G-AP Ref.	COMPETITOR	G-AP Ref.	COMPETITOR	G-AP Ref.
OE		7467558	GHA333072	7470608	GHA327012K	12413091	GHA400031	15225750	GHA400147
		7467575	GHA333074	7470609	GHA400015	12413097	GHA333072	15225751	GHA400147
5890994	GHA320001K	7467576	GHA333073	7470610	GHA400015	12413098	GHA333072	15225752	GHA333068
5948422	GHA230002S	7467601	GHA333078	7470611	GHA400031	12413099	GHA4000145	15225770	GHA333041
5961002	GHA420001	7467617	GHA333072	7470619	GHA400053K	12413100	GHA400145	15233111	GHA400005
5963034	GHA320001K	7467651	GHA330012	7470625	GHA333010T	12413103	GHA400289	15233113	GHA333027
6087129	GHA423007	7467687	GHA330012	7470626	GHA333010T	12413105	GHA330034	15564905	GHA333011
6501053	GHA326020K	7470002	GHA333003K	7470628	GHA400012	12413121	GHA400306	15564906	GHA333013
6517013	GHA425004K	7470003	GHA327023K	7522385	GHA422007	12413122	GHA400306	15564913	GHA333064
6517014	GHA423002	7470004	GHA333024K	7591328	GHA422001	12413164	GHA333074	15649176	GHA333057
6750217	GHA400248K	7470005	GHA327021	7603485	GHA230002F	12413165	GHA333073	15693437	GHA333013
6756889	GHA326026K	7470009	GHA333006	7608131	GHA422015	12413166	GHA330012	15693440	GHA333057
6757024	GHA237002K	7470012	GHA327022	7613514	GHA230028K	12413190	GHA400145	15719015	GHA333041
6779735	GHA330026K	7470013	GHA327022	7667265	GHA425008	12413195	GHA333072	15731627	GHA329501
7466905	GHA333003K	7470014	GHA333024K	7672265	GHA422015	12413196	GHA333072	15740291	GHA333027
7466906	GHA400019	7470017	GHA333083K	7732410	GHA230028K	12413197	GHA333078	15753473	GHA333068
7466907	GHA327021	7470018	GHA330001K	7746191	GHA230107	12413215	GHA333072	15753476	GHA400147
7466908	GHA333024K	7470105	GHA333083K	7769902	GHA230090K	12413216	GHA333072	15772838	GHA400075
7466918	GHA400057	7470108	GHA400014	7769902	GHA230090K	12413228	GHA400306	15793213	GHA330012
7466920	GHA327021	7470143	GHA333083K	8672371	GHA336006S	12413244	GHA400299	15798483	GHA400212
7466922	GHA327023K	7470503	GHA400057	8952996	GHA326001	12413247	GHA333079	15816313	GHA330041
7466923	GHA400025	7470504	GHA400057	8971103	GHA326011K	12413257	GHA327027	15839050	GHA400195
7466925	GHA333024K	7470506	GHA327022	8973406	GHA230005K	12429201	GHA330001K	15839051	GHA400296
7466926	GHA400057	7470509	GHA400014	8993875	GHA326001	12429202	GHA330001K	15863440	GHA400005
7466928	GHA333024K	7470511	GHA333006	8993883	GHA326001	12429204	GHA333083K	15863441	GHA333027
7466931	GHA400025	7470512	GHA333006	8993891	GHA326001	12429205	GHA333083K	15871426	GHA333054
7466932	GHA400029	7470513	GHA400013	8993909	GHA326001	12541129	GHA333011	15871427	GHA333053
7466935	GHA400025	7470515	GHA333010T	9113991	GHA336006K	12549138	GHA333064	15874836	GHA333104
7466941	GHA333024K	7470517	GHA333010T	9117619	GHA333036K	12796081	GHA330011K	15889806	GHA400186
7466942	GHA327021	7470518	GHA333010T	9117620	GHA333033K	12799815	GHA330011K	15910968	GHA333095
7466944	GHA400025	7470519	GHA400018	9117621	GHA333102K	13110964	GHA333070K	15910969	GHA333109
7466948	GHA400057	7470520	GHA400018	9117622	GHA333029K	13121138	GHA400153K	15918787	GHA333108
7466949	GHA400029	7470522	GHA333024K	9119931	GHA400052K	13123485	GHA333036K	15941790	GHA333108
7466950	GHA333024K	7470523	GHA400014	9120128	GHA400064K	13123486	GHA333033K	15946732	GHA400147
7466952	GHA327021	7470531	GHA400054	9120129	GHA400058K	13500589	GHA400283	15946733	GHA333068
7466957	GHA327023K	7470532	GHA400054	9120273	GHA400053K	13500590	GHA400267	15981339	GHA333064
7466960	GHA333010T	7470533	GHA400036K	9140092	GHA326004K	13500591	GHA400280	15990509	GHA333063
7466961	GHA333014	7470534	GHA400036K	9156305	GHA400052K	13500592	GHA400259	15990510	GHA333105
7466964	GHA327022	7470536	GHA327021	9156621	GHA400058K	13502828	GHA333080K	15991989	GHA333028
7466966	GHA333010T	7470537	GHA327012K	9156622	GHA400064K	13502829	GHA330019K	15991990	GHA333028
7466967	GHA333010T	7470541	GHA400017	9173872	GHA400109K	13502872	GHA400164K	15997071	GHA333008
7466968	GHA400017	7470542	GHA400017	9173991	GHA336006K	13502873	GHA400193K	15997072	GHA333008
7466970	GHA400014	7470543	GHA400111	9196298	GHA227023K	13580135	GHA330024K	15997073	GHA333009
7466976	GHA333006	7470544	GHA400111	10305030	GHA333083K	13580135	GHA330024S	15997074	GHA333009
7466978	GHA400013	7470545	GHA400020	10334134	GHA333072	13583478	GHA333080K	18060224	GHA333064
7466982	GHA333010T	7470546	GHA400020	10345966	GHA330028	13583479	GHA330019K	18061146	GHA400078
7466983	GHA333010T	7470549	GHA400013	10345967	GHA330042	13591998	GHA400164K	18061148	GHA400297
7466986	GHA400034	7470550	GHA400013	10351823	GHA333055	13598180	GHA235008K	19149001	GHA400078
7466989	GHA400012	7470551	GHA400025	10351824	GHA333056	15037207	GHA400005	19150997	GHA330010K
7466991	GHA400111	7470552	GHA400025	10359823	GHA333055	15042868	GHA333041	19151003	GHA33008K
7466992	GHA400018	7470555	GHA400018	10359824	GHA333056	15056753	GHA333068	19184266	GHA400039
7466994	GHA400054	7470556	GHA400018	10393162	GHA400005	15058367	GHA333101	19206599	GHA330010K
7466995	GHA400036K	7470558	GHA333003K	10393163	GHA333027	15058368	GHA333099	19206599	GHA330031
7466996	GHA400020	7470560	GHA400019	10393170	GHA400286	15058393	GHA400075	19206600	GHA330008K
7466997	GHA333024K	7470561	GHA330001K	10393171	GHA333075	15064670	GHA400147	19209040	GHA333027
7467101	GHA333024K	7470562	GHA330001K	10434253	GHA333083K	15100274	GHA327046	20835869	GHA333095
7467106	GHA400144	7470567	GHA333083K	12413003	GHA400016	15100275	GHA327045	20863127	GHA330032
7467107	GHA330027	7470568	GHA333083K	12413004	GHA400016	15102293	GHA400005	20971868	GHA400358
7467108	GHA400014	7470569	GHA400144	12413005	GHA333072	15102294	GHA333027	21011095	GHA400022
7467109	GHA400019	7470570	GHA400144	12413025	GHA400029	15104582	GHA333041	21011096	GHA400012
7467110	GHA400012	7470571	GHA330027	12413029	GHA400291	15104907	GHA400147	21011953	GHA433006K
7467111	GHA400022	7470572	GHA330027	12413031	GHA400142	15111599	GHA333104	21012556	GHA400022
7467113	GHA400018	7470579	GHA400029	12413035	GHA333083K	15112380	GHA400005	21012577	GHA400012
7467117	GHA400022	7470580	GHA400029	12413037	GHA327027	15112382	GHA333027	21013003	GHA400012
7467119	GHA400018	7470584	GHA327023K	12413040	GHA330001K	15112408	GHA400147	21990449	GHA333056
7467127	GHA400015	7470585	GHA333014	12413041	GHA400025	15112411	GHA333041	21990451	GHA333054
7467128	GHA400017	7470586	GHA333014	12413045	GHA327012K	15112450	GHA333099	21990564	GHA333055
7467129	GHA400111	7470587	GHA400034	12413046	GHA327012K	15112451	GHA333101	21995732	GHA330012
7467132	GHA400057	7470588	GHA400034	12413047	GHA327020	15115915	GHA400147	22667146	GHA333074
7467133	GHA400020	7470597	GHA400014	12413071	GHA400143	15130858	GHA327027	22667147	GHA333073
7467139	GHA327012K	7470598	GHA400014	12413075	GHA333074	15134584	GHA333027	22669735	GHA400212
7467140	GHA333010T	7470599	GHA400019	12413076	GHA333074	15170661	GHA400219	22671547	GHA400195
7467144	GHA330027	7470600	GHA400019	12413077	GHA333073	15170662	GHA400318	22671548	GHA400296
7467145	GHA400144	7470602	GHA400012	12413078	GHA333073	15178881	GHA400301	22701516	GHA333074
7467190	GHA400144	7470603	GHA400022	12413083	GHA330012	15178882	GHA400300	22701520	GHA333073
7467505	GHA333072	7470604	GHA400022	12413084	GHA330012	15178883	GHA400303	22702689	GHA333054
7467506	GHA400145	7470607	GHA327012K	12413089	GHA400287	15178884	GHA400302	22702690	GHA333053

COMPETITOR	G-AP Ref.	COMPETITOR	G-AP Ref.	COMPETITOR	G-AP Ref.	COMPETITOR	G-AP Ref.	COMPETITOR	G-AP Ref.
OE		46447445	GHA422018	71753815	GHA330025K	93188477	GHA333097K	333501117	GHA499014
		46453887	GHA230044K	71753816	GHA400206K	93188708	GHA400338K	333501118	GHA499015
22702717	GHA333055	46512973	GHA230046K	71753817	GHA237018K	93190215	GHA230092S	357407615	GHA422009K
22702718	GHA333056	46519901	GHA230046K	71753819	GHA230047K	93190216	GHA230098K	357501117	GHA499044
22703526	GHA400019	46531237	GHA235020K	71768165	GHA324003	93271759	GHA422006K	517549410	GHA242007K
22706424	GHA400290	46538958	GHA230105	71768167	GHA400188K	93271760	GHA433003	547407601	GHA425004K
22706425	GHA330016	46554134	GHA230047K	71769492	GHA230047K	93293082	GHA400058K	812025159	GHA230144K
22706967	GHA330012	46554135	GHA230047K	71769738	GHA230046K	93501838	GHA435003	962280244	GHA230119K
22715554	GHA333078	46739139	GHA237018K	76135140	GHA230028K	93810034	GHA245017	1300472080	GHA428004
22721886	GHA400212	46745258	GHA425009	82403117	GHA235014K	93852713	GHA400054	1307355080	GHA435001
24413034	GHA330011K	46798592	GHA422007	82491391	GHA422018	94628790	GHA499051	1328045080	GHA428006
24421906	GHA400137K	50003785	GHA422016	82494391	GHA422018	94639054	GHA499085	1328053080	GHA435002
25737778	GHA330036	50704683	GHA230097K	86723710	GHA336006K	94852714	GHA400036K	1346652080	GHA435002
25760931	GHA330004	50706067	GHA330025K	86723715	GHA336006K	95015335	GHA400091K	1346653080	GHA428006
25784448	GHA333108	50707555	GHA330025K	88955477	GHA333083K	95242741	GHA433014	1401393480	GHA400182K
25832143	GHA400327	50707556	GHA400206K	88957259	GHA330001K	95492092	GHA422027K	1606291880	GHA325018K
25832144	GHA327047	51733843	GHA425008	88964096	GHA333072	95496146	GHA232004K	1606635580	GHA230046K
25840786	GHA400078	51748680	GHA330011K	88964105	GHA400306	95512288	GHA230092S	1663340206	GHA330047
25848366	GHA333108	51749115	GHA400137K	88964177	GHA400313	95619162	GHA232004K	1698910027	GHA400240K
25903295	GHA330008K	51750868	GHA435004	88964968	GHA333083K	95666965	GHA232022K	2013571708	GHA425048
25903358	GHA330010K	51753218	GHA435003	88967258	GHA333079	95903586	GHA225021K	2033570008	GHA425048
25918329	GHA333075	51754192	GHA230044K	88967271	GHA400299	95903587	GHA225025K	2033570108	GHA425048
25933291	GHA333103	51754195	GHA235021K	88967287	GHA400144	96115666	GHA499002	2043300425	GHA499042
25964540	GHA333095	51754196	GHA230120K	88967288	GHA330027	96142932	GHA225037K	2043300625	GHA499042
25976819	GHA333075	51754941	GHA242007K	88970097	GHA400077	96162249	GHA433013	2103300325	GHA235024K
25999685	GHA333079	51754942	GHA242008K	89047639	GHA330036	96176252	GHA422006K	2103340301	GHA235024K
29801902	GHA235024K	51757885	GHA230118K	89047669	GHA330004	96205939	GHA433017	2115016191	GHA412001
29802002	GHA235024K	51759727	GHA230047K	89047684	GHA333083K	96219448	GHA230131	2119810227	GHA249002K
30002467	GHA228033K	51782549	GHA422015	89047802	GHA333083K	96219449	GHA230123K	2309810127	GHA249005K
30025890	GHA241002	51787397	GHA230092K	89047803	GHA333072	96219450	GHA230124	3055011171	GHA499044
30025891	GHA241002	51810086	GHA230086K	89059056	GHA400147	96219473	GHA230123K	3115015812	GHA412002
30639875	GHA336011K	51810087	GHA230128	89059058	GHA333068	96219474	GHA230131	4142009401	GHA400169K
30639876	GHA336012K	51810395	GHA230127	89059059	GHA333041	96264600	GHA230119K	4142009403	GHA400169K
30639877	GHA336014K	51813925	GHA242009S	89060208	GHA330035	96268475	GHA433001	4142009702	GHA328005K
30666104	GHA400174K	51832400	GHA230115K	90095270	GHA433007	96285980	GHA400091K	4143108001	GHA245021
30666540	GHA336012K	71753811	GHA242008K	90129572	GHA499004	96292254	GHA328008	4230132060	GHA426052
30666541	GHA336012K	52007851	GHA333058	90142161	GHA499022	96316756	GHA423018	4240906010	GHA230026K
30666606	GHA400174K	52008220	GHA333022	90157724	GHA422006K	96316757	GHA423010	4240906020	GHA230026K
30682223	GHA400174K	52009406	GHA242005	90235435	GHA235013	96328247	GHA400091K	4240906040	GHA400086K
30683161	GHA336010K	52009528	GHA242004	90235571	GHA235001K	96328248	GHA400049	4240907020	GHA230026K
30711730	GHA336010K	52098679	GHA327015K	90251816	GHA433007	96328337	GHA328003K	4240919015	GHA228006K
30714730	GHA336010K	53000228	GHA327016	90468645	GHA422023	96451751	GHA400049	4240920010	GHA230038K
30736501	GHA340003K	53000230	GHA327016	90468646	GHA433019	96451752	GHA400091K	4240932010	GHA230026K
30736653	GHA336010K	53007449	GHA327010K	90486467	GHA235001K	96471773	GHA225021K	4240933010	GHA230026K
30736885	GHA400174K	51787397	GHA230092K	90496444	GHA433004	96471775	GHA225021K	4240933020	GHA230026K
30748191	GHA336012K	52007851	GHA333058	90498610	GHA422006K	96471776	GHA225025K	4240933030	GHA230026K
30748192	GHA336014K	60552720	GHA235021K	90510543	GHA400052K	96535041	GHA422027K	4240933040	GHA230026K
30748989	GHA400285K	60613615	GHA230104K	90510629	GHA400064K	96535041	GHA422027K	4240934010	GHA248001
30794650	GHA340004K	60652014	GHA235018K	90511494	GHA400058K	96535151	GHA499052	4240942010	GHA238001K
30812651	GHA230071K	60652720	GHA235021K	90538939	GHA333036K	96535152	GHA499053	4241001010	GHA400077
30819062	GHA336011K	60656090	GHA230120K	90538941	GHA333029K	96549779	GHA433010	4241001020	GHA400077
30889072	GHA230071K	60671437	GHA242009K	90540069	GHA400064K	96591235	GHA499055	4241002080	GHA400077
31201010	GHA336014K	60806445	GHA230028K	90540262	GHA400058K	96626339	GHA330010K	4241002100	GHA400059
31201011	GHA336012K	60809721	GHA230028K	90575809	GHA333102K	96626439	GHA330008K	4241002101	GHA400059
31212698	GHA336010K	60811481	GHA230028K	90576767	GHA422014	96639584	GHA328008	4241002140	GHA400059
31262040	GHA400253K	60815883	GHA230044K	91159916	GHA235025	96639584	GHA328008	4241002170	GHA400093
31262356	GHA336016K	60816007	GHA230046K	91166212	GHA235025	96639585	GHA328003K	4241002171	GHA400093
31262571	GHA400174K	60816766	GHA242009K	91738720	GHA400109K	96639606	GHA400091K	4241002180	GHA400093
31262950	GHA336010K	71714463	GHA230046K	91738724	GHA400109K	96639607	GHA400049	4241006010	GHA230026K
31277808	GHA400253K	71714471	GHA230046K	91739910	GHA336006K	96812619	GHA328003K	4241006030	GHA400113
31277809	GHA336016K	71714474	GHA230111K	91739912	GHA336006K	175407615	GHA422012K	4241006050	GHA400113
31277810	GHA336015K	71714476	GHA230044K	92115771	GHA400040	191407615	GHA422004	4241006091	GHA400024
31280051	GHA400174K	71714477	GHA230044K	92115772	GHA400042	306398750	GHA336011K	4241008010	GHA326046
31329968	GHA400253K	71714478	GHA242009K	92192305	GHA400152	306398760	GHA336012K	4241012090	GHA400054
31329980	GHA336006K	71729121	GHA230047K	93161254	GHA235025	306831610	GHA336010K	4241012210	GHA400059
31340099	GHA336012K	71736330	GHA230097K	93168760	GHA230092S	307147300	GHA336010K	4241012211	GHA400059
31340100	GHA336012K	71737189	GHA230046K	93170611	GHA400137K	307147306	GHA336010K	4241012240	GHA326043
31340119	GHA400285K	71737612	GHA230044K	93171495	GHA330011K	307365010	GHA336006K	4241012250	GHA326053
31340604	GHA336010K	71737613	GHA230044K	93175327	GHA330011K	307481910	GHA336012K	4241012260	GHA400077
31340686	GHA400174K	71737614	GHA230046K	93178625	GHA400153K	307481920	GHA336014K	4241012300	GHA400093
31360027	GHA336016K	71737615	GHA230097K	93178626	GHA400133K	307489890	GHA336014K	4241020150	GHA230038K
31360096	GHA340003K	71737769	GHA230097K	93178651	GHA333069K	308126515	GHA230071K	4241020190	GHA400077
31360097	GHA340004K	71738029	GHA242009K	93178652	GHA333070K	308890722	GHA230071K	4241030020	GHA330029
34505248	GHA230110K	71747713	GHA230092K	93178661	GHA330021K	312010100	GHA336014K	4241030040	GHA330046
35160373	GHA235011K	71747857	GHA320001K	93186387	GHA330011K	312010110	GHA336012K	4241032031	GHA230026K
46425959	GHA230028K	71753810	GHA242007K	93186388	GHA330021K	312129490	GHA230020K	4241032100	GHA326057
46426612	GHA235022K	71736330	GHA230097K	93186389	GHA330013K	321501117	GHA499044	4241033010	GHA230026K

COMPETITOR	G-AP Ref.	COMPETITOR	G-AP Ref.	COMPETITOR	G-AP Ref.	COMPETITOR	G-AP Ref.	COMPETITOR	G-AP Ref.
OE		4245042020	GHA400121	4355028010	GHA326024K	5271034500	GHA234008K	8124130450	GHA327012K
		4245042030	GHA400121	4355028030	GHA330014K	5271034501	GHA234008K	8151002740	GHA327046
4241033020	GHA230026K	4245042040	GHA400238	4355030010	GHA400237	5271034600	GHA234003K	8151002750	GHA327045
4241033050	GHA400113	4245042050	GHA400121	4355030020	GHA400237	5271034700	GHA234003K	8151308580	GHA327027
4241033060	GHA400113	4245044010	GHA400184	4355030030	GHA330045	5271034701	GHA234003K	8200002874	GHA230142K
4241042010	GHA400129K	4245044040	GHA400121	4355030050	GHA400282	5271034800	GHA234003K	8200208332	GHA421004A
4241042020	GHA326027K	4245047030	GHA400095	4355042010	GHA326024K	5271034801	GHA234003K	8200217106	GHA499032K
4241042030	GHA400129K	4245047040	GHA400166	4355042020	GHA330014K	5273038000	GHA400037	8200218779	GHA235025
4241042040	GHA326030K	4245047050	GHA400234	4355047010	GHA326039	5273038001	GHA400037	8200228610	GHA235025
4241042050	GHA400129K	4245048010	GHA400060	4355047011	GHA326039	5273038002	GHA400037	8200244108	GHA230142K
4241044021	GHA326046	4245048011	GHA400060	4355050010	GHA400292	5273038003	GHA400037	8200308649	GHA423003K
4241048040	GHA326036	4245048030	GHA400126	4355050011	GHA400292	5273038100	GHA400004	8200367094	GHA230141K
4241048041	GHA326036	4245048040	GHA400236	4355050032	GHA400292	5273038101	GHA400004	8200381148	GHA230144K
4241048060	GHA326032K	4245048050	GHA400360	4355062010	GHA254001K	5273038102	GHA400004	8200649353	GHA230142K
4241050010	GHA330037	4245052020	GHA400008	4356026010	GHA254901	5273038103	GHA400004	8200655249	GHA230141K
4241050020	GHA330037	4245052021	GHA400008	4356026011	GHA254001K	5273039000	GHA400231	8671006223	GHA232004K
4241050030	GHA330020K	4245052060	GHA400087K	4356030010	GHA400210	5273039011	GHA400231	8953007449	GHA326020K
4241052020	GHA400007	4245052080	GHA400350	4356030030	GHA330044	5273039012	GHA400231	8972099651	GHA400293
4241052021	GHA400007	4245052090	GHA400233	4357004010	GHA254003K	5273039013	GHA400231	8972099652	GHA400293
4241052070	GHA400098	4245052100	GHA400233	4357060010	GHA254003K	5274537000	GHA228035K	8972099653	GHA400293
4241052090	GHA326054K	4245060070	GHA249003	4357060030	GHA258001	5275026100	GHA235023K	8972099654	GHA400293
4241060060	GHA244006	4245063011	GHA400095	4357060031	GHA258001	5275026101	GHA235023K	8973633590	GHA400293
4241087701	GHA228009	4245076020	GHA400351	4513300059	GHA400254	5862030150	GHA245003	9030163003	GHA230026K
4242120020	GHA230038K	4246004010	GHA244001	4513300159	GHA400254	5862062990	GHA234004K	9036938019	GHA230026K
4244060020	GHA244005	4246006010	GHA400061	4513500135	GHA33076K	6001547685	GHA421012	9063304020	GHA400354K
4245002020	GHA400036K	4246006020	GHA400061	4513500235	GHA33076K	6001548299	GHA499032K	9063304120	GHA400354K
4245002030	GHA228006K	4246006021	GHA400061	4543300020	GHA325026K	6025102558	GHA230116K	9063304920	GHA400354K
4245002060	GHA400010	4246006030	GHA400061	4543300025	GHA325026K	6025171136	GHA230113K	9063305020	GHA400354K
4245002070	GHA400010	4246006040	GHA400061	4543300059	GHA325026K	6025171137	GHA230116K	9063500149	GHA329008K
4245002081	GHA400062	4246006060	GHA400061	4543300120	GHA325026K	6025370612	GHA230075A	9063500249	GHA329013
4245002090	GHA400010	4246006070	GHA400345	4543300159	GHA325026K	6383340101	GHA427019	9063503710	GHA329008K
4245002100	GHA400062	4246006090	GHA400344	4543500135	GHA400135K	6393301832	GHA400051K	9063503810	GHA329008K
4245002120	GHA400079	4246006120	GHA400344	5175002000	GHA425016	6393301932	GHA400051K	9403350718	GHA230121K
4245002130	GHA400079	4246033010	GHA400344	5175007001	GHA424019	7700313184	GHA428007	9567217780	GHA230111K
4245002170	GHA400309	4246048010	GHA400061	5175024500	GHA425001	7700415121	GHA423003K	9671326080	GHA400335K
4245002210	GHA400094	4246048011	GHA400061	5175250000	GHA425002	7700416374	GHA499032K	9685863380	GHA232031K
4245002211	GHA400309	4246048030	GHA400125	5175025001	GHA425002	7700433290	GHA421010	11023104015	GHA499023
4245002250	GHA400090	4246048040	GHA400321	5175028000	GHA425001	7700704704	GHA421001	21083103012	GHA422029
4245004010	GHA244002	4246060030	GHA249004	5175029000	GHA425044	7700719140	GHA421001	21213103012	GHA422010
4245005011	GHA400067	4260733011	GHA400350	5175029100	GHA425045	7700768318	GHA421004A	21233103012	GHA424013
4245005040	GHA400095	4350202030	GHA426022	5175380000	GHA427006	7700768319	GHA421004A	31201095616	GHA400001K
4245005060	GHA400241	4350202050	GHA426034	5175039600	GHA427020	7700787641	GHA225034K	31204081309	GHA400268K
4245005080	GHA400269	4350202070	GHA426034	5271002300	GHA228067K	7700803924	GHA225034K	31206775771	GHA400268K
4245006010	GHA400086K	4350202110	GHA426030K	5271002500	GHA228049K	7700803928	GHA225020K	31206779735	GHA330026K
4245006020	GHA400060	4350202120	GHA426030K	5271002550	GHA228067K	7700803929	GHA225020K	31206791007	GHA400268K
4245006021	GHA400060	4350205021	GHA426030K	5271017000	GHA230403	7700820849	GHA225006F	31206794850	GHA400314K
4245006030	GHA400060	4350206030	GHA426039	5271017100	GHA232008K	7700830220	GHA423001	31206795959	GHA330026K
4245006040	GHA400060	4350206040	GHA430001K	5271022000	GHA228017K	7701204667	GHA225020K	31206850158	GHA400268K
4245006080	GHA400060	4350212090	GHA426021	5271022100	GHA228035K	7701204689	GHA225006F	31206857230	GHA400314K
4245006110	GHA400346	4350212110	GHA426023K	5271022100	GHA228031K	7701204690	GHA225003K	31206867256	GHA400314K
4245006130	GHA400343	4350212140	GHA426022	5271022300	GHA228035K	7701204693	GHA225034K	31209813211	GHA326042
4245006160	GHA400343	4350216040	GHA426013	5271022300	GHA228031K	7701204866	GHA225022K	31211123435	GHA237004K
4245007010	GHA400086K	4350222080	GHA499084	5271022400	GHA228017K	7701204867	GHA225022K	31211124439	GHA237004K
4245008010	GHA400141	4350226110	GHA499049	5271022500	GHA228031K	7701204868	GHA225036K	31211126117	GHA237004K
4245008020	GHA400167K	4350228090	GHA426026	5271022600	GHA228035K	7701204901	GHA225039K	31211126478	GHA237004K
4245008030	GHA400348	4350228100	GHA430005K	5271025000	GHA228022K	7701205170	GHA225015K	31211127307	GHA231001K
4245012070	GHA400010	4350232050	GHA426005K	5271025001	GHA228022K	7701205471	GHA225035K	31211128157	GHA231001K
4245012081	GHA400010	4350232070	GHA426015K	5271025100	GHA228034K	7701205477	GHA225022K	31211128158	GHA231001K
4245012090	GHA400090	4350232080	GHA426030K	5271025101	GHA228034K	7701205499	GHA225026K	31211128569	GHA231001K
4245012100	GHA400079	4350233010	GHA430001K	5271029100	GHA228035K	7701206327	GHA225018K	31211129382	GHA237001K
4245012110	GHA400269	4350242010	GHA426041	5271029150	GHA228028K	7701206328	GHA225018K	31211129386	GHA237001K
4245012170	GHA400309	4350242020	GHA426049K	5271029400	GHA228018K	7701206353	GHA225027K	31211129396	GHA237001K
4245013010	GHA400010	4350252010	GHA424016K	5271029400	GHA228035K	7701206354	GHA225028K	31211130530	GHA237004K
4245020020	GHA400067	4350252030	GHA426024	5271029450	GHA228028K	7701206846	GHA235025	31211131297	GHA231001K
4245020050	GHA230038K	4350260180	GHA430008	5271029450	GHA228035K	7701207611	GHA225040K	31211131298	GHA237004K
4245020051	GHA230038K	4350260190	GHA436007	5271029460	GHA228028K	7701207823	GHA225019K	31211137996	GHA237003K
4245020080	GHA400349	4350260201	GHA430008	5271029461	GHA228028K	7701207898	GHA225041K	31211139345	GHA237002K
4245028010	GHA400167K	4351047010	GHA326028K	5271029470	GHA228028K	7701208054	GHA225039K	31211468751	GHA237001K
4245028011	GHA400167K	4351047011	GHA326028K	5271029471	GHA228028K	7701208075	GHA225030K	31211468752	GHA231001K
4245028012	GHA400167K	4351450010	GHA400184	5271029670	GHA228068K	7701208230	GHA230140K	31211468753	GHA237004K
4245028030	GHA400310	4355002010	GHA326024K	5271029670	GHA228028K	7701209503	GHA225019K	31211468926	GHA237002K
4245028041	GHA400347	4355002020	GHA330014K	5271029671	GHA228068K	7701472838	GHA230141K	31212225362	GHA237004K
4245032040	GHA400095	4355002030	GHA326024K	5271029671	GHA228028K	7701713008	GHA230141K	31212226640	GHA237001K
4245032041	GHA400095	4355002040	GHA330014K	5271033500	GHA234003K	7704002262	GHA225020K	31212226904	GHA237001K
4245033010	GHA230026K	4355002070	GHA326024K	5271033600	GHA234003K	7704002263	GHA225020K	31216765157	GHA400171K
4245033030	GHA400343	4355002080	GHA330014K	5271033700	GHA234008K	7711130076	GHA235025	31221092519	GHA237003K
4245042010	GHA400121	4355017010	GHA400295	5271033701	GHA234008K	8124130370	GHA327027	31221093427	GHA400001K

COMPETITOR	G-AP Ref.	COMPETITOR	G-AP Ref.	COMPETITOR	G-AP Ref.	COMPETITOR	G-AP Ref.	COMPETITOR	G-AP Ref.
OE		191501118D	GHA499015	28373FG010	GHA327056	3F132C299CA	GHA231005	40202EA300	GHA329003
		1C1J1K018AA	GHA245009K	28373XA00A	GHA327052	3F132C300BA	GHA326009	40202EB70B	GHA400160
31221137996	GHA237003K	1F0233061	GHA327017	28373XA00B	GHA327052	3F1Z1104AA	GHA231002	40202ED71A	GHA400172
31221139345	GHA237002K	1F122C299CA	GHA231005	28473AE01A	GHA325003	3F1Z1104BA	GHA326009	40202EB000	GHA325024
31221468926	GHA237002K	1F1Z1104AA	GHA231002	28473AG001	GHA325025K	3F1Z1104CA	GHA231005	40202EE500	GHA325016K
31222229501	GHA237002K	1F1Z1104CA	GHA231005	28473AG00A	GHA325025K	3F1Z1104DA	GHA231009	40202EE50A	GHA325020
31226750217	GHA400248K	1F1Z1104DA	GHA231009	28473AG00B	GHA325025K	3F232C513AG	GHA326029	40202EE91B	GHA325020
31226756889	GHA326026K	1F222B664AB	GHA231006	28473FG000	GHA327038K	3F232C513AH	GHA326029	40202EG000	GHA400203
31226757024	GHA237002K	1F222C300AA	GHA326006	28473FG010	GHA327054	3F232C513AJ	GHA326029	40202EJ70A	GHA400203
31226756501	GHA400170K	1F222C300BA	GHA326006	28473FJ020	GHA327049	3F2Z1104AA	GHA326029	40202EJ70B	GHA327035
31226776162	GHA326031K	1F2Z1104AA	GHA326006	28473SC000	GHA327038K	3F2Z1104AB	GHA326035	40202EL000	GHA325016K
31226776671	GHA326031K	1F6033061	GHA327033	28473XA00A	GHA327057	3F2Z1109AA	GHA400214	40202EM00A	GHA325016K
33406850156	GHA249006K	1F7033061	GHA327017	28473XA00B	GHA327057	3F2Z1109AB	GHA400215	40202EM30A	GHA325016K
33406850159	GHA249006K	1H0407613A	GHA436001	28474AE000	GHA240008K	3L241104AB	GHA327033	40202EM30C	GHA325016K
33409806302	GHA400279	1H0407613B	GHA436001	28474AE00A	GHA240008K	3L241104AC	GHA327033	40202EN010	GHA329006K
33411093102	GHA245001K	1J0407613B	GHA436002K	28474AE01A	GHA240008K	3L241K018AA	GHA327024K	40202ET00A	GHA400357
33411093567	GHA427008	1J0407613C	GHA436002K	2E0407303AA	GHA400354K	3L241K018AB	GHA327024K	40202ET010	GHA329021
33411093725	GHA245001K	1J0407613G	GHA436002K	2E0407303P	GHA400354K	3L241W002AA	GHA429001K	40202ET010	GHA400357
33411095238	GHA245012K	1J0407615A	GHA436005	2E0407303Q	GHA400354K	3L2Z1104AA	GHA327033	40202ET01A	GHA329021
33411095462	GHA245001K	1J0501477A	GHA230051K	2E0407303R	GHA400354K	3L2Z1104AB	GHA327024K	40202F4200	GHA425017
33411095652	GHA245001K	1J0501611A	GHA230051K	2E0407303S	GHA400354K	3L2Z1109AA	GHA429001K	40202JA000	GHA329019
33411095654	GHA245001K	1J0501611B	GHA230051K	2E0407304P	GHA400354K	3L2Z1109AA	GHA429001K	40202JA010	GHA329019
33411131118	GHA427003	1J0501611C	GHA230051K	2E0407304Q	GHA400354K	3L541104AA	GHA327033	40202JA100	GHA332024
33411136180	GHA427008	1J0598477	GHA230051K	2E0407304S	GHA400354K	3L541104AB	GHA327033	40202JG000	GHA329006K
33411468753	GHA237002K	1K0407621D	GHA336004K	2E0501171E	GHA329008K	3L5Z1104AA	GHA327033	40202JG01A	GHA329006K
33416756830	GHA400154K	1K0407621E	GHA336004K	2E0501171G	GHA329008K	3M512C299	GHA400084K	40202JG01B	GHA329006K
33416760056	GHA427011	1K0407621G	GHA336007K	2E0501172D	GHA329008K	3M512C300CH	GHA336003K	40202JP11A	GHA332023
33416762314	GHA245012K	1K0498621	GHA336004K	2E0501172F	GHA329008K	3N612C299A	GHA400106	40202JR70B	GHA329005
33416770974	GHA251003	1K0501611G	GHA230082K	2K0498621A	GHA336007K	3N612C300AD	GHA336008	40202JR70C	GHA329005
33416775021	GHA249006K	1K0598611	GHA230082K	2L141A049AA	GHA333091	3R832B663BA	GHA400181	40202JR71A	GHA329009
33416786552	GHA400134F	1L141104AA	GHA333019	2L142B664AA	GHA333091	3W121104BA	GHA400146	40202JX00A	GHA329010
33416786620	GHA400134K	1L241104AC	GHA327024K	2L142B664AB	GHA333091	3W132B663BA	GHA400146	40202JY00A	GHA329006K
33416795961	GHA251003	1L241104AD	GHA327024K	2L142B664AC	GHA333091	3W132B663BB	GHA400146	40202Y02G0	GHA425017
42450200510	GHA230038K	1L241104AE	GHA327024K	2L142B664AD	GHA333091	3W1Z1104AA	GHA400146	40202ZM70A	GHA329001K
95833158300	GHA251002K	1L241104AF	GHA327024K	2L142B664AE	GHA333091	3W1Z1104BA	GHA400146	40202ZP50A	GHA400127
95834190100	GHA251002K	1L241104AG	GHA327024K	2L142B664AF	GHA333091	3W432B663BA	GHA400076	40202ZR90A	GHA329003
0001870V023000000	GHA228058K	1L241K018AB	GHA327024K	2L1Z1104CA	GHA400202	3W4Z1104BA	GHA400076	40202ZR00B	GHA329024
021149002A	GHA230002F	1L241W002AA	GHA429001K	2L1Z1104DA	GHA400222	400010M8R5	GHA227006	40202ZR40A	GHA329024
04509766AA	GHA228048	1L2Z1104AA	GHA327024K	2L1Z1109AA	GHA333091	400012F5R5	GHA230039K	40202ZR40B	GHA329024
04593462AA	GHA326008	1L2Z1104AB	GHA327024K	2L1Z1215BA	GHA400222	402000V010	GHA234010	40202ZW70A	GHA325016K
04721578AD	GHA332002	1L2Z1109AA	GHA429001K	2L211104AA	GHA327024K	4020205A00	GHA424007	40202ZX00A	GHA329019
04766719AA	GHA400072K	1L2Z1109AB	GHA429001K	2L241K018AB	GHA327024K	402020M010	GHA425017	40202ZX10A	GHA332024
04779199AA	GHA237013	1L2Z1215AB	GHA327024K	2L2Z1104AA	GHA327024K	402020W093	GHA499064	40204AX600	GHA423003K
04779328AA	GHA327040K	1L341104AA	GHA333045	2L2Z1104AB	GHA327024K	402021AB0A	GHA329019	40210AL800	GHA243011
0482-CSF	GHA425033	1L341104BA	GHA333018	2S611104DA	GHA425004K	402021FC0A	GHA325016K	40210VW000	GHA251001
04860074AA	GHA228071	1L3Z1104BA	GHA333018	2W432B663AA	GHA400076	402021FC0B	GHA325016K	40210VV610	GHA251001
05010018AA	GHA333042	1R332B633AA1R3	GHA234502	2W4Z1104AA	GHA400076	402021LB0B	GHA332025	40210WL000	GHA251004
05016458AA	GHA327013	1R3Z1104AA	GHA234502	312111293821	GHA237001K	402022291R	GHA230143K	40210WL020	GHA251004
05085406AC	GHA332001K	1R3Z1104AB	GHA234502	333501117A	GHA499046	402022560R	GHA329006K	42200S04005	GHA228030K
0K01133061E	GHA499066	1R3Z1104BA	GHA234502	333501118A	GHA499045	402022Y000	GHA429002K	42200S04008	GHA228030K
0K20226150	GHA230035K	1S0598611	GHA228061K	357407613B	GHA422036K	402022Y010	GHA429004K	42200S04028	GHA228030K
0K21626150	GHA230066K	1S712C299AC	GHA400081K	357501117A	GHA499044	402023JA0A	GHA332024	42200S04951	GHA228032K
0K2N133061	GHA428016	1T0498621	GHA336007K	374841A	GHA225016	402023ZG1A	GHA332024	42200S0XA50	GHA234007
0K2N133061A	GHA428016	1T0598611	GHA232018K	3748A3	GHA400182K	402024076R	GHA230144K	42200S0XA51	GHA234007
0K30A26115C	GHA499065	1T0598611A	GHA232018K	3748A6	GHA232031K	402024F105	GHA423017	42200S0XA52	GHA234007
0K55233060	GHA428011K	1T0598611B	GHA232018K	3785A008	GHA400176K	402024M400	GHA425018K	42200S1008LH	GHA239004
0K9A226150	GHA233007K	2072V009000000	GHA324002K	3785A008	GHA400072K	402024M405	GHA425018K	42200S10008RH	GHA239001
0K9A233061A	GHA428017	2072V010000000	GHA324002K	3785A009	GHA325018K	402024U010	GHA427017	42200S10018	GHA239003
0K9A326150	GHA233016	21149002A	GHA230002F	3785A015	GHA327044K	402024X00A	GHA400127	42200S1AE01	GHA230112K
0K9A426150	GHA233007K	2115016191CTR	GHA412001	3785A019	GHA327044K	402024X01A	GHA329003	42200S1AE02	GHA230112K
0K9A426150	GHA233016	28052AA000	GHA427024	3785A035	GHA325030	402025X00A	GHA329014	42200S1AE21	GHA230093K
0K9A526150	GHA233007K	28052AA001	GHA427024	3785A064	GHA325030	402027585R	GHA325019K	42200S2XJ51	GHA230067K
1-04721010AC	GHA332009K	28052AA010	GHA427023	3880A018	GHA428015K	402027S000	GHA329017	42200S30008	GHA230095
104779328AA	GHA327040K	28063AA000	GHA230114	3925235F03	GHA243006K	402027S100	GHA329017	42200S30951	GHA230023K
1-05105233AC	GHA332010K	28063AA000NT	GHA230114	3C0498621	GHA336007K	402029HC0A	GHA329019	42200S30C01	GHA230023K
120224A1046	GHA230101	28063AA010NT	GHA230114	3C342B513BA	GHA355005K	40202AL510	GHA400247	42200S30C11	GHA230023K
12413060	GHA330001K	28063AA011	GHA230114	3C342B513BB	GHA355005K	40202AL56C	GHA400247	42200S30C51	GHA230020K
1-52060398AC	GHA332008K	28063AC000	GHA230114	3C342B513BC	GHA355005K	40202AX000	GHA425041K	42200S30J51	GHA230020K
1-52111884AB	GHA329007	28362AE000	GHA427024	3C342B513CA	GHA355004K	40202BA60A	GHA329006K	42200S3MA51	GHA230130
184HUB	GHA424011	28362AE001	GHA427024	3C342B513CB	GHA355004K	40202BU000	GHA427017	42200S3MA52	GHA230130
1870V021000000	GHA228058K	28373AG000	GHA327039K	3C342B513CC	GHA355004K	40202CA000	GHA329001K	42200S3Y951	GHA223001

COMPETITOR	G-AP Ref.	COMPETITOR	G-AP Ref.	COMPETITOR	G-AP Ref.	COMPETITOR	G-AP Ref.	COMPETITOR	G-AP Ref.
OE		42200SNC951	GHA400316	424500T010	GHA400328	4320090J26	GHA227026K	43202JY30A	GHA325019K
		42200SR3005	GHA228030K	424500TVA10	GHA400200	432009F500	GHA230094K	43202WLO10	GHA429006
42200S84A01	GHA230072	42200SR3008	GHA228030K	424600C010	GHA249004	432009F510	GHA230039K	43202ZB600	GHA400011
42200S84A31	GHA230030K	42200SR3A02	GHA230014K	424600E010	GHA400125	43200AD000	GHA234011	43202ZP80A	GHA332005K
42200S84A51	GHA230030K	42200SR3A04	GHA230014K	424600E020	GHA400235	43200AD001	GHA234011	4320600QAB	GHA235025
42200S84C01	GHA230072	42200SR3A05	GHA230014K	424600T010	GHA400329	43200AV700	GHA230058K	4321035F01	GHA243005
42200S84C31	GHA230030K	42200SR3A052	GHA230014K	4246Z9	GHA225042K	43200BM400	GHA230070	43210AA100	GHA243005
42200S84C51	GHA230030K	42200SR3A06	GHA230014K	42611SB2005	GHA228030K	43200BM400	GHA230094K	43210AL500	GHA243006K
42200S84C52	GHA230030K	42200SR3A52	GHA230015K	42611SB2025	GHA228030K	43200BM500	GHA230080K	43210AL505	GHA243006K
42200S87A51	GHA230024K	42200SR3A53	GHA230015K	430421HA0A	GHA499080	43200WE000	GHA230152	43210EA200	GHA242015
42200S87C51	GHA230024K	42200ST3E02	GHA230014K	43042AX600	GHA499032K	43200WE205	GHA230011	43210WL000	GHA250010
42200S87C52	GHA230024K	42200ST3E51	GHA230015K	432000007R	GHA230138K	4320200QAC	GHA225030K	432340L700	GHA230039K
42200SAA502	GHA228019K	42200ST3E52	GHA230015K	432000007RD	GHA230138K	432020L710	GHA230052K	4340160G20	GHA228027K
42200SAAE03	GHA228038K	42200STK951	GHA328002K	432000010R	GHA230137K	432020M000	GHA227001K	4340165D00	GHA241001
42200SAAAG01	GHA228019K	42200STXA02	GHA328013	432000015R	GHA230143K	432021AA0B	GHA329023	4340165D10	GHA241002
42200SAAAG02	GHA228019K	42200SV1008	GHA230003K	4320006B00	GHA232009	432021E401	GHA230034K	4340165J00	GHA328007K
42200SAAAG51	GHA228029K	42200SV1J01	GHA230003K	432000L700	GHA230062	432021J61A	GHA400096	4340165J0000	GHA328007K
42200SAHG51	GHA228029K	42200SV1J51	GHA230017K	432000M000	GHA227001K	432021J62A	GHA400357	4340165J01	GHA328007K
42200SB2003	GHA225008	42200SV1N51	GHA230017K	432000M001	GHA227001K	432021KA0A	GHA400194	4340165J01000	GHA328007K
42200SB2005	GHA225008	42200SV2N00	GHA234001	432000M801	GHA227006	4320230R06	GHA230034K	4340165J02	GHA328007K
42200SB2008	GHA225008	42200SV2N01	GHA234001	432000Z801	GHA230034K	4320230R07	GHA230034K	4340165J02000	GHA328007K
42200SB2015	GHA228030K	42200SV2N02	GHA234002	432001539R	GHA225038K	4320234B00	GHA227022F	4340254G10	GHA228027K
42200SB2018	GHA228030K	42200SV2N50	GHA234002	432001E400	GHA230034K	432023939R	GHA230144K	4340254G11	GHA228027K
42200SB2025	GHA228030K	42200SV2N51	GHA234002	432001E401	GHA230034K	432023JA0A	GHA400183	4340254G12	GHA228027K
42200SB2028	GHA228030K	42200SV4008	GHA230003K	432001L000	GHA230004	432023JA0B	GHA329015K	4340254G20	GHA228026K
42200SCVA01	GHA243010	42200SV4J01	GHA230003K	432001L005	GHA230004	432023Z000	GHA400117	4340254G21	GHA228026K
42200SCVA02	GHA243010	42200SV4J51	GHA230017K	432002F500	GHA230039K	432023Z010	GHA400011	4340254G22	GHA228026K
42200SCVA31	GHA243008	42200SV4N01	GHA234001	432002Y000	GHA230052K	432024048R	GHA230138K	4340257K00	GHA228074K
42200SD2005	GHA228015	42200SV4N02	GHA234001	4320030R06	GHA230034K	432024B000	GHA227001K	4340257L50	GHA328007K
42200SD2008	GHA228015	42200SV4N51	GHA234002	4320030R07	GHA230034K	432024B010	GHA227001K	4340257L50000	GHA328007K
42200SDAA51	GHA230022	42200SWB951	GHA400116	4320031U06	GHA230062	432024M400	GHA227019	4340257L51	GHA328007K
42200SE0000	GHA230014K	42200SX8008	GHA228030K	4320037U06	GHA230004	432024X00A	GHA332005K	4340260G10	GHA228027K
42200SE0004	GHA230014K	42200SZ3951	GHA234004K	4320037U07	GHA230004	4320250Y00	GHA227001K	4340260G11	GHA228027K
42200SE0008	GHA230014K	42200SZT008	GHA230134K	432004327R	GHA230144K	4320250Y01	GHA227001K	4340260G21	GHA228026K
42200SE0955	GHA230014K	42200TA0A51	GHA400101	432004B000	GHA227001K	4320250Y02	GHA227001K	4340260G22	GHA228026K
42200SE0956	GHA230014K	42200TC0751	GHA400101	432004B010	GHA227001K	4320250Y05	GHA227001K	4340264B01	GHA228033K
42200SE0J01	GHA230014K	42200TF0N51	GHA230068K	432004F100	GHA227022F	4320250Y06	GHA227001K	4340268L00	GHA400198
42200SE0J02	GHA230014K	42200TF0Z51	GHA230069	432004F105	GHA227022F	4320250Y07	GHA227001K	4340271L00	GHA400199
42200SEA951	GHA400068	42200TL0G51	GHA400275	432004F106	GHA227022F	43202621B00	GHA227022F	4340271L50	GHA324004K
42200SED951	GHA234005K	42201S10008	GHA239004	432004F116	GHA227022F	4320265E10	GHA230034K	4340277A00	GHA228051K
42200SED952	GHA234005K	42201S10018LH	GHA239002	432004F800	GHA227017K	4320265E15	GHA230034K	4340277A01	GHA228051K
42200SELG01	GHA228050	42201S10018RH	GHA239003	432004F805	GHA227017K	4320270N05	GHA230034K	4340277A21	GHA228057K
42200SELT51	GHA228019K	42201S10A01	GHA243003K	432004F806	GHA227017K	4320270N06	GHA230034K	4340278J00	GHA330008K
42200SF4008	GHA225008	42201SCVA12	GHA243009	432004M400	GHA227004K	432027B000	GHA232009	4340279J00	GHA400188K
42200SFE951	GHA400116	42210S9A000	GHA423016	432004Z000	GHA227019	432027S000	GHA332014	4340279J50	GHA324003
42200SH3008	GHA228030K	424100D010	GHA400007	432004Z005	GHA227013K	432028H300	GHA499081	4340279J50000	GHA324003
42200SH3018	GHA228030K	424100D030	GHA400007	432004Z005	GHA227019	432028J100	GHA400011	4340279J51	GHA324003
42200SH3028	GHA228030K	424100D040	GHA400098	432004Z010	GHA227019	4320295F0A	GHA227014	4340280J00	GHA400187
42200SH3970	GHA228030K	424100E020	GHA326036	4320050J00	GHA227003K	432029W200C100	GHA400011	4340285Z00	GHA400091K
42200SHJA51	GHA400216	424100E021	GHA326036	4320050J05	GHA227003K	43202AG000	GHA429003	4340285Z01	GHA400091K
42200SHJF951	GHA230135	424100E030	GHA326032K	4320050J06	GHA227003K	43202AX400	GHA323002	4340286Z00	GHA400091K
42200SHJL951	GHA326052	424100E031	GHA326032K	4320050J10	GHA227026K	43202CA000	GHA329015K	4340286Z20	GHA400049
42200SK3E01	GHA230014K	424100E050	GHA326036	4320050J15	GHA227003K	43202CK000	GHA400124	4340286Z21	GHA400049
42200SL4J51	GHA230029K	424100R010	GHA326030K	4320050J16	GHA227026K	43202CN000	GHA400011	4340286Z22	GHA400049
42200SL5A01	GHA230129	42410B1010	GHA400099	4320050J50	GHA227003K	43202EA500	GHA332005K	4342082Z20	GHA400127
42200SLAN01	GHA230069	42410B1030	GHA400099	4320050J55	GHA227026K	43202ED000	GHA400180	4342178J00	GHA330010K
42200SM1008	GHA230003K	42410B2010	GHA400115	4320050Y00	GHA227001K	43202ED51B	GHA400356	4342186Z00	GHA328008
42200SM1J51	GHA230029K	42410B2050	GHA400224	4320050Y01	GHA227001K	43202EE500	GHA400096	4342186Z01	GHA328008
42200SM4000	GHA230003K	42410B2030	GHA400115	4320050Y02	GHA227010	43202EE508	GHA400104	4342186Z20	GHA328003K
42200SM4003	GHA230003K	424500C010	GHA249003	4320050Y05	GHA227001K	43202EG000	GHA329025	4342186Z21	GHA328003K
42200SM4004	GHA230003K	424500C020	GHA258002	4320050Y06	GHA227001K	43202EG00A	GHA329025	43421A70B01	GHA423014K
42200SM4008	GHA230003K	424500D010	GHA400008	4320050Y07	GHA227010	43202EL000	GHA400096	43421A70B01000	GHA423014K
42200SM4013	GHA230003K	424500D030	GHA400008	4320050Y10	GHA227001K	43202EN000	GHA400326	4344054G01	GHA234002
42200SM4018	GHA230003K	424500D050	GHA400087K	432005F607	GHA227017K	43202EN100	GHA325019K	435020A010	GHA426013
42200SM4A01	GHA230095	424500D060	GHA400087K	432005F617	GHA227017K	43202EN11A	GHA325019K	435020D010	GHA426016K
42200SM4J01	GHA230003K	424500D080	GHA400087K	432005M000	GHA227014	43202ET000	GHA400342	435020D060	GHA426031A
42200SM4J02	GHA230003K	424500D110	GHA400276	432006506R	GHA230137K	43202ET010	GHA400320	435020K010	GHA499028
42200SM4J03	GHA230003K	424500D120	GHA400308	432006506RSK	GHA230137K	43202JA000	GHA400183	435020K030	GHA430004
42200SM4J51	GHA230029K	424500D140	GHA400308	4320065E10	GHA230034K	43202JA010	GHA400183	43502AA021	GHA430005K
42200SM5A01	GHA234001	424500D150	GHA400308	4320065E15	GHA230034K	43202JG000	GHA400161	43511BZ090	GHA499067
42200SMGG51	GHA230091K	424500E010							

COMPETITOR	G-AP Ref.	COMPETITOR	G-AP Ref.	COMPETITOR	G-AP Ref.	COMPETITOR	G-AP Ref.	COMPETITOR	G-AP Ref.
OE		4779572AA	GHA332020	517504N000	GHA424018	52128692AE	GHA327043K	5F9Z1104AA	GHA338005
		4779572AB	GHA332020	51750A5000	GHA427018	52128692AF	GHA327043K	5F9Z1104AB	GHA338002
435700C010	GHA258001	4779796AA	GHA400178	51750A6000	GHA327048	52128693AA	GHA327028	5F9Z1104BA	GHA338003
44200S3Y008	GHA237021	4779797AA	GHA400179	51750FD000	GHA424015	52128693AB	GHA327028	5K0498621	GHA336007K
44200SJA008	GHA330048K	4860074AA	GHA228071	51750M2000	GHA425050	52128693AC	GHA327028	5K0498621A	GHA336004K
44200SL5000	GHA243007	4880208AA	GHA326034	5179955AA	GHA333077	52128693AD	GHA327028	5L142B664AA	GHA333091
44200SL5003	GHA243007	4880208AB	GHA326034	52009361AB	GHA400012	52128693AE	GHA327028	5L1Z1104AA	GHA333091
44200SL5008	GHA243007	4A0501117A	GHA499047	52009406AC	GHA242005	52128693AF	GHA327028	5L1Z1104DA	GHA400222
44200SM1008	GHA243001K	4D0407625D	GHA245010K	52009406AD	GHA242005	527102C000	GHA232042	5L342C530AD	GHA400173
44200SM1018	GHA243001K	4D0407625H	GHA245010K	52009406AE	GHA242005	527102C001	GHA232040K	5L342C530AE	GHA400173
44200SM4000	GHA243001K	4D0498625	GHA247001K	52009528AC	GHA242004	527102C005	GHA232040K	5L3Z1104AA	GHA400173
44200SM4003	GHA243001K	4E0498625	GHA247001K	52009528AD	GHA242004	527102C100	GHA232024K	5L3Z1104AB	GHA400173
44200SM4013	GHA243001K	4E0498625A	GHA245007K	52009528AE	GHA242004	527102C101	GHA232024K	5L3Z1104BA	GHA400218
44200SM4018	GHA243001K	4E0498625B	GHA247001K	52009863AA	GHA333047	527102C105	GHA232037K	5L3Z1104BB	GHA400218
44200SM4J00	GHA243001K	4E0498625C	GHA247001K	52009863AC	GHA333047	527102C305	GHA232037K	5N111104AA	GHA425004K
44200SN7008	GHA243001K	4E0598625	GHA245007S	52009867AA	GHA242003	527102D000	GHA232043	5U0501117	GHA499054
44200SV7A01	GHA245003	4E0598625A	GHA245007S	52009867AB	GHA242003	527102D010	GHA232044	5W132B663BA	GHA400146
44200SX0008	GHA245003	4F0498625	GHA245007K	52060398AC	GHA332008K	527102D011	GHA232044	5W1Z1104B	GHA400146
44200SX00081	GHA245003	4F0498625A	GHA247001K	52068964AB	GHA331004	527102D012	GHA232044	5W432B663BA	GHA400076
44300STXA01	GHA330038	4F0498625B	GHA245007K	52068964AD	GHA331004	527102D015	GHA232015K	5W432B663BB	GHA400076
44600S5AJ00	GHA426029	4F0598611A	GHA400196K	52068964AE	GHA331004	527102D025	GHA232025	5W4Z1104BA	GHA400076
44600S7A000	GHA426035	4F0598611B	GHA400196K	52068964AF	GHA331004	527102D110	GHA232047	5X0407615A	GHA422011
44600S87A00	GHA428014	4F0598625A	GHA247001K	52068965AB	GHA331001	527102D115	GHA232002K	5Z0407615	GHA422026
44600SDAA10	GHA428022K	4G0501611	GHA232036K	52068965AD	GHA331001	527102D215	GHA232015K	68024245AA	GHA333107
44600SEL000	GHA426036	4G0598611	GHA232036K	52068965AE	GHA331001	527102D225	GHA232025	68030387AA	GHA333038
44600SJKJ00	GHA430007	4H0498625	GHA262001K	52068965AF	GHA331001	527102D315	GHA232002K	6C111104AD	GHA428008
44600SLNA00	GHA426048K	4H0498625A	GHA262001K	52069361AB	GHA331006K	527102E000	GHA233008	6C111A049BA	GHA237010K
44600SM4020	GHA428001	4L241K018AA	GHA327024K	52069361AC	GHA331006K	527102E100	GHA233005K	6C111A049DA	GHA245015K
44600SNA000	GHA426028K	4L2Z1104AA	GHA327024K	52069876AA	GHA333094K	527102E500	GHA427004	6C111K018AA	GHA245008K
44610SE0000	GHA426008	4L3Z1104AB	GHA4000294	52069877AA	GHA333093K	527103A000	GHA235015K	6C111K018BA	GHA249001K
4509325B	GHA228059	4R3Z1104AA	GHA237020	52069880AA	GHA333060	527103A001	GHA235015K	6C112B664BB	GHA237010K
4509766AA	GHA228048	4R3Z1104AB	GHA237022	52069881AA	GHA333062	527103A100	GHA235012K	6C112C229AA	GHA237015K
4543300020S1	GHA325026K	5003549AA	GHA228073	52069882AA	GHA333094K	527103A101	GHA235012K	6C342B513BA	GHA332003
4543300059S1	GHA325026K	5003550AA	GHA228047	52070321AA	GHA333071	527103X000	GHA400257	6C342B513EA	GHA332013K
4543300120S1	GHA325026K	5003550AB	GHA228047	52070321AB	GHA333071	527103X100	GHA400355	6C3Z1104BA	GHA332003
4543300159S1	GHA325026K	5010018AA	GHA333042	52070321AC	GHA333071	527104D000	GHA245013	6C3Z1104CA	GHA332015K
4578144AA	GHA326008	5010020AA	GHA333039	52070323AA	GHA333038	52710M3000	GHA233011	6C3Z1104EA	GHA332013K
4578144AB	GHA326008	5015282AA	GHA333086	52070323AB	GHA333038	52710M3050	GHA233012	6E0407621C	GHA320003K
4593003AB	GHA333031	5015456AA	GHA333084	52070323AE	GHA333110	527301D400	GHA400340	6E0407621D	GHA320003K
4593450AA	GHA333031	5016458AA	GHA327013	52070323AG	GHA333110	527301M000	GHA400208	6E0598611	GHA225029K
4593462AA	GHA326008	5085406AB	GHA332001K	52070323AH	GHA333110	527302G200	GHA400108	6E0598611A	GHA225029K
4616263AA	GHA228005	5085406AC	GHA332001K	52070323AI	GHA333107	527302G400	GHA400108	6E511N069BB	GHA236002K
4616477AB	GHA228011	5103507AA	GHA333082	52070323AJ	GHA333107	527302H000	GHA400131	6E5Z1104AA	GHA236003
4641517AD	GHA326014K	5105233AB	GHA332010K	52089434AA	GHA329004K	527302H100	GHA400262	6E5Z1104AB	GHA428005K
4641525AC	GHA326016	5105233AC	GHA332010K	52089434AB	GHA329004K	527303C000	GHA400037	6E5Z1104BA	GHA236003
4641957AA	GHA326014K	5105719AB	GHA400072K	52089434AC	GHA329004K	527303C100	GHA400004	6F2Z1109A	GHA400215
4683869AA	GHA400112	5154214AA	GHA332002	52089434AD	GHA329004K	527303F000	GHA400230	6F2Z1109B	GHA400214
4683869AB	GHA400112	5171124AB	GHA332018	52089434AE	GHA329004K	527303K000	GHA400157	6G912C299AAB	GHA400197K
4721010AA	GHA332009K	5171124AE	GHA332018	52098679AB	GHA327015K	527303K100	GHA400265	6G912C299AAC	GHA400197K
4721010AB	GHA332009K	517500X000	GHA424019	52098679AC	GHA327015K	527303K200	GHA400108	6G912C299AAD	GHA400197K
4721010AC	GHA332009K	517501J000	GHA425036	52098679AD	GHA327015K	527303S000	GHA400258	6G912C300AAB	GHA330055K
4721241AB	GHA326034	517501P000	GHA427018	52104499AB	GHA333088	527303S100	GHA400258	6K9501477	GHA230057K
4721353AA	GHA332012	517501S000	GHA425036	52104499AC	GHA333088	527303S200	GHA400258	6L141A049AA	GHA333091
4721354AA	GHA326044	517501Y000	GHA424018	52104499AG	GHA333092	527500U000	GHA400232	6L142B664AA	GHA333091
4721354AB	GHA326044	517502B000	GHA330009	52104499AH	GHA333092	527501C000	GHA400100	6L1Z1104DA	GHA400222
4721515AB	GHA400071	517502B010	GHA330009	52104698AA	GHA333089	527501C100	GHA400130K	6L2Z1109AA	GHA333091
4721515AC	GHA400071	517502D000	GHA427007	52104698AC	GHA333089	527501C200	GHA400130K	6L1Z1109AAF	GHA333091
4721515AD	GHA400071	517502D003	GHA425027	52104698AD	GHA333089	527501G000	GHA400100	6L1Z1215AA	GHA400202
4721578AB	GHA332002	517502D003	GHA425047	52104699AA	GHA333090	527501G101	GHA400158K	6L1Z1215BA	GHA400222
4721578AD	GHA332002	517502D103	GHA427002	52104699AB	GHA333090	527501G101	GHA400130K	6L1Z1A049AA	GHA333091
4721578AE	GHA332002	517502E000	GHA427005	52104699AD	GHA333090	527501G101	GHA400130K	6L241104AH	GHA327037
4721762AA	GHA400175	517502E100	GHA427005	52104699AF	GHA333090	527501G500	GHA400100	6L2Z1104A	GHA327037
4721762AA	GHA400175	517502F010	GHA425047	52104699AG	GHA333090	527501R000	GHA400274	6L2Z1109B	GHA429001K
4721762AB	GHA400175	517502F110	GHA425047	52104699AI	GHA333090	527501Y000	GHA400274	6L342C530AA	GHA400173
4721762AC	GHA400175	517502H000	GHA427010	52109947AC	GHA332006	527501Y100	GHA400232	6L342C530DA	GHA400173
4721762AE	GHA400175	517503A000	GHA427005	52109947AD	GHA332006	527502B100	GHA400190	6L3Z1104AA	GHA400173
4721762AF	GHA400175	517503A000	GHA427005	52109947AE	GHA332006	527502K000	GHA400260	6L3Z1104BA	GHA400218
4721762AF	GHA400175	517503A003	GHA427005	52109947AF	GHA332006	527502K100	GHA400261	6L3Z1104DA	GHA400173
4721762AI	GHA400175	517503D000	GHA427022	52111884AA	GHA329007	527503A001	GHA235015K	6L3Z1104EA	GHA400218
4721762AJ	GHA400175	517503D003	GHA427022	52111884AB	GHA329007	527504L000	GHA400232	6L541104AA	GHA327033
4721762AJ	GHA400175	517503J000	GHA330009	52122190AB	GHA335001	53007449AB	GHA327010K	6L541104BA	GHA327033
4766719AA	GHA400072K	517503K000	GHA430002	52128352AB	GHA327051	53007449AC	GHA327013	6L5Z1104A	GHA327033
4766771AA	GHA400192								

COMPETITOR	G-AP Ref.	COMPETITOR	G-AP Ref.	COMPETITOR	G-AP Ref.	COMPETITOR	G-AP Ref.	COMPETITOR	G-AP Ref.
OE		8K0598611	GHA232026K	D2012615X	GHA228072	F7XZ1109BA	GHA232009	J0033315XA	GHA236002K
6Q0407621AD	GHA336001K	8K0598625	GHA262001K	D6512615XB	GHA400110	F7XZ1109BB	GHA232009	K04779572AA	GHA332020
6Q0407621AJ	GHA336001K	8L8Z1104A	GHA428010K	D6512615XC	GHA400110	F81A2B663CH	GHA355004K	K04779572AB	GHA332020
6Q0407621BE	GHA336001K	8V0498625	GHA336004K	D6512615XD	GHA400110	F81A2B663EF	GHA355002K	K05154199AB	GHA332002
6Q0407621BF	GHA336001K	8V0498625B	GHA336004K	D6512615XE	GHA400110	F81Z1104BG	GHA355001K	K68184748AA	GHA332009K
6Q0407621BG	GHA336001K	8V0598611	GHA230082K	D96298788	GHA400189	F81Z1104BH	GHA355001K	KD312615XA	GHA400281
6Q0407621BH	GHA336013K	8V0598611A	GHA230082K	D96639606	GHA400091K	F81Z1104CH	GHA355004K	KD352615XB	GHA328011K
6Q0407621BR	GHA336001K	8V411A049AA	GHA336017K	DACF1041JR	GHA230037K	F81Z1104DG	GHA400162K	KD353304XC	GHA331008
6Q0407621B	GHA336001K	8V512C299A	GHA400136K	DACF1085R	GHA230040K	F81Z1104ED	GHA355002K	KK15133061	GHA331008
6Q0407621CA	GHA336013K	8V512C299A	GHA400136K	E99Z1104A	GHA326013	F81Z1104EE	GHA355002K	KK15133061	GHA424004
6Q0407621CB	GHA336013K	8V512C299AB	GHA400136K	EG212615X	GHA400140	F87A1104AB	GHA342002	L2062615XA	GHA400359
6Q0598611	GHA228036K	8V512C299AC	GHA400136K	F0DC1104A	GHA231003	F87A1104AC	GHA342002	L2062615XB	GHA400359
6Q0598611A	GHA228037	8V512C299AE	GHA400136K	F0DC2C299AB	GHA231002	F87A1104BB	GHA342001	L20633060	GHA431002
6R0407621A	GHA336001K	8V512C299AF	GHA400136K	F0DZ1104B	GHA231003	F87A1104BC	GHA342001	L2142615XA	GHA328014
6R0407621E	GHA336001K	8V512C299BD	GHA400136K	F1513304X	GHA400155	F87A1104CA	GHA327011	L2142615XB	GHA328014
6R0407621G	GHA336013K	90369T0003	GHA254002K	F1893304X	GHA400156	F87A1104CB	GHA327011	LA0133042B	GHA236002K
6X0501477	GHA228041K	91AB1104AD	GHA425004K	F1CZ1104A	GHA230032K	F87Z1104AB	GHA342002	LA013304X	GHA236002K
6X0501611A	GHA228041K	91AB1104AE	GHA425004K	F1SC2B633AA	GHA234501	F87Z1104BB	GHA342001	LA013304XA	GHA236002K
6X0598477	GHA228041K	91AB1104BE	GHA423002	F1SC2C300AA	GHA234501	F87Z1104CAB	GHA327011	LA013304XB	GHA236002K
7701204901D	GHA225039K	93B82C299BB	GHA235005K	F1SZ1104A	GHA234501	F88A2B664AA	GHA231006	LB8333060	GHA236002K
7701207823SK	GHA225019K	93B82C299BB	GHA235005K	F1SZ1104B	GHA234501	F8AC2B663AB	GHA237006	LR001127	GHA428026
7701207898SK	GHA225041K	93B82C299AA	GHA235009K	F29Z1104A	GHA326013	F8AC2C300AC	GHA237006	LR003157	GHA340005K
7B0407621	GHA332002	98AB1A034AE	GHA229001	F2AC2B633AA	GHA237005	F8AZ1104AA	GHA237006	LR014147	GHA329002K
7B0407621A	GHA332002	9S511104AA	GHA422015	F2AC2C300AA	GHA237005	F8DC2B664AA	GHA231002	LR014147	GHA329018K
7C3Z1104B	GHA332003	A11-3301030BB	GHA230007	F2AZ1104A	GHA237005	F8DC2C299AA	GHA231003	MB3663630	GHA228055
7C3Z1104C	GHA332015K	A1663340206	GHA330047	F2AZ1104B	GHA237005	F8DZ1104AA	GHA231003	MB455003	GHA240001K
7C3Z1104D	GHA400333K	A1699810027	GHA400240K	F2DZ1104A	GHA426003K	F8DZ1104AB	GHA231002	MB515400	GHA233001
7C3Z1104E	GHA332013K	A2033570008	GHA425048	F32Z1104B	GHA233009K	F8RZ1104AA	GHA326009	MB584325	GHA233010K
7F9Z1104B	GHA338003	A2119810227	GHA249002K	F32Z1104C	GHA233002F	F8ZC2B663AA	GHA234502	MB584326	GHA233010K
7H0401611D	GHA338001K	A2309810127	GHA249005K	F3DC1104AB	GHA231003	F8Z1104AA	GHA234502	MB584674	GHA228070
7H0401611E	GHA338001K	A4154200102	GHA230144K	F3DC2B664AB	GHA231002	FTC3223	GHA324007	MB584790	GHA230040K
7H0401611H	GHA338001K	A4513500135	GHA333076K	F3DZ1104A	GHA231002	FTC3226	GHA324005	MB584791	GHA233011
7H0498611	GHA338001K	A4513500235	GHA333076K	F3DZ1104B	GHA231002	FTC3243	GHA324006	MB633276	GHA327032
7L0498611	GHA338001K	A9063500249	GHA329013	F3SC2B663AA	GHA234501	G14V2615X	GHA236002K	MB633512	GHA236001
7L1Z1104AA	GHA400304	A9063503910	GHA329008K	F3SC2C300AA	GHA234501	G14V2615XA	GHA236002K	MB663557	GHA230081K
7L1Z1104BA	GHA400330	A9063504010	GHA329008K	F3SZ1104A	GHA234501	G14V2615XB	GHA236002K	MB663630	GHA228055
7L1Z1109AA	GHA333106K	AC3Z1104C	GHA400333K	F4CZ1104C	GHA230032K	G33S2615X	GHA328012	MB663664	GHA233003
7L241104AA	GHA327037	AC3Z1104D	GHA332013K	F4CZ2B663AB	GHA234502	G33S2615XB	GHA328012	MB809577	GHA230100
7L241104AB	GHA327037	AC3Z1104F	GHA332003	F4CZ2B663AC	GHA234502	GA2A2615X	GHA233009K	MB809601	GHA230040K
7L2Z1104A	GHA327037	B00133061B	GHA424003	F4ZZ1104A	GHA234502	GA2G2615X	GHA233002F	MB844919	GHA228020K
7L342C530AA	GHA400173	B01C2615X	GHA230122K	F50Y1104A	GHA326009	GA5R2615X	GHA233009K	MB864847	GHA240001K
7L342C530AB	GHA400173	B01D2615X	GHA230125K	F57A1104CA	GHA327011	GA5S2615X	GHA233002F	MB892400	GHA240009
7L3Z1104A	GHA400173	B1022615XA	GHA228072	F57A1104CC	GHA327011	GA5S2615XA	GHA233002F	MB911498	GHA228020K
7L3Z1104B	GHA400218	B2012615X	GHA228072	F57Z1215AAB	GHA327011	GD7A2615X	GHA233009K	MB914617	GHA327032
7M512C2998C	GHA400105	B4552615X	GHA230032K	F5AC2B663AA	GHA237005	GD7G2615X	GHA233015	MB948961	GHA425032
7M512C299AC	GHA400084K	B4552615XA	GHA230032K	F5AC2C300AC	GHA237005	GE4T2615XA	GHA233009K	MB949047	GHA325501
7M512C299AD	GHA400084K	B4552615XA	GHA230036	F5AZ1104A	GHA237005	GE4V2615X	GHA233002F	MD00126115D	GHA499062
7P0498287	GHA251002K	B4552615XB	GHA230036	F5AZ1104B	GHA237005	GE4V2615XA	GHA233002F	MD00133042	GHA424004
7T4Z1104C	GHA328015	BBM22615XB	GHA400106	F5RZ1104B	GHA235005K	GF4K2615X	GHA236003	MDX5033061	GHA424012
805062C	GHA400248K	BG2B663A	GHA400159	F5SZ1104AA	GHA234501	GF4K2615XB	GHA236003	MN102067	GHA325026K
81AB1106BB	GHA423007	BN8B2615XB	GHA400107	F5T21104AB	GHA327011	GHB372	GHA230117K	MN102067S1	GHA325026K
823407615A	GHA422008A	BN8B2615XC	GHA400107	F65W1104AA	GHA333050	GHB380	GHA243001K	MN102068	GHA325026K
823407615A	GHA422011	BN8B2615XD	GHA400107	F65Z1104AA	GHA333050	GHK1249	GHA228030K	MN102068S1	GHA325026K
86AB1106AA	GHA423007	BN8B2615XE	GHA400107	F65Z1104AB	GHA333050	GHK1401	GHA230117K	MN113554	GHA425051
87U1104AA	GHA424008	BN8B2615XF	GHA400107	F65Z1104BA	GHA333012	GHK1482	GHA243001K	MR103649	GHA240001K
89411B2010	GHA400099	BN8B2615XG	GHA400107	F67A1125BA	GHA327011	GHK1483	GHA230003K	MR103663	GHA240001K
89411B2050	GHA400228	BN8B3315XB	GHA336008	F67Z1102HAB	GHA327011	GHK1484	GHA230029K	MR131774	GHA228020K
8A8Z1104B	GHA338004	BP4K2615XA	GHA400106	F67Z1125BA	GHA327011	GHK1551	GHA230017K	MR223284	GHA228066K
8C3Z1104F	GHA332022K	BP4K2615XB	GHA400106	F6SC2B663BA	GHA234501	GHK1560	GHA230117K	MR223285	GHA230053
8D0407615B	GHA433002	BP4K2615XC	GHA400106	F6SZ1104AA	GHA234501	GHK1561	GHA230151K	MR223962	GHA327032
8D0498625C	GHA245010K	BP4K2615XD	GHA400106	F6SZ1104AB	GHA234501	GHK1596	GHA230117K	MR223993	GHA327032
8D0501117C	GHA499047	BP4K2615XE	GHA400106	F6SZ1104BA	GHA234501	GHK1597	GHA230151K	MR297725	GHA228055
8E0498625A	GHA245010K	BP4K2615XF	GHA400106	F6ZC2B663AA	GHA234502	GHK1693	GHA232023	MR319603	GHA425051
8E0498625B	GHA245010K	BP4K3315XA	GHA336008	F6ZZ1104AA	GHA234502	GJ6A33060D	GHA428005K	MR369520	GHA240001K
8E0501611	GHA400003	BP4K3315XB	GHA336008	F75W1104AA	GHA333059	GJ6A33060E	GHA428005K	MR403558	GHA230108K
8E0501611J	GHA400003	BT4Z1104B	GHA338004	F75W1104BB	GHA333018	GWB2G2615X	GHA236003	MR403806	GHA228020K
8E0598611	GHA232014K	C2532615XA	GHA338012	F75W1104CA	GHA333044	GWB2G2615XA	GHA236003	MR403968	GHA240009
8E0598611A	GHA232014K	C2S17483	GHA400081K	F75W1104DA	GHA333050	GWB2H2615X	GHA236002K	MR418068	GHA333052K
8E0598611B	GHA232014K	C2S3301	GHA326038K	F75W1104EA	GHA333012	GWB2H2615XA	GHA236002K	MR455004	GHA325001
8E0598611C	GHA232014K	C2S3301	GHA326038K	F75Z1104AA	GHA333059	GR1A33060	GHA428005K	MR475333	GHA325005
8E0598625A	GHA245010K	C2S46772	GHA326038K	F75Z1104BA	GHA333018	GR1A33060A	GHA428005K	MR493619	GHA230043K
8E0598625B	GHA245010K	CB31000100E	GHA330010K	F75Z1104CA	GHA333044	GS1D2615X	GHA400140	MR510149	GHA425052
8F9Z1104A	GHA338005	CB31000200D	GHA330008K	F78Z1104AA	GHA231006	GS1D2615XA	GHA400140	MR519922	GHA425033
8F9Z1104B	GHA338003	CKP7058EVA	GHA230017K	F7AC2B300AA	GHA231006	GS1D2615XB	GHA400140	MR519923	GHA425049
8F9Z1104C	GHA338002	D02021W01A	GHA499083	F7AZ1104AC	GHA231006	I13583478	GHA333080K	MR527452	GHA230100
8G912C300	GHA340005K	D0202VL20A	GHA499082	F7C61N069AA	GHA230032K	J0013315XA	GHA236002K	MR527453	GHA230087K
8J0598625	GHA336007K	D1022615XA	GHA228072	F7CZ1104AB	GHA230032K	J00333060A	GHA236002K	MR589431	GHA327041

COMPETITOR	G-AP Ref.	COMPETITOR	G-AP Ref.	COMPETITOR	G-AP Ref.	COMPETITOR	G-AP Ref.	COMPETITOR	G-AP Ref.
OE		YF1Z1104AB	GHA231002	9804202	GWB1397	39819505	GWB6686	926230030	GWB3967
		YF1Z1104AC	GHA231008	9804202	GWB0802	54381200	GWB0504	926230030	GWB3968
MR589519	GHA400315	YF1Z1104BA	GHA231003	9804202	GWB0911	59812605	GWB1470	926230103	GWB3967
MR589520	GHA400211	YF2Z1104AA	GHA326006	9808202	GWB1397	59815305	GWB3475	926230103	GWB3968
MR589536	GHA325028	YL1Z1104AA	GHA333019	9808202	GWB3404	59817105	GWB3519	926235029	GWB1930
MR594142	GHA400135K	YL241104BA	GHA327011	9809302	GWB1498	59817105	GWB0528	926235029	GWB3797
MR594443	GHA400165	YL341104AA	GHA333045	9809302	GWB3565	59817105	GWB0529	926235032	GWB1930
MR594494	GHA400239	YL3Z1104AA	GHA333045	9813605	GWB3475	59817105	GWB0542	926235032	GWB3797
MR594979	GHA328006K	YL3Z1104BA	GHA333061	9815805	GWB0523	59817105	GWB0802	09262A20076	GWB1931
NA013304X	GHA228046K	YL521104AA	GHA327017	9815805	GWB0526	59817105	GWB0944	09262A20076	GWB3717
NA013304XA	GHA228046K	YL541104AA	GHA327017	9815805	GWB0756	69811605	GWB0504	09262A25074	GWB1931
NA233304XA	GHA228056K	YL541104BA	GHA327034	9815805	GWB0941	69811605	GWB0528	09262A25074	GWB3716
NA233304XC	GHA228056K	YL5Z1104AA	GHA327017	9815905	GWB1465	69811605	GWB0529	09262A25074	GWB3717
NE513304X	GHA400151	YL5Z1104BA	GHA327034	9815905	GWB3519	69811605	GWB0756	09262A35033	GWB1930
OK20226150	GHA230035K	YL8Z1104AB	GHA428010K	9815905	GWB0523	69811605	GWB0944	09262A35033	GWB3797
PMYW432B663AC	GHA400076	YR332B663AA	GHA234502	9815905	GWB0526	69814505	GWB3417	926529001	GWB3255
PW823106	GHA230084K	YR333C300AA	GHA234502	9815905	GWB0542	69815005	GWB0596	926529001	GWB0534
RFM001483EVA	GHA230003K	YR3Z1104AA	GHA234502	9815905	GWB0911	69815105	GWB0596	926529001	GWB0947
RFM001484EVA	GHA230029K	YR3Z1104BA	GHA234502	9815905	GWB0941	69815605	GWB1393	926734001	GWB3256
RFM500010	GHA329002K	YS4Z1104AA	GHA425007K	9816305	GWB0526	69815605	GWB3475	926734001	GWB3786
RFM500010	GHA329018K	YS4Z204CA	GHA342001	9819002	GWB1393	69815605	GWB6700	926735003	GWB3713
RLB000050	GHA230117K	ZBA407615	GHA422011	9819002	GWB3475	69815605	GWB6742	926739001	GWB3257
RLB000050	GHA230117K	ZZP033061	GHA342002	9819002	GWB6700	69815805	GWB1499	926739001	GWB3785
RLB000060	GHA230151K	ZZP133061	GHA342001	9819002	GWB6742	69815805	GWB3434	926739002	GWB3902
RLB100292	GHA232023	YF122B664AA	GHA231002	16172300	GWB0523	69815805	GWB6686	926739004	GWB3902
RUC000074	GHA431005	YF122C299BA	GHA231003	16172300	GWB0526	79810405	GWB1393	926739010	GWB3902
RUC500120	GHA431005	328105	GWB3543	16172300	GWB0756	79810405	GWB3475	926740001	GWB3718
S113301031AB	GHA225902	330012	GWB0926	16172300	GWB0941	79810405	GWB6700	926935009	GWB1971
SE021149002A	GHA230002F	332675	GWB3539	16172400	GWB1465	79810405	GWB6742	926935009	GWB3970
SE028140301A	GHA320001K	332677	GWB3539	16172400	GWB3519	79811405	GWB6700	926935010	GWB3220
SE127149004A	GHA320001K	335015	GWB1412	16172400	GWB0523	79812105	GWB6700	926941001	GWB3219
SU00300791	GHA327038K	335080	GWB3649	16172400	GWB0526	79817605	GWB3430	926941001	GWB3922
T71407613	GHA499086	335083	GWB3649	16172400	GWB0542	89815705	GWB1397	OK01A33047	GWB1909
TAY100060	GHA324009	1583567	GWB0926	16172400	GWB0911	89815705	GWB3404	OK01A33047	GWB1951
TAY100060	GHA245022K	1587565	GWB3539	16172400	GWB0941	89815805	GWB1397	OK01A33047	GWB1915
TAY100060E	GHA245022K	1591389	GWB1455	16172400	GWB0926	89815805	GWB0802	OK01A33047	GWB3727
TD1133060	GHA431003	3981591	GWB0926	19802902	GWB0596	89815805	GWB0911	OK01A33047	GWB3949
UR6133061	GHA428027	4009067	GWB0926	19803002	GWB1498	99814105	GWB3417	OK01A33075	GWB1383
XC352B663BA	GHA355004K	4096104	GWB0926	19806202	GWB3434	99814505	GWB3417	OK01A33075	GWB1928
XF122C300BB	GHA326009	4708249	GWB7525	19806202	GWB6686	99814805	GWB3417	OK01A33075	GWB0739
XF1Z1104AE	GHA326009	4711556	GWB7525	19806302	GWB3434	99816005	GWB3417	OK01A33075	GWB0949
XF1Z1104BA	GHA326009	5025675	GWB1455	19806302	GWB6686	99816105	GWB3417	OK01A33075	GWB3949
XF222C300AA	GHA326006	7413409	GWB0926	19810427	GWB0757	99817005	GWB3417	OK20133047	GWB1950
XF222C300AB	GHA326006	9815905	GWB0926	19811505	GWB3430	109817405	GWB1499	OK2JT33047	GWB1948
XF2Z1104AA	GHA326006	11055109	GWB0926	19816105	GWB3430	109817405	GWB3565	OK2JT33047	GWB7446
XF5Z1104AA	GHA232009	31733075	GWB1353	19816505	GWB3430	109817405	GWB6537	OK72A33047	GWB3936
XF5Z1109BA	GHA232009	31733075	GWB1352	19818905	GWB3475	109817405	GWB6693	OK72A33075	GWB3936
XFI22C300BB	GHA326009	60523333	GWB0926	29803002	GWB6530	119818905	GWB3435	OK9A233047	GWB1948
XL1Z1104AE	GHA333044	139133047	GWB1353	29803102	GWB6530	021140301A	GWB1410	OK9A233047	GWB7446
XL241104BA	GHA327011	139133047	GWB1352	29806402	GWB1499	021140301B	GWB1410	100167600	GWB5549
XL341104AG	GHA333061	3200200150	GWB5549	29806402	GWB5549	022621N	GWB0504	100167601	GWB5549
XL341104BB	GHA333012	3200200151	GWB5549	29806402	GWB6537	2667886	GWB3217	1001718	GWB3449
XL341104BD	GHA333012	3434365000	GWB5549	29806402	GWB6693	2667886	GWB3255	1001719	GWB3450
XL341104CB	GHA333059	4200200100	GWB5549	29806502	GWB1498	2667886	GWB0534	1002689	GWB5549
XL341104DC	GHA333018	4200200101	GWB5549	29806502	GWB3565	4421350201	GWB1369	1003457	GWB5549
XL3Z1104AA	GHA333045	5272024000	GWB1961	29806502	GWB6537	4421350201	GWB7474	1019561	GWB1333
XL3Z1104AD	GHA333050	5272024100	GWB1961	29811205	GWB3417	4421350201	GWB0826	1046767	GWB3485
XL3Z1104BA	GHA333061	5272024210	GWB1961	29811305	GWB1393	4421350202	GWB1369	1053115	GWB1465
XL3Z1104BC	GHA333012	5272024310	GWB1961	29811305	GWB3475	4421350202	GWB7474	105E4220A1	GWB1369
XL3Z1104CB	GHA333059	5273036200	GWB1353	29811305	GWB6700	4421350202	GWB0826	105E4220A1	GWB7474
XL3Z1104DA	GHA333018	5273036200	GWB1352	29811305	GWB6742	61030204	GWB3796	105E4220A1	GWB0826
XL541104AA	GHA342002	9000709340	GWB0926	29811905	GWB3475	6324990079	GWB0828	1085565	GWB3532
XL541104BA	GHA342001	9036819037	GWB1353	29812205	GWB3475	6342990066	GWB3430	1101597	GWB1393
XR825194	GHA400181	9036819037	GWB1352	29816605	GWB1393	811362040	GWB3716	1101597	GWB3475
XR855936	GHA400076	9036831003	GWB1353	29816605	GWB3475	812362047	GWB1931	1101597	GWB6700
XS611104AA	GHA425004K	9036831003	GWB1352	29816605	GWB6700	812362047	GWB3717	1101597	GWB6742
XW432B663AB	GHA400076	21013103020	GWB0926	29816605	GWB6742	812362057	GWB1931	1104362	GWB3450
XW432B663AC	GHA400076	21013103025	GWB0926	31733075	GWB0904	812362057	GWB3716	11054479	GWB0504
XW432B663AE	GHA400076	21083103020	GWB0663	31733075	GWB0947	812362057	GWB3717	11054489	GWB3217
XW4Z1104AA	GHA400076	21213103020	GWB1324	39811005	GWB1499	812362067	GWB3967	11054489	GWB3255
YC152B663AE	GHA245009K	31212634103	GWB0926	39811005	GWB3434	812362067	GWB3968	11054489	GWB0504
YC352B513BA	GHA335001K	99905906500	GWB0926	39811005	GWB6686	91517185	GWB1444	11054489	GWB0528
YC352B513EA	GHA355002K	720032206	GWB3430	39811505	GWB1499	091517185B	GWB1444	11054489	GWB0529
YC352B663BA	GHA355001K	720032210	GWB3475	39811505	GWB3434	926220069	GWB3716	11054489	GWB0534
YC352B663BB	GHA355001K	720432210	GWB3475	39811505	GWB6686	926225061	GWB1931	11054489	GWB0756
YC352B663EA	GHA355002K	9800316	GWB0757	39819505	GWB1499	926225061	GWB3716	11054489	GWB0944
YC352B663EB	GHA355002K	9800516	GWB3628	39819505	GWB3434	926225061	GWB3717	11055109	GWB1465

COMPETITOR	G-AP Ref.	COMPETITOR	G-AP Ref.	COMPETITOR	G-AP Ref.	COMPETITOR	G-AP Ref.	COMPETITOR	G-AP Ref.
OE		1201568	GWB3532	1583567	GWB0542	184447	GWB0756	2203300051	GWB3522
		1201568	GWB6515	1583567	GWB0904	184447	GWB0944	2203300051	GWB3628
11055109	GWB3519	1201569	GWB3531	1583567	GWB0911	1851800M91	GWB0596	2203300051	GWB6646
11055109	GWB0523	1225764	GWB3625	1583567	GWB0941	191498625	GWB0906	2209800016	GWB3628
11055109	GWB0526	1243300251	GWB1498	1583567	GWB0947	191498625A	GWB1358	2209800116	GWB3628
11055109	GWB0542	1243300351	GWB1498	1583567	GWB1353	191598625	GWB0529	2209810027	GWB3400
11055109	GWB0904	1243300551	GWB1498	1583567	GWB1352	1D0498625B	GWB1356	2209810027	GWB3522
11055109	GWB0911	1243500549	GWB1347	1587548	GWB3577	1E003261YA	GWB1333	2209810027	GWB3628
11055109	GWB0941	1243500649	GWB1347	1591389	GWB1433	1E003261YA	GWB3666	2209810027	GWB6646
11055109	GWB0947	1243500749	GWB0757	1591389	GWB1473	1H0498625	GWB1491	2213300225	GWB6693
11055109	GWB1353	1249800202	GWB1347	1591389	GWB0687	1J0407625	GWB3455	22621N	GWB0504
11055109	GWB1352	1249800316	GWB1347	1591389	GWB0740	1J0407625	GWB3607	2303300325	GWB6537
11055119	GWB0523	1249800416	GWB1347	1591389	GWB0741	1J0498625	GWB3455	235817	GWB0652
11055119	GWB0526	1249800516	GWB1347	1591389	GWB0897	1J0598625	GWB3455	2469810006	GWB7016
11055119	GWB0756	1293300051	GWB1498	1591389	GWB0898	1K040AA	GWB3449	251405645B	GWB1498
11055119	GWB0941	1293300151	GWB1498	1603022	GWB6720	1K040AA	GWB3450	251405645B	GWB3565
11070311	GWB3255	1293300251	GWB1498	1603065	GWB0944	1S7W1215AA	GWB3575	26800160	GWB3475
11070311	GWB3519	1293500049	GWB0757	1603109	GWB0526	2013300151	GWB0756	26800340	GWB3405
11070311	GWB0528	1299800016	GWB0757	1603191	GWB0736	2013300251	GWB0941	273135603102	GWB1432
11070311	GWB0529	1299800116	GWB0757	1603192	GWB3256	2013500149	GWB0757	273135603102	GWB3678
11070311	GWB0534	1299800216	GWB0757	1603193	GWB0944	2013500249	GWB0757	273135603102	GWB0736
11070311	GWB0542	1299800316	GWB0757	1603195	GWB3403	2013500549	GWB0757	273135603102	GWB0754
11070311	GWB0802	1299800416	GWB0757	1603196	GWB3410	2019800016	GWB0757	28016AA011	GWB1365
11070311	GWB0944	1300535080	GWB3428	1603337	GWB6550	2019800116	GWB0757	28016AA011	GWB3235
11070311	GWB0947	1311506080	GWB3423	1603338	GWB6540	2023300051	GWB1498	28016AA011NT	GWB1365
1110003	GWB3475	1326188080	GWB3633	1604007	GWB3601	2029800016	GWB0757	28016AA011NT	GWB3235
1112547	GWB3531	1328029080	GWB3642	1604286	GWB0526	2029800116	GWB0757	28016AA020	GWB3236
1133023	GWB3575	1328046080	GWB3640	1604287	GWB0754	2029810127	GWB0757	28016AA020NT	GWB3236
1135043	GWB3532	1328054080	GWB3641	1604292	GWB1326	2033300051	GWB6530	28016AA030	GWB3236
113517185	GWB1397	1330512080	GWB3423	1606374680	GWB6570	20339N	GWB0504	28016FC000	GWB3236
113517185	GWB0802	1333562	GWB3678	1606374980	GWB3690	20339N	GWB0528	28016FC001	GWB3236
113517185	GWB0911	1335383	GWB3532	1606375080	GWB3640	20339N	GWB0529	281498625	GWB0802
113517185C	GWB1397	1335383	GWB6515	1606375180	GWB3641	20339N	GWB0756	281501319	GWB1470
113517185C	GWB0802	1346650080	GWB3690	1606623580	GWB3584	20339N	GWB0944	28316AE000	GWB1365
113517185C	GWB0911	1346651080	GWB3689	1607286	GWB0526	2039800016	GWB0757	28316AE000	GWB3235
113517185D	GWB1397	13500488	GWB6720	1607704180	GWB3683	2099800016	GWB0757	28316FE000	GWB1365
113517185D	GWB0802	13592067	GWB6720	1611500880	GWB7408	21013103025	GWB1465	28316FE000	GWB3235
113517185D	GWB0911	1400078	GWB3430	1633300051	GWB3522	21013103025	GWB3519	291407645	GWB1445
1137830	GWB1333	1403300051	GWB1499	1649810106	GWB6559	21013103025	GWB0523	291407645	GWB3429
1141771	GWB1432	1403300251	GWB1499	1649810406	GWB6559	21013103025	GWB0526	291501319B	GWB3475
115204	GWB1320	1403500049	GWB3400	1668557	GWB6636	21013103025	GWB0542	293501319	GWB1393
115204	GWB0001	1403500149	GWB3400	1689810327	GWB3521	21013103025	GWB0911	293501319	GWB3475
115204	GWB3499	1409800416	GWB3400	1689810327	GWB0976	21013103025	GWB0941	293501319	GWB6700
116002140800	GWB0504	1409800516	GWB3400	1689810627	GWB3520	2103300051	GWB1498	293501319	GWB6742
116002140800	GWB0528	1409800616	GWB3628	1689810727	GWB6508	2103300151	GWB3518	2D0407625	GWB1499
116002140800	GWB0529	1409800716	GWB3628	1699368	GWB6508	21083103020	GWB1306	2D0407625	GWB3434
116002140800	GWB0756	1409810005	GWB1499	1699810006	GWB6509	21083103020	GWB0593	2D0407625	GWB6686
116002140800	GWB0944	1409810005	GWB3434	1699810127	GWB6509	21083104020	GWB1307	2D0407625A	GWB3434
116002141303	GWB3519	1409810005	GWB6686	171407625A	GWB1306	2108310402000	GWB1307	2D0407625A	GWB6686
116002141303	GWB0528	1409810305	GWB1499	171407625A	GWB0593	2109800116	GWB3628	2D0498625	GWB3434
116002141303	GWB0529	1409810305	GWB3565	171407625A	GWB6653	2109800516	GWB3628	2D0501319	GWB3435
116002141303	GWB0542	1409810305	GWB6537	171407625C	GWB1306	2109800816	GWB6647	2D0501319A	GWB3475
116002141303	GWB0802	1409810305	GWB6693	171407625C	GWB0593	2109810127	GWB3486	2D0501319B	GWB1393
116002141303	GWB0944	1484269	GWB6520	171407625C	GWB0663	2109810127	GWB3518	2D0501319B	GWB3475
116002141306	GWB3519	1492160	GWB3217	171498625	GWB0593	2109810227	GWB6647	2D0501319B	GWB6700
116002141306	GWB0528	1492160	GWB3255	171498625A	GWB0593	211405645C	GWB0523	2D0501319B	GWB6742
116002141306	GWB0529	1492160	GWB0504	171498625B	GWB0593	211405645C	GWB0526	2S611215BC	GWB3531
116002141306	GWB0542	1492160	GWB0528	171498625C	GWB0593	211405645C	GWB0756	2S611215BC	GWB6653
116002141306	GWB0802	1492160	GWB0529	171498625D	GWB0593	211405645C	GWB0904	2S611238AF	GWB3532
116002141306	GWB0944	1492160	GWB0534	1746588	GWB6653	211405645C	GWB0941	2S611238AF	GWB6515
116002540108	GWB1320	1492160	GWB0756	181585+181584	GWB1465	211405645C	GWB0947	2S611238AG	GWB3532
116002540108	GWB0001	1492160	GWB0904	181585+181584	GWB3519	211405645C	GWB1353	2S611238AG	GWB6515
116002540108	GWB3499	1492160	GWB0944	181585+181584	GWB0523	211405645C	GWB1352	2S6W1215AA	GWB3530
1163300051	GWB0596	1501642	GWB6636	181585+181584	GWB0526	211405645D	GWB1465	2T141215BA	GWB6520
1165860033	GWB0596	1565443	GWB0504	181585+181584	GWB0542	211405645D	GWB3519	3024E1200A	GWB0504
119002140801	GWB1465	1565443	GWB0904	181585+181584	GWB0911	211405645D	GWB0523	3026E1200A	GWB0504
119002140801	GWB3519	1565444	GWB3519	181585+181584	GWB0941	211405645D	GWB0526	3026E1200A	GWB0904
119002140801	GWB0523	1565444	GWB0528	181585+181584	GWB0926	211405645D	GWB0542	303715	GWB0540
119002140801	GWB0526	1565444	GWB0529	183578	GWB1498	211405645D	GWB0911	303715	GWB0652
119002140801	GWB0542	1565444	GWB0542	183583	GWB3430	211405645D	GWB0941	30818024	GWB1480
119002140801	GWB0911	1565444	GWB0802	1836381	GWB6636	211405645D	GWB0926	30870319	GWB3443
119002140801	GWB0941	1565444	GWB0944	183684	GWB0828	211501283D	GWB0910	30884539	GWB3647
119002140801	GWB0926	1582282	GWB6653	183765	GWB3475	211501287	GWB0910	311405625	GWB0504
119002141301	GWB0523	1583567	GWB1465	183834	GWB0504	212131003020	GWB1324	311405625	GWB0904
119002141301	GWB0526	1583567	GWB3519	184447	GWB0504	2123300025	GWB6537	311405625E	GWB3255
119002141301	GWB0756	1583567	GWB0523	184447	GWB0528	2183300125	GWB6537	311405625E	GWB3519
119002141301	GWB0941	1583567	GWB0526	184447	GWB0529	2203300051	GWB3400	311405625E	GWB0528

COMPETITOR	G-AP Ref.	COMPETITOR	G-AP Ref.	COMPETITOR	G-AP Ref.	COMPETITOR	G-AP Ref.	COMPETITOR	G-AP Ref.
OE		330011	GWB0528	357498625B	GWB1358	4021050Y05	GWB3201	43210AX000	GWB0961
		330011	GWB0529	357498625C	GWB1358	4021050Y05	GWB3308	43210AZ300	GWB3525
311405625E	GWB0529	330011	GWB0756	3666951	GWB1369	402105733R	GWB3637	43210AZ300	GWB3556
311405625E	GWB0534	330011	GWB0944	3666951	GWB7474	402106566R	GWB3618	43210AZ300	GWB3658
311405625E	GWB0542	330012	GWB1465	3666951	GWB0826	4021085000	GWB3206	43210AZ300	GWB0961
311405625E	GWB0802	330012	GWB3519	373015	GWB0540	4021085000	GWB3950	43210C9300	GWB3331
311405625E	GWB0944	330012	GWB0523	373015	GWB0652	4021085000	GWB0841	43210LC42A	GWB3552
311405625E	GWB0947	330012	GWB0526	373017	GWB0540	4021086000	GWB3206	43211M7000	GWB3255
311405645	GWB3217	330012	GWB0542	373020	GWB1445	4021086000	GWB3950	43211M7000	GWB0534
311405645	GWB3255	330012	GWB0911	373020	GWB3429	4021086000	GWB0841	43211M7000	GWB0947
311405645	GWB0504	330012	GWB0941	373021	GWB3525	4021090J00	GWB1999	4330647	GWB1444
311405645	GWB0528	330756	GWB0915	373021	GWB3556	4021095F0A	GWB3272	4330648	GWB1445
311405645	GWB0529	331598625	GWB0575	373021	GWB3658	4021095F0A	GWB3940	4330648	GWB3429
311405645	GWB0534	331598625A	GWB1358	373021	GWB0961	402109697R	GWB3648	4344051K00	GWB7526
311405645	GWB0756	331598625B	GWB1358	373022	GWB3430	4021099B00	GWB3703	4344054G01	GWB6819
311405645	GWB0944	332627	GWB1444	373032	GWB3642	40210AX000	GWB3637	4344054G02	GWB6819
311498071BS	GWB0529	332631	GWB0882	373032	GWB1445	40210AX000	GWB3991	4344058J00	GWB3965
31203450600	GWB3574	332635	GWB0915	373515	GWB3429	40210C6000	GWB3319	4344068L10	GWB7526
31211106032	GWB1498	332639	GWB1327	373518	GWB3430	40210F1700	GWB1369	4344071L00	GWB7526
31211106032	GWB3565	332640	GWB3423	374809	GWB0540	40210F1700	GWB7474	4344078A00	GWB3965
31211110115	GWB3519	332641	GWB3428	374817	GWB0961	40210F1700	GWB0826	4344079J00	GWB6578
31211110115	GWB0528	332662	GWB3640	374839	GWB3556	4021145460	GWB3319	4344080J00	GWB6578
31211110115	GWB0529	332663	GWB3641	374877	GWB3658	402150F000	GWB3205	4344083E10	GWB3965
31211110115	GWB0542	332666	GWB3679	374883	GWB3680	402152S600	GWB3205	4344084F00	GWB3965
31211110115	GWB0802	332669	GWB3690	374890	GWB6544	4021550W00	GWB3205	4344086G00	GWB6819
31211110115	GWB0944	332671	GWB6570	374894	GWB6549	40215A0100	GWB0904	43440M68K00	GWB3965
31212634103	GWB1465	332672	GWB3538	3748A1	GWB6726	40215A0100	GWB0947	43440M79F00	GWB3965
31212634103	GWB3519	332674	GWB7408	3885A001	GWB3272	40215A0100	GWB1353	43440T51K00	GWB7526
31212634103	GWB0523	332675	GWB3581	3885A001	GWB3940	40215A0100	GWB1352	43440T68L10	GWB7526
31212634103	GWB0526	332676	GWB3538	3885A017	GWB7408	40215C6000	GWB3331	4346285C00	GWB3219
31212634103	GWB0542	332677	GWB3581	3885A040	GWB7408	40215C6000	GWB3319	4346285C00	GWB3922
31212634103	GWB0911	33411090505	GWB3668	3981588	GWB1410	40215F1700	GWB1369	43560B2020	GWB6966
31212634103	GWB0941	33411123415	GWB1326	3981589	GWB1410	40215F1700	GWB7474	43560B2030	GWB6966
31212634104	GWB0504	33411124358	GWB1317	402100005R	GWB3608	40215F1700	GWB0826	4359165D00	GWB7455
31212634104	GWB0528	33411124358	GWB1459	4021000Q0E	GWB3648	4096101	GWB0523	4403023	GWB3613
31212634104	GWB0529	33411124358	GWB3446	4021000Q0F	GWB3618	4096101	GWB0526	4403044	GWB3614
31212634104	GWB0756	33411130617	GWB1320	4021000Q0H	GWB6721	4096101	GWB0756	4408277	GWB3617
31212634104	GWB0944	33411130617	GWB0001	4021000QAA	GWB3596	4096101	GWB0941	4408668	GWB3618
31212634105	GWB0504	33411130617	GWB3499	4021000QAC	GWB3613	4096104	GWB1465	4408669	GWB3616
31212634106	GWB0523	33416762317	GWB3682	4021000QAE	GWB3618	4096104	GWB3519	4412598	GWB3648
31212634106	GWB0526	33416762321	GWB6632	4021000QAF	GWB3616	4096104	GWB0523	4419183	GWB6721
31212634106	GWB0756	33416775842	GWB6632	4021000QAG	GWB3648	4096104	GWB0526	4419184	GWB6722
31212634106	GWB0941	33416792361	GWB7016	4021000QAK	GWB3648	4096104	GWB0542	4421370	GWB6742
31221095702	GWB3668	335016	GWB0915	4021001	GWB1365	4096104	GWB0911	4421378	GWB1393
31226751978	GWB3574	335017	GWB0882	4021001	GWB3235	4096104	GWB0941	4421378	GWB3475
31226783913	GWB3574	335018	GWB1327	4021005U00	GWB3221	4096587	GWB0596	4421378	GWB6700
3199810005	GWB0828	335021	GWB1444	402100F000	GWB3205	4096591	GWB0596	4421378	GWB6742
3199810405	GWB3475	335024	GWB3428	4021018000	GWB3796	4149810127	GWB3520	4424161J00	GWB3740
321498625B	GWB0575	335025	GWB3429	402101HA1A	GWB3637	415203	GWB1326	4424161J00	GWB0827
321498625C	GWB0575	335026	GWB3430	402101HA1A	GWB3991	42470845	GWB3551	44300S04008	GWB3245
321498625D	GWB0575	335027	GWB3423	402102084R	GWB3608	42471033	GWB3664	44300S04A01	GWB3246
321498625E	GWB0575	335029	GWB1444	4021021000	GWB0904	430009707R	GWB6799	44300S04A02	GWB3246
328011	GWB3598	335030	GWB3428	4021021B00	GWB1342	431498625	GWB0613A	44300S0A003	GWB3951
328012	GWB3599	335031	GWB3490	4021021B00	GWB3224	431498625A	GWB0962	44300S0A003	GWB7587
328017	GWB0504	335032	GWB3554A	4021021B00	GWB3916	4321000QA	GWB6722	44300S1AE01	GWB3951
328018	GWB0523	335069	GWB3584	4021021B00	GWB3917	4321000QAB	GWB3614	44300S1AE01	GWB7587
328018	GWB0526	335070	GWB3633	402102771R	GWB3608	4321000QAC	GWB3617	44300S2G004	GWB3245
328018	GWB0756	335072	GWB3657	402102S600	GWB3205	4321000QAD	GWB0976	44300S47008	GWB3951
328018	GWB0941	335081	GWB3633	402102Y000	GWB3981	4321001J10	GWB3332	44300S47008	GWB7587
328022	GWB3519	335082	GWB3683	4021030R01	GWB1999	432100286R	GWB6658	44300S5A004	GWB3246
328022	GWB0528	335084	GWB3584	4021030R06	GWB1999	432102069R	GWB6799	44300S5A008	GWB3246
328022	GWB0529	335085	GWB3683	4021032R01	GWB1999	432102103R	GWB7032	44300S6DE01	GWB3246
328022	GWB0542	335086	GWB3657	4021032R06	GWB1999	432103106R	GWB6799	44300S84A02	GWB3951
328022	GWB0802	335087	GWB3633	4021034B00	GWB1342	432104177R	GWB6722	44300S84A02	GWB7587
328022	GWB0944	335090	GWB3633	4021034B00	GWB3224	432104A00A	GWB6820	44300S9A003	GWB6830
328023	GWB3598	335091	GWB3423	4021034B00	GWB3916	432104A00A	GWB7606	44300S9A008	GWB6830
328026	GWB6774	335092	GWB3657	4021034B00	GWB3917	4321050A00	GWB1363	44300S9H003	GWB7490
328103	GWB1432	335093	GWB6575	402103708R	GWB6721	432105162R	GWB1393	44300SAA003	GWB6825
328103	GWB3678	335097	GWB3584	4021041B00	GWB3703	432105162R	GWB3475	44300SCAE51	GWB6825
328103	GWB0736	335098	GWB3683	402104M400	GWB3272	432105162R	GWB6700	44300SDAA51	GWB3961
328103	GWB0754	336501	GWB0928	402104M400	GWB3940	432105162R	GWB6742	44300SDAA52	GWB3961
328104	GWB3256	336658	GWB0927	4021050A00	GWB1362	432108H300	GWB6805	44300SE0004	GWB1374
328104	GWB3786	357407625A	GWB1358	4021050W00	GWB3205	432109818R	GWB6742	44300SELT01	GWB3245
328105	GWB3410	357407625A	GWB1491	4021050Y00	GWB1340	43210AG000	GWB3997	44300SJKJ01	GWB7440
328105	GWB3412	357407625E	GWB1358	4021050Y00	GWB3201	43210AX000	GWB3525	44300SMGG01	GWB7469
328106	GWB3403	357407625E	GWB1491	4021050Y00	GWB3308	43210AX000	GWB3556	44300SNA951	GWB7469
330011	GWB0504	357498625	GWB1358	4021050Y05	GWB1340	43210AX000	GWB3658	44300SNA952	GWB7469

COMPETITOR	G-AP Ref.	COMPETITOR	G-AP Ref.	COMPETITOR	G-AP Ref.	COMPETITOR	G-AP Ref.	COMPETITOR	G-AP Ref.
OE		4686063J01	GWB6975	5020656	GWB1431	517202J001	GWB6956	527972	GWB0504
		4686076G01	GWB7456	5024195	GWB1431	517202J001	GWB6944	527972	GWB0528
44300SR3008	GWB3245	4686076G01	GWB7458	5024196	GWB1432	517202K000	GWB6923	527972	GWB0529
44300SR3A02	GWB3246	4686080G00	GWB6820	5024251	GWB1433	517202T000	GWB6891	527972	GWB0756
44300SR3A04	GWB3246	4686080G00	GWB7606	5025899	GWB1465	5172034000	GWB1970	527972	GWB0944
44300ST3E01	GWB3246	4686080G01	GWB7456	5025900	GWB1466	5172034000	GWB1973	527973	GWB0504
44300SWWE01	GWB7440	4686080G01	GWB7458	5025901	GWB1467	5172034000	GWB3906	5489811	GWB3902
44300T1GA01	GWB7440	4686083E00	GWB3966	5027620	GWB1480	5172034000	GWB6913	5516010506	GWB3430
44300TF0951	GWB7490	4686083E10	GWB3966	5030538	GWB1333	5172034100	GWB1970	5516010573	GWB0828
44300TR0951	GWB7469	46860M60D10	GWB1931	503103E101	GWB6956	5172034100	GWB1973	55703172	GWB6550
44300TR0952	GWB7469	46860M60D10	GWB3716	503103E101	GWB6944	5172034100	GWB3906	5890987	GWB1439
44300TV0E01	GWB7469	46860M60D10	GWB3717	503103E102	GWB6956	5172034100	GWB6913	5890990	GWB1438
44300TV2E01	GWB3961	46860M68K00	GWB6820	503103E102	GWB6944	5172034200	GWB1970	5890991	GWB1401
4430305	GWB3648	46860M68K00	GWB7606	503103E200	GWB6956	5172034200	GWB1973	5937306	GWB1307
4432022	GWB7534A	46860T62J00	GWB6639	503103E200	GWB6944	5172034200	GWB3906	5947834	GWB1307
443311413	GWB0962	46860T62J00	GWB7525	503103E201	GWB6956	5172034200	GWB6913	5996248	GWB3430
443407625A	GWB0962	46880M70F10	GWB1931	503103E201	GWB6944	5172038000	GWB3909	5996253	GWB3430
443407625D	GWB0962	46880M70F10	GWB3717	503644252	GWB3552	5172038100	GWB3909	6001539074	GWB0961
443407625F	GWB1356	4700322	GWB3571	504288649	GWB3551	5172038110	GWB6891	6001543344	GWB3496
443407625F	GWB3605	4700323	GWB3572	507700495	GWB3599	517203A000	GWB6891	6001547686	GWB6561
443407625H	GWB1356	4706538	GWB6640	510384	GWB3519	517203A101	GWB6891	6001547696	GWB3596
443407625H	GWB3605	4706538	GWB6642	510384	GWB0528	517203A200	GWB6938	6001548986	GWB3525
443498625	GWB0613A	4707157	GWB6643	510384	GWB0529	51720FD000	GWB1383	6001550915	GWB3637
443498625A	GWB1356	4707157	GWB7526	510384	GWB0542	51720FD000	GWB1928	60055388	GWB0927
443498625B	GWB0962	4708249	GWB6639	510384	GWB0802	51720FD000	GWB0739	6013501510	GWB1470
443498625C	GWB0962	4709078	GWB6643	510384	GWB0944	51720FD000	GWB0949	60141947	GWB6742
443498625E	GWB0962	4709078	GWB7526	510385	GWB0504	51720FD000	GWB3949	6025370536	GWB3504
443498625F	GWB1356	4711556	GWB6639	510385	GWB0528	51720M2011	GWB1970	6040100283	GWB6878
4470124	GWB1445	491899	GWB3430	510385	GWB0529	51720M2011	GWB1973	6043300025	GWB3434
4470124	GWB3429	4A0407625A	GWB1356	510385	GWB0756	51720M2011	GWB3906	60510366	GWB1488
4488728	GWB3796	4A0407625A	GWB3605	510385	GWB0944	51720M2011	GWB6913	60521282	GWB3519
4501154	GWB3500	4A0498625	GWB1356	5105586AA	GWB7408	5173011100	GWB3217	60521282	GWB0528
4501155	GWB3501	4A0598625	GWB0542	5127496	GWB6731	5173011100	GWB3255	60521282	GWB0529
46393024	GWB3552	4A0598625A	GWB0542	5170144030	GWB1369	5173011100	GWB0534	60521282	GWB0542
46421951	GWB1488	4B0498625	GWB1355	5170144030	GWB7474	5173011101	GWB3217	60521282	GWB0802
46423869	GWB1439	4B0498625A	GWB1356	5170144030	GWB0826	5173011101	GWB3255	60521282	GWB0944
46423869	GWB3416	4B0598625B	GWB3535	5170344030	GWB1369	5173011101	GWB0534	60523333	GWB1465
46423870	GWB1401	4D0407625A	GWB3427	5170344030	GWB7474	51745702	GWB6570	60523333	GWB3519
46423870	GWB3413	4D0407625E	GWB1356	5170344030	GWB0826	51753789	GWB1401	60523333	GWB0523
46423871	GWB1438	4D0407625E	GWB3605	517034A000	GWB1369	51753789	GWB3413	60523333	GWB0526
46423871	GWB3414	5000388284	GWB0828	517034A000	GWB7474	51754191	GWB1439	60523333	GWB0542
46439334	GWB1410	5000388399	GWB1470	517034A000	GWB0826	51754191	GWB3416	60523333	GWB0911
46439334	GWB1495	5000389250	GWB1393	5172002000	GWB3907	51934100119	GWB1326	60523333	GWB0941
46439334	GWB3528	5000389250	GWB3475	5172002000	GWB6931	5270144110	GWB1909	606334	GWB3420
46512970	GWB3581	5000389250	GWB6700	5172002000	GWB7545	5270144110	GWB1951	606334	GWB3421
46512970	GWB3539	5000389250	GWB6742	517200Q000	GWB6923	5270144110	GWB1915	6077541	GWB0523
46519869	GWB3581	5000389879	GWB6693	5172011100	GWB0904	5270144110	GWB3727	6077541	GWB0526
46519869	GWB3539	5000389879	GWB0828	5172011101	GWB0904	5270144110	GWB3949	6077541	GWB0756
46527732	GWB3538	5000389906	GWB1470	517201C000	GWB3907	5270144120	GWB1909	6077541	GWB0941
46528566	GWB1438	5000391585	GWB3417	517201C000	GWB6931	5270144120	GWB1951	60801380	GWB1439
46528566	GWB3414	5000392236	GWB3417	517201C000	GWB7545	5270144120	GWB1915	60801380	GWB3416
46529970	GWB1439	5000392237	GWB1393	517201D000	GWB6891	5270144120	GWB3727	60811569	GWB1488
46529970	GWB3416	5000392237	GWB3475	5172021100	GWB1366	5270144120	GWB3949	60815880	GWB1439
46531160	GWB3577	5000392237	GWB6700	5172022000	GWB1366	5270344500	GWB1444	60815882	GWB1488
46532573	GWB6502	5000392237	GWB6742	5172025000	GWB3907	5270344520	GWB1444	60815902	GWB3539
4668442AA	GWB6590	5000685691	GWB6742	5172025000	GWB6931	5270344530	GWB1444	6113300725	GWB0596
46773659	GWB1438	5000685959	GWB6700	5172025000	GWB7545	5271026500	GWB6956	6113300825	GWB3434
46773659	GWB3414	5000788063	GWB3475	5172025001	GWB3907	5271026500	GWB6944	6140418	GWB3485
46773660	GWB3538	5000788202	GWB3475	5172025001	GWB6931	5271026510	GWB6956	6140418	GWB0918
46773661	GWB1439	5003090903	GWB1499	5172025001	GWB7545	5271026510	GWB6944	6140418	GWB0919
46773661	GWB3416	5003090903	GWB3434	5172029100	GWB3907	5271026530	GWB6956	6189218	GWB1431
46773662	GWB3581	5003090903	GWB6686	5172029100	GWB6931	5271026530	GWB6944	6199622	GWB1333
46773662	GWB3539	5007027	GWB0504	5172029100	GWB7545	5271044120	GWB1909	6199622	GWB3666
46836196	GWB3598	5007028	GWB0528	5172029150	GWB3907	5271044120	GWB1951	6319800102	GWB3404
46840M79010	GWB1931	5007029	GWB0523	5172029150	GWB6931	5271044120	GWB1915	6319810005	GWB3405
46840M79010	GWB3717	5007040	GWB0687	5172029150	GWB7545	5271044120	GWB3727	6319810605	GWB3405
46850M79010	GWB1931	5008716	GWB0740	5172029300	GWB3907	5271044120	GWB3949	6389810027	GWB3486
46850M79010	GWB3716	5010136758	GWB1499	5172029300	GWB6931	52710FD000	GWB0904	6389810027	GWB3518
46850M79010	GWB3717	5010136758	GWB3434	5172029300	GWB7545	52710FD000	GWB0947	6485018	GWB1432
4686060D00	GWB1931	5010136758	GWB6686	5172029400	GWB3907	52710FD000	GWB1353	6485018	GWB3678
4686060D00	GWB3716	5010762	GWB0741	5172029400	GWB6931	52710FD000	GWB1352	6485018	GWB0736
4686060D00	GWB3717	5011391	GWB0898	5172029400	GWB7545	527201F000	GWB6956	6485018	GWB0754
4686062J00	GWB6639	5011392	GWB0897	517202D000	GWB6812	527201F000	GWB6944	6553708	GWB1431
4686062J00	GWB7525	5012347	GWB0918	517202D100	GWB6812	5272447AA	GWB6591	6822JL	GWB3684
4686062J01	GWB6639	5012478	GWB0919	517202D200	GWB3909	5272448AA	GWB6591	6N0498625	GWB0906
4686062J01	GWB7525	5020654	GWB1333	517202G000	GWB6891	5273036200	GWB0904	6U0407625A	GWB3441
4686063J00	GWB6975	5020655	GWB1333	517202H000	GWB6923	5273036200	GWB0947	6U0501319	GWB0504

COMPETITOR	G-AP Ref.	COMPETITOR	G-AP Ref.	COMPETITOR	G-AP Ref.	COMPETITOR	G-AP Ref.	COMPETITOR	G-AP Ref.
OE		7555466	GWB1438	7910012339	GWB0652	893498625B	GWB1355	9004366022	GWB3950
		7555466	GWB3414	7L0498287	GWB3645	893498625C	GWB1356	9004366022	GWB0841
6U0501319	GWB0528	7558570	GWB1401	7M0407625	GWB3449	893498625D	GWB1355	9004366039	GWB1956
6U0501319	GWB0529	7558570	GWB3413	7M0407625	GWB3450	893498625E	GWB1356	9004366039	GWB3775
6U0501319	GWB0756	7700830794	GWB3495	7M0498625	GWB3449	8941512130	GWB3256	9004368006	GWB3796
6U0501319	GWB0944	7700841382	GWB3504	7M0598625A	GWB3450	8941512130	GWB3786	9004A36093	GWB6967
6U0598625	GWB0529	7701205416	GWB3500	7M3498625	GWB3449	8942013090	GWB0904	9004A36094	GWB7549
7162191	GWB1393	7701205417	GWB3501	7M3598625	GWB3450	8942013100	GWB3217	9008036021	GWB3237
7162191	GWB3475	7701205596	GWB0976	803407625	GWB0613A	8942013100	GWB3255	9008036021	GWB3945
7162191	GWB6700	7701205692	GWB0909	811407625D	GWB0575	8942013100	GWB0534	9008036064	GWB1909
7162191	GWB6742	7701205778	GWB3496	811407625F	GWB0575	8942426830	GWB1369	9008036064	GWB1951
7164487	GWB6742	7701205779	GWB3596	81934200352	GWB3496	8942426830	GWB7474	9008036064	GWB3727
71714450	GWB1444	7701205780	GWB3495	81934206009	GWB1397	8942426830	GWB0826	9008036067	GWB1909
71714452	GWB3430	7701205812	GWB3525	81934206009	GWB0802	8942429130	GWB1369	9008036067	GWB1951
71714454	GWB3429	7701205972	GWB3492	81934206009	GWB0911	8942429130	GWB7474	9008036067	GWB1915
71714457	GWB3539	7701206661	GWB3608	81AB1215A	GWB1433	8942429130	GWB0826	9008036067	GWB3727
71714458	GWB3577	7701206740	GWB3613	81AB1215A	GWB1473	8942451390	GWB3255	9008036067	GWB3949
71714459	GWB3538	7701206742	GWB3614	81AB1215A	GWB0687	8942451390	GWB0534	9008036078	GWB3237
71714460	GWB1439	7701206771	GWB3615	81AB1215A	GWB0740	8942451390	GWB0947	9008036078	GWB3945
71714464	GWB3528	7701206847	GWB3618	81AB1215A	GWB0741	895322M91	GWB1465	9008036087	GWB3979
71714466	GWB3413	7701206848	GWB3616	81AB1215A	GWB0897	895322M91	GWB3519	9008036087	GWB6831
71714468	GWB3414	7701206849	GWB3617	81AB1215A	GWB0898	895322M91	GWB0523	9008036108	GWB3929
71714472	GWB1488	7701207358	GWB3648	81AB1215A	GWB1455	895322M91	GWB0526	9008036137	GWB3979
71714473	GWB3423	7701207676	GWB3638	81AB1215AB	GWB1433	895322M91	GWB0542	9008036137	GWB6831
71714480	GWB3416	7701207677	GWB3637	81AB1215AB	GWB1473	895322M91	GWB0911	9008036149	GWB3979
71731547	GWB3633	7701207966	GWB3648	81AB1215AB	GWB0687	895322M91	GWB0941	9008036149	GWB6831
71732444	GWB3649	7701208058	GWB3639	81AB1215AB	GWB0740	895322M91	GWB0926	9008036176	GWB3979
71742699	GWB6578	7701208059	GWB3676	81AB1215AB	GWB0741	89FB1238AC	GWB1333	9008036176	GWB6831
71745046	GWB6550	7701208060	GWB3608	81AB1215AB	GWB0897	89FB1238AC	GWB3666	9008036178	GWB3929
71745047	GWB6540	7701208427	GWB3648	81AB1215AB	GWB0898	89FB1238AD	GWB1333	9008036206	GWB6901
71746393	GWB1307	7701208429	GWB3608	81AB1215AB	GWB1455	89FB1238AD	GWB3666	90095271	GWB3257
71753061	GWB3539	7701208950	GWB3692	81AB1238AA	GWB1465	89FB1K040AC	GWB1431	90095271	GWB3785
71753062	GWB3538	7701209504	GWB3639	81AB1238AA	GWB3519	8A0498625	GWB1355	9013301025	GWB6686
71753812	GWB6502	7701209807	GWB3608	81AB1238AA	GWB0523	8D0498625	GWB1355	9023500068	GWB3435
71753818	GWB3642	7701209838	GWB3692	81AB1238AA	GWB0526	8D0498625A	GWB3427	9023501410	GWB3435
71753820	GWB3598	7701210004	GWB6658	81AB1238AA	GWB0542	8D0498625B	GWB1356	90235281	GWB1326
71753821	GWB3599	7701210111	GWB3638	81AB1238AA	GWB0756	8D0598625	GWB3519	90279331	GWB3256
7180066	GWB3552	7701460642	GWB0652	81AB1238AA	GWB0904	8D0598625A	GWB1355	90279331	GWB3786
7182301	GWB3664	7701462021	GWB0909	81AB1238AA	GWB0911	8E0598625	GWB3605	90279332	GWB1432
7185978	GWB3664	7701463523	GWB0969	81AB1238AA	GWB0941	8L0498625	GWB3607	90279332	GWB3257
7187566	GWB3552	7701463986	GWB0975	81AB1238AA	GWB0947	8L0498625A	GWB3607	90279332	GWB3678
7189750	GWB3552	7701463987	GWB0976	81AB1238AA	GWB0926	90005147	GWB0944	90279332	GWB3785
728103	GWB1432	7701464049	GWB3596	81AB1238AA	GWB1353	9000709340	GWB1465	90279332	GWB0736
728103	GWB3678	7701465647	GWB0828	81AB1238AA	GWB1352	9000709340	GWB3519	90279332	GWB0754
728103	GWB0736	7701469682	GWB3504	81AB1238BA	GWB0523	9000709340	GWB0523	9036338006	GWB1911
728103	GWB0754	7703090029	GWB3405	81AB1238BA	GWB0526	9000709340	GWB0526	9036338006	GWB3729
72GB1200AA	GWB3255	7703090034	GWB1324	81AB1238BA	GWB0756	9000709340	GWB0542	9036338006	GWB3730
72GB1200AA	GWB3519	7703090045	GWB0540	81AB1238BA	GWB0941	9000709340	GWB0911	9036340020	GWB3740
72GB1200AA	GWB0528	7703090085	GWB3430	82289841	GWB1439	9000709340	GWB0941	9036340020	GWB0827
72GB1200AA	GWB0529	7703090199	GWB0909	82289841	GWB3416	9000936030	GWB3217	9036340041	GWB3740
72GB1200AA	GWB0534	7703090251	GWB3496	823407625B	GWB0575	9000936030	GWB3255	9036340041	GWB0827
72GB1200AA	GWB0542	7703090253	GWB3525	82374669	GWB1439	9000936030	GWB0534	9036340047	GWB3740
72GB1200AA	GWB0802	7703090253	GWB3556	82374669	GWB3416	9000936042	GWB3217	9036340047	GWB0827
72GB1200AA	GWB0944	7703090253	GWB3658	82390273	GWB1439	9000936042	GWB3255	9036340066	GWB3979
72GB1200AA	GWB0947	7703090253	GWB0961	82390273	GWB3416	9000936042	GWB0534	9036340066	GWB6831
72GB1215AA	GWB3217	7703090266	GWB0652	8582739	GWB0926	9000936050	GWB0904	9036340068	GWB6901
72GB1215AA	GWB3255	7703090267	GWB0540	85GB1238AA	GWB3485	9000936061	GWB0904	9036340079	GWB6878
72GB1215AA	GWB0504	7703090267	GWB0652	85GB1238AA	GWB0918	90016721	GWB0526	90363T0009	GWB6901
72GB1215AA	GWB0528	7703090283	GWB3496	85GB1238AA	GWB0919	90030000	GWB6720	90363T0015	GWB3979
72GB1215AA	GWB0529	7703090313	GWB0969	867407625A	GWB0577	9004363079	GWB1931	90363T0015	GWB6831
72GB1215AA	GWB0534	7703090325	GWB0975	871498625A	GWB0577	9004363079	GWB3716	90363T0023	GWB6878
72GB1215AA	GWB0756	7703090341	GWB1465	8824111	GWB0523	9004363079	GWB3717	90363W0001	GWB3946
72GB1215AA	GWB0944	7703090365	GWB3521	8824111	GWB0526	9004363150	GWB6966	90363W0001	GWB6849
7413406	GWB0523	7703090365	GWB0976	8824111	GWB0756	9004363151	GWB6966	90363W0005	GWB6878
7413406	GWB0526	7703090404	GWB3496	8824111	GWB0941	9004363187	GWB6967	90363W0006	GWB6878
7413406	GWB0756	7703090433	GWB3525	8906240	GWB0504	9004363213	GWB6967	9036547013	GWB1905
7413406	GWB0941	7703090433	GWB3556	893373M91	GWB0523	9004363214	GWB6967	9036617010	GWB3217
7413409	GWB1465	7703090433	GWB3658	893373M91	GWB0526	9004363252	GWB6966	9036617010	GWB3255
7413409	GWB3519	7703090433	GWB0961	893373M91	GWB0756	9004363253	GWB6966	9036617010	GWB0534
7413409	GWB0523	7903090002	GWB0540	893373M91	GWB0941	9004363314	GWB6967	9036627001	GWB3217
7413409	GWB0526	7903090002	GWB0652	893407625	GWB1355	9004363315	GWB7549	9036817017	GWB3217
7413409	GWB0542	7903090266	GWB0540	893407625	GWB3535	9004363319	GWB6966	9036817017	GWB3255
7413409	GWB0911	7903090266	GWB0652	893407625C	GWB1355	9004363320	GWB6966	9036817017	GWB0534
7413409	GWB0941	7903090267	GWB0540	893407625C	GWB3535	9004363361	GWB6966	9036819037	GWB0904
7485139097	GWB3552	7903090267	GWB0652	8934655	GWB1498	9004363368	GWB6967	9036819037	GWB0947
755466	GWB1438	7910012338	GWB0652	893498625	GWB1355	9004363369	GWB7549	9036821001	GWB1369
755466	GWB3414	7910012339	GWB0540	893498625A	GWB1355	9004366022	GWB3206	9036821001	GWB7474

COMPETITOR	G-AP Ref.	COMPETITOR	G-AP Ref.	COMPETITOR	G-AP Ref.	COMPETITOR	G-AP Ref.	COMPETITOR	G-AP Ref.
OE		9161454	GWB3500	95592226	GWB3525	B09226175	GWB3255	FB0126151D	GWB7446
		9161455	GWB3501	95592226	GWB3556	B09226175	GWB0534	FB0126151E	GWB1948
9036821001	GWB0826	9192000	GWB1465	95592226	GWB3658	B09226175	GWB0947	FB0126151E	GWB7446
9036821065	GWB1369	9192000	GWB3519	95592226	GWB0961	B2162617X	GWB1353	GA2A33047	GWB1948
9036821065	GWB7474	9192000	GWB0523	95603182	GWB1327	B2162617X	GWB1352	GA2A33047	GWB7446
9036821065	GWB0826	9192000	GWB0526	95608940	GWB3525	B45533047A	GWB1950	GA2A33047A	GWB1948
9036826027	GWB0904	9192000	GWB0542	95608940	GWB3556	B45533047C	GWB1950	GA2A33047A	GWB7446
9036829068	GWB3255	9192000	GWB0911	95608940	GWB3658	B45533047D	GWB1950	GA2A33047B	GWB1948
9036829068	GWB0534	9192000	GWB0941	95608940	GWB0961	BA15823600	GWB0927	GA2A33047B	GWB7446
9036829068	GWB0947	9192000	GWB0926	95619160	GWB0915	BA15823700	GWB0927	GAM633047A	GWB7538
9036834001	GWB1369	9192133	GWB0504	95654074	GWB1327	BBM233047	GWB6972	GAM633047C	GWB7538
9036834001	GWB7474	9196286	GWB3601	95654076	GWB0882	BBM233047	GWB7536	GE15823600	GWB0523
9036834001	GWB0826	91AB1215AA	GWB1432	95654078	GWB0961	BN8B33047	GWB1948	GE15823600	GWB0526
9036834039	GWB1369	91AB1215AA	GWB3678	9567217680	GWB3423	BN8B33047	GWB7446	GE15823600	GWB0526
9036834039	GWB7474	91AB1215AA	GWB0736	959232207	GWB0828	BN8B33047A	GWB1948	GE15823600	GWB0941
9036834039	GWB0826	91AB1215AA	GWB0754	96095947	GWB1412	BN8B33047A	GWB7446	GHB101	GWB0504
9036834083	GWB3901	91AB1K040AB	GWB1431	96129301	GWB0915	BP4L33047A	GWB6972	GHB102	GWB1465
9036845087	GWB1909	9203934	GWB3571	96285525	GWB3901	BP4L33047A	GWB7536	GHB102	GWB3519
9036845087	GWB1951	9203935	GWB3572	96316634	GWB3796	BP4L33047B	GWB6972	GHB102	GWB0523
9036845087	GWB1915	9213602	GWB6640	96316635	GWB3796	BP4L33047B	GWB7536	GHB102	GWB0526
9036845087	GWB3727	9213602	GWB6642	96316760	GWB3901	C23626151A	GWB6972	GHB102	GWB0542
9036845087	GWB3949	9214025	GWB6643	969106800	GWB3441	C23626151A	GWB7536	GHB102	GWB0911
9036849084	GWB1909	9214025	GWB7526	969106801	GWB3441	C23626151B	GWB6972	GHB102	GWB0941
9036849084	GWB1951	92403013	GWB3598	969300171	GWB0504	C23626151B	GWB7536	GHB102	GWB0926
9036849084	GWB3727	92VB1215AA	GWB1465	969300171	GWB0528	C23626151C	GWB6972	GHB105	GWB0523
9036928006	GWB1345	92VB1225BA	GWB1466	969300171	GWB0529	C23626151C	GWB7536	GHB105	GWB0526
9036930044	GWB1344	92VB1238BA	GWB1467	969300171	GWB0756	C23626151D	GWB6972	GHB105	GWB0756
9036935029	GWB1342	93161059	GWB3648	969300171	GWB0944	C23626151D	GWB7536	GHB105	GWB0941
9036935029	GWB3224	93161376	GWB3648	969300291	GWB3519	C45710	GWB1498	GHB107	GWB0504
9036935029	GWB3916	93168535	GWB6720	969300291	GWB0528	C45710	GWB3565	GHB107	GWB0528
9036935029	GWB3917	93188889	GWB6550	969300291	GWB0529	CAC4603	GWB3519	GHB107	GWB0529
9036936043	GWB1340	93188890	GWB6540	969300291	GWB0542	CAC4603	GWB0528	GHB107	GWB0756
9036936043	GWB3201	93192990	GWB6639	969300291	GWB0802	CAC4603	GWB0529	GHB107	GWB0944
9036936043	GWB3308	93192990	GWB7525	969300291	GWB0944	CAC4603	GWB0542	GHB112	GWB0504
9036938003	GWB1340	93193920	GWB6643	969300590	GWB0523	CAC4603	GWB0802	GHB143	GWB0749
9036938003	GWB3201	93193920	GWB7526	969300590	GWB0526	CAC4603	GWB0944	GHB197	GWB3420
9036938003	GWB3308	93197149	GWB6721	969300590	GWB0756	CAC4999	GWB1498	GHB197	GWB3421
9036938011	GWB1911	93197150	GWB6722	969300590	GWB0941	CAC6332	GWB3434	GHB209	GWB1498
9036938011	GWB3729	93824580	GWB3551	96995000	GWB3902	CAC6332	GWB6686	GHB209	GWB3565
9036938011	GWB3730	93BB1215AB	GWB1480	97114406308	GWB3740	CAC6333	GWB1397	GHB271	GWB0910
9036938021	GWB3929	94020002	GWB3430	9714406308	GWB0827	CAC6333	GWB3404	GHK1140	GWB0749
9036938022	GWB3929	9403350889	GWB6575	985778	GWB0928	D0210F1700	GWB1369	GHK1692	GWB3603
9036940003	GWB3765	9403350930	GWB6575	9860302060	GWB3796	D0210F1700	GWB7474	GHK1933	GWB1374
9036943008	GWB3237	94535209+94535210	GWB3217	9900011425	GWB1444	D0210F1700	GWB0826	GJ2126151	GWB1349
9036943008	GWB3945	94535209+94535210	GWB3255	996030208	GWB3206	D0215F1700	GWB1369	GP9A33047A	GWB3946
9036943009	GWB3237	94535209+94535210	GWB0534	996030208	GWB0950	D0215F1700	GWB7474	GP9A33047A	GWB6849
9036943009	GWB3945	94535214	GWB7573	996030208	GWB0841	D0215F1700	GWB0826	GP9A33047C	GWB3946
9036945003	GWB3946	94535218	GWB3255	996253	GWB3430	D35026151B	GWB3532	GP9A33047C	GWB6849
9036945003	GWB6849	94535218	GWB0534	9966510	GWB1498	D35026151B	GWB6515	GP9A33047D	GWB3946
9036945005	GWB3946	94535218	GWB0947	99905901800	GWB0523	D35026151C	GWB3532	GP9A33047D	GWB6849
9036945005	GWB6849	94535247	GWB3256	99905901800	GWB0526	D35026151C	GWB6515	GS1D33047	GWB6972
9036947001	GWB3985	94535247	GWB3786	99905901800	GWB0756	D35033047A	GWB3530	GS1D33047	GWB7536
9036954001	GWB3974	94535249	GWB3256	99905901800	GWB0941	D35033047B	GWB3530	GS1D33047	GWB7537
9036954002	GWB3974	94535249	GWB3786	99905906100	GWB1498	D35133047A	GWB3531	GS1D33047A	GWB6972
90369W0001	GWB3684	94535253	GWB3902	99905906500	GWB1465	D35133047A	GWB6653	GS1D33047A	GWB7536
90425658	GWB3410	94535254	GWB3257	99905906500	GWB3525	D35133047B	GWB3531	GS1D33047A	GWB536
90425658	GWB3412	94535254	GWB3785	99905906500	GWB0523	D35133047B	GWB6653	GS1D33047B	GWB6972
90425658	GWB3543	94535259	GWB3902	99905906500	GWB0526	D65133047A	GWB3531	GS1D33047B	GWB7536
90447280	GWB3403	94535982	GWB3902	99905906500	GWB0542	D65133047A	GWB6653	GS1D33047B	GWB7537
90486457	GWB0526	94536117	GWB3256	99905906500	GWB0911	D65133047B	GWB3531	GS1D33047C	GWB6972
90486458	GWB3256	94536117	GWB3786	99905906500	GWB0941	D65133047B	GWB6653	GS1D33047C	GWB7536
90486460	GWB0736	94797384	GWB3255	99905908902	GWB0596	FA15823600	GWB0926	GS1D33047C	GWB7537
90486461	GWB0754	94797384	GWB0534	A0009800316	GWB0757	FA15824400	GWB1465	HB14030202	GWB1307
90486463	GWB0944	94797384	GWB0947	ANR5861	GWB3527	FA15824400	GWB3519	KK15033047	GWB1383
90486468	GWB1326	95035620	GWB1412	B00133047	GWB1383	FA15824400	GWB0523	KK15033047	GWB1928
90510542	GWB3410	95496252	GWB0915	B00133047	GWB1928	FA15824400	GWB0526	KK15033047	GWB0739
90510544	GWB3403	95507285	GWB1393	B00133047	GWB0739	FA15824400	GWB0542	KK15033047	GWB0949
906020011	GWB1931	95507285	GWB3475	B00133047	GWB0949	FA15824400	GWB0911	KK15033047	GWB3949
906020011	GWB3717	95507285	GWB6700	B00133047	GWB3949	FA15824400	GWB0941	KKY0133047	GWB0904
906100004	GWB3796	95507285	GWB6742	B00233047	GWB0904	FA15824400	GWB0926	KKY0133075	GWB3217
906100005	GWB3796	95507286	GWB6742	B00233075	GWB3217	FB0126151A	GWB1948	KKY0133075	GWB3255
9111023	GWB3613	95507796	GWB6639	B00233075	GWB3255	FB0126151A	GWB7446	KKY0133075	GWB0534
9111044	GWB3614	95507796	GWB7525	B00233075	GWB0534	FB0126151B	GWB1948	MB001315	GWB1370
91159917	GWB3617	95511623	GWB3598	B09226075	GWB0904	FB0126151B	GWB7446	MB001835	GWB0904
91160086	GWB3618	95511624	GWB3599	B09226075	GWB0947	FB0126151C	GWB1948	MB001836	GWB3217
91160087	GWB3616	95513921	GWB3598	B09226075	GWB1353	FB0126151C	GWB7446	MB001836	GWB3255
9140844	GWB1314	95513922	GWB6774	B09226075	GWB1352	FB0126151D	GWB1948	MB001836	GWB0534

COMPETITOR	G-AP Ref.	COMPETITOR	G-AP Ref.	COMPETITOR	G-AP Ref.	COMPETITOR	G-AP Ref.	COMPETITOR	G-AP Ref.
OE		RTC3808	GWB0941						
		RUD100150	GWB3603						
95534190100	GWB3645	S08333047	GWB1369						
95590022	GWB0915	S08333047	GWB7474						
MB002073	GWB0904	S08333047	GWB0826						
MB002073	GWB0947	S08333075	GWB3796						
MB002073	GWB1353	S23133047	GWB1383						
MB002073	GWB1352	S23133047	GWB1909						
MB00233047	GWB0904	S23133047	GWB1928						
MB00233075	GWB3217	S23133047	GWB1951						
MB00233075	GWB3255	S23133047	GWB0739						
MB00233075	GWB0534	S23133047	GWB0949						
MB092185	GWB3967	S23133047	GWB1915						
MB092185	GWB3968	S23133047	GWB3727						
MB092749	GWB1909	S23133047	GWB3949						
MB092749	GWB1951	S23133075	GWB1383						
MB092749	GWB1915	S23133075	GWB1928						
MB092749	GWB3727	S23133075	GWB0739						
MB092749	GWB3949	S23133075	GWB0949						
MB109564	GWB1369	S23133075	GWB3949						
MB109564	GWB7474	STC4382	GWB3420						
MB109564	GWB0826	STC4382	GWB3421						
MB109565	GWB1369	UH7126175	GWB3206						
MB109565	GWB7474	UH7126175	GWB3950						
MB109565	GWB0826	UH7126175	GWB0841						
MB242820	GWB1367	UH7433047	GWB1909						
MB303865	GWB1970	UH7433047	GWB1951						
MB303865	GWB1973	UH7433047	GWB1915						
MB303865	GWB3906	UH7433047	GWB3727						
MB303865	GWB6913	UH7433047	GWB3949						
MB349416	GWB1366	UH7433075	GWB1383						
MB515470	GWB1962	UH7433075	GWB1928						
MB515471	GWB1961	UH7433075	GWB0739						
MB664447	GWB1956	UH7433075	GWB0949						
MB664447	GWB3775	UH7433075	GWB3949						
MB664611	GWB3325	UM5133047	GWB7534A						
MB808442	GWB3309	V893407625G	GWB1355						
MB808442	GWB6845	V893407625G	GWB3535						
MB932726	GWB1909	VP2S7W1215AA	GWB3625						
MB932726	GWB1951	XM341215AA	GWB1369						
MB932726	GWB1915	XM341215AA	GWB7474						
MB932726	GWB3727	XM341215AA	GWB0826						
MB932726	GWB3949	XM341216CA	GWB3796						
MN101347	GWB7408	XM341244AA	GWB3206						
MR403500	GWB3272	XM341244AA	GWB3950						
MR403500	GWB3940	XM341244AA	GWB0841						
MR449797	GWB3309	XR81723	GWB3688						
MR449797	GWB6845	ZF04330648	GWB1445						
MR491449	GWB6926	ZF04330648	GWB3429						
MR519097	GWB3272	ZF04470124	GWB1445						
MR519097	GWB3940	ZF04470124	GWB3429						
OK67233047A	GWB1909	ZF05996248	GWB3430						
OK67233047A	GWB1951								
OK67233047A	GWB1915								
OK67233047A	GWB3727								
OK67233047A	GWB3949								
OS23133075	GWB1383								
OS23133075	GWB1928								
OS23133075	GWB0739								
OS23133075	GWB0949								
OS23133075	GWB3949								
PLC1512	GWB3441								
RFC000010	GWB3603								
RFM000060	GWB1374								
RTC3398	GWB1465								
RTC3398	GWB3519								
RTC3398	GWB0523								
RTC3398	GWB0526								
RTC3398	GWB0542								
RTC3398	GWB0911								
RTC3398	GWB0941								
RTC3398	GWB0926								
RTC3429	GWB3420								
RTC3429	GWB3421								
RTC3808	GWB0523								
RTC3808	GWB0526								
RTC3808	GWB0756								

Hub Assemblies

Photo.....

GHA223001

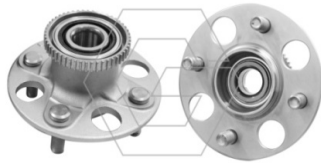

GHA225006K

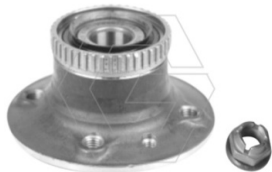

GHA225008

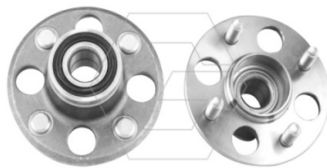

GHA225010K



GHA225012K



GHA225014K

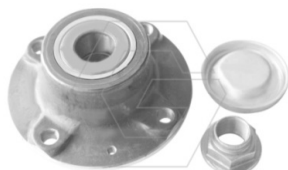

GHA225003K

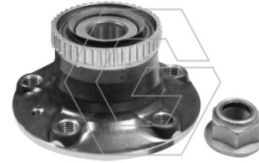

GHA225006F

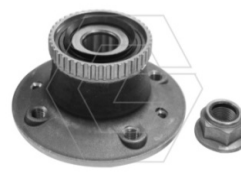

GHA225009A

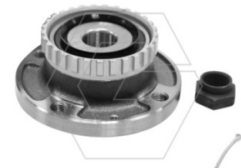

GHA225011K



GHA225013K



GHA225015K

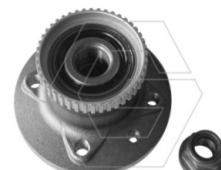

Hub Assemblies

Photo.....

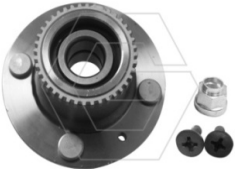
GHA225016 
GHA225021K 
GHA225025K 
GHA225027K 
GHA225029K 
GHA225031K 

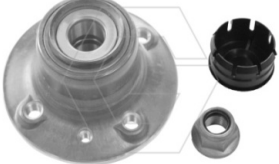
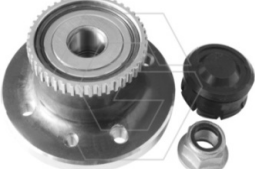
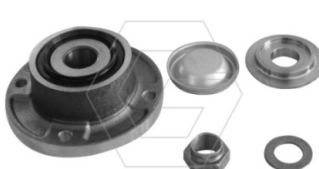
GHA225020K 
GHA225022K 
GHA225026K 
GHA225028K 
GHA225030K 
GHA225032K 

Hub Assemblies

Photo.....



Hub Assemblies

Photo.....

GHA227014

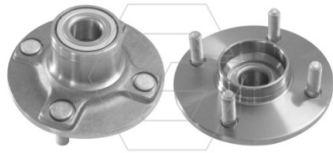

GHA227017K

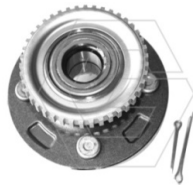

GHA227019

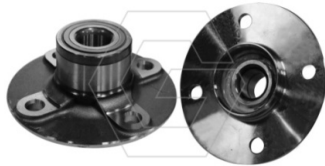

GHA227015

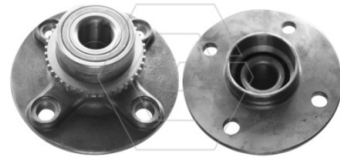

GHA227018K



GHA227022F



GHA227023K



GHA227026K

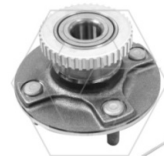

GHA228006K

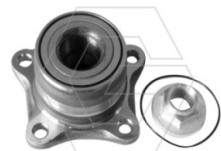

GHA228009

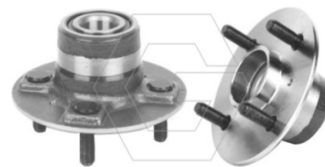

GHA228011

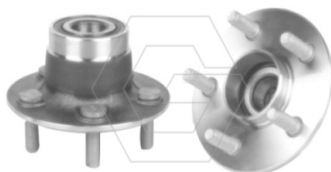

GHA228013



Hub Assemblies

Photo.....

GHA228014

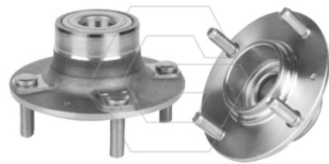

GHA228016



GHA228018K

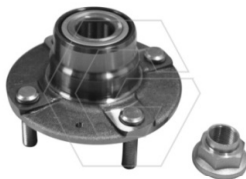

GHA228020K



GHA228026K

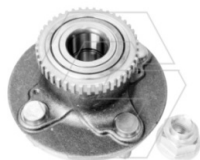

GHA228028K



GHA228015



GHA228017K

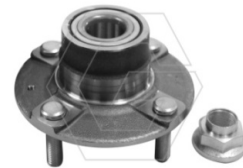

GHA228019K



GHA228022K

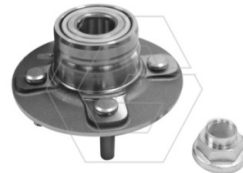

GHA228027K

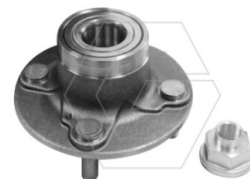

GHA228029K



Hub Assemblies

Photo.....

GHA228030K

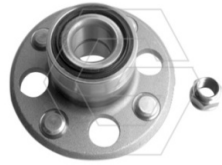

GHA228032K

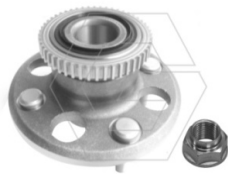

GHA228034K



GHA228036K

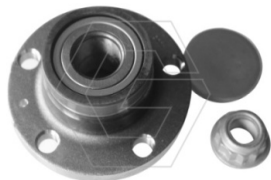

GHA228038K



GHA228046K



GHA228031K



GHA228033K



GHA228035K

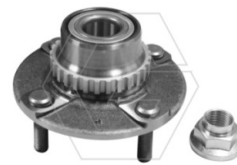

GHA228037

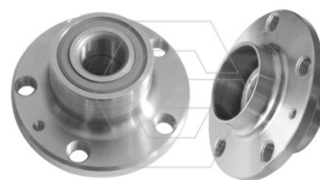

GHA228041K

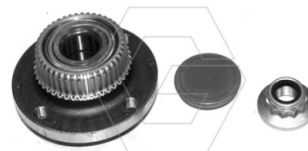

GHA228048

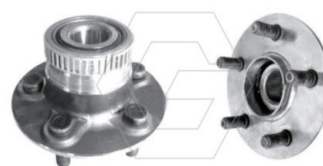

Hub Assemblies

Photo.....

GHA228049K

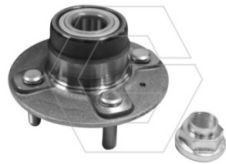

GHA228051K



GHA228055



GHA228057K



GHA228061K

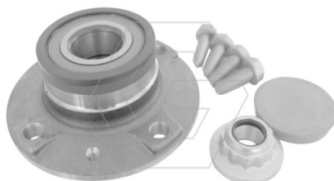

GHA228067K

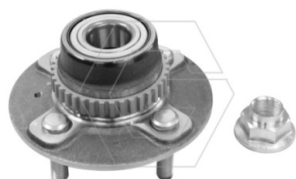

GHA228050



GHA228052

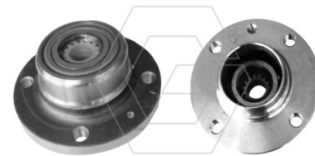

GHA228056K



GHA228058K

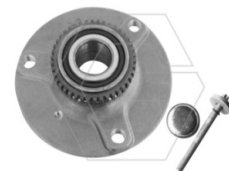

GHA228066K



GHA228068K

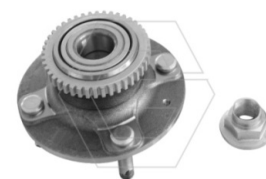

Hub Assemblies

Photo.....

GHA228071

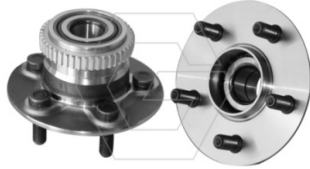

GHA228072

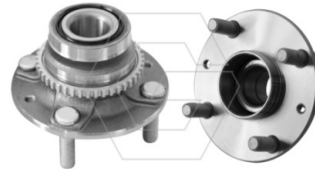

GHA228074K



GHA229001

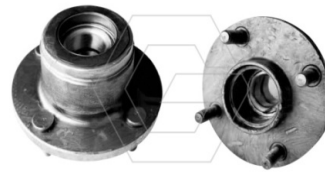

GHA230002F



GHA230002S



GHA230003K



GHA230004

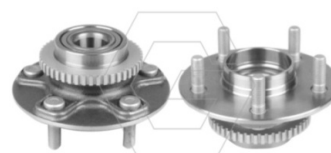

GHA230005K

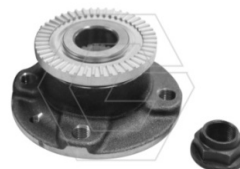

GHA230007



GHA230008K

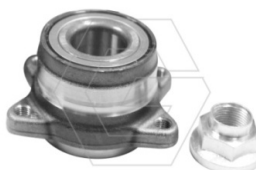

GHA230014K

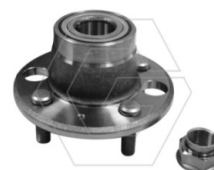

Hub Assemblies

Photo.....

GHA230015K



GHA230020K

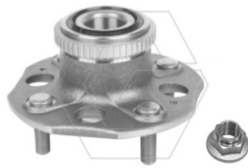

GHA230023K



GHA230026K

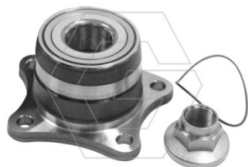

GHA230029K



GHA230032K



GHA230017K



GHA230022

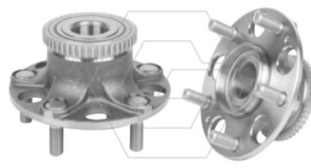

GHA230024K

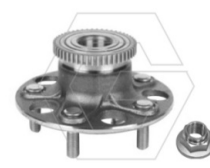

GHA230028K



GHA230030K



GHA230034K



Hub Assemblies

Photo.....

GHA230035K



GHA230037K

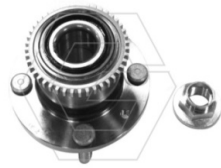

GHA230039K



GHA230044K



GHA230047K



GHA230050K



GHA230036



GHA230038K

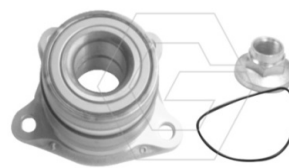

GHA230040K



GHA230046K

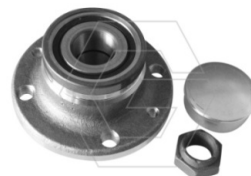

GHA230049K

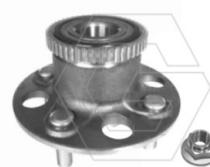

GHA230051K

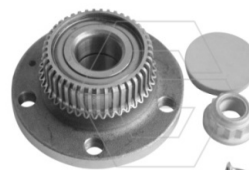

Hub Assemblies

Photo.....

GHA230052K

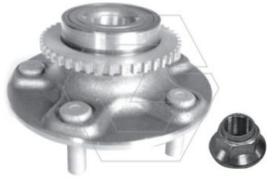

GHA230053

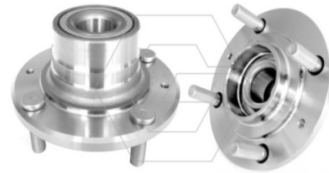

GHA230057K



GHA230058K

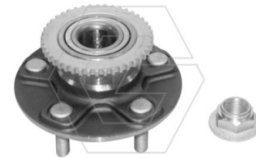

GHA230061K

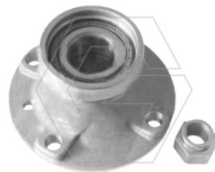

GHA230062

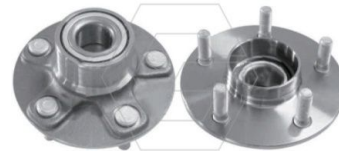

GHA230065K



GHA230066K

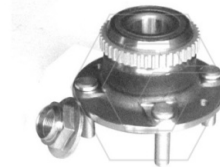

GHA230067K



GHA230068K

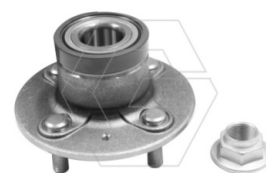

GHA230069

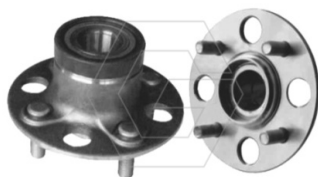

GHA230070

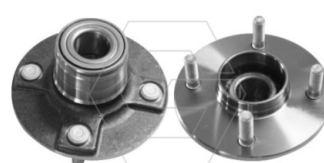

Hub Assemblies

Photo.....



Hub Assemblies

Photo.....

GHA230092K

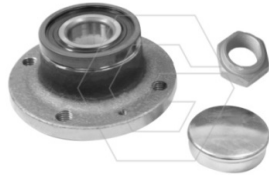

GHA230093K



GHA230095

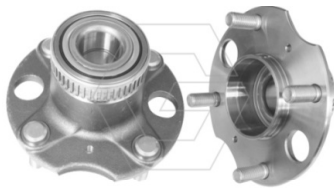

GHA230098K

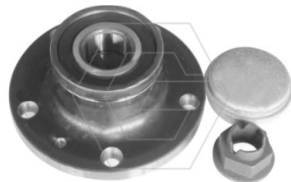

GHA230104K

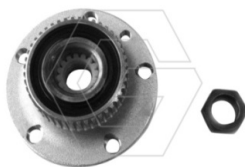

GHA230108K



GHA230092S



GHA230094K

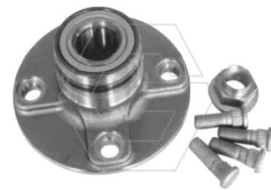

GHA230097K

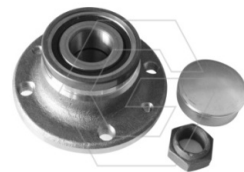

GHA230100

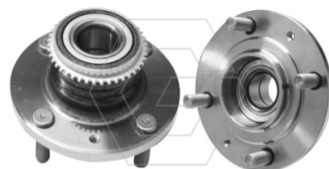

GHA230107

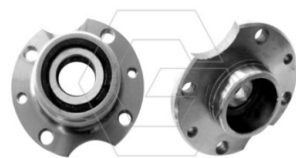

GHA230109K

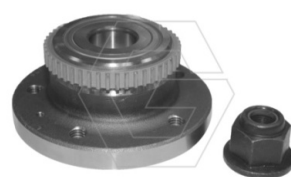

Hub Assemblies

Photo.....



Hub Assemblies

Photo.....

GHA230122K



GHA230124

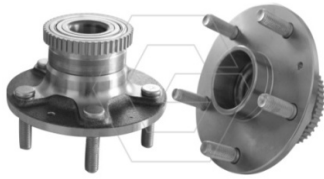

GHA230127



GHA230123K

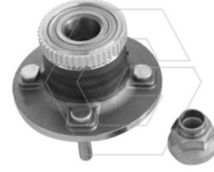

GHA230125K



GHA230128

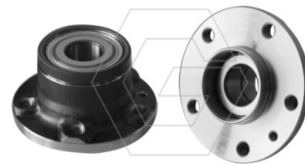

GHA230131

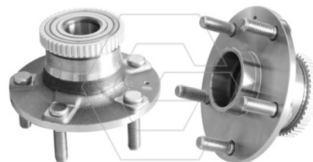

GHA230134K



GHA230135

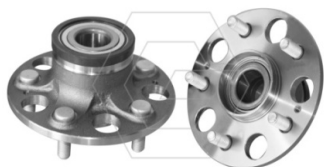

GHA230151K



GHA230152



GHA231001K



Hub Assemblies

Photo.....

GHA232001K



GHA232004K

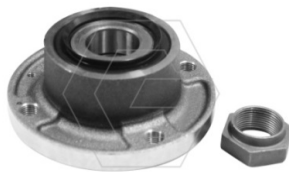

GHA232007F

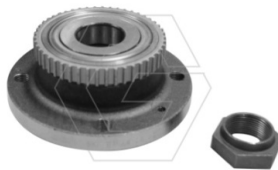

GHA232011K



GHA232013K

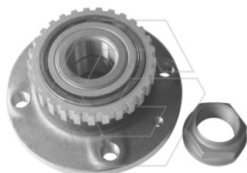

GHA232015K

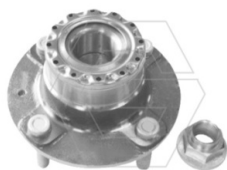

GHA232002K

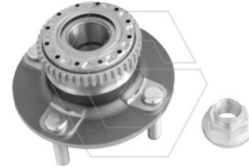

GHA232005

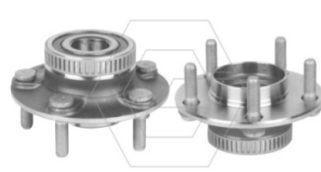

GHA232008K



GHA232012K

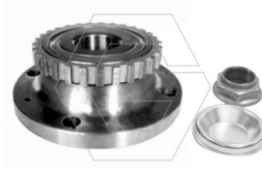

GHA232014K

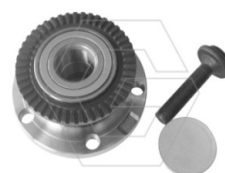

GHA232018K

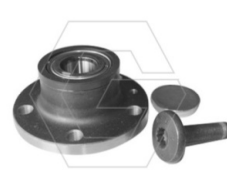

Hub Assemblies

Photo.....

GHA232021K 
GHA232023 
GHA232025 
GHA232028K 
GHA232030K 
GHA232032K 

GHA232022K 
GHA232024K 
GHA232026K 
GHA232029K 
GHA232031K 
GHA232033K 

Hub Assemblies

Photo.....



Hub Assemblies

Photo.....

GHA233003

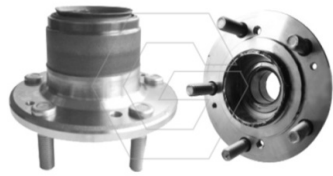

GHA233007K



GHA233009K

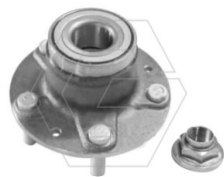

GHA233011

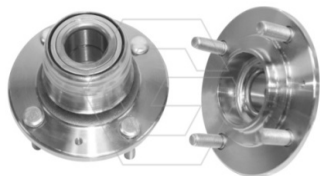

GHA233013

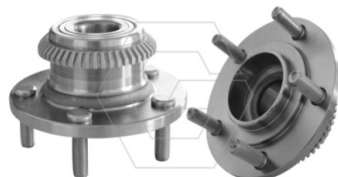

GHA233016

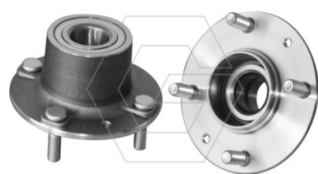

GHA233005K



GHA233008

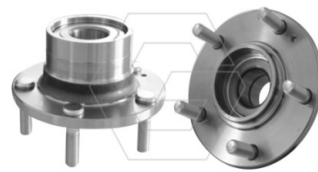

GHA233010K



GHA233012

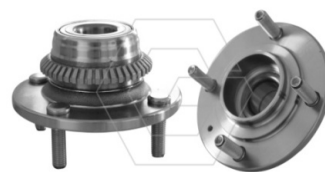

GHA233014

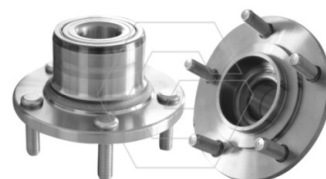

GHA234001

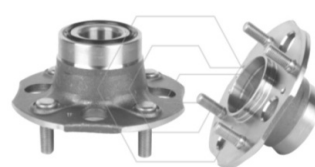

Hub Assemblies

Photo.....

GHA234002

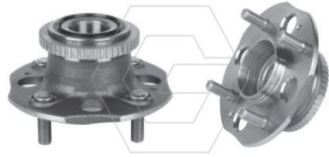

GHA234004K

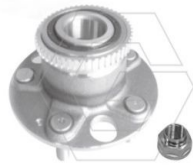

GHA234007

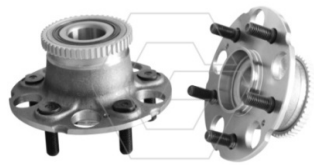

GHA234010



GHA234502



GHA235005K

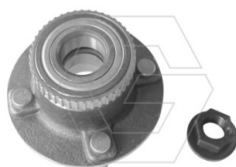

GHA234003K



GHA234005K

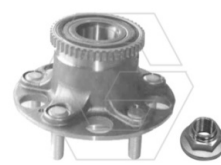

GHA234008K

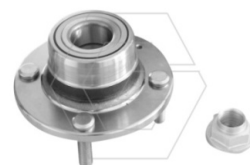

GHA234011



GHA235001K

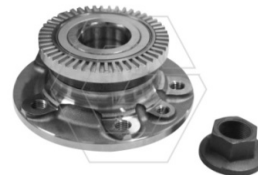

GHA235008K

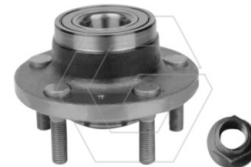

Hub Assemblies

Photo.....

GHA235009K



GHA235012K

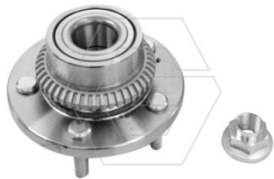

GHA235014K



GHA235018K

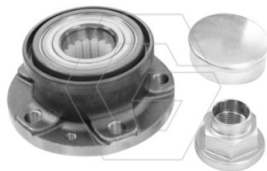

GHA235020K

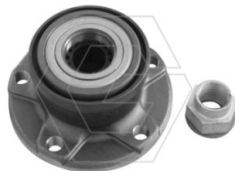

GHA235022K

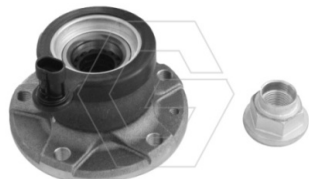

GHA235011K



GHA235013



GHA235015K

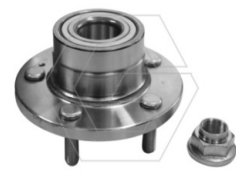

GHA235019K



GHA235021K

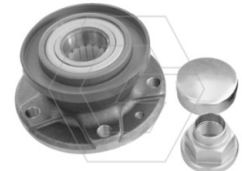

GHA235023K



Hub Assemblies

Photo.....

GHA235024K

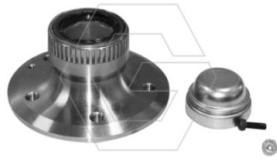

GHA236002K

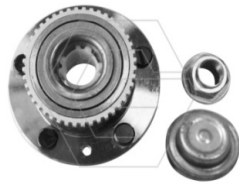

GHA237002K



GHA237004K

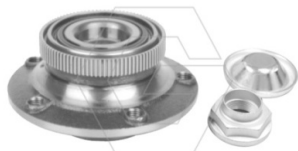

GHA237009K

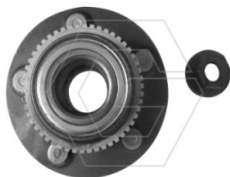

GHA237013

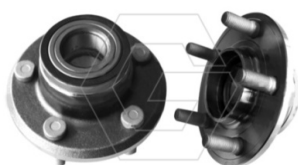

GHA236001



GHA237001K

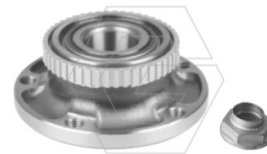

GHA237003K



GHA237006



GHA237010K

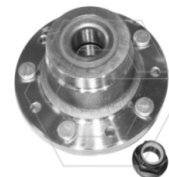

GHA237015K

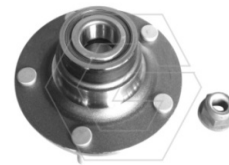

Hub Assemblies

Photo.....

GHA237016K



GHA237017K



GHA237018K

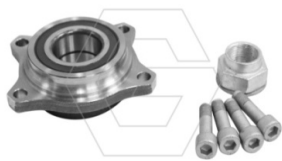

GHA237020

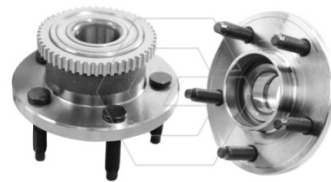

GHA238001K

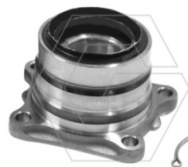

GHA238002

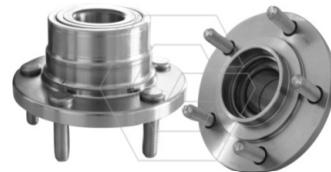

GHA239001

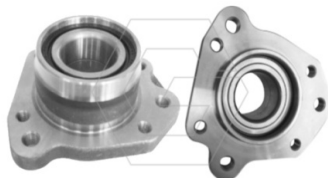

GHA239002

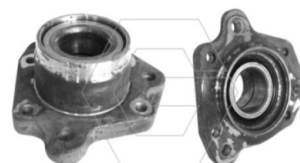

GHA239003

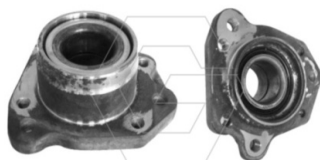

GHA239004



GHA240001K

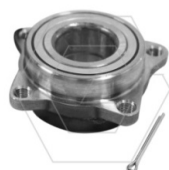

GHA240008K



Hub Assemblies

Photo.....

GHA240009

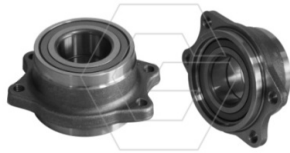

GHA241002



GHA241001

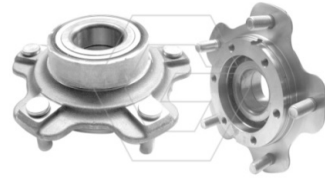

GHA242007K

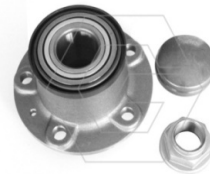

GHA242008K



GHA242009K



GHA242009S



GHA243001K

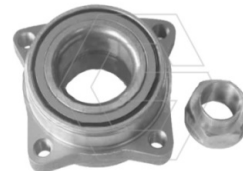

GHA243003K



GHA243004K

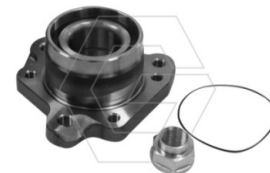

GHA243005

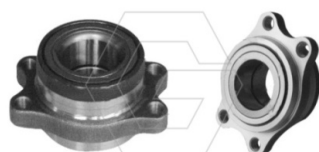

GHA243006K



Hub Assemblies

Photo.....

GHA243008 
GHA243011 
GHA244002 
GHA244004K 
GHA245001K 
GHA245007K 

GHA243009 
GHA244001 
GHA244003K 
GHA244005 
GHA245003 
GHA245007S 

Hub Assemblies

Photo.....

GHA245008K



GHA245010K



GHA245012K



GHA245015K



GHA245017



GHA245021



GHA245009K



GHA245011

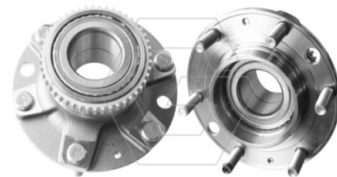

GHA245013

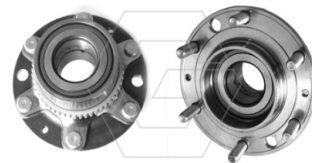

GHA245016K



GHA245019

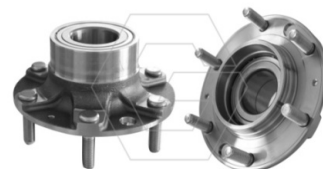

GHA245022K



Hub Assemblies

Photo.....

GHA247001K



GHA249001K

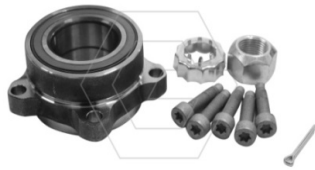

GHA249003

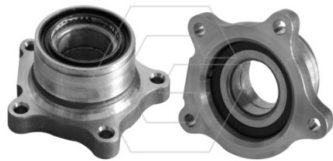

GHA249005K

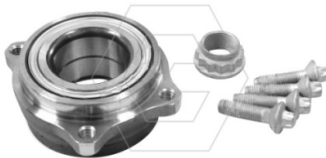

GHA250001



GHA250011



GHA248001

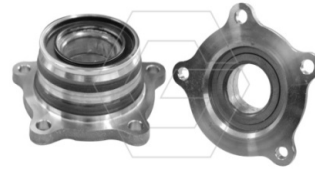

GHA249002K

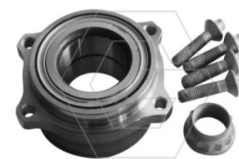

GHA249004



GHA249006K

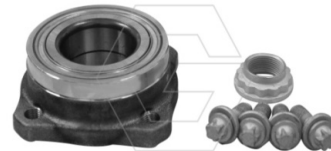

GHA250010



GHA251001



Hub Assemblies

Photo.....

GHA251002K

GHA251004

GHA254002K

GHA254004K

GHA258001

GHA262001K

GHA251003

GHA254001K

GHA254003K

GHA254901

GHA258002

GHA320001K



Hub Assemblies

Photo.....

GHA320002K

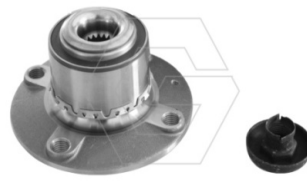

GHA320003K



GHA323002

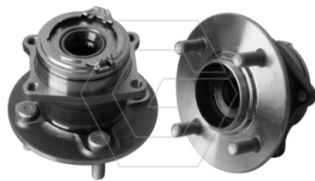

GHA324002K

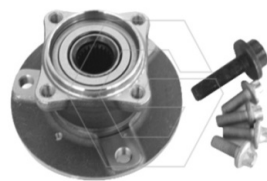

GHA324003

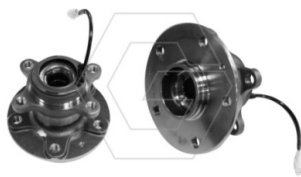

GHA324004K



GHA324005

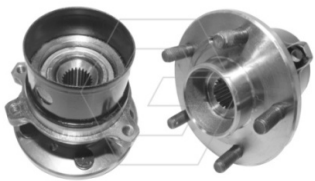

GHA324006

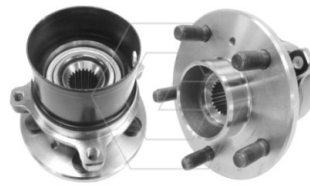

GHA324007

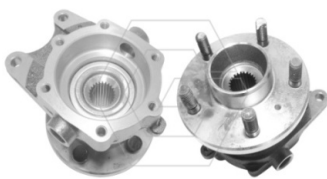

GHA324008

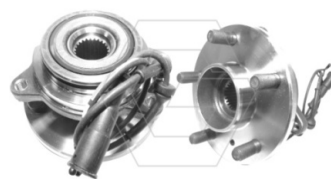

GHA324009



GHA325001



Hub Assemblies

Photo.....

GHA325003

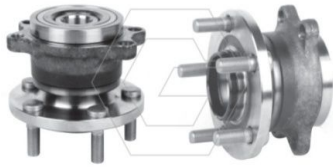

GHA325016K



GHA325019K



GHA325022K



GHA325025K



GHA325029

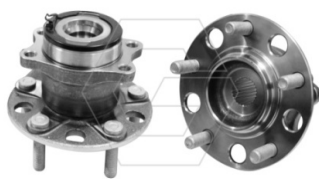

GHA325005



GHA325018K



GHA325020

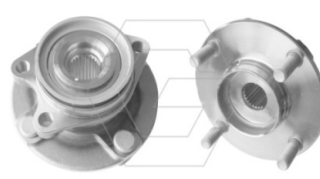

GHA325024

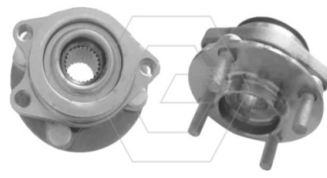

GHA325026K



GHA325030



Hub Assemblies

Photo.....

GHA326001



GHA326005K



GHA326008



GHA326011K



GHA326016

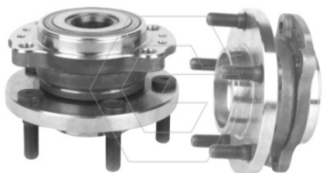

GHA326020K



GHA326004K



GHA326006

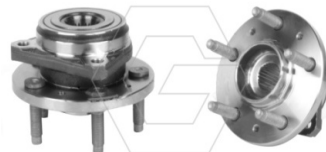

GHA326009

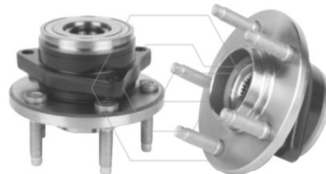

GHA326014K

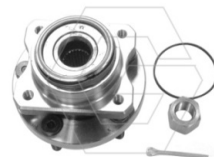

GHA326017K



GHA326024K

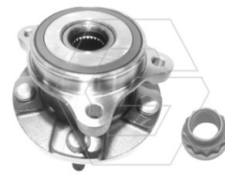

Hub Assemblies

Photo.....

GHA326026K

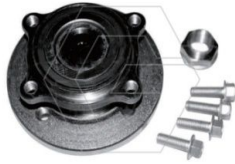

GHA326028K



GHA326031K

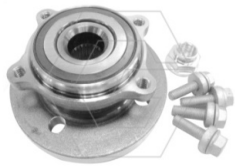

GHA326034



GHA326038K

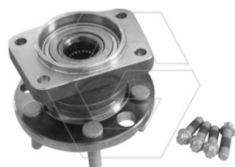

GHA326043

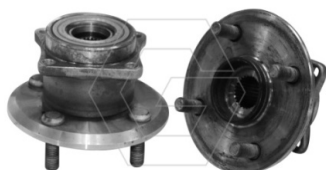

GHA326027K



GHA326030K



GHA326032K



GHA326036

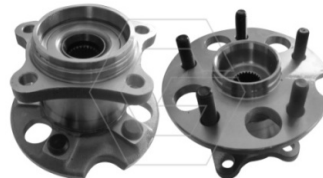

GHA326039

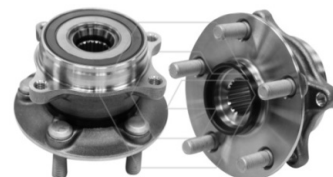

GHA326046

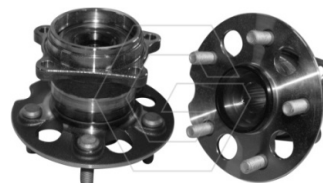

Hub Assemblies

Photo.....

GHA326047



GHA326053

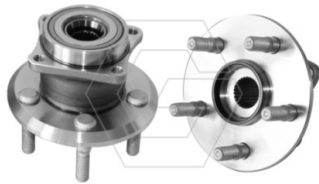

GHA326057



GHA327011



GHA327015K



GHA327017

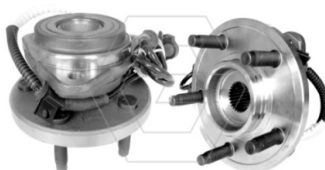

GHA326052

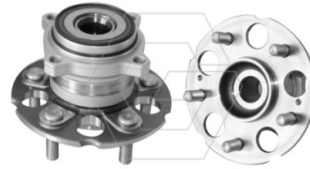

GHA326054K



GHA327010K



GHA327013



GHA327016



GHA327021

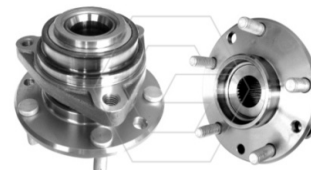

Hub Assemblies

Photo.....

GHA327022

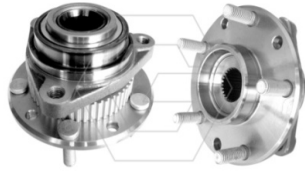

GHA327027



GHA327032

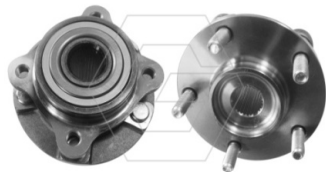

GHA327034



GHA327037

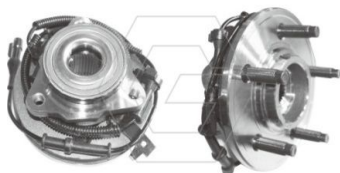

GHA327039K



GHA327023K



GHA327028

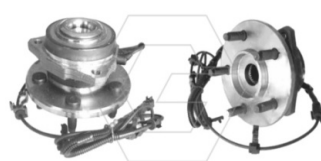

GHA327033



GHA327035

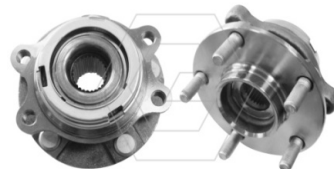

GHA327038K



GHA327040K



Hub Assemblies

Photo.....

GHA327043K



GHA327051

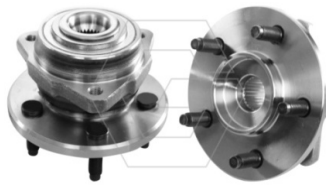

GHA327054

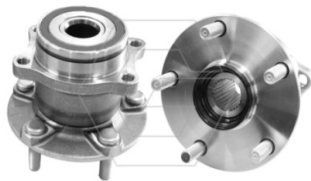

GHA327057



GHA328003K



GHA328006K



GHA327044K

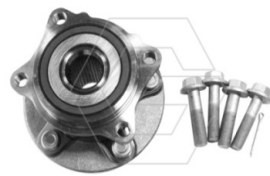

GHA327052

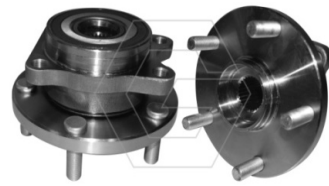

GHA327056

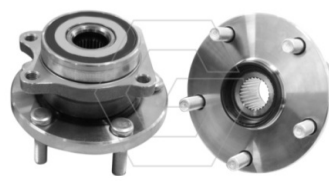

GHA328002K



GHA328005K



GHA328007K



Hub Assemblies

Photo.....

GHA328008

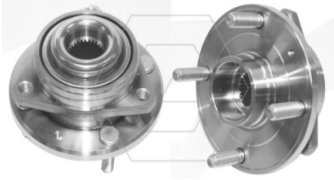

GHA328012

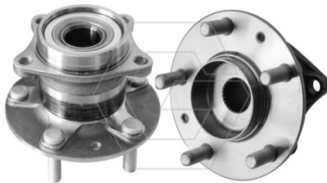

GHA328014

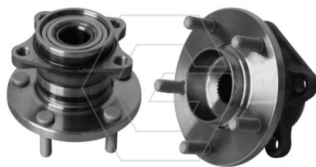

GHA329002K

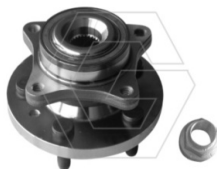

GHA329004K



GHA329006K



GHA328011K

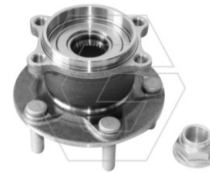

GHA328013



GHA329001K



GHA329003



GHA329005



GHA329007



Hub Assemblies

Photo.....

GHA329008K



GHA329010

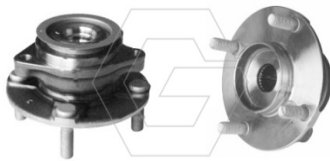

GHA329013

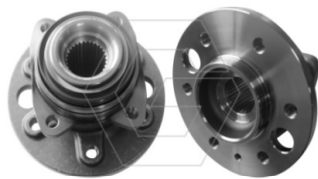

GHA329017



GHA329019

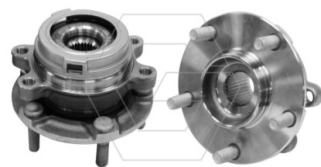

GHA329025



GHA329009

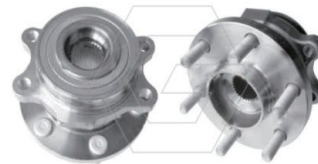

GHA329012K

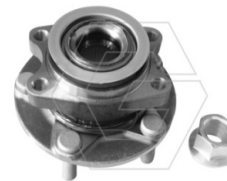

GHA329015K



GHA329018K

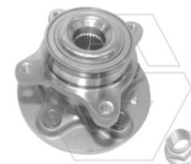

GHA329023



GHA330001K



Hub Assemblies

Photo.....

GHA330006K



GHA330008K



GHA330010K

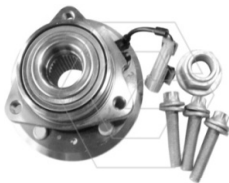

GHA330013K



GHA330017K

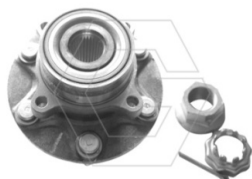

GHA330019K

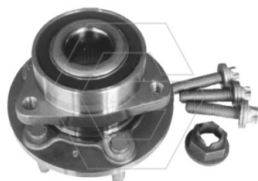

GHA330007



GHA330009



GHA330011K



GHA330014K



GHA330018K



GHA330020K



Hub Assemblies

Photo.....

GHA330021K

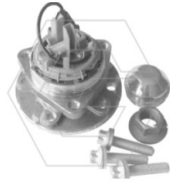

GHA330024K

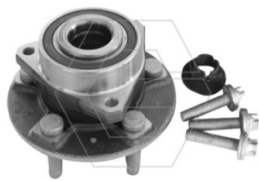

GHA330024S



GHA330026K

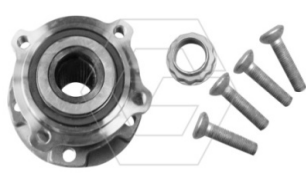

GHA330028



GHA330032

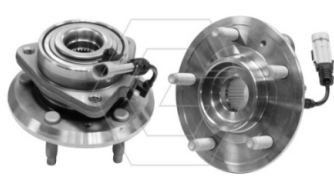

GHA330022F



GHA330024F



GHA330025K

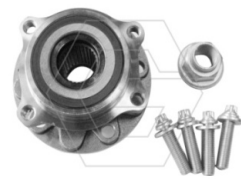

GHA330027

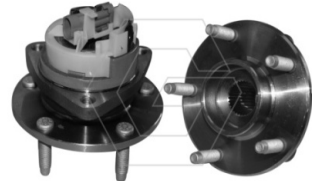

GHA330029

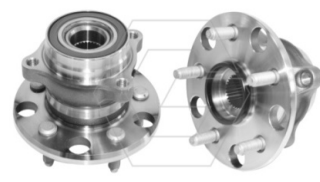

GHA330037

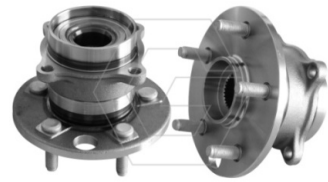

Hub Assemblies

Photo.....

GHA330038



GHA330045

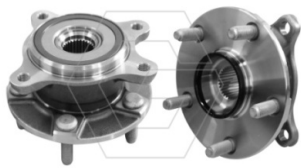

GHA330044

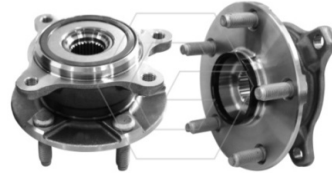

GHA330046

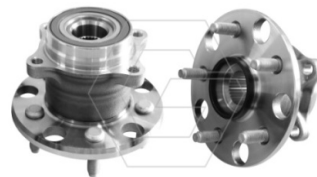

GHA330047

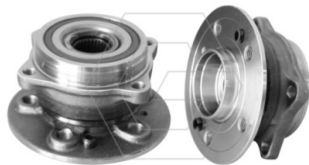

GHA330048K



GHA331001

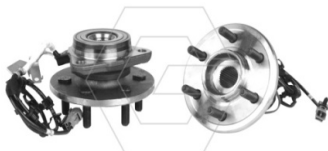

GHA331004



GHA331006K



GHA331007A

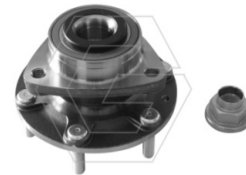

GHA331008

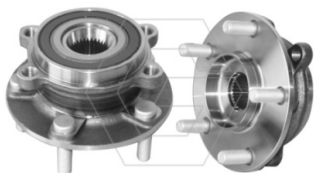

GHA332001K

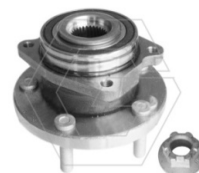

Hub Assemblies

Photo.....

GHA332002



GHA332006



GHA332009K

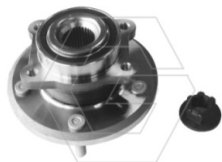

GHA332011

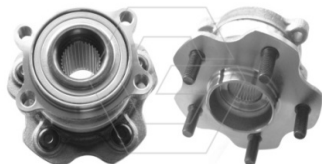

GHA332018



GHA332024

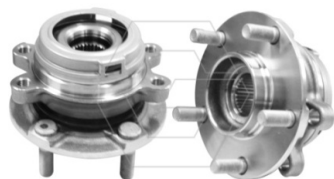

GHA332005K



GHA332008K



GHA332010K



GHA332014



GHA332020

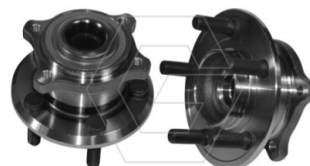

GHA333006

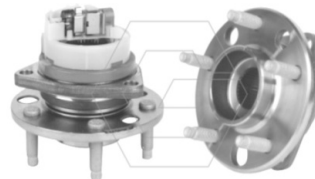

Hub Assemblies

Photo.....

GHA333012

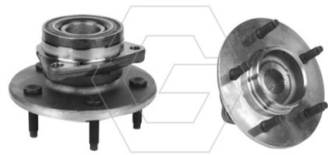

GHA333019



GHA333024K



GHA333029K



GHA333033k



GHA333038

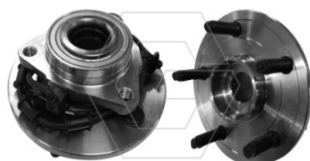

GHA333018



GHA333022

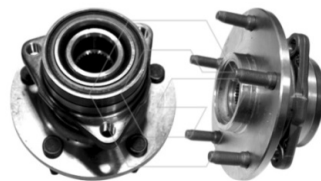

GHA333027

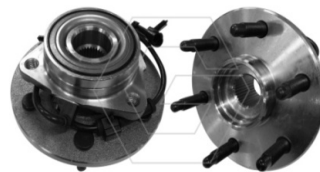

GHA333031

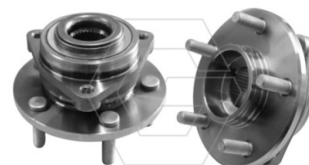

GHA333036K

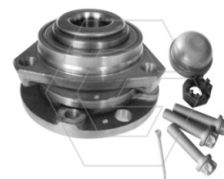

GHA333039

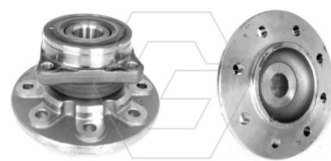

Hub Assemblies

Photo.....

GHA333041



GHA333047

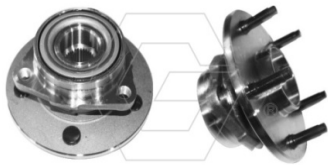

GHA333042

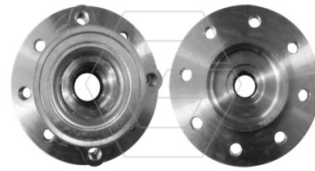

GHA333048

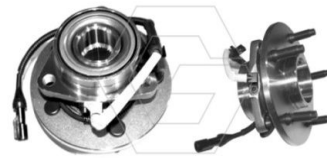

GHA333050

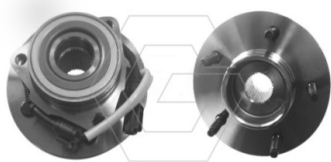

GHA333052K



GHA333058



GHA333059



GHA333060



GHA333061



GHA333062



GHA333068

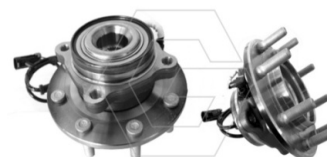

Hub Assemblies

Photo.....

GHA333069K



GHA333075



GHA333077

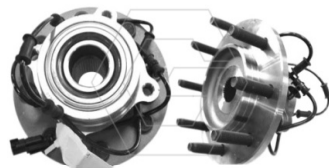

GHA333082

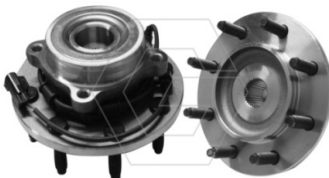

GHA333084

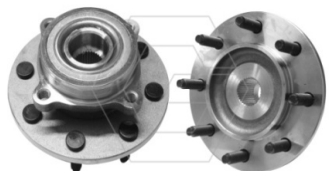

GHA333086



GHA333070K



GHA333076K



GHA333080K

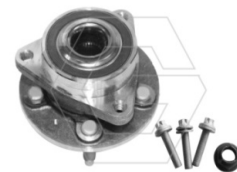

GHA333083K



GHA333085



GHA333090

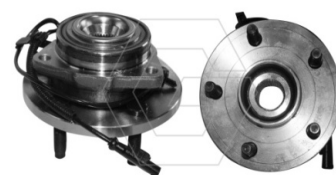

Hub Assemblies

Photo.....

GHA333091

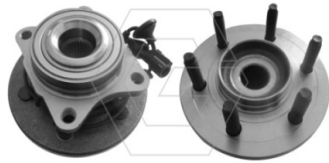

GHA333097K

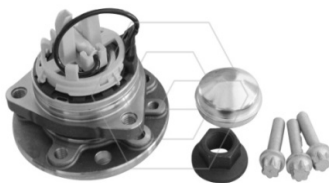

GHA333104



GHA333110

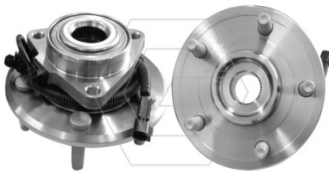

GHA336001K



GHA336003K



GHA333095



GHA333102K



GHA333107



GHA335001



GHA336002



GHA336004K

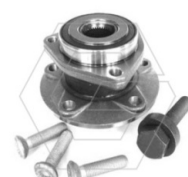

Hub Assemblies

Photo.....

GHA336005K



GHA336006S

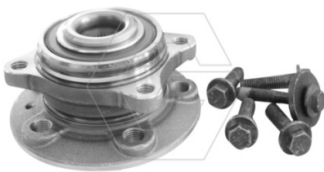

GHA336006K

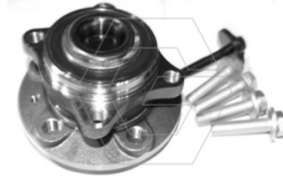

GHA336007K

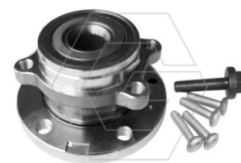

GHA336008

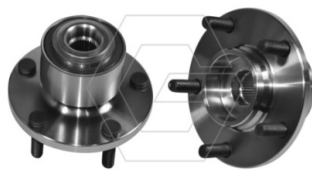

GHA336010K

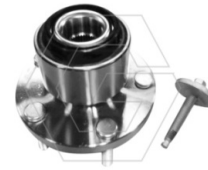

GHA336011K

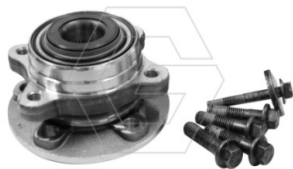

GHA336012K



GHA336013K

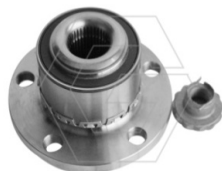

GHA336014K

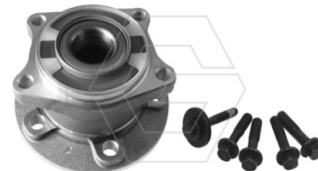

GHA336015K

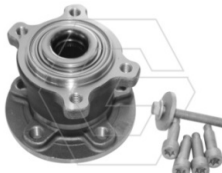

GHA336016K



Hub Assemblies

Photo.....

GHA336017K

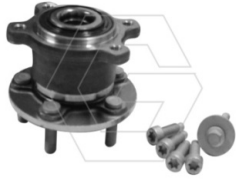

GHA340001K



GHA340004K

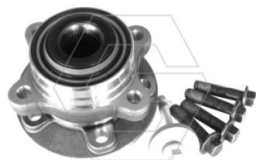

GHA342001



GHA400001K

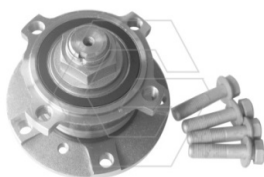

GHA400004

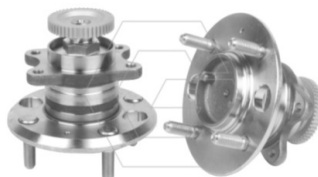

GHA338001K



GHA340003k



GHA340005K

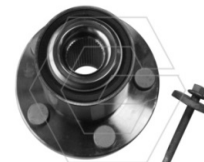

GHA355005K



GHA400003



GHA400007



Hub Assemblies

Photo.....

GHA400008

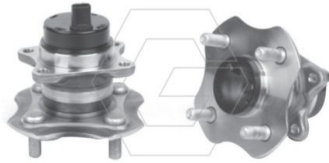

GHA400010

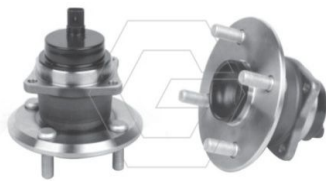

GHA400009



GHA400011

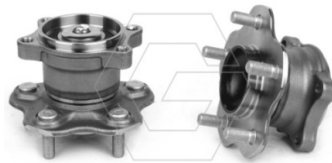

GHA400013

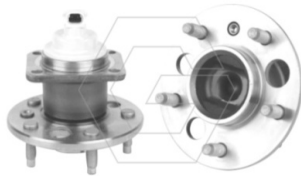

GHA400014



GHA400016

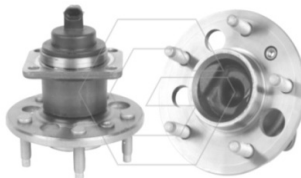

GHA400024



GHA400025

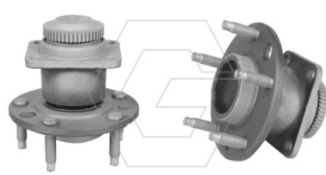

GHA400026

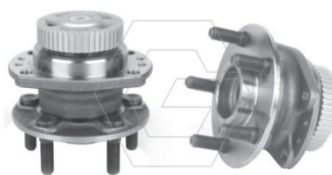

GHA400027



GHA400030

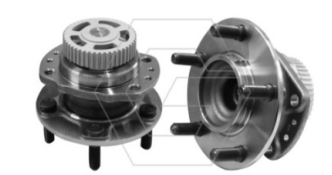

Hub Assemblies

Photo.....

GHA400047

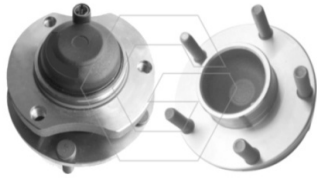

GHA400049

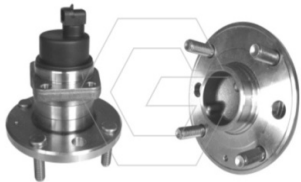

GHA400048



GHA400051K



GHA400052K



GHA400053K

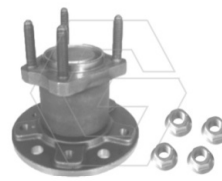

GHA400054

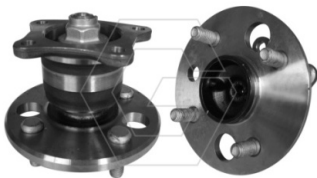

GHA400058K

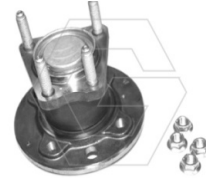

GHA400059

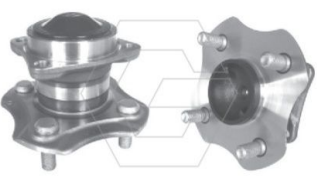

GHA400060

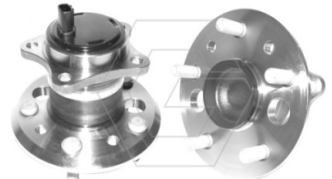

GHA400061

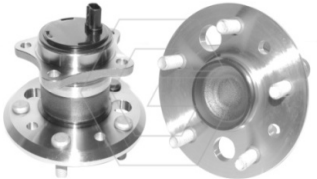

GHA400062

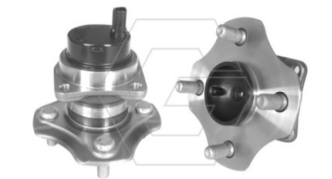

Hub Assemblies

Photo.....

GHA400064K

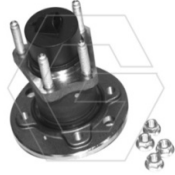

GHA400068

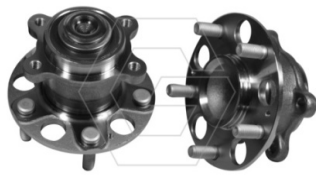

GHA400072K



GHA400077



GHA400081K

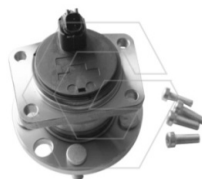

GHA400084K

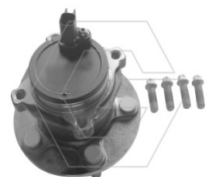

GHA400067

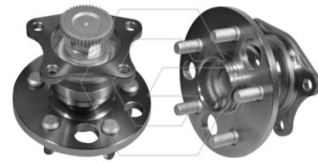

GHA400071

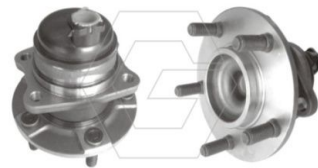

GHA400076

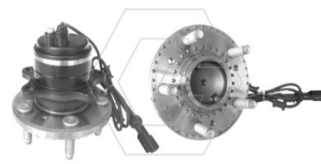

GHA400079



GHA400083

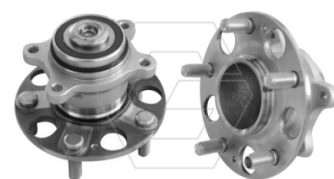

GHA400085



Hub Assemblies

Photo.....

GHA400086K

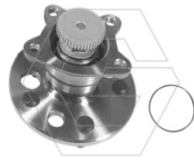

GHA400088

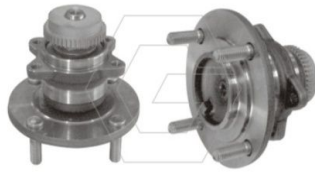

GHA400090



GHA400092

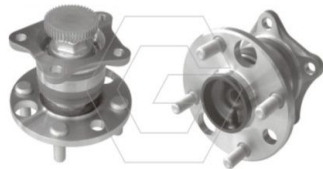

GHA400094

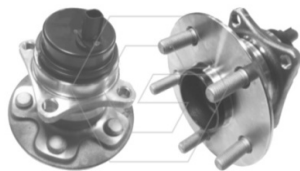

GHA400096

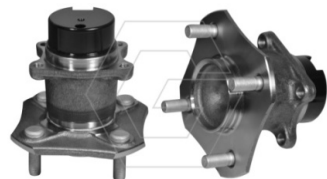

GHA400087K



GHA400089

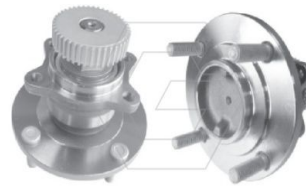

GHA400091K



GHA400093

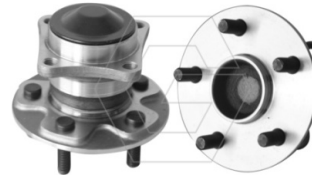

GHA400095

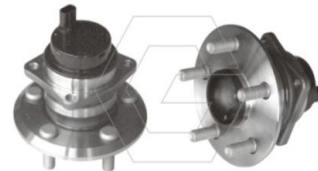

GHA400098

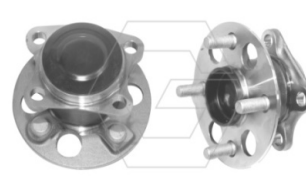

Hub Assemblies

Photo.....

GHA400115



GHA400116

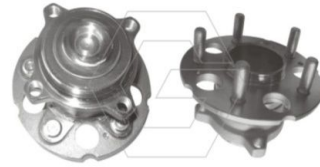

GHA400118K

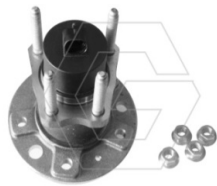

GHA400121

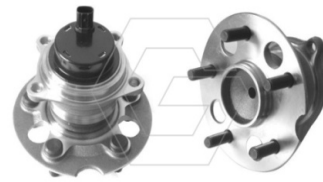

GHA400127

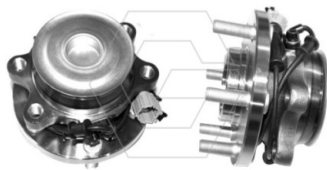

GHA400129K



GHA400130K

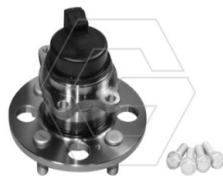

GHA400131

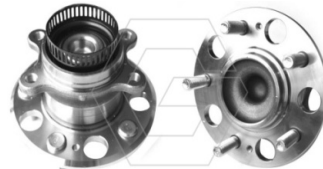

GHA400133K

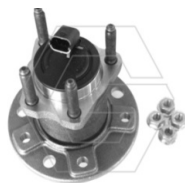

GHA400134K

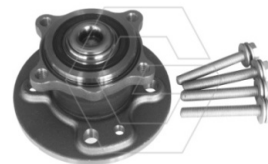

GHA400134F

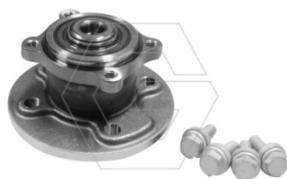

GHA400135K

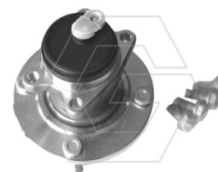

Hub Assemblies

Photo.....

GHA400136K



GHA400140



GHA400144



GHA400151

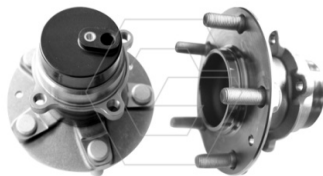

GHA400153K

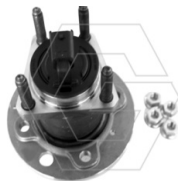

GHA400155



GHA400137K

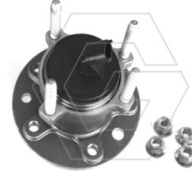

GHA400141

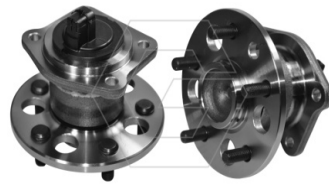

GHA400149

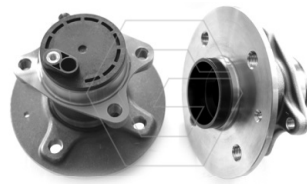

GHA400152

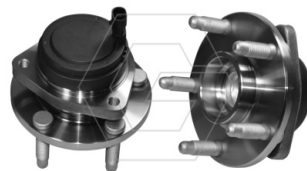

GHA400154k

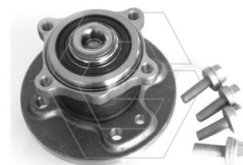

GHA400156

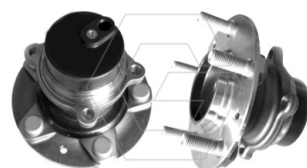

Hub Assemblies

Photo.....

GHA400157

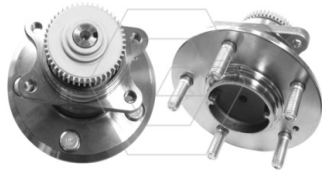

GHA400159

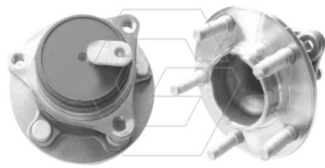

GHA400161

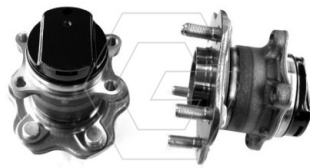

GHA400165

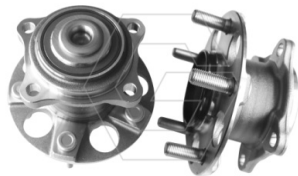

GHA400167K

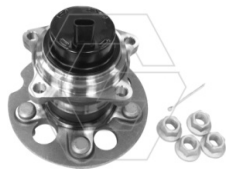

GHA400169K



GHA400158K



GHA400160

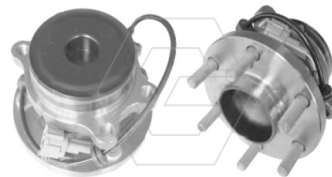

GHA400164K



GHA400166

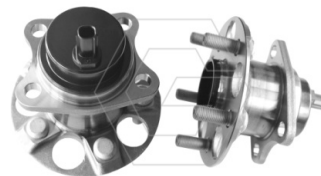

GHA400168

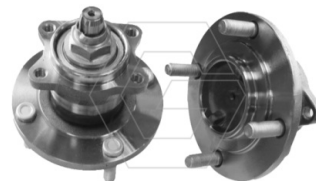

GHA400170K



Hub Assemblies

Photo.....

GHA400171K

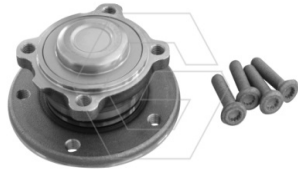

GHA400171S

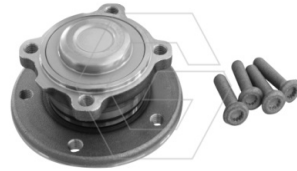

GHA400172

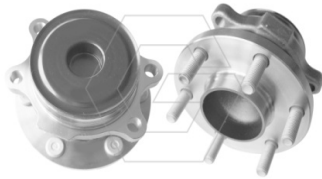

GHA400173

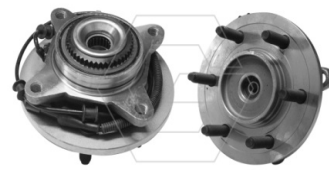

GHA400174K

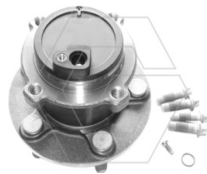

GHA400175



GHA400176K

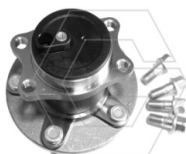

GHA400177

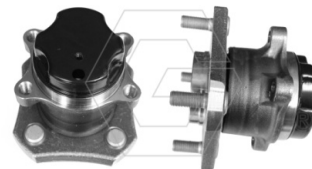

GHA400178

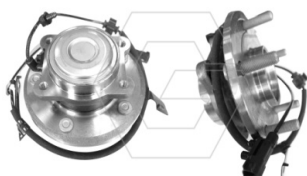

GHA400179

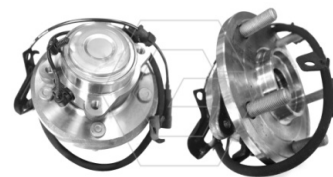

GHA400180

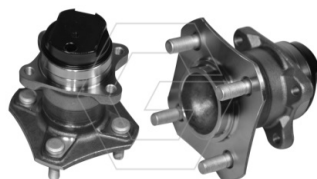

GHA400181

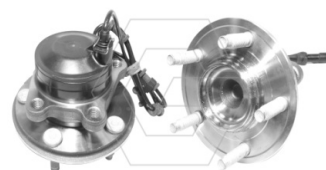

Hub Assemblies

Photo.....

GHA400182K

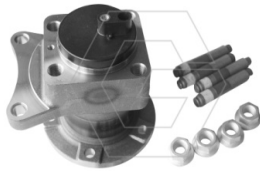

GHA400184

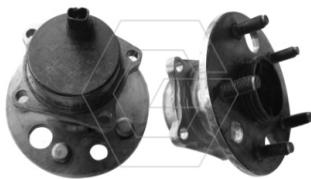

GHA400188K



GHA400191

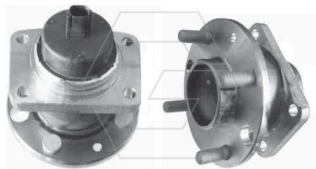

GHA400193K

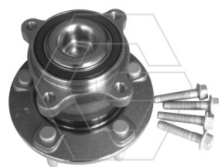

GHA400196K

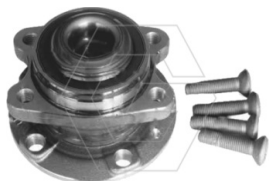

GHA400183

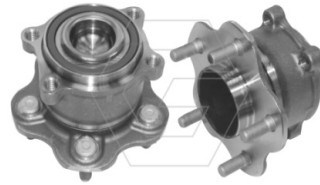

GHA400187

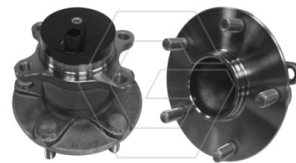

GHA400190



GHA400192

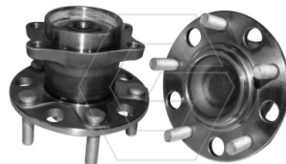

GHA400194

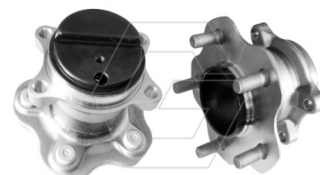

GHA400197K

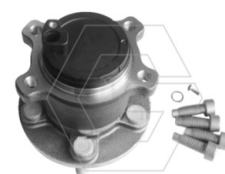

Hub Assemblies

Photo.....

GHA400198

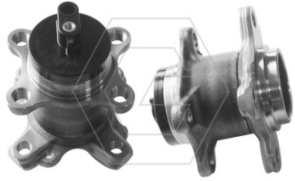

GHA400199

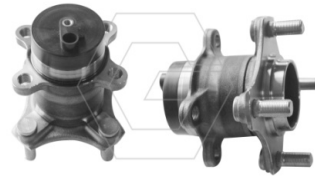

GHA400203



GHA400206K

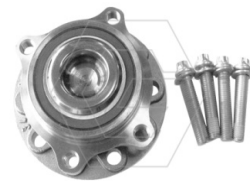

GHA400207K

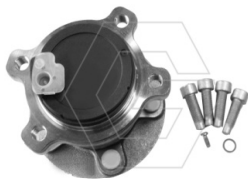

GHA400208

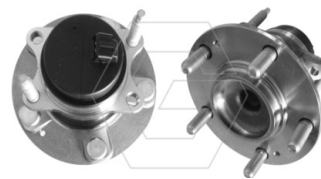

GHA400210

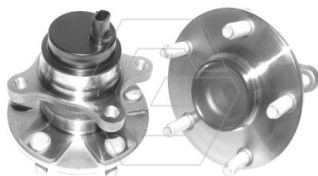

GHA400211

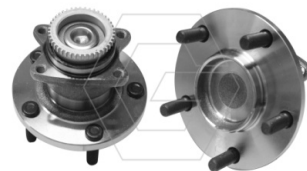

GHA400216

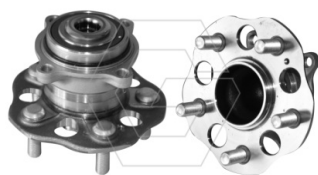

GHA400218



GHA400224

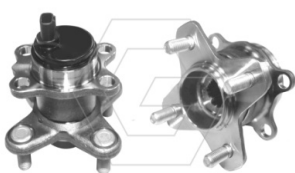

GHA400230

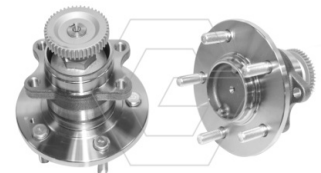

Hub Assemblies

Photo.....

GHA400231

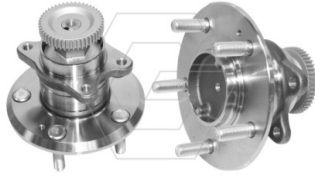

GHA400233

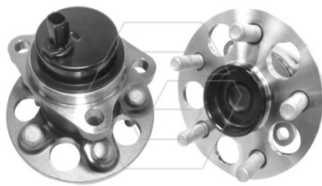

GHA400236

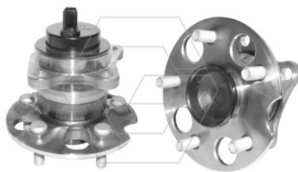

GHA400238

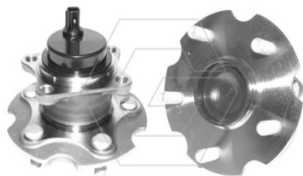

GHA400240K



GHA400242



GHA400232

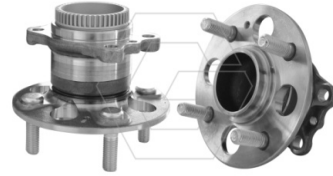

GHA400234

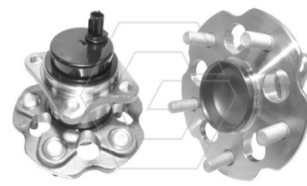

GHA400237

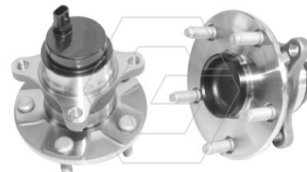

GHA400239

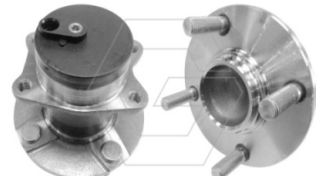

GHA400241



GHA400247

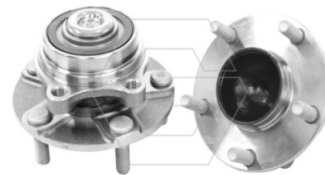

Hub Assemblies

Photo.....

GHA400248K

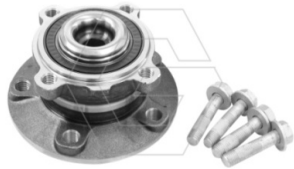

GHA400254

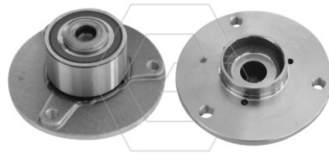

GHA400257

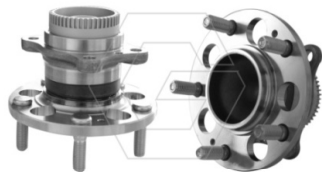

GHA400259

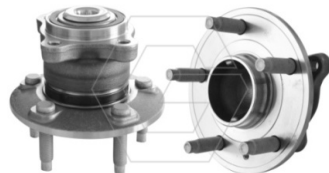

GHA400261

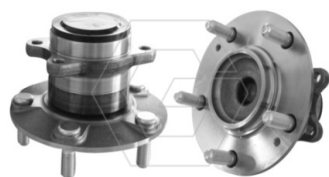

GHA400263

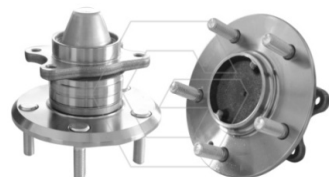

GHA400253K

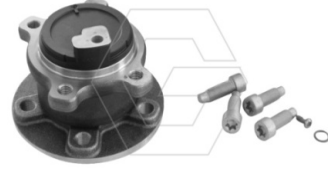

GHA400256

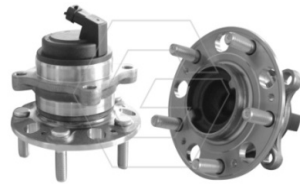

GHA400258

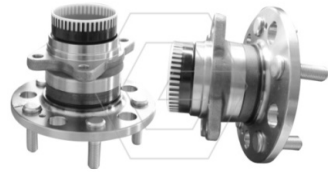

GHA400260



GHA400262

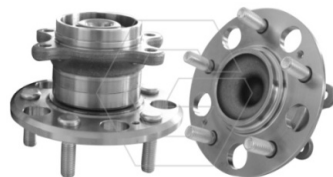

GHA400264



Hub Assemblies

Photo.....

GHA400265 
GHA400269 
GHA400275 
GHA400279 
GHA400282 
GHA400286 

GHA400268K 
GHA400274 
GHA400276 
GHA400281 
GHA400285K 
GHA400292 

Hub Assemblies

Photo.....

GHA400295

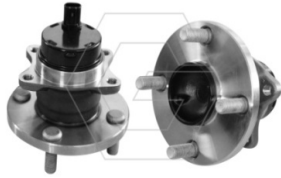

GHA400310

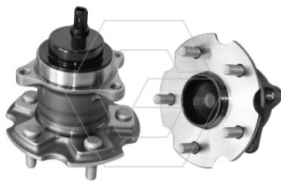

GHA400314K



GHA400326



GHA400336K



GHA400338K

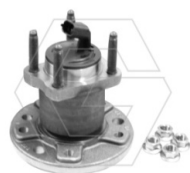

GHA400309

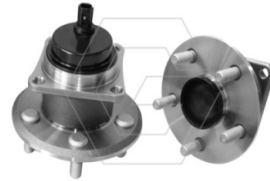

GHA400313



GHA400321



GHA400335K

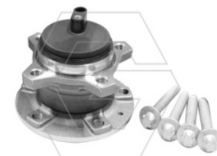

GHA400337K



GHA400340

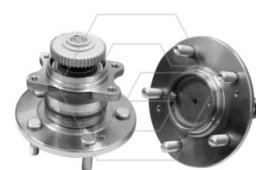

Hub Assemblies

Photo.....

GHA400343

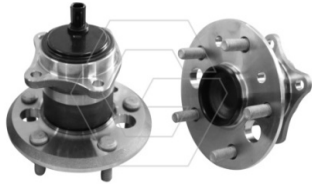

GHA400350

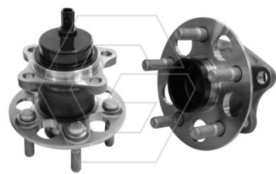

GHA400353K



GHA400356

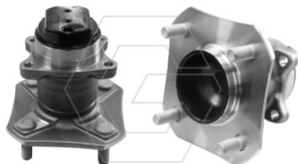

GHA400360



GHA421001

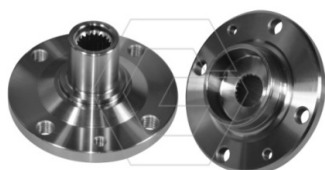

GHA400344

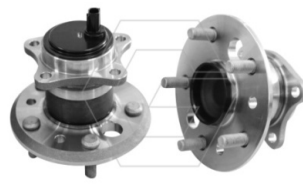

GHA400351



GHA400354K



GHA400359



GHA420004

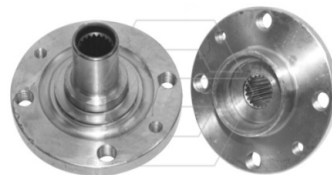

GHA421003

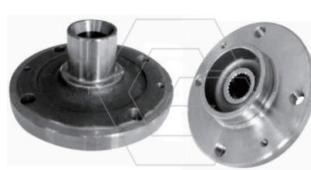

Hub Assemblies

Photo.....

GHA421004A 
GHA422001 
GHA422006K 
GHA422008A 
GHA422010 
GHA422014 

GHA421012 
GHA422004 
GHA422007 
GHA422009K 
GHA422012K 
GHA422015 

Hub Assemblies

Photo.....

GHA422018

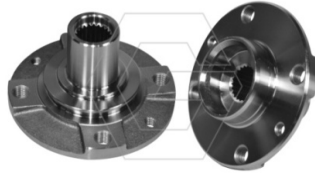

GHA422023

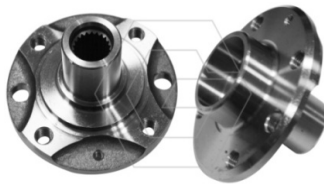

GHA422022

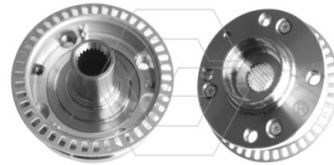

GHA422026

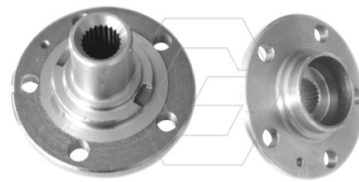

GHA422027K

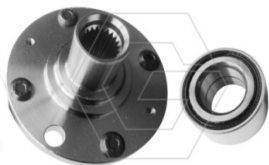

GHA422029



GHA422036K

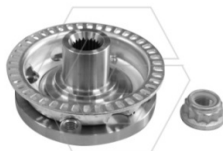

GHA423001



GHA423002



GHA423003K



GHA423007

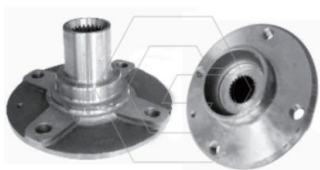

GHA423010



Hub Assemblies

Photo.....

GHA423016



GHA423018

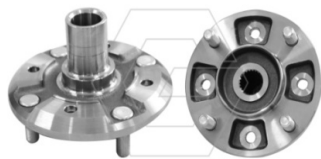

GHA423017

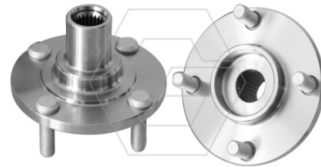

GHA424010



GHA424015

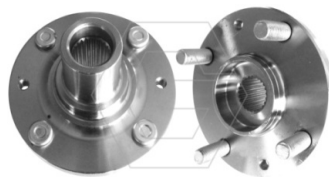

GHA424016K

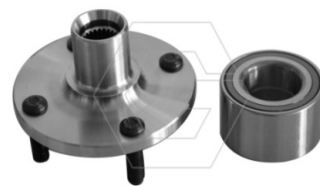

GHA424019

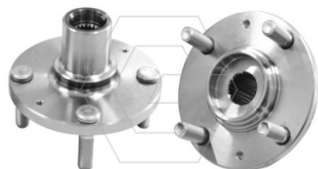

GHA425001



GHA425002

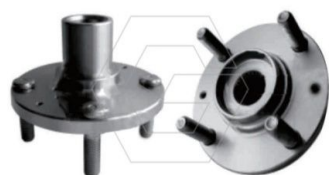

GHA425004K



GHA425008

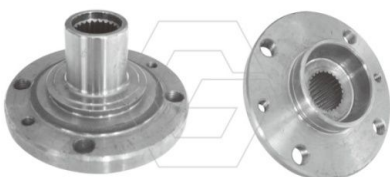

GHA425009



Hub Assemblies

Photo.....

GHA425017 
GHA425022 
GHA425028 
GHA425041K 
GHA425045 
GHA425048 

GHA425018K 
GHA425027 
GHA425036 
GHA425044 
GHA425047 
GHA425049 

Hub Assemblies

Photo.....

GHA425051

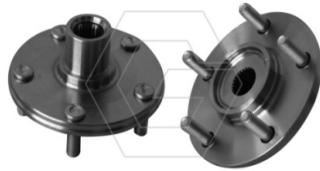

GHA426009K



GHA426021

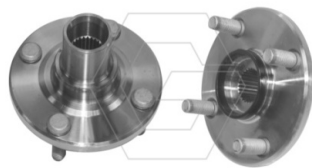

GHA426023K



GHA426026

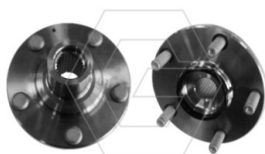

GHA426030K

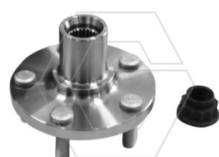

GHA425052



GHA426015K



GHA426022

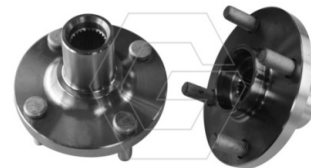

GHA426024

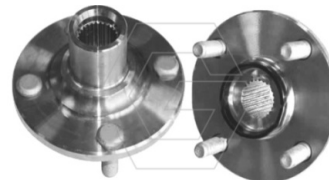

GHA426028K



GHA426041

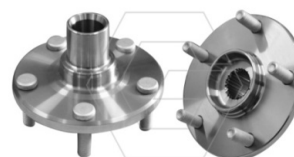

Hub Assemblies

Photo.....

GHA426048K

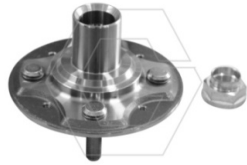

GHA426052



GHA427003



GHA427005

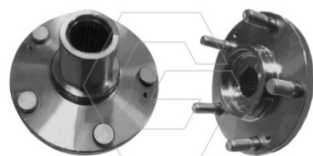

GHA427008



GHA427011



GHA426049K

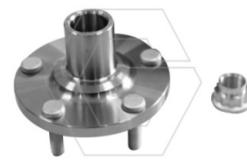

GHA427002



GHA427004

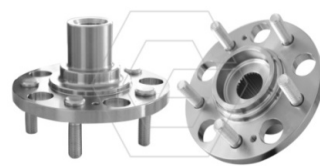

GHA427006



GHA427010



GHA427017

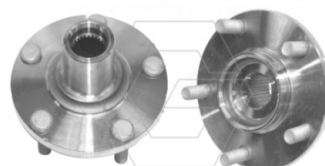

Hub Assemblies

Photo.....

GHA427019

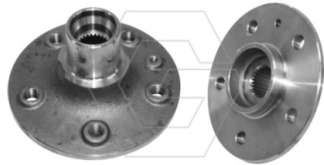

GHA427021



GHA427023

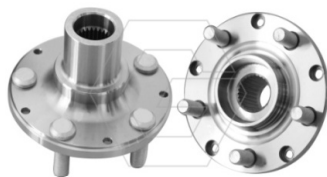

GHA428001



GHA428005K

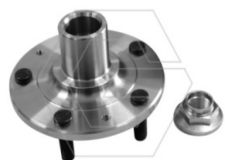

GHA428011K

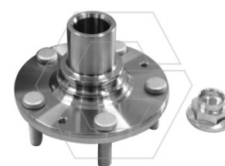

GHA427020

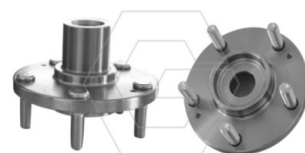

GHA427022

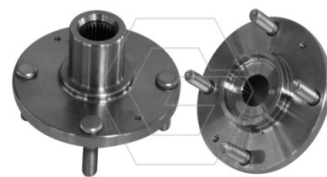

GHA427024

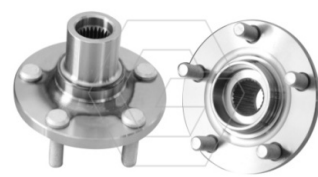

GHA428004



GHA428006

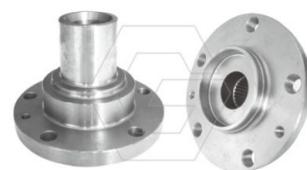

GHA428015K

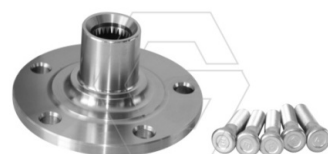

Hub Assemblies

Photo.....

GHA428016

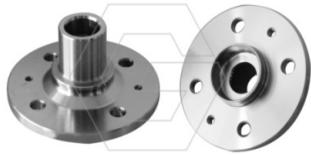

GHA429001K



GHA429003

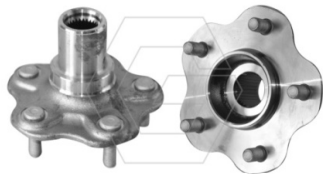

GHA428026

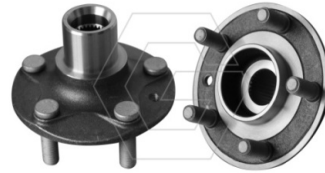

GHA429002K

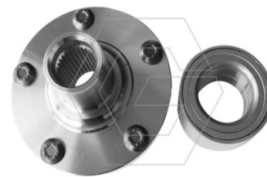

GHA429006

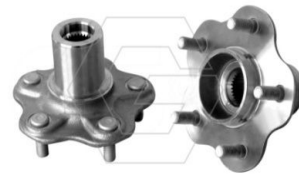

GHA430001K



GHA430002

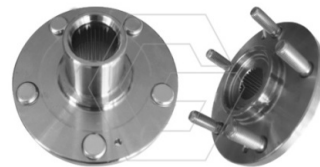

GHA430005K

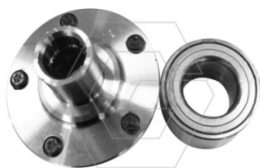

GHA430007

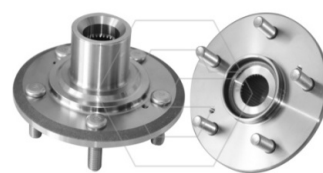

GHA430008



GHA431002

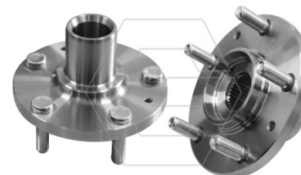

Hub Assemblies

Photo.....

GHA431005

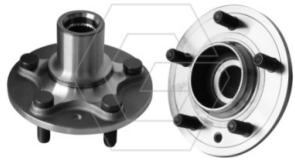

GHA433002



GHA433001



GHA433004



GHA433007



GHA433010



GHA433013

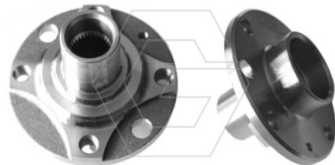

GHA433019

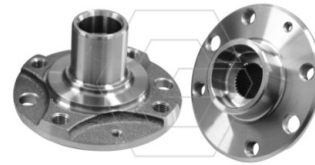

GHA435001

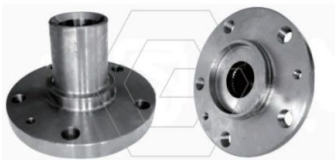

GHA435002

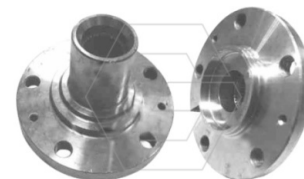

GHA436001



GHA436002K



Hub Assemblies

Photo.....



Hub Assemblies

Photo.....



Brake Disc

Photo.....

GHA225018K

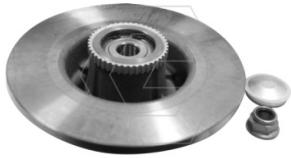

GHA225038K



GHA225040K

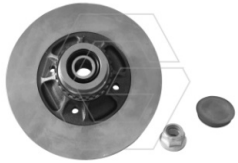

GHA225042K

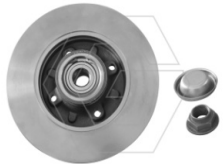

GHA230138K

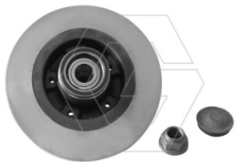

GHA230141K

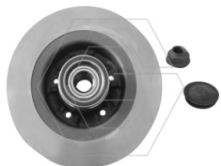

GHA225019K

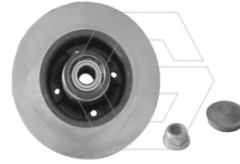

GHA225039K

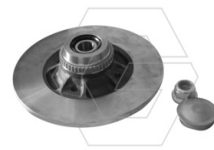

GHA225041K

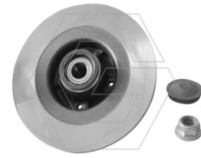

GHA230137K



GHA230140K

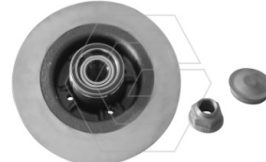



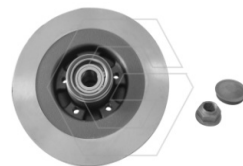

GHA230142K

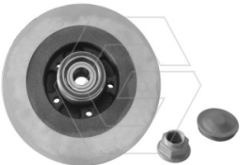

Brake Disc

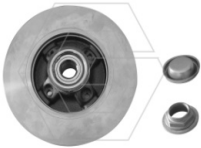
Photo.....

GHA230143K

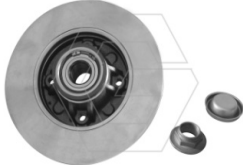
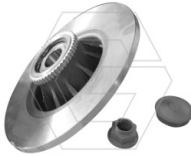
GHA230145K

GHA230148K

GHA230144K

GHA230146K

GHA235025K

Bearing Kits

Photo.....

GWB0001



GWB0523



GWB0528



GWB0534



GWB0542



GWB0577



GWB0504



GWB0526



GWB0529



GWB0540



GWB0575



GWB0593



Bearing Kits

Photo.....

GWB0596

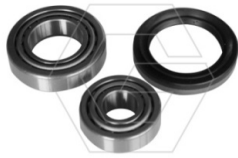

GWB0652



GWB0687



GWB0739



GWB0741



GWB0754

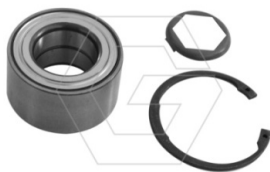

GWB0613A



GWB0663

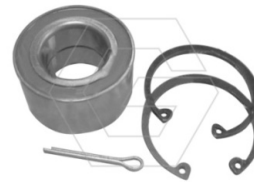

GWB0736

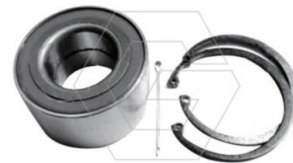

GWB0740



GWB0749



GWB0756



Bearing Kits

Photo.....

GWB0757



GWB0826



GWB0828



GWB0882

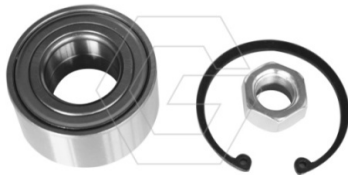

GWB0898



GWB0906



GWB0802

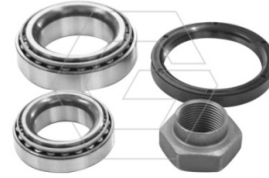

GWB0827



GWB0841



GWB0897



GWB0904



GWB0909



Bearing Kits

Photo.....

GWB0910



GWB0915



GWB0919



GWB0927



GWB0941



GWB0947



GWB0911



GWB0918



GWB0926



GWB0928



GWB0944



GWB0949



Bearing Kits

Photo.....

GWB0961 
GWB0969 
GWB0976 
GWB1314 
GWB1320 
GWB1326 

GWB0962 
GWB0975 
GWB1306 
GWB1317 
GWB1324 
GWB1327 

Bearing Kits

Photo.....

GWB1333



GWB1342



GWB1345



GWB1349

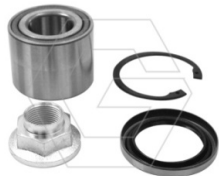

GWB1353

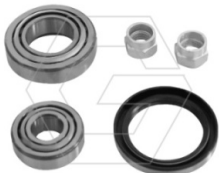

GWB1356



GWB1340



GWB1344



GWB1347



GWB1352



GWB1355



GWB1358



Bearing Kits

Photo.....

GWB1362



GWB1365



GWB1367

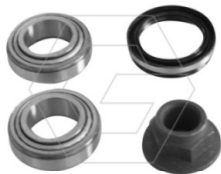

GWB1370



GWB1383



GWB1397



GWB1363

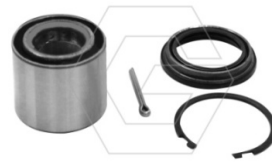

GWB1366



GWB1369



GWB1374



GWB1393

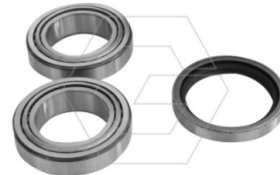

GWB1401

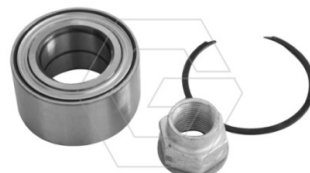

Bearing Kits

Photo.....

GWB1410

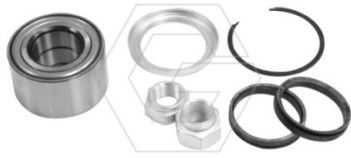

GWB1430

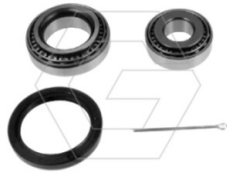

GWB1432



GWB1438

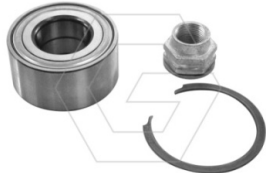

GWB1444



GWB1455



GWB1412



GWB1431

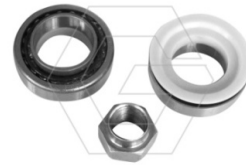

GWB1433



GWB1439



GWB1445



GWB1459

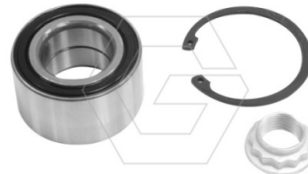

Bearing Kits

Photo.....

GWB1465



GWB1467

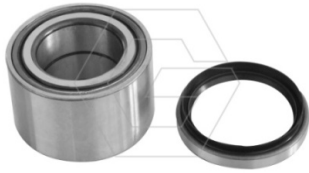

GWB1473



GWB1488



GWB1495



GWB1499



GWB1466



GWB1470



GWB1480



GWB1491



GWB1498



GWB1905

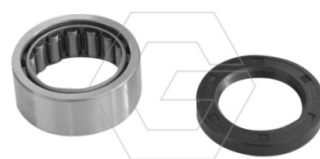

Bearing Kits

Photo.....

GWB1909



GWB1915



GWB1930



GWB1948



GWB1951



GWB1961

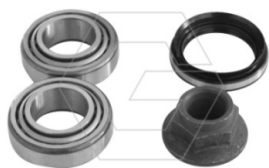

GWB1911



GWB1928



GWB1931

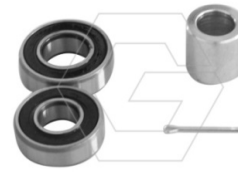

GWB1950



GWB1956



GWB1962

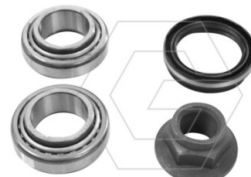

Bearing Kits

Photo.....

GWB1970



GWB1973



GWB3201



GWB3206



GWB3219



GWB3221



GWB1971



GWB1999



GWB3205



GWB3217



GWB3220

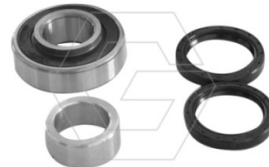

GWB3224



Bearing Kits

Photo.....

GWB3235



GWB3237



GWB3246

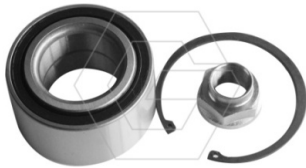

GWB3256



GWB3272

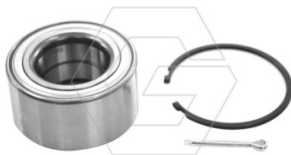

GWB3309



GWB3236



GWB3245



GWB3255



GWB3257

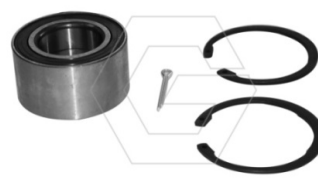

GWB3308



GWB3319

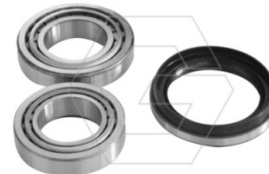

Bearing Kits

Photo.....

GWB3325



GWB3332



GWB3403



GWB3405



GWB3412



GWB3414

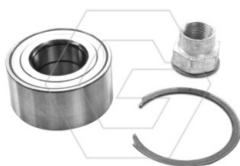

GWB3331

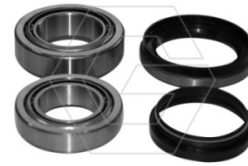

GWB3400



GWB3404



GWB3410



GWB3413

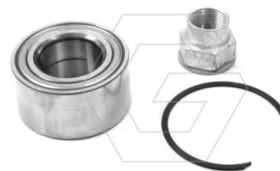

GWB3416

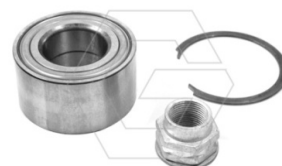

Bearing Kits

Photo.....

GWB3417



GWB3421



GWB3427



GWB3429



GWB3434



GWB3441

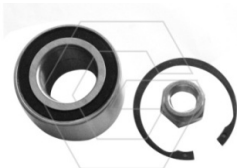

GWB3420

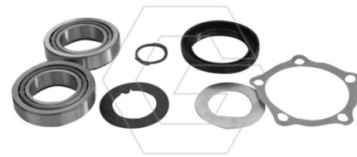

GWB3423



GWB3428



GWB3430



GWB3435



GWB3443



Bearing Kits

Photo.....

GWB3446



GWB3450



GWB3475



GWB3486



GWB3492

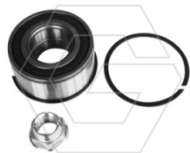

GWB3496



GWB3449



GWB3455



GWB3485



GWB3490



GWB3495



GWB3499

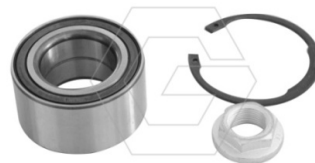

Bearing Kits

Photo.....

GWB3500



GWB3504

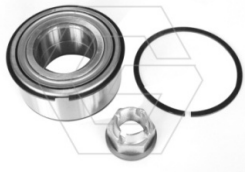

GWB3519



GWB3521



GWB3525



GWB3528



GWB3501



GWB3518



GWB3520



GWB3522

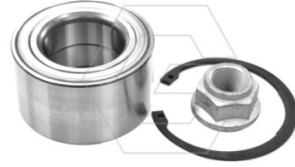

GWB3527

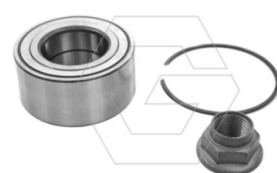

GWB3530



Bearing Kits

Photo.....

GWB3531



GWB3535

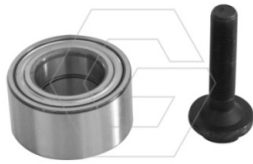

GWB3532



GWB3538



GWB3539



GWB3543



GWB3551



GWB3552

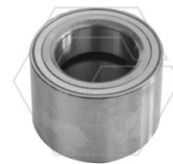

GWB3554A



GWB3556



GWB3565



GWB3571



Bearing Kits

Photo.....

GWB3572



GWB3575

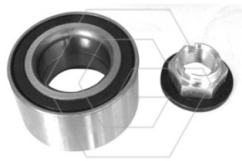

GWB3581



GWB3596



GWB3599

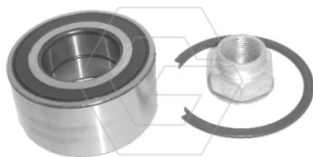

GWB3603

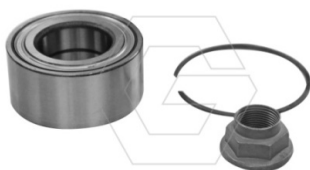

GWB3574

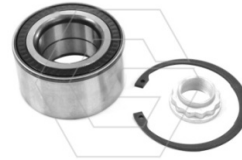

GWB3577

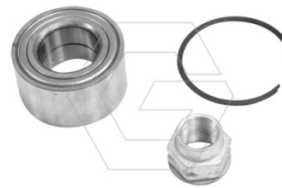

GWB3584

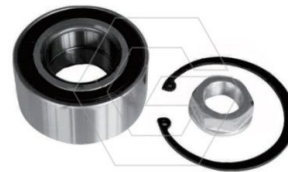

GWB3598



GWB3601



GWB3605

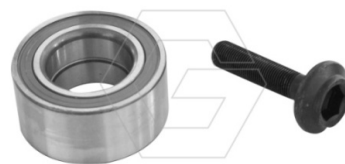

Bearing Kits

Photo.....

GWB3607



GWB3608

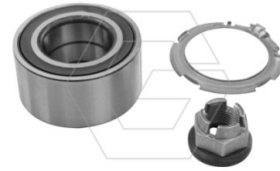

GWB3613

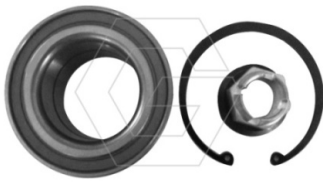

GWB3614

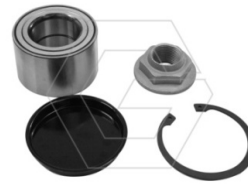

GWB3615

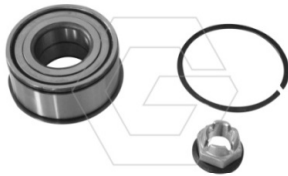

GWB3616

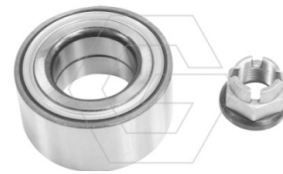

GWB3617

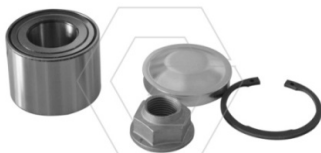

GWB3618

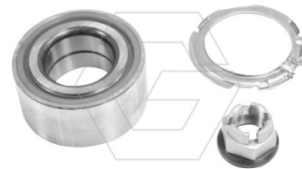

GWB3625



GWB3628



GWB3633

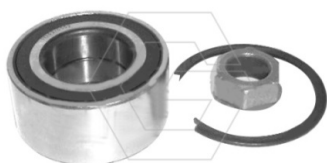

GWB3637



Bearing Kits

Photo.....

GWB3638



GWB3640



GWB3642



GWB3647



GWB3649



GWB3658



GWB3639



GWB3641



GWB3645

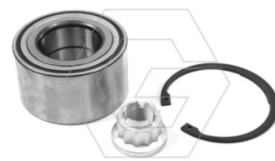

GWB3648

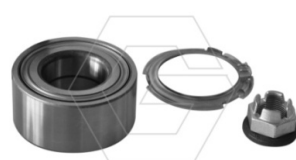

GWB3657



GWB3664

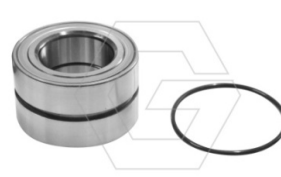

Bearing Kits

Photo.....

GWB3666



GWB3676



GWB3679



GWB3682



GWB3684



GWB3689



GWB3668

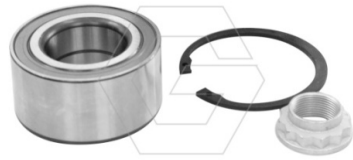

GWB3678



GWB3680

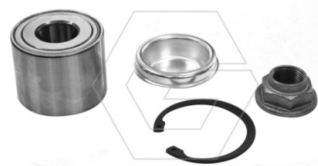

GWB3683

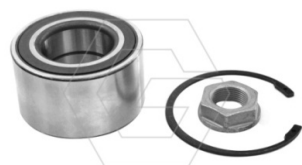

GWB3688



GWB3690



Bearing Kits

Photo.....

GWB3692

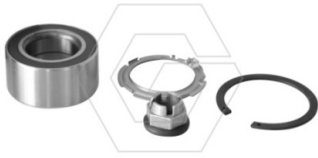

GWB3713



GWB3717

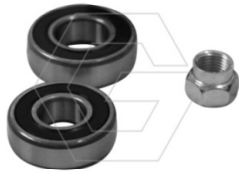

GWB3703



GWB3716

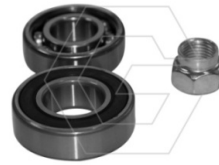

GWB3718



GWB3727



GWB3729



GWB3730



GWB3740



GWB3765



GWB3775

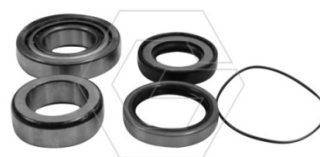

Bearing Kits

Photo.....

GWB3785 
GWB3796 
GWB3901 
GWB3906 
GWB3909 
GWB3917 

GWB3786 
GWB3797 
GWB3902 
GWB3907 
GWB3916 
GWB3922 

Bearing Kits

Photo.....

GWB3929



GWB3940

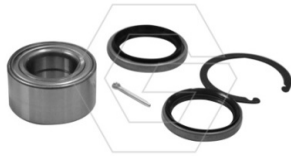

GWB3946



GWB3950



GWB3959



GWB3965



GWB3936



GWB3945



GWB3949



GWB3951

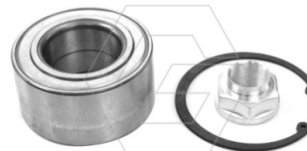

GWB3961



GWB3966

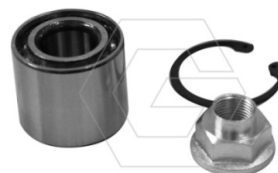

Bearing Kits

Photo.....

GWB3967



GWB3970



GWB3979

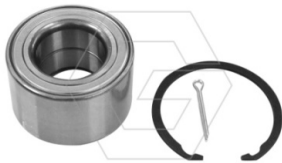

GWB3985

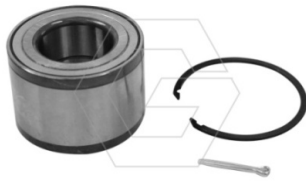

GWB3997



GWB6502

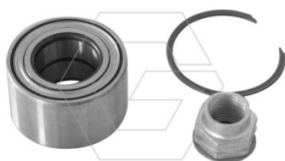

GWB3968

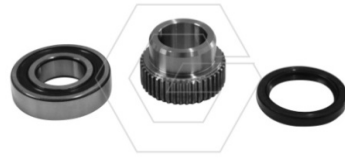

GWB3974



GWB3981



GWB3991



GWB5549



GWB6508



Bearing Kits

Photo.....

GWB6509



GWB6520

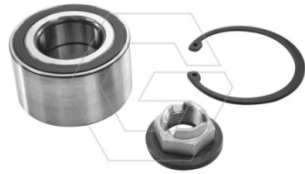

GWB6537



GWB6544



GWB6550

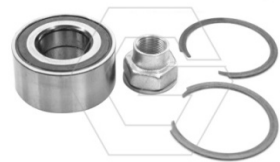

GWB6561



GWB6515



GWB6530



GWB6540



GWB6549



GWB6559



GWB6570



Bearing Kits

Photo.....

GWB6575



GWB6578



GWB6590

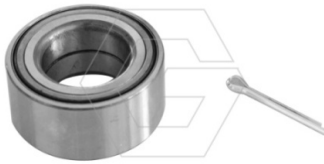

GWB6591

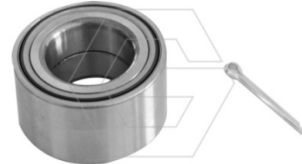

GWB6632



GWB6636

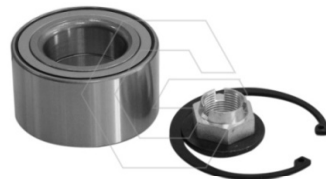

GWB6639



GWB6640



GWB6642



GWB6643



GWB6646



GWB6647



Bearing Kits

Photo.....

GWB6653



GWB6686

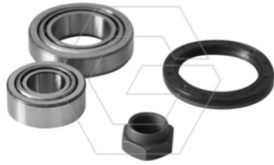

GWB6720

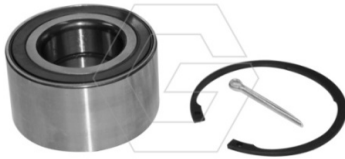

GWB6722

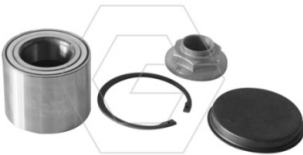

GWB6731

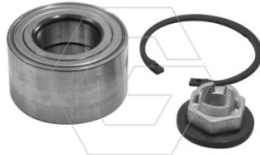

GWB6774

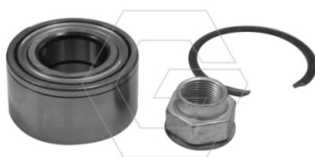

GWB6658



GWB6700



GWB6721



GWB6726

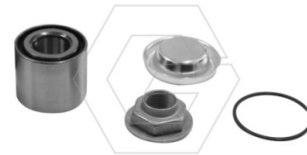

GWB6742

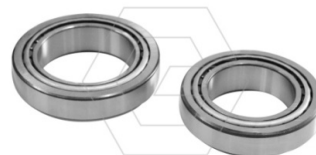

GWB6799

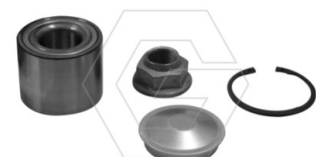

Bearing Kits

Photo.....

GWB6805



GWB6819



GWB6825



GWB6831



GWB6849



GWB6878



GWB6812

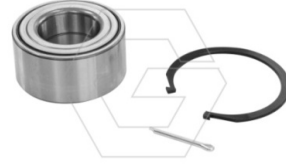

GWB6820

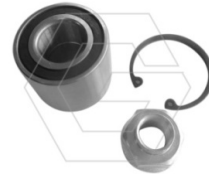

GWB6830



GWB6845

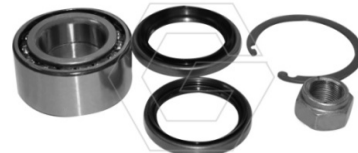

GWB6856

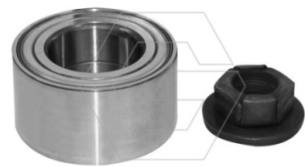

GWB6891



Bearing Kits

Photo.....

GWB6901



GWB6923

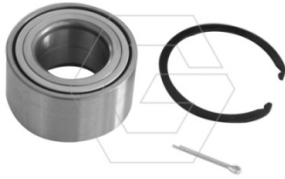

GWB6931

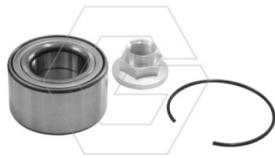

GWB6944



GWB6966

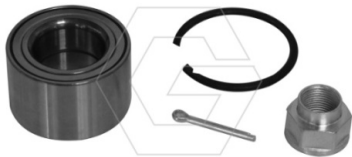

GWB6972



GWB6913



GWB6926

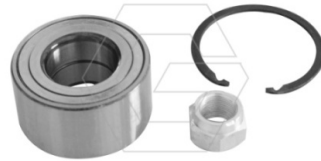

GWB6938

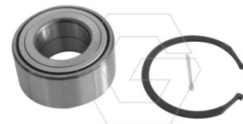

GWB6956



GWB6967

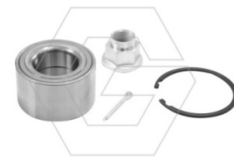

GWB6975



Bearing Kits

Photo.....

GWB7016 
GWB7408 
GWB7446 
GWB7456 
GWB7469 
GWB7490 

GWB7032 
GWB7440 
GWB7455 
GWB7458 
GWB7474 
GWB7525 

Bearing Kits

Photo.....

GWB7526 
GWB7536 
GWB7538 
GWB7549 
GWB7587 

GWB7534A 
GWB7537 
GWB7545 
GWB7573 
GWB7606 

New applications (compared with catalogue 2015)

G-AP Ref.	G-AP Ref.	G-AP Ref.	G-AP Ref.	G-AP Ref.	G-AP Ref.	G-AP Ref.
GHA225037K	GHA327057	GHA335001	GHA425041K	GWB6726		
GHA227007	GHA328011K	GHA342001	GHA425047	GWB6731		
GHA227011	GHA328013	GHA355005K	GHA425048	GWB6742		
GHA228011	GHA328014	GHA400009	GHA425049	GWB6774		
GHA228016	GHA329006K	GHA400011	GHA425051	GWB6799		
GHA228052	GHA329008K	GHA400013	GHA425052	GWB6819		
GHA228073	GHA329010	GHA400014	GHA426009K	GWB6901		
GHA230007	GHA329012K	GHA400016	GHA426015K	GWB6913		
GHA230072	GHA329017	GHA400024	GHA426022	GWB6931		
GHA230084K	GHA329018K	GHA400025	GHA426026	GWB6938		
GHA230107	GHA329025	GHA400054	GHA426030K	GWB6944		
GHA230127	GHA330001K	GHA400072K	GHA426048K	GWB6967		
GHA230128	GHA330020K	GHA400076	GHA426052	GWB7408		
GHA230131	GHA330024F	GHA400077	GHA427006	GWB7456		
GHA230152	GHA330027	GHA400086K	GHA427008	GWB7458		
GHA232047	GHA330028	GHA400109K	GHA427017	GWB7537		
GHA234007	GHA330037	GHA400114	GHA428005K	GWB7545		
GHA234011	GHA330048K	GHA400141	GHA428011K	GWB7549		
GHA234502	GHA331001	GHA400144	GHA428015K	GWB7573		
GHA235024K	GHA331004	GHA400169K	GHA428016			
GHA235025K	GHA331006K	GHA400173	GHA428026			
GHA236003	GHA331007A	GHA400177	GHA429001K			
GHA237001K	GHA332001K	GHA400178	GHA429002K			
GHA237021	GHA332008K	GHA400179	GHA429003			
GHA243005	GHA332009K	GHA400183	GHA429006			
GHA243011	GHA332010K	GHA400184	GHA430001K			
GHA244006	GHA332014	GHA400192	GHA430005K			
GHA245011	GHA332020	GHA400194	GHA430008			
GHA245022K	GHA332024	GHA400198	GHA431002			
GHA248001	GHA333006	GHA400199	GHA431005			
GHA250001	GHA333012	GHA400203	GHA433010			
GHA250010	GHA333018	GHA400211	GHA433013			
GHA251004	GHA333019	GHA400216	GHA436007			
GHA254901	GHA333022	GHA400218	GHA499001K			
GHA258001	GHA333024K	GHA400224	GHA499064			
GHA323002	GHA333027	GHA400236	GHA499084			
GHA324004K	GHA333031	GHA400309	GWB1455			
GHA325030	GHA333038	GHA400310	GWB1491			
GHA326006	GHA333039	GHA400313	GWB1915			
GHA326009	GHA333041	GHA400326	GWB3319			
GHA326032K	GHA333042	GHA400343	GWB3405			
GHA326034	GHA333047	GHA400344	GWB3499			
GHA326043	GHA333048	GHA400353K	GWB3528			
GHA326046	GHA333050	GHA400354K	GWB3664			
GHA326047	GHA333058	GHA400356	GWB3689			
GHA326052	GHA333059	GHA400359	GWB3727			
GHA326053	GHA333060	GHA400360	GWB3765			
GHA326057	GHA333061	GHA420004	GWB3775			
GHA327011	GHA333062	GHA421004A	GWB3796			
GHA327017	GHA333068	GHA422008A	GWB3797			
GHA327021	GHA333075	GHA422022	GWB3940			
GHA327022	GHA333077	GHA422026	GWB3949			
GHA327027	GHA333082	GHA422027K	GWB3967			
GHA327033	GHA333084	GHA422036K	GWB3968			
GHA327034	GHA333086	GHA423010	GWB3974			
GHA327035	GHA333090	GHA424010	GWB6540			
GHA327037	GHA333091	GHA424015	GWB6559			
GHA327052	GHA333095	GHA425008	GWB6642			
GHA327054	GHA333107	GHA425027	GWB6646			
GHA327056	GHA333110	GHA425028	GWB6722			



CAT.NO.G51016/E

